



# PRIME

SISTEMA MINIMALISTA  
CORTE TÉRMICO 180MM

SISTEMA MINIMALISTA  
PUENTE TÉRMICO 180MM



## SISTEMA PRIME

### Sistema de correr de conceito minimalista com corte térmico

#### CARACTERÍSTICAS DO SISTEMA

Sistema de alumínio com rotura térmica para executar vãos de correr de grandes dimensões de conceito minimalista procurando aliar o máximo de transparência com o mínimo de visão estrutural.

#### PERFIS DE ALUMÍNIO

Perfis extrudidos nas ligas de alumínio 6060 para arquitetura de acordo com norma NP EN 12020-02.

Os perfis com rotura térmica são obtidos por inserção de varetas de poliamida 6.6 reforçadas com 25% de fibra de vidro de 14.6mm nos aros fixos e de 32mm nos aros móveis. A espessura média dos perfis de alumínio é de 2mm;

#### AROS FIXOS

Secção do aro fixo perimetral ou de corte recto de 82.7mm mono-rail, de 180mm bi-rail ou 277.3mm tri-rail;

Perfil guia de deslizamento inferior em alumínio com rolamentos duplos de altas prestações ou com guia carril, ambos em aço inoxidável.

Este sistema inclui soluções com soleiras embutidas para permitir a integração no pavimento, assim como, pré-aros para uma melhor e eficaz aplicação dos caixilhos e drenagem mais eficiente. Existe também a possibilidade de aplicação de remates interior ou exterior.

#### AROS MÓVEIS

Secção dos aros móveis de vista muito reduzida de corte reto com montagem por ligação mecânica;

Vidro duplo ou triplo isolante com selagem secundária de silicone desde 34mm até 56mm de espessura total composto por tipologias de vidro exterior temperado ou termo-endurecido e de vidro interior temperado ou laminado-temperado;

Silicones estruturais recomendados para colagem vertical dos vidros: Silicone estrutural Dow Corning 895 preto ou silicone estrutural Sikasil SG20 preto.

Aros móveis reforçados para grande dimensionamento;

Solução com rede mosquiteira.

#### DIMENSIONAMENTO E MANIOBRABILIDADE

Dimensões mínimas - máximas de folha abertura manual 500mm - 2500mm (L);

Dimensões mínimas - máximas de folha abertura manual 500mm - 4000mm (H);

Área máxima da folha abertura manual: 10m<sup>2</sup>.

Peso máximo de 450Kg por folha abertura manual.

Dimensões mínimas - máximas de folha abertura motorizada 1000mm - 3200mm (L);

Dimensões mínimas - máximas de folha abertura motorizada 1700mm - 5000mm (H);

Área máxima da folha abertura motorizada: 16m<sup>2</sup>;

Peso máximo de 1000Kg por folha em abertura motorizada;

Tipologias de 2 a 6 folhas com folhas móveis e/ou fixas;

Possibilidade de abertura em canto ou abertura em Galandage;

O deslizamento das folhas é feito sobre perfil guia de deslizamento inferior em alumínio com rolamentos duplos de altas prestações em aço inoxidável ou com guia carril em aço inoxidável para uma fácil abertura do vão mesmo em configurações extremas de peso ou dimensões;

Tipologias dos vãos com mais de 98% de luminosidade;

Permeabilidade ao ar e estanquidade à água assegurada através de pelúcia de última geração e junta em EPDM de qualidade marítima;

Ferragem Multiponto com diversos pontos de fechos de fácil aplicação e regulação incluído possibilidade de micro-ventilação;

Puxadores específicos com tratamento de lacagem ou de anodização para facilitar a manobra de abertura e de fecho do vão;

Existe opção de aplicação de fechadura para uma abertura exterior/interior.

#### PERFORMANCES

Sistema certificado por laboratório credenciado, notificado para Ensaio Tipo Inicial (ITT) de acordo com a norma de produto EN 14351-1 para efeitos de Marcação CE.

Objectivo de categorias na avaliação do sistema PRIME tipologia porta de 2 folhas:

1. Permeabilidade ao ar: Classe 3 (normas de ensaio EN 10207 e EN 1026)
2. Estanquidade à água: Classe 7A (normas de ensaio EN 12208 e EN 1027)
3. Resistência ao vento: Classe C3 (normas de ensaio EN 12210 e EN 12211)

Coefficiente de transmissão térmica de vão de 2 folhas com 6.0m x 3m com vidro duplo de valor Ug= 0.5 W/m<sup>2</sup>K, intercalar efeito "Warm Edge" e factor solar g=0.37:

• Uw = 0,73 W/m<sup>2</sup>K

Zonas de aplicação segundo os regulamentos REH e RECS (em função do valor Ug) : I1, I2, I3, V1, V2, V3;

## SISTEMA PRIME

### Sistema de corredera de concepto minimalista con puente térmico

#### CARACTERÍSTICAS DEL SISTEMA

Sistema de aluminio para ejecución de huecos correderos de grandes dimensiones de concepto minimalista en busca del máximo de transparencia con el mínimo de visión estructural.

#### PERFILES DE ALUMINIO

Perfiles extrudidos en la aleación de aluminio 6060 para arquitectura de acuerdo con la norma NP EN 12020-02.

Son obtenidos por inserción de varillas de poliamida 6.6 reforzadas con 25% fibra de vidrio de 14.6mm en los marcos y 32mm en las hojas. El espesor medio de los perfiles de aluminio es de 2mm.

#### MARCOS

Sección de marco fijo o de corte recto de 82.7mm monocarril, de 180mm bicarril o 277.3 tricarril;

Perfil guía inferior deslizante de aluminio con doble rodamiento de alto rendimiento o con guía de carril, ambos en acero inoxidable.

Este sistema incluye soluciones con solape empotrados para permitir la integración en el suelo, así como pre marcos para una mejor y eficaz aplicación de los marcos y un drenaje más eficiente. También existe la posibilidad de aplicar remates interiores o exteriores.

#### HOJAS

Sección de hojas de vista muy reducida de corte recto con montaje por ligación mecánica;

Vidrio doble o triple aislante con sellado secundario de silicona de 34 mm a 56 mm de espesor total, compuesto por tipos de vidrio exterior templado o termoendurecible y vidrio interior laminado o laminado templado.

Siliconas estructurales recomendadas: Dow Corning 895 black o Sikasil SG20 black; Hojas reforzadas para grandes dimensiones.

Solución de red mosquiteira.

#### DIMENSIONAMENTO Y MANIOBRABILIDAD

Dimensiones mínimas - máximas de hoja apertura manual 500mm - 2500mm (L);

Dimensiones mínimas - máximas de hoja apertura manual 500mm - 4000mm (H);

Área máxima de hoja apertura manual: 10m<sup>2</sup>.

Peso máximo de 450 kg por hoja apertura manual;

Dimensiones mínimas - máximas de hoja apertura con motor 1000mm - 3200mm (L);

Dimensiones mínimas - máximas de hoja apertura con motor 1700mm - 5000mm (H);

Área máxima de hoja apertura con motor: 16m<sup>2</sup>.

Peso máximo de 1000 kg por hoja apertura manual;

Possibilidades de apertura: 2 a 6 hojas, con hojas correderas y/ó fijas;

Possibilidade de abertura en esquina o abertura en Galandage;

El deslizamiento de las hojas se realiza sobre un perfil guía deslizante inferior de aluminio con doble rodamiento de alto rendimiento en acero inoxidable o con un carril guía en acero inoxidable para una fácil apertura del hueco incluso en configuraciones extremas de peso o dimensiones;

Permite que tener un hueco con más del 98% de luminosidad;

Permeabilidad al aire y estanquidad al agua aseguradas a través de la junta de EPDM de calidad marina y felpa de última generación;

Herrajes multipunto con varios puntos de cierre para una fácil aplicación y ajuste, incluyendo la posibilidad de micro ventilación;

Manillas específicas con tratamiento de lacado o anodizado para facilitar la apertura y cierre;

Existe la opción de aplicar una cerradura para una apertura exterior/interior.

#### ENSAYOS

Sistema certificado por laboratorio credenciado, notificado para Ensayos Tipo Inicial (ITT) de acuerdo con la norma de producto EN 14351-1 para efectos de Marcado CE.

Categorías alcanzadas en los ensayos del sistema PRIME tipologia 2 puertas:

1. Permeabilidad al aire: Clase 3 (norma de ensayo EN 10207 y EN 1026)
2. Estanquidad al agua: Clase 7A (norma de ensayo EN 12208 y EN 1027)
3. Resistencia al viento: Clase C3 (norma de ensayo EN 12210 y EN 12211)

Coefficiente de transmisión térmica de hueco de 2 hojas con 6 m x 3 m con vidrio doble Ug = 0.5 W/m<sup>2</sup>K, intercalar efecto "Warm Edge" y factor solar g=0.37:

• Uw = 0,73 W/m<sup>2</sup>K

Zonas de aplicación según los regulamentos REH y RECS (en función del valor Ug): I1, I2, I3, V1, V2, V3;

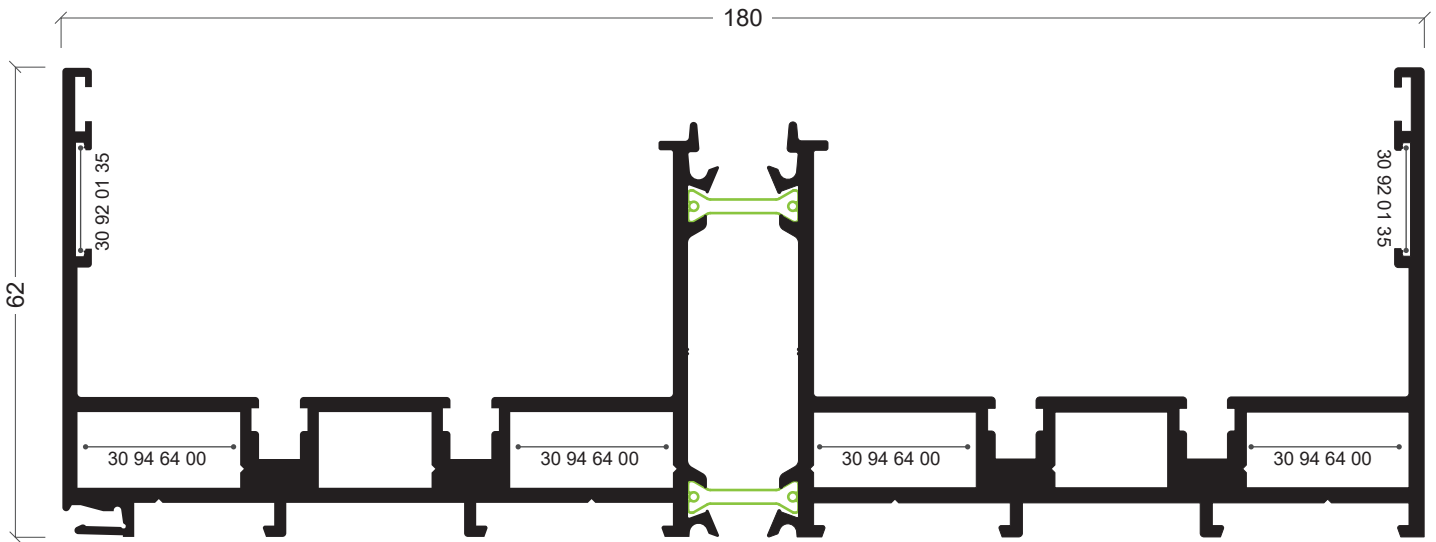

**KL-49**

Aro Fixo perimetral com clip  
Marco Perimetral con clip

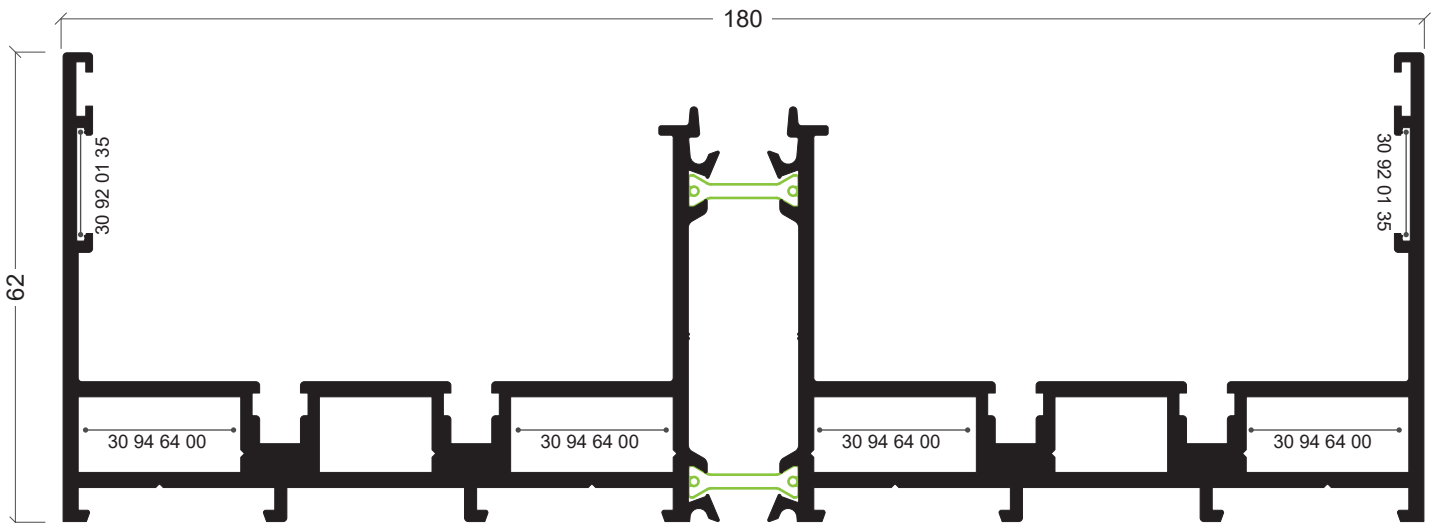

**KL-51**

Aro Fixo perimetral  
Marco Perimetral

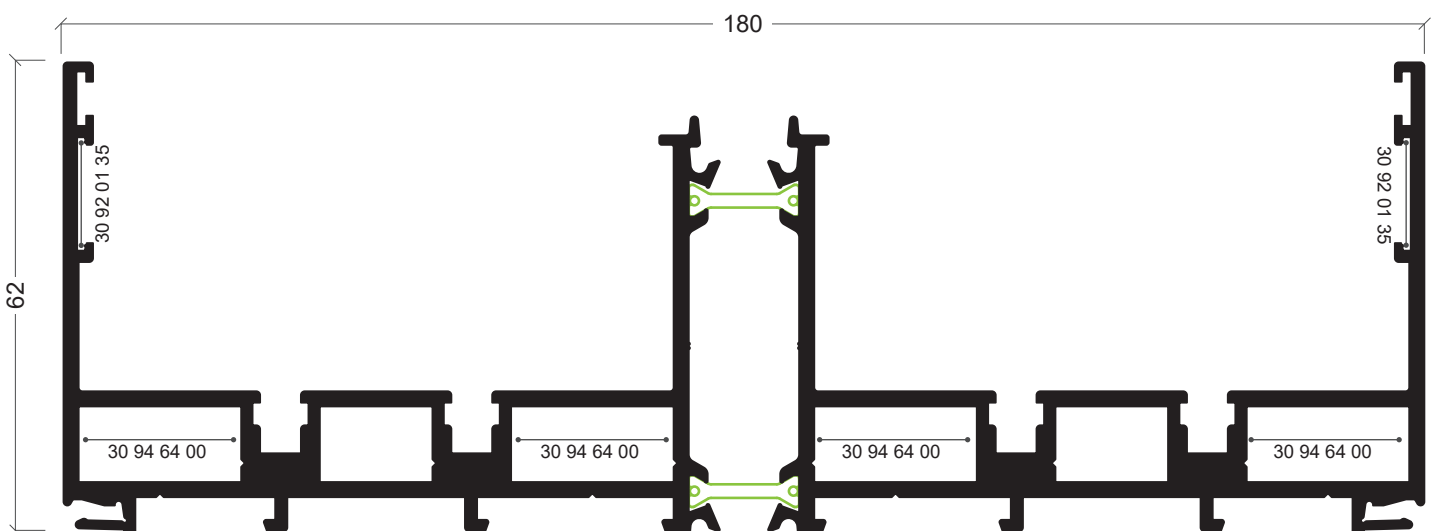

**KL-50**

Aro Fixo perimetral com duplo clip  
Marco Perimetral con doble clip

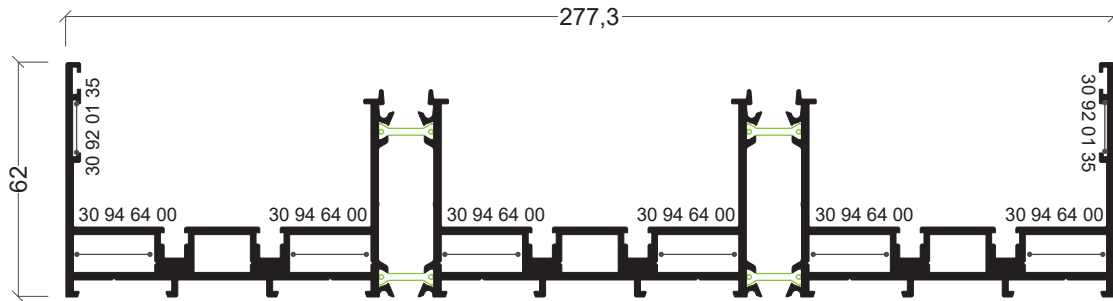

**KL-73**

Aro fixo perimetral tri-rail  
Marco perimetral tricarril

Escala 1:2  
Escala 1:2

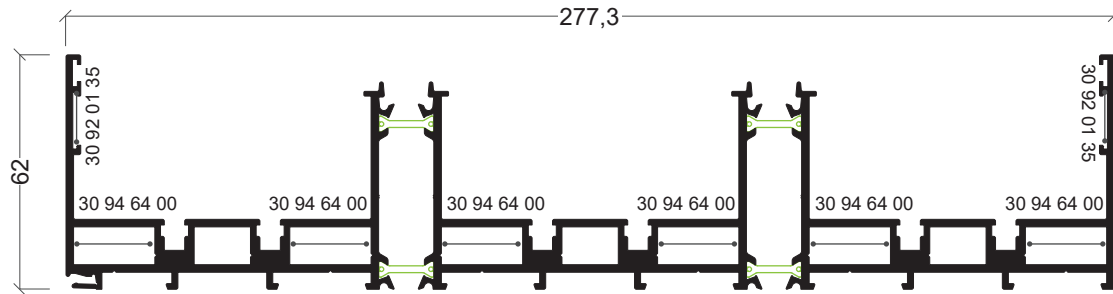

**KL-74**

Aro fixo perimetral tri-rail com clip  
Marco Perimetral tricarril con clip

Escala 1:2  
Escala 1:2

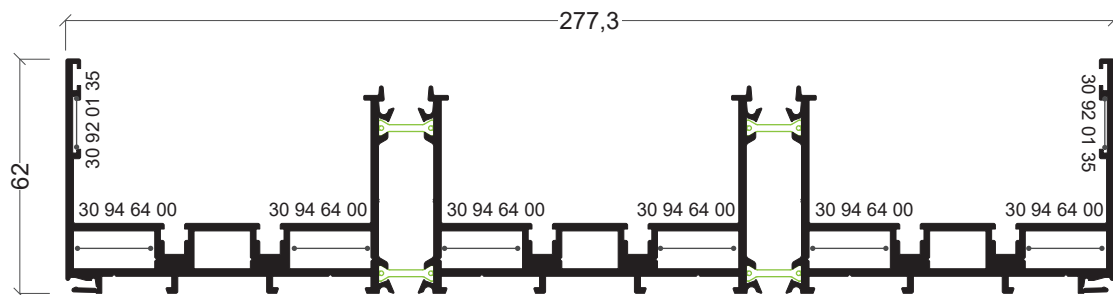

**KL-75**

Aro fixo perimetral tri-rail com duplo clip  
Marco Perimetral tricarril con doble clip

Escala 1:2  
Escala 1:2



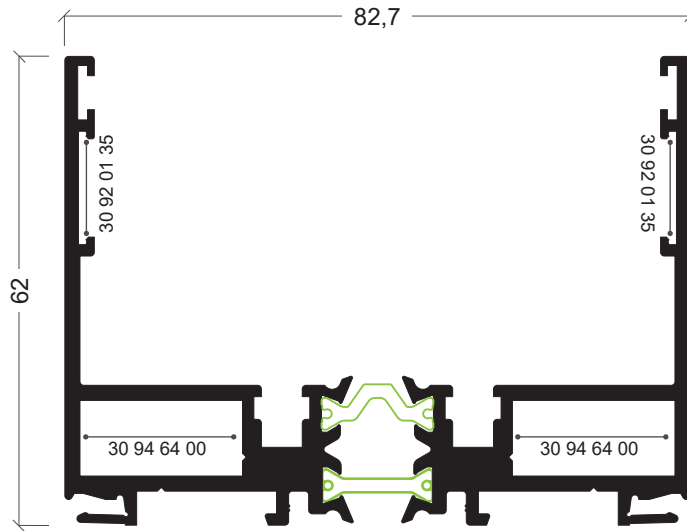

**KL-90**  
Perfil mono-rail com duplo clip  
Guia monorrail con doble clip

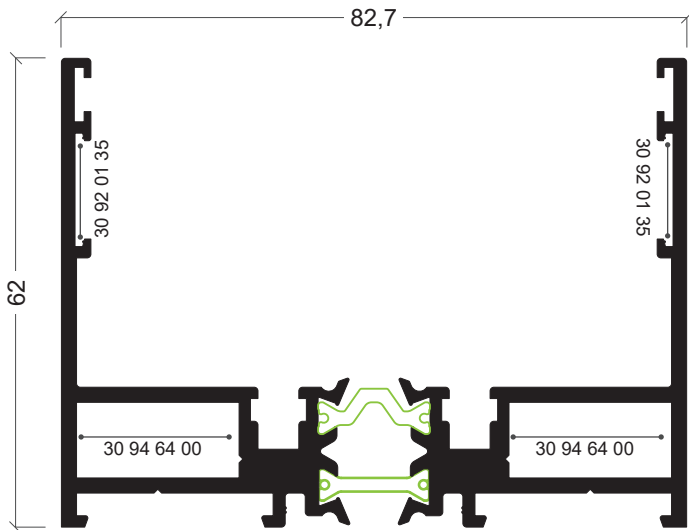

**KL-91**  
Perfil mono-rail  
Guia monorrail

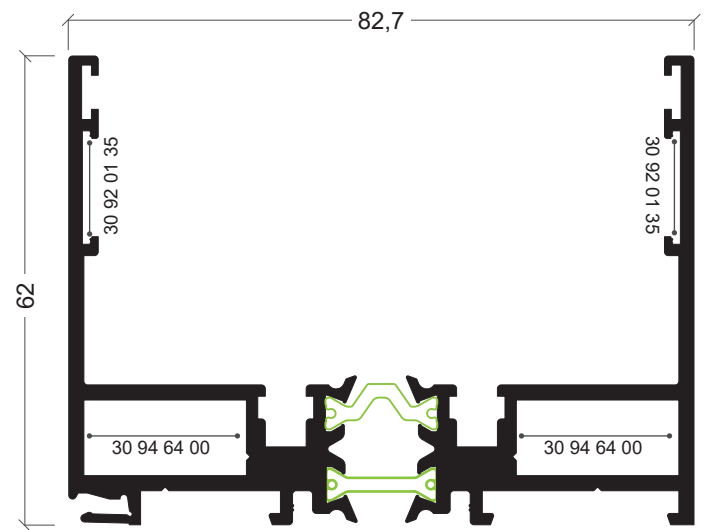

**KL-92**  
Perfil mono-rail com clip  
Guia monorrail con clip

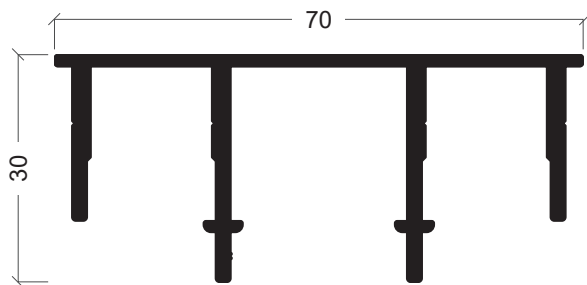

**KL-55**  
Perfil suporte para folha fixa  
Soporte para marco

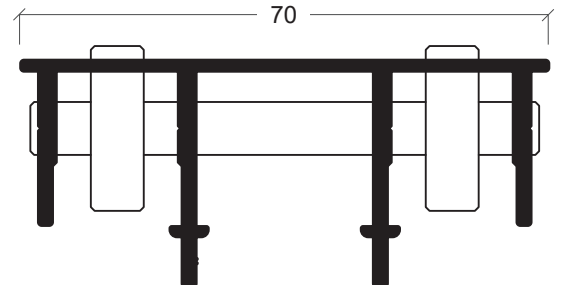

**KL-55/RD**  
Perfil guia para folha  
Guia para hoja

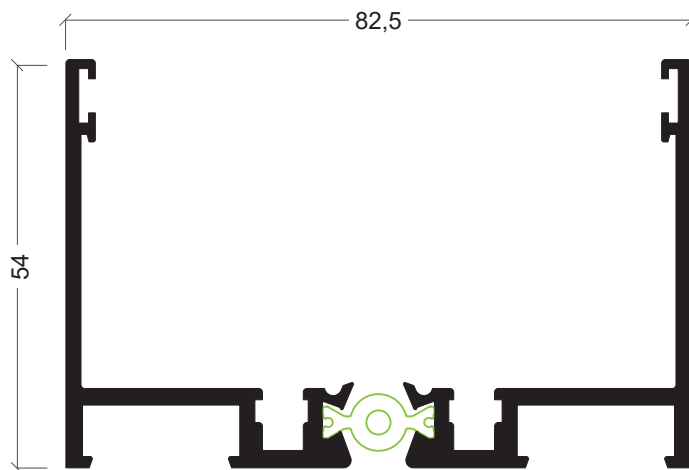

**KL-82**  
Soleira/Padieira mono-rail  
Solape monorrail

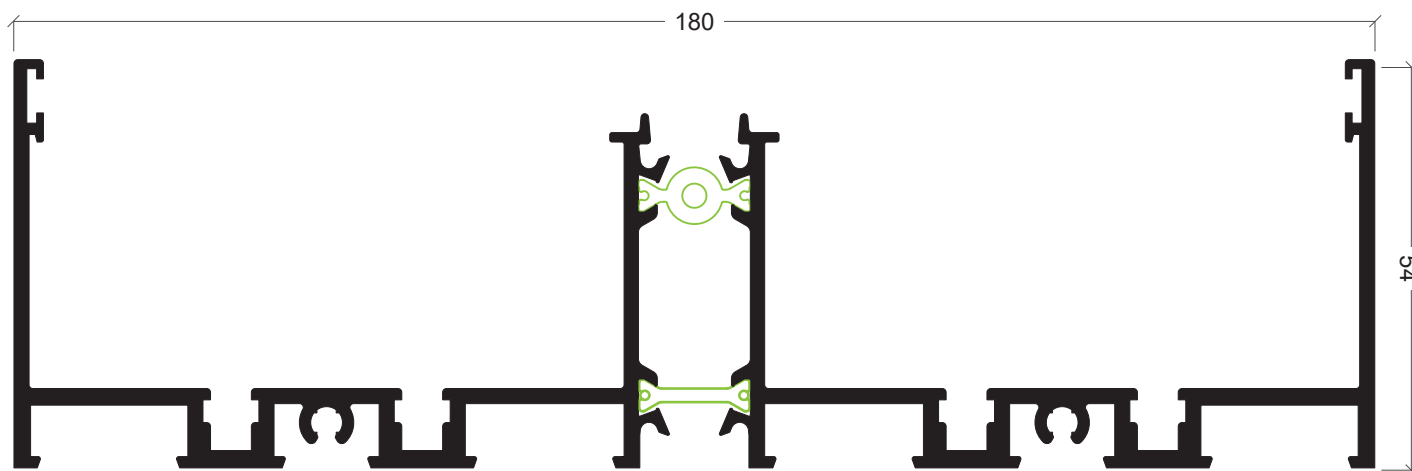

**KL-83**  
Soleira/Padieira bi-rail  
Solape bicarril

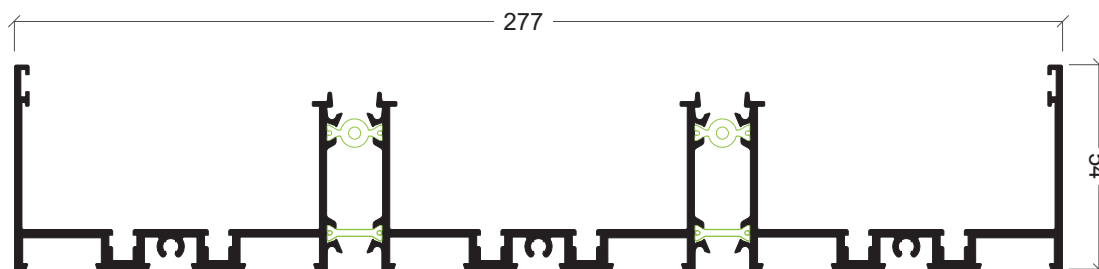

**KL-84**  
Soleira/Padieira Tri-rail  
Solape tricarril

Escala 1:2  
Escala 1:2

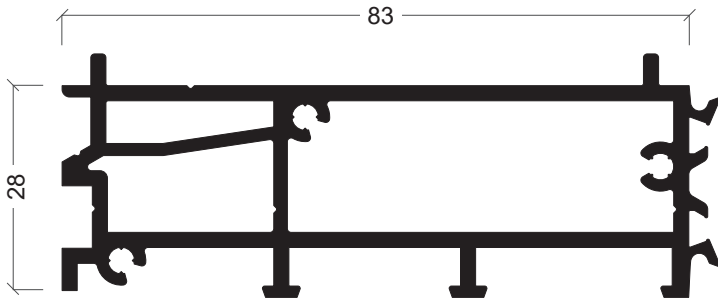

**KL-93/A**  
Pré Aro mono-rail  
Pré Marco monorrail

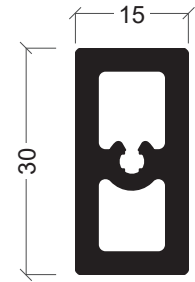

**KL-87**  
Perfil de reforço  
Refuerzo

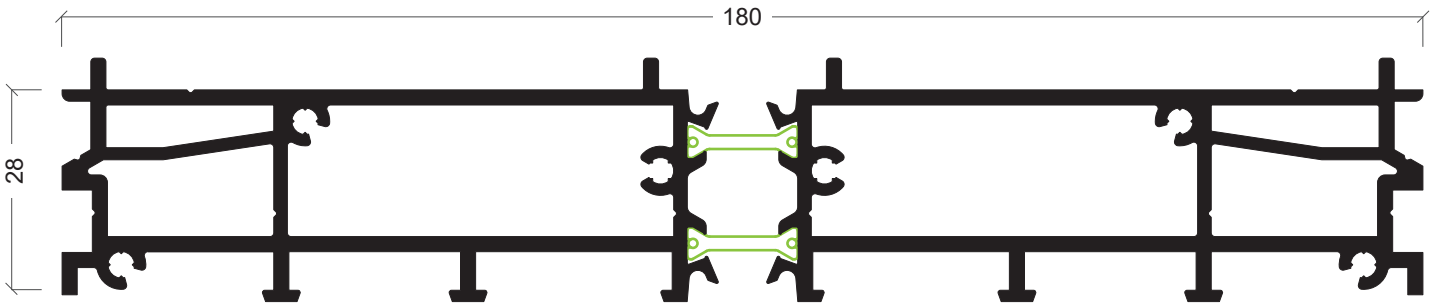

**KL-93**  
Pré Aro bi-rail  
Pré Marco bicarril

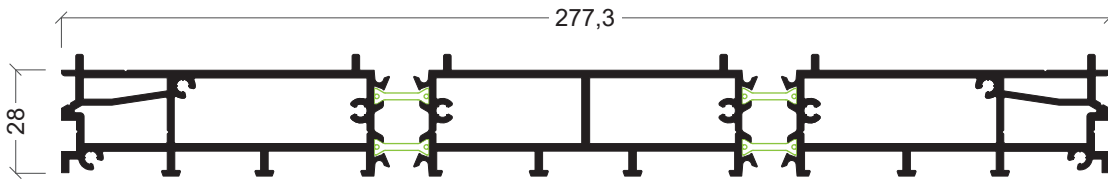

**KL-94**  
Pré Aro tri-rail  
Pré Marco tricarril

Escala 1:2  
Escala 1:2

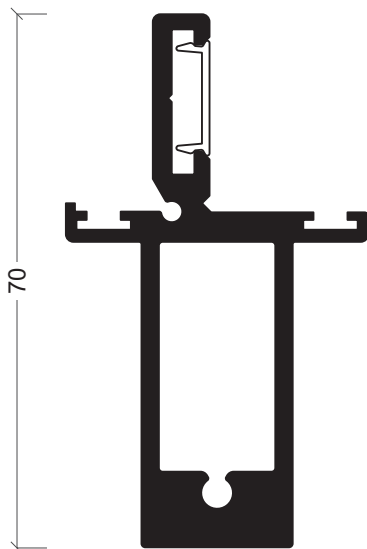

**KL-86**  
Perfil central reforçado  
Guia reforzado

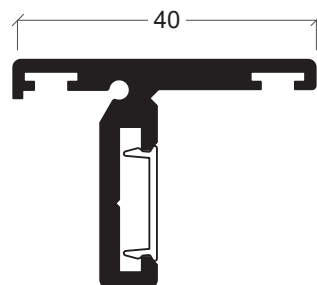

**KL-85**  
Perfil Central  
Guia central

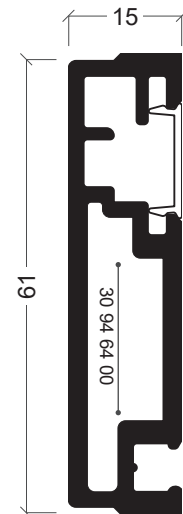

**KL-60**  
Perfil mosquiteira  
Perfil mosquitera



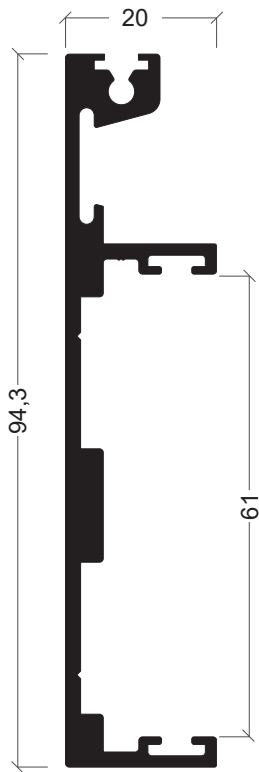

**KL-59**  
Aro móvel central  
Hoja central

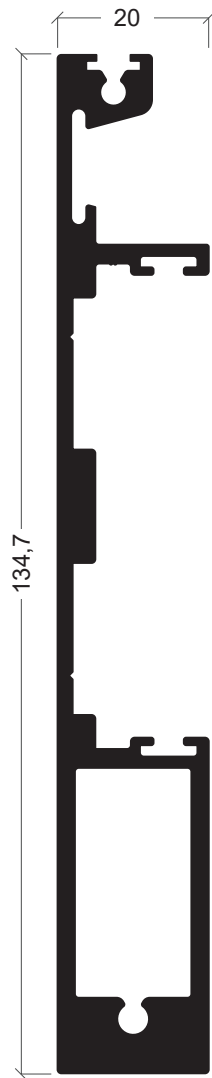

**KL-52**  
Aro Móvel central reforçado  
Hoja central reforzado

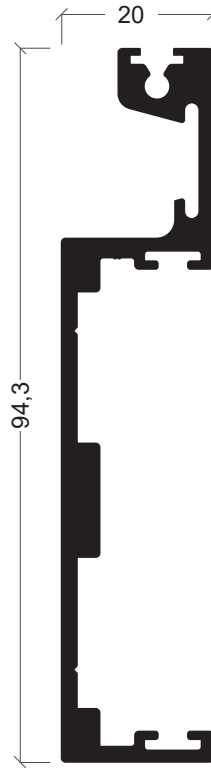

**KL-64**  
Aro móvel central 3/4 folhas  
Hoja central 3/4 hojas

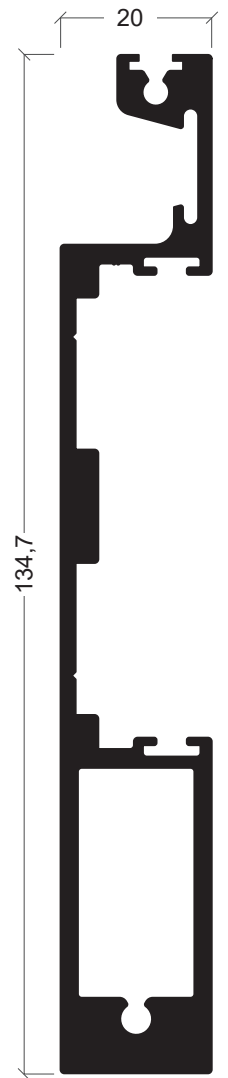

**KL-62**  
Aro Móvel central reforçado 3/4 folhas  
Hoja central reforzado 3/4 hojas

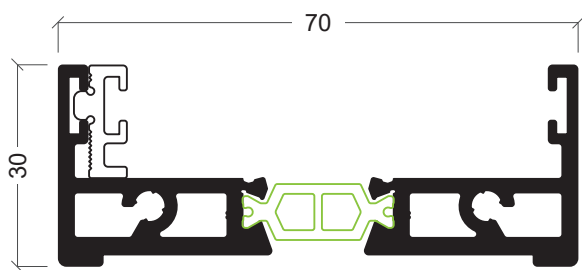

**KL-57**  
Aro móvel superior/inferior  
Hoja superior/inferior

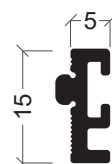

**KL-71**  
Redutor  
Reductor

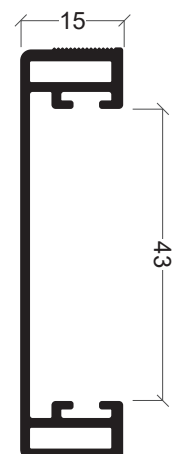

**KL-81**  
Redutor  
Reductor

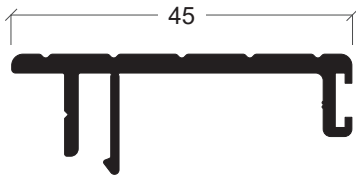

**KL-67**  
Tampa lateral para soleira embutida rasa  
Tapa lateral para solape incrustada rasa

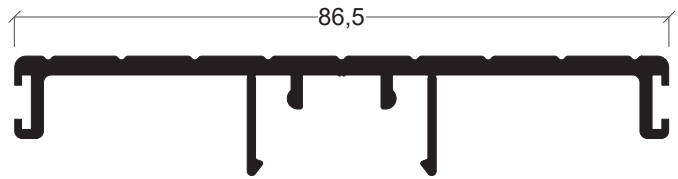

**KL-68**  
Tampa central para soleira embutida rasa  
Tapa central para solape incrustada rasa

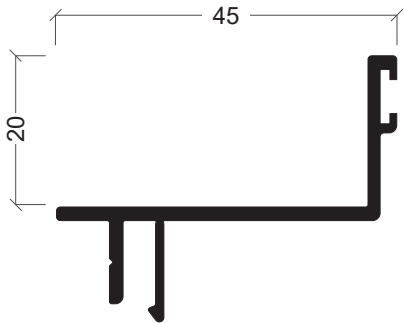

**KL-65**  
Tampa lateral para soleira embutida  
Tapa lateral para solape incrustada

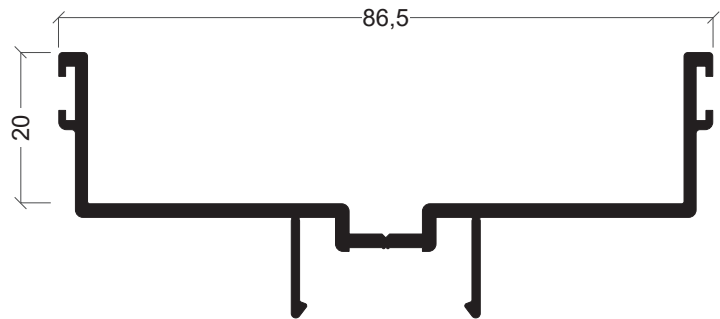

**KL-66**  
Tampa central para soleira embutida  
Tapa central para solape incrustada

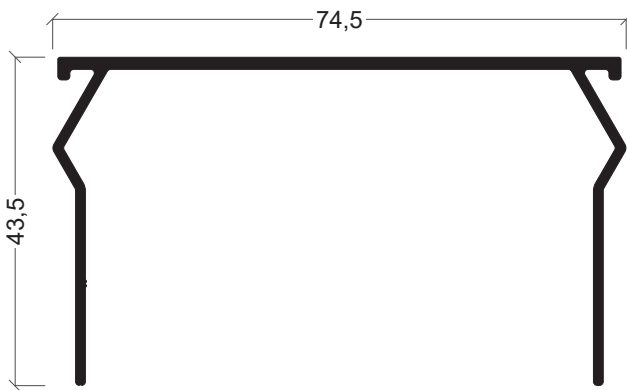

**KL-63**  
Perfil Tampa  
Embelecedor

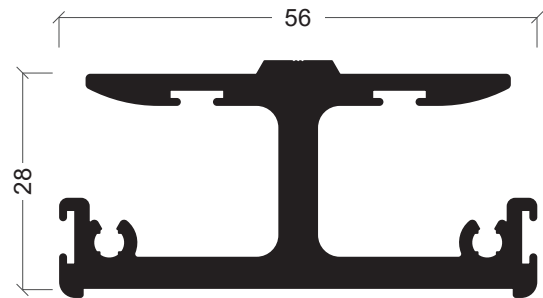

**KL-70**  
Soleira embutida  
Solape incrustada

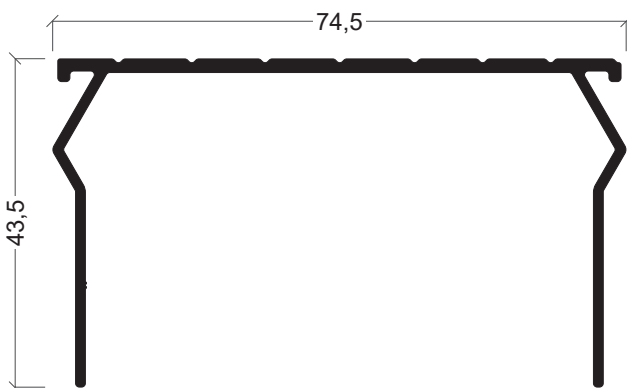

**KL-69**  
Perfil Tampa  
Perfil Tapa

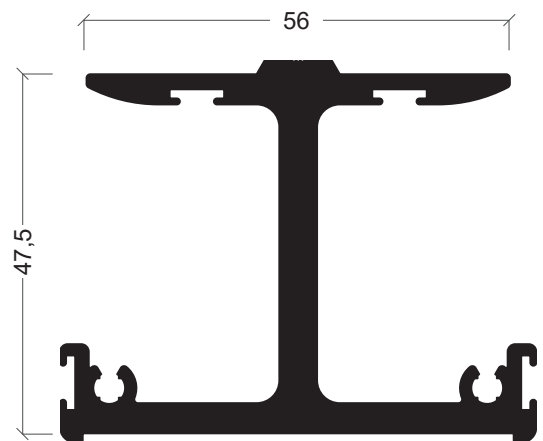

**KL-54**  
Soleira embutida  
Solape incrustada

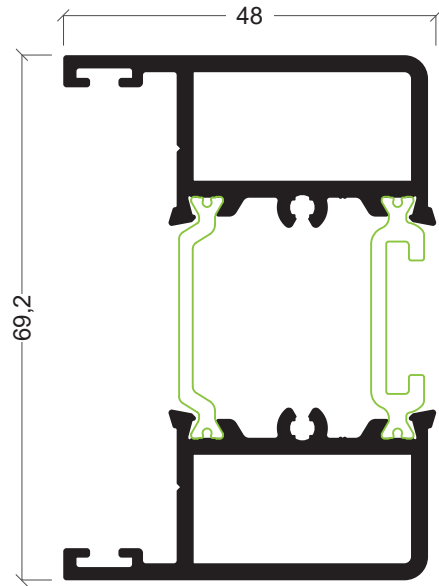

**KL-53**  
Aro móvel lateral  
Hoja lateral

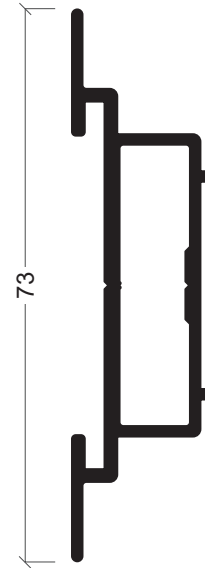

**KL-58**  
Ombreira para fechos  
Umbral para cierre

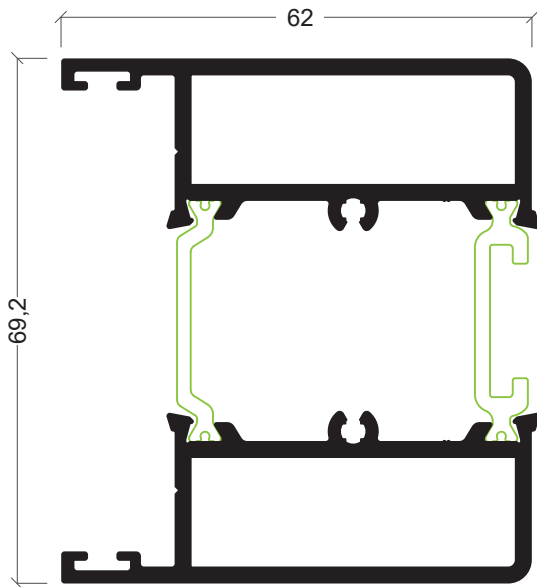

**KL-78**  
Aro móvel para fechadura  
Hoja para cierre

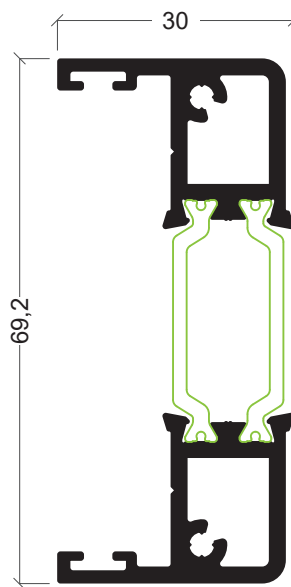

**KL-72**  
Aro móvel lateral para motor  
Hoja lateral para motor

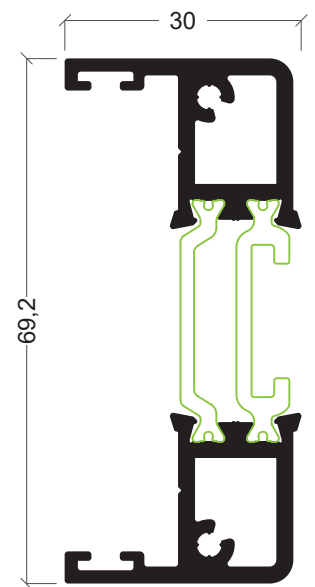

**KL-56**  
Aro móvel lateral  
Hoja lateral



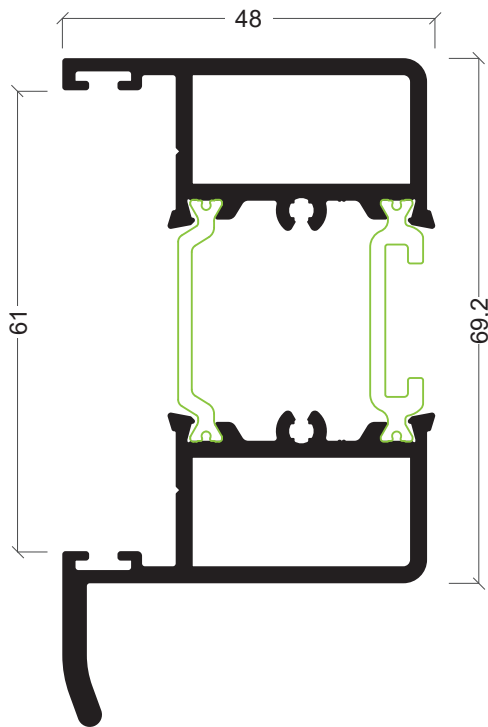

**KL-76**  
Aro móvel lateral  
Hoja cierre

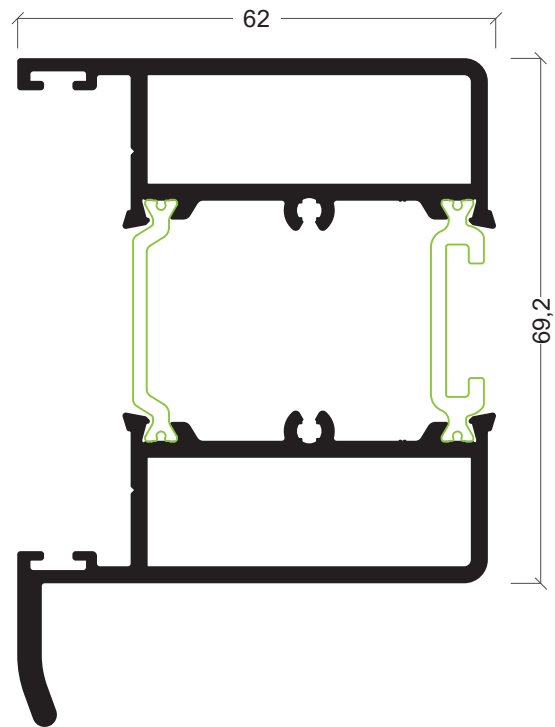

**KL-79**  
Aro móvel para fechadura  
Hoja para cierre

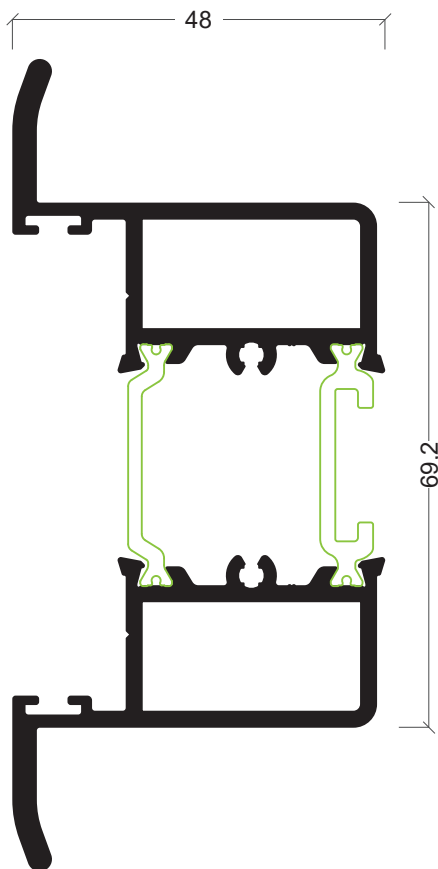

**KL-77**  
Aro móvel lateral  
Hoja lateral

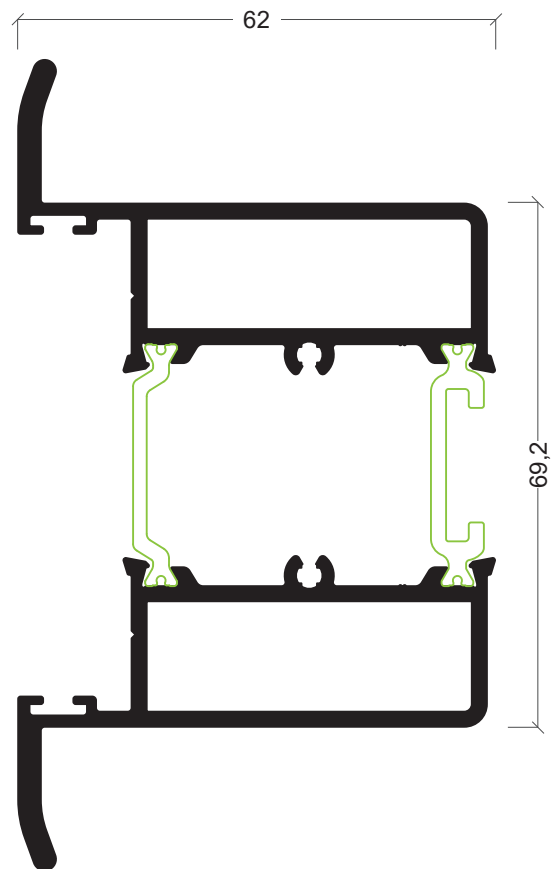

**KL-80**  
Aro móvel para fechadura  
Hoja para cierre

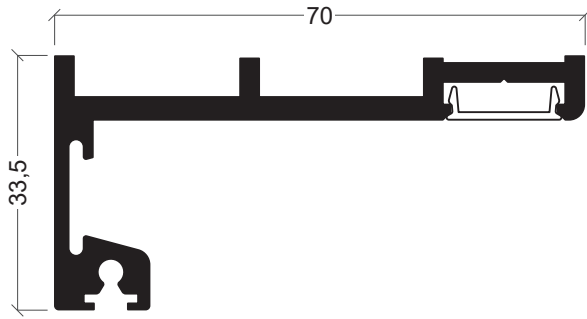

**KL-48**

Prumo de cruzamento  
Remate de aislamiento

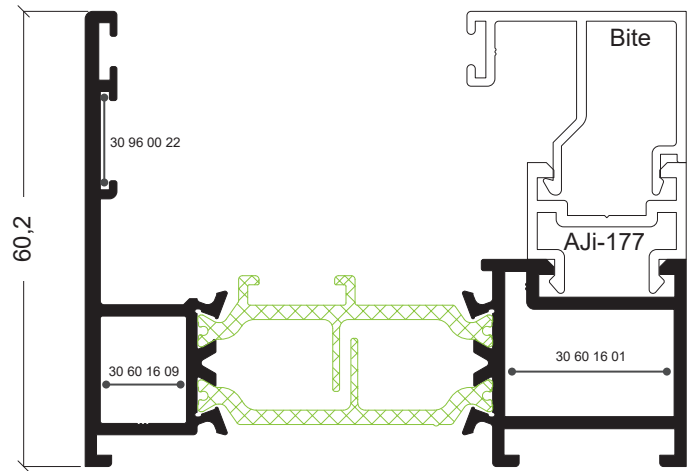

**APi-103**

Aro Fixo  
Marco

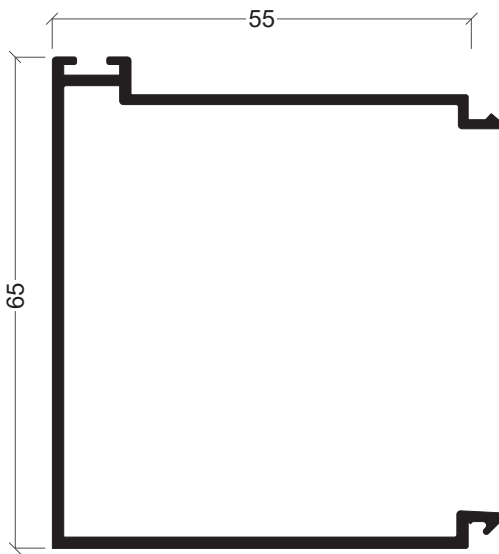

**CW-29**

Remate de Galandage  
Remate de aislamiento

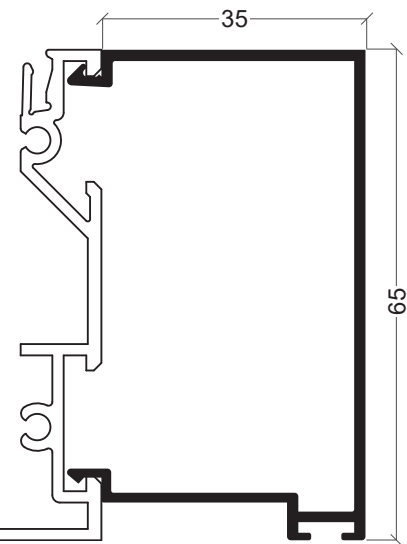

**CW-12**

Remate de Galandage  
Remate de aislamiento

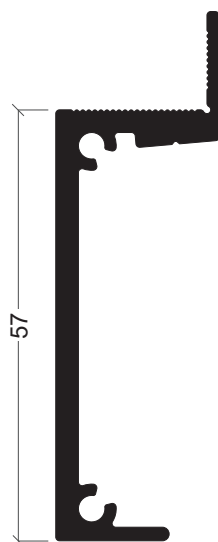

**KL-46**

Remate de Galandage  
Remate de aislamiento

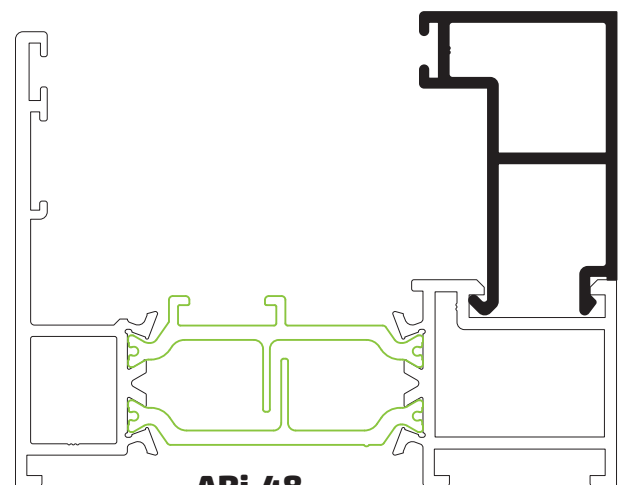

**ARi-48**

Bite  
Bite

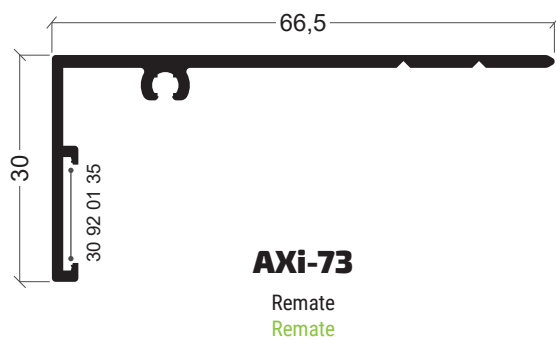
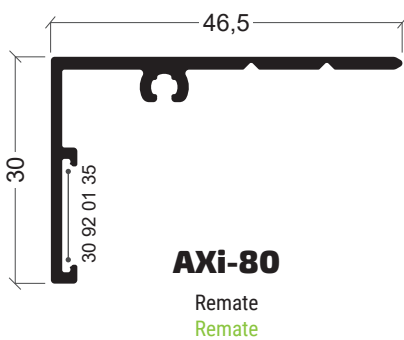
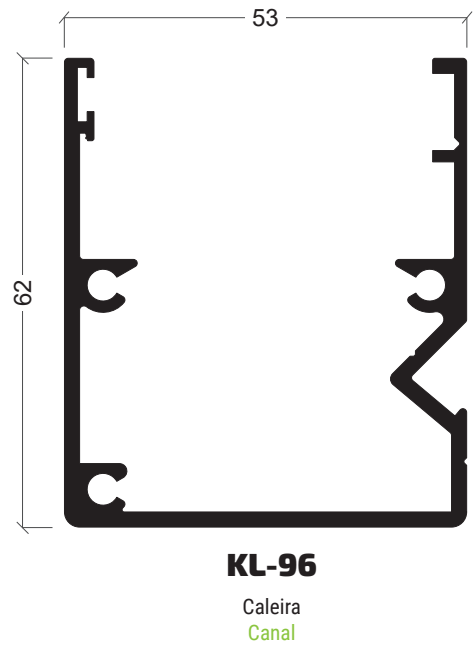
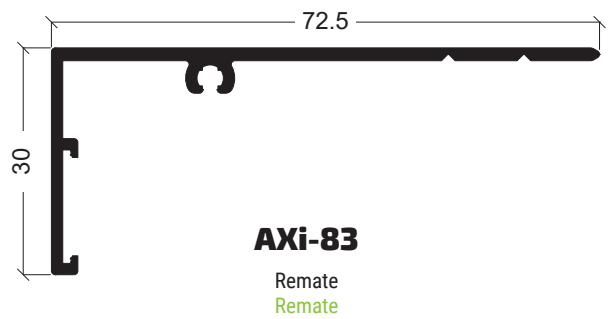
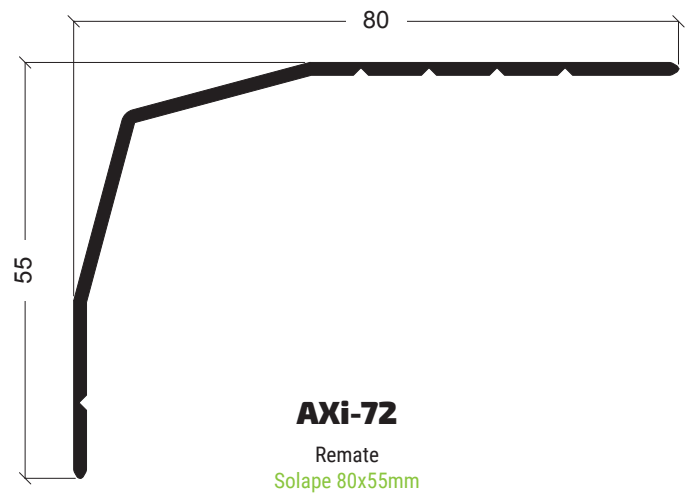
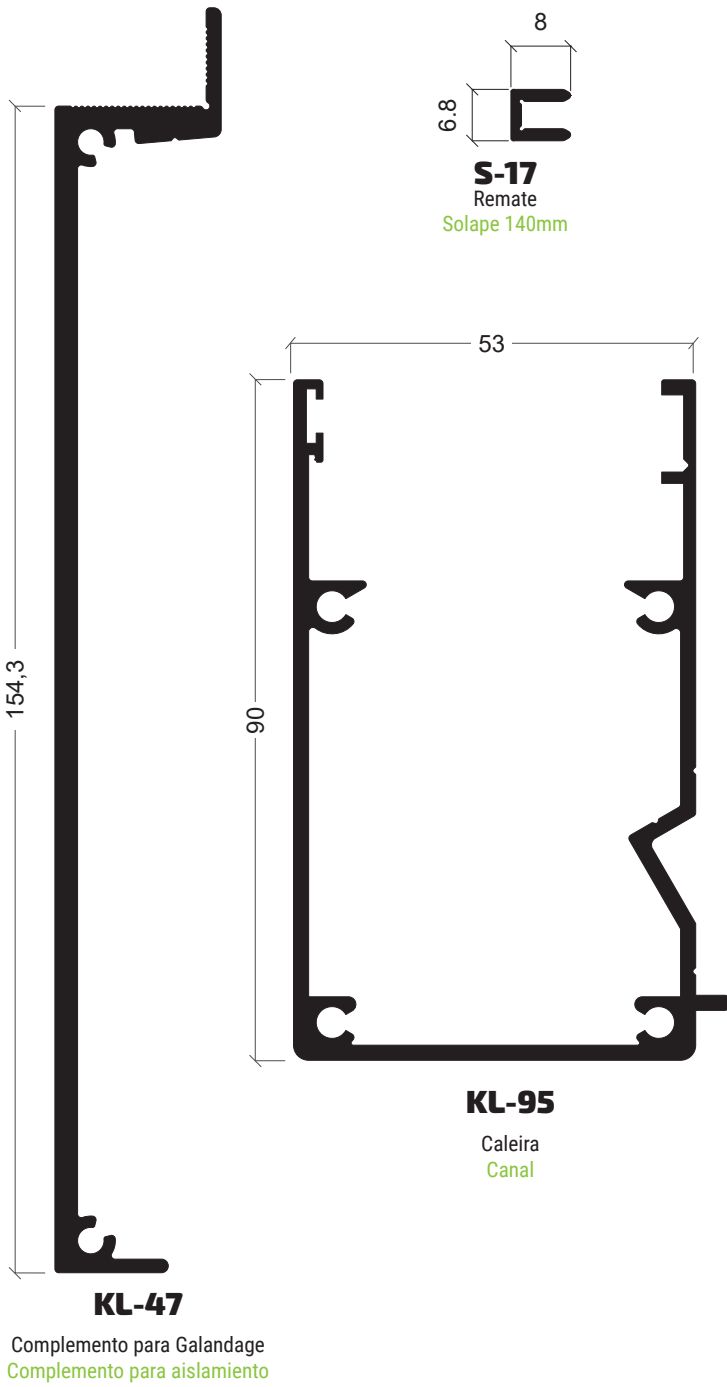





**KL-04**

Tampa  
Tope

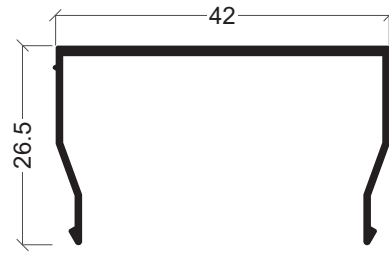

**KL-13/R**

Tampa c/ furação  
Tapa c/ furação



**AX-19**

Vareta  
Pletina

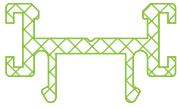

**KL-06**

Perfil polímero central  
Perfil polímero central



**CTe-03**

Guia carril (aço inox 304)  
Guia marco carril inf. (AISI 304)



**CT-94**

Perfil União  
Perfil União

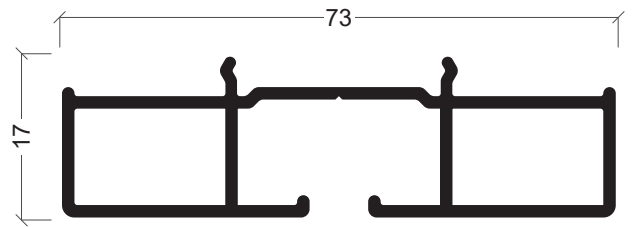

**KL-88**

Perfil para motor telescópico  
Perfil para motor telescópico

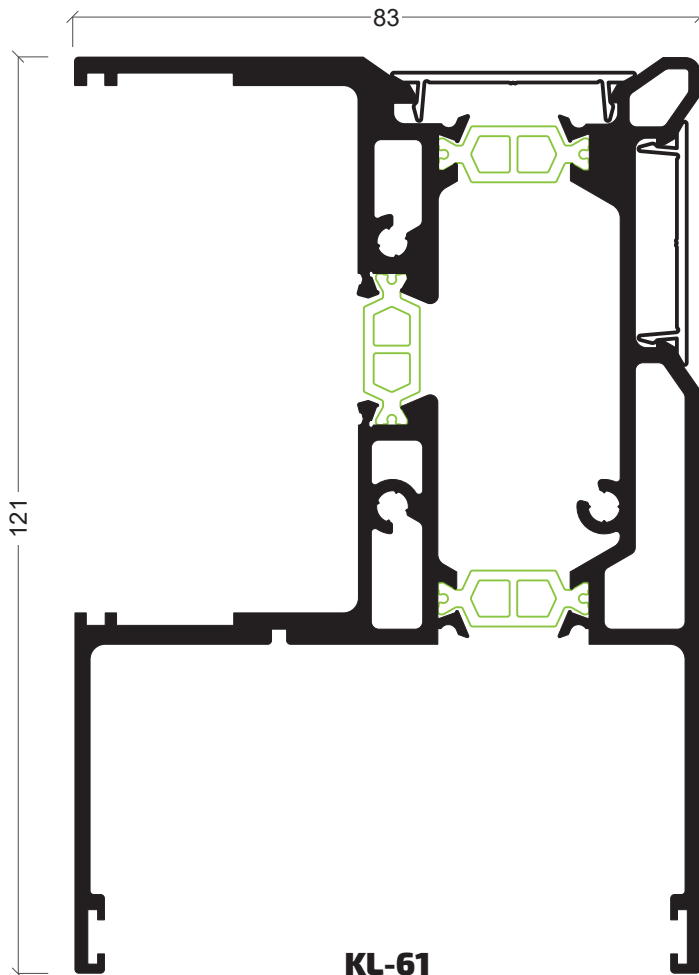

**KL-61**

Perfil canto  
Perfil canto

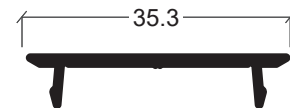

**KL-16**

Tampa  
Tapa

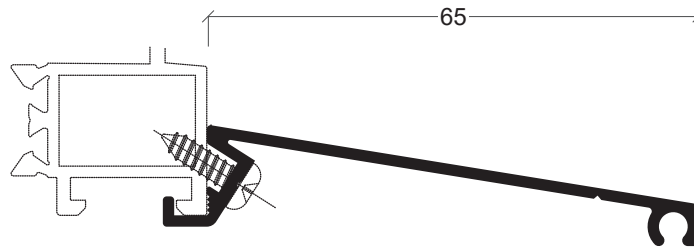

**CT-30**

Soleira  
Solape

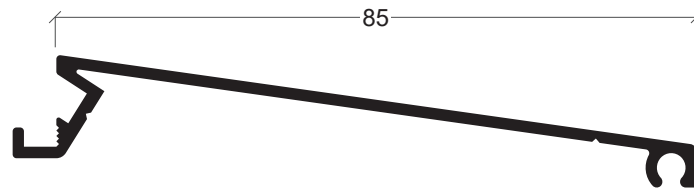

**CT-31**

Soleira  
Solape

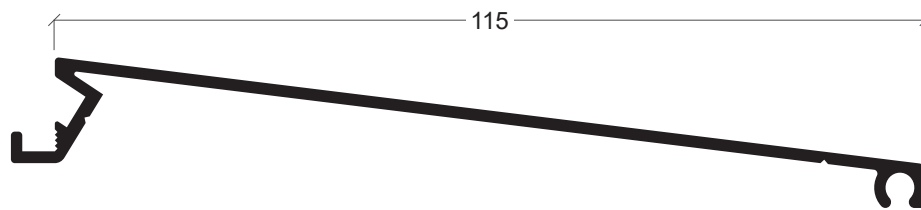

**CT-32**

Soleira  
Solape

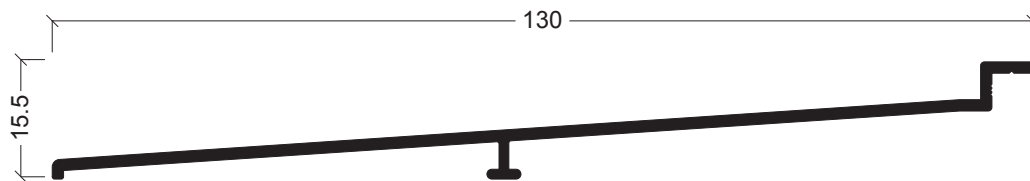

**AZ-24**

Soleira  
Solape

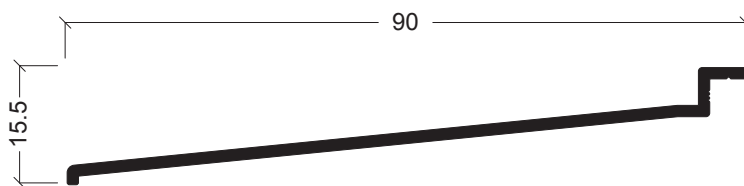

**AZ-23**

Soleira  
Solape

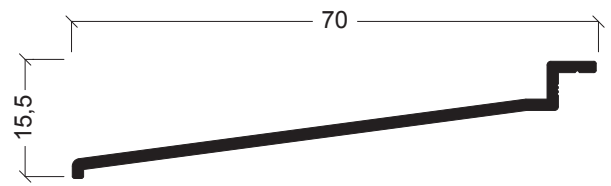

**AZ-30**

Soleira  
Solape

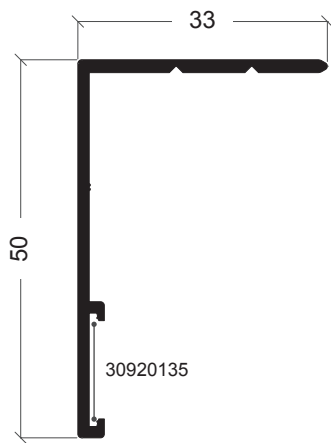

**S-20**  
Remate  
Solape 33x50mm

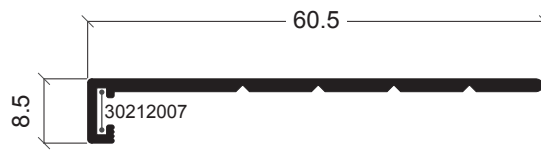

**S-21**  
Remate  
Solape 60.5x8,5mm

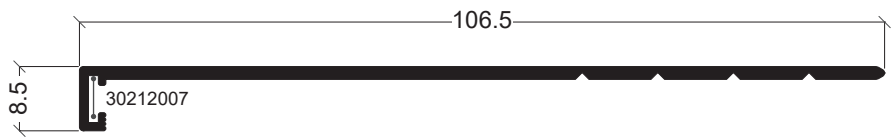

**S-22**  
Remate  
Solape 106.5x8.5mm

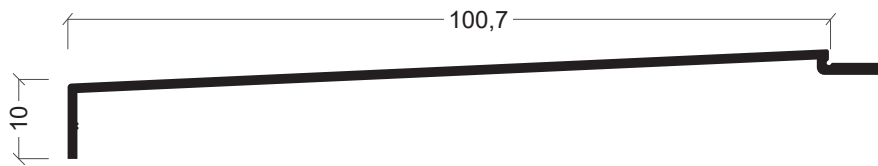

**S-15**  
Remate  
Solape 100x10mm

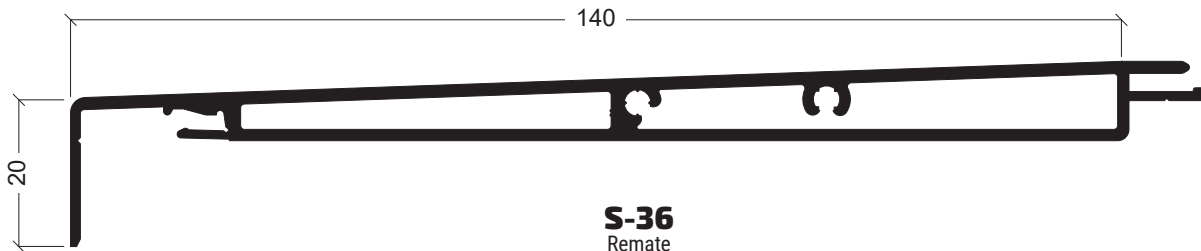

**S-36**  
Remate  
Solape 140mm

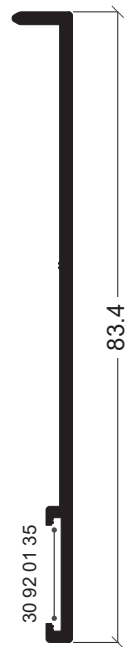

**S-14**  
Remate  
Solape 83,4mm



**S-18**  
Remate  
Solape 73,4mm



**S-37**  
Remate  
Solape 68,4mm

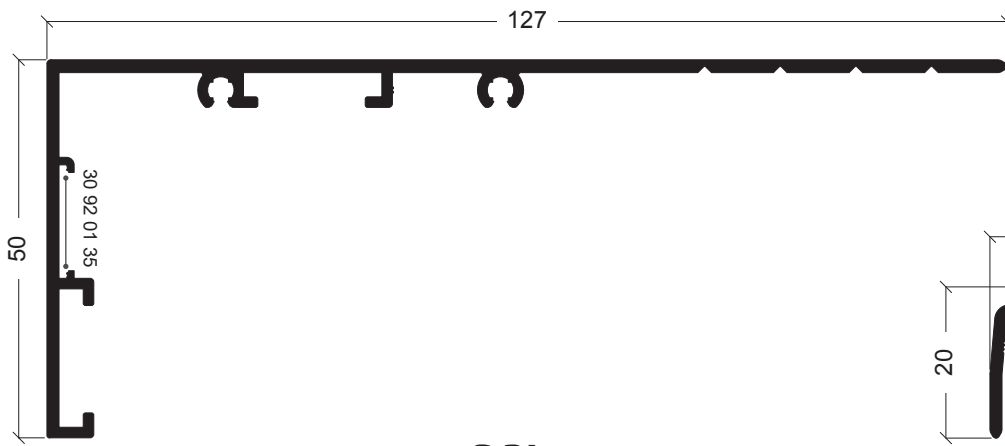

**S-24**  
Remate  
Solape 127x50mm

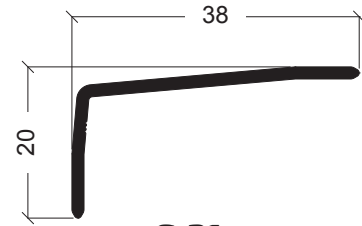

**S-31**  
Remate  
Solape 38x20mm

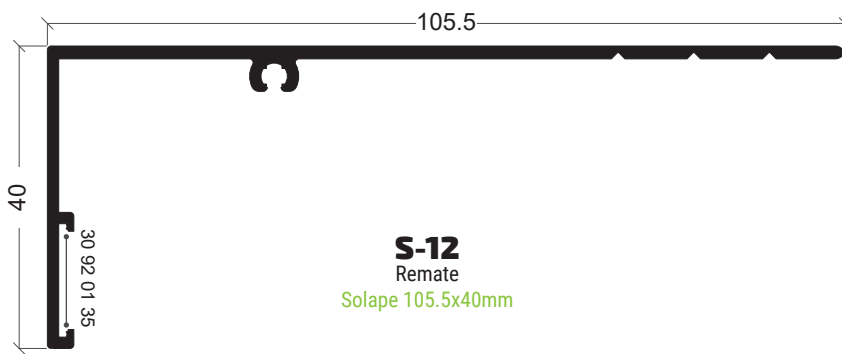

**S-12**  
Remate  
Solape 105.5x40mm

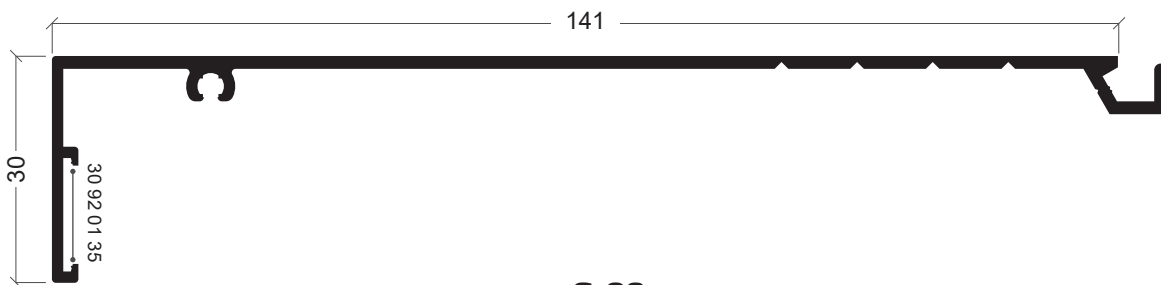

**S-09**  
Remate  
Solape 141x30mm

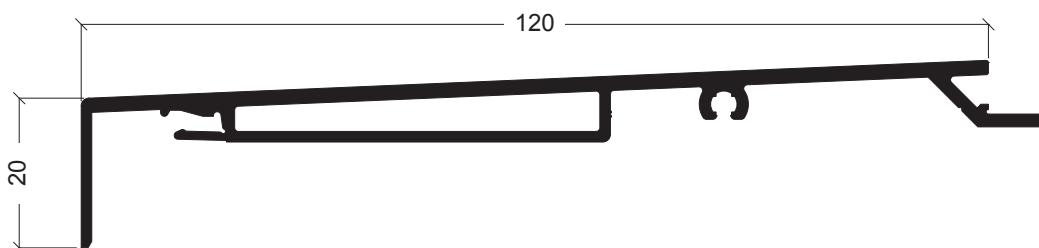

**S-23**  
Remate  
Solape 120x20mm

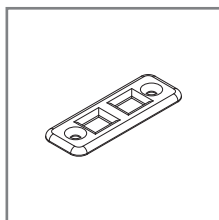

**30 24 30 75**

Contra-fecho inox aplicar com fechos lisos  
Contra cierre doble inferior inox

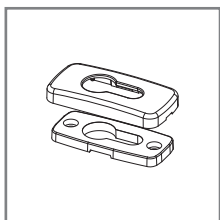

**30 60 16 55/56/57**

Escudo de alumínio branco/preto/2AC  
Escudo de alumínio blanco/negro

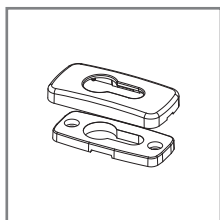

**30 60 16 58/59**

Escudo de alumínio champ ac/inox ac  
Escudo de alumínio champ ac/inox ac

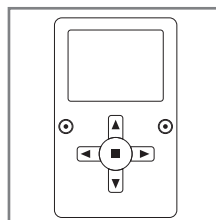

**30 90 90 04**

Comando para programação  
Comando para programação

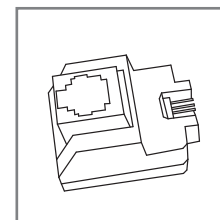

**30 90 90 05**

Modulo de ligação para WIFI e programação  
Modulo de ligação para WIFI e programación

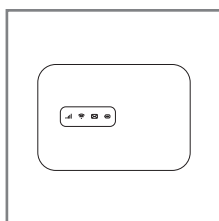

**30 90 90 06**

Modulo WIFI  
Modulo WIFI

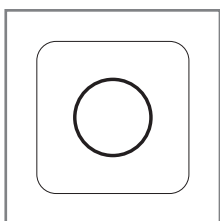

**30 90 90 07**

Interruptor CLEAN c/fonte 12V  
Interruptor CLEAN c/fonte 12V

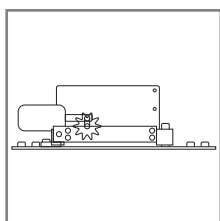

**30 90 90 08**

Motor 1F/2F p/ligações domótica  
Motor 1F/2F c/ conexión domótica

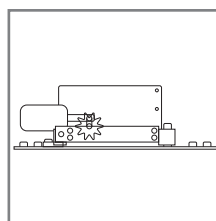

**30 90 90 09**

Motor telescópico p/ligações domótica  
Motor telescópico 1F/2F c/ conexión domótica

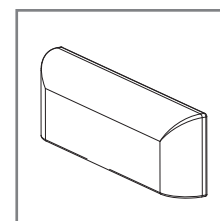

**30 92 01 00/01**

Goteira preto/branco  
Tapa salida de aguas negro/blanco

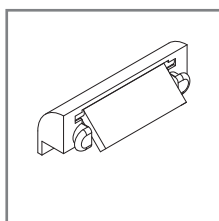

**30 92 01 02/03**

Goteira com válvula preto/branco  
Vierteaguas con agujero negro/blanco

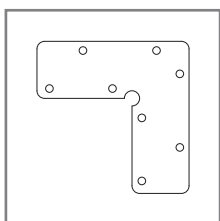

**30 92 01 35**

Esquadro de alinhamento  
Escuadra de alineamiento

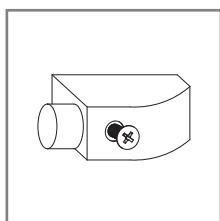

**30 94 50 20**

Limitador de abertura  
Limitador apertura

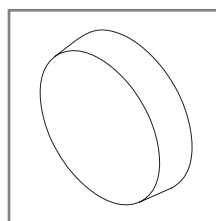

**30 94 50 36**

Tampa preta para parafuso cabeça de queijo 9.3  
Tapa negra para tornillo

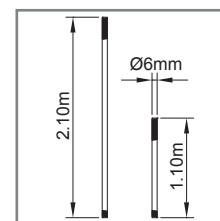

**30 94 60 31**

Conjunto varão alumínio 3m  
Conj. varilla aluminio 3mts

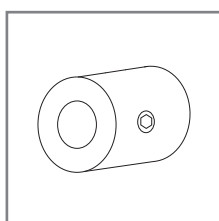

**30 94 60 32**

Guiador para varão por cada 500 mm  
Guiador Varilla

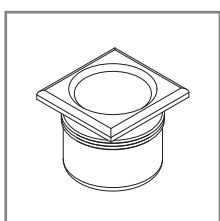

**30 94 60 34**

Contra-fecho central para puxador 3/4 F  
+ central (preto)  
Contracierre central negro

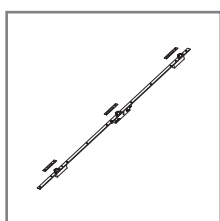

**30 94 60 36**

Fechadura 3 pontos sem canhão para correr  
Cierre Kristal 3 puntos sin bombillo para  
corredera

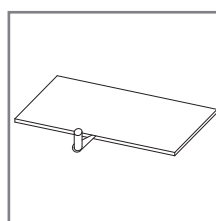

**30 94 60 62**

Calço para vidro 1mm  
Calço para vidrio 1mm

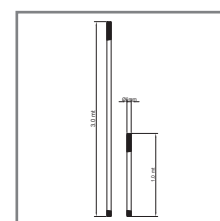

**30 94 60 80**

Conjunto varão inox roscado (4m)  
Conjunto varilla roscada inox(4m)

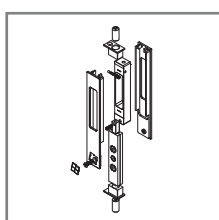

**30 94 61 45/46/47**

Fecho Puxador central branco/preto/natural  
Cierre manilla central blanco/negro/natural

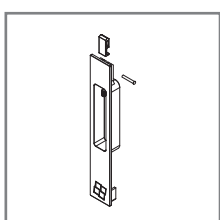

**30 94 61 48/49/50**

Puxador cego central branco/preto/natural  
Manilla ciega central blanca/negra/natural

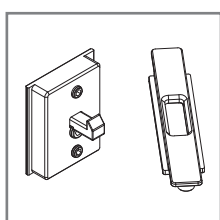

**30 94 61 75**

Conjunto ponto de fecho Gravity  
Conjunto punto de cierre Gravity

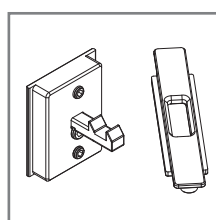

**30 94 61 76**

Conjunto Micro-ventilação Gravity  
Conjunto micro-ventilación Gravity

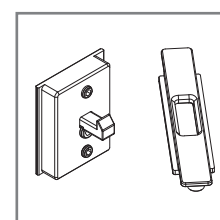

**30 94 61 85**

Conjunto ponto de fecho Gravity Inox  
Conjunto punto de cierre Gravity Inox

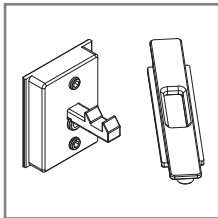

**30 94 61 86**

Conjunto Micro-ventilação Gravity Inox  
Conjunto micro-ventilación Gravity Inox

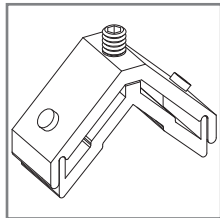

**30 94 64 00**

Esquadro Aro Fixo  
Escuadra

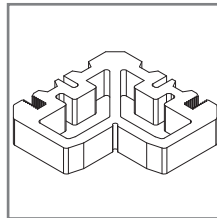

**30 94 64 01**

Esquadro para angulo 90  
Fijación lateral montante

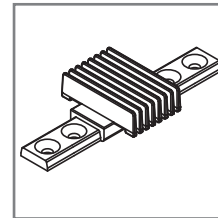

**30 94 64 02**

Corta-Vento  
Cortaviento

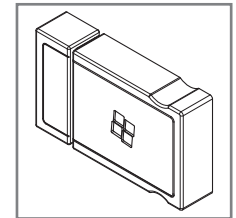

**30 94 64 05/06/07**

Fecho central 4F branco/preto/2AC  
Cierre central 4F blanco/negro/2AC

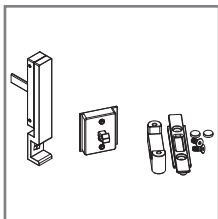

**30 94 64 10/11/12**

Fecho Gravity Prime branco/preto/2AC  
Cierre Gravity Prime blanco/negro/2AC

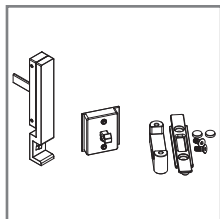

**30 94 64 13/14/15**

Fecho Gravity Prime manual branco/preto/2AC  
Cierre Gravity Prime manual blanco/negro/2AC

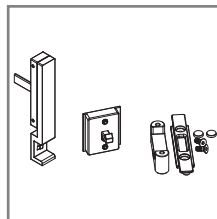

**30 94 64 16/17/18**

Fecho Gravity Prime Inox branco/preto/2AC  
Cierre Gravity Prime Inox blanco/negro/2AC

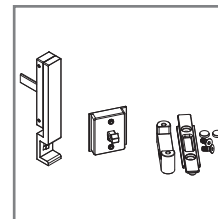

**30 94 64 19/20/21**

Fecho Gravity Prime manual Inox branco/  
preto/2AC  
Cierre Gravity Prime manual Inox blanco/  
negro/2AC

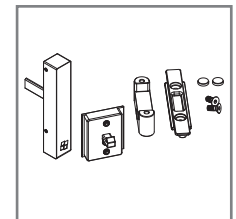

**30 94 64 22/23/24**

Fecho sem Aba Gravity Prime branco/preto/  
natural  
Cierre sin aba Gravity Prime blanco/negro/  
natural

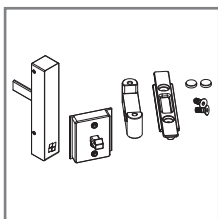

**30 94 64 25/26/27**

Fecho sem Aba Gravity Prime manual branco/  
preto/natural  
Cierre sin aba Gravity Prime manual blanco/  
negro/natural

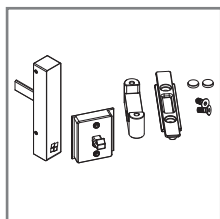

**30 94 64 28/29/30**

Fecho sem Aba Gravity Prime Inox branco/  
preto/natural  
Cierre sin aba Gravity Prime Inox blanco/  
negro/natural

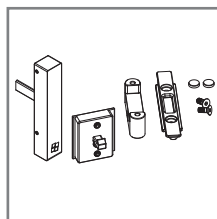

**30 94 64 31/32/33**

Fecho sem Aba Gravity Prime manual Inox  
branco/preto/natural  
Cierre sin aba Gravity Prime manual Inox  
branco/negro/natural

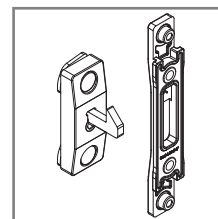

**30 94 64 35**

Conjunto fecho central Gravity  
Conjunto cierre central Gravity

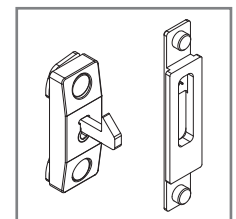

**30 94 64 36**

Conjunto fecho central Gravity Inox  
Conjunto cierre central Gravity Inox

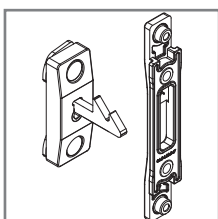

**30 94 64 37**

Conjunto Micro-Ventilação central Gravity  
Conjunto Micro-Ventilación central Gravity

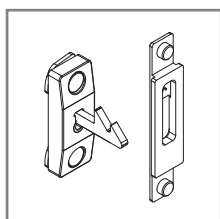

**30 94 64 38**

Conjunto Micro-Ventilação central Gravity Inox  
Conjunto Micro-Ventilación central Gravity Inox

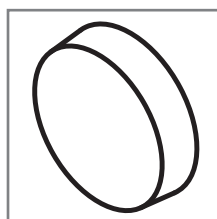

**30 94 64 39**

Batente  
Tope

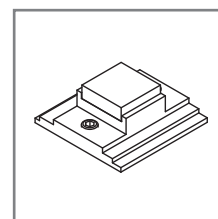

**30 94 64 40**

Batente lateral folha  
Tope lateral

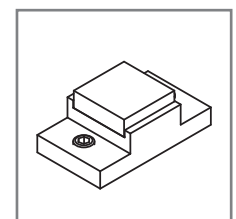

**30 94 64 41**

Batente central folha  
Tope central

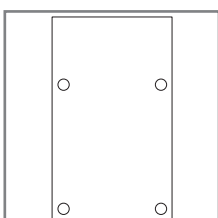

**30 94 64 42**

Topo caleira grande preto  
Tope canal grande negro

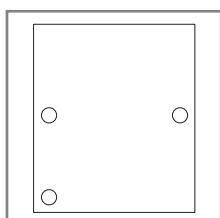

**30 94 64 43**

Topo caleira pequena preto  
Tope canal pequena negro

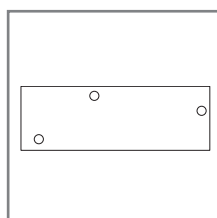

**30 94 64 44**

Topo pré-aro mono-rail preto  
Tope ZZZZ negro

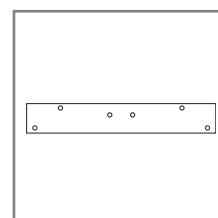

**30 94 64 45**

Topo pré-aro bi-rail preto  
Tope pré marco bicarril negro

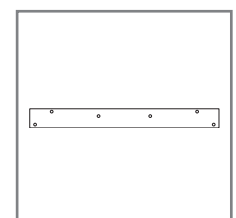

**30 94 64 46**

Topo pré-aro tri-rail preto  
Tope pré marco tricarril negro

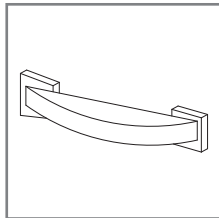

**30 94 64 48**

Deslizador  
Deslizador

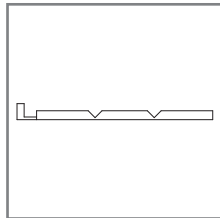

**30 94 64 50/51/52**

Calço para vidro 4x20/5x20/6x20  
Calço para vidro 4x20/5x20/6x20

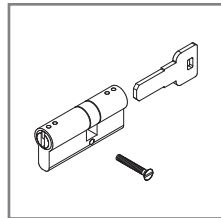

**30 94 64 54**

Canhão  
Bombillo

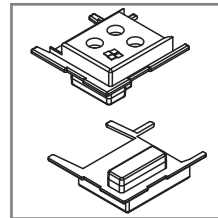

**30 94 64 55**

Conjunto topo canto preto  
Conjunto tope canto negro

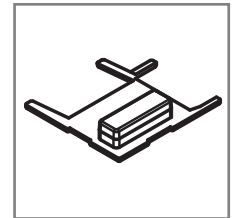

**30 94 64 56**

Topo Canto Embutida  
Tope canto incrustada

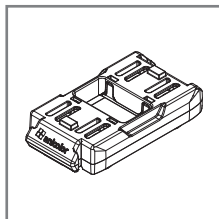

**30 94 64 60**

Rolamento Prime 250kg por rolamento  
Rolamiento Prime 250Kg por rolamiento

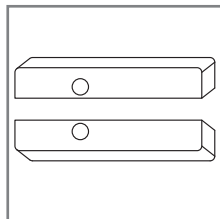

**30 94 64 65/66/67**

Conjunto topo central KL-85 branco/preto/2AC  
Conjunto tope central KL-85 blanco/negro/2C

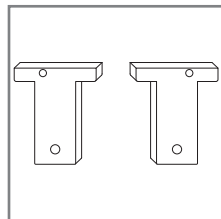

**30 94 64 70/71/72**

Conjunto topo central KL-86 branco/preto/2AC  
Conjunto tope central KL-86 blanco/negro/2C

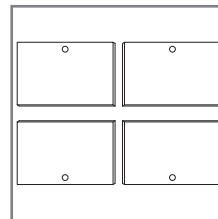

**30 94 64 75**

Kit juntas estanquidade KL-82  
Kit juntas estanquidad KL-82

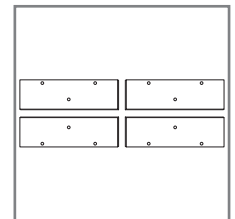

**30 94 64 76**

Kit juntas estanquidade KL-83  
Kit juntas estanquidad KL-83

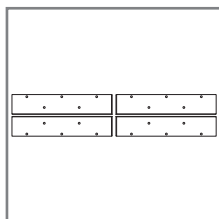

**30 94 64 77**

Kit juntas estanquidade KL-84  
Kit juntas estanquidad KL-84

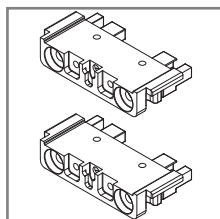

**30 94 65 00/01/02**

Conjunto ligação KL-52/59/62/64 branco/  
preto/2AC  
Conjunto ligación KL-52/59/62/64 blanco/  
preto/2AC

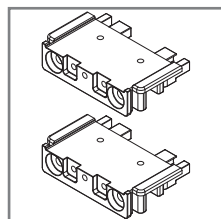

**30 94 65 03/04/05**

Conjunto ligação KL-56/72 branco/preto/2AC  
Conjunto ligación KL-56/72 blanco/negro/2AC

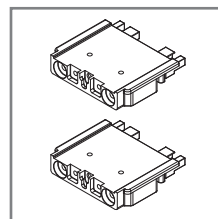

**30 94 65 06/07/08**

Conjunto ligação KL-53/77/76 branco/preto/2AC  
Conjunto ligación KL-53/77/76 blanco/  
negro/2AC

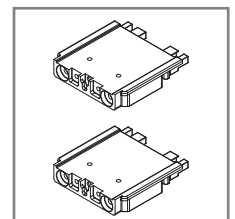

**30 94 65 09/10/11**

Conjunto ligação KL-78/79/80 branco/preto/2AC  
Conjunto ligación KL-78/79/80 blanco/  
negro/2AC

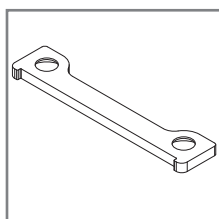

**30 94 65 12**

Topo Guia KL-70 preto  
Tope Guia KL-70 negro

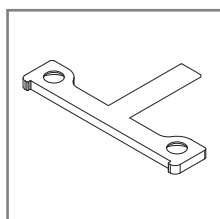

**30 94 65 13**

Topo Guia KL-54 preto  
Tope Guia KL-54 negro

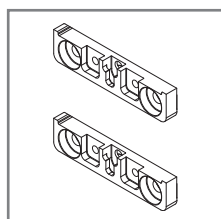

**30 94 65 14**

Conjunto ligação Galandage preto  
Conjunto ligación Galandage negro

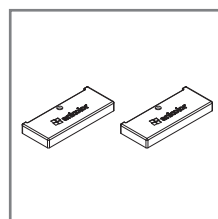

**30 94 65 15/16/17**

Conjunto Tampas (branco/preto/2AC)  
Conjunto Tapas (branco/negro/2AC)

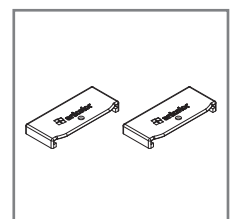

**30 94 65 18/19/20**

Conjunto Tampas Guia Embutida (branco/  
preto/2AC)  
Conjunto Tapas Guia Incrustada (branco/  
negro/2AC)

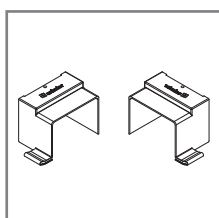

**30 94 65 25/26/27**

Conjunto Tampas KL-76 (branco/  
preto/2AC)  
Conjunto Tapas KL-76 (branco/  
negro/2AC)

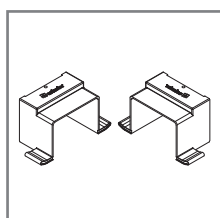

**30 94 65 28/29/30**

Conjunto Tampas KL-77 (branco/  
preto/2AC)  
Conjunto Tapas KL-77 (branco/  
negro/2AC)

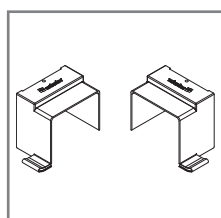

**30 94 65 31/32/33**

Conjunto Tampas KL-79 branco/  
preto/2AC  
Conjunto Tapas KL-79 blanco/negro/2AC

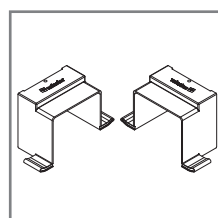

**30 94 65 34/35/36**

Conjunto Tampas KL-80 branco/  
preto/2AC  
Conjunto Tapas KL-80 blanco/negro/2AC

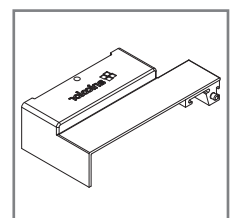

**30 94 65 40/41/42**

Tampa Esquerda KL-59 branco/preto/2AC  
Tapa Esquerda KL-59 blanco/negro/2AC

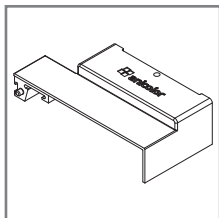

**30 94 65 43/44/45**

Tampa Direita KL-59 branco/preto/2AC  
Tapa Derecha KL-59 blanco/negro/2AC

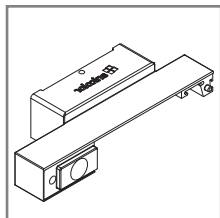

**30 94 65 50/51/52**

Tampa Esquerda KL-52 branco/preto/2AC  
Tapa Izquierda KL-52 blanco/negro/2AC

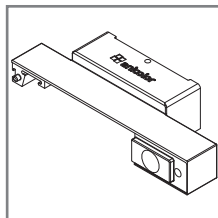

**30 94 65 53/54/55**

Tampa Direita KL-52 branco/preto/2AC  
Tapa Derecha KL-52 blanco/negro/2AC

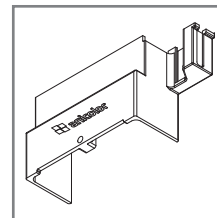

**30 94 65 60/61/62**

Tampa Esquerda KL-64 branco/preto/2AC  
Tapa Izquierda KL-64 blanco/negro/2AC

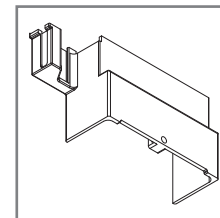

**30 94 65 63/64/65**

Tampa Direita KL-64 branco/preto/2AC  
Tapa Derecha KL-64 blanco/negro/2AC

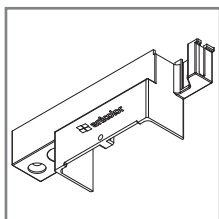

**30 94 65 70/71/72**

Tampa Esquerda KL-62 branco/preto/2AC  
Tapa Izquierda KL-62 blanco/negro/2AC

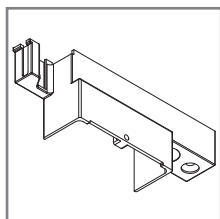

**30 94 65 73/74/75**

Tampa Direita KL-62 branco/preto/2AC  
Tapa Derecha KL-62 blanco/negro/2AC

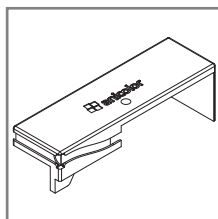

**30 94 65/80/81/82**

Tampa Esquerda KL-59 embutida branco/  
preto/2AC  
Tapa Izquierda KL-59 emprotada blanco/  
negro/2AC

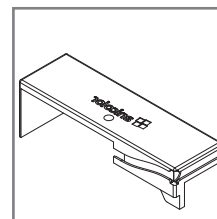

**30 94 65 83/84/85**

Tampa Direita KL-59 embutida branco/  
preto/2AC  
Tapa Derecha KL-59 emprotada blanco/  
negro/2AC

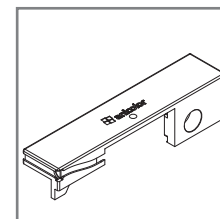

**30 94 65 90/91/92**

Tampa Esquerda KL-52 embutida branco/  
preto/2AC  
Tapa Izquierda KL-52 emprotada blanco/  
negro/2AC

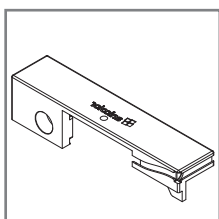

**30 94 65 93/94/95**

Tampa Direita KL-52 embutida branco/preto/2AC  
Tapa Derecha KL-52 emprotada blanco/  
negro/2AC

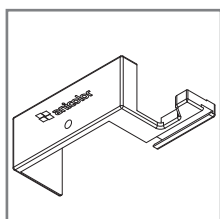

**30 94 66 00/01/02**

Tampa Esquerda KL-64 embutida branco/  
preto/2AC  
Tapa Izquierda KL-64 emprotada blanco/  
negro/2AC

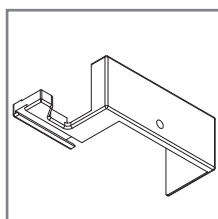

**30 94 66 03/04/05**

Tampa Direita KL-64 embutida branco/preto/2AC  
Tapa Derecha KL-64 emprotada blanco/  
negro/2AC

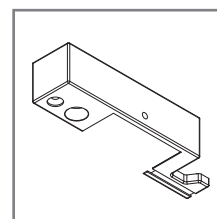

**30 94 66 10/11/12**

Tampa Esquerda KL-62 embutida branco/  
preto/2AC  
Tapa Izquierda KL-62 emprotada blanco/  
negro/2AC

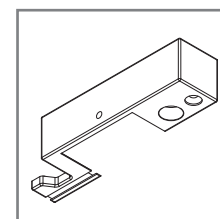

**30 94 66 13/14/15**

Tampa Direita KL-62 embutida branco/preto/2AC  
Tapa Derecha KL-62 emprotada blanco/  
negro/2AC

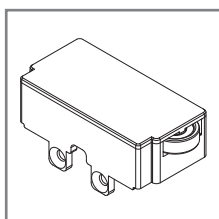

**30 94 66 20**

Carro guia  
Carro guía

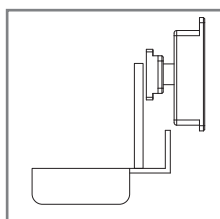

**30 94 66 21/22/23**

Conjunto puxador Prime branco/preto/2AC para  
perfil KL-56  
Conjunto manilla Prime blanco/negro/2AC para  
perfil KL-56

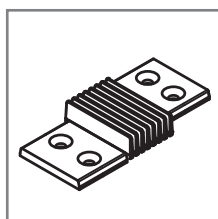

**30 94 66 25**

Corta-vento mono-rail  
Cortaviento monorail

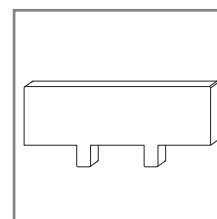

**30 94 66 26**

Junta de estanquidade para perfil de rolamentos  
Junta de estanquidad para perfil de rolamientos

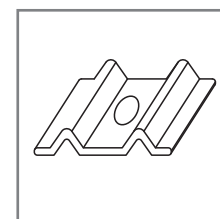

**30 94 66 27**

Mola para perfil de rolamento  
Muelle para perfil de rolamiento

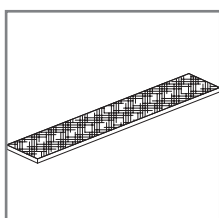

**30 95 60 56**

Barra de latão com 3m e fita adesiva  
dupla face  
Bar de latão com 3m e cinta adesiva  
dos lados

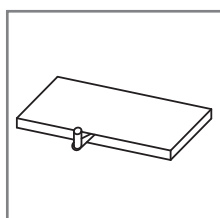

**30 95 60 72/73/74/75**

Calço de vidro 2/30 3/30 4/30 5/30  
Calço de vidrio 2/30 3/30 4/30 5/30

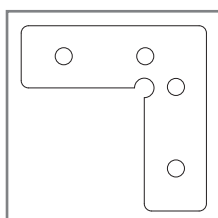

**30 96 00 22**

Esquadro alinhamento  
Escuadra alineamiento

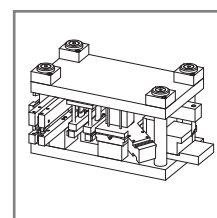

**33 94 66 00**



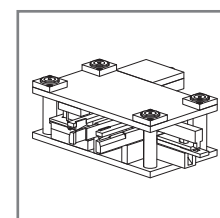

















Cunho Prime perimetral  
Troquel Prime perimetral



**33 94 66 01**

Cunho Prime recto  
Troquel Prime Recto



REFERÊNCIA • REFERENCIA	DESENHO • DISEÑO	DESCRIÇÃO • DESCRIPCIÓN
30 60 00 17		Junta exterior plana vidro 2mm • Junta exterior plana vidrio 2mm
30 60 00 21		Junta para caleiras • Junta para canal
30 93 00 60		Junta exterior vidro 4mm • Junta exterior vidrio 4mm
30 93 00 61		Junta exterior vidro 2mm • Junta exterior vidrio 2mm
30 93 00 62		Junta exterior plana vidro 4mm • Junta exterior plana vidrio 4mm
30 93 00 65		Junta interior vidro 5mm • Junta interior vidrio 5mm
30 93 00 66		Junta interior vidro 4mm • Junta interior vidrio 4mm
30 93 00 67		Junta interior vidro 2mm • Junta interior vidrio 2mm
30 93 00 68		Junta interior vidro 6/7mm • Junta interior vidrio 6/7mm
30 93 00 69		Junta interior vidro 8/9mm • Junta interior vidrio 8/9mm
30 94 60 12		Pelúcia tri-fin • Burlete tri-fin
30 94 64 61		Junta de estanquidade • Junta de estanquedad
30 94 64 80		Junta central termo-acústica • Junta central termo-acústica
30 94 64 81		Junta interior plana vidro 3mm • Junta interior plana vidrio 3mm
30 94 64 82		Junta interior plana vidro 5mm • Junta interior plana vidrio 5mm
30 94 64 83		Junta interior plana vidro 7mm • Junta interior plana vidrio 7mm
30 94 64 84		Junta interior plana vidro 9mm • Junta interior plana vidrio 9mm
30 95 00 10		Pelúcia 7x9 mm stop-fin • Burlete 7x9 mm stop-fin
30 95 00 30		Pelúcia 7x7 mm stop-fin • Burlete 7x7 mm stop-fin
30 95 00 40		Pelúcia 7x5.5 mm stop-fin • Burlete 7x5.5 mm stop-fin
30 95 00 50		Pelúcia 7x6 mm stop-fin • Burlete 7x6 mm stop-fin
30 95 60 02		Junta tapa canal • Junta tapa canal

**Janela 2 folhas correr • Ventana 2 hojas corredera**
**PERFIS • PERFIS**

DESENHO • DESEÑO	REF.	DESCRIÇÃO • DESCRIPCIÓN	CORTE CORTE	QUANTIDADE CANTIDAD	MEDIDAS • MEDIDA
	KL-51	Aro fixo Marco Fijo Doble		2	L
	KL-06 *	Separador fixo Separador poliamida central		2	L-98 mm
	KL-04	Tampa fixa Tapeta marco		4	(L/2)-125mm
	KL-58	Ombreira para fechos • Suplemento cierres		2	H-40mm
	AX-19	Vareta Pletina		2	H-93mm
	KL-63	Perfil tampa Embellecedor		2	H-37mm
	KL-55/RD	Perfil guia Rodamiento inferior		2	L (várias medidas)
	KL-57	Aro móvel inferior/superior Hoja inferior/superior		4	(L/2)-107mm
	KL-76	Aro móvel lateral Hoja lateral		2	H-93mm
	KL-52	Aro móvel central Hoja central con refuerzo		1	H-93mm
	KL-59	Aro móvel central Hoja central		1	H-93mm

\* preferencialmente cortar juntamente com o perfil KL-51 • preferiblemente cortado junto con el perfil KL-51

**ACESSÓRIOS E JUNTAS • ACCESORIOS Y JUNTAS**

REF.	DESCRIÇÃO • DESCRIPTION	QUANTIDADE CANTIDAD
30 94 64 00	Esquadro Aro Fixo • Escuadra MARCO	16
30 91 01 35	Esquadro de alinhamento • Escuadra alineamiento especial	8
30 92 01 02	Goteira com válvula • Vierteaguas con deflector blanco/negro	4
30 94 64 40	Batente Lateral • Batiente lateral	4
30 94 64 17	Fecho Gravity Inox • Cierre Gravity Inox	2
30 94 61 85	Conjunto fecho Gravity • Conjunto cierre Gravity	2
30 94 61 86	Conjunto fecho microventilação Gravity • Conj. cierre microventilación Gravity	2
30 94 65 07	Conjunto ligação KL-76 • Conjunto ligación KL-76	2
30 94 65 01	Conjunto ligação KL-52/59 • Conjunto ligación KL-52/59	2
30 94 66 20	Carro Guia • Carro guía	4
30 95 60 56	Barra de latão • Bar de latão	2L
30 94 64 02	Corta-vento • Cortaviento	2
30 94 65 26	Conjunto tampas KL-76 • Conjunto tapas KL-76	2
30 94 65 41	Tampa esq. KL-59 • Tapa izq. KL-59	1
30 94 65 44	Tampa dir. KL-59 • Tapa der. KL-59	1
30 94 65 51	Tampa esq. KL-52 • Tapa izq. KL-52	1
30 94 65 54	Tampa dir. KL-52 • Tapa der. KL-52	1
30 94 64 51	Calço 5x20 • Calzo 5x20	8
30 94 60 73	Calço 3mm • Calzo 3mm	12
30 94 64 80	Junta Central • Junta central	2H
30 95 60 02	Junta tapa canal • Junta tapa canal	4L
---	Junta vidro exterior • Junta vidrio exterior	2L+4H
---	Junta vidro interior • Junta vidrio interior	2L+4H
30 95 00 40	Pelúcia • Burlete	8L+4H
30 95 00 50	Pelúcia • Burlete	2H

**VIDRO • VIDRIO**

Espessura total máxima 56mm • Espesor máximo 56mm

Hv= H-116mm	Lv= (L/2) - 83mm
-------------	------------------

Aplicar intercalar do tipo Warm Edge • Selagem secundária do vidro duplo em silicone • Sellado secundario de doble vidrio de silicona  
 Aplicar vidro duplo ou triplo com bordos arestados • Aplicar vidrio doble o triple con bordos rugosos

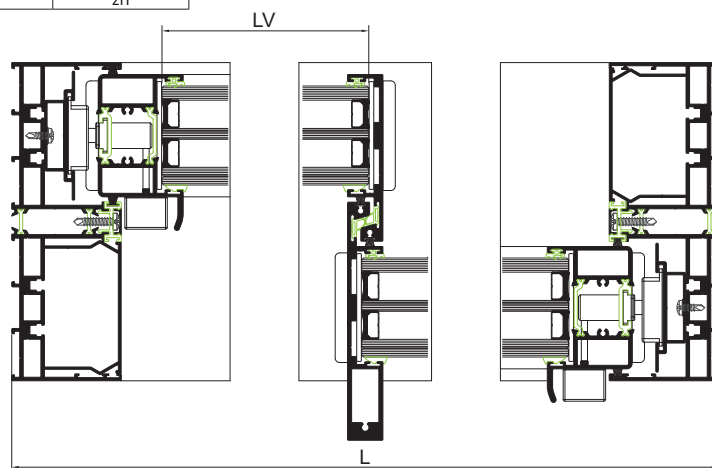
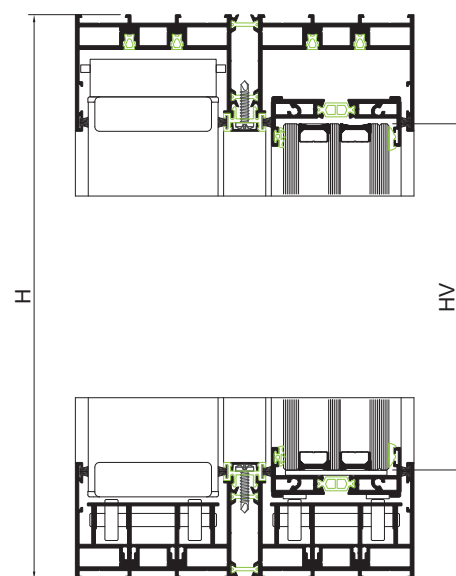
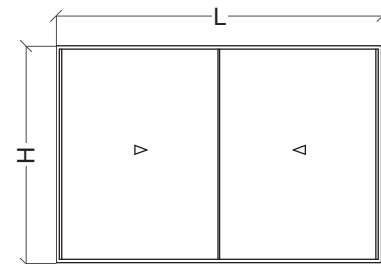

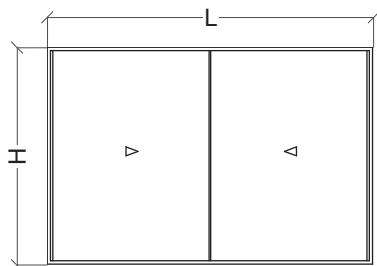
**Janela 2 folhas correr minimalista • Ventana 2 hojas corredera minimalista**
**PERFIS • PERFIS**

DESENHO • DESEÑO	REF.	DESCRIÇÃO • DESCRIPCIÓN	CORTE CORTE	QUANTIDADE CANTIDAD	MEDIDAS • MEDIDA
	KL-51	Aro fixo Marco Fijo Doble		2	L
				2	H
	KL-06 *	Separador fixo Separador poliamida central		2	L-98 mm
				2	H-98mm
	KL-04	Tampa fixa Tapeta marco		4	(L/2)-125mm
				2	H-124mm
	KL-58	Ombreira para fechos • Suplemento cierres		2	H-40mm
	AX-19	Vareta Pletina		2	H-93mm
	KL-63	Perfil tampa Embellecedor		2	H-37mm
	KL-55/RD	Perfil guia Rodamiento inferior		2	L (várias medidas)
	KL-57	Aro móvel inferior/superior Hoja inferior/superior		4	(L/2)-89mm
	KL-56	Aro móvel lateral Hoja lateral		2	H-93mm
	KL-52	Aro móvel central Hoja central con refuerzo		1	H-93mm
	KL-59	Aro móvel central Hoja central		1	H-93mm

**ACESSÓRIOS E JUNTAS • ACCESORIOS Y JUNTAS**

REF.	DESCRIÇÃO • DESCRIPTION	QUANTIDADE CANTIDAD
30 94 64 00	Esquadro Aro Fixo • Escuadra Marco	16
30 91 01 35	Esquadro de alinhamento • Escuadra alineamiento especial	8
30 92 01 02	Goteira com válvula •	4
30 94 64 40	Batente Lateral • Batiente lateral	4
30 94 66 22	Conjunto puxador Prime • Conjunto manilla Prime	2
30 94 61 85	Conjunto fecho Gravity • Conjunto cierre Gravity	2
30 94 61 86	Conjunto fecho microventilação Gravity • Conj. cierre microventilación Gravity	2
30 94 65 16	Conjunto ligação KL-56 • Conjunto ligación KL-56	2
30 94 65 01	Conjunto ligação KL-52/59 • Conjunto ligación KL-52/59	2
30 94 66 20	Carro Guia • Carro guia	4
30 95 60 56	Barra de latão • Bar de latão	2L
30 94 64 02	Corta-vento • Cortaviento	2
30 94 65 16	Conjunto tampas • Conjunto tapas	2
30 94 65 41	Tampa esq. KL-59 • Tapa izq. KL-59	1
30 94 65 44	Tampa dir. KL-59 • Tapa der. KL-59	1
30 94 65 51	Tampa esq. KL-52 • Tapa izq. KL-52	1
30 94 65 54	Tampa dir. KL-52 • Tapa der. KL-52	1
30 94 64 51	Calço 5x20 • Calzo 5x20	8
30 94 60 73	Calço 3mm • Calzo 3mm	12
30 94 64 80	Junta Central • Junta central	2H
30 95 60 02	Junta tapa canal • Junta tapa canal	4L
---	Junta vidro exterior • Junta vidrio exterior	2L+4H
---	Junta vidro interior • Junta vidrio interior	2L+4H
30 95 00 40	Pelúcia • Burlete	8L+6H

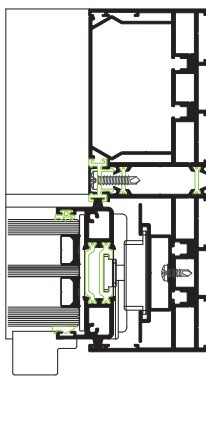
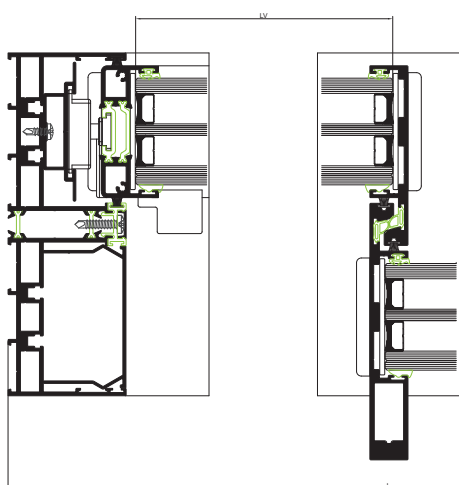
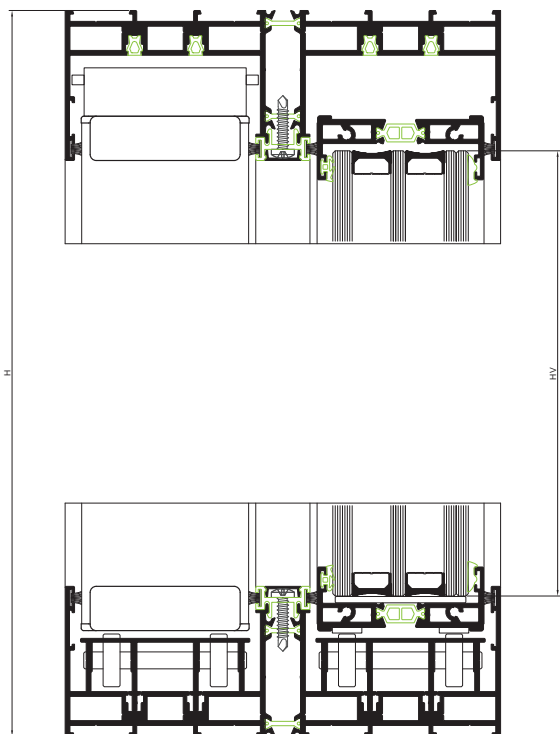
**VIDRO • VIDRIO**

Espessura total máxima 56mm • Espesor máximo 56mm

Hv= H-116mm      Lv= (L/2) - 65mm

























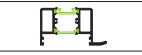





Aplicar intercalar do tipo Warm Edge •

Selagem secundária do vidro duplo em silicone • Sellado secundario de doble vidrio de silicona

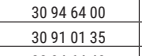
Aplicar vidro duplo ou triplo com bordos arestados • Aplicar vidrio doble o triple con bordos rugosos

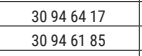
**Janela 3 folhas com pré-aro • Ventana 3 hojas con pre-marco**

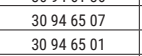
PERFIS • PERFIS

DESENHO • DESEÑO	REF.	DESCRIÇÃO • DESCRIPCIÓN	CORTE CORTE	QUANTIDADE CANTIDAD	MEDIDAS • MEDIDA
	KL-51	Aro fixo Marco fijo doble		2	L
	KL-06 *	Separador fixo Separador poliámidá central		2	L-98 mm
	KL-04	Tampa fixa Tapeta marco		4	(L/3)-46mm
				2	(L/3)-86mm
	KL-58	Ombreira para fechos • Suplemento cierres		2	H-68mm
	AX-19	Vareta Pletina		2	H-121mm
	KL-63	Perfil tampa Embellecedor		2	H-65mm
	KL-55/RD	Perfil guia Rodamiento inferior		2	L (várias medidas)
	KL-57	Aro móvel inferior/superior Hoja inferior/superior		6	(L/3)-78mm
	KL-76	Aro móvel lateral Hoja lateral		2	H-121mm
	KL-52	Aro móvel central Hoja central con refuerzo		2	H-121mm
	KL-59	Aro móvel central Hoja central		2	H-121mm
	KL-93	Pré-Aro • Pre-marco doble		1	L-6mm
	KL-95	Caleira • Canalón		1	L-6mm
	KL-13/R	Tampa com furação • Embellecedor troquelado		1	L-6mm

\* preferencialmente cortar juntamente com o perfil KL-51 • preferiblemente cortado junto con el perfil KL-51

**ACESSÓRIOS E JUNTAS • ACCESORIOS Y JUNTAS**

REF.	DESCRIÇÃO • DESCRIPTION	QUANTIDADE CANTIDAD
30 94 64 00	Esquadro Aro Fixo • Escuadra Marco	16
30 91 01 35	Esquadro de alinhamento • Escuadra alineamiento especial	8
30 94 64 40	Batente Lateral • Batiente lateral	4
30 94 64 17	Fecho Gravity Inox • Cierre Gravity Inox	2
30 94 61 85	Conjunto fecho Gravity • Conjunto cierre Gravity	2
30 94 61 86	Conjunto fecho microventilação Gravity • Conj. cierre microventilación Gravity	2
30 94 65 07	Conjunto ligação KL-76 • Conjunto ligación KL-76	2
30 94 65 01	Conjunto ligação KL-52/59 • Conjunto ligación KL-52/59	4
30 94 66 20	Carro Guia • Carro guía	6
30 95 60 56	Barra de latão • Bar de latão	2L
30 94 64 02	Corta-vento • Cortaviento	4
30 94 65 26	Conjunto tampas KL-76 • Conjunto tapas KL-76	2
30 94 65 41	Tampa esq. KL-59 • Tapa izq. KL-59	2
30 94 65 44	Tampa dir. KL-59 • Tapa der. KL-59	2
30 94 65 51	Tampa esq. KL-52 • Tapa izq. KL-52	2
30 94 65 54	Tampa dir. KL-52 • Tapa der. KL-52	2
30 94 64 42	Topo caleira • Tope canalon	2
30 94 64 45	Topo pré-aro • Tope pré-marco	2
30 94 64 51	Calço 5x20 • Calzo 5x20	16
30 94 60 73	Calço 3mm • Calzo 3mm	18
30 94 64 80	Junta Central • Junta central	4H
30 95 60 02	Junta tapa canal • Junta tapa canal	4L
---	Junta vidro exterior • Junta vidrio exterior	2L+6H
---	Junta vidro interior • Junta vidrio interior	2L+6H
30 95 00 40	Pelúcia • Burlete	8L+4H
30 95 00 50	Pelúcia • Burlete	4H







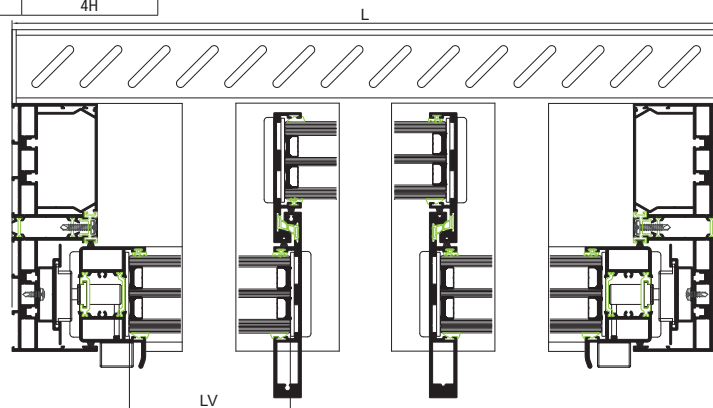
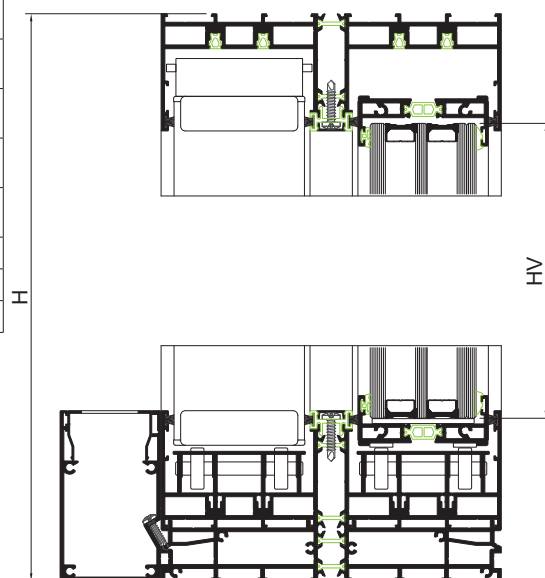
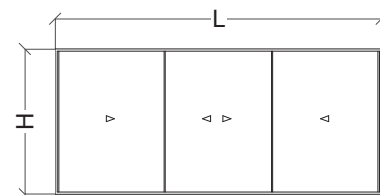



















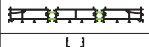

**VIDRO • VIDRIO**

Espessura total máxima 56mm • Espesor máximo 56mm

Hv= H-144mm	Lv= (L/3) - 54mm
-------------	------------------

 Aplicar intercalar do tipo Warm Edge •  
 Selagem secundária do vidro duplo em silicone • Sellado secundario de doble vidrio de silicona  
 Aplicar vidro duplo ou triplo com bordos arestados • Aplicar vidrio doble o triple con bordos rugosos

**Janela 3 folhas tri-rail com pré-aro • Ventana 3 hojas tri-rail con pré-marco**
**PERFIS • PERFIS**

DESENHO • DESEÑO	REF.	DESCRIÇÃO • DESCRIPCIÓN	CORTE CORTE	QUANTIDADE CANTIDAD	MEDIDAS • MEDIDA
	KL-73	Aro fixo tri-rail Marco Fijo triple		2	L
	KL-06 *	Separador fixo Separador poliamida central		4	L-98 mm
	KL-04	Tampa fixa Tapeta marco		2	(L/3)-46mm (L/3)-86mm (L/2)-18mm
	KL-58	Ombreira para fechos • Suplemento cierres		2	H-68mm
	AX-19	Vareta Pletina		2	H-121mm
	KL-63	Perfil tampa Embelecedor		4	H-65mm
	KL-55/RD	Perfil guia Rodamiento inferior		3	L (várias medidas)
	KL-57	Aro móvel inferior/superior Hoja inferior/superior		6	(L/3)-78mm
	KL-76	Aro móvel lateral Hoja lateral		2	H-121mm
	KL-52	Aro móvel central Hoja central con refuerzo		2	H-121mm
	KL-59	Aro móvel central Hoja central		2	H-121mm
	KL-94	Pré-Aro • Premarco triple		1	L-6mm
	KL-95	Caleira • Canalon		1	L-6mm
	KL-13/R	Tampa com furação • Embelecedor troquelado		1	L-6mm

\* preferencialmente cortar juntamente com o perfil KL-73 • preferiblemente cortado junto con el perfil KL-73

**ACESSÓRIOS E JUNTAS • ACCESORIOS Y JUNTAS**

REF.	DESCRIÇÃO • DESCRIPTION	QUANTIDADE CANTIDAD
30 94 64 00	Esquadro Aro Fixo • Escuadra Marco	24
30 91 01 35	Esquadro de alinhamento • Escuadra alineamiento especial	8
30 94 64 40	Batente Lateral • Batiente lateral	4
30 94 64 17	Fecho Gravity Inox • Cierre Gravity Inox	2
30 94 61 85	Conjunto fecho Gravity • Conjunto cierre Gravity	2
30 94 61 86	Conjunto fecho microventilação Gravity • Conj. cierre microventilación Gravity	2
30 94 65 07	Conjunto ligação KL-76 • Conjunto ligación KL-76	2
30 94 65 01	Conjunto ligação KL-52/59 • Conjunto ligación KL-52/59	4
30 94 66 20	Carro Guia • Carro guía	6
30 95 60 56	Barra de latão • Bar de latón	2L
30 94 64 02	Corta-vento • Cortaviento	4
30 94 65 26	Conjunto tampas KL-76 • Conjunto tapas KL-76	2
30 94 65 41	Tampa esq. KL-59 • Tapa izq. KL-59	2
30 94 65 44	Tampa dir. KL-59 • Tapa der. KL-59	2
30 94 65 51	Tampa esq. KL-52 • Tapa izq. KL-52	2
30 94 65 54	Tampa dir. KL-52 • Tapa der. KL-59	2
30 94 64 42	Topo caleira • Tapa canalon	2
30 94 64 46	Topo pré-aro • Tapa pré-marco	2
30 94 64 51	Calço 5x20 • Calzo 5x20	16
30 94 60 73	Calço 3mm • Calzo 3mm	18
30 94 64 80	Junta Central • Junta central	4H
30 95 60 02	Junta tapa canal • Junta tapa canal	6L
---	Junta vidro exterior • Junta vidrio exterior	2L+6H
---	Junta vidro interior • Junta vidrio interior	2L+6H
30 95 00 40	Pelúcia • Burlete	12L+4H
30 95 00 50	Pelúcia • Burlete	4H

**VIDRO • VIDRIO**







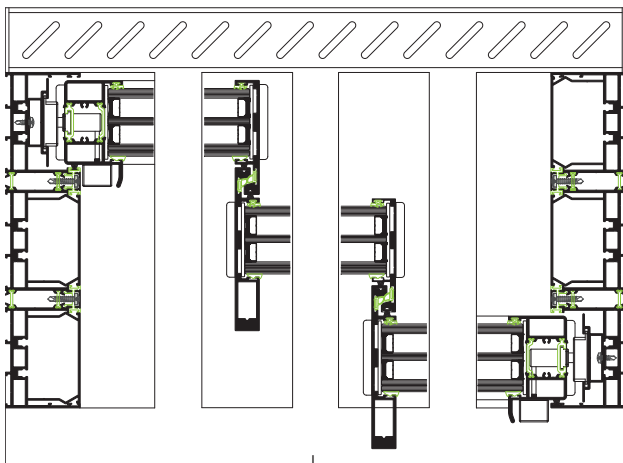
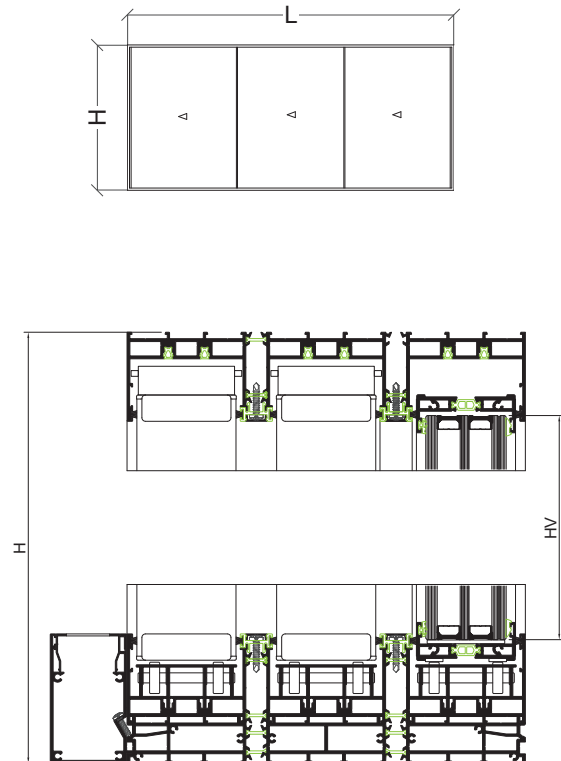















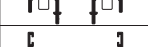



Espessura total máxima 56mm • Espesor máximo 56mm

Hv= H-144mm Lv= (L/3) - 54mm

Aplicar intercalar do tipo Warm Edge •  
 Selagem secundária do vidro duplo em silicone • Sellado secundario de doble vidrio de silicona  
 Aplicar vidro duplo ou triplo com bordos arestados • Aplicar vidrio doble o triple con bordos rugosos



**Janela 3 folhas tri-rail com corte recto • Ventana 3 hojas tri-rail con corte recto**
**PERFIS • PERFIS**

DESENHO • DESEÑO	REF.	DESCRIÇÃO • DESCRIPCIÓN	CORTE CORTE	QUANTIDADE CANTIDAD	MEDIDAS • MEDIDA
	KL-73	Aro fixo tri-rail Marco Fijo triple		2	H
	KL-84	Soleira/Padieira tri-rail Solape tricarril		2	L-37mm
	KL-06 *	Separador fixo Separador poliamida central		4	L-110 mm
				4	H-108mm
	KL-04	Tampa fixa Tapeta marco		4	(L/3)-46mm
				2	(L/3)-86mm
				2	(L/2)-18mm
	KL-58	Ombreira para fechos • Suplemento cierres		2	H-24mm
	AX-19	Vareta Pletina		2	H-77mm
	KL-63	Perfil tampa Embelecedor		4	H-21mm
	KL-55/RD	Perfil guia Rodamiento inferior		3	L (várias medidas)
	KL-57	Aro móvel inferior/superior Hoja inferior/superior		6	(L/3)-78mm
	KL-76	Aro móvel lateral Hoja lateral		2	H-77mm
	KL-52	Aro móvel central Hoja central con refuerzo		2	H-77mm
	KL-59	Aro móvel central Hoja central		2	H-77mm

\* preferencialmente cortar juntamente com o perfil KL-73 • preferiblemente cortado junto con el perfil KL-73

**ACESSÓRIOS E JUNTAS • ACCESORIOS Y JUNTAS**

REF.	DESCRIÇÃO • DESCRIPTION	QUANTIDADE CANTIDAD
30 94 64 40	Batente Lateral • Batiante lateral	4
30 94 64 17	Fecho Gravity Inox • Cierre Gravity Inox	2
30 94 61 85	Conjunto fecho Gravity • Conjunto cierre Gravity	2
30 94 61 86	Conjunto fecho microventilação Gravity • Conj. cierre microventilación Gravity	2
30 94 65 07	Conjunto ligação KL-76 • Conjunto ligación KL-76	2
30 94 65 01	Conjunto ligação KL-52/59 • Conjunto ligación KL-52/59	4
30 94 66 20	Carro Guia • Carro guía	6
30 95 60 56	Barra de latão • Bar de latón	2L
30 94 64 02	Corta-vento • Cortaviento	4
30 94 65 26	Conjunto tampas KL-76 • Conjunto tapas KL-76	2
30 94 65 41	Tampa esq. KL-59 • Tapa izq. KL-59	2
30 94 65 44	Tampa dir. KL-59 • Tapa der. KL-59	2
30 94 65 51	Tampa esq. KL-52 • Tapa izq. KL-52	2
30 94 65 54	Tampa dir. KL-52 • Tapa der. KL-52	2
30 94 64 76	Kit juntas estanquidade KL-83 • Kit juntas estanquidad KL-83	1
30 94 64 51	Calço 5x20 • Calzo 5x20	16
30 94 60 73	Calço 3mm • Calzo 3mm	18
30 94 64 80	Junta Central • Junta central	4H
30 95 60 02	Junta tapa canal • Junta tapa canal	6L
---	Junta vidro exterior • Junta vidrio exterior	2L+6H
---	Junta vidro interior • Junta vidrio interior	2L+6H
30 95 00 40	Pelúcia • Burlete	12L+8H











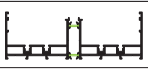













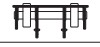



**VIDRO • VIDRIO**

Espessura total máxima 56mm • Espesor máximo 56mm

Hv= H-100mm      Lv= (L/3) - 54mm

Aplicar intercalar do tipo Warm Edge • Selagem secundária do vidro duplo em silicone • Sellado secundario de doble vidrio de silicona  
 Aplicar vidro duplo ou triplo com bordos arestados • Aplicar vidrio doble o triple con bordos rugosos

**Janela 4 folhas minimalista • Ventana 4 hojas minimalista**
**PERFIS • PERFILES**

DESENHO • DISEÑO	REF.	DESCRIÇÃO • DESCRIPCIÓN	CORTE CORTE	QUANTIDADE CANTIDAD	MEDIDAS • MEDIDA
	KL-51	Aro fixo Marco Fijo Doble		2	L
				2	H
	KL-06 *	Separador fixo Separador poliamida central		2	L-98 mm
				2	H-98mm
	KL-04	Tampa fixa Tapeta marco		4	(L/4)-31mm
				4	(L/4)-71mm
	KL-58	Ombreira para fechos • Suplemento cierres		2	H-40mm
	AX-19	Vareta Pletina		2	H-93mm
	KL-63	Perfil tampa Embellecedor		2	H-37mm
	KL-55/RD	Perfil guia Rodamiento inferior		2	L (várias medidas)
	KL-57	Aro móvel inferior/superior Hoja inferior/superior		8	(L/4)-63mm
	KL-76	Aro móvel lateral Hoja lateral		2	H-93mm
	KL-52	Aro móvel central Hoja central con refuerzo		2	H-93mm
	KL-59	Aro móvel central Hoja central		2	H-93mm
	KL-62	Aro móvel central Hoja central		1	H-93mm
	KL-64	Aro móvel central Hoja central		1	H-93mm

\* preferencialmente cortar juntamente com o perfil KL-51 • preferiblemente cortado junto con el perfil KL-51

**ACESSÓRIOS E JUNTAS • ACCESORIOS Y JUNTAS**

REF.	DESCRIÇÃO • DESCRIPTION	QUANTIDADE CANTIDAD
30 94 64 00	Esquadro Aro Fixo • Escuadra Marco	16
30 91 01 35	Esquadro de alinhamento • Escuadra alineamiento especial	8
30 92 01 02	Goteira com válvula • Tapa salida de aguas con deflector (negro)	4
30 94 64 40	Batente Lateral • Batiente lateral	4
30 94 64 17	Fecho Gravity Inox • Cierre Gravity Inox	2
30 94 61 85	Conjunto fecho Gravity • Conjunto cierre Gravity	2
30 94 61 86	Conjunto fecho microventilação Gravity • Conj. cierre microventilación Gravity	2
30 94 64 06	Fecho Central 4F • Cierre central 4F	2
30 94 65 07	Conjunto ligação KL-76 • Conjunto ligación KL-76	2
30 94 65 01	Conjunto ligação KL-52/59/62/64 • Conjunto ligación KL-52/59/62/64	6
30 94 66 20	Carro Guia • Carro guía	8
30 95 60 56	Barra de latão • Bar de latão	2L
30 94 64 02	Corta-vento • Cortaviento	6
30 94 65 26	Conjunto tampas KL-76 • Conjunto tapas KL-76	2
30 94 65 41	Tampa esq. KL-59 • Tapa izq. KL-59	2
30 94 65 44	Tampa dir. KL-59 • Tapa der. KL-59	2
30 94 65 51	Tampa esq. KL-52 • Tapa izq. KL-52	2
30 94 65 54	Tampa dir. KL-52 • Tapa der. KL-52	2
30 94 65 61	Tampa esq. KL-64 • Tapa izq. KL-64	1
30 94 65 64	Tampa dir. KL-64 • Tapa der. KL-64	1
30 94 65 71	Tampa esq. KL-62 • Tapa izq. KL-62	1
30 94 65 74	Tampa dir. KL-62 • Tapa der. KL-62	1
30 94 64 51	Calço 5x20 • Calzo 5x20	24
30 94 60 73	Calço 3mm • Calzo 3mm	20
30 94 64 80	Junta Central • Junta central	6H
30 95 60 02	Junta tapa canal • Junta tapa canal	4L
---	Junta vidro exterior • Junta vidrio exterior	2L+8H
---	Junta vidro interior • Junta vidrio interior	2L+8H
30 95 00 40	Pelúcia • Burlete	8L+4H
30 95 00 50	Pelúcia • Burlete	6H

**VIDRO • VIDRIO**







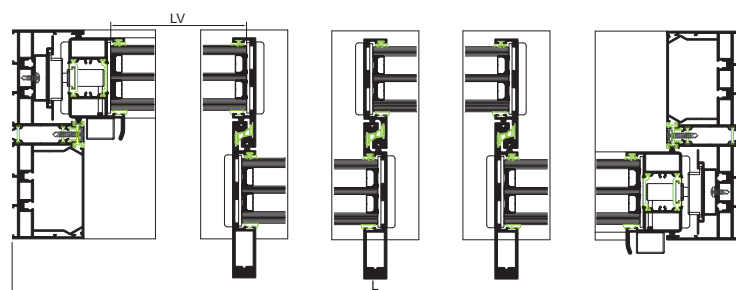
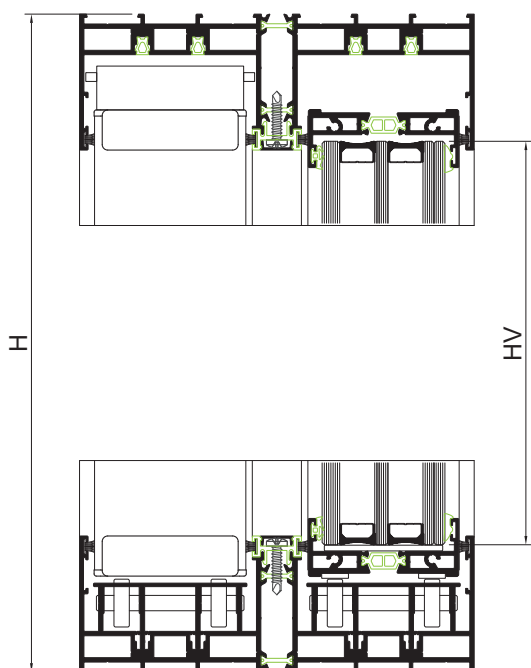
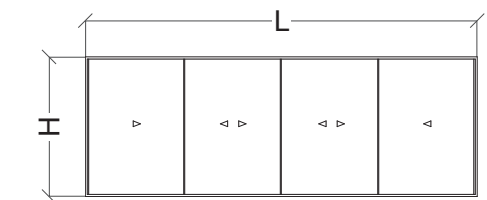













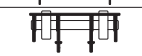







Espessura total máxima 56mm • Espesor máximo 56mm

Hv= H-116mm Lv= (L/4) - 40mm

Aplicar intercalar do tipo Warm Edge • Selagem secundária do vidro duplo em silicone • Sellado secundario de doble vidrio de silicona  
 Aplicar vidro duplo ou triplo com bordos arestados • Aplicar vidrio doble o triple con bordos rugosos



**Janela 2 folhas com soleira embutida • Ventana 2 hojas con solape empotrada**
**PERFIS • PERFIS**

DESENHO • DESEÑO	REF.	DESCRIÇÃO • DESCRIPCIÓN	CORTE CORTE	QUANTIDADE CANTIDAD	MEDIDAS • MEDIDA
	KL-51	Aro fixo Marco Fijo Doble		2	L
	KL-06 *	Separador fixo Separador poliámidia central		2	L-98 mm
	KL-04	Tampa fixa Tapeta marco		4	(L/2)-125mm
	KL-58	Ombreira para fechos • Suplemento cierres		2	H-40mm
	AX-19	Vareta Pletina		2	H-141mm
	KL-63	Perfil tampa Embelecedor		2	H-37mm
	KL-55/RD	Perfil guia Rodamiento inferior		2	L (várias medidas)
	KL-57	Aro móvel inferior/superior Hoja inferior/superior		4	(L/2)-107mm
	KL-76	Aro móvel lateral Hoja lateral		2	H-141mm
	KL-52	Aro móvel central Hoja central con refuerzo		1	H-141mm
	KL-59	Aro móvel central Hoja central		1	H-141mm
	KL-54	Soleira Embutida Solape de unión		2	(L/2)-27mm
	KL-65	Tampa lateral Embelecedor lateral		2	(L/2)-62mm
	KL-66	Tampa Central Embelecedor Central		2	(L/2)-35mm

\* preferencialmente cortar juntamente com o perfil KL-51 • preferiblemente cortado junto con el perfil KL-51

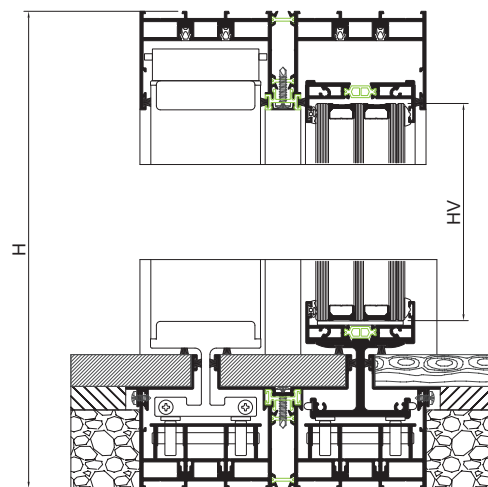
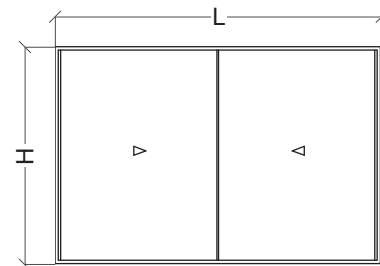
**ACESSÓRIOS E JUNTAS • ACCESORIOS Y JUNTAS**

REF.	DESCRIÇÃO • DESCRIPTION	QUANTIDADE CANTIDAD
30 94 64 00	Esquadro Aro Fixo • Escuadra Marco	16
30 91 01 35	Esquadro de alinhamento • Escuadra alineamiento especial	8
30 92 01 02	Goteira com válvula • Vierendeaguas con deflector blanco/negro	4
30 94 64 40	Batente Lateral • Batiente lateral	4
30 94 64 17	Fecho Gravity Inox • Cierre Gravity Inox	2
30 94 61 85	Conjunto fecho Gravity • Conjunto cierre Gravity	2
30 94 61 86	Conjunto fecho microventilação Gravity • Conj. cierre microventilación Gravity	2
30 94 65 07	Conjunto ligação KL-76 • Conjunto ligación KL-76	2
30 94 65 01	Conjunto ligação KL-52/59 • Conjunto ligación KL-52/59	2
30 94 66 20	Carro Guia • Carro guia	4
30 95 60 56	Barra de latão • Bar de latão	2L
30 94 64 02	Corta-vento • Cortaviento	1
30 94 65 26	Conjunto tampas KL-76 • Conjunto tapas KL-76	1
30 94 65 19	Conjunto tampas guia embutida • Conjunto tapas guia incrustada	1
30 94 65 44	Tampa dir. KL-59 • Tapa der. KL-59	1
30 94 65 54	Tampa dir. KL-52 • Tapa der. KL-52	1
30 94 65 81	Tampa esq. embutida KL-59 • Tapa izq. incrustada KL-59	1
30 94 65 91	Tampa esq. embutida KL-52 • Tapa izq. incrustada KL-52	1
30 94 65 13	Topo guia KL-54 • Tope guia KL-54	4
30 94 64 48	Deslizador • Deslizador	8
30 94 64 51	Calço 5x20 • Calzo 5x20	8
30 94 60 73	Calço 3mm • Calzo 3mm	12
30 94 64 80	Junta Central • Junta central	2H
30 95 60 02	Junta tapa canal • Junta tapa canal	4L
---	Junta vidro exterior • Junta vidrio exterior	2L+4H
---	Junta vidro interior • Junta vidrio interior	2L+4H
30 95 00 40	Pelúcia • Burlete	4L+4H
30 95 00 30	Pelúcia • Burlete	2L
30 95 00 50	Pelúcia • Burlete	4L+2H

**VIDRO • VIDRIO**

Espessura total máxima 56mm • Espesor máximo 56mm





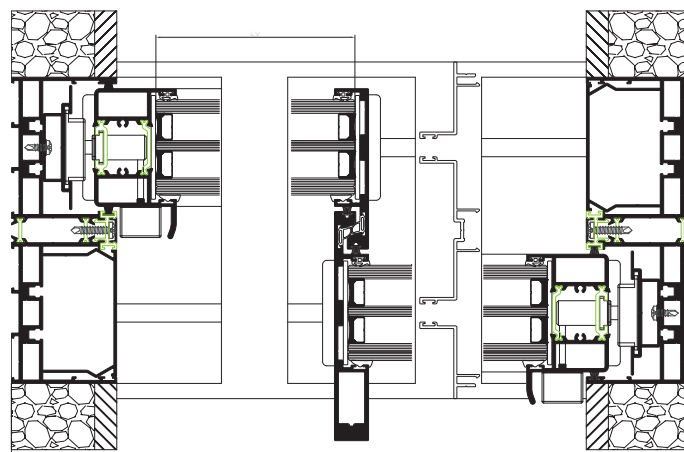



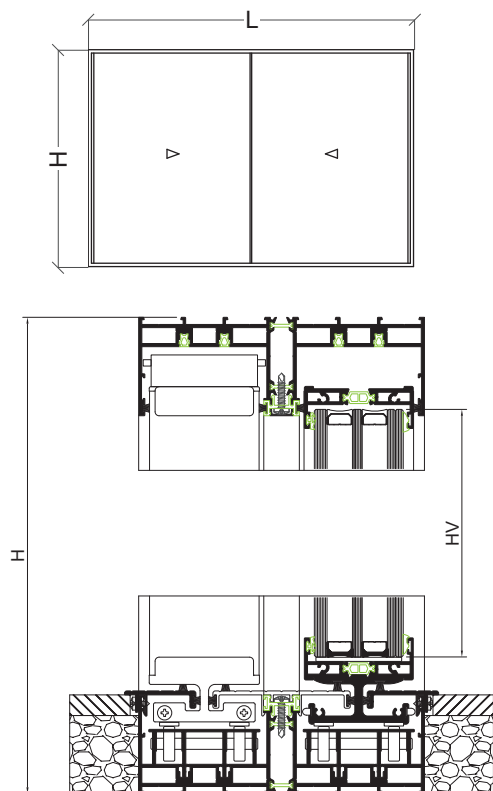



























Hv= H-164mm      Lv= (L/2) - 83mm

Aplicar intercalar do tipo Warm Edge • Selagem secundária do vidro duplo em silicone • Sellado secundario de doble vidrio de silicona  
 Aplicar vidro duplo ou triplo com bordos arestados • Aplicar vidrio doble o triple con bordos rugosos



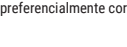

**Janela 2 folhas com soleira embutida rasa • Ventana 2 hojas con solape emprotada rasa**

**PERFIS • PERFIS**

DESENHO • DESEÑO	REF.	DESCRIÇÃO • DESCRIPCIÓN	CORTE CORTE	QUANTIDADE CANTIDAD	MEDIDAS • MEDIDA
	KL-51	Aro fixo Marco Fijo Doble		2	L
				2	H
	KL-06 *	Separador fixo Separador poliámidá central		2	L-98 mm
				2	H-98mm
	KL-04	Tampa fixa Tapeta marco		4	(L/2)-125mm
				2	H-124mm
	KL-58	Ombreira para fechos • Suplemento cierres		2	H-40mm
	AX-19	Vareta Pletina		2	H-121mm
	KL-69	Perfil tampa Embelecedor		2	H-37mm
	KL-55/RD	Perfil guia Rodamiento inferior		2	L (várias medidas)
	KL-57	Aro móvel inferior/superior Hoja inferior/superior		4	(L/2)-107mm
	KL-76	Aro móvel lateral Hoja lateral		2	H-121mm
	KL-52	Aro móvel central Hoja central con refuerzo		1	H-121mm
	KL-59	Aro móvel central Hoja central		1	H-121mm
	KL-70	Soleira Embutida Solape de unión		2	(L/2)-27mm
	KL-67	Tampa lateral Embelecedor lateral		2	(L/2)-62mm
				2	(L/2)-35mm
	KL-68	Tampa Central Embelecedor Central		2	(L/2)-35mm

\* preferencialmente cortar juntamente com o perfil KL-51 • preferiblemente cortado junto con el perfil KL-51

**ACESSÓRIOS E JUNTAS • ACCESORIOS Y JUNTAS**

REF.	DESCRIÇÃO • DESCRIPTION	QUANTIDADE CANTIDAD
30 94 64 00	Esquadro Aro Fixo • Escuadra Marco	16
30 91 01 35	Esquadro de alinhamento • Escuadra alineamiento especial	8
30 92 01 02	Goteira com válvula • Vierteaguas con deflector blanco/negro	4
30 94 64 40	Batente Lateral • Batiente lateral	4
30 94 64 17	Fecho Gravity Inox • Cierre Gravity Inox	2
30 94 61 85	Conjunto fecho Gravity • Conjunto cierre Gravity	2
30 94 61 86	Conjunto fecho microventilação Gravity • Conj. cierre microventilación Gravity	2
30 94 65 07	Conjunto ligação KL-76 • Conjunto ligación KL-76	2
30 94 65 01	Conjunto ligação KL-52/59 • Conjunto ligación KL-52/59	2
30 94 66 20	Carro Guia • Carro guía	4
30 95 60 56	Barra de latão • Bar de latón	2L
30 94 64 02	Corta-vento • Cortaviento	1
30 94 65 26	Conjunto tampas guia KL-76 • Conjunto tapas guías KL-76	1
30 94 65 19	Conjunto tampas guia embutida • Conjunto tapas guías incrustada	1
30 94 65 44	Tampa dir. KL-59 • Tapa der. KL-59	1
30 94 65 54	Tampa dir. KL-52 • Tapa der. KL-52	1
30 94 65 81	Tampa esq. embutida KL-59 • Tapa izq. incrustada KL-59	1
30 94 65 91	Tampa esq. embutida KL-52 • Tapa izq. incrustada KL-52	1
30 94 65 12	Topo guia KL-70 • Tope guía KL-70	4
30 94 64 48	Deslizador • Deslizador	8
30 94 64 51	Calço 5x20 • Calzo 5x20	8
30 94 60 73	Calço 3mm • Calzo 3mm	12
30 94 64 80	Junta Central • Junta central	2H
30 95 60 02	Junta tapa canal • Junta tapa canal	4L
---	Junta vidro exterior • Junta vidrio exterior	2L+4H
---	Junta vidro interior • Junta vidrio interior	2L+4H
30 95 00 40	Pelúcia • Burlete	4L+4H
30 95 00 30	Pelúcia • Burlete	2L
30 95 00 50	Pelúcia • Burlete	4L+2H

**VIDRO • VIDRIO**

Espessura total máxima 56mm • Espesor máximo 56mm

Hv= H-144mm	Lv= (L/2) - 83mm
-------------	------------------

Aplicar intercalar do tipo Warm Edge • Selagem secundária do vidro duplo em silicone • Sellado secundario de doble vidrio de silicona  
 Aplicar vidro duplo ou triplo com bordos arestados • Aplicar vidrio doble o triple con bordos rugosos

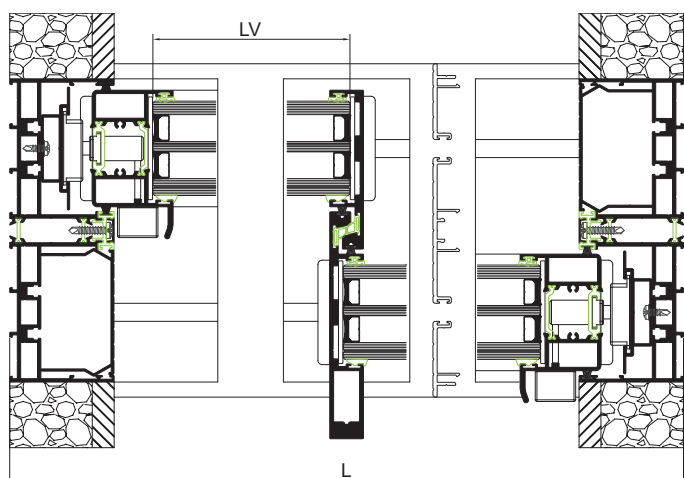



**anicolor**  
Sistemas de Aluminio

## PORTUGAL

---

ALGARVE

AVEIRO

CASTELO BRANCO

CHAVES

COIMBRA

GUARDA

LEIRIA

LISBOA

MINHO

PORTO

S.J. DA MADEIRA

UISEU

## ESPAÑA

---

CÁDIS

CORDOBA

IBIZA

JAÉN

LEÓN

MADRID

MÁLAGA

MAIORCA

MÚRCIA

OURENSE

SEVILHA

VALÈNCIA

