

[www.anicolor.pt](http://www.anicolor.pt)

## SISTEMA DE CORRER DE CONCEITO MINIMALISTA COM RPT

SISTEMA DE CORRER DE CONCEITO  
MINIMALISTA COM RPT

# Kristal



**anicolor**

Sistemas de Alumínio

## SISTEMA KRISTAL

### Sistema de correr de conceito minimalista com RPT

#### CARACTERÍSTICAS DO SISTEMA

Sistema de alumínio com rotura térmica para executar vãos de correr de conceito minimalista.

#### PERFIS DE ALUMÍNIO

Os perfis de alumínio são extrudidos na liga de alumínio 6060 para arquitetura de acordo com norma NP EN 12020-02.

Perfis com rotura térmica obtida por inserção de varetas isolantes de poliamida de 6,6 mm reforçadas com 25% de fibra de vidro de 14,6 mm nos aros fixos e de 18 mm nos aros móveis.

Espessura média dos perfis de alumínio de 2,0 mm.

#### AROS FIXOS

Secção do aro fixo perimetral de 120 mm com bi-rail para montagem a meia esquadria; Possibilidade de aplicação de remates interior ou exterior;

Perfil guia de deslizamento inferior em alumínio com rolamentos duplos de altas prestações em aço inoxidável.

#### AROS MÓVEIS

Secção dos aros móveis de vista muito reduzida de corte recto por montagem por clipagem;

Vidro duplo isolante com selagem secundária de silicone de 32,4 mm a 32,8 mm de espessura total, composto por tipologias de vidro exterior temperado ou termoendurecido e de vidro interior laminado, ou laminado temperado, com intercalar do tipo "Warm Edge";

Calha em polímero colada em todo o perímetro do vidro isolante com silicone estrutural preto;

Silicones estruturais recomendados: Dow Corning 791 preto ou Sikasil SG20 preto;

Aros móveis reforçados de linha contemporânea para elevados dimensionamentos.

#### DIMENSIONAMENTO E MANOBRABILIDADE

Dimensões mínimas - máximas de folha: 300 mm - 2300 mm (L); 500 mm - 3000 mm (H), com abertura manual;

Dimensões máximas de folha com abertura motorizada: 3000mm(L), 4000mm(H).

Peso máximo de 300 kg por folha com abertura manual e de 600Kg por folha com abertura motorizada;

Tipologias de 2, 3, 4 ou 6 folhas móveis e/ou fixas;

Possibilidade de abertura em canto;

Sistema de correr de conceito minimalista com deslizamento das folhas sobre o perfil de alumínio efectuado com rolamentos em aço inoxidável de altas prestações para uma fácil abertura do vão mesmo com configurações extremas de peso ou dimensão;

Tipologias dos vãos com mais de 95% de luminosidade;

Permeabilidade ao ar e estanqueidade à água asseguradas através de pelúcia de última geração e junta em EPDM de qualidade marítima;

Ferragem multiponto com diversos pontos de fecho e de fácil aplicação e regulação;

Ferragem multiponto com micro-ventilação incluída em todos os pontos de fecho;

Puxador específico para facilitar a manobra de abertura e de fecho do vão;

Existe a opção com fechadura para permitir a abertura do vão pelo exterior.

#### PERFORMANCES

Sistema certificado por laboratório credenciado, notificado para Ensaio Tipo Inicial (ITT) de acordo com a norma de produto EN 14351-1 para efeitos de Marcação CE.

Categorias alcançadas na avaliação do sistema Kristal tipologia janela:

1. Permeabilidade ao ar: Classe 2 (norma de ensaio EN 10207 e EN 1026)
2. Estanqueidade à água: Classe 7A (norma de ensaio EN 12208 e EN 1027)
3. Resistência ao vento: Classe C5 (norma de ensaio N 12208 e EN 12211)

Categorias alcançadas na avaliação do sistema Kristal tipologia porta:

1. Permeabilidade ao ar: Classe 3 (norma de ensaio EN 10207 e EN 1026)
2. Estanqueidade à água: Classe 6A (norma de ensaio EN 12208 e EN 1027)
3. Resistência ao vento: Classe C2 (norma de ensaio N 12210 e EN 12211)
4. Permeabilidade ao ar em Micro-ventilação: Classe 1 (norma de ensaio EN 1026)

Categorias alcançadas na avaliação do sistema KRISTAL para determinação das forças de manobra (EN 12046):

1. Libertação da ferragem de fecho: Classe 2
2. Abertura da folha: Classe 1
3. Fecho da folha: Classe 1
4. Engate da ferragem de fecho: Classe 2

Categoria alcançada na determinação da resistência a abertura e fecho repetidos (5000 ciclos): Classe 1 (EN 1191)

Coefficiente de transmissão térmica de vão de 2 folhas com 5,0 m x 3,0 m com vidro Ug = 1,0 W/m<sup>2</sup>K, com intercalar efeito "Warm Edge": Uw = 1,29 W/m<sup>2</sup>K

Coefficiente de atenuação acústica de vão de 2 folhas com vidro acústico 8/16/44,1: Rw (C; Ctr) = 38 dB (-1; -5)

Zonas de aplicação segundo RCCTE (em função do valor Ug): I1, I2, I3, V1, V2, V3.

## SISTEMA KRISTAL

### Sistema de corredera de conceito minimalista con RPT

#### CARACTERÍSTICAS DEL SISTEMA

Sistema de aluminio con rotura de puente térmico para ejecutar vanos correderos con un concepto minimalista.

#### PERFILES DE ALUMINIO

Los perfiles de aluminio están extrudidos en la aleación de aluminio 6060 para arquitectura según la norma NP EN 12020-02.

Perfiles con rotura de puente térmico obtenidos mediante la inserción de varillas aislantes de poliamida de 6,6 mm reforzadas con un 25% de fibra de vidrio de 14,6 mm en los marcos fijos y 18 mm en los marcos móviles.

Espesor medio de perfiles de aluminio de 2,0 mm.

#### MARCOS

Sección de marco perimetral fijo de 120 mm con bi-rail para montaje en inglete;

Posibilidad de aplicar molduras interiores o exteriores;

Perfil guía deslizante inferior de aluminio con rodamientos dobles de alto rendimiento en acero inoxidable.

#### HOJAS

Sección de las hojas de vista muy reducida de corte recto por montaje por clipaje;

Vidrio doble aislante con sellado secundario de silicona de 32,4 mm a 32,8 mm de espesor total, compuesto por tipos de vidrio exterior templado o termoendurecible y vidrio interior laminado o laminado templado, con intercalar del tipo "Warm Edge".

Canaleta de polímero pegada alrededor del perímetro del vidrio aislante con silicona estructural negra;

Siliconas estructurales recomendadas: Dow Corning 791 black o Sikasil SG20 black;

Hojas reforzadas de línea contemporánea para grandes dimensiones.

#### DIMENSIONAMIENTO Y MANIOBRABILIDAD

Dimensiones mínimas - hojas máximas: 300 mm - 2300 mm (W); 500 mm - 3000 mm (alto) con apertura manual;

Dimensiones máximas de hoja con apertura motorizada: 3000mm(L), 4000mm(H)

Peso máximo de 300 kg por hoja con apertura manual y 600 kg por hoja con apertura motorizada;

Tipologías de 2, 3, 4 o 6 hojas móviles y / o fijas;

Posibilidad de apertura en esquina;

Sistema de deslizamiento de concepto minimalista con láminas deslizantes sobre el perfil de aluminio fabricado con cojinetes de acero inoxidable de alto rendimiento para facilitar la apertura del vano incluso con configuraciones extremas de peso o dimensión;

Tipologías de vanos con más del 95% de brillo;

Permeabilidad al aire y estanqueidad asegurada mediante felpa de última generación y se une en EPDM de calidad marina;

Herrajes multipunto con varios puntos de cierre y de fácil aplicación y ajuste;

Herrajes multipunto con microventilación incluidos en todos los puntos de cierre;

Asa específica para facilitar la apertura y cierre del tramo;

Existe la opción con cierre para permitir la apertura del hueco desde el exterior.

#### EMSAYOS

Sistema certificado por laboratorio notificado credenciado, para pruebas de tipo inicial (ITT) de acuerdo con la norma de producto EN 14351-1 a los efectos del marcado CE.

Categorías logradas en la evaluación del sistema de ventanas de tipologia Kristal:

1. Permeabilidad al aire: Clase 2 (norma de prueba EN 10207 y EN 1026)
2. Estanqueidad al agua: Clase 7A (prueba estándar EN 12208 y EN 1027)
3. Resistencia al viento: Clase C5 (prueba estándar N 12208 y EN 12211)

Categorías logradas en la evaluación del sistema de tipologia de puertas Kristal:

1. Permeabilidad al aire: Clase 3 (norma de prueba EN 10207 y EN 1026)
2. Estanqueidad al agua: Clase 6A (prueba estándar EN 12208 y EN 1027)
3. Resistencia al viento: Clase C2 (prueba estándar N 12210 y EN 12211)
4. Permeabilidad al aire por microventilación: Clase 1 (norma de prueba EN 1026)

Categorías logradas en la evaluación del sistema KRISTAL para la determinación de las fuerzas de manobra (EN 12046):

1. Liberación del hardware de cierre: Clase 2
2. Apertura de papel: Clase 1
3. Cierre de hoja: Clase 1
4. Cierre de conexión de hardware: Clase 2

Categoría alcanzada en la determinación de la resistencia a la apertura y cierre repetidos (5000 ciclos): Clase 1 (EN 1191)

Coefficiente de transmisión térmica de luz de 2 hojas con 5,0 m x 3,0 m con vidrio Ug = 1,0 W / m<sup>2</sup>K, con efecto intercalario "Warm Edge": Uw = 1,29 W / m<sup>2</sup>K

Coefficiente de atenuación acústica de un tramo de 2 hojas con vidrio acústico 8/16 / 44,1: Rw (C; Ctr) = 38 dB (-1; -5)

Campos de aplicación según RCCTE (en función del valor Ug): I1, I2, I3, V1, V2, V3.

## SISTEMA KRISTAL PIVOTANTE

### Sistema pivotante de conceito minimalista com RPT

#### CARACTERÍSTICAS DO SISTEMA

Sistema de alumínio com rotura térmica para executar vãos porta pedonal pivotante vertical Minimalista.

#### PERFIS DE ALUMÍNIO

Os perfis de alumínio são extrudidos nas ligas de alumínio 6060/6063 para arquitetura de acordo com norma NP EN 12020-02.

Os perfis com rotura térmica são obtidos por inserção de varetas de poliamida 6.6 reforçadas com 25% de fibra de vidro.

Espessura média dos perfis de alumínio de 2mm;

#### AROS FIXOS

Secção do aro fixo perimetral de 120mm para montagem a meia esquadria;

Possibilidade de aplicação de remates interior ou exterior;

Perfil de grelha para drenagem inferior;

Drenagem oculta;

#### AROS MÓVEIS

Secção dos aros móveis de vista muito reduzida de corte recto com montagem por clipagem;

Vidro duplo isolante com selagem secundária de silicone desde 32.4mm até 32.8mm de espessura total composto por tipologias de vidro exterior temperado ou termo-endurecido e de vidro interior laminado ou laminado-temperado;

Calha em polímero colada em todo o perímetro do vidro isolante com silicone estrutural preto;

Silicones estruturais recomendados:

silicone estrutural Dow Corning 791 preto ou

silicone estrutural Sikasil SG20 preto;

#### DIMENSIONAMENTO E MANIOBRABILIDADE

Dimensões mínimas - máximas Largura de folha 800mm - 2000mm ;

Dimensões mínimas Altura de folha 1700mm ;

Área máxima da folha: 7m<sup>2</sup>;

Peso máximo de 300Kg por folha ;

Tipologias de Porta 1, 2, 3 ou 4 folhas Pivotante de eixo vertical de abertura interior ou exterior ;

Possibilidade de conjugação com o Sistema Kristal - Correr;

Sistema KRISTAL - Pivotante para uma fácil abertura do vão mesmo com configurações extremas de peso ou de dimensões ;

Tipologias dos vãos com mais de 95% de luminosidade ;

Permeabilidade ao ar e Estanqueidade à água asseguradas através de pelúcias e junta em EPDM de qualidade marítima ;

Possibilidade de aplicação de Fechadura Mecânica ou Electromecânica ;

#### PERFORMANCES

Sistema com certificação em laboratório notificado segundo ensaio tipo inicial (ITT) de acordo com a norma de produto EN 14351-1:2008+A1:2011 para efeitos de Marcação CE.

Categorias previstas na avaliação do sistema KRISTAL tipologia porta:

1. Permeabilidade ao ar: Classe 3 (normas de ensaio EN 10207 e EN 1026)

2. Estanqueidade à água: Classe 5B (normas de ensaio EN 12208 e EN 1027)

3. Resistência ao vento: Classe A2 (normas de ensaio EN 12210 e EN 12211)

Coefficiente de transmissão térmica de vão de 1 folha Pivotante com 2.0m x 3m com vidro de valor  $U_g = 0.9 \text{ W/m}^2\text{K}$  com intercalar efeito "Warm Edge":

·  $U_w = 1.16 \text{ W/m}^2\text{K}$

Coefficiente de atenuação acústica de vão de 1 folha Pivotante com vidro acústico 8 / 16 / 44.2

·  $R_w = 38 \text{ dB} (-2, -4)$

Zonas de aplicação segundo os regulamentos REH e RECS (em função do valor  $U_g$ ): I1, I2, I3, V1, V2, V3;

## SISTEMA KRISTAL PIVOTANTE

### Sistema pivotante de concepto minimalista con RPT

#### CARACTERÍSTICAS DEL SISTEMA

Sistema de aluminio con rotura de puente térmico para ejecutar huecos de puerta peatonal pivotante minimalista vertical.

#### PERFILES DE ALUMINIO

Los perfiles de aluminio están extrudidos en aleaciones de aluminio 6060/6063 para arquitectura de acuerdo con la norma NP EN 12020-02.

Los perfiles de rotura de puente térmico se obtienen mediante la inserción de varillas de poliamida 6.6 reforzadas con un 25% de fibra de vidrio.

Espesor medio de perfiles de aluminio de 2 mm;

#### MARCOS

Sección de marcos de 120 mm de perímetro para montaje de media esquadra;

Possibilidade de aplicar molduras interiores o exteriores;

Perfil de parrilla para drenaje inferior;

Drenaje oculto;

#### HOJAS

Sección de las hojas de vista muy reducida de corte recto con montaje por clipaje;

Vidrio doble aislante con sellado secundario de silicona de 32,4 mm a 32,8 mm

de espesor total compuesto por tipos de vidrio exterior templado o

vidrio interior termoendurecido y laminado o laminado templado;

Canaleta de polímero pegada alrededor del perímetro del vidrio aislante con silicona estructural negra;

Siliconas estructurales recomendadas:

silicona estructural Dow Corning 791 negra o

silicona estructural Sikasil SG20 negra;

#### DIMENSIONAMIENTO Y MANIOBRABILIDAD

Dimensiones mínimas - máximas Ancho de la hoja 800 mm - 2000 mm;

Dimensiones mínimas Altura de la hoja 1700 mm;

Área máxima de hojas: 7m<sup>2</sup>;

Peso máximo de 300Kg por hoja;

Tipologías de Puerta 1, 2, 3 o 4 hojas Eje vertical pivotante de apertura interior o exterior;

Possibilidade de conjugación con Kristal - Sistema de corredera;

Sistema KRISTAL: pivotante para facilitar la apertura de la misma abertura con configuraciones extremas de peso o dimensión;

Tipologías de huecos con más del 95% de iluminación;

Permeabilidad al aire y estanqueidad asegurada por felpa y junta en EPDM de calidad marina;

Possibilidade de aplicar Cerradura Mecánica o Electromecánica;

#### ENSAYOS

Sistema certificado en un laboratorio notificado según la prueba de tipo inicial (ITT) según la norma de producto EN 14351-1: 2008 + A1: 2011 a efectos del Marcado CE.

Categorías previstas en la evaluación del sistema de tipología de puertas KRISTAL:

1. Permeabilidad al aire: Clase 3 (normas de prueba EN 10207 y EN 1026)

2. Estanqueidad al agua: Clase 5B (normas de ensayo EN 12208 y EN 1027)

3. Resistencia al viento: Clase A2 (normas de prueba EN 12210 y EN 12211)

Coefficiente de transmisión térmica de un hueco de 1 pivote con 2,0 mx 3 m con vidrio de valor  $U_g = 0,9 \text{ W/m}^2\text{K}$  con efecto intermedio "Borde cálido":

$U_w = 1,16 \text{ W/m}^2\text{K}$

Coefficiente de atenuación acústica del tramo de 1 hoja Pivotante con vidrio acústico 8/16 / 44,2

·  $R_w = 38 \text{ dB} (-2, -4)$

Campos de aplicación según normativa REH y RECS (según valor  $U_g$ ): I1, I2, I3, V1, V2, V3;

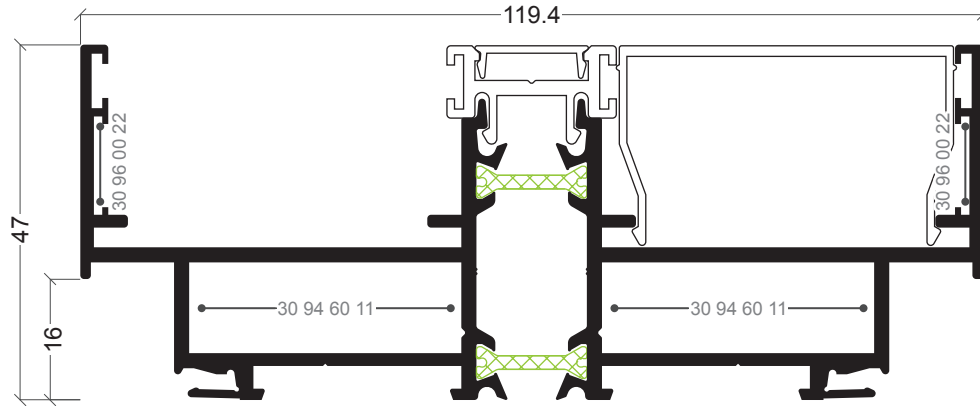

**KL-01**

Aro fixo perimetral  
Marco Perimetral

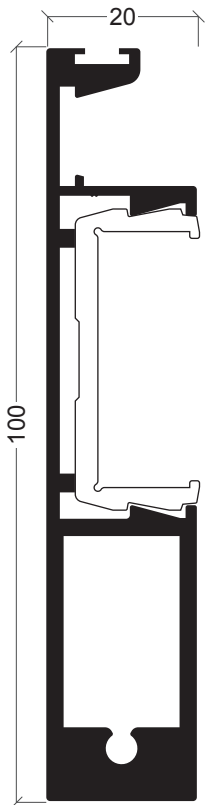

**KL-02**

Aro móvel central reforçado  
Hoja central reforzada

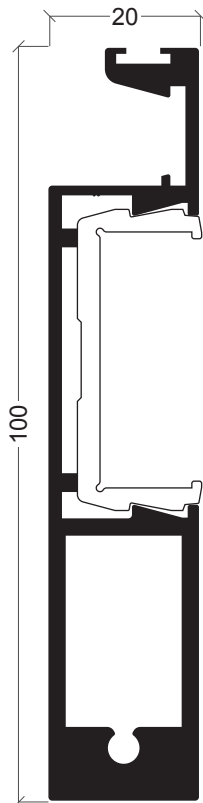

**KL-12**

Aro móvel central reforçado 3/4 folhas  
Hoja central reforzada 3/4 folhas

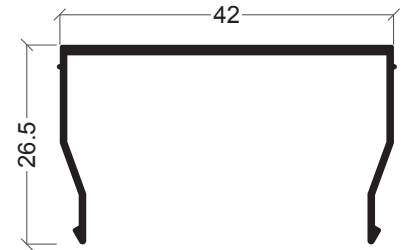

**KL-13**

Perfil tampa  
Perfil de tapa

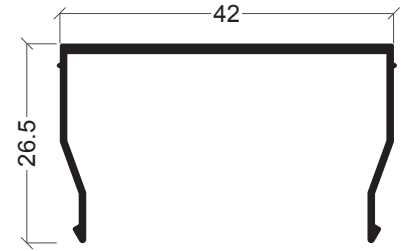

**KL-13/R**

Tampa c/ furação para pivotante  
Tapa c/ furaçión para pivotante

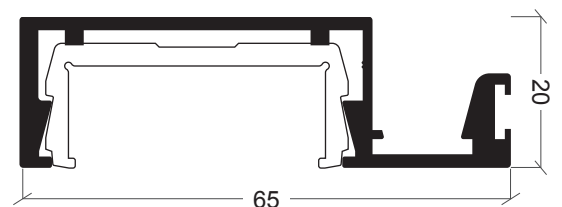

**KL-17**

Aro móvel central 3/4 folhas  
Hoja central 3/4 folhas



**KL-06**

Perfil polímero central  
Perfil polímero central

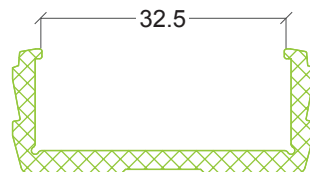

**KL-07**

Perfil polímero para vidro  
Perfil polímero para vidro

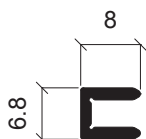

**S-17**

Perfil união  
Perfil unión

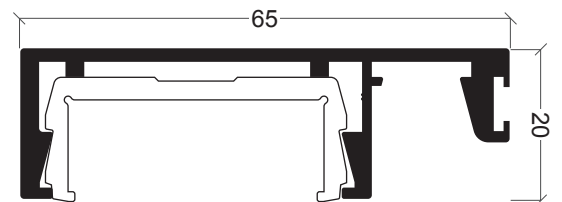

**KL-09**

Aro móvel central  
Hoja central

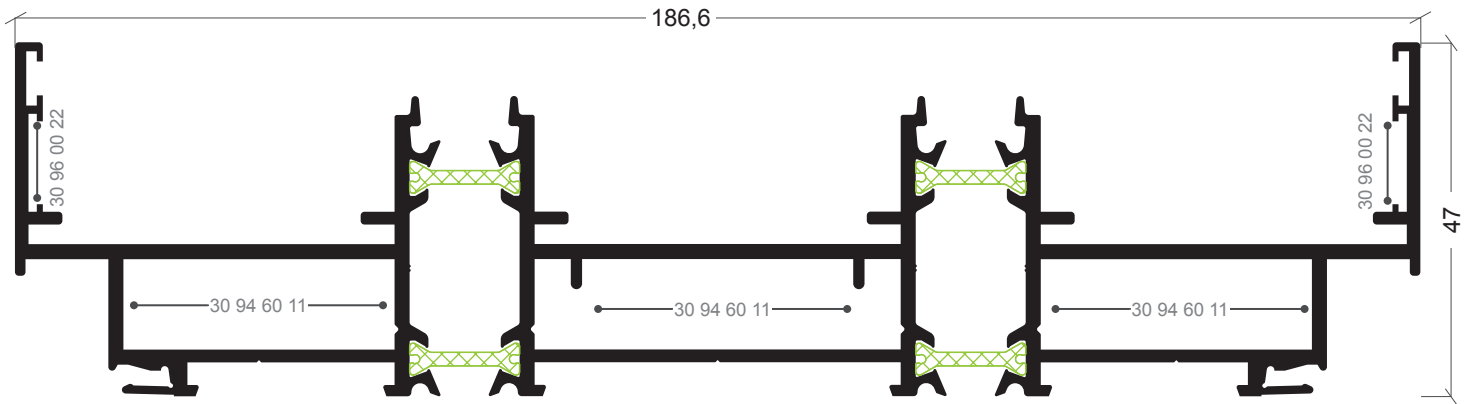

**KL-25**

Aro fixo perimetral tri-rail  
Marco perimetral tri-rail

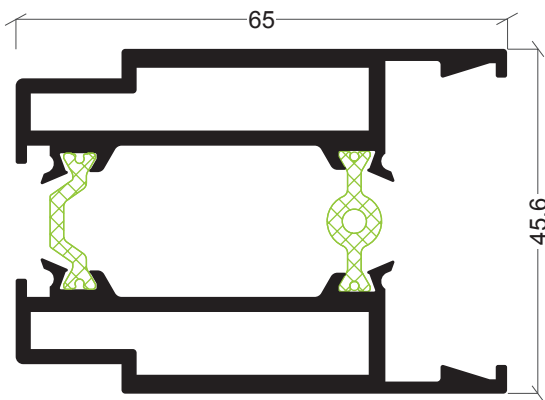

**KL-24**

Aro móvel para fechadura  
Hoja para cerradura

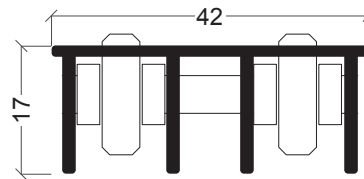

**KL-05/RD**

Perfil guia para folha peso <200Kg  
Acetinado 1AC  
Acetinado 2AC  
Lacado 9005 MT  
Perfil guia para folha <200Kg  
Acetinado 1AC  
Acetinado 2AC  
Lacado 9005 MT

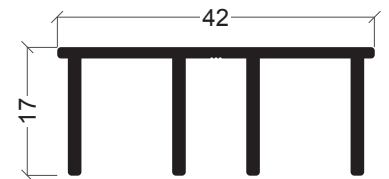

**KL-05**

Perfil suporte para folha fixa  
Perfil de soporte para marco

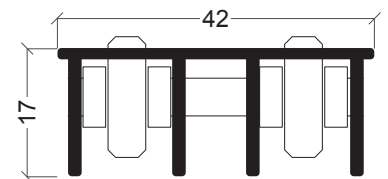

**KL-14/RD**

Perfil guia para folha peso >=200Kg  
Acetinado 1AC  
Acetinado 2AC  
Lacado 9005 MT  
Perfil guia para folha >=200Kg  
Acetinado 1AC  
Acetinado 2AC  
Lacado 9005 MT

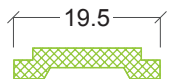

**KL-08**

Vareta de poliamida  
Varilla de poliamida



**KL-04**

Tampa  
Tope

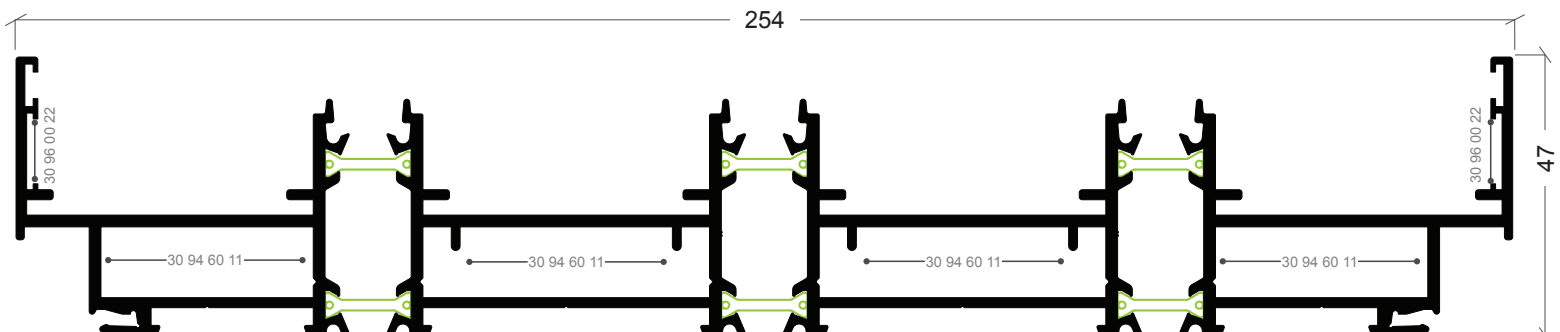

**KL-35**

Aro fixo perimetral quadri-rail  
Marco perimetral de cuatro raíles

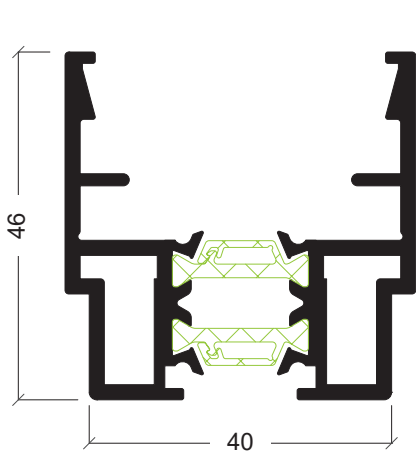

**KL-03/BI**

Aro móvel Anti Bi-Metal  
Hoja Anti Bi-Metal

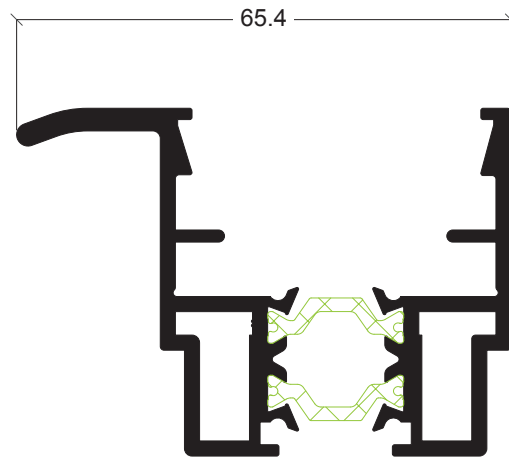

**KL-26**

Aro móvel  
Hoja

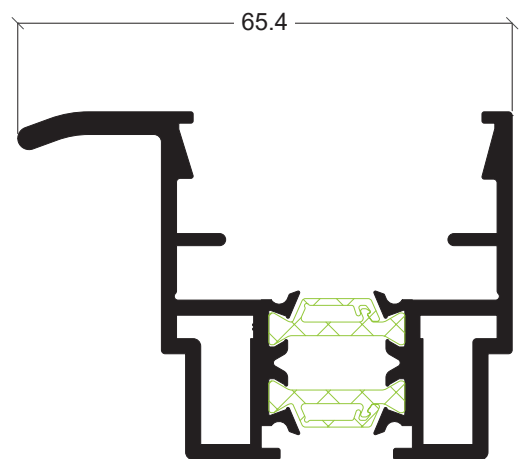

**KL-26/BI**

Aro móvel Anti Bi-Metal  
Hoja Anti Bi-Metal

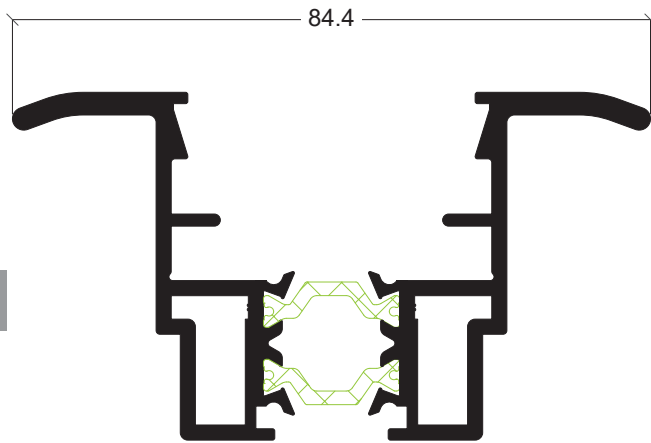

**KL-27**

Aro móvel  
Hoja

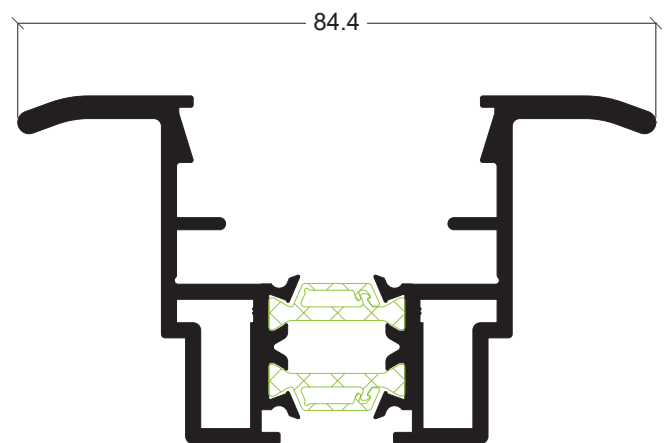

**KL-27/BI**

Aro móvel Anti Bi-Metal  
Hoja Anti Bi-Metal

376

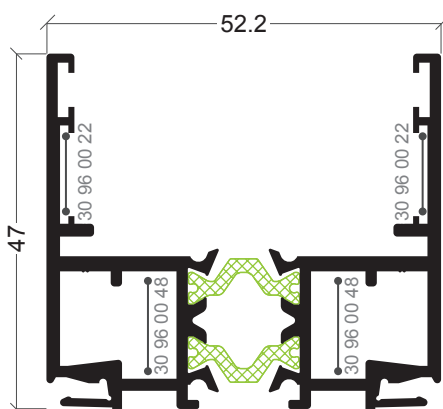

**KL-10**

Perfil mono-rail e 3º rail  
Perfil monocarril y tricarril

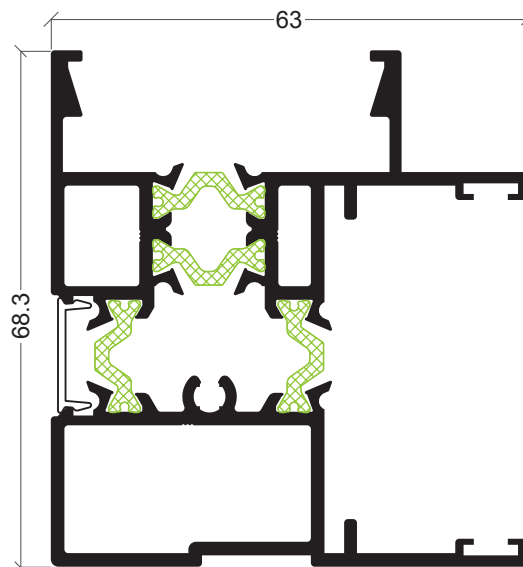

**KL-11**

Perfil canto  
Perfil canto

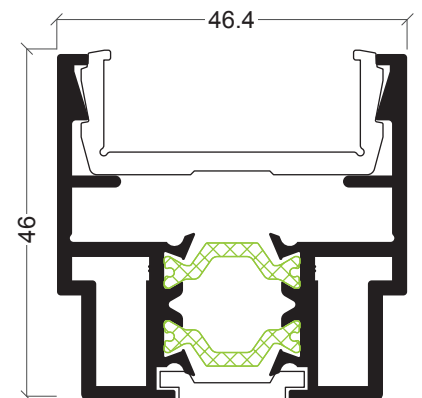

**KL-03**

Aro móvel lateral  
Hoja lateral

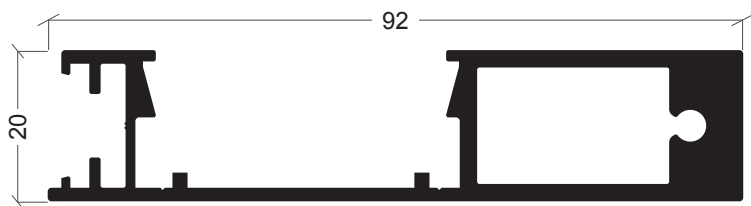

**KL-20**

Aro móvel central pivotante  
Hoja central pivotante

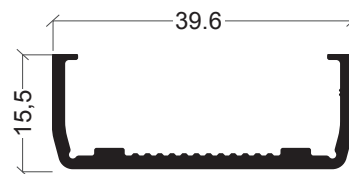

**KL-18**

Aro móvel lateral  
Hoja lateral

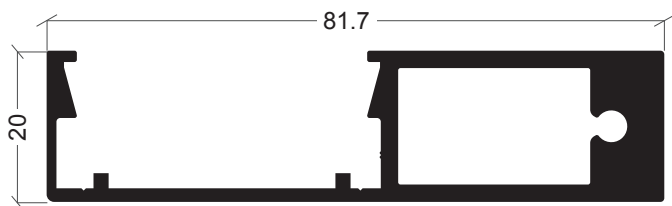

**KL-21**

Aro móvel lateral pivotante  
Hoja lateral pivotante

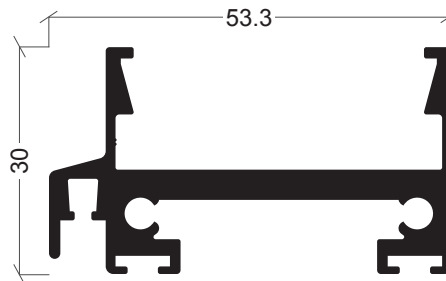

**KL-19**

Aro móvel inferior pivotante  
Hoja inferior pivotante

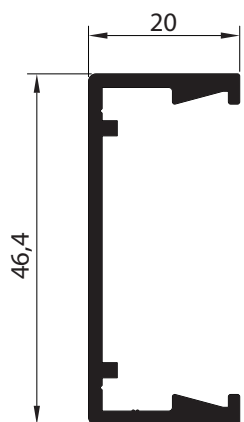

**KL-28**

Aro móvel lateral pivotante  
Hoja lateral pivotante

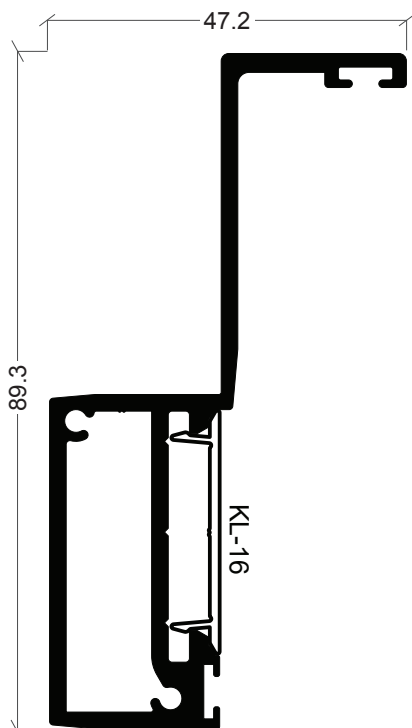

**KL-23**

Batente exterior pivotante  
Batiante exterior pivotante

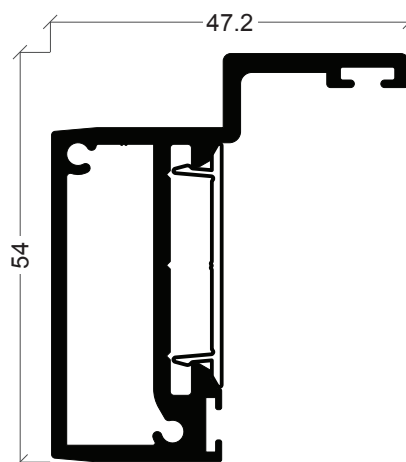

**KL-22**

Batente lateral pivotante  
Batiante exterior pivotante

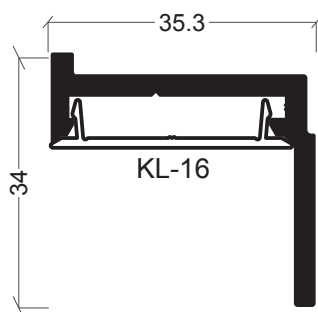

**KL-15**

Puxador  
Manilla

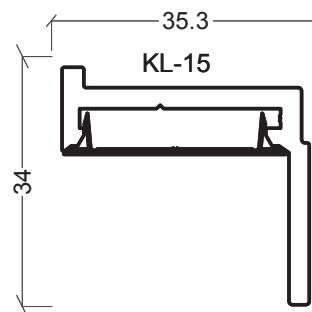

**KL-16**

Tampa para KL-15  
Tapa para KL-15

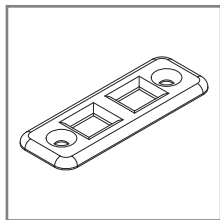

**30 24 30 75**

Contra-fecho inox aplicar com fechos lisos  
Contra cierre doble inferior inox

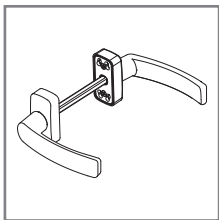

**30 60 16 50/51/52**

Puxador duplo de alumínio branco/preto/2AC  
Manilla doble de aluminio blanco/negro/2AC

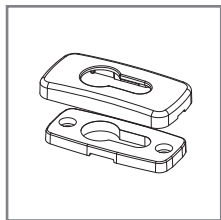

**30 60 16 55/56/57**

Escudo de alumínio branco/preto/2AC  
Espejo de aluminio blanco/negro/2AC

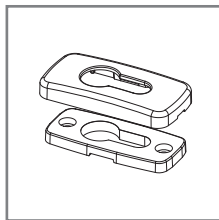

**30 60 16 58/59**

Escudo de alumínio champ ac/inox ac  
Espejo de aluminio champ ac/inox ac

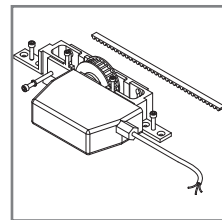

**30 90 90 00**

Motor(1000 Newton)  
Motor(1000 Newton)

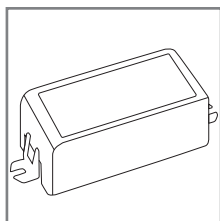

**30 90 90 01**

Transformador de corrente 230V-24V dc  
Transformador 230 AC-24 Vdc

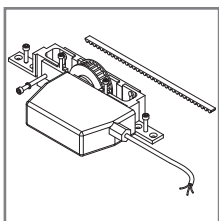

**30 90 90 02**

Motor(1500 Newton)  
Motor(1500 Newton)

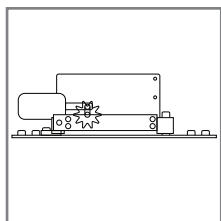

**30 90 90 03**

Motor Kristal p/ ligações doméstica  
Motor Kristal p/ ligaci3ns dom3stica

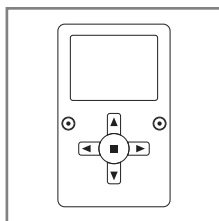

**30 90 90 04**

Comando para programação  
Comando para programaci3n

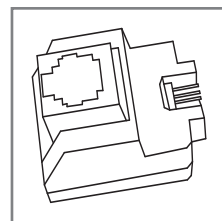

**30 90 90 05**

Modulo de ligaç3o para WIFI e programaç3o  
Modulo de ligaci3n para WIFI e programaci3n

378

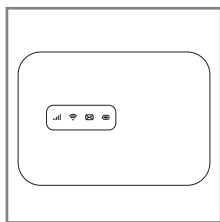

**30 90 90 06**

Modulo WIFI  
Modulo WIFI

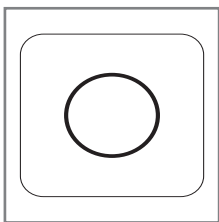

**30 90 90 07**

Interruptor CLEAN c/fonte 12V  
Interruptor CLEAN c/fonte 12V

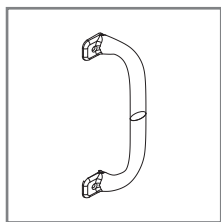

**30 91 41 77/78**

Puxador p/fecho emb. clip (Branco/Preto)  
Manilla p/cierre emb. clip( blanco/negro)

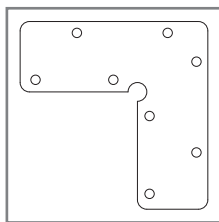

**30 92 01 35**

Esquadro alinhamento AXI-73/80/83/88  
Escuadro alineamiento interior hoja

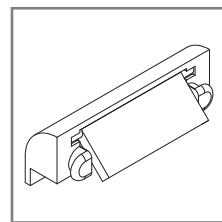

**30 92 01 02/03**

Goteira com válvula (preto/branco)  
Vierteaguas con deflector blanco/negro

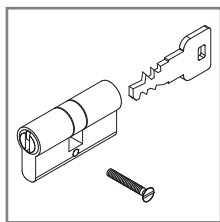

**30 93 02 45**

Canhão  
Bombillo

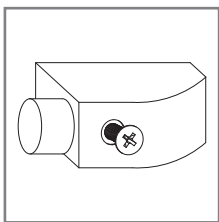

**30 94 50 20**

Limitador de abertura  
Limitador apertura

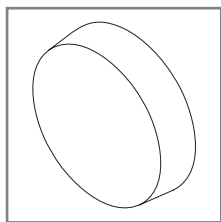

**30 94 50 36**

Tampa preta para parafuso cabeça de queijo 9.3  
Tapa negra para tornillo

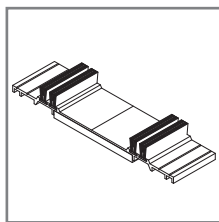

**30 94 50 41**

Cortaventos Superior/ Inferior  
Cortaviento Superior/Inferior

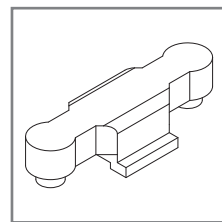

**30 94 60 02**

União varetas zamack preto alternativa  
Union varillas zamack negro

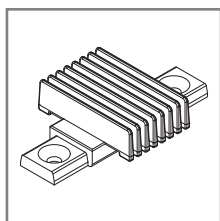

**30 94 60 03**

Corta-vento Kristal preto  
Cortaviento kristal negro

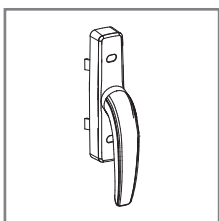

**30 94 60 04/05**

Cremona exterior lacado (branco/preto)  
Cremona exterior lac blanco

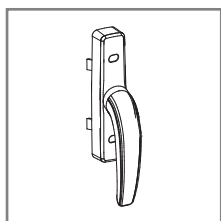

**30 94 60 06**

Cremona exterior lacado (cinza 9006)  
Cremona exterior lac Gris (9006)

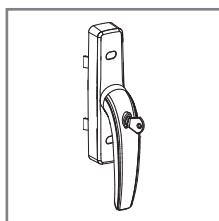

**30 94 60 08/09**

Cremona exterior c/ chave lacado (branco/preto)  
Cremona exterior con llave lac blanco/negro

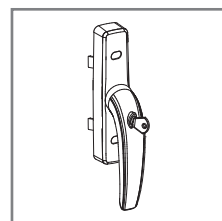

**30 94 60 10**

Cremona exterior lacado c/ chave (cinza 9006)  
Cremona exterior con llave lac Gris (9006)



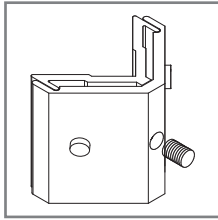

**30 94 60 11**

Esquadro 36x12 mm centrado KL-01  
Escuadra 36x12mm centrada KL-01

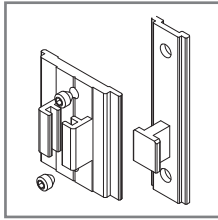

**30 94 60 14**

Conjunto fecho preto  
Conjunto cierre Kristal negro

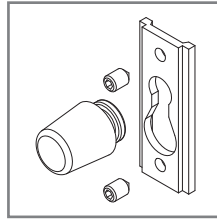

**30 94 60 15**

Batente preto KL-03  
Batiente negro KL-03

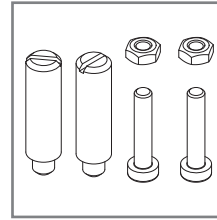

**30 94 60 16**

Suplemento para fecho fixação cremone exterior  
Suplemento para cierre

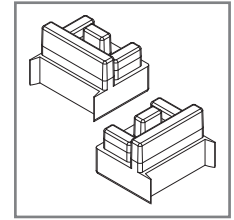

**30 94 60 17**

Conjunto topo lateral preto KL-03  
Conjunto tope lateral negro

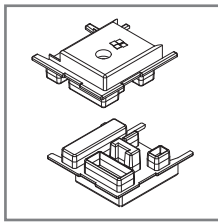

**30 94 60 18**

Conjunto topo canto preto KL-11  
Conjunto tope canto negro

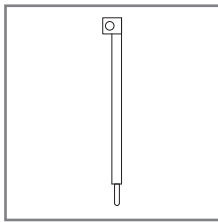

**30 94 60 19/21**

Fecho liso interior 450 mm (branco/preto)  
Cierre liso interior 450mm blanco/negro

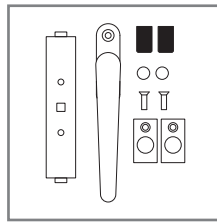

**30 94 60 20/22**

Conjunto puxadores para 3F/4F ou central  
Conj. manillas ¾ hojas + central blanco/negro

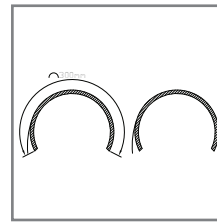

**30 94 60 23**

Kit Espumas EPDM autoadesivas (par)  
Kit Espuma EPDM

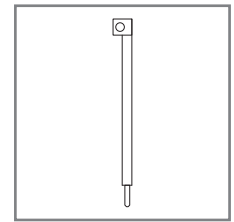

**30 94 60 25/26**

Fecho liso interior 700 mm (branco/preto)  
Cierre liso interior 700 mm (blanco/negro)

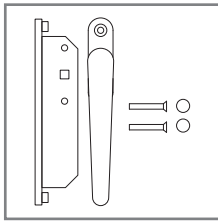

**30 94 60 28/29**

Puxador lateral baixo (branco/preto)  
Conj. manilla lateral hoja blanco/negro

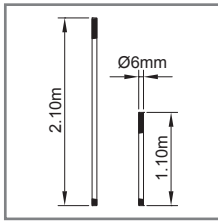

**30 94 60 31**

Conjunto varão alumínio 3000 mm  
Conj. varilla aluminio 3mts

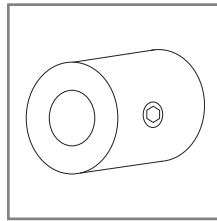

**30 94 60 32**

Guiador para varão por cada 500 mm  
Guiador Varilla

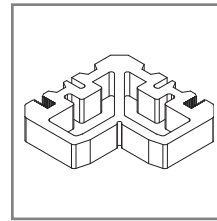

**30 94 60 33**

Esquadro para canto 90°  
Escuadra ângulo Kristal 11.7x36

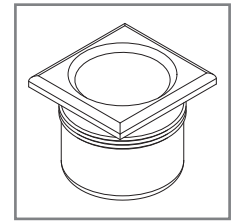

**30 94 60 34**

Contra-fecho central para puxador 3/4 F  
+ central (preto)  
Contracierre central negro

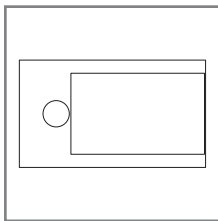

**30 94 60 35**

Topo para KL-02 / KL-12 preto  
Topo para refuerzo KL-02/12 negro

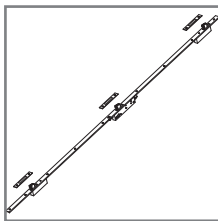

**30 94 60 36**

Fechadura 3 pontos sem canhão para correr  
Cierre Kristal 3 puntos sin bombillo para corredera

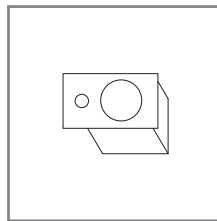

**30 94 60 37**

Topo p/fechos central Kristal preto  
Topo p/cierres central Kristal negro

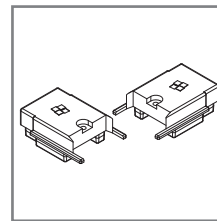

**30 94 60 38**

Conjunto Topos laterais KL-24 preto  
Conjunto topes laterais KL-24 negro

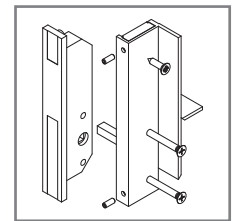

**30 94 60 40/41/42/43**

Conjunto fecho minimal direito  
branco/preto/natural/inox ac  
Conj. cierre minimal Kristal der.  
Lac negro/Anod Nat/ Inox Anod.

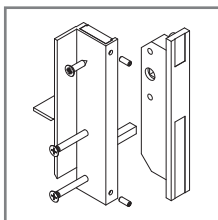

**30 94 60 44/45/46/47**

Conjunto fecho minimal Kristal esquerdo  
branco/preto/natural/inox ac  
Conj. cierre minimal Kristal izq.  
Lac negro/Anod Nat/ Inox Anod.

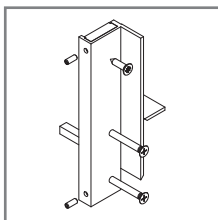

**30 94 60 48/49/50/51**

Fecho minimal direito  
branco/preto/natural/inox ac  
Cierre minimal Kristal derecho blanco/negro/  
derecho Anod. Natural/derecho Inox natural

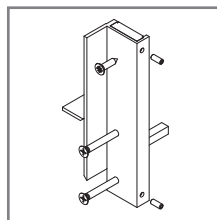

**30 94 60 52/53/54/55**

Fecho minimal esquerdo  
branco/preto/natural/inox ac  
Cierre Minimal Kristal Izquierdo blanco/lac negro  
/ Anod nat / inox anod.

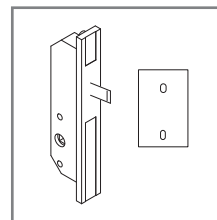

**30 94 60 60**

Transmissão com calço para falsa manobra  
Trasmision c/ cuña p/ falsa manobra Kristal

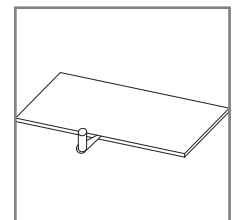

**30 94 60 62**

Calço 1mm Kristal Ultra-minimalista  
Calço 1mm Ultra minimalista

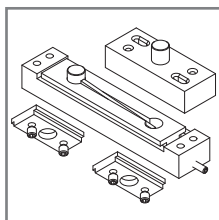

**30 94 60 65**

Kit Kristal pivotante  
Kit kristal pivotante

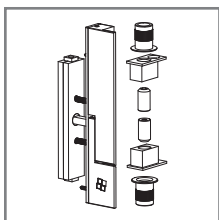

**30 94 60 70/71**

Conj. fecho pivotante direito branco/preto  
Conj. cierre Kristal pivotante der. Negro/blanco

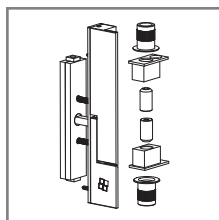

**30 94 60 72/73**

Conj. fecho pivotante direito natural/inox ac  
Conj. cierre Kristal pivotante Der. Ac. Natural/Inox

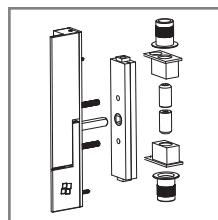

**30 94 60 75/76**

Conj. fecho pivotante esquerdo branco/preto  
Conj. cierre pivotante Izquierdo blanco/negro

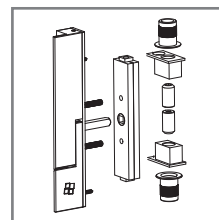

**30 94 60 77/78**

Conj. fecho pivotante esquerdo natural/inox  
Conj. cierre pivotante Izquierdo natural/inox

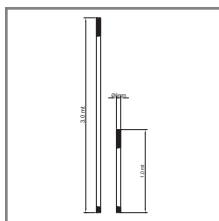

**30 94 60 80**

Conjunto varão inox roscado (4m)  
Conjunto varilla roscada inox(4 m)

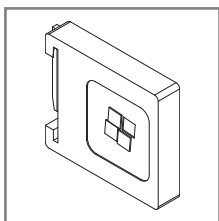

**30 94 60 81/82/83/84**

Fecho lateral pivotante  
branco/preto/natural/inox ac  
Conjunto cierre Kristal pivotante negro/blanco/  
natural/inox

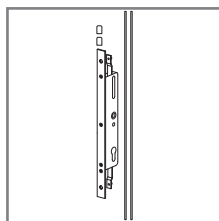

**30 94 60 90**

Fechadura pivotante  
Cierre pivotante

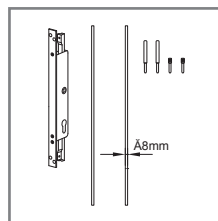

**30 94 60 91**

Fechadura Kristal Pivotante (H-2400)  
Cierre Kristal Pivotante

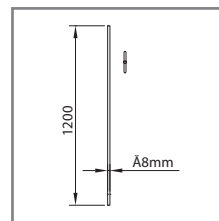

**30 94 60 92**

Vareta suplementar p/fechad.  
Varilla adicional p/cerradura

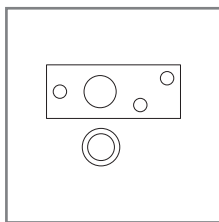

**30 94 60 93**

Ponto de Fecho para fechad.  
Punto de Cierre para cerradura

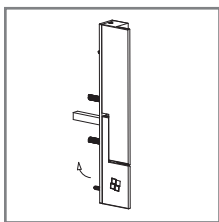

**30 94 60 97/98**

Fecho Minimalista Direito Branco/Preto  
Cierre Minimalista Derecho Blanco/Negro

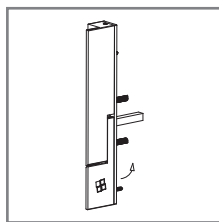

**30 94 60 99/100**

Fecho Minimalista Esquerdo Branco/Preto  
Cierre Minimalista Izquierdo Blanco/Negro

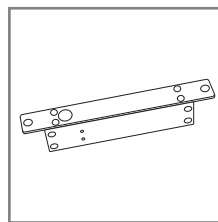

**30 94 61 10**

Fechadura Electrica de pistão 12V  
Cierre Electrica 12V

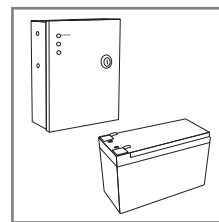

**30 94 61 20**

Fonte de alimentação com UPS  
Fuente de alimentación con UPS



**30 94 61 30**

Controlo de Acesso  
Control de Acceso

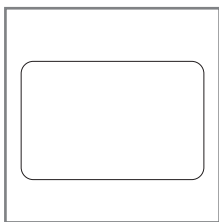

**30 94 61 38**

Cartão para controlo de acesso  
Tarjeta de control de acceso

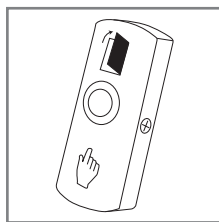

**30 94 61 40**

Interruptor Interior  
Interruptor Interior

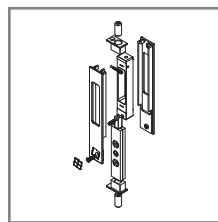

**30 94 61 45/46/47**

Fecho Puxador central Kristal branco/preto/  
natural  
Cierre manilla central Kristal blanco/negro/  
natural

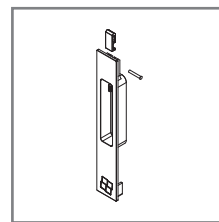

**30 94 61 48/49/50**

Puxador cego central Kristal Pivotante branco/  
preto/natural  
Manilla ciega central Kristal Pivotante blanca/  
negra/natural

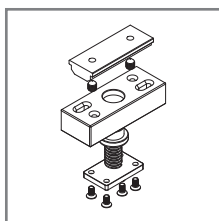

**30 94 61 51/52/53**

Mola chão Kristal pivotante (branco/lac. preto/2AC)  
Mola tierra Kristal pivotante( blanco/negro/2AC)

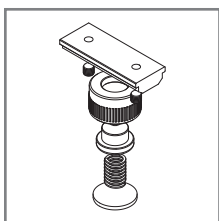

**30 94 61 54/55/56**

Mola chão p/chumbar Kristal Pivotante  
(branco/lac. preto/2AC)  
Mola tierra p/chumbar Kristal Pivotante  
(branco/lac. negro/2AC)

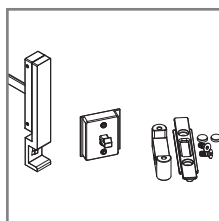

**30 94 61 70/71/72**

Fecho Gravity Kristal (branco/lac.preto/2AC)  
Cierre Gravity Kristal (branco/lac.negro/2AC)

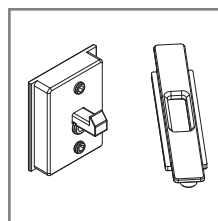

**30 94 61 75**

Conjunto ponto de fecho Gravity  
Conjunto punto de cierre Gravity

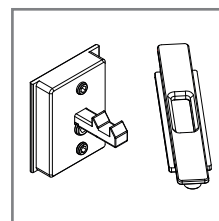

**30 94 61 76**

Conjunto Micro-ventilação Gravity Kristal  
Conjunto micro-ventilación Gravity Kristal

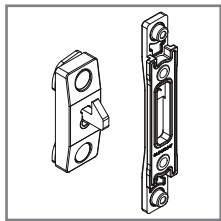

**30 94 61 77**

Conj. ponto de fecho central Gravity  
Conjunto punto de cierre central Gravity

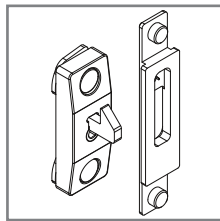

**30 94 61 78**

Conj. ponto de fecho central Gravity Inox  
Conjunto punto de cierre central Gravity Inox

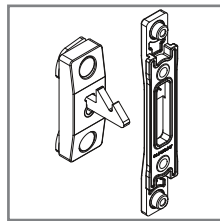

**30 94 61 87**

Conj. micro-ventilação Central Gravity  
Conjunto micro-ventilación central Gravity

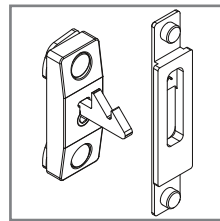

**30 94 61 88**

Conj. micro-ventilação Central Gravity Inox  
Conjunto micro-ventilación central Gravity  
Inox

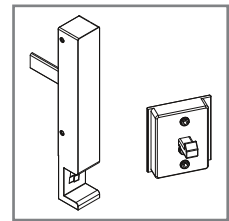

**30 94 62 00/01/02**

Fecho Gravity manual Kristal Branco/  
Preto/2AC  
Cierre Gravity manual Kristal blanco/negro/  
natural

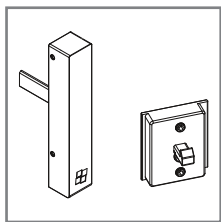

**30 94 62 05/06/07**

Fecho Gravity s/aba manual Kristal Branco/  
Preto/2AC  
Cierre Gravity sin aba manual Kristal blanco/  
negro/natural

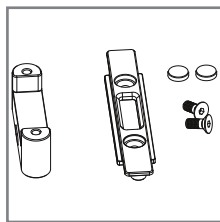

**30 94 62 10/11/12**

Fecho Gravity manual Inox Kristal Branco/  
Preto/2AC  
Cierre Gravity manual Inox Kristal blanco/  
negro/natural

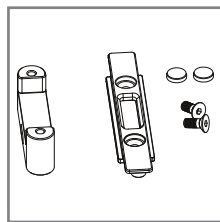

**30 94 62 15/16/17**

Fecho Gravity s/aba manual Inox Kristal  
Branco/Preto/2AC  
Cierre Gravity sin aba manual Inox Kristal  
blanco/negro/natural

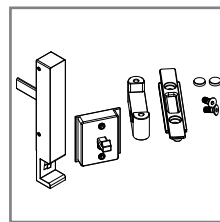

**30 94 61 80/81/82**

Fecho Gravity Kristal Inox branco/preto/natural  
Cierre Gravity Kristal Inox blanco/negro/natural

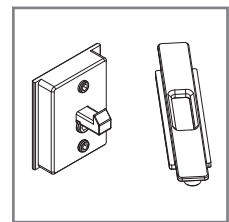

**30 94 61 85**

Conjunto ponto de fecho Gravity Inox  
Conjunto punto de cierre Gravity Inox

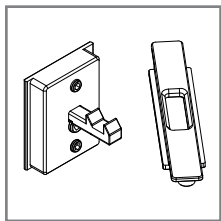

**30 94 61 86**

Conjunto Micro-ventilação Gravity Kristal  
Inox  
Conjunto micro-ventilación Gravity Kristal  
Inox

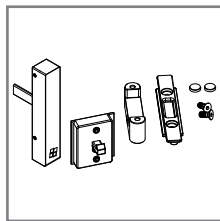

**30 94 61 90/91/92**

Fecho sem Aba Gravity Kristal branco/  
preto/natural  
Cierre sin aba Gravity Kristal blanco/negro/  
natural

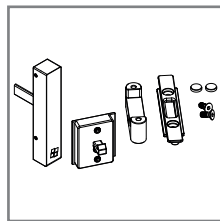

**30 94 61 95/96/97**

Fecho sem Aba Gravity Kristal inox branco/  
preto/natural  
Cierre sin aba Gravity Kristal inox blanco/  
negro/natural

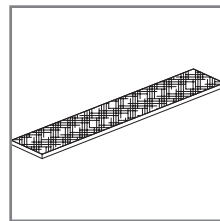

**30 95 60 56**

Barra de latão com 3m e fita adesiva  
dupla face  
Bar de latão com 3m e cinta adhesiva  
dos lados

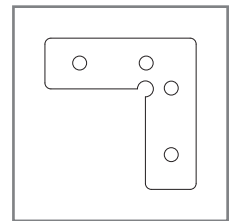

**30 96 00 22**

Esquadro de alinhamento KL-01  
Escuadra alineamiento especial

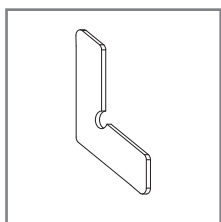

**30 96 00 23**

Esquadro de alinhamento  
Escuadro de alineación

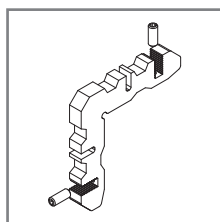

**30 96 00 48**

Esquadro interior/exterior KL-10  
Escuadra alineamiento 7x4 c/tornillas

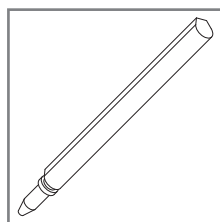

**30 96 00 55**

Perno para fixação esquadro  
30 96 00 48 (opcional)  
Perro para fijación de escuadra

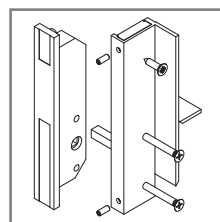

**31 90 85 58**

Conjunto fecho minimal direito  
para laca ou anodizar  
Conjunto cierre minimal kristal derecho

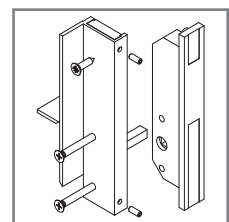

**31 90 85 59**

Conjunto fecho minimal esquerdo  
para laca ou anodizar  
Conjunto cierre minimal Kristal Izquierdo

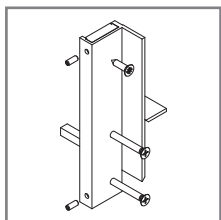

**31 90 85 60**

Fecho minimal direito para laca ou anodizar  
Cierre Minimal Kristal Derecho colores

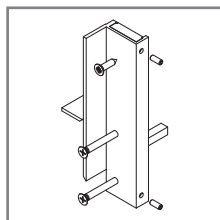

**31 90 85 61**

Fecho minimal esquerdo para laca ou anodizar  
Cierre Minimal Kristal Izquierdo colores

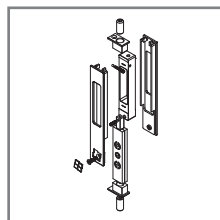

**31 94 60 31**

Fecho puxador central Kristal  
Cierre Manilla Kristal

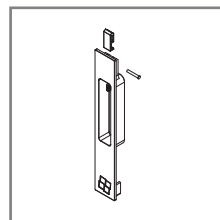

**31 94 60 32**

Puxador cego central Kristal Pivotante  
Manilla ciega central Kristal Pivotante

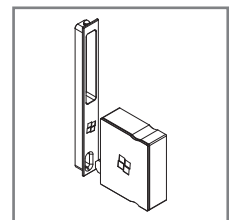

**31 94 60 90**

Fecho lateral Kristal direito  
Cierre lateral Kristal derecho

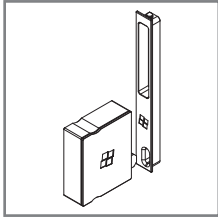
**31 94 60 91**

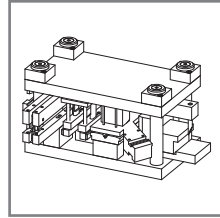
 Fecho lateral Kristal esquerdo  
 Cierre lateral Kristal izquierdo

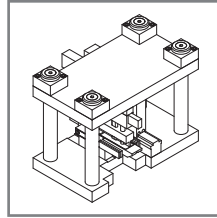
**33 93 29 99**

 Cunho  
 Troquel Kristal

**33 96 87 99**

 Cunho esquadros exteriores e interiores KL-10  
 Troquel escuadros interior/exterior

REFERÊNCIA • REFERENCIA	DESENHO • DISEÑO	DESCRIÇÃO • DESCRIPCIÓN
30 60 00 14		Perfil pelúcia metálica 18mm preto • Perfil burlete metálico 18mm preto
30 93 01 20		Junta interior • Junta interior
30 93 05 00		Junta central EPDM KL-02 • Junta central EPDM KL-02
30 94 60 12		Pelúcia tri-fin • Burlete tri-fin
30 94 60 61		Junta de estanquidade ultra minimalista • Junta de estanquidad ultra minimalista
30 94 60 63		Junta central pivotante preto • Junta central pivotante negro
30 94 64 80		Junta central termo-acústica KL-02/09/12/17 • Junta central termo-acústica KL-02/09/12/17
30 95 00 10		Pelúcia 7x9 mm • Burlete 7x9 mm
30 95 00 40		Pelúcia 7x5.5 mm • Burlete 7x5.5 mm

**Janela 2 folhas correr • Ventana 2 hojas correr**
**PERFIS • PERFIS**

DESENHO • DESEÑO	REF.	DESCRIÇÃO • DESCRIPCIÓN	CORTE CORTE	QUANTIDADE CANTIDAD	MEDIDAS • MEDIDA
	KL-01	Aro fixo Marco Perimetral		2	L
			2	H	
	KL-02	Aro central Hoja central		2	H-106 mm
	KL-03	Aro lateral Hoja lateral		2	H-106 mm
	KL-04	Tampa fixa Perfil complementar marco		4	(L/2)-60 mm
				2	H-94 mm
	KL-05/RD	Guia com rolagentos Perfil guia para folha		2	L (a dividir)
	KL-06*	Separador fixo Perfil polímero central		2	L-68 mm
				2	H-68 mm
	KL-07	Perfil para colar no vidro Perfil polímero para vidro		4	(L/2)-62 mm
				4	H-77 mm
	KL-08	Vareta poliamida Varilla de poliamida		1	H (a dividir)
	KL-13	Perfil tampa Perfil de tapa		2	H-49 mm

\* preferencialmente cortar juntamente com o perfil KL-01 • preferiblemente cortado junto con el perfil KL-01

**ACESSÓRIOS E JUNTAS • ACCESORIOS Y JUNTAS**

REF.	DESCRIÇÃO • DESCRIPTION	QUANTIDADE CANTIDAD
30 92 01 02	Goteira com válvula • Vierteaguas con deflector blanco/negro	4
30 94 50 20	Limitador de abertura • Limitador apertura	2
30 94 60 02	União vareta*** • Union varillas zamack negro	4 ou 12
30 94 60 03	Corta-vento central • Cortaviento kristal negro	2
30 94 60 11	Esquadro 36x12mm centrado • Escuadra 36x12mm centrada KL-01	8
30 94 60 14	Conjunto fecho Kristal** • Conjunto cierre Kristal negro	4 ou 8
30 94 60 15	Batente Kristal • Batiente negro KL-03	4
30 94 60 17	Conjunto topo lateral Kristal • Conjunto tope lateral negro	2
30 94 60 35	Topo p/ reforço KL-02/KL12 preto • Tope para refuerzo KL-02/12 negro	4
30 94 60 4X	Conjunto fecho minimal direito • Conj. cierre minimal Kristal der.	1
30 94 60 4X	Conjunto fecho minimal esquerdo • Conj. Cierre minimal Kristal Izquierdo	1
30 95 60 56	Barra de latão • Bar de latão	2L
30 96 00 22	Esquadro de alinhamento • Escuadra alineamiento especial	8
30 93 05 00	Junta central Kristal • Junta central Kristal	2H
30 94 60 12	Pelúcia tri-fin • Burlete tri-fin	2H
30 95 00 40	Pelúcia 7x5,5 fin-seal • Burlete 7x5,5 fin-seal	8L+4H

\*\* vãos até altura de 1600 mm considerar 4 conjuntos e 4 uniões • se extiende hasta una altura de 1600 mm considere 4 juegos y 4 juntas

\*\*\* vãos com altura >1600 mm considerar 8 conjuntos e 12 uniões • vanos con altura > 1600 mm consideran 8 juegos y 12 juntas

**VIDRO • VIDRIO**

+0 -1 mm Hv = H-84 mm	+0 -1 mm Lv = (L/2)-70 mm
-----------------------------	---------------------------------

Altura Hv e largura Lv dos vidros com tolerância de +0/-1 mm • Alto Hv y ancho Lv de vidrio con tolerancia de + 0 / -1 mm

Setagem secundária do vidro duplo em silicone • Sellado secundario de doble vidrio de silicona

Aplicar vidro duplo com bordos arestados • Aplicar doble vidrio con bordes rugosos

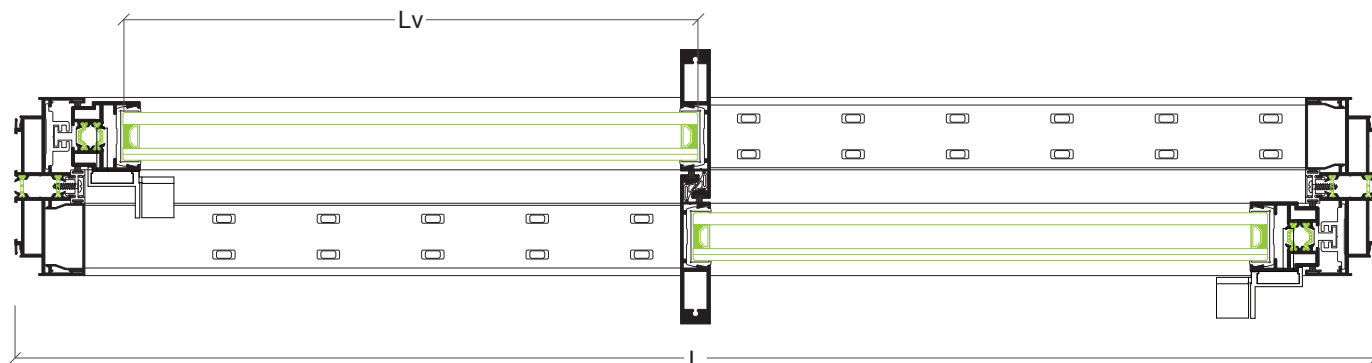
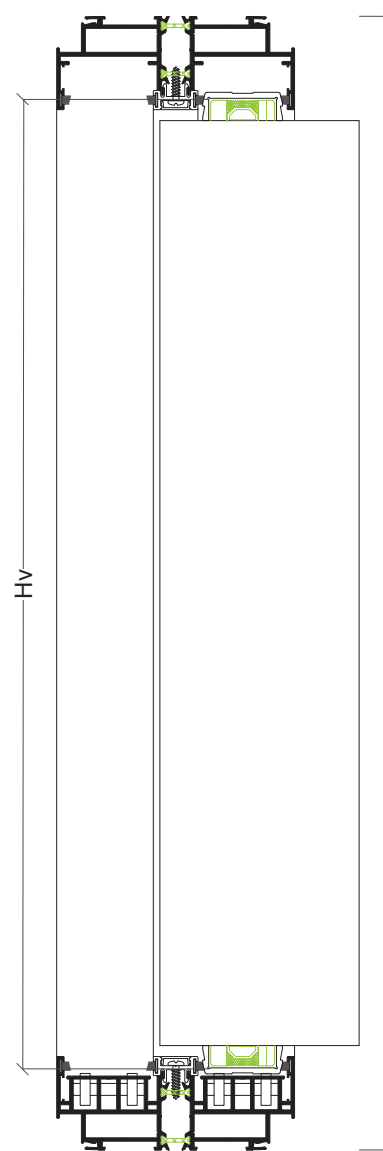
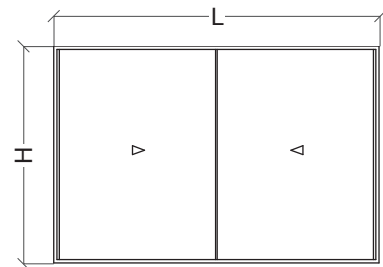

**Janela 3 folhas correr • Ventana 3 hojas correr**
**PERFIS • PERFIS**

DESENHO • DISEÑO	REF.	DESCRIÇÃO • DESCRIPCIÓN	CORTE CORTE	QUANTIDADE CANTIDAD	MEDIDAS • MEDIDA
	KL-01	Aro fixo Marco Perimetral		2	L
				2	H
	KL-02	Aro central Hoja central		4	H-106 mm
	KL-03	Aro lateral Hoja lateral		2	H-106 mm
	KL-04	Tampa fixa Perfil complementar marco		4	(L/2)-60 mm
				2	H-94 mm
	KL-05/RD	Guia com rolamentos Guía con rodamientos		2	L (a dividir)
	KL-06*	Separador fixo Perfil polímero central		2	L-68 mm
				2	H-68 mm
	KL-07	Perfil para colar no vidro Perfil polímero para vidro		6	(L/3)-37 mm
				6	H-77 mm
	KL-08	Vareta poliamida Varilla de poliamida		2	H (a dividir)
	KL-13	Perfil tampa Perfil de tapa		2	H-49 mm

\*\* preferencialmente cortar juntamente com o perfil KL-01 • preferiblemente cortado junto con el perfil KL-01

**ACESSÓRIOS E JUNTAS • ACCESORIOS Y JUNTAS**

REF.	DESCRIÇÃO • DESCRIPTION	QUANTIDADE CANTIDAD
30 92 01 02	Goteira com válvula • Vierteaguas con deflector blanco/negro	6
30 94 60 02	União vareta*** • Unión varilla	4 ou 12
30 94 60 03	Corta-vento central • Cortaviento kristal negro	4
30 94 60 11	Esquadro 36x12mm centrado • Escuadra 36x12mm centrada KL-01	8
30 94 60 14	Conjunto fecho Kristal** • Conjunto cierre Kristal negro	4 ou 8
30 94 60 15	Batente Kristal • Batiente negro KL-03	4
30 94 60 17	Conjunto topo lateral Kristal • Conjunto tope lateral negro	2
30 94 60 35	Topo p/ reforço KL-02/KL12 preto • Tope para refuerzo KL-02/12 negro	8
30 94 60 4X	Conjunto fecho minimal direito • Conjunto cierre minimal derecho	1
30 94 60 4X	Conjunto fecho minimal esquerdo • Conj. cierre minimal Kristal der.	1
30 95 60 56	Barra de latão • Bar de latão	2L
30 96 00 22	Esquadro de alinhamento • Escuadra alineamiento especial	8
30 93 05 00	Junta central Kristal • Junta central Kristal	2H
30 94 60 12	Pelúcia tri-fin • Buriete tri-fin	4H
30 95 00 40	Pelúcia 7x5,5 fin-seal • Buriete 7x5,5 fin-seal	8L+4H

\*\* vãos até altura de 1600 mm considerar 4 conjuntos e 4 uniões • se extiende hasta una altura de 1600 mm considere 4 juegos y 4 juntas  
 \*\*\* vãos com altura >1600 mm considerar 8 conjuntos e 12 uniões • vanos con altura > 1600 mm consideran 8 juegos y 12 juntas

**VIDRO • VIDRIO**

+0	+0
-1 mm	-1 mm
Hv = H-84 mm	Lv = (L/3)-45 mm

Altura Hv e largura Lv dos vidros com tolerância de +0/-1 mm • Alto Hv y ancho Lv de vidrio con tolerancia de + 0 / -1 mm  
 Selagem secundária do vidro duplo em silicone • Sellado secundario de doble vidrio de silicona  
 Aplicar vidro duplo com bordos arestados • Aplicar doble vidrio con bordes rugosos

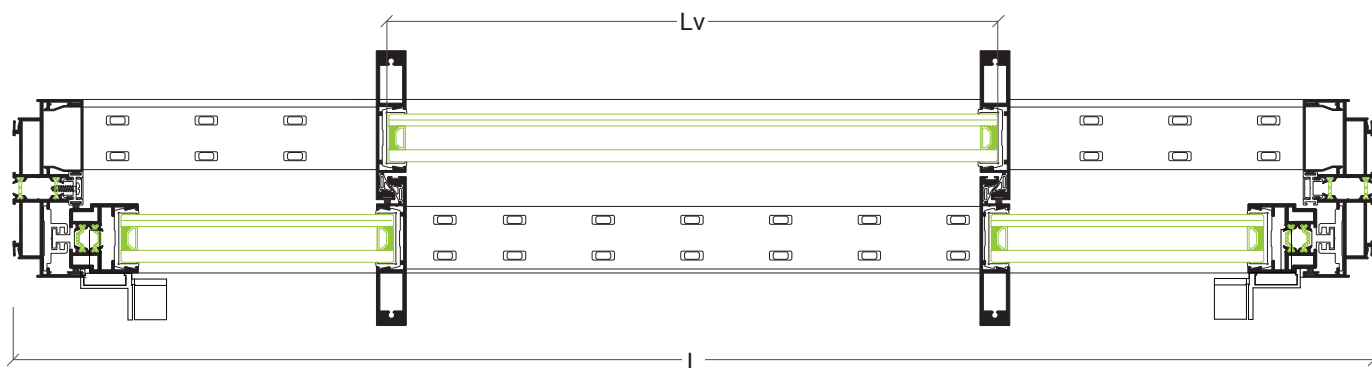
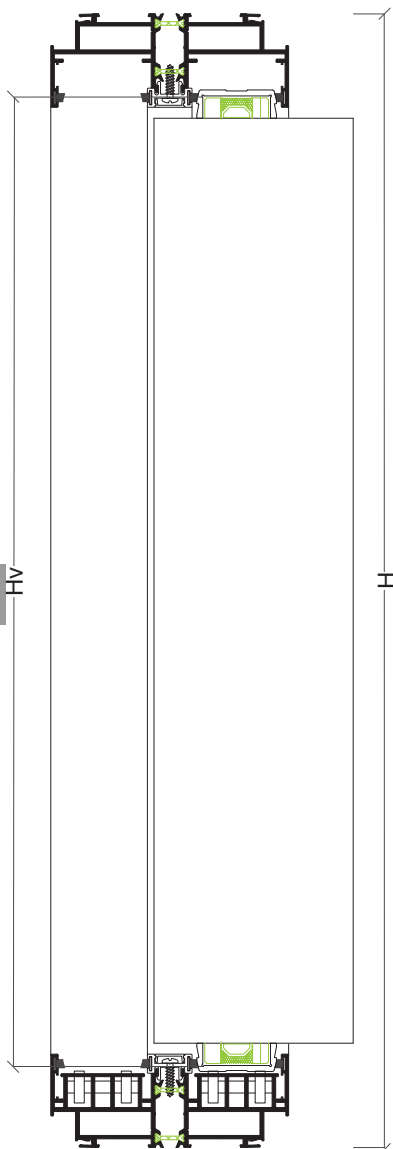
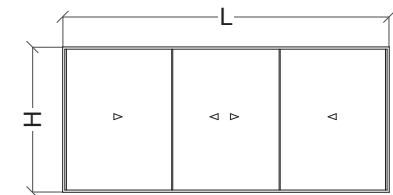

**Janela 3 folhas correr tri-rail • Ventana 3 hojas correr tri-rail**
**PERFIS • PERFILES**

DESENHO • DISEÑO	REF.	DESCRIÇÃO • DESCRIPCIÓN	CORTE CORTE	QUANTIDADE CANTIDAD	MEDIDAS • MEDIDA
	KL-01	Aro fixo Marco Perimetral		2	L
	KL-02	Aro central Hoja central		4	H-106 mm
	KL-03	Aro lateral Hoja lateral		2	H-106 mm
	KL-04	Tampa fixa Perfil complementario marco		4	(L/2)-60 mm
	KL-05/RD	Guia com rolamentos Perfil quiador para hoja		2	(a dividir)
	KL-06*	Separador fixo Perfil polímero central		2	L-68 mm
	KL-07	Perfil para colar no vidro Perfil polímero para vidro		6	(L/3)-37 mm
	KL-08	Vareta poliamida Varilla de poliamida		2	H (a dividir)
	KL-10	Aro fixo Perfil monocarril y tricarril		2	L
	P-02	Perfil de ligação Complemento para 3º e 4º guia		2+2	L-7 mm / H-94 mm
	KL-13	Perfil tampa Perfil de tapa		4	H-49 mm

\* preferencialmente cortar juntamente com o perfil KL-01 • preferiblemente cortado junto con el perfil KL-01

**ACESSÓRIOS E JUNTAS • ACCESORIOS Y JUNTAS**

REF.	DESCRIÇÃO • DESCRIPTION	QUANTIDADE CANTIDAD
30 92 01 02	Goteira com válvula • Vierendeaguas con deflector blanco/negro	2
30 94 50 20	Limitador de abertura • Limitador apertura	2
30 94 60 02	União vareta*** • Union varillas zamack negro	4 ou 12
30 94 60 03	Corta-vento central • Cortaviento kristal negro	4
30 94 60 11	Esquadro 36x12mm centrado • Escuadra 36x12mm centrada KL-01	12
30 94 60 14	Conjunto fecho Kristal** • Conjunto cierre Kristal negro	4 ou 8
30 94 60 15	Batente Kristal • Batiente negro KL-03	4
30 94 60 17	Conjunto topo lateral Kristal • Conjunto tope lateral negro	2
30 94 60 35	Topo p/ reforço KL-02/KL12 preto • Tope para refuerzo KL-02/12 negro	8
30 94 60 4X	Conjunto fecho minimal direito • Conj. cierre minimal Kristal der.	1
30 94 60 4X	Conjunto fecho minimal esquerdo • Conj. Cierre minimal Kristal izquierdo	1
30 95 60 56	Barra de latão • Bar de latão	2L
30 96 00 22	Esquadro de alinhamento • Escuadra alineamiento especial	16
30 96 00 48	Esquadro interior/exterior KL-10 • Escuadra alineamiento 7x4 c/tornillas	8
30 93 05 00	Junta central Kristal • Junta central Kristal	4H
30 94 60 12	Pelúcia tri-fin • Burlete tri-fin	4H
30 95 00 40	Pelúcia 7x5,5 fin-seal • Burlete 7x5,5 fin-seal	12L+4H

\*\* vãos até altura de 1600 mm considerar 4 conjuntos e 4 uniões • se extiende hasta una altura de 1600 mm considere 4 juegos y 4 juntas

\*\*\* vãos com altura >1600 mm considerar 8 conjuntos e 12 uniões • vanos con altura > 1600 mm consideran 8 juegos y 12 juntas

**VIDRO • VIDRIO**

+0	+0
-1 mm	-1 mm
Hv = H-84 mm	Lv = (L/3)-45 mm

Altura Hv e largura Lv dos vidros com tolerância de +0/-1 mm • Alto Hv y ancho Lv de vidrio con tolerancia de + 0 / -1 mm

Selagem secundária do vidro duplo em silicone • Sellado secundario de doble vidrio de silicona

Aplicar vidro duplo com bordos arestados • Aplicar doble vidrio con bordos rugosos

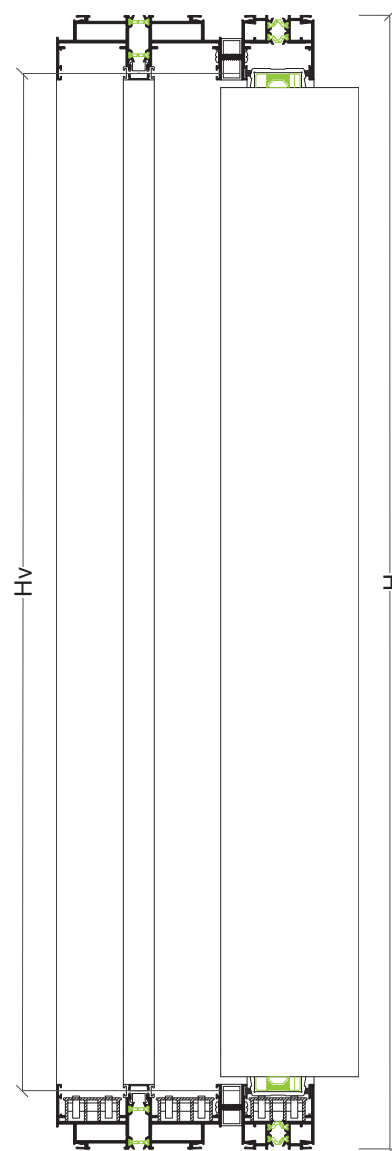
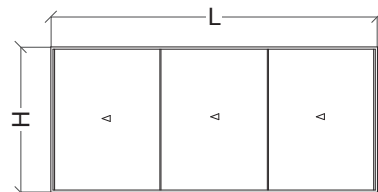
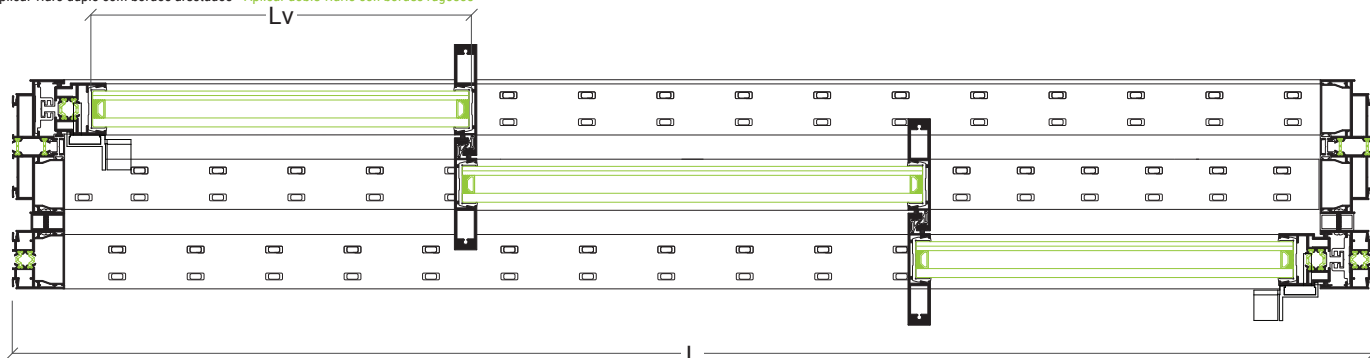

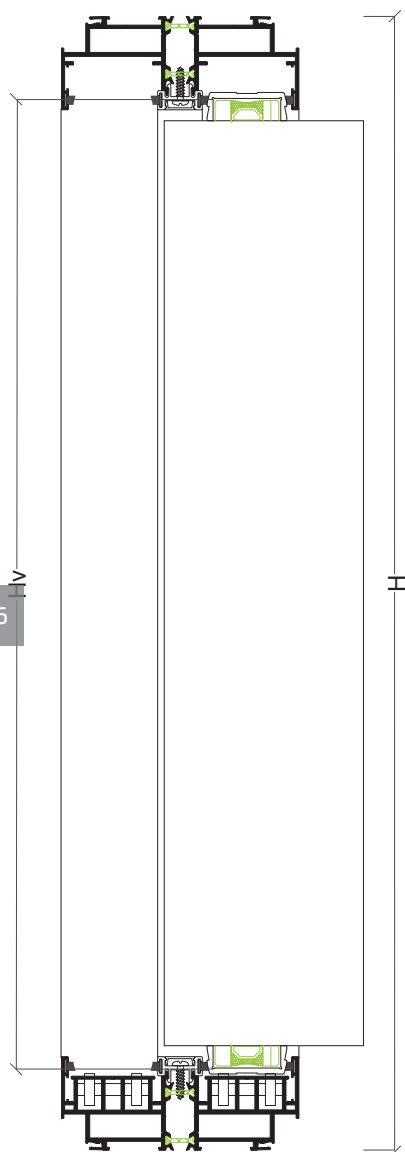
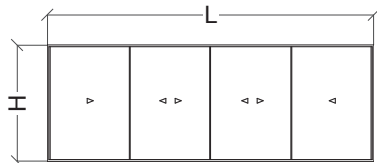
**Janela 4 folhas correr • Ventana 4 hojas correr**
**PERFIS • PERFIS**

DESENHO • DISEÑO	REF.	DESCRIÇÃO • DESCRIPCIÓN	CORTE CORTE	QUANTIDADE CANTIDAD	MEDIDAS • MEDIDA
	KL-01	Aro fixo Marco		2	L
				2	H
	KL-02	Aro central Hoja central		4	H-106 mm
	KL-12	Aro central 3/4 folhas Hoja central 3/4 folhas		2	H-106 mm
	KL-03	Aro lateral Hoja lateral		2	H-106 mm
	KL-04	Tampa fixa Tope fija		4	---
				2	H-94 mm
	KL-05/RD	Guia com rolamentos Guía com rodamientos		2	L (a dividir)
	KL-06*	Separador fixo Separador fijo		2	L-68 mm
				2	H-68 mm
	KL-07	Perfil para colar no vidro Perfil para pegar no vidrio		8	(L/4)-25 mm
				8	H-77 mm
	KL-08	Vareta poliamida Varilla poliamida		2	H (a dividir)
	KL-13	Perfil tampa Perfil tope		2	H-49 mm

\* preferencialmente cortar juntamente com o perfil KL-01 • preferiblemente cortado junto con el perfil KL-01

**ACESSÓRIOS E JUNTAS • ACCESORIOS Y JUNTAS**

REF.	DESCRIÇÃO • DESCRIPTION	QUANTIDADE CANTIDAD
30 92 01 02	Goteira com válvula • Vierteaguas con deflector blanco/negro	7
30 94 50 20	Limitador de abertura • Limitador apertura	2
30 94 60 02	União vareta*** • Union varillas zamack negro	12
30 94 60 03	Corta-vento central • Cortaviento kristal negro	6
30 94 60 11	Esquadro 36x12mm centrado • Escuadra 36x12mm centrada KL-01	8
30 94 60 14	Conjunto fecho Kristal** • Conjunto cierre Kristal negro	4 ou 8
30 94 60 15	Batente Kristal • Batiente negro KL-03	4
30 94 60 17	Conjunto topo lateral Kristal • Conjunto tope lateral negro	2
30 94 61 45	Fecho Puxador central Kristal • Cierre manilla central Kristal	1
30 94 60 81	Fecho lateral pivotante • Conjunto cierre kristal pivotante	2
30 94 60 31	Conjunto varão alumínio 3m • Conj. varilla aluminio 3mts	1
30 94 60 32	Guiador para varão • Guiador Varilla	A cada 500mm
30 94 60 37	Contra fecho central para puxador • Contracierre central negro	2
30 94 60 35	Topo p/ reforço KL-02/KL12 preto • Tope para refuerzo KL-02/12 negro	10
30 94 60 4X	Conjunto fecho minimal direito • Conj. cierre minimal Kristal der.	1
30 94 60 4X	Conjunto fecho minimal esquerdo • Conj. Cierre minimal Kristal izquierdo	1
30 95 60 56	Barra de latão • Bar de latão	2L
30 96 00 22	Esquadro de alinhamento • Escuadra alineamiento especial	8
30 93 05 00	Junta central Kristal • Junta central Kristal	6H
30 94 60 12	Pelúcia tri-fin • Burlete tri-fin	6H
30 95 00 40	Pelúcia 7x5,5 fin-seal • Burlete 7x5,5 fin-seal	8L+4H

**VIDRO • VIDRIO**

+0	+0
-1 mm	-1 mm
Hv = H-84 mm	Lv = (L/4)-33 mm

Altura Hv e largura Lv dos vidros com tolerância de +0/-1 mm • Alto Hv y ancho Lv de vidrio con tolerancia de + 0 / -1 mm  
 Selagem secundária do vidro duplo em silicone • Sellado secundario de doble vidrio de silicona  
 Aplicar vidro duplo com bordos arestados • Aplicar doble vidrio con bordos rugosos

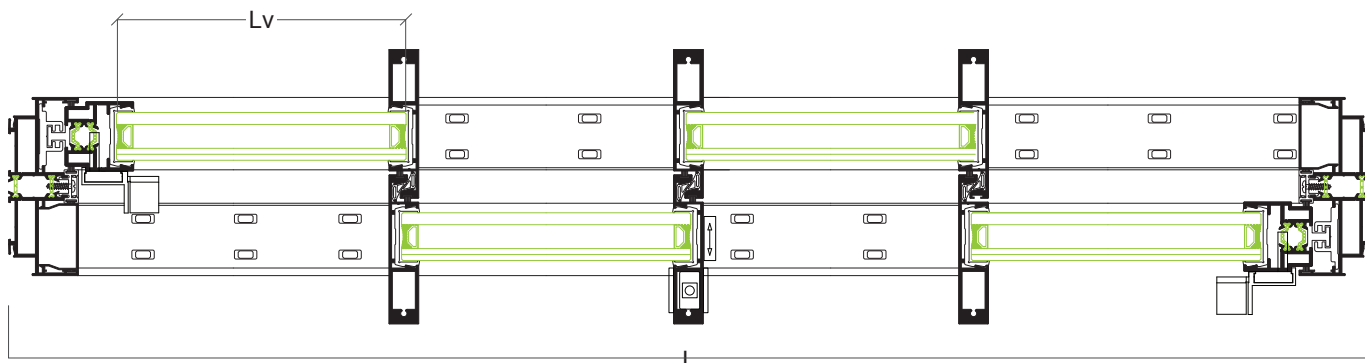

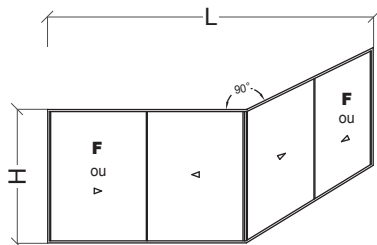

**Janela 2+2 folhas canto 90° • Ventana 2+2 hojas canto 90°**

**VIDRO • VIDRIO**

+0 -1 mm Hv = H-84 mm	+0 -1 mm L1v = (L1/2)-80 mm L2v = (L2/2)-62 mm
-----------------------------	---

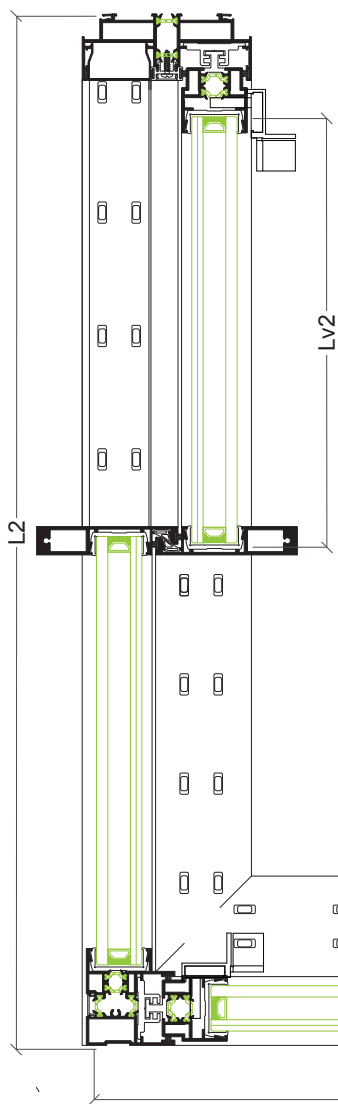
Altura Hv e largura Lv dos vidros com tolerância de +0/-1 mm  
 Alto Hv y ancho Lv de vidrio con tolerancia de + 0 / -1 mm  
 Selagem secundária do vidro duplo em silicone  
 Sellado secundario de doble vidrio de silicona  
 Aplicar vidro duplo com bordos arestados  
 Aplicar doble vidrio con bordes rugosos

**PERFIS • PERFIS**

DESENHO • DISEÑO	REF.	DESCRIÇÃO • DESCRIPCIÓN	CORTE CORTE	QUANTIDADE CANTIDAD	MEDIDAS • MEDIDA
	KL-01	Aro fixo Marco		1	L1
				1	L2
				2	H
	KL-02	Aro central Hoja central		4	H-105 mm
	KL-03	Aro lateral Hoja lateral		3	H-106 mm
	KL-04	Tampa fixa Tope fija		2	(L1/2)-65 mm
				2	(L1/2)-56 mm
				2	(L2/2)-65 mm
				2	(L2/2)-56 mm
	KL-05/RD	Guia com rolamentos Guía con rodamientos		2	L1 (a dividir)
				2	L2 (a dividir)
	KL-06*	Separador fixo Separador fijo		2	L1-88 mm
				2	L2-88 mm
	KL-07	Perfil para colar no vidro Perfil para pegar no vidrio		8	(L1/2)-72 mm
				4	(L2/2)-54mm
				4	H-77 mm
	KL-08	Vareta poliamida Varilla poliamida		3	H (a dividir)
	KL-11	Perfil canto Perfil canto		2	H-106 mm
	KL-04	Tampa fixa Tope fija		2	H-94 mm
				1	H-106 mm
	KL-13	Perfil tampa Perfil tope		2	H-49 mm

\* preferencialmente cortar juntamente com o perfil KL-01 • preferiblemente cortado junto con el perfil KL-01

**ACESSÓRIOS E JUNTAS • ACCESORIOS Y JUNTAS**

REF.	DESCRIÇÃO • DESCRIPTION	QUANTIDADE CANTIDAD
30 92 01 02	Goteira com válvula • Vierendeaguas con deflector blanco/negro	7
30 94 60 02	União vareta*** • Union varillas zamack negro	6 ou 18
30 94 60 03	Corta-vento central • Cortaviento kristal negro	4
30 94 60 11	Esquadro 36x12mm centrado • Escuadra 36x12mm centrada KL-01	8
30 94 60 14	Conjunto fecho Kristal** • Conjunto cierre Kristal negro	12
30 94 60 15	Batente Kristal • Batiente negro KL-03	6
30 94 60 17	Conjunto topo lateral Kristal • Conjunto tope lateral negro	3
30 94 60 18	Conjunto topo canto • Conjunto tope canto negro	1
30 94 60 33	Esquadro para canto 90° • Escuadra ángulo Kristal 11.7x36	4
30 94 60 35	Topo p/ reforço KL-02/KL12 preto • Tope para refuerzo KL-02/12 negro	8
30 94 60 4X	Conjunto fecho minimal direito • Conj. cierre minimal Kristal der.	1
30 94 60 4X	Conjunto fecho minimal esquerdo • Conj. Cierre minimal Kristal izquierdo	2
30 95 60 56	Barra de latão • Bar de latão	2L1 + 2L2
30 96 00 22	Esquadro de alinhamento • Escuadra alineamiento especial	8
30 93 05 00	Junta central Kristal • Junta central Kristal	4H
30 94 60 12	Pelúcia tri-fin • Burlete tri-fin	4H
30 95 00 40	Pelúcia 7x5,5 fin-seal • Burlete 7x5,5 fin-seal	8(L1)+8(L2)+6H
30 94 60 23	Kit Espumas EPDM autoadesivas (par) • Kit Espuma EPDM	1





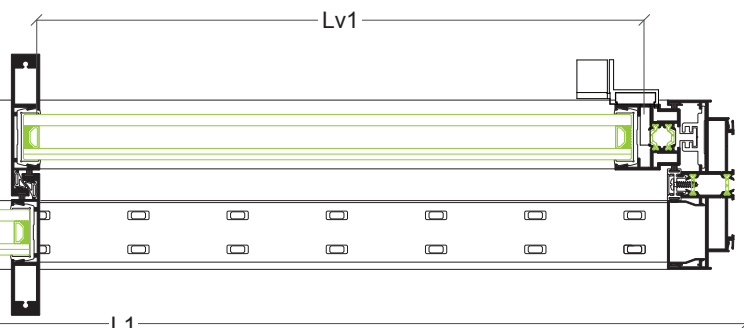

















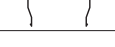



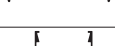

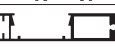



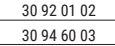

\*\* vão até altura de 1600 mm considerar 6 conjuntos e 6 uniões • vanos de hasta 1600 mm de altura consideran 6 juegos y 6 uniones

\*\*\* vão com altura >1600 mm considerar 12 conjuntos e 18 uniões • vanos con altura > 1600 mm consideran 12 juegos y 18 juntas

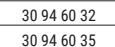

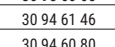
## Porta pivotante 2 folhas abertura interior • Puerta pivotante 2 hojas apertura interior

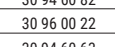
### PERFIS • PERFIS

DESENHO • DESEÑO	REF.	DESCRIÇÃO • DESCRIPCIÓN	CORTE CORTE	QUANTIDADE CANTIDAD	MEDIDAS • MEDIDA
	KL-01	Aro fixo Marco		2	L
				2	H
	KL-04	Tampa fixa Tope fija		2	(L/2)-60 mm
				2	(L/2)-89 mm
				2	H-94 mm
	KL-06*	Separador fixo Separador fijo		2	L-68 mm
				2	H-68 mm
	KL-07	Perfil para colar no vidro Perfil para pegar no vidrio		4	H-134 mm
				4	(L/2)-51mm
	KL-13	Perfil tampa Perfil tope		2	H-94 mm
				1	L (a dividir)
				1	L (a dividir)
	KL-13/R	Perfil tampa com rasgos Perfil tope com rasgos		1	L (a dividir)
	KL-13/R	Perfil tampa com rasgos Perfil tope com rasgos		1	L (a dividir)
	KL-13	Perfil tampa Perfil tope		1	L (a dividir)
	KL-16	Tampa Tope		2	H-94mm
				1	30mm
	KL-19	Aro móvel inferior Hoja inferior		4	(L/2) 51mm (com malhetes)
	KL-20	Aro móvel central Hoja central		2	H-106mm
	KL-21	Aro móvel lateral Hoja lateral		2	H-106mm
	KL-22	Batente inferior Batiente inferior		2	H-94mm
	KL-23	Batente exterior Batiente exterior		2	30mm

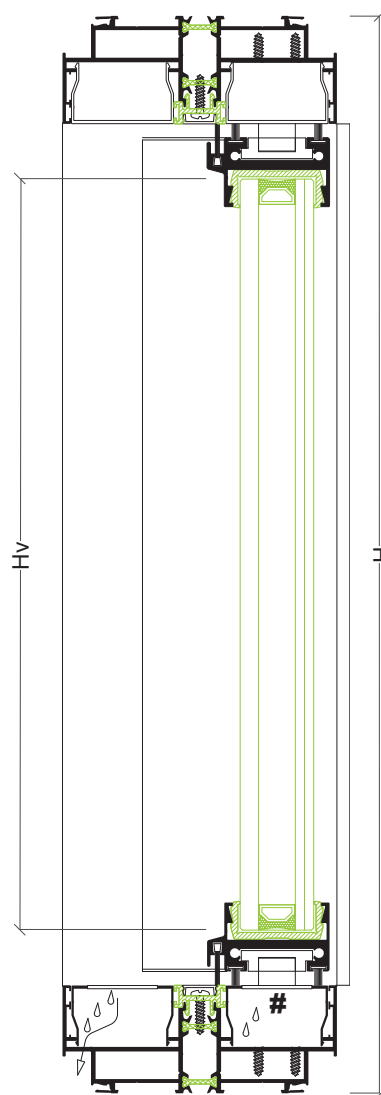
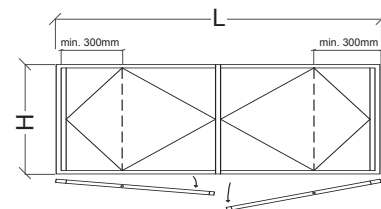

### VIDRO • VIDRIO

+0	+0
-1 mm	-1 mm
Hv = H-142 mm	Lv = (L/2)-59 mm

Altura Hv e largura Lv dos vidros com tolerância de +0/-1 mm

Alto Hv y ancho Lv de vidrio con tolerancia de + 0 / -1 mm

Selagem secundária do vidro duplo em silicone

Sellado secundario de doble vidrio de silicona

Aplicar vidro duplo com bordos arestados

Aplicar doble vidrio con bordos rugosos

\* preferencialmente cortar juntamente com o perfil KL-01 • preferiblemente cortado junto con el perfil KL-01

### ACESSÓRIOS E JUNTAS • ACCESORIOS Y JUNTAS

REF.	DESCRIÇÃO • DESCRIPTION	QUANTIDADE CANTIDAD
30 92 01 02	Goteira com válvula • Vierendeaguas con deflector blanco/negro	4
30 94 60 03	Corta-vento central • Cortaviento kristal negro	4
30 94 60 11	Esquadro 36x12mm centrado • Escuadra 36x12mm centrada KL-01	8
30 94 60 32	Guiador para varão • Guiador Varilla	A cada 500mm (H)
30 94 60 35	Topo p/ reforço KL-02/KL12 preto • Tope para refuerzo KL-02/12 negro	6
30 95 60 65	Kit Kristal pivotante • Kit kristal pivotante	2
30 94 61 46	Fecho pivotante • Conjunto cierre Kristal pivotante Der. Negro/blanco	1
30 94 60 80	Conjunto varão inox • Conjunto varilla roscada inox(4 m)	1
30 94 60 82	Fecho lateral • Conjunto cierre kristal pivotante negro/blanco/natural/inox	2
30 96 00 22	Esquadro de alinhamento KL-01 • Escuadra alineamiento especial	8
30 94 60 63	Junta central • Junta central	2H
30 93 01 20	Junta interior batente • Junta interior batiente	2H
30 60 00 14	Pelúcia metálica • Burlete metálica	2L
30 95 00 10	Pelúcia • Burlete	4L+2H
30 94 61 52	Mola chão p/chumbar Kristal Pivotante • Mola tierra p/chumbar Kristal Pivotante	2
30 94 60 37	Contra fecho central para puxador • Contracierre central negro	2

