

**Sistema
Kristal**

Sistema Kristal

Sistema de correr de conceito minimalista com RPT

Características do sistema

Sistema de alumínio com rotura térmica para executar vãos de correr de conceito minimalista.

Perfis de alumínio

Os perfis de alumínio são extrudidos na liga de alumínio 6060 para arquitetura de acordo com norma NP EN 12020-02.

Perfis com rotura térmica obtida por inserção de varetas isolantes de poliamida de 6.6 mm reforçadas com 25% de fibra de vidro de 14.6 mm nos aros fixos e de 18 mm nos aros móveis.

Espessura média dos perfis de alumínio de 2.0 mm.

Aros fixos

Secção do aro fixo perimetral de 120 mm com bi-rail para montagem a meia esquadria;

Possibilidade de aplicação de remates interior ou exterior;

Perfil guia de deslizamento inferior em alumínio com rolamentos duplos de altas prestações em aço inoxidável 316.

Aros móveis

Secção dos aros móveis de vista muito reduzida de corte recto por montagem por clipagem;

Vidro duplo isolante com selagem secundária de silicone de 32.4 mm a 32.8 mm de espessura total, composto por tipologias de vidro exterior temperado ou termo-endurecido e de vidro interior laminado termo-endurecido ou temperado;

Calha em polímero colada em todo o perímetro do vidro isolante com silicone estrutural preto;

Silicones estruturais recomendados: Dow Corning 791 preto ou Sikasil SG20 preto;

Aros móveis reforçados de linha contemporânea para elevados dimensionamentos.

Dimensionamento e manobralidade

Dimensões mínimas - máximas de folha: 300 mm - 3000 mm (L); 500 mm - 3000 mm (H);

Peso máximo de 300 kg por folha;

Tipologias de 2, 3 ou 4 folhas móveis e/ou fixas;

Possibilidade de abertura em canto;

Sistema de correr de conceito minimalista com deslizamento das folhas sobre o perfil de alumínio efectuado com rolamentos em aço inoxidável de altas prestações para uma fácil abertura do vão mesmo com configurações extremas de peso ou dimensão;

Tipologias dos vãos com mais de 95% de luminosidade;

Permeabilidade ao ar e estanquidade à água asseguradas através de pelúcia de última geração e junta em EPDM de qualidade marítima;

Ferragem multiponto com diversos pontos de fecho e de fácil aplicação e regulação;

Ferragem multiponto com micro-ventilação incluída em todos os pontos de fecho;

Puxador específico para facilitar a manobra de abertura e de fecho do vão;

Existe a opção de puxador com chave para permitir a abertura do vão pelo exterior.

Performances

Sistema certificado por laboratório notificado para Ensaio Tipo Inicial (ITT) de acordo com a norma de produto EN 14351-1 para efeitos de Marcação CE.

Categorias alcançadas na avaliação do sistema Kristal tipologia janela:

1. Permeabilidade ao ar: Classe 2 (norma de ensaio EN 1026)
2. Estanquidade à água: Classe 7A (norma de ensaio EN 1027)
3. Resistência ao vento: Classe C5 (norma de ensaio EN 12211)

Categorias alcançadas na avaliação do sistema Kristal tipologia porta:

1. Permeabilidade ao ar: Classe 3 (norma de ensaio EN 1026)
2. Estanquidade à água: Classe 6A (norma de ensaio EN 1027)
3. Resistência ao vento: Classe C2 (norma de ensaio EN 12211)
4. Permeabilidade ao ar em Micro-ventilação: Classe 1 (norma de ensaio EN 1026)

Categorias alcançadas na avaliação do sistema KRISTAL para determinação das forças de manobra (EN 12046):

1. Libertação da ferragem de fecho: Classe 2
2. Abertura da folha: Classe 1
3. Fecho da folha: Classe 1
4. Engate da ferragem de fecho: Classe 2

Categoria alcançada na determinação da resistência a abertura e fecho repetidos (5000 ciclos): Classe 1 (EN 1191)

Coefficiente de transmissão térmica de vão de 2 folhas com 5.0 m x 3.0 m com vidro $U_g = 1.0 \text{ W/m}^2\text{K}$, com intercalar efeito "Warm Edge":

• $U_w = 1.29 \text{ W/m}^2\text{K}$

Coefficiente de atenuação acústica de vão de 2 folhas com vidro acústico 8/16/44.1:

• $R_w (C; C_{tr}) = 41 \text{ dB} (-1; -5)$

Zonas de aplicação segundo RCCTE (em função do valor U_g): I1, I2, I3, V1, V2, V3.

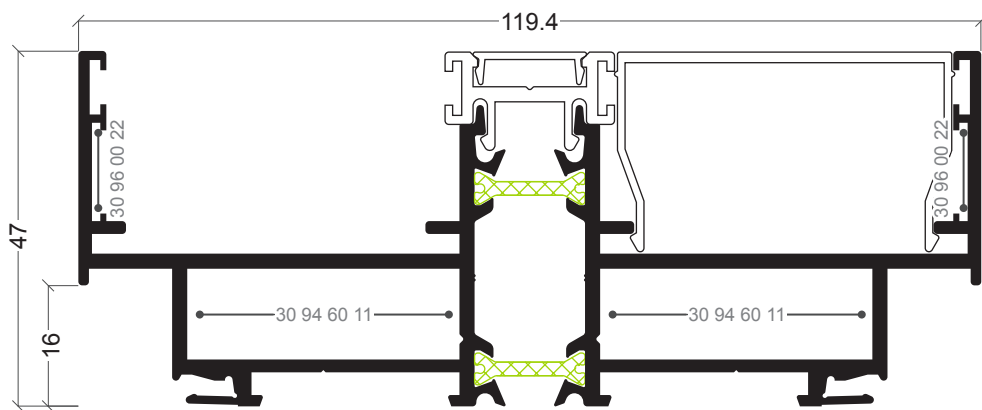

KL-01
Aro fixo perimetral

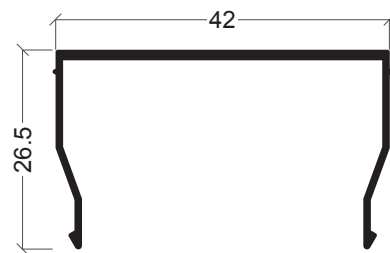

KL-13
Perfil Tampa

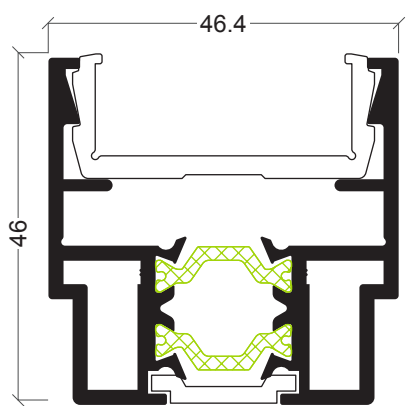

KL-03
Aro móvel lateral

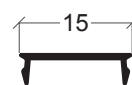

KL-04
Perfil complementar aro fixo

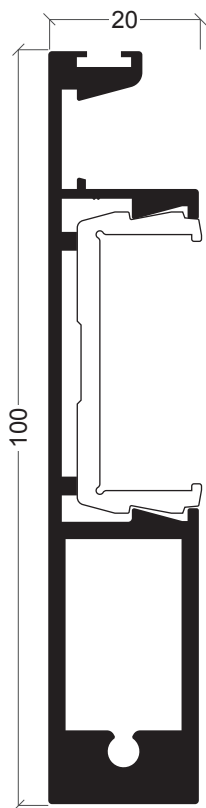

KL-02
Aro móvel central reforçado

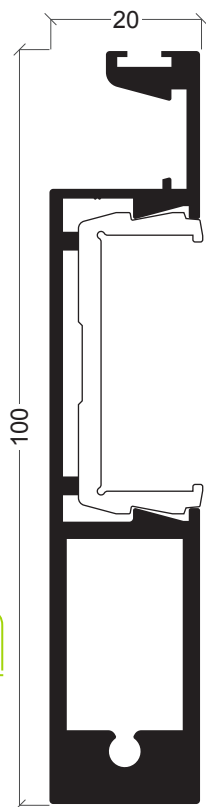

KL-12
Aro móvel central reforçado 3/4 folhas

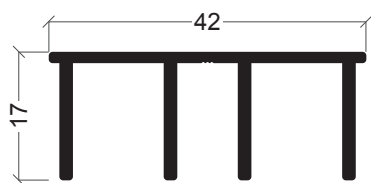

KL-05
Perfil suporte para folha fixa

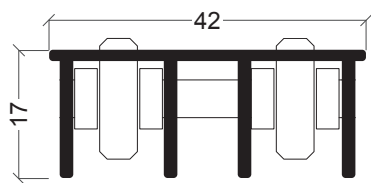

KL-05/RD
Perfil guia para folha móvel
Acetinado 1AC
Acetinado 2AC
Lacado 9005 MT

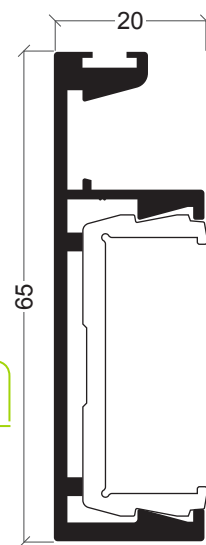

KL-09
Aro móvel central

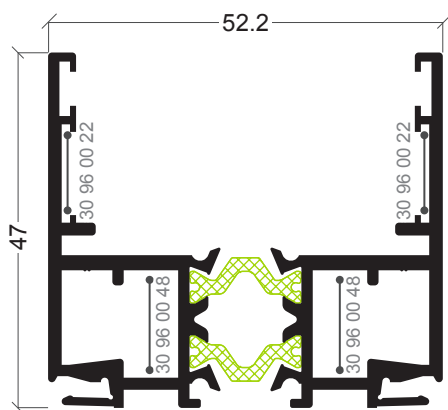

KL-10
Perfil mono-rail e 3º rail

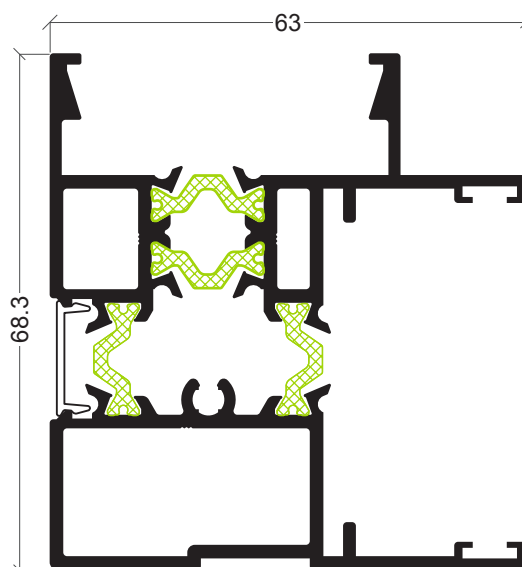

KL-11
Perfil canto

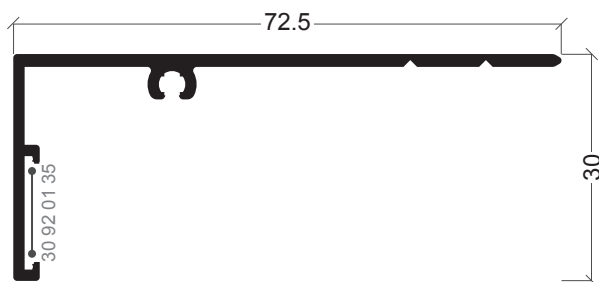

AXi-83
Remate

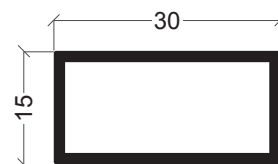

P-02
Complemento para 3ª e 4ª guia

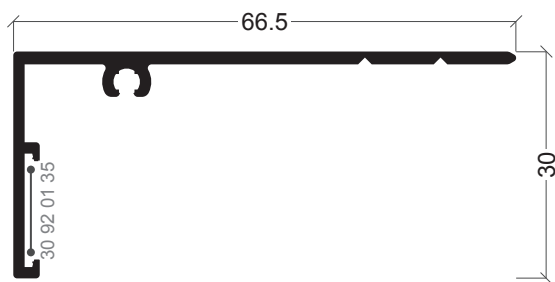

AXi-73
Remate

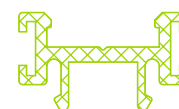

KL-06
Perfil polímero central

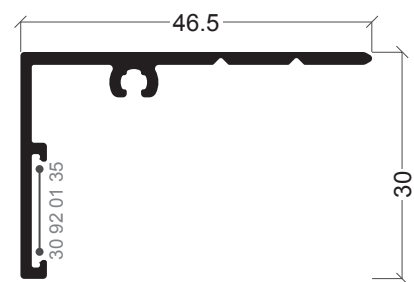

AXi-80
Remate



AXi-88
Complemento remate

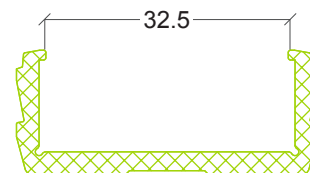

KL-07
Perfil polímero para vidro



KL-08
Vareta de poliamida

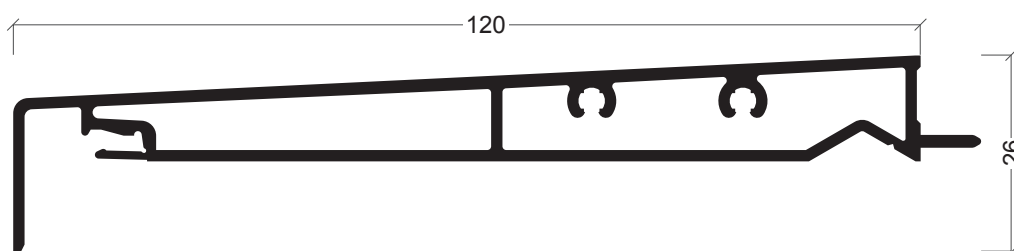

AXi-74
Remate soleira

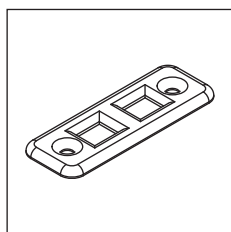

30 24 30 75
Contra-fecho inox
aplicar com fechos lisos

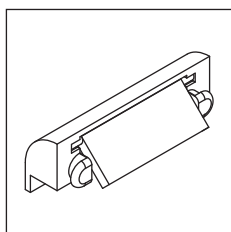

30 92 01 02/03
Goteira com válvula
(preto/branco)

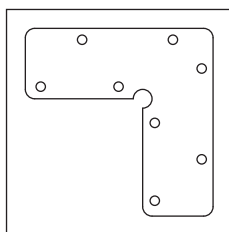

30 92 01 35
Esquadro alinhamento
AXi-73/80/83/88

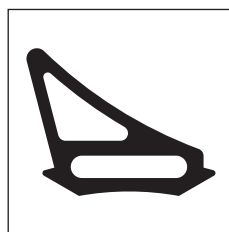

30 93 05 00
Junta central EPDM
KL-02

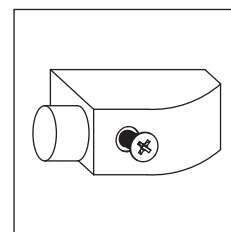

30 94 50 20
Limitador de abertura

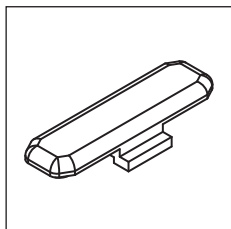

30 94 60 01
União varetas nylon
preto

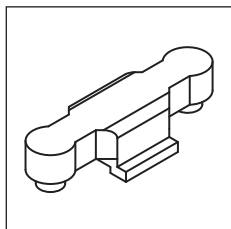

30 94 60 02
União varetas zamack
preto alternativa

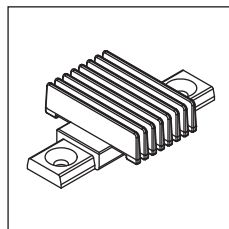

30 94 60 03
Corta-vento Kristal preto

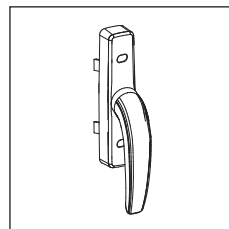

30 94 60 04/05
Cremone exterior lacado
(branco/preto)

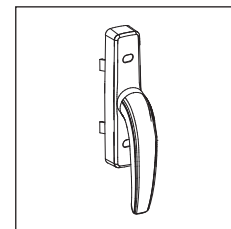

30 94 60 06
Cremone exterior lacado
(cinza 9006)

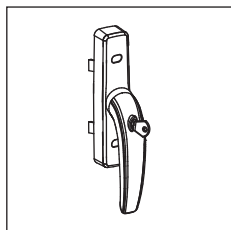

30 94 60 08/09
Cremone exterior com
chave lacado (branco/preto)

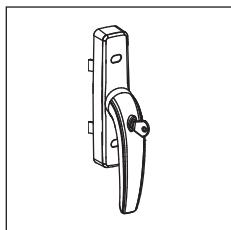

30 94 60 10
Cremone exterior lacado
com chave (cinza 9006)

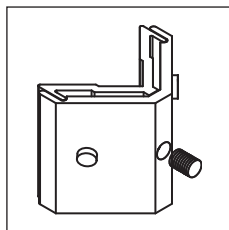

30 94 60 11
Esquadro 36x12 mm
centrado KL-01

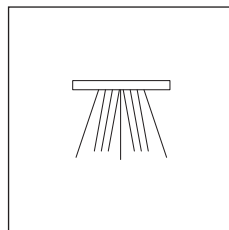

30 94 60 12
Pelúcia tri-fin

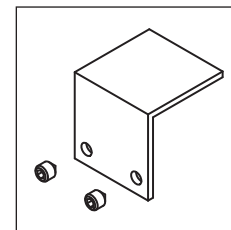

30 94 60 13
Cantoneira de apoio
central preto KL-02

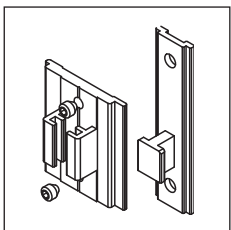

30 94 60 14
Conjunto fecho preto

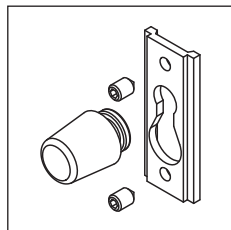

30 94 60 15
Batente preto KL-03

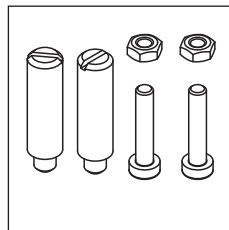

30 94 60 16
Suplemento para fecho
fixação cremone exterior

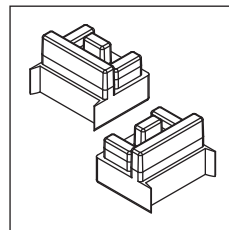

30 94 60 17
Conjunto topo lateral
fixação preto KL-03

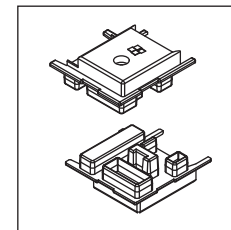

30 94 60 18
Conjunto topo canto
preto KL-11

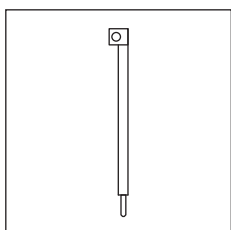

30 94 60 19/21
Fecho liso interior
450 mm (branco/preto)

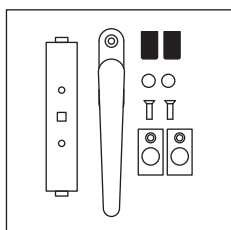

30 94 60 20/22
Conjunto puxadores para
3F/4F ou central

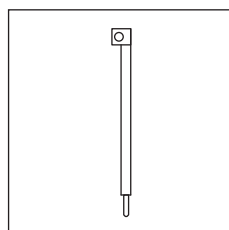

30 94 60 25/26
Fecho liso interior
700 mm (branco/preto)

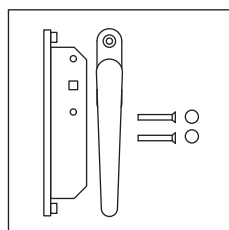

30 94 60 28/29
Puxador lateral baixo
(branco/preto)

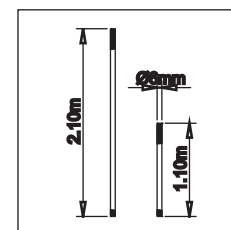

30 94 60 31
Conjunto varão alumínio
3000 mm

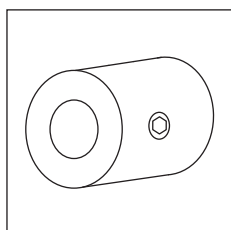

30 94 60 32
Guiador para varão por
cada 500 mm

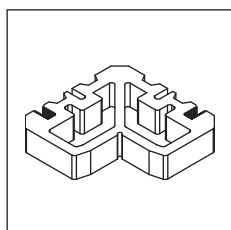

30 94 60 33
Esquadro para canto 90°

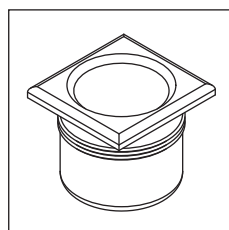

30 94 60 34
Contra-fecho central para
puxador 3/4 F + central (preto)

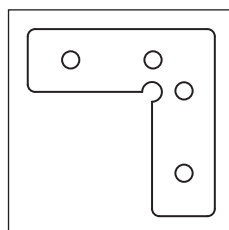

30 96 00 22
Esquadro de
alinhamento KL-01

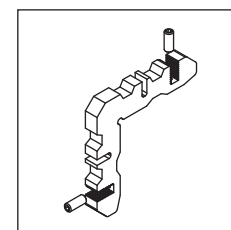

30 96 00 48
Esquadro interior/exterior
KL-10

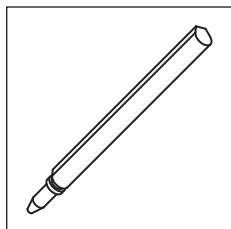

30 96 00 55

Perno para fixação esquadro
30 96 00 48 (opcional)

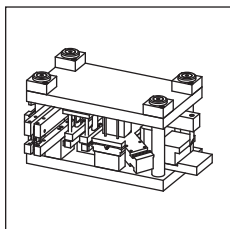

33 93 29 99

Cunho

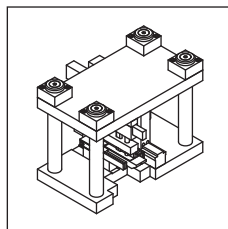

33 96 87 99

Cunho esquadros exteriores
e interiores KL-10

Janela 1 folha correr com fixo lateral

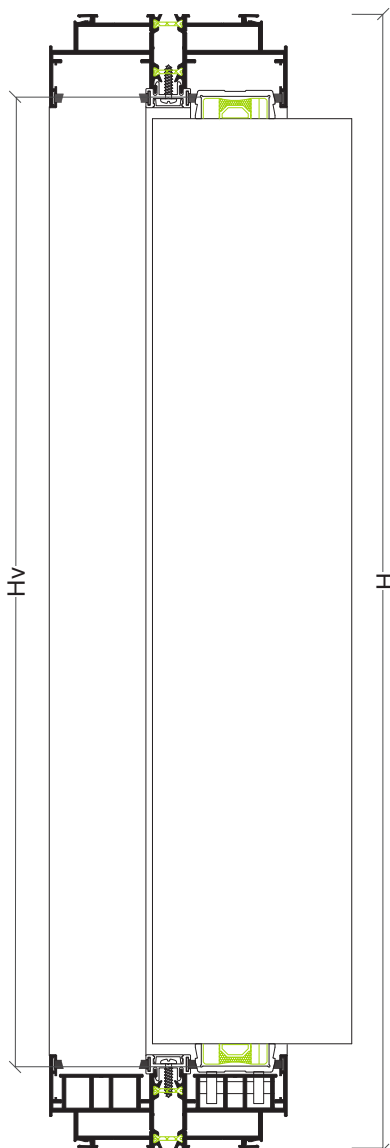
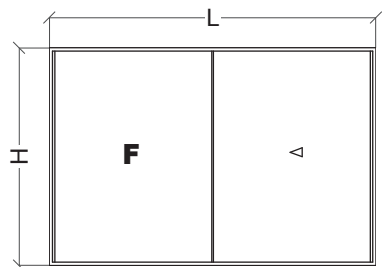

Perfis

Desenho	Ref	Descrição	Corte	Quant	Medida
	KL-01	Aro fixo		2	L
				2	H
	KL-02	Aro central		2	H-105 mm
	KL-03	Aro lateral		2	H-106 mm
	KL-04	Tampa fixa		4	(L/2)-60 mm
				2	H-94 mm
	KL-05/RD	Guia com rolamentos		1	L (a dividir)
	KL-05	Perfil suporte folha fixa		1	L-50 mm
	KL-06*	Separador fixo		2	L-68 mm
				2	H-68 mm
	KL-07	Perfil para colar no vidro		4	(L/2)-62 mm
				4	H-77 mm
	KL-08	Vareta poliamida		1	H-400 mm
	KL-13	Perfil tampa		1	H-62 mm
				1	H-49 mm

* preferencialmente cortar juntamente com o perfil KL-01

Acessórios e Juntas

Referência	Descrição	Quantidade
30 94 60 11	Esquadro aro fixo	8
30 96 00 22	Esquadro de alinhamento	8
30 94 60 0X	Cremona	1
30 94 60 16	Suplemento para fecho	1
30 94 60 15	Batente Kristal	4
30 94 60 14	Conjunto fecho Kristal**	2 ou 4
30 94 60 02	União vareta***	2 ou 6
30 94 60 17	Conjunto topo lateral Kristal	2
30 94 60 03	Corta-vento central	2
30 94 60 13	Cantoneira de apoio	2
30 94 50 20	Limitador de abertura	1
30 93 05 00	Junta central Kristal	2H
30 94 60 12	Pelúcia tri-fin	8L+6H

** vãos até altura de 1600 mm considerar 4 conjuntos e 4 uniões

*** vãos com altura >1600 mm considerar 8 conjuntos e 12 uniões

Vidro

+0 -1 mm	+0 -1 mm
Hv = H-84 mm	Lv = (L/2)-70 mm

Altura Hv e largura Lv dos vidros com tolerância de +0/-1 mm

Selagem secundária do vidro duplo em silicone

Aplicar vidro duplo com bordos arestados

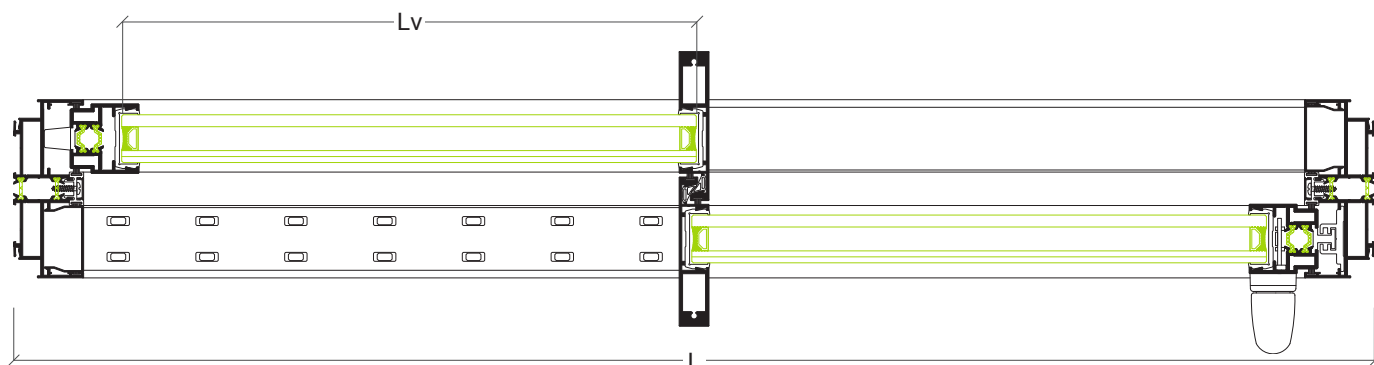

Janela 2 folhas correr

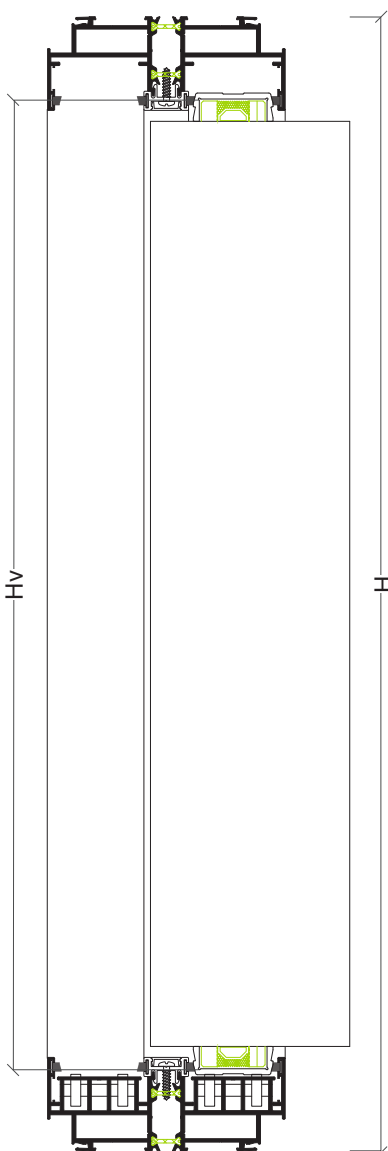
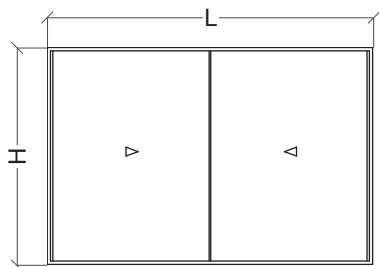

Perfis

Desenho	Ref	Descrição	Corte	Quant	Medida
	KL-01	Aro fixo		2	L
				2	H
	KL-02	Aro central		2	H-105 mm
	KL-03	Aro lateral		2	H-106 mm
	KL-04	Tampa fixa		4	(L/2)-60 mm
				2	H-94 mm
	KL-05/RD	Guia com rolamentos		2	L (a dividir)
	KL-06*	Separador fixo		2	L-68 mm
				2	H-68 mm
	KL-07	Perfil para colar no vidro		4	(L/2)-62 mm
				4	H-77 mm
	KL-08	Vareta poliamida		1	H-400 mm
	KL-13	Perfil tampa		1	H-49 mm

* preferencialmente cortar juntamente com o perfil KL-01

Acessórios e Juntas

Referência	Descrição	Quantidade
30 94 60 11	Esquadro aro fixo	8
30 96 00 22	Esquadro de alinhamento	8
30 94 60 0X	Cremona	2
30 94 60 16	Suplemento para fecho	2
30 94 60 15	Batente Kristal	4
30 94 60 14	Conjunto fecho Kristal**	4 ou 8
30 94 60 02	União vareta***	4 ou 12
30 94 60 17	Conjunto topo lateral Kristal	2
30 94 60 03	Corta-vento central	2
30 94 60 13	Cantoneira de apoio	2
30 94 50 20	Limitador de abertura	2
30 93 05 00	Junta central Kristal	2H
30 94 60 12	Pelúcia tri-fin	8L+6H

** vãos até altura de 1600 mm considerar 4 conjuntos e 4 uniões

*** vãos com altura >1600 mm considerar 8 conjuntos e 12 uniões

Vidro

+0 -1 mm	+0 -1 mm
Hv = H-84 mm	Lv = (L/2)-70 mm

Altura Hv e largura Lv dos vidros com tolerância de +/-1 mm

Selagem secundária do vidro duplo em silicone

Aplicar vidro duplo com bordos arestados

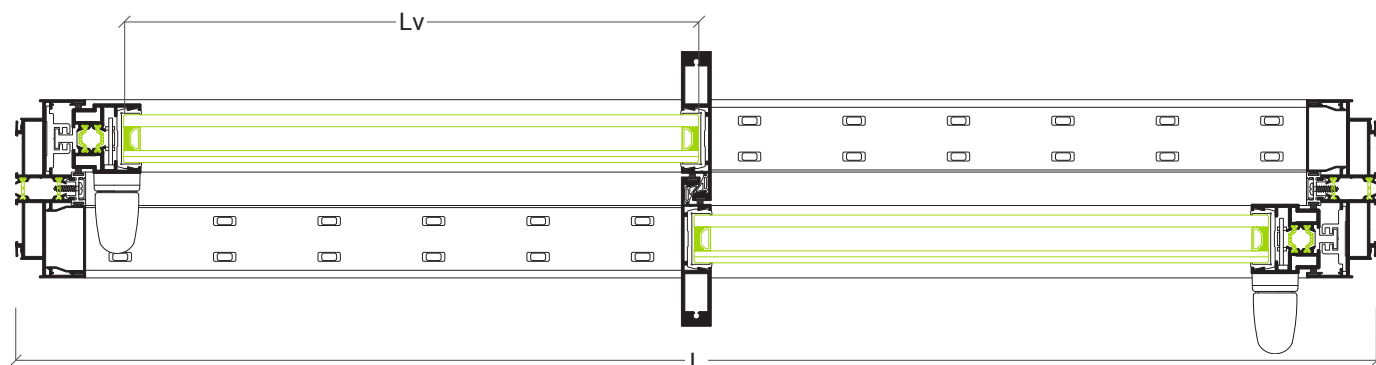

Janela 3 folhas correr

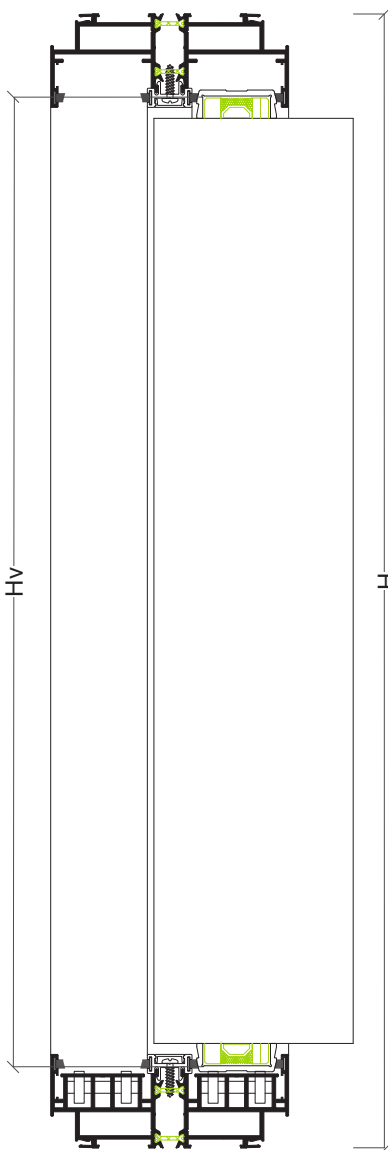
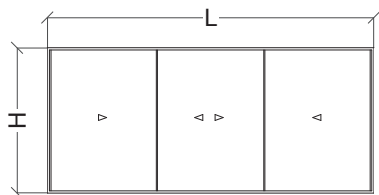

Perfis

Desenho	Ref	Descrição	Corte	Quant	Medida
	KL-01	Aro fixo		2	L
				2	H
	KL-02	Aro central		4	H-105 mm
	KL-03	Aro lateral		2	H-106 mm
	KL-04	Tampa fixa		4	(L/2)-60 mm
				2	H-94 mm
	KL-05/RD	Guia com rolamentos		2	L (a dividir)
	KL-06*	Separador fixo		2	L-68 mm
				2	H-68 mm
	KL-07	Perfil para colar no vidro		6	(L/3)-37.5 mm
				6	H-77 mm
	KL-08	Vareta poliamida		2	H-400 mm
	KL-13	Perfil tampa		2	H-49 mm

* preferencialmente cortar juntamente com o perfil KL-01

Acessórios e Juntas

Referência	Descrição	Quantidade
30 94 60 11	Esquadro aro fixo	8
30 96 00 22	Esquadro de alinhamento	8
30 94 60 0X	Cremona	2
30 94 60 16	Suplemento para fecho	2
30 94 60 15	Batente Kristal	4
30 94 60 14	Conjunto fecho Kristal**	4 ou 8
30 94 60 02	União vareta***	4 ou 12
30 94 60 17	Conjunto topo lateral Kristal	2
30 94 60 03	Corta-vento central	4
30 94 60 13	Cantoneira de apoio	4
30 94 50 20	Limitador de abertura	1
30 93 05 00	Junta central Kristal	4H
30 94 60 12	Pelúcia tri-fin	8L+6H

** vãos até altura de 1600 mm considerar 4 conjuntos e 4 uniões

*** vãos com altura >1600 mm considerar 8 conjuntos e 12 uniões

Vidro

+0 -1 mm	+0 -1 mm
Hv = H-84 mm	Lv = (L/3)-46 mm

Altura Hv e largura Lv dos vidros com tolerância de +0/-1 mm

Selagem secundária do vidro duplo em silicone

Aplicar vidro duplo com bordos arestados

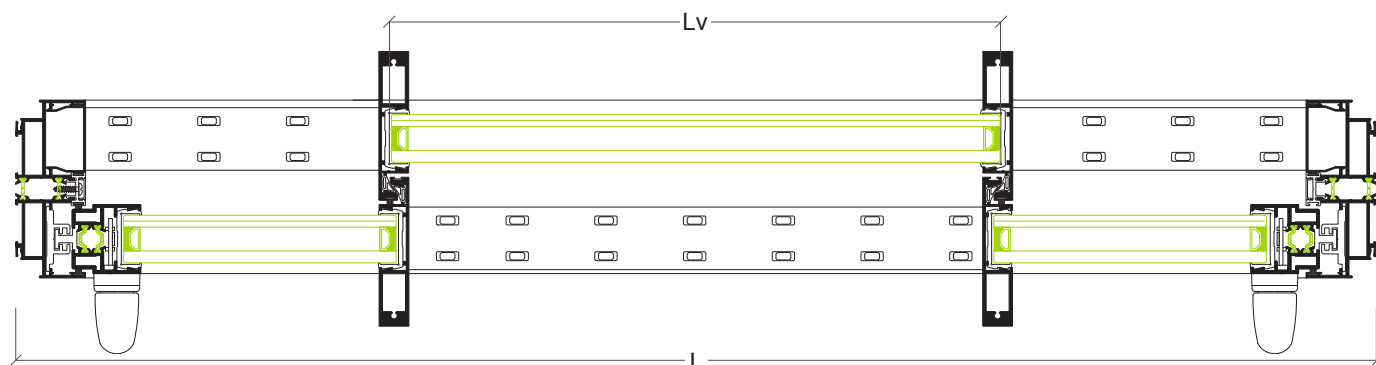

Janela 3 folhas correr tri-rail

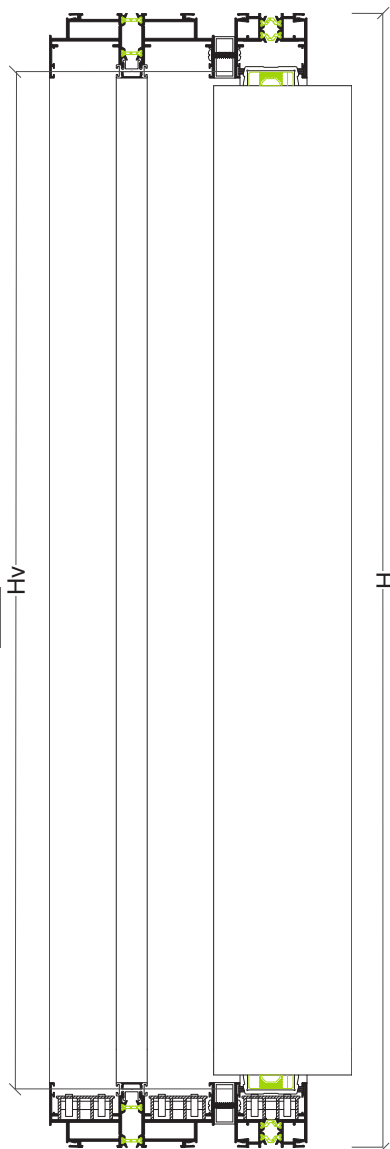
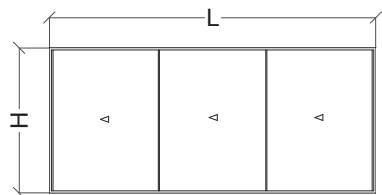

Perfis

Desenho	Ref	Descrição	Corte	Quant	Medida
	KL-01	Aro fixo		2	L
				2	H
	KL-02	Aro central		4	H-105 mm
	KL-03	Aro lateral		2	H-106 mm
	KL-04	Tampa fixa		4	(L/2)-60 mm
				2	H-94 mm
	KL-05/RD	Guia com rolamentos		2	(a dividir)
	KL-06*	Separador fixo		2	L-68 mm
				2	H-68 mm
	KL-07	Perfil para colar no vidro		6	(L/3)-37,5 mm
				6	H-77 mm
	KL-08	Vareta poliamida		2	H-400 mm
	KL-10	Aro fixo		2	L
				2	H
	P-02	Perfil de ligação		2+2	L-7 mm / H-94 mm
	KL-13	Perfil tampa		2	H-49 mm

* preferencialmente cortar juntamente com o perfil KL-01

Acessórios e Juntas

Referência	Descrição	Quantidade
30 94 60 11	Esquadro aro fixo	8
30 96 00 22	Esquadro de alinhamento	8
30 94 60 0X	Cremone	2
30 94 60 16	Suplemento para fecho	2
30 94 60 15	Batente Kristal	4
30 94 60 14	Conjunto fecho Kristal**	4 ou 8
30 94 60 02	União vareta***	4 ou 12
30 94 60 17	Conjunto topo lateral Kristal	2
30 94 60 03	Corta-vento central	4
30 94 60 13	Cantoneira de apoio	4
30 93 05 00	Junta central Kristal	4H
30 94 60 12	Pelúcia tri-fin	8L+8H
30 94 50 20	Limitador de abertura	1
30 96 00 48	Esquadro aro fixo KL-10	8
30 96 00 55	Perno para esquadro KL-10 (opcional)	8

** vãos até altura de 1600 mm considerar 4 conjuntos e 4 uniões
*** vãos com altura >1600 mm considerar 8 conjuntos e 12 uniões

Vidro

+0 -1 mm Hv = H-84 mm	+0 -1 mm Lv = (L/3)-46 mm
-----------------------------	---------------------------------

Altura Hv e largura Lv dos vidros com tolerância de +/-1 mm

Selagem secundária do vidro duplo em silicone

Aplicar vidro duplo com bordos arestados

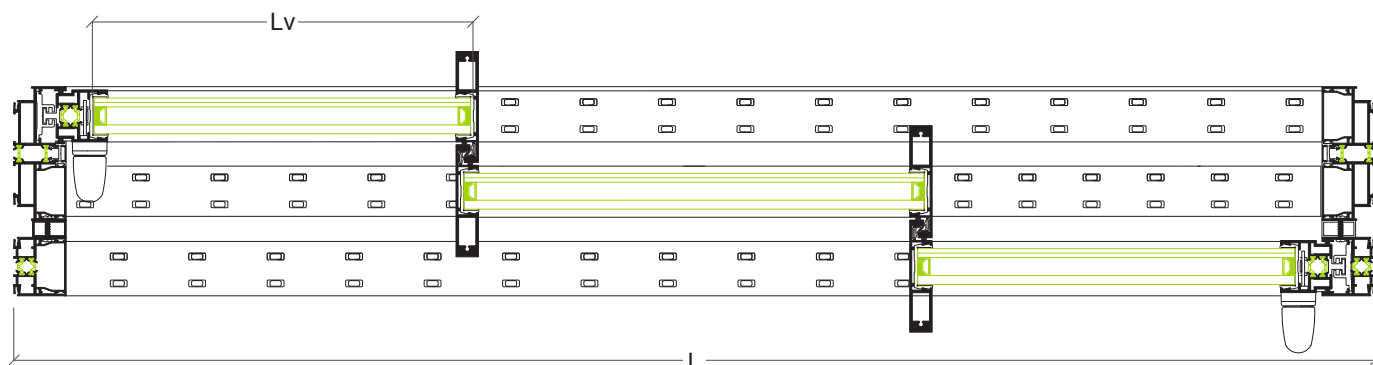

Janela 4 folhas correr

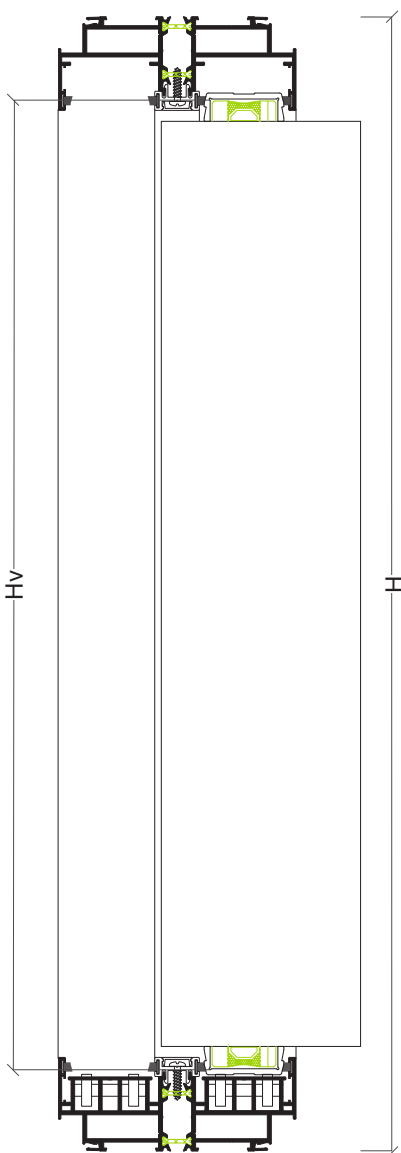
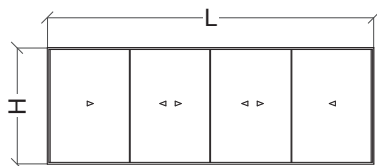

Perfis

Desenho	Ref	Descrição	Corte	Quant	Medida
	KL-01	Aro fixo		2	L
				2	H
	KL-02	Aro central		4	H-105 mm
	KL-12	Aro central 3/4 folhas		2	H-105 mm
	KL-03	Aro lateral		2	H-106 mm
	KL-04	Tampa fixa		4	(L/2)-60 mm
				2	H-94 mm
	KL-05/RD	Guia com rolamentos		2	L (a dividir)
	KL-06*	Separador fixo		2	L-68 mm
				2	H-68 mm
	KL-07	Perfil para colar no vidro		8	(L/4)-25 mm
				8	H-77 mm
	KL-08	Vareta poliamida		2	H-400 mm
	KL-13	Perfil tampa		2	H-49 mm

* preferencialmente cortar juntamente com o perfil KL-01

Acessórios e Juntas

Referência	Descrição	Quantidade
30 94 60 11	Esquadro aro fixo	8
30 96 00 22	Esquadro de alinhamento	8
30 94 60 0X	Cremona	2
30 94 60 16	Suplemento para fecho	2
30 94 60 15	Batente Kristal	4
30 94 60 14	Conjunto fecho Kristal**	4 ou 8
30 94 60 02	União vareta***	4 ou 12
30 94 60 17	Conjunto topo lateral Kristal	2
30 94 60 03	Corta-vento central	6
30 94 60 13	Cantoneira de apoio	6
30 94 50 20	Limitador de abertura	2
30 93 05 00	Junta central Kristal	6H
30 94 60 12	Pelúcia tri-fin	8L+10H
30 94 60 XX	Fecho liso interior	2
30 24 30 75	Contra fecho inox	2
30 94 60 2X	Conjunto puxador de 3/4 folhas	1
30 94 60 31	Conjunto varão alumínio 3 mts	1
30 94 60 34	Contra-fecho central	2

** vãos até altura de 1600 mm considerar 4 conjuntos e 4 uniões

*** vãos com altura >1600 mm considerar 8 conjuntos e 12 uniões

Vidro

+0	+0
-1 mm	-1 mm
Hv = H-84 mm	Lv = (L/4)-34 mm

Altura Hv e largura Lv dos vidros com tolerância de +/-1 mm

Selagem secundária do vidro duplo em silicone



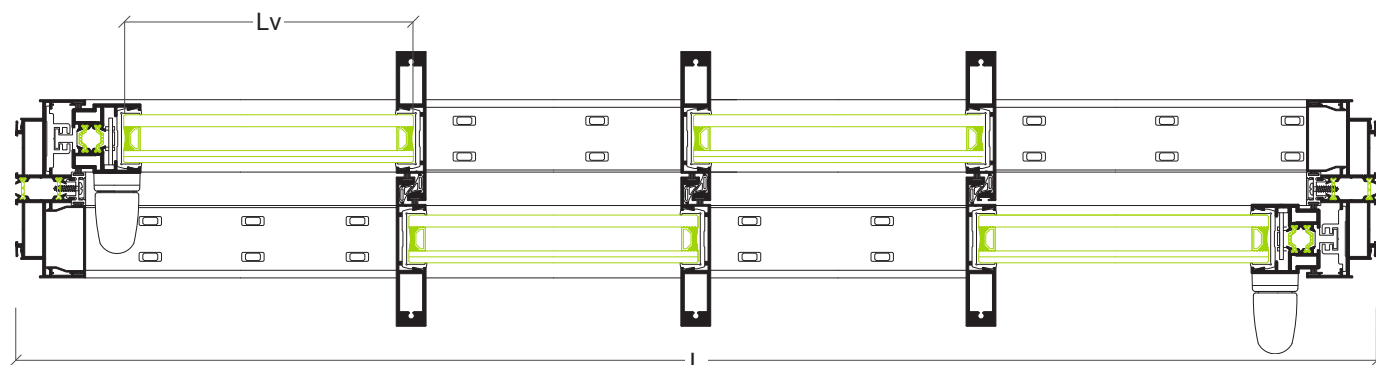



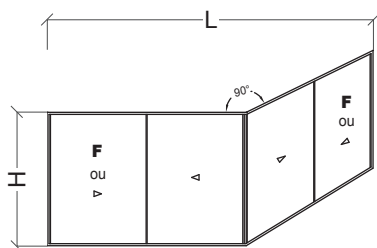



















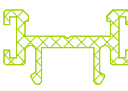





Aplicar vidro duplo com bordos arestados



Janela 2+2 folhas canto 90°



Perfis

Desenho	Ref	Descrição	Corte	Quant	Medida
	KL-01	Aro fixo		1	L1
				1	L2
				2	H
	KL-02	Aro central		4	H-105 mm
	KL-03	Aro lateral		3	H-106 mm
	KL-04	Tampa fixa		2	(L1/2)-65 mm
				2	(L1/2)-56 mm
				2	(L2/2)-65 mm
				2	(L2/2)-56 mm
	KL-05/RD	Guia com rolamentos		2	L1 (a dividir)
				2	L2 (a dividir)
	KL-06*	Separador fixo		2	L1-88 mm
				2	H-68 mm
				2	H-68 mm
	KL-07	Perfil para colar no vidro		8	(L1/2)-71.5 mm
				4	(L2/2)-54mm
				4	H-77 mm
	KL-08	Vareta poliamida		3	H-400 mm
	KL-11	Perfil canto		2	H-106 mm
	KL-04	Tampa fixa		1	H-106 mm
	KL-13	Perfil tampa		2	H-49 mm

* preferencialmente cortar juntamente com o perfil KL-01

Acessórios e Juntas

Referência	Descrição	Quantidade
30 94 60 11	Esquadro aro fixo	8
30 96 00 22	Esquadro de alinhamento	8
30 94 60 0X	Cremone	3
30 94 60 16	Suplemento para fecho	3
30 94 60 15	Batente Kristal	6
30 94 60 14	Conjunto fecho Kristal**	6 ou 12
30 94 60 02	União vareta***	6 ou 18
30 94 60 17	Conjunto topo lateral Kristal	3
30 94 60 03	Corta-vento central	4
30 94 60 13	Cantoneira de apoio	4
30 93 05 00	Junta central Kristal	4H
30 94 60 12	Pelúcia tri-fin	8L1+8L2+10H
30 94 50 20	Limitador de abertura	2
30 94 60 18	Conjunto topo canto 90°	1
30 94 60 33	Esquadro para canto 90°	4

** vãos até altura de 1600 mm considerar 4 conjuntos e 4 uniões

*** vãos com altura >1600 mm considerar 8 conjuntos e 12 uniões

Vidro

+0 -1 mm Hv = H-84 mm	+0 -1 mm L1v = (L1/2)-80 mm L2v = (L2/2)-62 mm
-----------------------------	---------------------------------------------------------

Altura Hv e largura Lv dos vidros com tolerância de +/-1 mm

Selagem secundária do vidro duplo em silicone

Aplicar vidro duplo com bordos arestados

