





[www.anicolor.pt](http://www.anicolor.pt)

**SISTEMA DE CORRER  
COM RPT - 105 mm**

**SISTEMA CORREDERA  
CON RPT - 105 mm**

**CW**

 **anicolor**  
Sistemas de Alumínio

## SISTEMA CW

### Sistema de correr com RPT - 105 mm

#### CARACTERÍSTICAS DO SISTEMA

Sistema de alumínio com rotura térmica para executar vãos de correr.  
 O sistema de correr CW possibilita a execução de 4 versões de caixilharia:  
 Perimetral, Minimal, Galandage e Elevatória.

#### PERFIS DE ALUMÍNIO

Os perfis de alumínio são extrudidos na liga de alumínio 6060 para arquitetura de acordo com norma NP EN 12020-02.  
 Perfis com rotura térmica obtida por inserção de varetas isolantes de poliamida de 6.6 mm reforçadas com 25% de fibra de vidro de 30 mm nos aros fixos e de 14.6 mm nos aros móveis.  
 Espessura média dos perfis de alumínio de 1.5 mm.

#### AROS FIXOS

Secção do aro fixo perimetral de 2 guias de 105 mm para montagem a meia esquadria;  
 Perfil guia de deslizamento inferior em aço inoxidável AISI 304 para evitar desgaste das peças.

#### AROS MÓVEIS

Secção dos aros móveis perimetrais de 48 mm com montagem a meia esquadria;  
 Enchimento de 4 a 36 mm;  
 Aros móveis de linha recta com ou sem bite ou com bite reduzido;  
 Bites rectos;  
 Estantidade assegurada através de juntas em EPDM e pelúcia tipo Fin-Seal.

#### DIMENSIONAMENTO E MANOBRABILIDADE

Dimensões mínimas - máximas de folha: 300 mm - 2500 mm (L); 350 mm - 2675 mm (H);  
 Peso máximo de 300 Kg por folha (com 2 rolamentos)  
 Tipologias de 2, 3, 4, 6 e 8 folhas móveis e/ou fixas;  
 Tipologias de correr Galandage de 1, 2, 3, 4 e 6 folhas;  
 Rolamento duplo oscilante com regulação;  
 Rolamentos de agulhas em inox com eixo temperado retificado sendo possível a substituição sem desmontagem da folha;  
 Suporte exterior com tratamento cataforese (anti-corrosivo);  
 Abertura do vão com fecho lateral ou ferragem multiponto com 2 ou mais pontos de fecho;  
 Puxadores desviados (esquerdo ou direito) para ferragem multiponto permitindo maior facilidade de abertura;  
 Possibilidade de aplicação de ferragem elevatória de média dimensão;  
 Puxador específico para ferragem elevatória de modo a facilitar as manobras de abertura e fecho do vão;  
 Existe a opção de puxador duplo com colocação de canhão com chave para permitir a abertura do vão pelo exterior.

#### PERFORMANCES

Sistema certificado por laboratório credenciado, notificado para Ensaio Tipo Inicial (ITT) de acordo com a norma de produto EN 14351-1 para efeitos de Marcação CE.

Categorias alcançadas na avaliação do sistema CW tipologia janela:

1. Permeabilidade ao ar: Classe 3 (norma de ensaio EN 10207 e EN 1026)
2. Estantidade à água: Classe 7A (norma de ensaio EN 12208 e EN 1027)
3. Resistência ao vento: Classe C5 (norma de ensaio EN 12210 e EN 12211)

Categorias alcançadas na avaliação do sistema CW tipologia porta:

1. Permeabilidade ao ar: Classe 3 (norma de ensaio EN 10207 e EN 1026)
2. Estantidade à água: Classe 6A (norma de ensaio EN 12208 e EN 1027)
3. Resistência ao vento: Classe B3 (norma de ensaio EN 12210 e EN 12211)

Categorias alcançadas na avaliação do sistema CW tipologia porta elevatória:

1. Permeabilidade ao ar: Classe 4 (norma de ensaio EN 10207 e EN 1026)
2. Estantidade à água: Classe 7A (norma de ensaio EN 12208 e EN 1027)
3. Resistência ao vento: Classe C3 (norma de ensaio EN 12210 e EN 12211)

Categorias alcançadas na avaliação do sistema CW para determinação das forças de manobra (EN 12046):

1. Libertação da ferragem de fecho: Classe 2
2. Abertura da folha: Classe 1
3. Fecho da folha: Classe 2
4. Engate da ferragem de fecho: Classe 2

Categoria alcançada na determinação da resistência a abertura e fecho repetidos (5000 ciclos): Classe 1 (EN 1191)

Coefficiente de transmissão térmica de vão de 2 folhas com 4.0 m x 2.4 m com vidro Ug = 0.7 W/m<sup>2</sup>K, com intercalar efeito "Warm Edge":  
 • Uw = 1.48 W/m<sup>2</sup>K

Coefficiente de atenuação acústica de vão de 2 folhas com vidro acústico 6/16/44.1:  
 • Rw (C; Ctr) = 34 dB (-1; -6)

Zonas de aplicação segundo RCCTE (em função do valor Ug): I1, I2, I3, V1, V2, V3.

Sistema certificado pelo laboratório francês CSTB de acordo com as seguintes características:

- Certificado QB49
- Documento técnico de aplicação (DTA) nas tipologias de correr Bi-rail e Tri rail, Galandage e minimal com o avis technique 6/19-2399\_V1.

## SISTEMA CW

### Sistema corredera con RPT - 105 mm

#### CARACTERÍSTICAS DEL SISTEMA

Sistema de aluminio con rotura térmica para ejecución de huecos de correr.  
 El sistema corredero CW permite la ejecución de 4 versiones de marcos:  
 Perimetral, Minimal e Galandage

#### PERFILES DE ALUMINIO

Los perfiles de aluminio son extruidos en aleación de aluminio 6060 para arquitectura de acuerdo con la norma NP EN 12020-02.  
 Los perfiles con rotura térmica son obtenidos por inserción de varillas aislantes de poliamida 6.6 mm reforzadas con 25% de fibra de vidrio de 30mm en los marcos y de 14.6mm en las hojas.  
 Espesor medio de los perfiles de aluminio de 1.5 mm.

#### MARCOS

Profundidad del marco perimetral de 2 guías de 105 mm para montaje a englete;  
 Perfil guía de deslizamiento inferior en acero inoxidable AISI 304, para evitar el desgaste de las piezas.

#### HOJAS

Profundidad de las hojas perimetrales de 48 mm para montaje a englete;  
 Acrislamiento de 4 mm a 36 mm;  
 Hojas de linea recta con y sin junquillo y con junquillo reducido;  
 Estanteidad asegurada mediante juntas en EPDM y burlete tipo Sin-Feal.

#### DIMENSIONAMIENTO Y MANIOBRABILIDAD

Dimensiones miniomas-máximas de hoja: 300mm - 2500mm (L); 350mm - 2675mm (H);  
 Peso máximo de 300 Kg por hoja (con 2 rodamientos);  
 Posibilidades de apertura: 2, 3, 4, 6 y 8 hojas con hojas correderas y/o fijas;  
 Tipologias corredera Galandage de 1, 2, 3, 4 u 6 hojas;  
 Rodamiento doble oscilante con regulación;  
 Rodamientos de agujas inox con eje templado rectificado siendo posible la sustitución de la hoja sin desmontar la ventana;  
 Soporte exterior con tratamiento anticorrosión;  
 Apertura del hueco con cierre lateral u herraje multipunto con 2 u más puntos de cierre.  
 Manilla desplazadas (izquierdo u derecho) para herraje multipunto permitiendo más facilidad de apertura;  
 Posibilidad de aplicación de herraje elevable de media dimensión;  
 Manilla de herraje elevable específica para facilitar las maniobras de apertura y cierre del hueco;  
 Existe la opción de doble manilla con colocación de bombillo con llave para permitir la apertura del hueco por el exterior.

#### ENSAYOS

Sistema certificado por laboratorio credenciado, notificado para Ensayos Tipo Inicial (ITT) de acuerdo con la norma de producto EN 14351-1 para efectos de Marcado CE.

Categorias alcanzadas en los ensayos del sistema CW tipologia ventana:

1. Permeabilidad al aire: Clase 3 (norma de ensayo EN 10207 e EN 1026)
2. Estanteidad al agua: Clase 7A (norma de ensayo EN 12208 e EN 1027)
3. Resistencia al viento: Clase C5 (norma de ensayo EN 12210 e EN 12211)

Categorias alcanzadas en los ensayos del sistema CW tipologia puerta:

1. Permeabilidad al aire: Clase 3 (norma de ensayo EN 10207 e EN 1026)
2. Estanteidad al agua: Clase 6A (norma de ensayo EN 12208 e EN 1027)
3. Resistencia al viento: Clase B3 (norma de ensayo EN 12210 e EN 12211)

Categorias alcanzadas en los ensayos del sistema CW tipologia puerta elevable:

1. Permeabilidad al aire: Clase 4 (norma de ensayo EN 10207 e EN 1026)
2. Estanteidad al agua: Clase 7A (norma de ensayo EN 12208 e EN 1027)
3. Resistencia al viento: Clase C3 (norma de ensayo EN 12210 e EN 12211)

Categorias alcanzadas en los ensayos del sistema CW para determinación de las fuerzas de manobra (EN 12046):

1. Libertación de la herraje de cierre: Clase 2
2. Apertura de la hoja: Clase 1
3. Cierre de la hoja: Clase 2
4. Engate de la herraje de cierre: Clase 2

Categoria alcanzada en la determinación de la resistencia a apertura y cierre repetidos (5000 ciclos): Clase 1 (EN 1191)

Coefficiente de transmisión térmica de hueco de 2 hojas con 4.00 m x 2.40 m con vidrio Ug = 0.7 W/m<sup>2</sup>K con intercalar efecto "Warm Edge":  
 • Uw = 1.48 W/m<sup>2</sup>K

Coefficiente de atenuación acústica de hueco de 2 hojas con vidrio acústico 6/16/44.1:  
 • Rw (C; Ctr) = 34 dB (-1; -6)

Sistema certificado por el laboratorio francés CSTB según las siguientes características:

- Certificado QB49
- Documento de solicitud técnica (DTA) en Bi-rail y Tri-rail, Galandage y tipologías de deslizamiento mínimo con avis technique 6 / 19-2399\_V1.

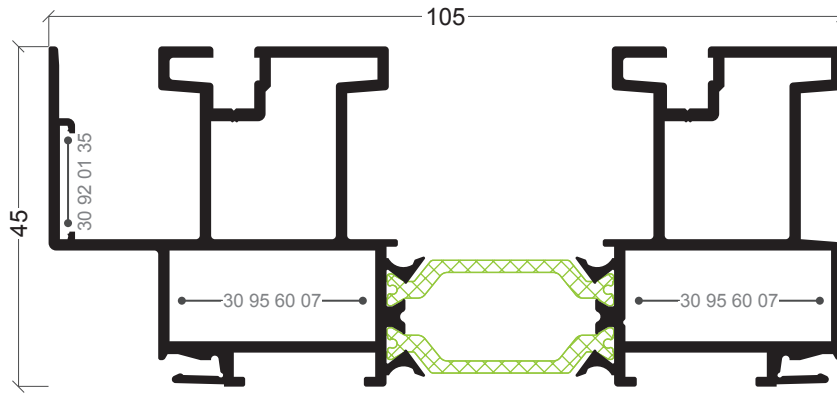

**CW-01**

Aro fixo perimetral  
Marco bicarril con enganches

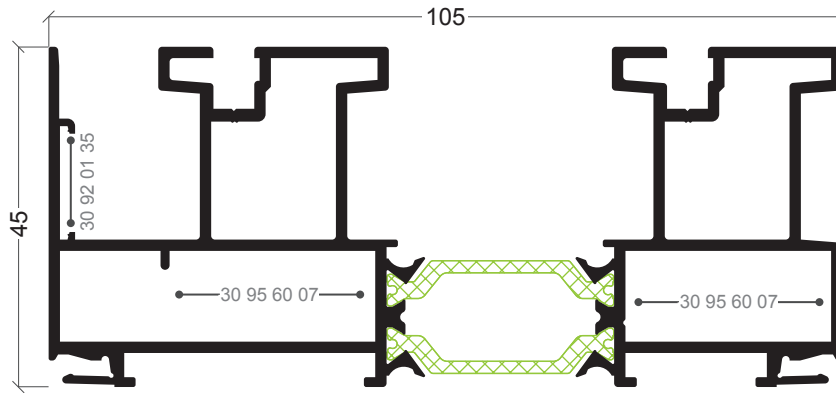

**CW-05**

Aro fixo perimetral  
Marco bicarril con enganches

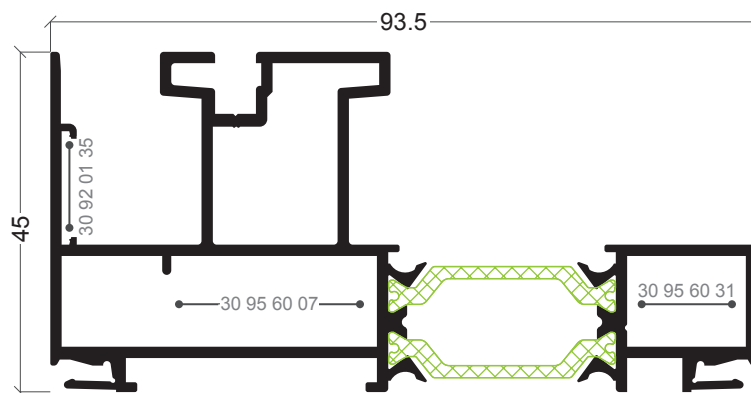

**CW-07**

Aro fixo mono-rail galandage  
Marco mono carril galandage

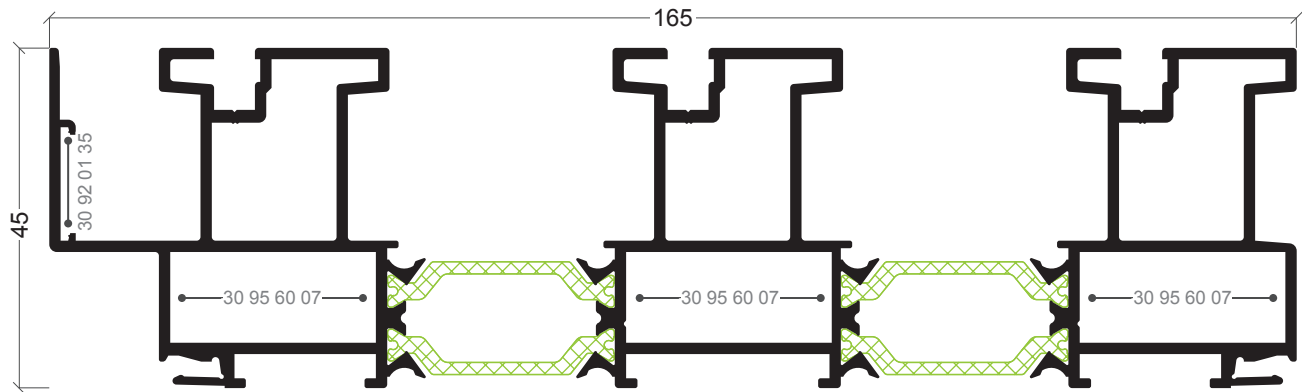

**CW-08**

Aro fixo tri-rail perimetral  
Marco tricarril con enganches

356

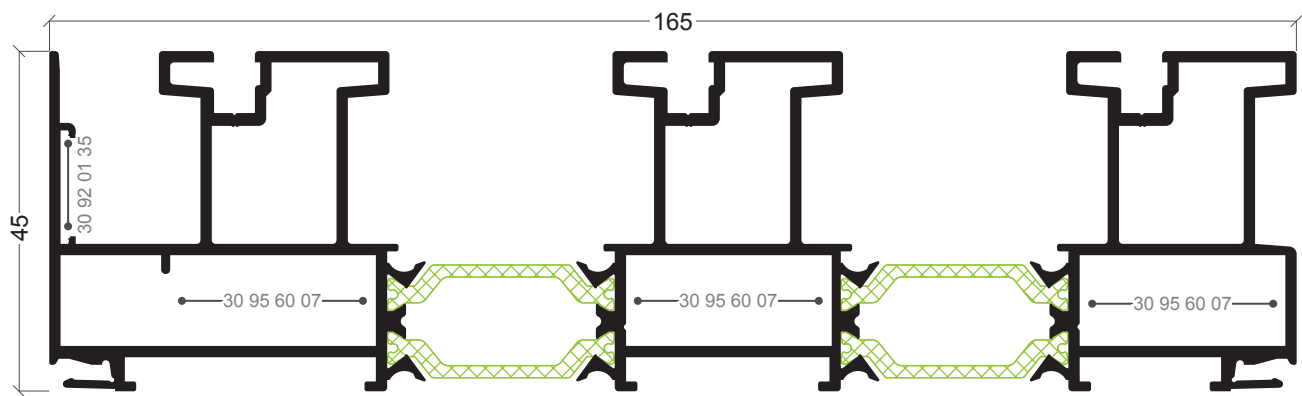

**CW-09**

Aro fixo tri-rail perimetral  
Marco tricarril con enganches

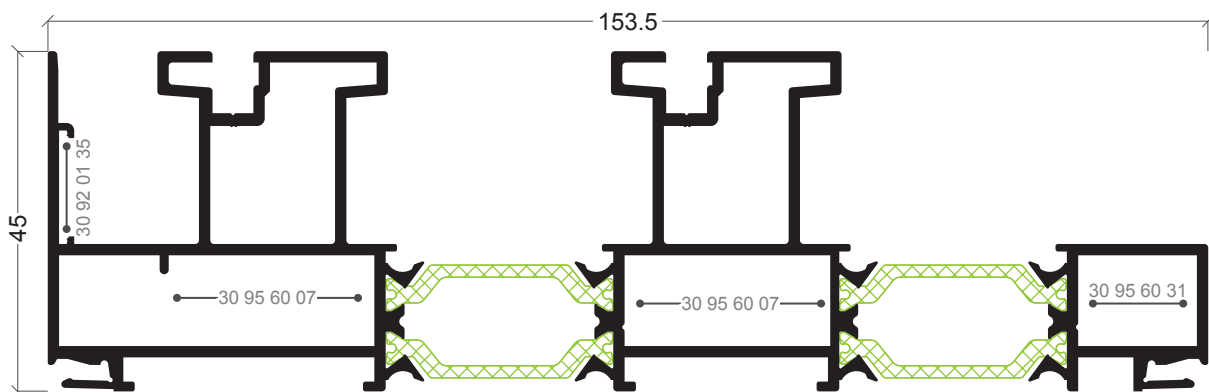

**CW-10**

Aro fixo bi-rail galandage  
Marco bicarril galandage con enganches

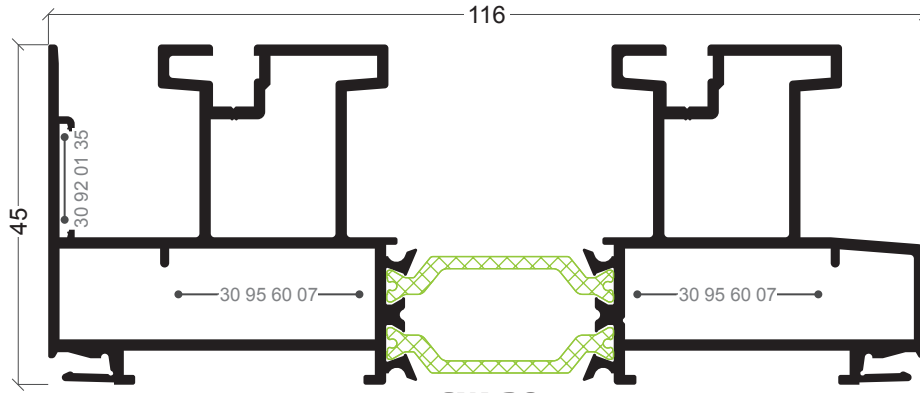

**CW-20**

Aro fixo bi-rail  
Marco bicarril con enganches

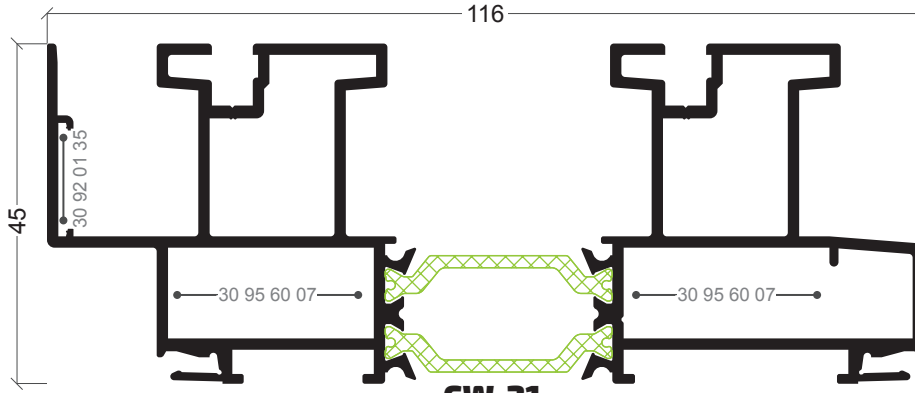

**CW-21**

Aro fixo bi-rail  
Marco bicarril con enganches

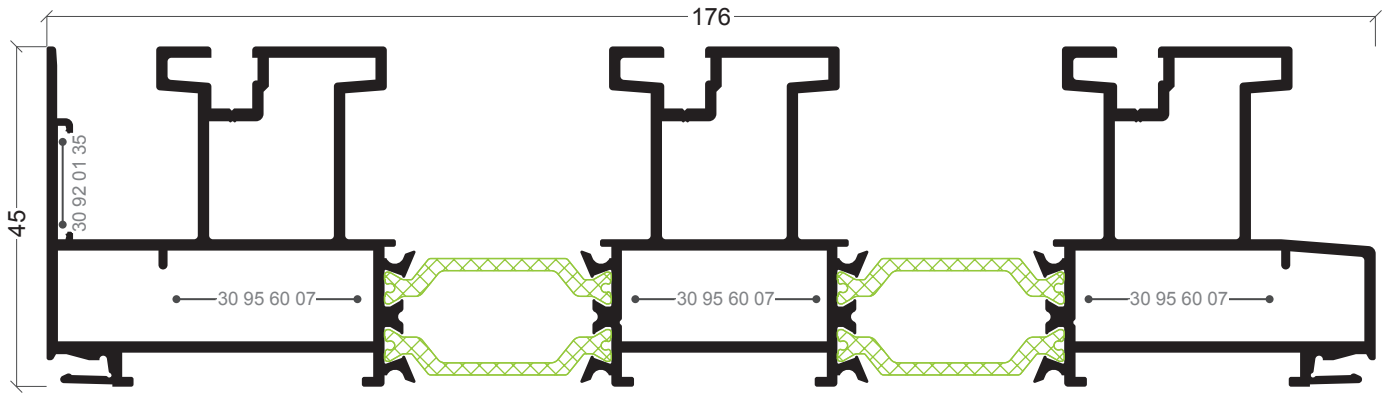

**CW-22**

Aro fixo tri-rail  
Marco tricarril con enganches

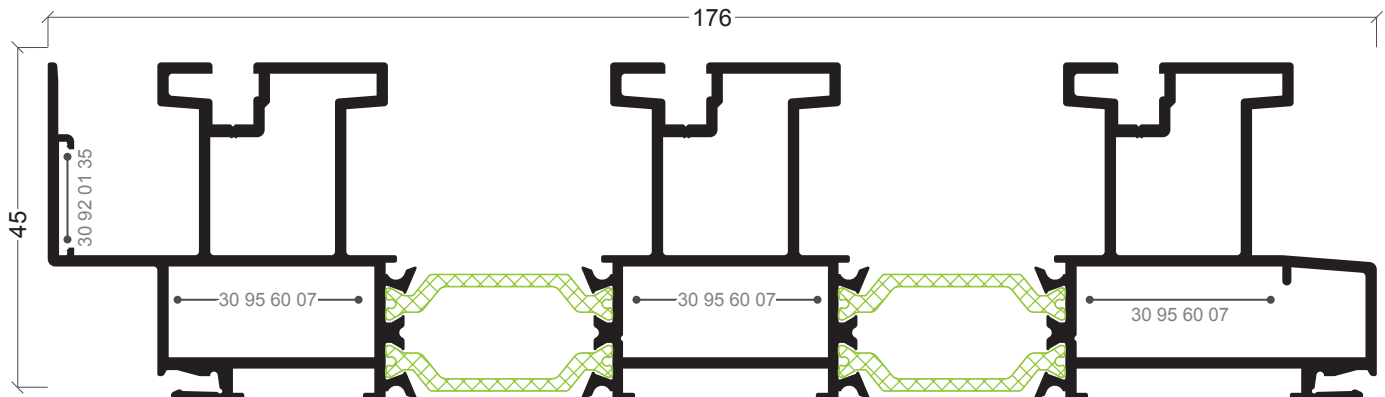

**CW-23**

Aro fixo tri-rail  
Marco tricarril con enganches

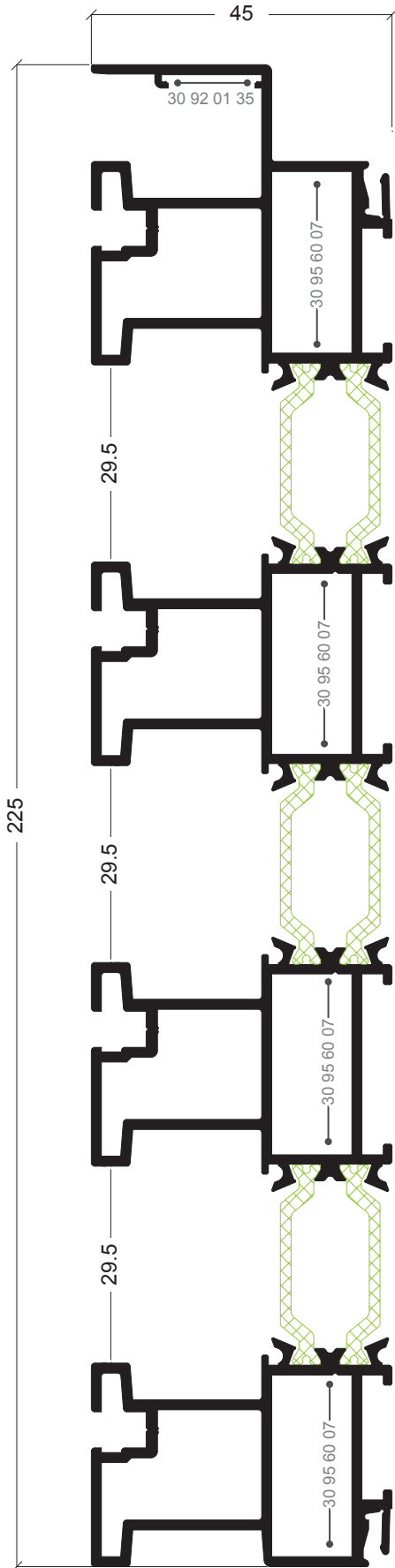

**CW-17**

Soleira Quadri-rail  
Soleira Quadri-rail

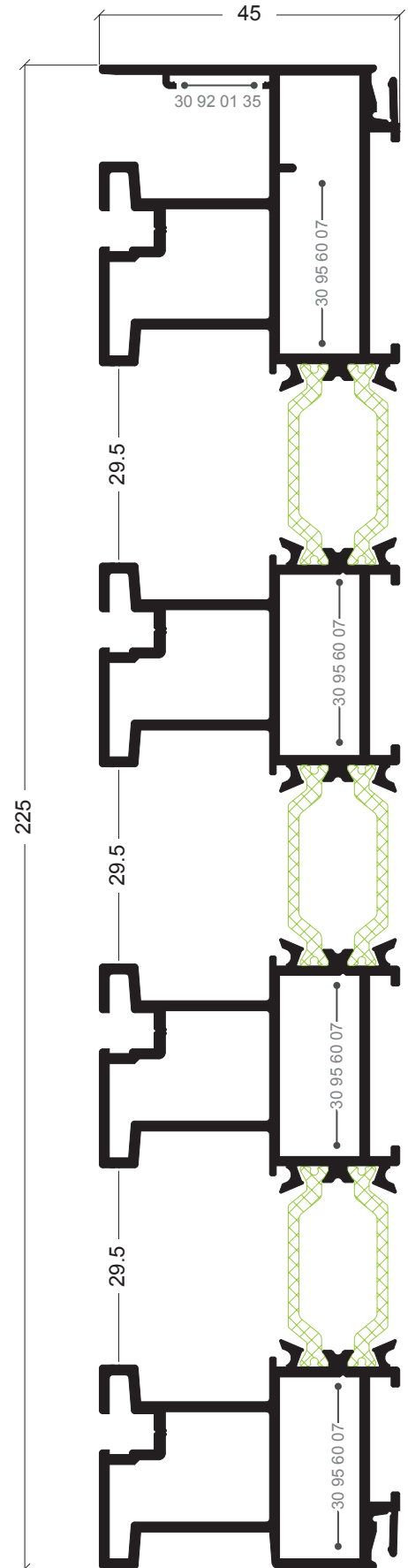

**CW-18**

Soleira Quadri-rail  
Soleira Quadri-rail



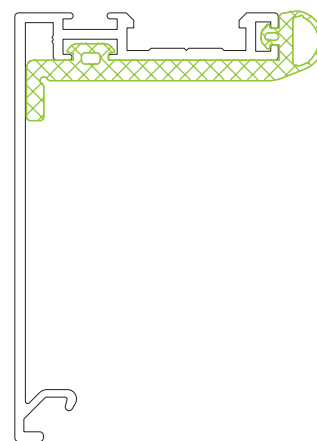
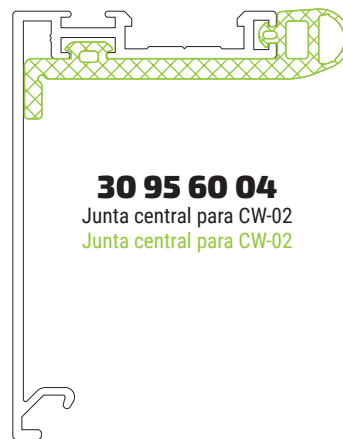
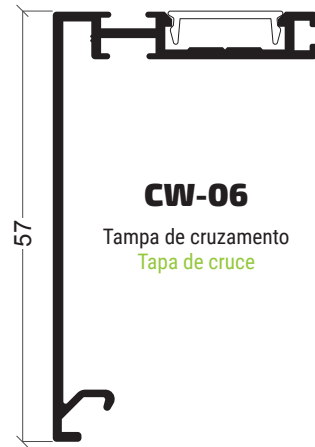
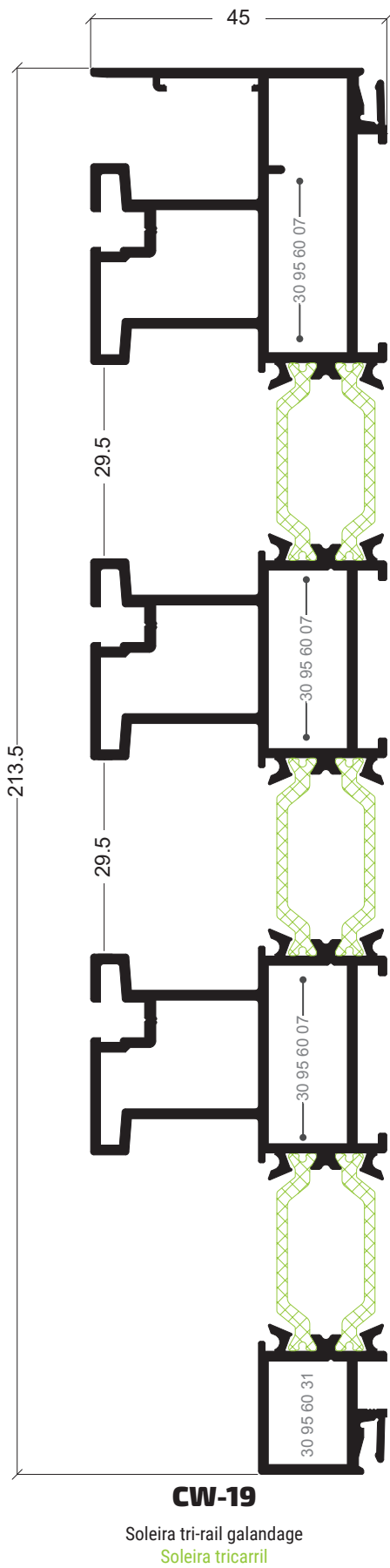

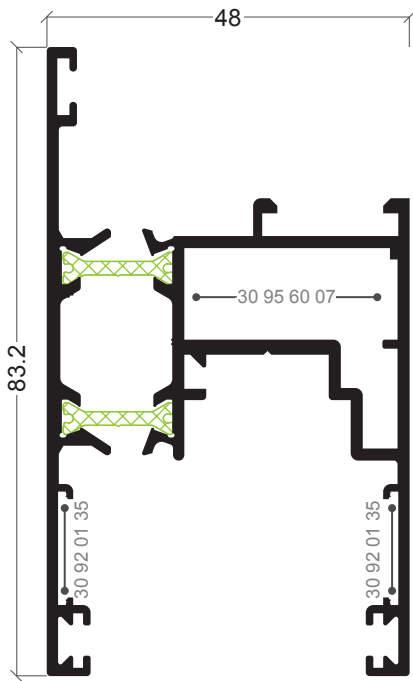

**CW-02**

Aro móvel perimetral  
Hoja perimetral

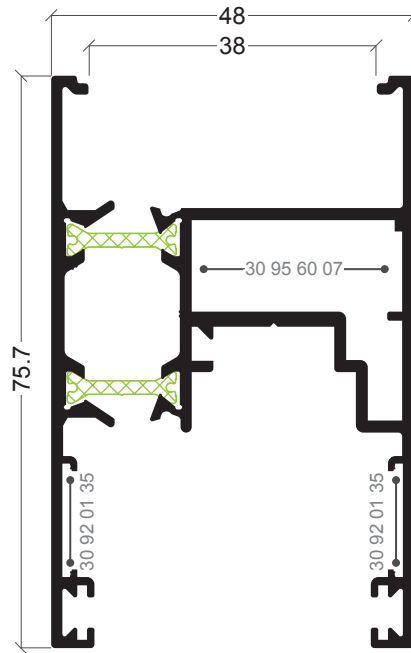

**CW-03**

Aro móvel perimetral  
Hoja perimetral

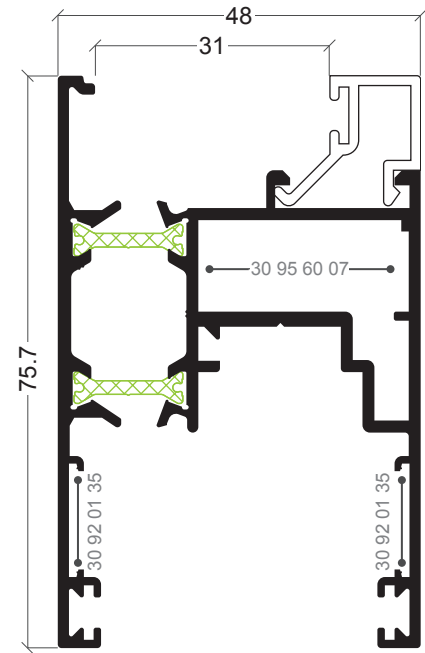

**CW-04**

Aro móvel perimetral  
Hoja perimetral

360

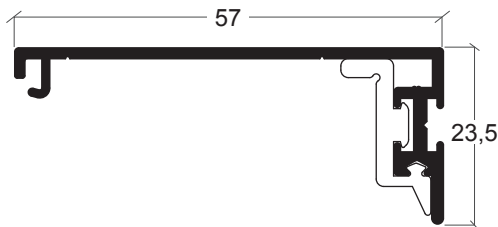

**CW-26**

Tampa de cruzamento CW minimal  
Tope de cruce CW minimal

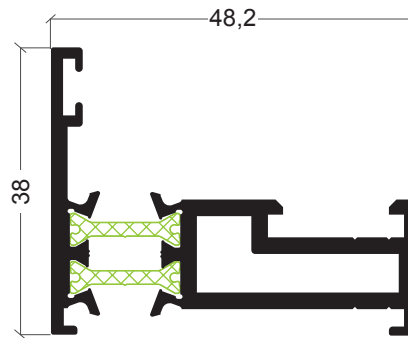

**CW-24**

Prumo Central CW minimal  
Prumo Central CW minimal

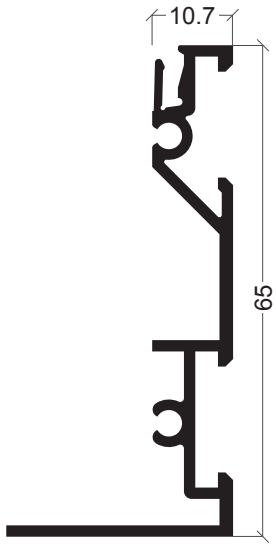

**CW-11**

Remate de isolamento  
Remate de aislamiento

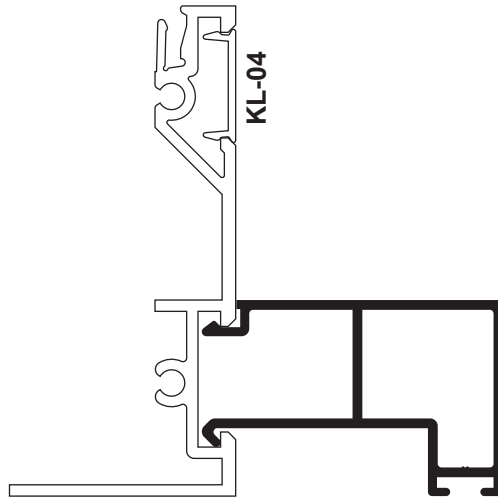

**ARI-48**

Bite  
Junquillo

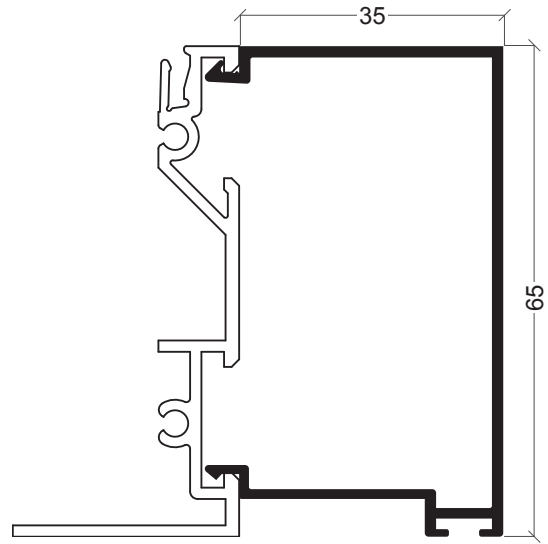

**CW-12**

Remate de Galandage  
Remate de aislamiento

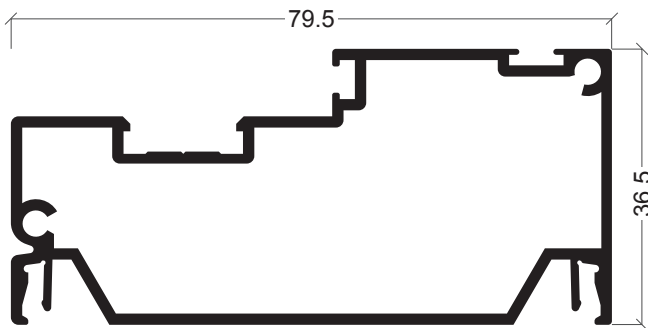

**CW-13**

Prumo de Cruzamento  
Remate de aislamiento

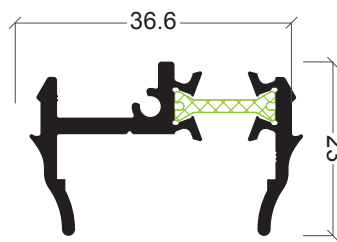

**CTe-09**

Perfil 4 folhas  
Perfil 4 hojas

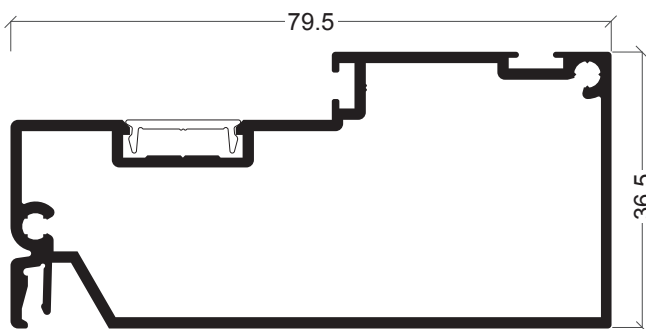

**CW-28**

Prumo de Cruzamento  
Remate de aislamiento

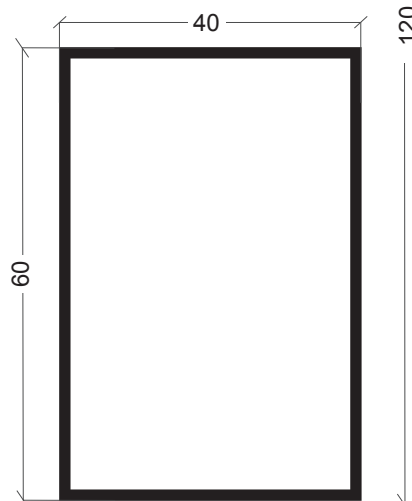

**P-20**

Perfil para gandalage  
Perfil para gandalage

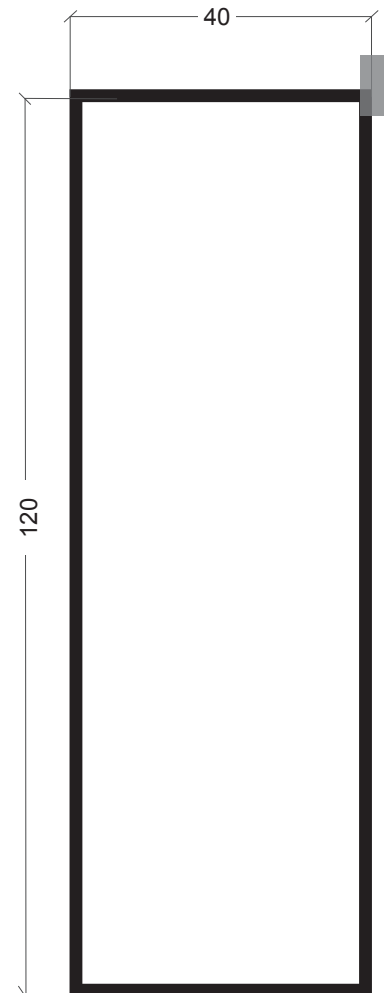

**P-30**

Perfil para gandalage  
Perfil para gandalage

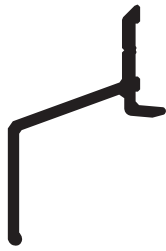

**CT-29**

Pingadeira superior  
Viertaguas superior

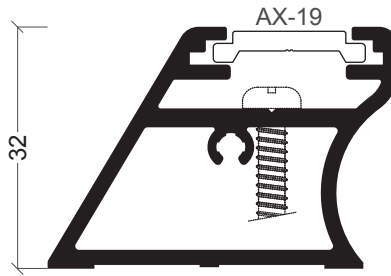

**CT-28**

Reforço  
Refuerzo

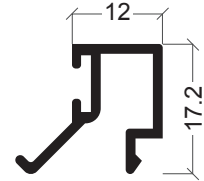

**AX-70**

Bite CW-04  
Junquillo CW-04



**CTe-03**

Perfil guia  
Guia marco carril inf. (AISI 304)



**KL-04**

Perfil complementar  
Perfil tapa central

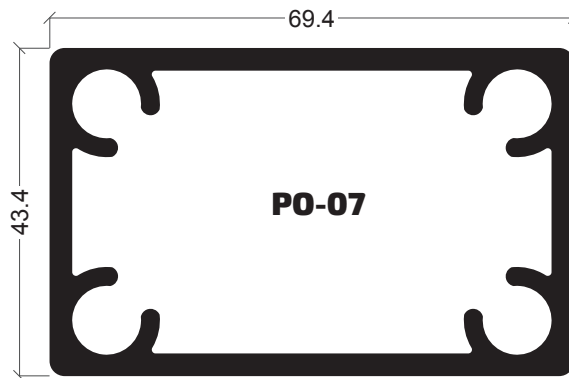

**PO-07**

362



**CT-94**

Perfil união  
Perfil unión



**AX-19**

Vareta  
Varilla

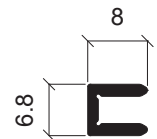

**S-17**

Perfil união  
Perfil Unión



**CW-15**

Tampa  
Tope

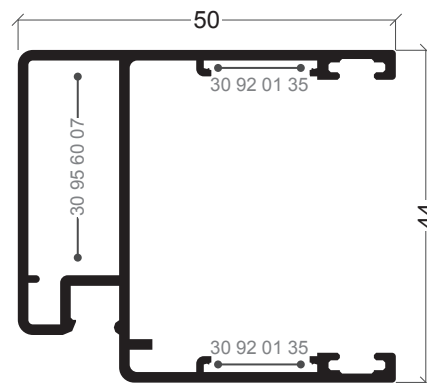

**CW-14**

Perfil para rede mosquiteira  
Perfil para mosquitera

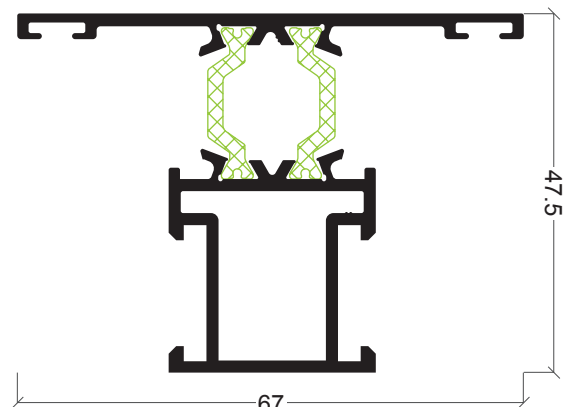

**CW-16**

Travessa  
Travesaño 67x47.5mm

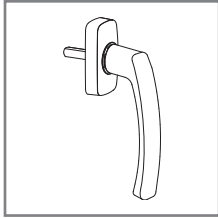

**30 60 16 40/41**

Puxador de alumínio branco/preto  
Manilla de alumínio blanco/negro

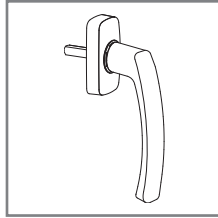

**30 60 16 42/43**

Puxador de alumínio 2 ac/champ ac  
Manilla de alumínio 2 ac/champ ac

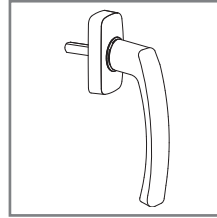

**30 60 16 44**

Puxador de alumínio inox ac  
Manilla de alumínio inox ac

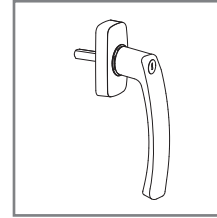

**30 60 16 45/46/47**

Puxador c/ chave de alumínio branco/preto/2AC  
Manilla c/ llave de alumínio blanco/negro/2AC

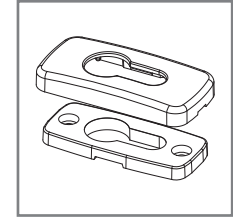

**30 60 16 55/56**

Escudo de alumínio branco/preto  
Espejo de alumínio blanco/negro

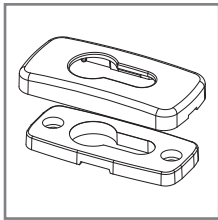

**30 60 16 57/58**

Escudo de alumínio 2 ac/champ ac  
Espejo de alumínio 2 ac/champ ac

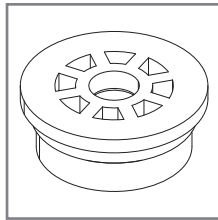

**30 91 20 60**

Canal  
Desague carril inferior

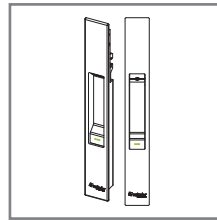

**30 91 40 39/40/41**

Fecho embutir manual (natural/preto/branco)  
Cierre embutir manual (natural/negro/blanco)

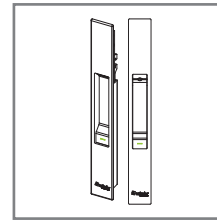

**30 91 40 42/43/44**

Fecho embutir automático (natural/preto/branco)  
Cierre embutir automático (natural/negro/blanco)

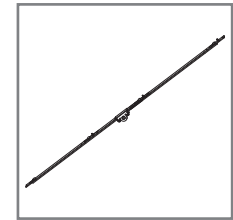

**30 91 41 29**

Barra multiponto 4 pontos (1800 mm)  
Cierre multipunto 4 puntos (1800 mm)

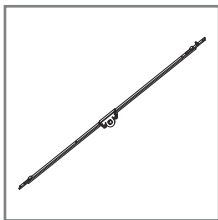

**30 91 41 30**

Barra multiponto 2 pontos (600 mm)  
Cierre multipunto 2 puntos (600 mm)

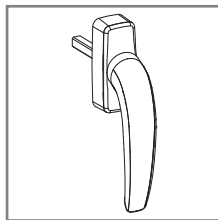

**30 91 41 47/48**

Cremona multiponto (branco/preto)  
Cremona multipunto (blanco/negro)

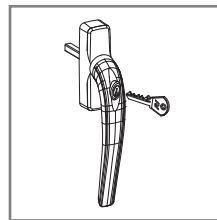

**30 91 41 56/57**

Cremona com chave multiponto (branco/preto)  
Cremona con llave multipunto (blanco/negro)

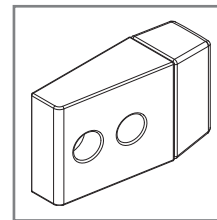

**30 91 41 71**

Topo limitador de abertura  
Tope limitador de apertura

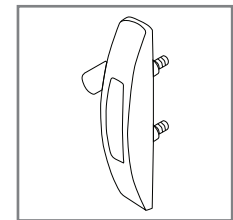

**30 91 42 00/01**

Fecho janela multiponto branco/preto  
Cierre ventana multipunto blanco/negro

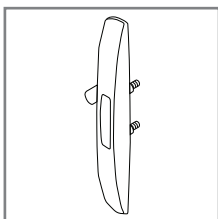

**30 91 42 05/06**

Fecho porta multiponto branco/preto  
Cierre puerta multipunto blanco/negro

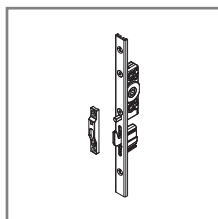

**30 91 42 21**

Barra multiponto inox c/ 2 pontos de fecho  
Barra multipunto inox c/ 2 puntos de cierre

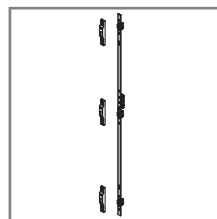

**30 91 42 22**

Barra Multiponto Inox c/ 3 pontos de fecho  
Barra Multipunto Inox c/ 3 puntos de cierre

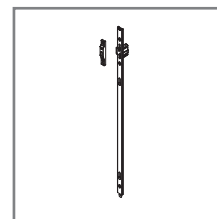

**30 91 42 23**

Extensão superior para multiponto inox  
Extensión superior para multipunto inox

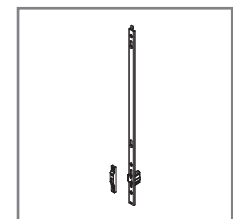

**30 91 42 33**

Extensão inferior para multiponto inox  
Extensión inferior para multipunto inox

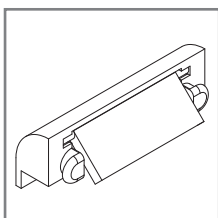

**30 92 01 02/03**

Goteira (preto/branco)  
Tapa salida de aguas con deflector (negro/blanco)

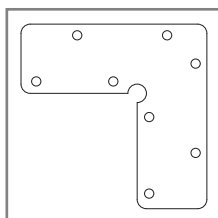

**30 92 01 35**

Esquadro de alinhamento  
CW-01/02/03/04/05/08/09  
Escuadra de alineamiento  
CW-01/02/03/04/05/08/09

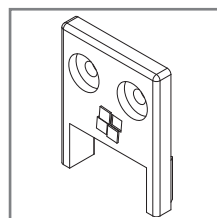

**30 94 50 35**

Tampa guia móvel recta CW-06  
Tope guia hoja recta CW-06

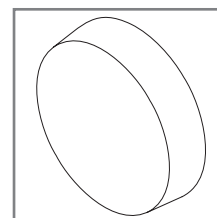

**30 94 50 36**

Tampa preta para parafuso cabeça de queijo 9.3  
Tapa para 30 94 50 35

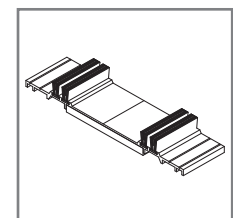

**30 94 50 41**

Cortavento superior elevável  
Cortaviento superior elevable

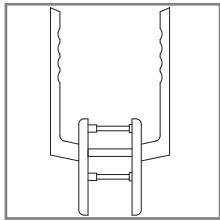

**30 94 52 00/01/02/03**

Puxador duplo para correr-elevatória (natural/preto/inox/branco)  
Manilla doble para corredera elevable (natural/negro/inox/blanco)

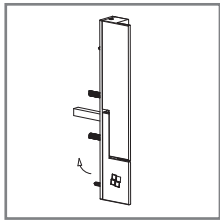

**30 94 60 97/98**

Fecho Minimalista direito branco/preto  
Cierre Minimalista derecho blanco/negro

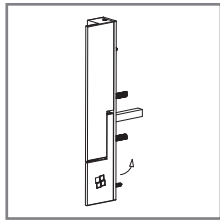

**30 94 60 99/30 94 61 00**

Fecho Minimalista esquerdo branco/preto  
Cierre Minimalista izquierdo blanco/negro

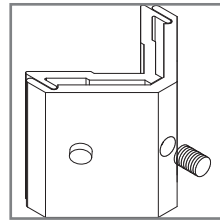

**30 95 60 07**

Esquadro 27x12 mm centrado  
Escuadra 27x12 mm centrada

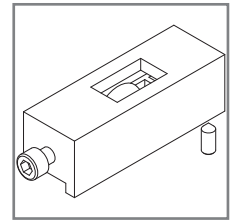

**30 95 60 08**

Rolamento simples regulável CW  
(50 kg por rolamento)  
Rodamiento simple regulable  
(50 kg rodamiento)

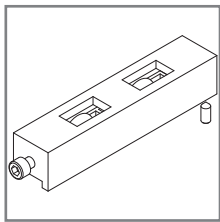

**30 95 60 09**

Rolamento duplo regulável CW  
(100 kg por rolamento)  
Rodamiento doble regulable CW  
(100 kg por rodamiento)

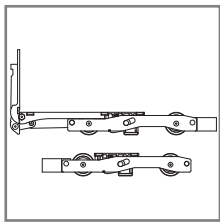

**30 95 60 10**

Conjunto rolamentos elevável 250kg  
Conjunto rodamientos elevable 250kg

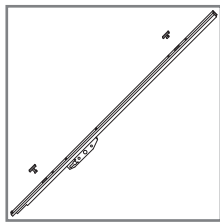

**30 95 60 11**

Ferragem correr/elevatória 170  
Herraje corredera/elevable 170

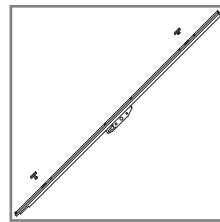

**30 95 60 12**

Ferragem correr/elevatória 220  
Herraje corredera/elevable 220

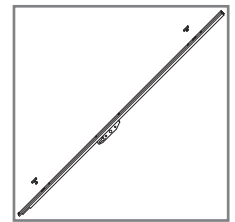

**30 95 60 13**

Ferragem correr/elevatória 260  
Herraje corredera/elevable 260

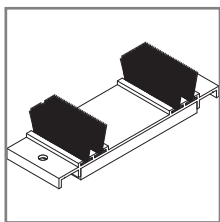

**30 95 60 14**

Corta-vento inferior/superior  
Cortaviento inferior/superior

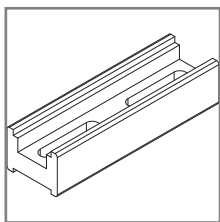

**30 95 60 15**

Calço multiponto nº 4  
Calzo multipunto nº 4

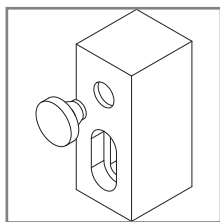

**30 95 60 16**

Batente lateral  
Batiente lateral

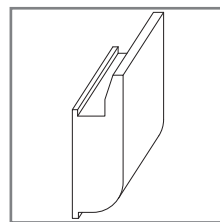

**30 95 60 17**

Guia  
Guía

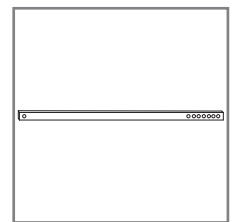

**30 95 60 18/19/20**

Barra de ligação 150/200/250  
Barra de ligación 150/200/250

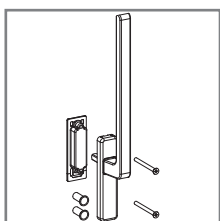

**30 95 60 21/22/23/24/25**

Conjunto puxador elevável  
(natural/preto/inox/bronze)  
Conjunto manilla elevable  
(natural/negro/blanco/inox/bronze)

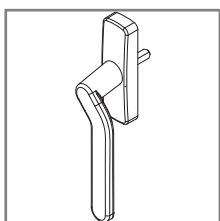

**30 95 60 26/28**

Puxador desviado M-P direito branco/preto  
Manilla desplazado MP derecho blanco/negro

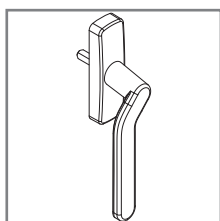

**30 95 60 27/29**

Puxador desviado M-P esquerdo branco/preto  
Manilla desplazado MP izquierdo blanco/negro

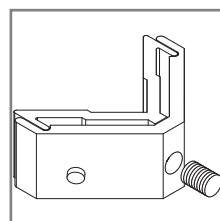

**30 95 60 31**

Esquadro 15x12 mm exterior  
Escuadra 15x12 mm exterior

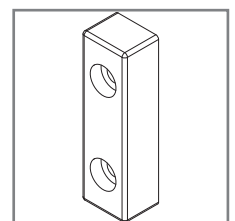

**30 95 60 34**

Calço 3/4 folhas  
Calzo 3/4 hojas

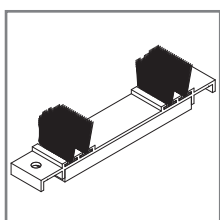

**30 95 60 35**

Corta-vento inferior/superior galadage  
Cortaviento inferior/superior galadage

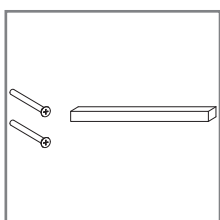

**30 95 60 36**

Conjunto perno + parafuso para puxador multiponto desviado duplo  
Conjunto perno + tornillo para manilla multipunto desplazado doble

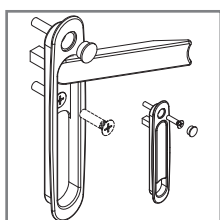

**30 95 60 37/38**

Fecho rotativo multiponto branco/preto  
Cierre rotativo multipunto blanco/negro

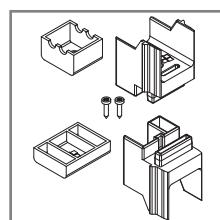

**30 95 60 42**

Topo para CTe-09 4 folhas elevável preto  
Tope para CTe-09 4 hojas corredera elevable

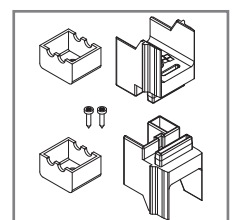

**30 95 60 43**

Topo para CTe-09 4 folhas correr preto  
Tope para CTe-09 4 hojas corredera

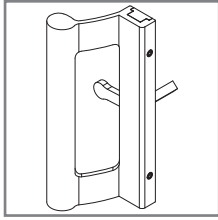

**30 95 60 44/45/46**

Puxador multiponto branco/preto/anodizado natural  
Manilla multipunto blanco/negro/anodizado natural

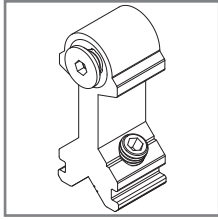

**30 95 60 48**

União travessa interior CW-24  
Unión travessa interior CW-24

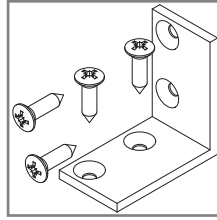

**30 95 60 49**

Canto Exterior CW-24  
Canto Exterior CW-24

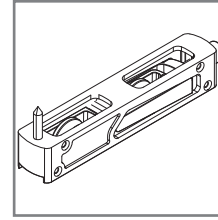

**30 95 60 50**

Rolamentos Duplo Regulável CW(150Kg por rolamento)  
Rodamientos Doble Regulable CW (150Kg por rodamiento)

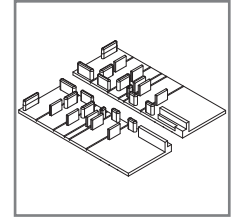

**30 95 60 60**

Conjunto de vedação preto  
Conjunto de vedación negro

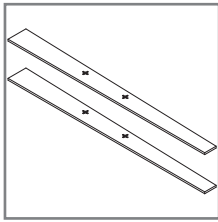

**30 95 60 61**

Conjunto de juntas  
Conjunto de juntas

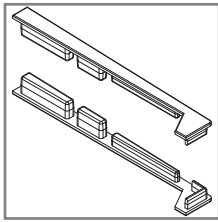

**30 95 60 62**

Conjunto de topos S-36  
Conjunto de topos S-36

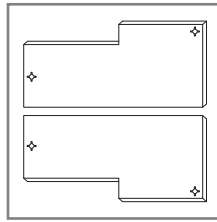

**30 95 60 63**

Conjunto de Juntas de estanqueidade CW-28  
Conjunto de Juntas de estanqueidad CW-28

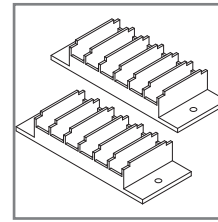

**30 95 60 64**

Conjunto de corta-ventos cw preto  
Conjunto de corta-ventos cw negro

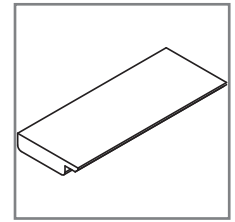

**30 95 60 65**

Suporte p/calço de vidro CW-02/04  
Soporte p/calço de vidrio CW-02/04

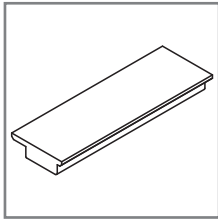

**30 95 60 66**

Suporte p/calço de vidro CW-16  
Soporte p/calço de vidrio CW-16

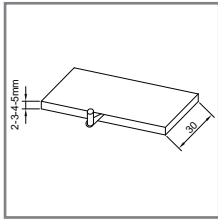

**30 95 60 72/73/74/75**

Calço de vidro 2/30 3/30 4/30 5/30  
Calço de vidrio 2/30 3/30 4/30 5/30

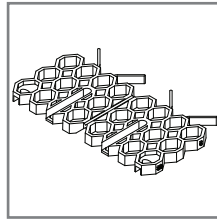

**30 95 60 76**

Suporte BOK para vidro CW-3  
Soporte BOK para vidrio CW-3

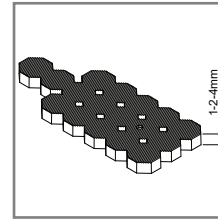

**30 95 60 77/78/79**

Calço BOK para vidro 1mm/2mm/4mm  
Calço BOK para vidrio 1mm/2mm/4mm

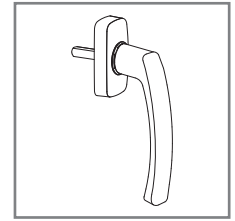

**31 70 16 40**

Puxador de alumínio em bruto  
Manilla de aluminio crudo

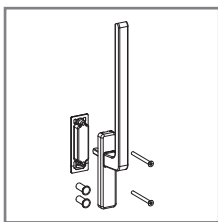

**31 90 85 54**

Conjunto puxador elevável (bruto)  
Conjunto manilla elevable (crudo)

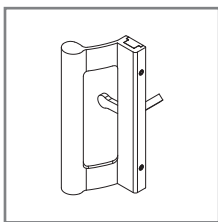

**31 90 85 62**

Asa Multiponto (cores)  
Asa Multipunto (colores)

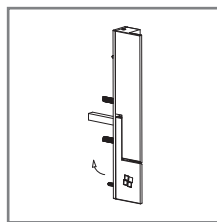

**31 94 60 25**

Fecho Minimalista Direito  
Cierre Minimalista Derecho

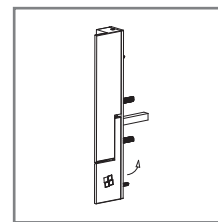

**31 94 60 26**

Fecho Minimalista Esquerdo  
Cierre Minimalista Izquierdo

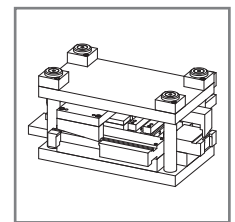





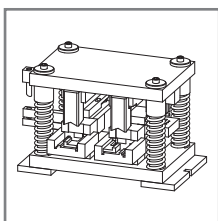





**33 92 29 99**

Cunho CW  
Troquel CW



**33 92 30 00**

Cunho CW minimal  
Troquel CW minimal

REFERÊNCIA • REFERENCIA	DESENHO • DISEÑO	DESCRIÇÃO • DESCRIPCIÓN
30 20 26 03		Junta interior/exterior • Junta interior/exterior
30 93 00 60		Junta exterior do vidro • Junta exterior vidrio
30 93 00 61		Junta vedação exterior vidro 2 mm • Junta estanqueidad exterior vidrio 2 mm
30 93 00 62		Junta plana para vidro • Junta plana para vidrio
30 93 00 65		Junta interior para vidro (5 mm) • Junta interior para vidrio (5 mm)
30 93 00 66		Junta interior para vidro (4 mm) • Junta interior para vidrio (4 mm)
30 93 00 67		Junta interior para vidro (2 mm) • Junta interior para vidrio (2 mm)
30 93 00 68		Junta interior para vidro (6/7 mm) • Junta interior para vidrio (6/7 mm)
30 93 00 69		Junta interior para vidro (8/9 mm) • Junta interior para vidrio (8/9 mm)
30 94 01 46		Junta para CW-13 • Junta para CW-13
30 94 60 12		Pelúcia tri-fin • Burlete tri-fin
30 95 00 10		Pelúcia 7x9 mm • Burlete 7x9 mm
30 95 00 40		Pelúcia 7x5.5 mm • Burlete 7x5.5 mm
30 95 60 01		Junta tapa canal central • Junta tapa canal central
30 95 60 02		Junta tapa canal aro fixo • Junta tapa canal marco
30 95 60 03		Junta vedação aro móvel • Junta estanqueidad hoja
30 95 60 04		Junta central CW-02 • Junta central CW-02
30 95 60 05		Junta central CW-03/04 • Junta central CW-03/04
30 95 60 06		Junta em U para vidro de 30 mm • Junta en U para vidrio de 30 mm
30 95 60 30		Junta isolante CW • Junta aislante CW
30 95 60 47		Junta central CW-24 + CW-26 • Junta central CW-24 + CW-26
30 60 00 17		Junta Exterior vidro plana 2mm preto • Junta exterior vidrio plana 2mm negro
30 94 01 46		Junta interior e exterior • Junta interior e exterior
30 95 00 30		Pelúcia 7x7 FIN • Burlete 7x7 FIN



## Janela 2 folhas correr - Conceito Minimalista

### Ventana 2 hojas corredera - Concepto Minimalista

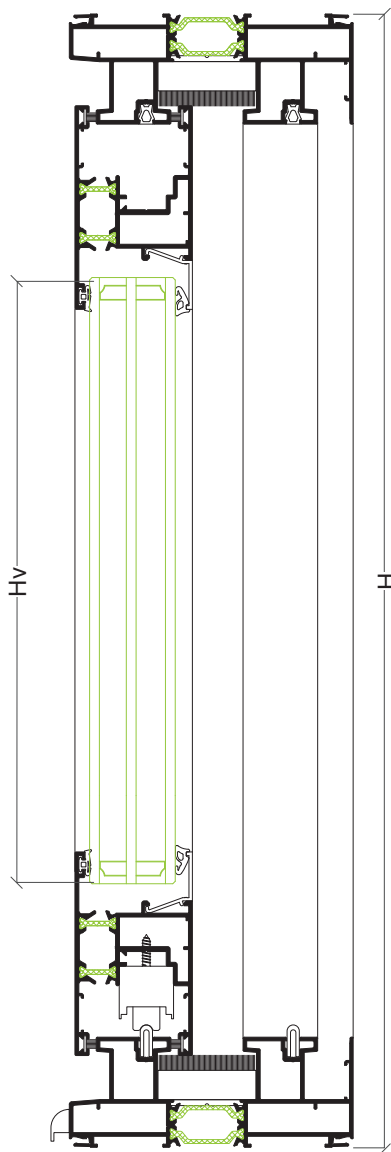
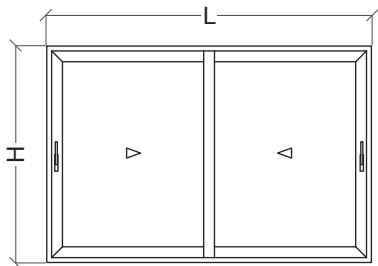

#### PERFIS • PERFIS

DESENHO • DISEÑO	REF.	DESCRIÇÃO • DESCRIPCIÓN	CORTE CORTE	QUANTIDADE CANTIDAD	MEDIDAS • MEDIDA
	CW-20	Aro fixo perimetral • Marco perimetral		2	L
			2	H	
	CW-02	Aro móvel perimetral • Hoja perimetral		4	L/2-38 mm
			2	H-75 mm	
	CW-24	Aro fixo CW Minimal • Marco CW Minimal		2	H-75 mm
	CW-26	Tampa de cruzamento minimal • Tope de cruce minimal		2	H-75 mm
	CTe-03	Perfil guia • Perfil guia		2	L-74 mm
	---	Bite horizontal • Junquillo horizontal		4	L/2-101 mm
	---	Bite vertical • Junquillo vertical		4	H-241.5 mm

#### ACESSÓRIOS E JUNTAS • ACCESORIOS Y JUNTAS

REF.	DESCRIÇÃO • DESCRIPTION	QUANTIDADE CANTIDAD
30 95 60 07	Esquadro • Escuadra	12
30 92 01 35	Esquadro de alinhamento • Escuadra de alineamiento	12
30 95 60 64	Conjunto Corta-vento CW preto • Conjunto de corta-vientos cw negro	1
30 95 60 16	Batente lateral • Batiente lateral	4
30 94 50 35	Tampa guia • Tapa guia	4
30 92 01 02	Goteira com válvula (preto) • Tapa salida de aguas con deflector (negro)	diversas • diversas
30 94 50 36	Tampa parafuso • Tapón tornillo	8
30 95 60 45	Asa Multiponto (preto) • Multicierre (negro)	1
30 95 60 38	Fecho rotativo multiponto preto • Cierre rotativo multicierre negro	1
30 91 41 30	Ferragem multiponto 600mm • Herraje multicierre 600mm	2
30 95 60 15	Calço multiponto nº4 • Calzo multipunto nº4	8
30 91 41 71	Limitador • Limitador	1
30 95 60 09	Rolamento duplo regulável • Doble rodamiento regulable	4
30 95 60 48	União travessa interior CW-24 • Unión travessaño inferior CW-24	4
30 95 60 49	Canto exterior CW-24 • Canto exterior CW-24	4
30 95 00 40	Pelúcia 7x5.5 fin-seal • Burlete 7x5.5 fin-seal	4L+2H
30 95 60 01	Junta tapa canal central • Junta tapa canal central	2L+2H
30 95 60 02	Junta tapa canal • Junta tapa canal	2L+4H
30 95 60 03	Junta de vedação • Junta de estanqueidad	4H
30 95 60 47	Junta central CW-24+CW-26 • Junta central CW-24+CW-26	2H
30 95 60 17	Guia • Guia	12
---	Junta exterior para vidro • Junta exterior para vidrio	2L+4H
---	Junta interior para vidro • Junta interior para vidrio	2L+4H





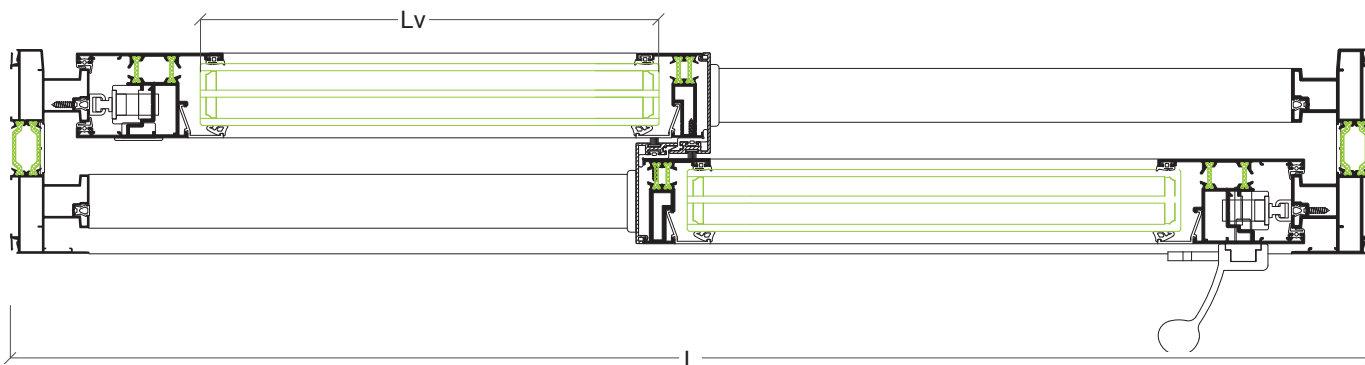





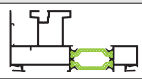



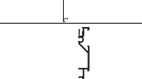

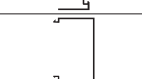

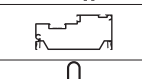





#### VIDRO • VIDRIO

Hv = H-215 mm	Lv = L/2-116 mm
---------------	-----------------

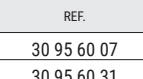

**Porta 1 folha galandage • Puerta 1 hoja galandage**

PERFIS • PERFIS

DESENHO • DESEÑO	REF.	DESCRIÇÃO • DESCRIPCIÓN	CORTE CORTE	QUANTIDADE CANTIDAD	MEDIDAS • MEDIDA
	CW-07	Aro fixo perimetral Marco monocarril galandage		2	(Lx2)+112 mm
	CW-03	Aro móvel perimetral • Hoja perimetral	 	2 2	H+15 mm L+52 mm H-60 mm
	CW-06	Tampa de cruzamento • Tapa de cruce		1	H-60 mm
	CW-11	Remate de isolamento Perfil para aislamiento		1	L+167 mm
	CW-12	Remate de Galandage Remate de aislamiento	 	1 2	H-39 mm L+106 mm L+106 mm
	CW-13	Prumo de cruzamento Remate de aislamiento		1	H-24 mm
	CTe-03	Perfil guia • Perfil guia		1	(Lx2)+38 mm
	KL-04	Perfil tampa central • Perfil tapa central	 	1 1	H-24 mm H-60 mm
	AXi-88	Remate lateral de isolamento exterior Complemento solape		1	(Lx2)+126 mm
	AXi-88	Remate lateral de isolamento interior Complemento solape	 	1 2	H+45 mm L+188 mm H+1.5 mm
	AXi-91	Remate lateral de isolamento interior Complemento solape		1+1	L

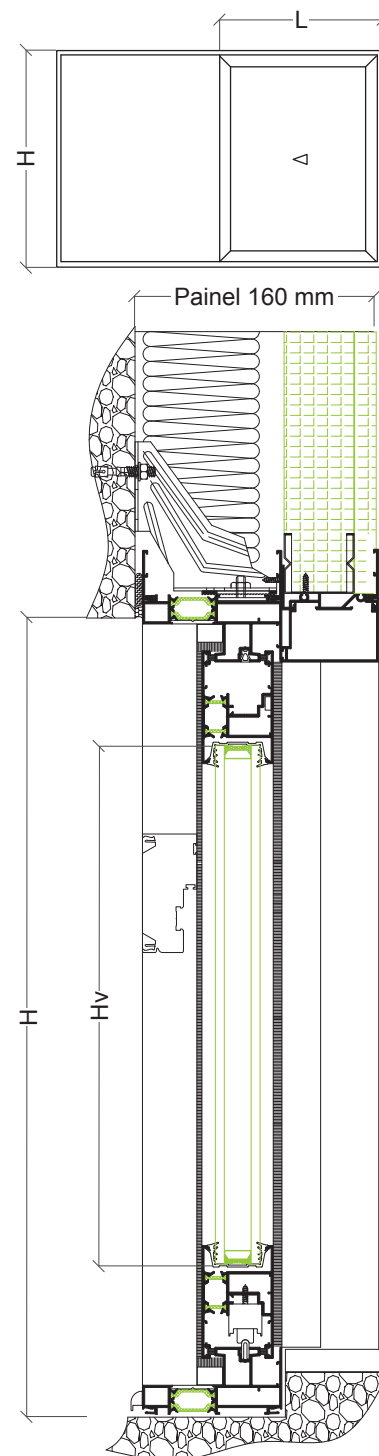

**ACESSÓRIOS E JUNTAS • ACCESORIOS Y JUNTAS**





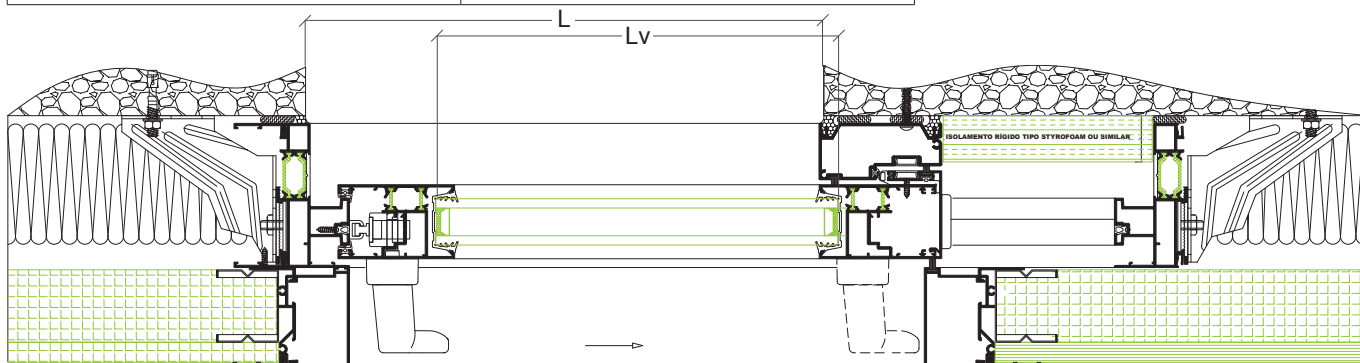

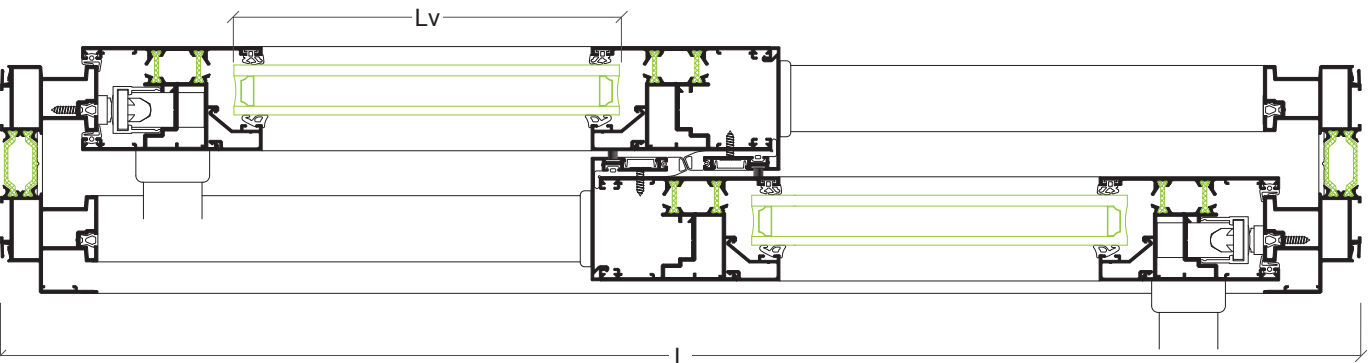
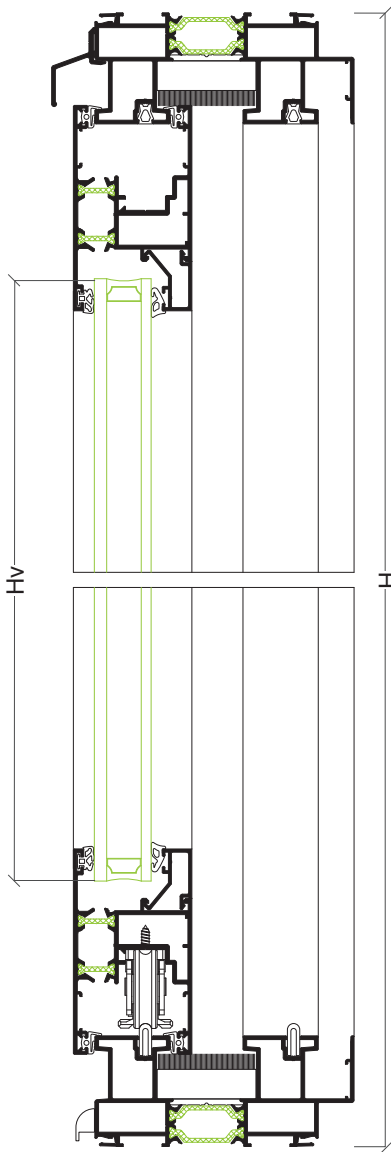
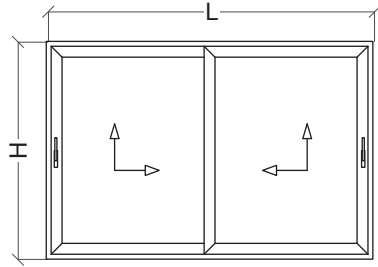



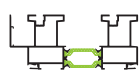







REF.	DESCRIÇÃO • DESCRIPTION	QUANTIDADE • CANTIDAD
30 95 60 07	Esquadro • Escuadra	8
30 95 60 31	Esquadro exterior • Escuadra exterior	4
30 92 01 35	Esquadro alinhamento • Escuadra alineamiento	18
30 95 60 35	Corta-vento inferior/superior mono-rail • Cortaviento inferior/superior monocarril	2
30 95 60 16	Batente lateral • Batiente lateral	2
30 94 50 35	Tampa guia • Tapa guia	2
30 92 01 02	Goteira com válvula (preto) • Tapa salida de agua con deflector (negro)	diversas • diversas
30 91 41 48	Puxador preto • Manilla negro	1
30 95 60 09	Rolamento duplo regulável • Rodamiento doble regulable	2
30 91 41 30	Ferragem multiponto 600 mm • Herraje multipunto 600 mm	2
30 95 60 15	Calço MP nº 4 • Calzo MP nº 4	4
30 95 00 40	Pelúcia 7x5.5 mm fin-seal • Burlete 7x5.5 mm fin-seal	4L+2H
30 95 60 01	Junta tapa-canal central • Junta tapa-canal central	4L+2H
30 95 60 02	Junta tapa-canal • Junta tapa-canal	4L+4H
30 95 60 03	Junta de vedação • Junta de estanqueidad	2H
30 95 60 05	Junta central CW-03/04 • Junta central CW-03/04	H
30 59 60 06	Junta para vidro (30 mm) • Junta para vidrio (30 mm)	2L+2H
30 94 01 46	Junta para CW-13 • Junta para CW-13	H
30 95 00 10	Pelúcia 7x9 mm • Burlete 7x9 mm	H
30 94 01 46	Junta para CW-13 • Junta para CW-13	H
30 95 60 17	Guia • Guia	6
30 91 20 60	Canal • Desaque carril inferior	2
30 95 60 63	Conjunto de Juntas de estanqueidad • Conjunto de Juntas de estanqueidad	1

**VIDRO • VIDRIO**

Hv = H-186 mm	Lv = L-75 mm
---------------	--------------



**Porta 2 folhas correr elevável • Puerta 2 hojas corredera elevadora**

**PERFIS • PERFIS**

DESENHO • DISEÑO	REF.	DESCRIÇÃO • DESCRIPCIÓN	CORTE CORTE	QUANTIDADE CANTIDAD	MEDIDAS • MEDIDA
	CW-01	Aro fixo perimetral Marco perimetral con recogida		2	L
				2	H
	CW-02	Aro móvel perimetral • Hoja perimetral		4	L/2+2 mm
				4	H-75 mm
	CW-06	Tampa de cruzamento • Tapa de cruce		2	H-75 mm
	CTe-03	Perfil guia • Perfil guia		2	L-74 mm
	CT-29	Pingadeira • Vientaguas superior		1	L
	KL-04	Perfil tampa central • Perfil tapa central		2	H-75 mm
	---	Bite horizontal • Junquillo horizontal		4	L/2-124.5 mm
	---	Bite vertical • Junquillo vertical		4	H-241.5 mm











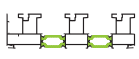

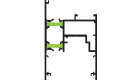



**ACESSÓRIOS E JUNTAS • ACCESORIOS Y JUNTAS**

REF.	DESCRIÇÃO • DESCRIPTION	QUANTIDADE CANTIDAD
30 95 60 07	Esquadro • Escuadra	16
30 92 01 35	Esquadro de alinhamento • Escuadra de alineamiento	20
30 95 60 14	Corta-vento inferior • Cortaviento inferior/superior	1
30 94 50 41	Corta-vento superior (elevável) • Corta viento superior (elevable)	1
30 94 50 35	Tampa guia • Tapa guía	4
30 92 01 02	Goteira com válvula (preto) • Tapa salida de aguas con deflector (negro)	diversas • diversas
30 95 60 XX	Ferragem correr/elevatória • Ferrage correr/elevable	2
30 95 60 10	Conjunto rolamentos elevável • Conjunto rodamientos elevable	2
30 95 60 XX	Conjunto puxador elevável • Conjunto manilla elevable	2
30 95 60 XX	Barra de ligação • Bar de ligación	2
30 91 41 71	Limitador • Tope limitador de apertura	1
30 95 00 40	Pelúcia 7x5.5 mm fin-seal • Burlete 7x5.5 mm fin-seal	2H
30 95 60 01	Junta tapa-canal central • Junta tapa-canal central	2L+2H
30 95 60 02	Junta tapa-canal • Junta tapa-canal	2L+4H
30 95 60 03	Junta de vedação • Junta de estanqueidad	4L+4H
30 95 60 04	Junta central CW-02 • Junta central CW-02	2H
---	Junta exterior para vidro • Junta exterior para vidrio	2L+4H
---	Junta interior para vidro • Junta interior para vidrio	2L+4H
30 95 60 16	Batente Lateral • Praticable Lateral	2
30 95 60 17	Guia • Guía	12

**VIDRO • VIDRIO**

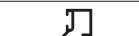
Hv = H-215 mm	Lv = L/2-138 mm
---------------	-----------------

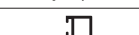
**Porta 3 folhas correr tri-rail • Puerta 3 hojas corredera 3 carriles**
**PERFIS • PERFIS**

DESENHO • DISEÑO	REF.	DESCRIÇÃO • DESCRIPCIÓN	CORTE CORTE	QUANTIDADE CANTIDAD	MEDIDAS • MEDIDA
	CW-09	Aro fixo tri-rail perimetral • Marco tricarril		2	L
				2	H
	CW-02	Aro móvel perimetral • Hoja perimetral		6	L/3+28 mm
				6	H-75 mm
	CW-06	Tampa de cruzamento • Tapa de cruce		4	H-75 mm
	CTe-03	Perfil guia • Guia marco carril inferior		3	L-74 mm
	CT-29	Pingadeira • Vientaguas superior		1	L
	KL-04	Perfil tampa central • Perfil tapa central		4	H-75 mm
	---	Bite horizontal • Junquillo horizontal		6	L/3-98.5 mm
	---	Bite vertical • Junquillo vertical		6	H-241.5 mm

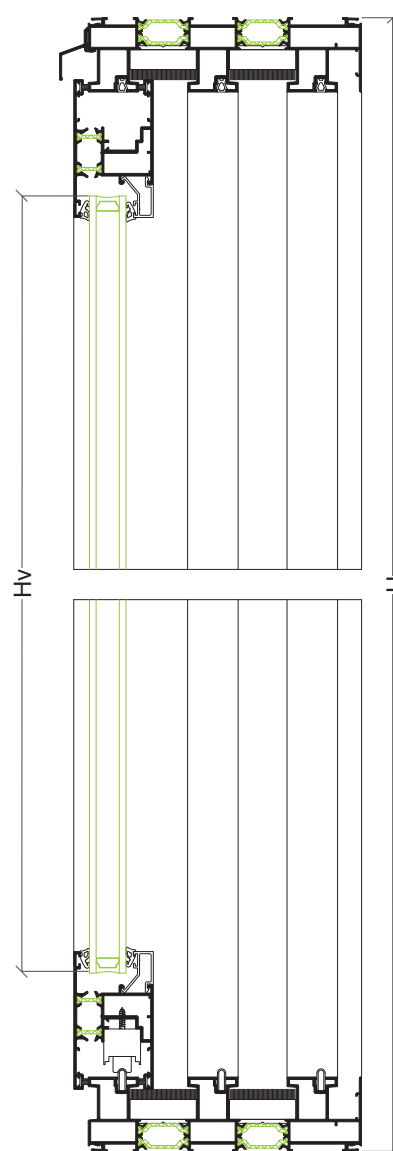
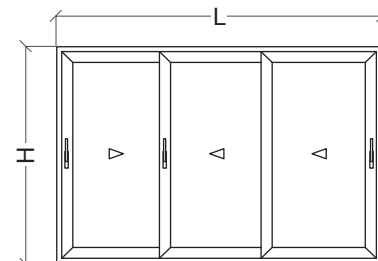
**ACESSÓRIOS E JUNTAS • ACCESORIOS Y JUNTAS**

REF.	DESCRIÇÃO • DESCRIPTION	QUANTIDADE CANTIDAD
30 95 60 07	Esquadro • Escuadra	24
30 92 01 35	Esquadro de alinhamento • Escuadra de alineamiento	28
30 95 60 14	Corta-vento inferior/superior • Cortaviento inferior/superior	4
30 95 60 16	Batente lateral • Batiente lateral	4
30 94 50 35	Tampa guia • Tapa guía	8
30 92 01 02	Goteira com válvula (preto) • Tapa salida de aguas con deflector (negro)	diversas • diversas
30 95 60 29	Puxador desviado esquerdo (preto) • Manilla desplazado izquierdo (negro)	1
30 95 60 28	Puxador desviado direito (preto) • Manilla desplazado derecho (negro)	1
30 91 41 30	Ferragem multiponto 600 mm • Herraje multipunto 600 mm	2
30 95 60 15	Calço MP nº 4 • Calzo MP nº 4	8
30 91 41 71	Limitador • Tope limitador de apertura	2
30 95 60 09	Rolamento duplo regulável • Rodamiento doble regulable	6
30 95 00 40	Pelúcia 7x5.5 mm fin-seal • Bulete 7x5.5 mm fin-seal	4H+4L
30 95 60 01	Junta tapa-canal central • Junta tapa-canal central	4L+4H
30 95 60 02	Junta tapa-canal • Junta tapa-canal	3L+6H
30 95 60 03	Junta de vedação • Junta de estanqueidad	4H
30 95 60 04	Junta central CW-02 • Junta central CW-02	4H
---	Junta exterior para vidro • Junta exterior para vidrio	2L+6H
---	Junta interior para vidro • Junta interior para vidrio	2L+6H
30 95 60 17	Guia • Bisagra	18

**VIDRO • VIDRIO**

Hv = H-215 mm	Lv = L/3-113 mm
---------------	-----------------

