

Sistema

CW

Sistema CW

Sistema de correr com RPT - 105 mm

Características do sistema

Sistema de alumínio com rotura térmica para executar vãos de correr.

Perfis de alumínio

Os perfis de alumínio são extrudidos na liga de alumínio 6060 para arquitetura de acordo com norma NP EN 12020-02.

Perfis com rotura térmica obtida por inserção de varetas isolantes de poliamida de 6.6 mm reforçadas com 25% de fibra de vidro de 30 mm nos aros fixos e de 14.6 mm nos aros móveis.

Espessura média dos perfis de alumínio de 1.5 mm.

Aros fixos

Secção do aro fixo perimetral de 2 guias de 105 mm para montagem a meia esquadria;

Perfil guia de deslizamento inferior em aço inoxidável AISI 304 para evitar desgaste das peças.

Aros móveis

Secção dos aros móveis perimetrais de 48 mm com montagem a meia esquadria;

Enchimento de 4 a 36 mm;

Aros móveis de linha recta com ou sem bite ou com bite reduzido;

Bites rectos;

Estanquidade assegurada através de juntas em EPDM e pelúcia tipo Fin-Seal.

Dimensionamento e manobralidade

Dimensões mínimas - máximas de folha: 300 mm - 2500 mm (L); 350 mm - 2675 mm (H);

Peso máximo de 200 kg por folha (com 2 rolamentos duplos);

Tipologias de 2, 3, 4 e 6 folhas móveis e/ou fixas;

Tipologias de correr Galandage de 1 ou 2 folhas;

Rolamento duplo oscilante com regulação;

Rolamentos de agulhas em inox com eixo temperado retificado sendo possível a substituição sem desmontagem da folha;

Suporte exterior com tratamento cataforese (anti-corrosivo);

Abertura do vão com fecho lateral ou ferragem multi-ponto com 2 ou 4 pontos de fecho;

Puxadores desviados (esquerdo ou direito) para ferragem multi-ponto permitindo maior facilidade de abertura;

Possibilidade de aplicação de ferragem elevatória de média dimensão;

Puxador específico para ferragem elevatória de modo a facilitar as manobras de abertura e fecho do vão;

Existe a opção de puxador duplo com colocação de canhão com chave para permitir a abertura do vão pelo exterior.

Performances

Sistema certificado por laboratório notificado para Ensaio Tipo Inicial (ITT) de acordo com a norma de produto EN 14351-1 para efeitos de Marcação CE.

Categorias alcançadas na avaliação do sistema CW tipologia janela:

1. Permeabilidade ao ar: Classe 3 (norma de ensaio EN 1026)
2. Estanquidade à água: Classe 7A (norma de ensaio EN 1027)
3. Resistência ao vento: Classe C5 (norma de ensaio EN 12211)

Categorias alcançadas na avaliação do sistema CW tipologia porta:

1. Permeabilidade ao ar: Classe 3 (norma de ensaio EN 1026)
2. Estanquidade à água: Classe 6A (norma de ensaio EN 1027)
3. Resistência ao vento: Classe B3 (norma de ensaio EN 12211)

Categorias alcançadas na avaliação do sistema CW tipologia porta elevatória:

1. Permeabilidade ao ar: Classe 4 (norma de ensaio EN 1026)
2. Estanquidade à água: Classe 7A (norma de ensaio EN 1027)
3. Resistência ao vento: Classe C3 (norma de ensaio EN 12211)

Categorias alcançadas na avaliação do sistema CW para determinação das forças de manobra (EN 12046):

1. Libertação da ferragem de fecho: Classe 2
2. Abertura da folha: Classe 1
3. Fecho da folha: Classe 2
4. Engate da ferragem de fecho: Classe 2

Categoria alcançada na determinação da resistência a abertura e fecho repetidos (5000 ciclos): Classe 1 (EN 1191)

Coeficiente de transmissão térmica de vão de 2 folhas com 4.0 m x 2.4 m com vidro $U_g = 0.7 \text{ W/m}^2\text{K}$, com intercalar efeito "Warm Edge":

• $U_w = 1.48 \text{ W/m}^2\text{K}$

Coeficiente de atenuação acústica de vão de 2 folhas com vidro acústico 6/16/44.1:

• $R_w (C; C_{tr}) = 34 \text{ dB} (-1; -6)$

Zonas de aplicação segundo RCCTE (em função do valor U_g): I1, I2, I3, V1, V2, V3.

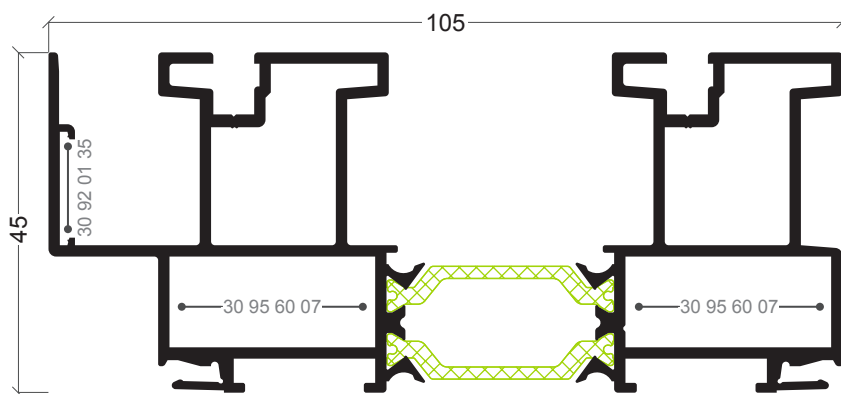

CW-01
Aro fixo perimetral

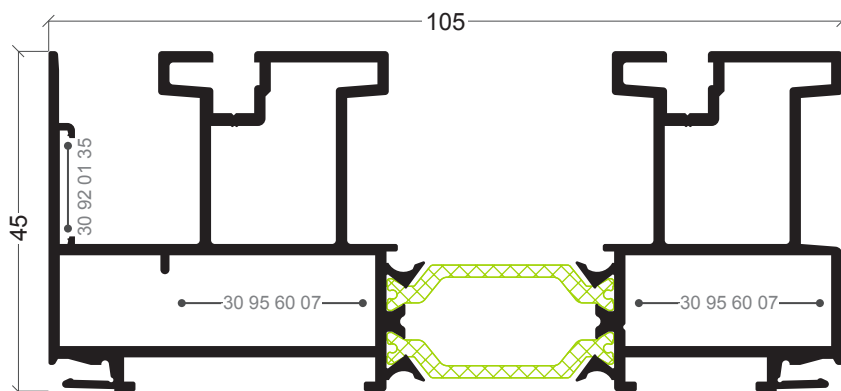

CW-05
Aro fixo perimetral

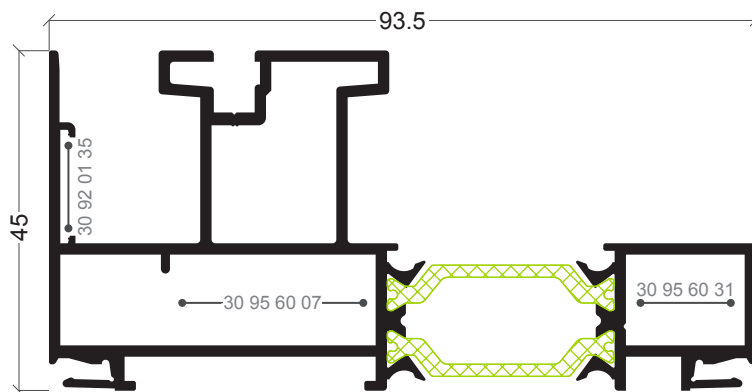

CW-07
Aro fixo mono-rail galandage

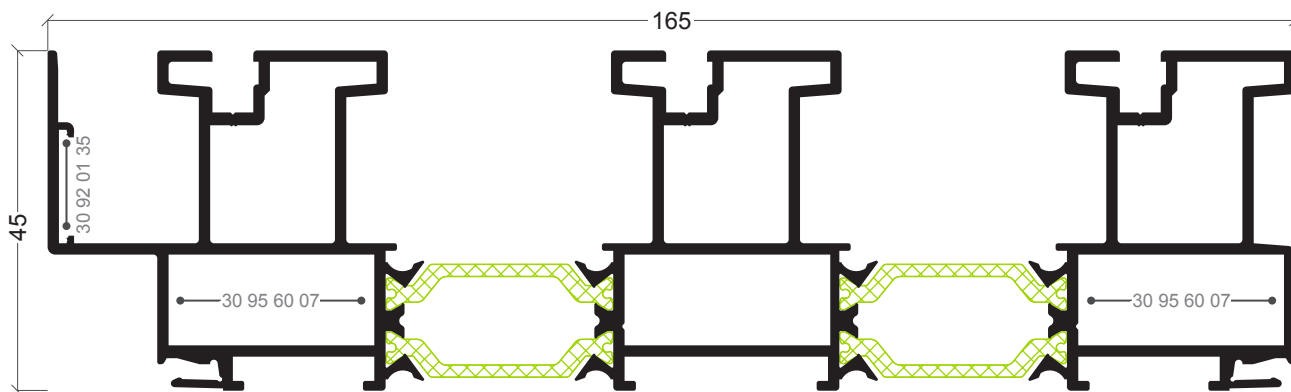

CW-08
Aro fixo tri-rail perimetral

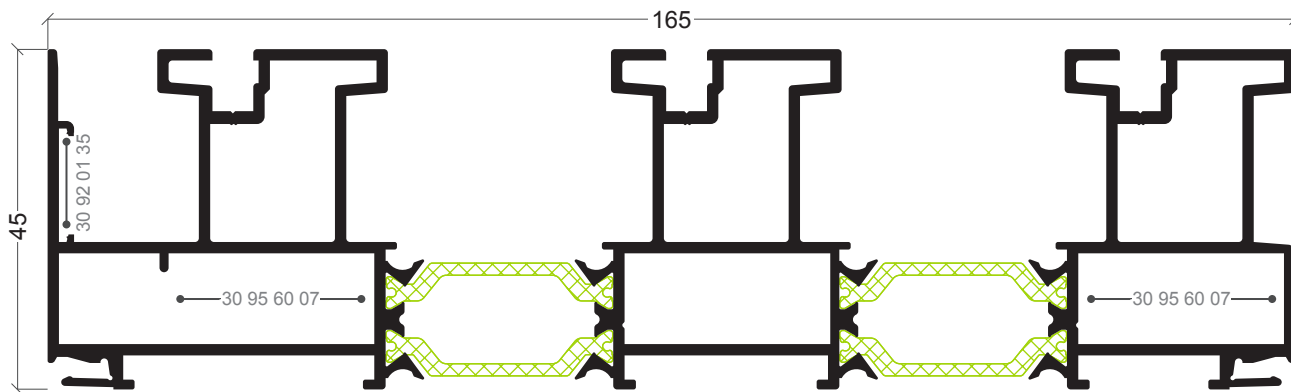

CW-09
Aro fixo tri-rail perimetral

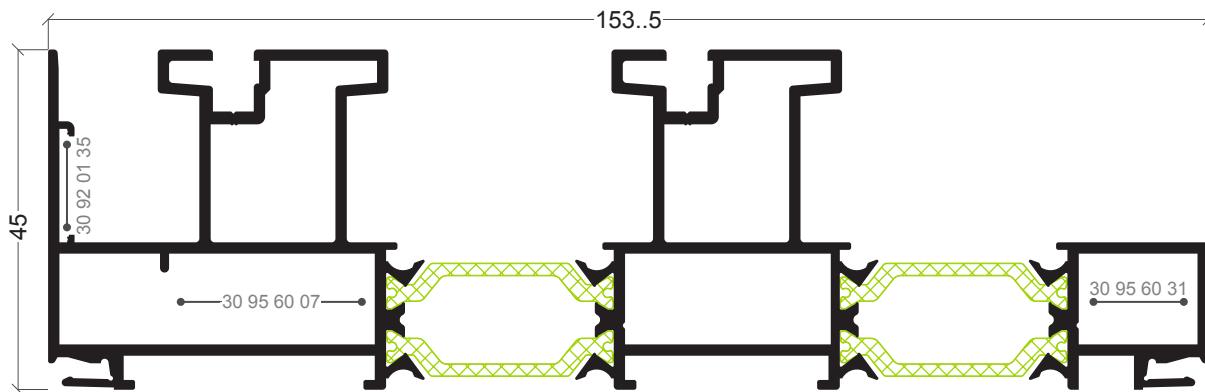

CW-10
Aro fixo bi-rail galandage

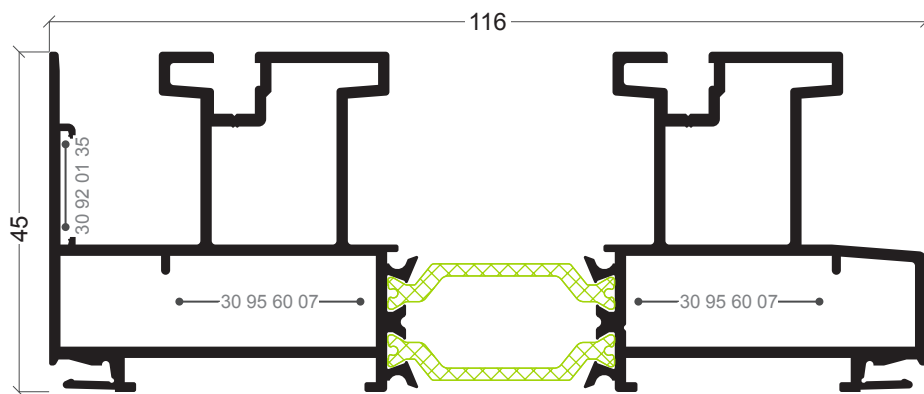

CW-20
Aro fixo bi-rail

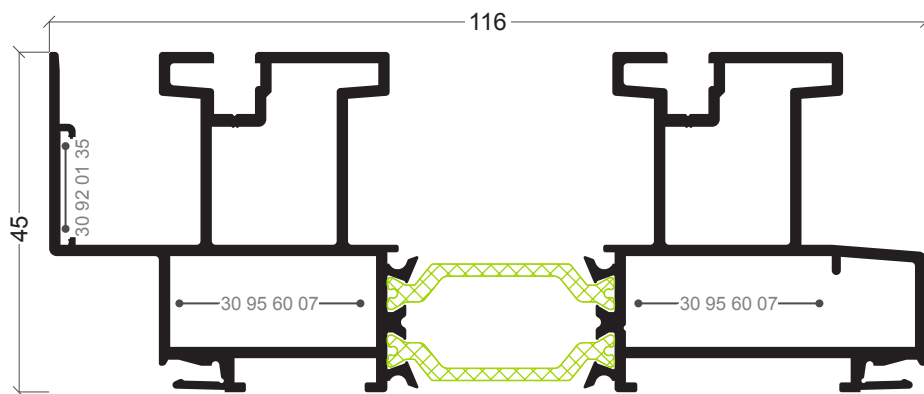

CW-21
Aro fixo bi-rail

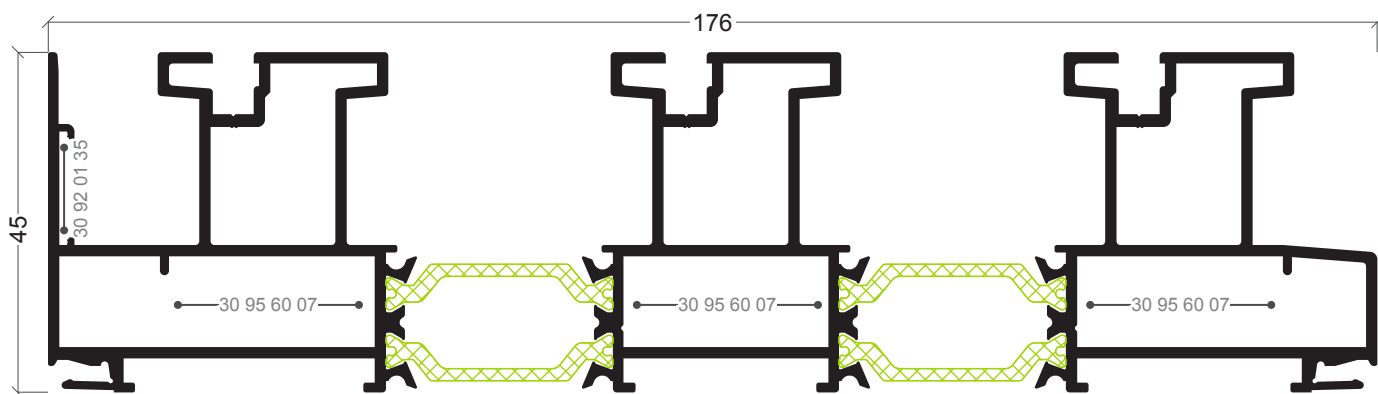

CW-22
Aro fixo tri-rail

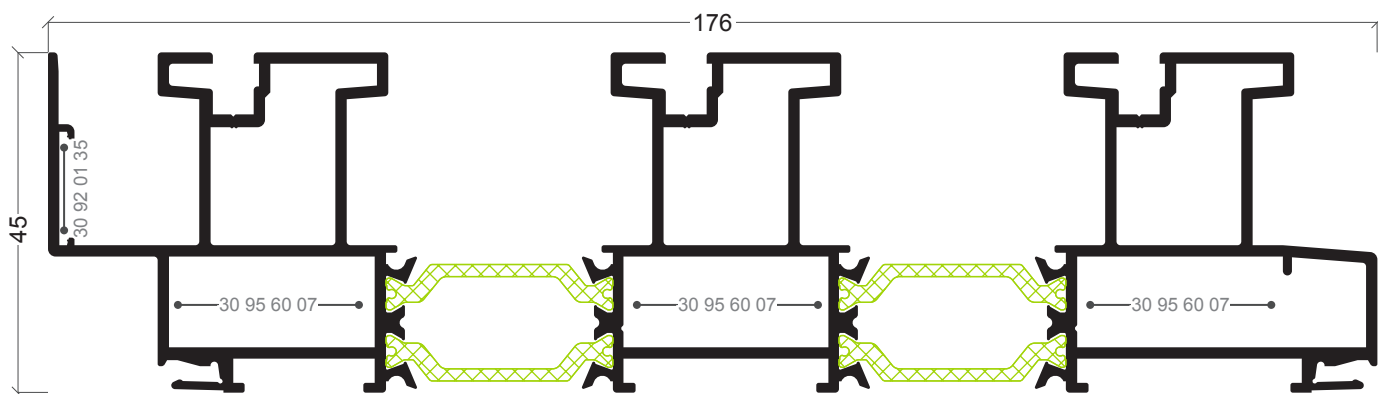

CW-23
Aro fixo tri-rail

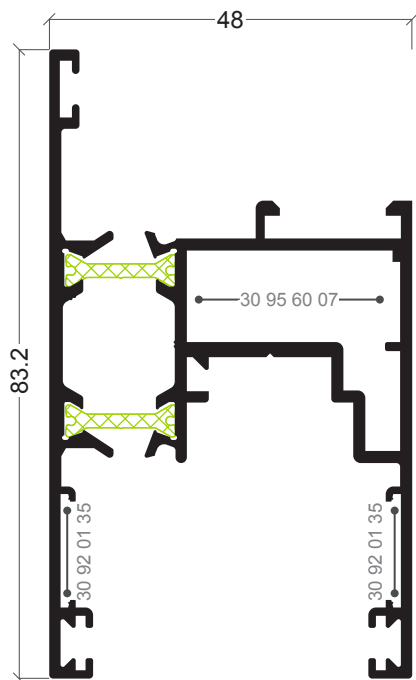

CW-02
Aro móvel perimetral

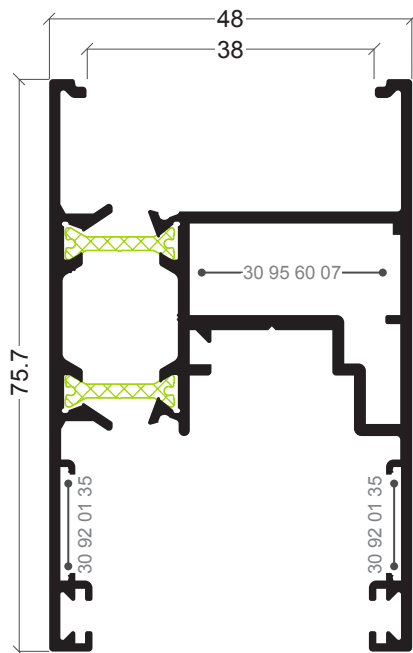

CW-03
Aro móvel perimetral

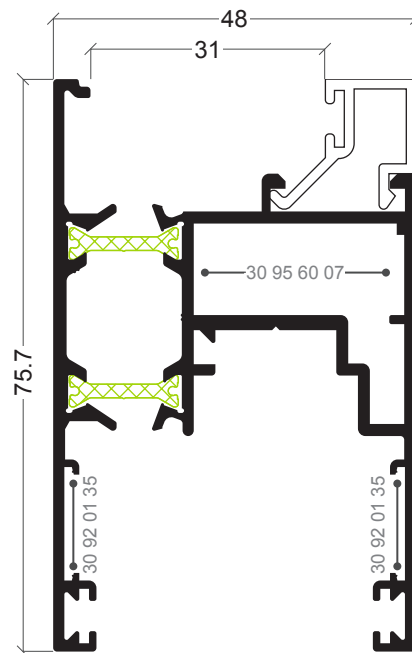

CW-04
Aro móvel perimetral

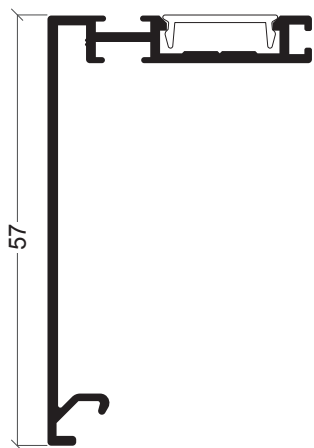

CW-06
Aro móvel perimetral

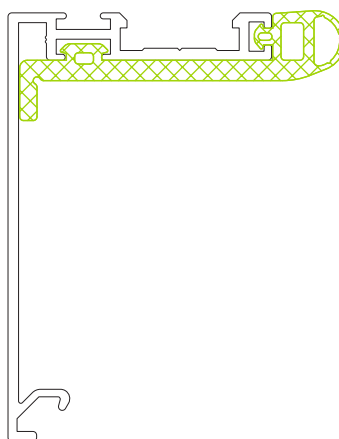

30 95 60 04
Junta central para CW-02

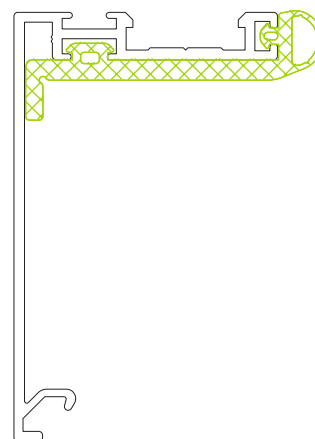

30 95 60 05
Junta central para CW-03/04



CW-15
Tampa

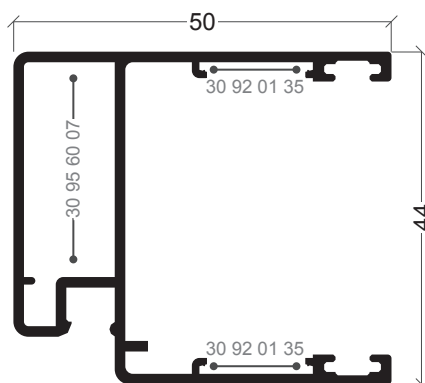

CW-14
Perfil para rede mosquiteira

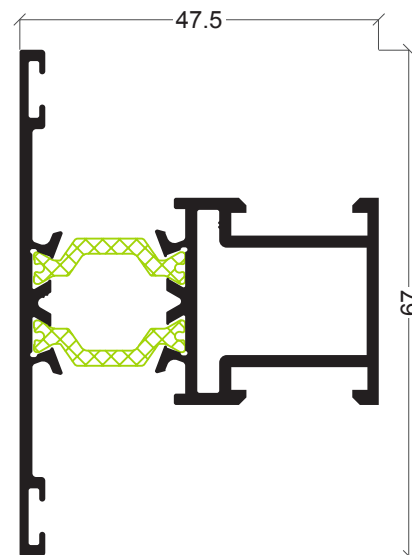

CW-16
Travessa

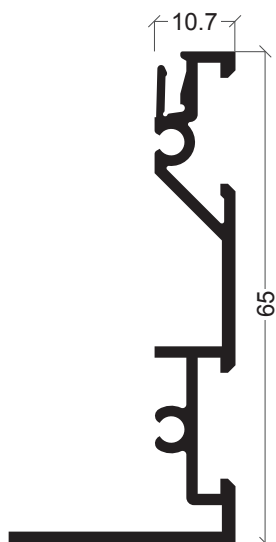

CW-11
Perfil para isolamento

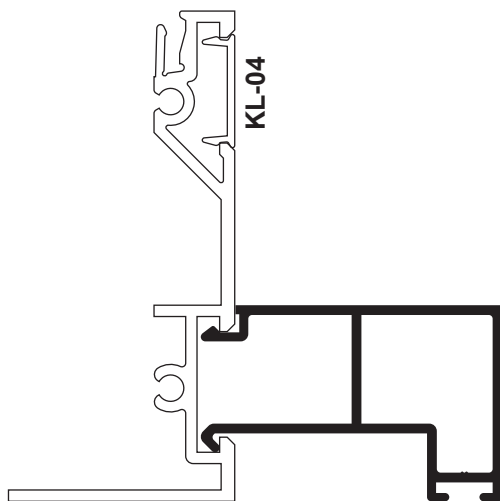

ARi-48
Bite

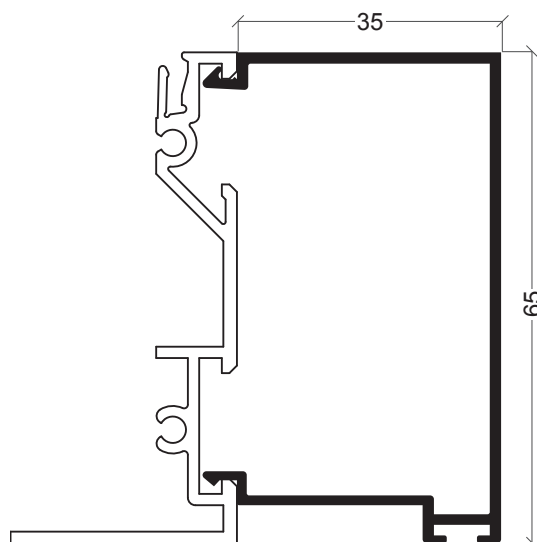

CW-12
Remate de isolamento

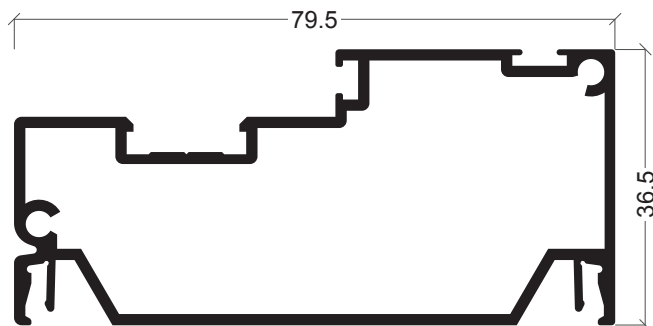

CW-13
Prumo de cruzamento

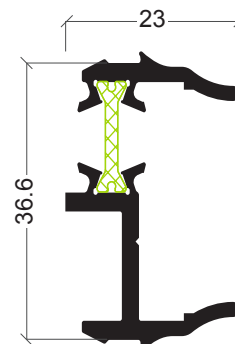

CTe-09
Perfil 4 folhas

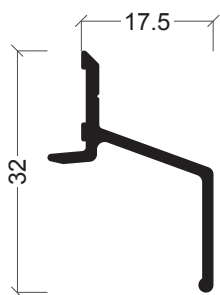

CT-29
Pingadeira superior

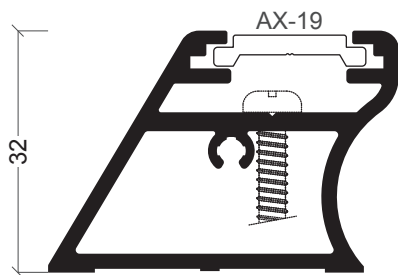

CT-28
Reforço

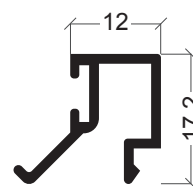

AX-70
Bite CW-04



CTe-03
Perfil guia

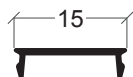

KL-04
Perfil complementar

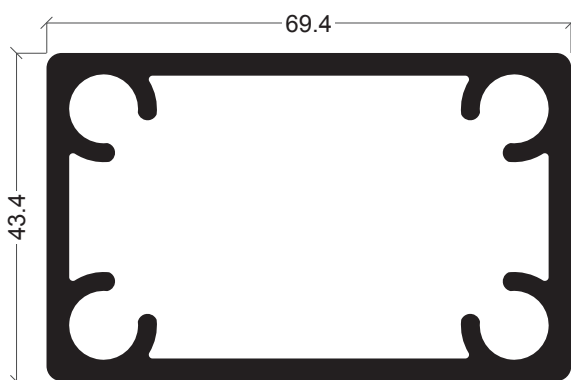

PO-07

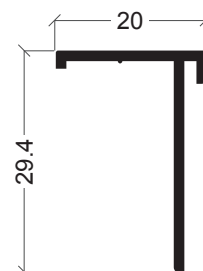

Y-24
Remate p/ apainelado

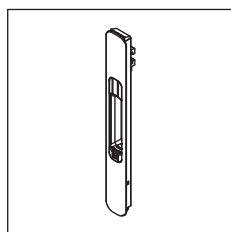

30 91 40 39/40/41
Fecho embutir manual
(natural/preto/branco)

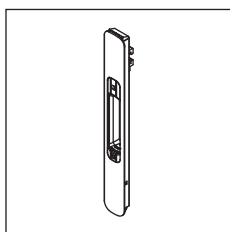

30 91 40 42/43/44
Fecho embutir automático
(natural/preto/branco)

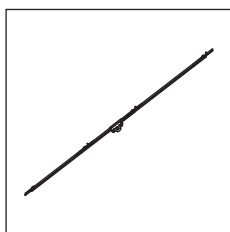

30 91 41 29
Barra multiponto 4
pontos (1800 mm)

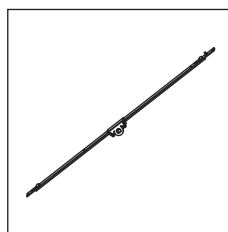

30 91 41 30
Barra multiponto 2
pontos (600 mm)

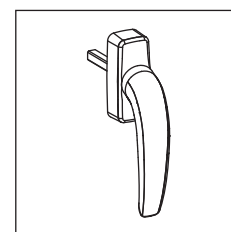

30 91 41 47/48
Cremone multi-ponto
(branco/preto)

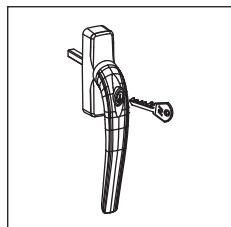

30 91 41 56/57
Cremone com chave multi-
ponto (branco/preto)

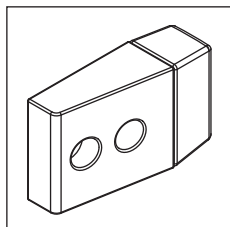

30 91 41 71
Topo limitador de
abertura

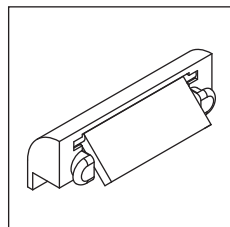

30 92 01 02/03
Goteira (preto/branco)

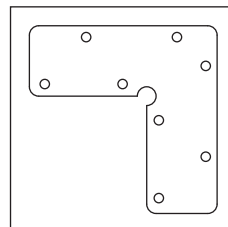

30 92 01 35
Esquadro de alinhamento
CW-01/02/03/04/05/08/09

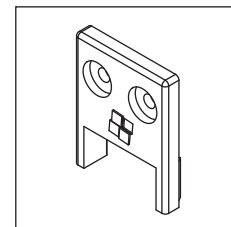

30 94 50 35
Tampa guia móvel recta
CW-06

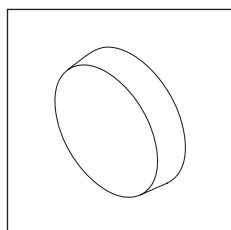

30 94 50 36
Tampa preta para parafuso
cabeça de queijo 9.3

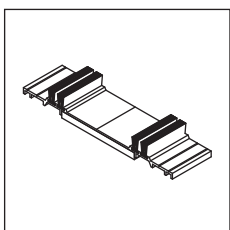

30 94 50 41
Cortavento superior
elevável

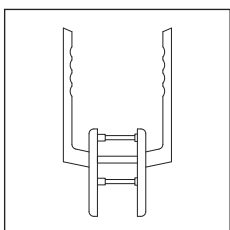

30 94 52 00/01/02
Puxador duplo para correr-
elevatória (natural/preto/inox)

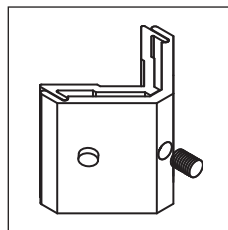

30 95 60 07
Esquadro 27x12 mm
centrado

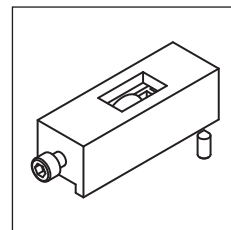

30 95 60 08
Rolamento simples regulável
CW (50 kg por rolamento)

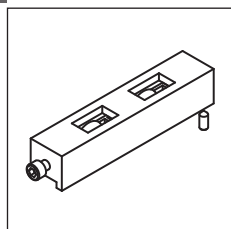

30 95 60 09
Rolamento duplo regulável
CW (100 kg por rolamento)

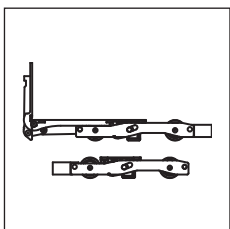

30 95 60 10
Conjunto rolamentos
elevável 200kg

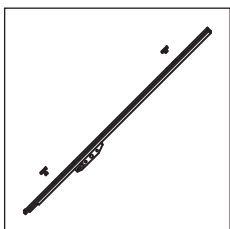

30 95 60 11
Ferragem correr/
elevatória 170

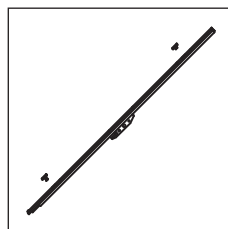

30 95 60 12
Ferragem correr/
elevatória 220

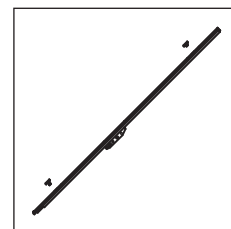

30 95 60 13
Ferragem correr/
elevatória 260

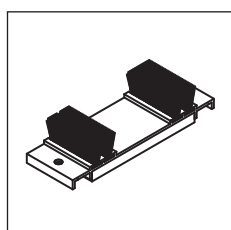

30 95 60 14
Corta-vento inferior/
superior

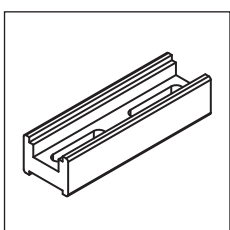

30 95 60 15
Calço multi-ponto n° 4

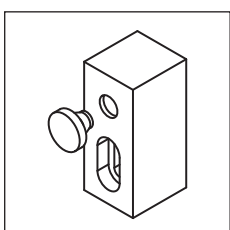

30 95 60 16
Batente lateral

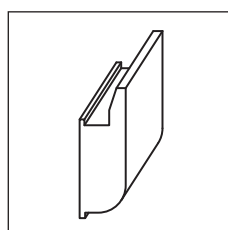

30 95 60 17
Guia

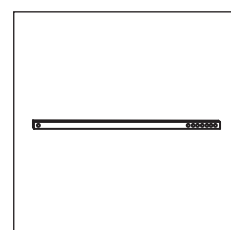

30 95 60 18
Barra de ligação 150

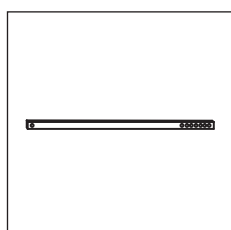

30 95 60 19
Barra de ligação 200

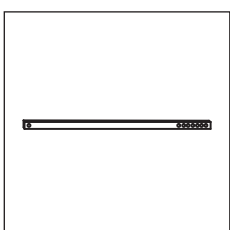

30 95 60 20
Barra de ligação 250

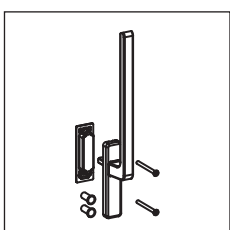

30 95 60 21/22/23/24/25
Conjunto puxador elevável
(natural/preto/branco/inox/bronze)

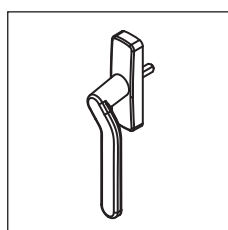

30 95 60 26/28
Puxador desviado M-P
direito branco/preto

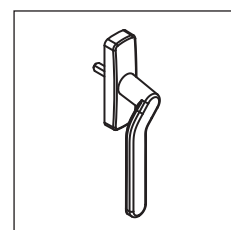

30 95 60 27/29
Puxador desviado M-P
esquerdo branco/preto

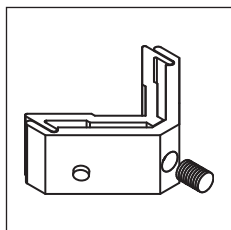

30 95 60 31

Esquadro 15x12 mm exterior

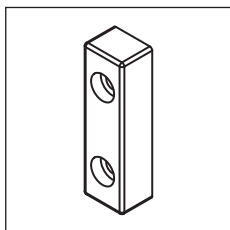

30 95 60 34

Calço 3/4 folhas

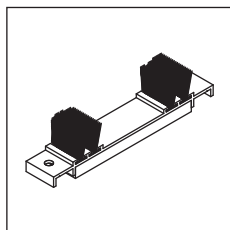

30 95 60 35

Corta-vento inferior/
superior mono-rail

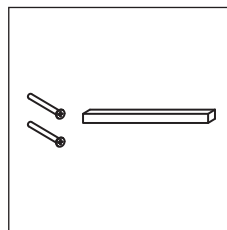

30 95 60 36

Conjunto perno + parafuso para
puxador multiponto desviado duplo

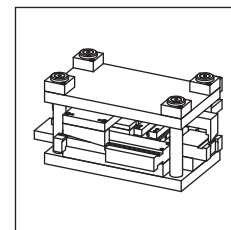

33 92 29 99







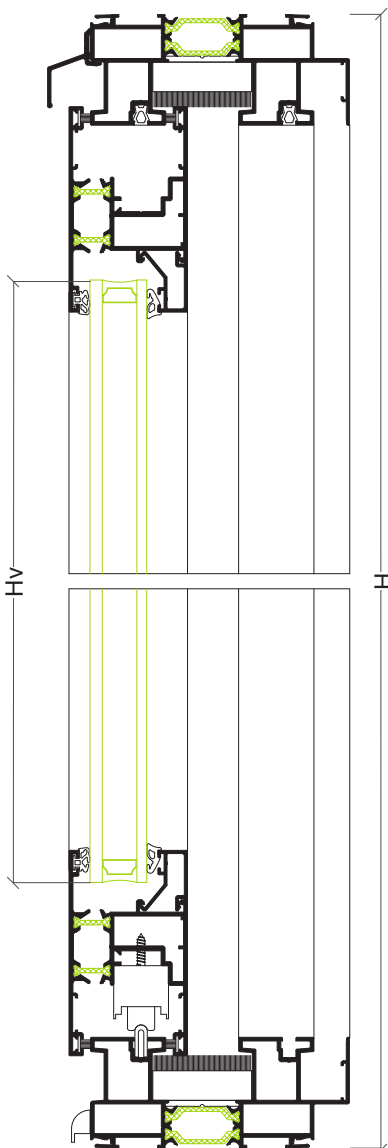
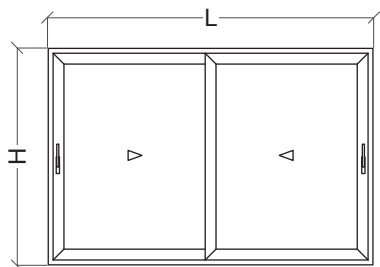



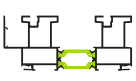

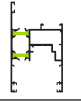



Cunho

| Referência | Desenho | Descrição |
|-------------|---------|------------------------------------|
| 30 20 26 03 | | Junta interior/exterior |
| 30 93 00 60 | | Vedante exterior do vidro |
| 30 93 00 61 | | Junta vedação exterior vidro 2 mm |
| 30 93 00 62 | | Junta plana para vidro |
| 30 93 00 65 | | Junta interior para vidro (5 mm) |
| 30 93 00 66 | | Junta interior para vidro (4 mm) |
| 30 93 00 67 | | Junta interior para vidro (2 mm) |
| 30 93 00 68 | | Junta interior para vidro (6/7 mm) |
| 30 93 00 69 | | Junta interior para vidro (8/9 mm) |
| 30 94 01 46 | | Junta para CW-13 |
| 30 94 60 12 | | Pelúcia tri-fin |
| 30 95 00 10 | | Pelúcia 7x9 mm |
| 30 95 00 40 | | Pelúcia 7x5.5 mm |
| 30 95 60 01 | | Junta tapa-canal central |
| 30 95 60 02 | | Junta tapa-canal aro fixo |
| 30 95 60 03 | | Junta vedação aro móvel |
| 30 95 60 04 | | Junta central CW-02 |
| 30 95 60 05 | | Junta central CW-03/04 |
| 30 95 60 06 | | Junta em U para vidro de 30 mm |
| 30 95 60 30 | | Junta isolante CW |

Janela 2 folhas correr



Perfis

| Desenho | Ref | Descrição | Corte | Quant | Medida |
|---|--------|----------------------|---|-------|--------------|
|  | CW-01 | Aro fixo perimetral |  | 2 | L |
| | | |  | 2 | H |
|  | CW-02 | Aro móvel perimetral |  | 4 | L/2+2 mm |
| | | |  | 4 | H-75 mm |
|  | CW-06 | Tampa de cruzamento |  | 2 | H-75 mm |
|  | CTe-03 | Perfil guia |  | 2 | L-74 mm |
|  | CT-29 | Pingadeira |  | 1 | L |
|  | KL-04 | Perfil tampa central |  | 2 | H-75 mm |
|  | --- | Bite horizontal |  | 4 | L/2-124.5 mm |
|  | --- | Bite vertical |  | 4 | H-241.5 mm |

Acessórios e Juntas

| Referência | Descrição | Quantidade |
|-------------|----------------------------------|------------|
| 30 95 60 07 | Esquadro | 16 |
| 30 92 01 35 | Esquadro de alinhamento | 20 |
| 30 95 60 14 | Corta-vento inferior/superior | 2 |
| 30 95 60 16 | Batente lateral | 4 |
| 30 94 50 35 | Tampa guia | 4 |
| 30 92 01 02 | Goteira com válvula (preto) | diversas |
| 30 91 40 43 | Fecho lateral automático (preto) | 2 |
| 30 95 60 09 | Rolamento duplo regulável | 4 |
| 30 95 00 40 | Pelúcia 7x5.5 mm fin-seal | 4L+2H |
| 30 95 60 01 | Junta tapa-canal central | 2L+2H |
| 30 95 60 02 | Junta tapa-canal | 2L+4H |
| 30 95 60 03 | Junta de vedação | 4H |
| 30 95 60 04 | Junta central CW-02 | 2H |
| --- | Junta exterior para vidro | 2L+4H |
| --- | Junta interior para vidro | 2L+4H |

Vidro

| | |
|---------------|-----------------|
| Hv = H-215 mm | Lv = L/2-138 mm |
|---------------|-----------------|

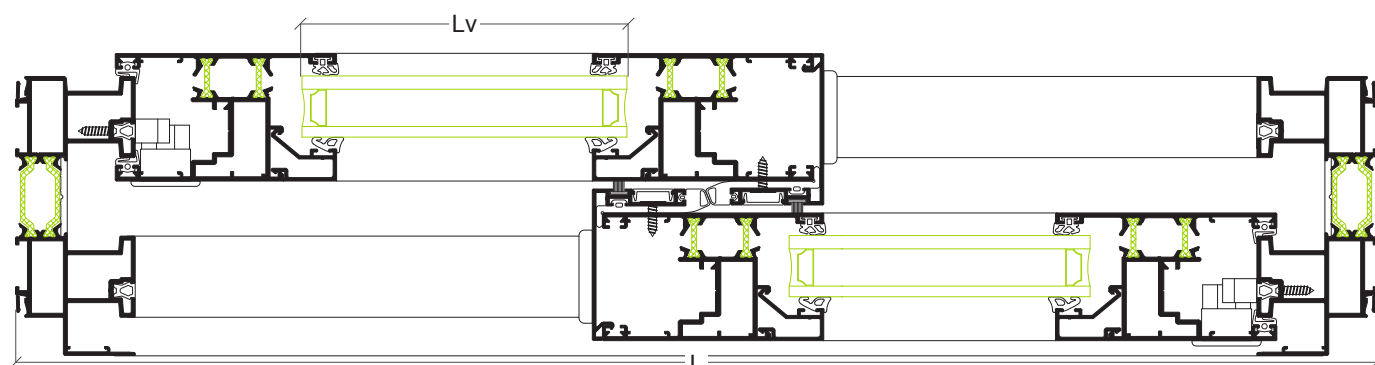

Porta 1 folha galandage

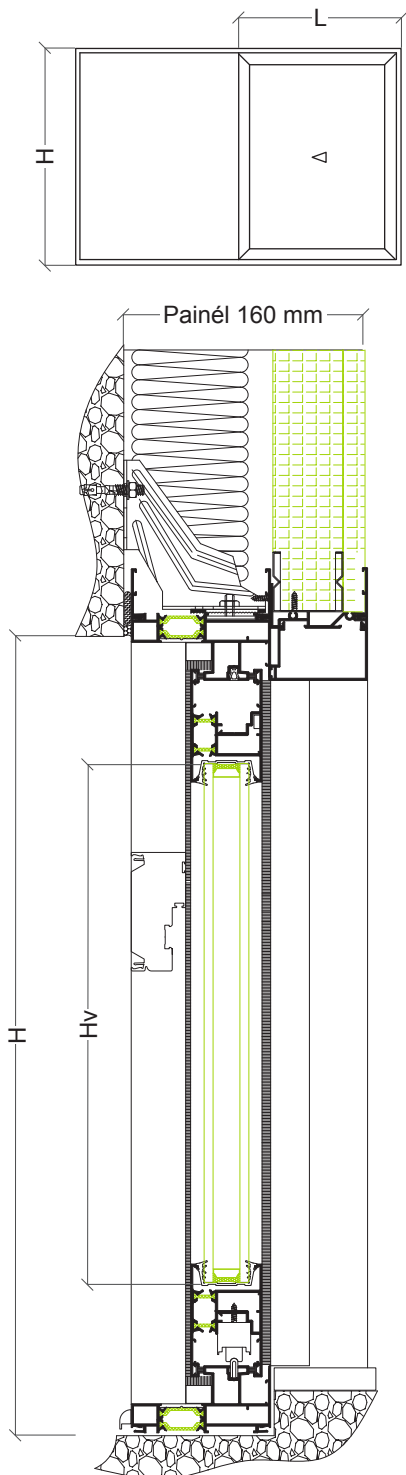

Perfis

| Desenho | Ref | Descrição | Corte | Quant | Medida |
|---------|--------|---------------------------------------|-------|-------|--------------|
| | CW-07 | Aro fixo perimetral | | 2 | (Lx2)+112 mm |
| | | | | 2 | H+15 mm |
| | CW-03 | Aro móvel perimetral | | 2 | L+52 mm |
| | | | | 2 | H-60 mm |
| | CW-06 | Tampa de cruzamento | | 1 | H-60 mm |
| | CW-11 | Perfil para isolamento | | 1 | L+167 mm |
| | | | | 2 | H-39 mm |
| | CW-12 | Remate de isolamento | | 1 | L+106 mm |
| | | | | 2 | L+106 mm |
| | CW-13 | Prumo de cruzamento | | 1 | H-24 mm |
| | CTe-03 | Perfil guia | | 1 | (Lx2)+38 mm |
| | KL-04 | Perfil tampa central | | 1 | H-24 mm |
| | | | | 1 | H-60 mm |
| | AXi-88 | Remate lateral de isolamento exterior | | 1 | (Lx2)+126 mm |
| | | | | 2 | H+45 mm |
| | AXi-88 | Remate lateral de isolamento interior | | 1 | L+188 mm |
| | | | | 2 | H+1.5 mm |

Acessórios e Juntas

| Referência | Descrição | Quantidade |
|-------------|---|------------|
| 30 95 60 07 | Esquadro | 8 |
| 30 95 60 31 | Esquadro exterior | 4 |
| 30 92 01 35 | Esquadro alinhamento | 24 |
| 30 95 60 35 | Corta-vento inferior/superior mono-rail | 2 |
| 30 95 60 16 | Batente lateral | 2 |
| 30 94 50 35 | Tampa guia | 2 |
| 30 92 01 02 | Goteira com válvula (preto) | diversas |
| 30 91 41 48 | Puxador preto | 1 |
| 30 95 60 09 | Rolamento duplo regulável | 2 |
| 30 91 41 30 | Ferragem multi-ponto 600 mm | 2 |
| 30 95 60 15 | Calço MP nº 4 | 4 |
| 30 95 00 40 | Pelúcia 7x5.5 mm fin-seal | 4L+2H |
| 30 95 60 01 | Junta tapa-canal central | 4L+2H |
| 30 95 60 02 | Junta tapa-canal | 4L+4H |
| 30 95 60 03 | Junta de vedação | 2H |
| 30 95 60 05 | Junta central CW-03/04 | H |
| 30 59 60 06 | Junta para vidro (30 mm) | 2L+2H |
| 30 94 01 46 | Junta para CW-13 | H |
| 30 95 00 10 | Pelúcia 7x9 mm | H |
| 30 94 01 46 | Junta para CW-13 | H |

Vidro



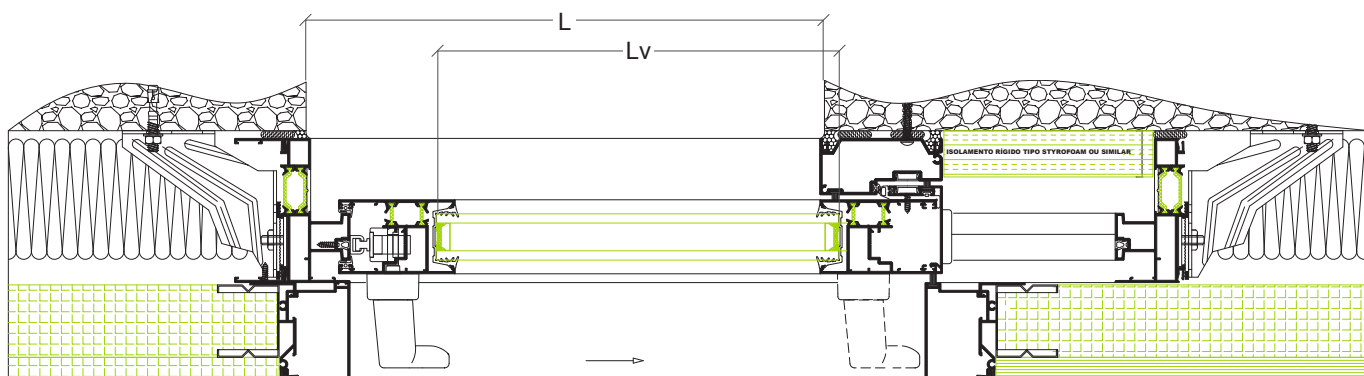



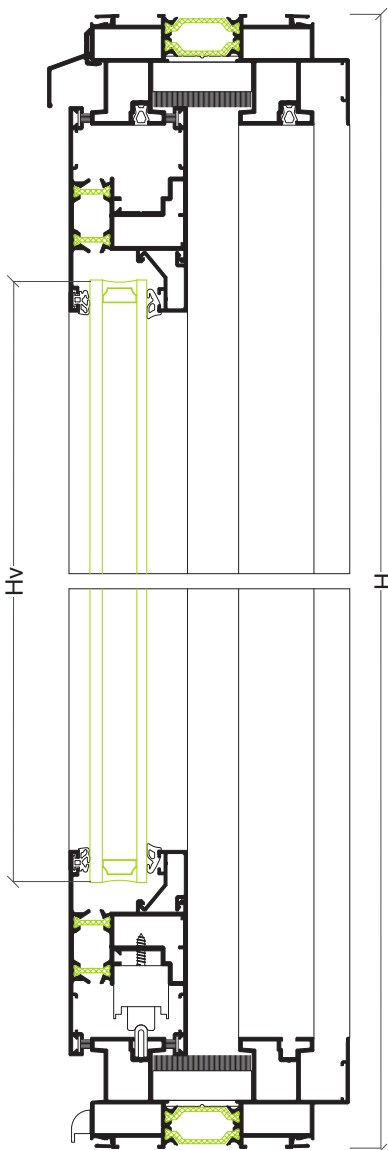
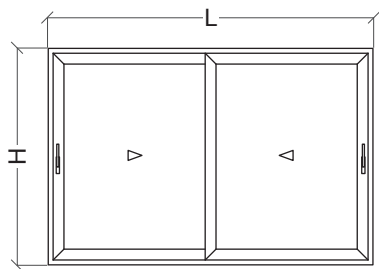



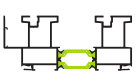

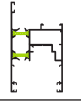



| | |
|---------------|--------------|
| Hv = H-186 mm | Lv = L-75 mm |
|---------------|--------------|



Porta 2 folhas correr



Perfis

| Desenho | Ref | Descrição | Corte | Quant | Medida |
|---|--------|----------------------|---|-------|--------------|
|  | CW-01 | Aro fixo perimetral |  | 2 | L |
| | | |  | 2 | H |
|  | CW-02 | Aro móvel perimetral |  | 4 | L/2+2 mm |
| | | |  | 4 | H-75 mm |
|  | CW-06 | Tampa de cruzamento |  | 2 | H-75 mm |
|  | CTe-03 | Perfil guia |  | 2 | L-74 mm |
|  | CT-29 | Pingadeira |  | 1 | L |
|  | KL-04 | Perfil tampa central |  | 2 | H-75 mm |
|  | --- | Bite horizontal |  | 4 | L/2-124.5 mm |
|  | --- | Bite vertical |  | 4 | H-241.5 mm |

Acessórios e Juntas

| Referência | Descrição | Quantidade |
|-------------|-----------------------------------|------------|
| 30 95 60 07 | Esquadro | 16 |
| 30 92 01 35 | Esquadro de alinhamento | 20 |
| 30 95 60 14 | Corta-vento inferior/superior | 2 |
| 30 95 60 16 | Batente lateral | 4 |
| 30 94 50 35 | Tampa guia | 4 |
| 30 92 01 02 | Goteira com válvula (preto) | diversas |
| 30 95 60 29 | Puxador desviado esquerdo (preto) | 1 |
| 30 95 60 28 | Puxador desviado direito (preto) | 1 |
| 30 91 41 30 | Ferragem multi-ponto 600 mm | 2 |
| 30 95 60 15 | Calço MP nº 4 | 8 |
| 30 91 41 71 | Limitador | 1 |
| 30 95 60 09 | Rolamento duplo regulável | 4 |
| 30 95 00 40 | Pelúcia 7x5.5 mm fin-seal | 4L+2H |
| 30 95 60 01 | Junta tapa-canal central | 2L+2H |
| 30 95 60 02 | Junta tapa-canal | 2L+4H |
| 30 95 60 03 | Junta de vedação | 4H |
| 30 95 60 04 | Junta central CW-02 | 2H |
| --- | Junta exterior para vidro | 2L+4H |
| --- | Junta interior para vidro | 2L+4H |

Vidro



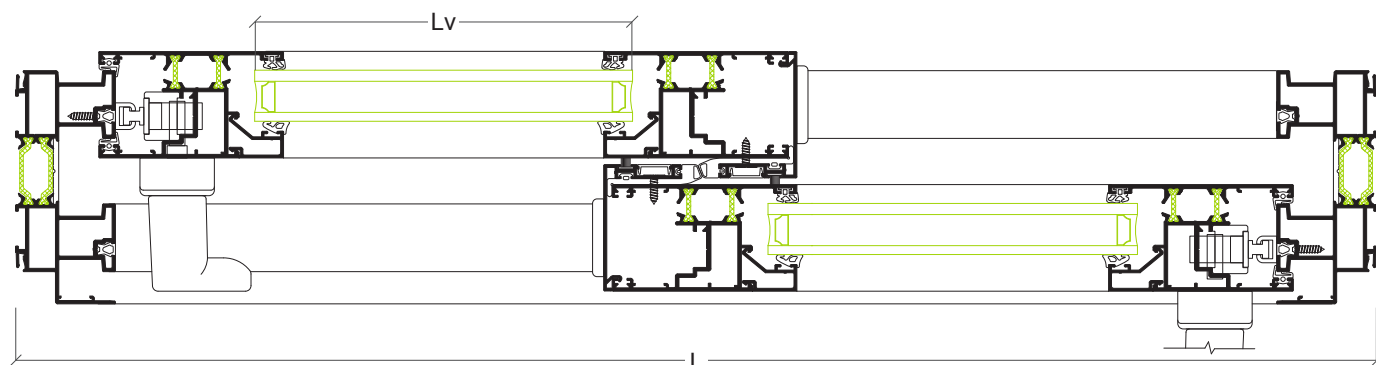



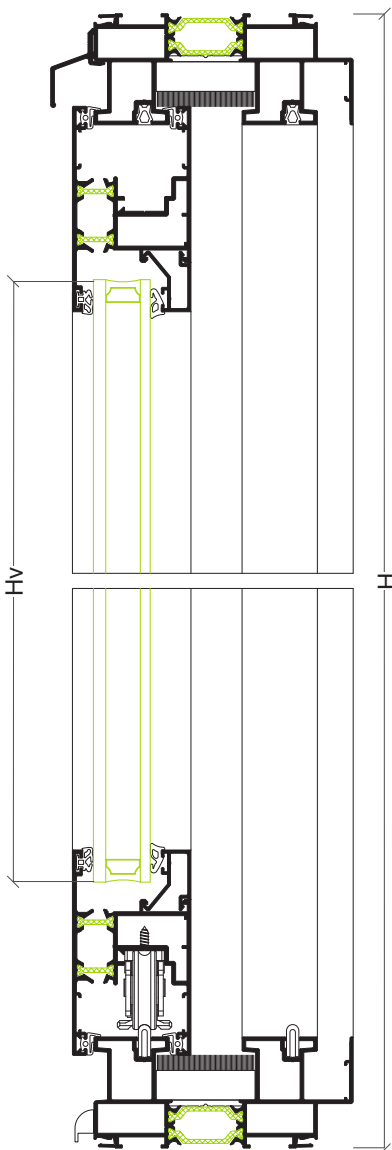
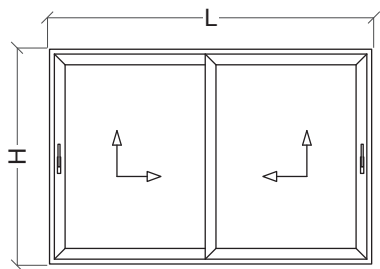



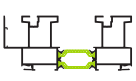

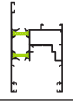



| | |
|---------------|-----------------|
| Hv = H-215 mm | Lv = L/2-138 mm |
|---------------|-----------------|



Porta 2 folhas correr elevável



Perfis

| Desenho | Ref | Descrição | Corte | Quant | Medida |
|---|--------|----------------------|---|-------|--------------|
|  | CW-01 | Aro fixo perimetral |  | 2 | L |
| | | |  | 2 | H |
|  | CW-02 | Aro móvel perimetral |  | 4 | L/2+2 mm |
| | | |  | 4 | H-75 mm |
|  | CW-06 | Tampa de cruzamento |  | 2 | H-75 mm |
|  | CTe-03 | Perfil guia |  | 2 | L-74 mm |
|  | CT-29 | Pingadeira |  | 1 | L |
|  | KL-04 | Perfil tampa central |  | 2 | H-75 mm |
|  | --- | Bite horizontal |  | 4 | L/2-124.5 mm |
|  | --- | Bite vertical |  | 4 | H-241.5 mm |

Acessórios e Juntas

| Referência | Descrição | Quantidade |
|-------------|---------------------------------|------------|
| 30 95 60 07 | Esquadro | 16 |
| 30 92 01 35 | Esquadro de alinhamento | 20 |
| 30 95 60 14 | Corta-vento inferior | 1 |
| 30 94 50 41 | Corta-vento superior (elevável) | 1 |
| 30 94 50 35 | Tampa guia | 4 |
| 30 92 01 02 | Goteira com válvula (preto) | diversas |
| 30 95 60 XX | Ferragem correr/elevatória | 2 |
| 30 95 60 10 | Conjunto rolamentos elevável | 2 |
| 30 95 60 XX | Conjunto puxador elevável | 2 |
| 30 95 60 XX | Barra de ligação | 2 |
| 30 91 41 71 | Limitador | 1 |
| 30 95 00 40 | Pelúcia 7x5.5 mm fin-seal | 2H |
| 30 95 60 01 | Junta tapa-canal central | 2L+2H |
| 30 95 60 02 | Junta tapa-canal | 2L+4H |
| 30 95 60 03 | Junta de vedação | 4L+4H |
| 30 95 60 04 | Junta central CW-02 | 2H |
| --- | Junta exterior para vidro | 2L+4H |
| --- | Junta interior para vidro | 2L+4H |

13

Vidro



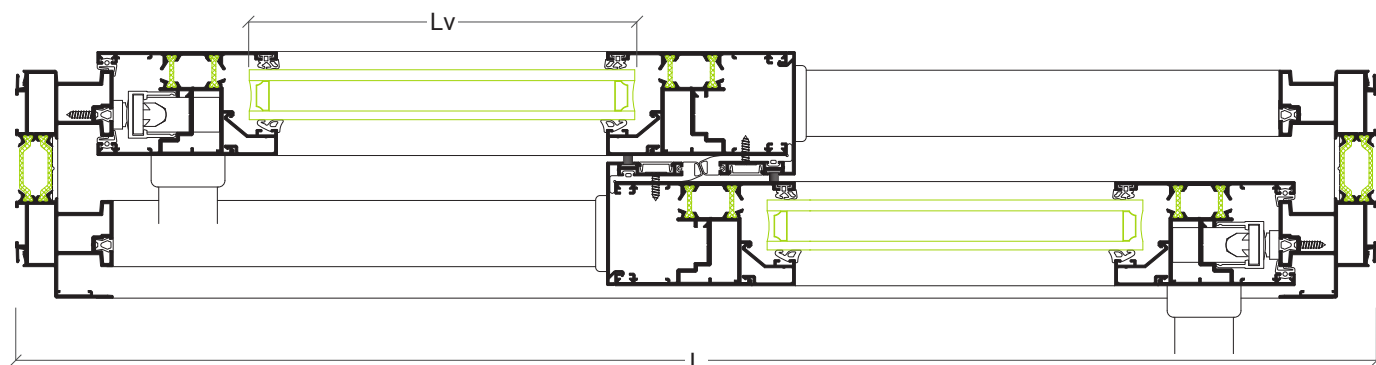



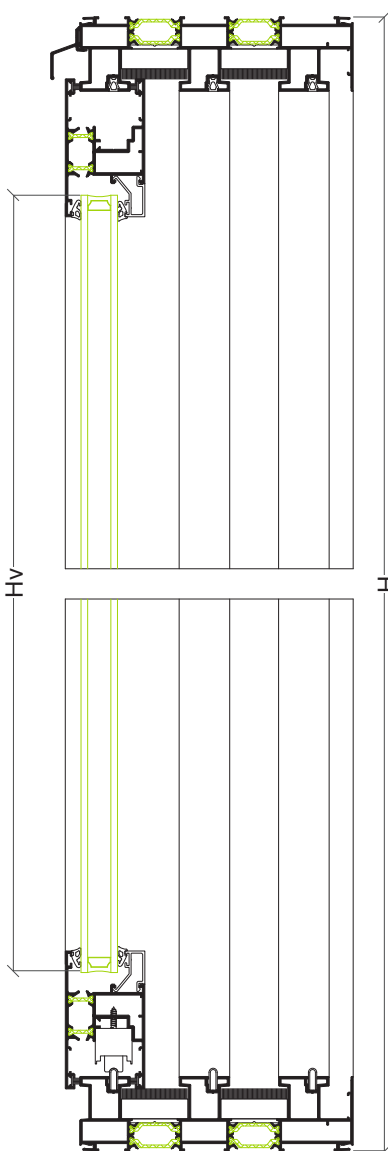
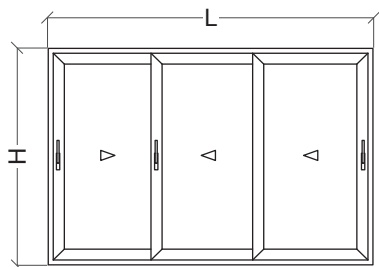











| | |
|---------------|-----------------|
| Hv = H-215 mm | Lv = L/2-138 mm |
|---------------|-----------------|



Porta 3 folhas correr tri-rail



Perfis

| Desenho | Ref | Descrição | Corte | Quant | Medida |
|---|--------|------------------------------|---|-------|-------------|
|  | CW-09 | Aro fixo tri-rail perimetral |  | 2 | L |
| | | |  | 2 | H |
|  | CW-02 | Aro móvel perimetral |  | 6 | L/3+28 mm |
| | | |  | 6 | H-75 mm |
|  | CW-06 | Tampa de cruzamento |  | 4 | H-75 mm |
|  | CTe-03 | Perfil guia |  | 3 | L-74 mm |
|  | CT-29 | Pingadeira |  | 1 | L |
|  | KL-04 | Perfil tampa central |  | 4 | H-75 mm |
|  | --- | Bite horizontal |  | 6 | L/3-98.5 mm |
|  | --- | Bite vertical |  | 6 | H-241.5 mm |

Acessórios e Juntas

| Referência | Descrição | Quantidade |
|-------------|-----------------------------------|------------|
| 30 95 60 07 | Esquadro | 20 |
| 30 92 01 35 | Esquadro de alinhamento | 28 |
| 30 95 60 14 | Corta-vento inferior/superior | 4 |
| 30 95 60 16 | Batente lateral | 4 |
| 30 94 50 35 | Tampa guia | 8 |
| 30 92 01 02 | Goteira com válvula (preto) | diversas |
| 30 95 60 29 | Puxador desviado esquerdo (preto) | 1 |
| 30 95 60 28 | Puxador desviado direito (preto) | 1 |
| 30 91 41 30 | Ferragem multiponto 600 mm | 2 |
| 30 95 60 15 | Calço MP nº 4 | 8 |
| 30 91 41 71 | Limitador | 2 |
| 30 95 60 09 | Rolamento duplo regulável | 6 |
| 30 95 00 40 | Pelúcia 7x5.5 mm fin-seal | 4H+4L |
| 30 95 60 01 | Junta tapa-canal central | 4L+4H |
| 30 95 60 02 | Junta tapa-canal | 3L+6H |
| 30 95 60 03 | Junta de vedação | 4H |
| 30 95 60 04 | Junta central CW-02 | 4H |
| --- | Junta exterior para vidro | 2L+6H |
| --- | Junta interior para vidro | 2L+6H |

Vidro



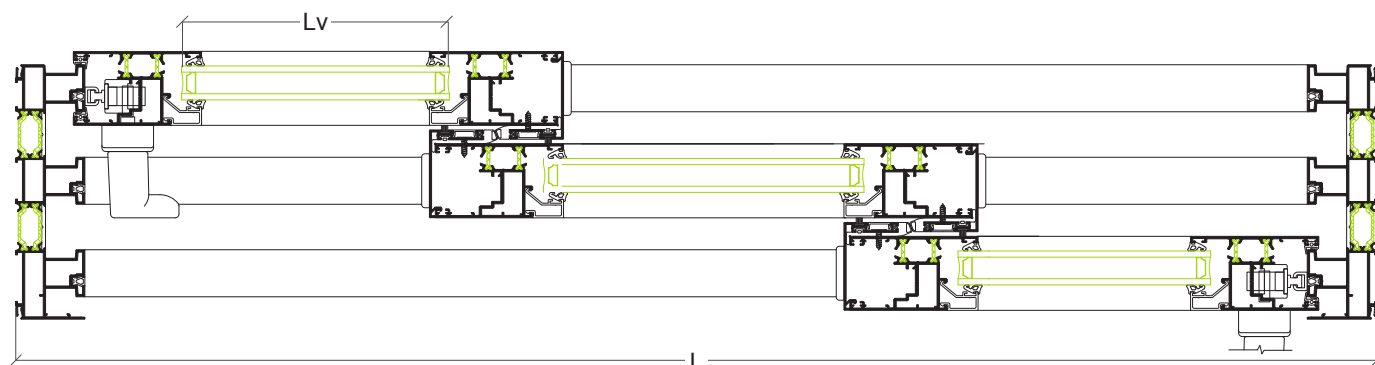



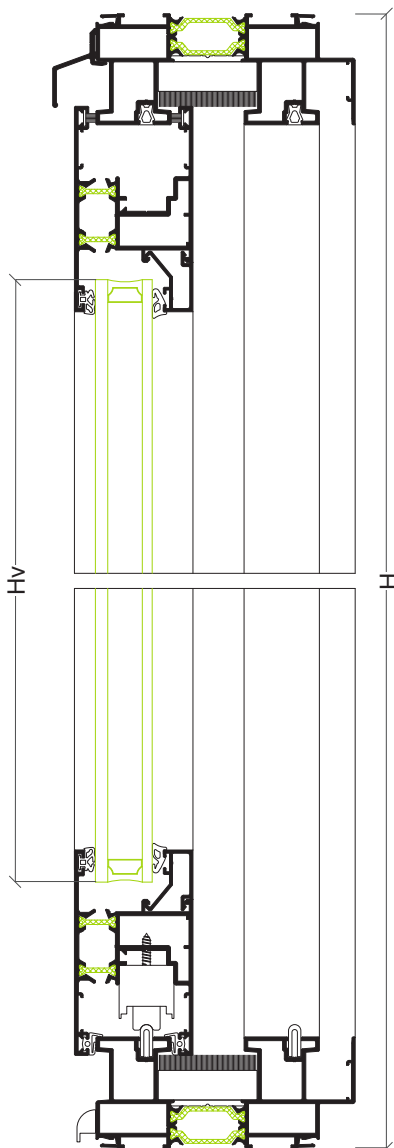
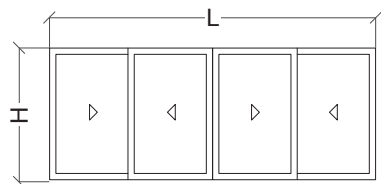



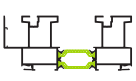

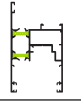

| | |
|---------------|-----------------|
| Hv = H-215 mm | Lv = L/3-113 mm |
|---------------|-----------------|



Porta 4 folhas correr



Perfis

| Desenho | Ref | Descrição | Corte | Quant | Medida |
|---|--------|----------------------|---|-------|------------|
|  | CW-01 | Aro fixo perimetral |  | 2 | L |
| | | |  | 2 | H |
|  | CW-02 | Aro móvel perimetral |  | 8 | L/4+20 mm |
| | | |  | 8 | H-75 mm |
|  | CW-06 | Tampa de cruzamento |  | 4 | H-75 mm |
|  | CTe-03 | Perfil guia |  | 2 | L-74 mm |
|  | CT-29 | Pingadeira |  | 1 | L |
|  | KL-04 | Perfil tampa central |  | 4 | H-75 mm |
|  | CTe-09 | Perfil 4 folhas |  | 1 | H-75 mm |
|  | --- | Bite horizontal |  | 8 | L/4-107 mm |
|  | --- | Bite vertical |  | 8 | H-241.5 mm |

Acessórios e Juntas

| Referência | Descrição | Quantidade |
|-------------|-----------------------------------|------------|
| 30 95 60 07 | Esquadro | 24 |
| 30 92 01 35 | Esquadro de alinhamento | 36 |
| 30 95 60 14 | Corta-vento inferior/superior | 6 |
| 30 95 60 16 | Batente lateral | 6 |
| 30 95 60 34 | Calço 3-4 folhas | 4 |
| 30 94 50 35 | Tampa guia | 8 |
| 30 92 01 02 | Goteira com válvula (preto) | diversas |
| 30 95 60 29 | Puxador desviado esquerdo (preto) | 1 |
| 30 95 60 28 | Puxador desviado direito (preto) | 2 |
| 30 91 41 30 | Ferragem multiponto 600 mm | 3 |
| 30 95 60 15 | Calço MP nº 4 | 12 |
| 30 91 41 71 | Limitador | 2 |
| 30 95 60 09 | Rolamento duplo regulável | 8 |
| 30 95 00 40 | Pelúcia 7x5.5 mm fin-seal | 4L+6H |
| 30 95 60 01 | Junta tapa-canal central | 2L+2H |
| 30 95 60 02 | Junta tapa-canal | 2L+4H |
| 30 95 60 03 | Junta de vedação | 4H |
| 30 95 60 04 | Junta central CW-02 | 4H |
| --- | Junta exterior para vidro | 2L+8H |
| --- | Junta interior para vidro | 2L+8H |

Vidro

| | |
|---------------|-------------------|
| Hv = H-215 mm | Lv = L/4 - 120 mm |
|---------------|-------------------|

