

[www.anicolor.pt](http://www.anicolor.pt)

**SISTEMA DE CORRER  
COM RPT - 60 mm**

**SISTEMA CORREDERA  
CON RPT - 60 mm**

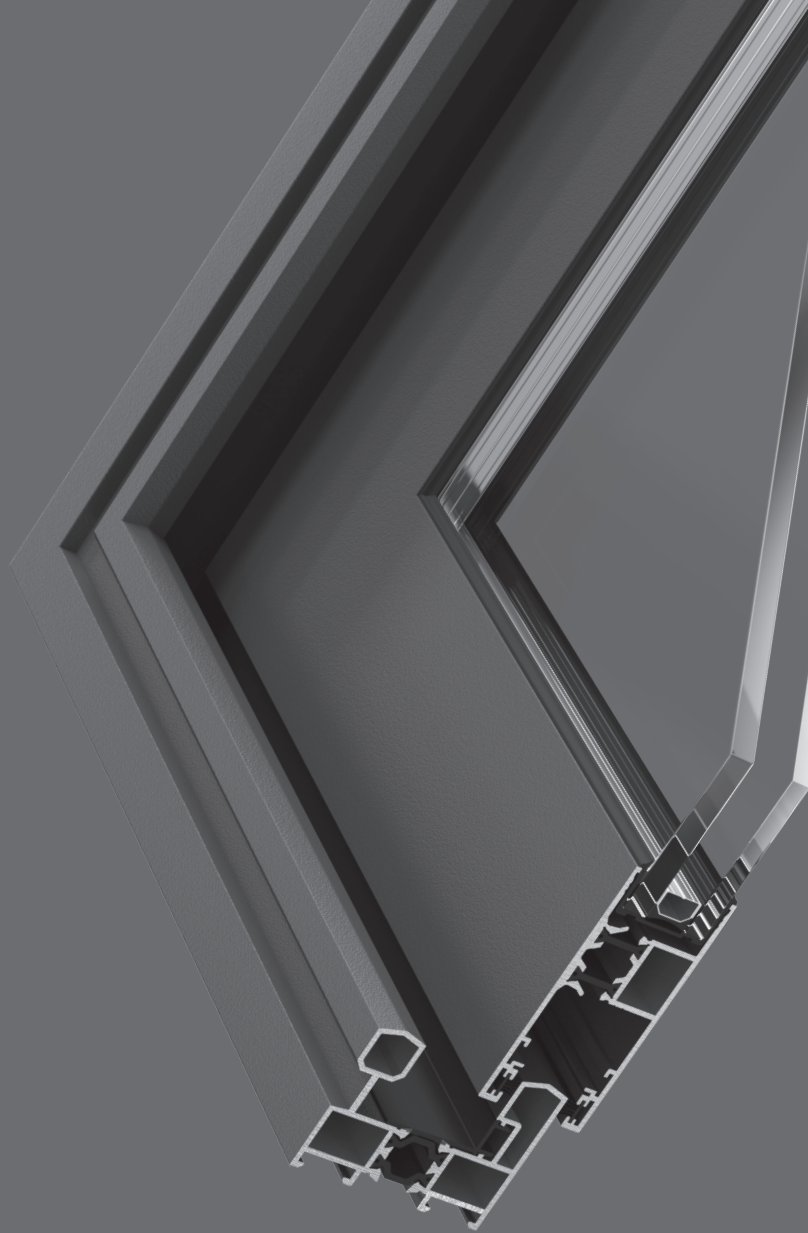

**CT**

 **anicolor**  
Sistemas de Alumínio

## SISTEMA CT

### Sistema de correr com RPT - 60 mm

#### CARACTERÍSTICAS DO SISTEMA

Sistema de alumínio com rotura térmica para execução de vãos de correr.  
 O sistema de correr CT possibilita a execução de 4 versões de caixilharia:  
 · CT - Perimetral, CT - Benelux, CT - Euro e CT - Hotel

#### PERFIS DE ALUMÍNIO

Os perfis de alumínio são extrudidos na liga de alumínio 6060 para arquitetura de acordo com norma NP EN 12020-02.

Os perfis com rotura térmica são obtidos por inserção de varetas isolantes de poliamida 6.6 mm reforçadas com 25% de fibra de vidro.

Versátil sistema de rotura térmica com aros e folhas perimetrais ou de corte recto designado por Benelux, é o sistema indicado para as inovadoras soluções arquitectónicas da actualidade.

Espessura média dos perfis de alumínio de 1.5 mm.

#### AROS FIXOS

Secção do aro fixo perimetral de 2 guias de 60 mm para montagem a meia esquadria;  
 Secção do aro fixo CT - Euro de 2 guias de 96mm para montagem em corte recto;  
 Perfis com rotura térmica obtida por inserção de varetas isolantes de poliamida de 14.6 mm, 18 mm ou 20 mm;  
 Perfil guia de deslizamento inferior em aço inoxidável 304 ou em poliamida, para evitar desgaste das peças.

#### AROS MÓVEIS

Secção dos aros móveis perimetrais de 33.1 mm para montagem a meia esquadria;  
 Secção dos aros móveis corte recto de 37,5 mm;  
 Enchimento de 18 mm a 26 mm para o sistema CT;  
 Enchimento de 18mm a 27 mm para o sistema CT-BENELUX;  
 Aros móveis de linha recta ou curva com ou sem bite;  
 Estanqueidade assegurada através de junta em TPE e/ou pelúcia tipo Sin-Feal.

#### DIMENSIONAMENTO E MANOBRABILIDADE

Peso máximo de 150 kg por folha (com 2 rolamentos duplos);  
 Possibilidades de abertura: 2, 3, 4 e 6 folhas com folhas móveis e/ou fixas;  
 Rolamento duplo oscilante com regulação;  
 Rolamentos de agulhas inox com eixo temperado retificado sendo possível a substituição sem desmontagem da folha;  
 Suporte exterior com tratamento cataforese (anti-corrosivo);  
 Abertura do vão com fecho lateral ou ferragem multi-ponto com 1 ou mais pontos de fecho.

#### PERFORMANCES

Sistema certificado por laboratório credenciado, notificado do ensaio tipo inicial (ITT) de acordo com a norma de produto EN 14351-1 para efeitos de Marcação CE.

Categorias alcançadas na avaliação do sistema CT tipologia janela:

1. Permeabilidade ao ar: Classe 3 (norma de ensaio EN 10207 e EN 1026)
2. Estanqueidade à água: Classe 7A (norma de ensaio EN 12208 e EN 1027)
3. Resistência ao vento: Classe C5 (norma de ensaio EN 12210 e EN 12211)

Categorias alcançadas na avaliação do sistema CT tipologia porta:

1. Permeabilidade ao ar: Classe 4 (norma de ensaio EN 10207 e EN 1026)
2. Estanqueidade à água: Classe 7A (norma de ensaio EN 12208 e EN 1027)
3. Resistência ao vento: Classe C2 (norma de ensaio EN 12210 e EN 12211)

Coefficiente de transmissão térmica de vão de 2 folhas com 1.80 m x 2.20 m com vidro Ug = 1.0 W/m<sup>2</sup>K com intercalar efeito "Warm Edge": Uw = 1.91 W/m<sup>2</sup>K

Coefficiente de atenuação acústica de vão de 2 folhas com vidro 6/14/33.1 acústico: Rw (C; Ctr) = 34 dB (-1; -6)

CT-Euro

Categorias alcançadas na avaliação do sistema CT tipologia janela:

1. Permeabilidade ao ar: Classe 4 (norma de ensaio EN 10207 e EN 1026)
2. Estanqueidade à água: Classe 7A (norma de ensaio EN 12208 e EN 1027)
3. Resistência ao vento: Classe C5 (norma de ensaio EN 12210 e EN 12211)

Coefficiente de atenuação acústica de vão de 2 folhas com vidro 33.2 silencio/10/44.2 silencio: Rw (C; Ctr) = 37 dB (-1; -3)

Zonas de aplicação segundo RCCTE (em função do valor Ug): I1, I2, I3, V1, V2, V3;

## SISTEMA CT

### Sistema corredera con RPT - 60 mm

#### CARACTERÍSTICAS DEL SISTEMA

Sistema de aluminio con rotura térmica para ejecución de huecos correderos.  
 El sistema CT en funcionamiento permite la ejecución de 4 versiones de los marcos:  
 CT - Perimetral  
 CT - Benelux  
 CT - Euro  
 CT - Hotel

#### PERFILES DE ALUMINIO

Sistema de aluminio con rotura térmica para ejecución de huecos correderos.

#### MARCOS

Profundidad del marco perimetral de 2 guías de 60 mm para montaje a englete;  
 Sección de marcos CT - Euro con 2 guías de 96 mm para montaje en sección recta;  
 Perfiles con rotura térmica obtenida por inserción de pletina fallebas aislantes de poliamida de 14.6 mm u 18 mm;  
 Perfil guía de deslizamiento inferior en acero inoxidable AISI 304 u en poliamida, para evitar el desgaste de las piezas.

#### HOJAS

Profundidad de las hojas perimetrales de 33.1 mm para montaje a englete;  
 Sección de hojas de corte recto de 37,5 mm;  
 Acristalamiento de 18 mm a 26 mm para el sistema CT;  
 Acristalamiento de 18 mm a 27 mm para el sistema CT-BENELUX;  
 Hojas de línea recta y curva con y sin junquillo;  
 Estanqueidad asegurada mediante junta de TPE y/u burlete tipo Sin-Feal.

#### DIMENSIONAMIENTO Y MANIOBRABILIDAD

Peso máximo de 150 kg por hoja (con 2 rodamientos dobles);  
 Posibilidades de apertura: 2, 3, 4 y 6 hojas con hojas correderas y/ó fijas;  
 Rodamiento doble oscilante con regulación;  
 Rodamientos de agujas inox con eje templado retificado siendo posible la sustitución sin desmontar la hoja;  
 Soporte exterior con tratamiento anticorrosivo;  
 Apertura del hueco con cierre lateral u herraje multicierre con 1 ó más puntos de cierre.

#### ENSAYOS

Sistema certificado por laboratorio credenciado, notificado para Ensayos Tipo Inicial (ITT) de acuerdo con la norma de producto EN 14351-1 para efectos de Marcado CE.

Categorías alcanzadas en los ensayos del sistema CT tipologia ventana:

1. Permeabilidad al aire: Clase 3 (norma de ensayo EN 1026)
2. Estanqueidad al agua: Clase 7A (norma de ensayo EN 1027)
3. Resistencia al viento: Clase C5 (norma de ensayo EN 12211)

Categorías alcanzadas en los ensayos del sistema CT tipologia puerta:

1. Permeabilidad al aire: Clase 4 (norma de ensayo EN 1026)
2. Estanqueidad al agua: Clase 7A (norma de ensayo EN 1027)
3. Resistencia al viento: Clase C2 (norma de ensayo EN 12211)

Coefficiente de transmisión térmica de hueco de 2 hojas con 1.80 m x 2.20 m con vidrio Ug = 1.0 W/m<sup>2</sup>K con intercalar efecto "Warm Edge": Uw = 1.91 W/m<sup>2</sup>K

Coefficiente de atenuación acústica de hueco de 2 hojas con vidrio 6/14/33.1 acústico: Rw (C; Ctr) = 34 dB (-1; -6)

CT-Euro

Categorías logradas en la evaluación del sistema de ventanas de tipologia de TC:

1. Permeabilidad al aire: Clase 4 (norma de prueba EN 10207 y EN 1026)
2. Estanqueidad al agua: Clase 7A (prueba estándar EN 12208 y EN 1027)
3. Resistencia al viento: Clase C5 (norma de prueba EN 12210 y EN 12211)

Coefficiente de atenuación acústica de 2 hojas con vidrio 33.2 silencio / 10 / 44,2 silencio: Rw (C; Ctr) = 37 dB (-1; -3)

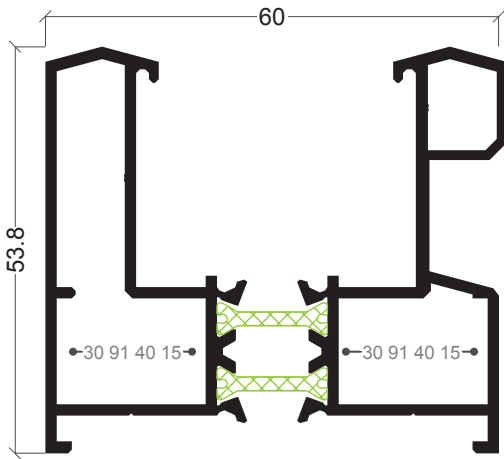

**CT-01**

Aro fixo perimetral  
Marco perimetral

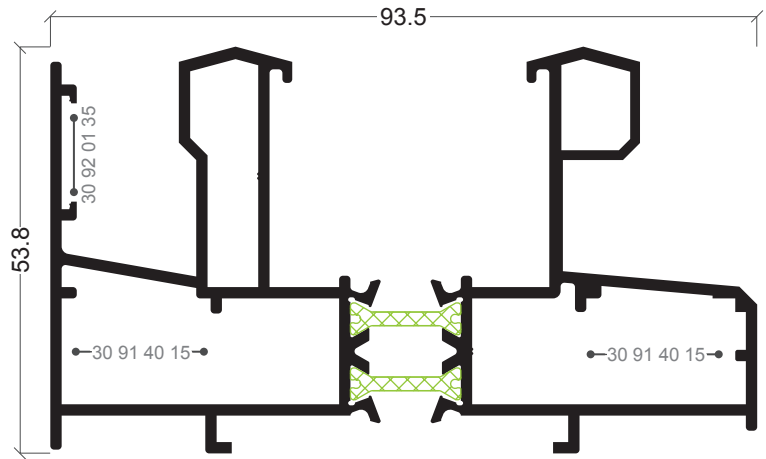

**CT-16**

Aro fixo perimetral  
Marco perimetral con recogida

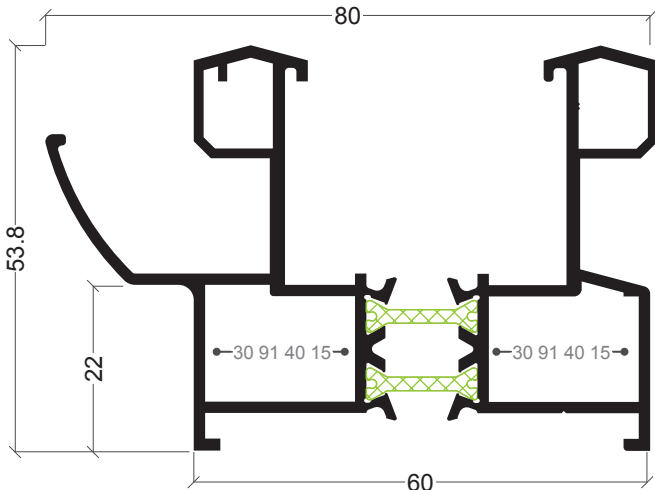

**CT-15**

Aro fixo perimetral  
Marco perimetral con recogida

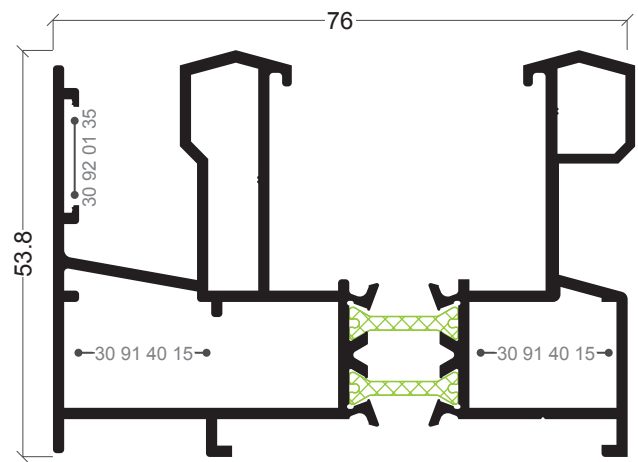

**CT-22**

Aro fixo perimetral  
Marco perimetral con recogida

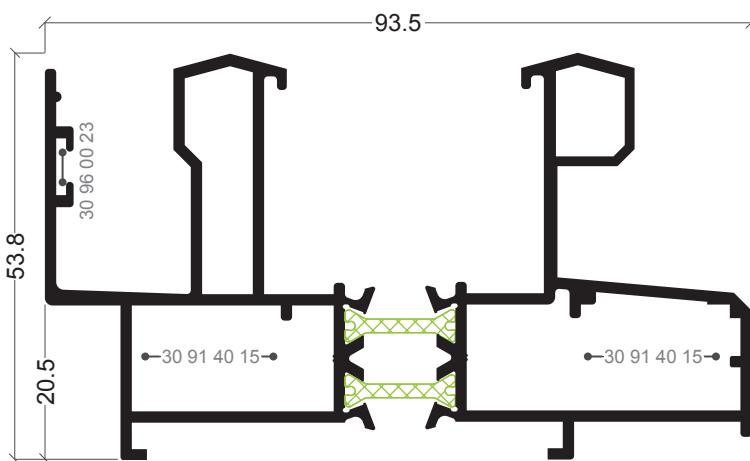

**CT-17**

Aro fixo perimetral  
Marco perimetral con recogida

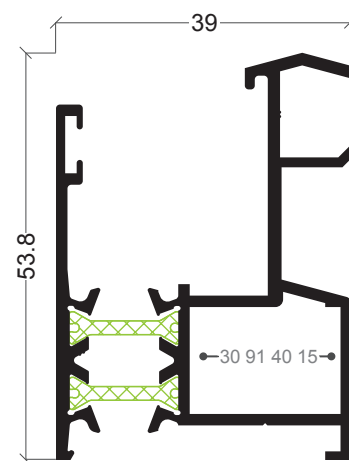

**CT-59**

Aro fixo perimetral mono-rail  
Marco perimetral monocarril

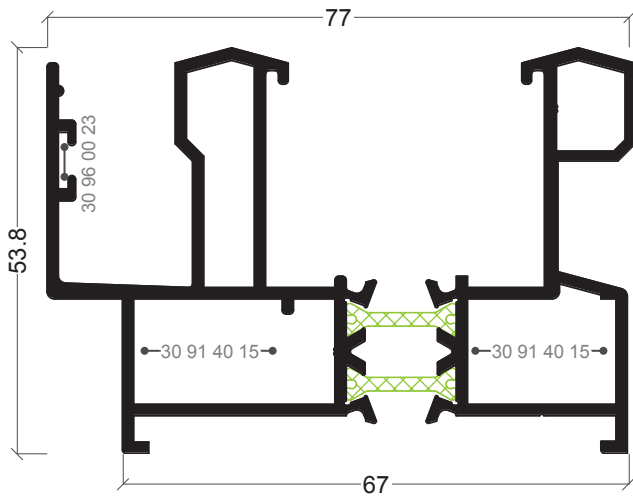

**CT-60**

Aro fixo perimetral  
Marco perimetral con recogida

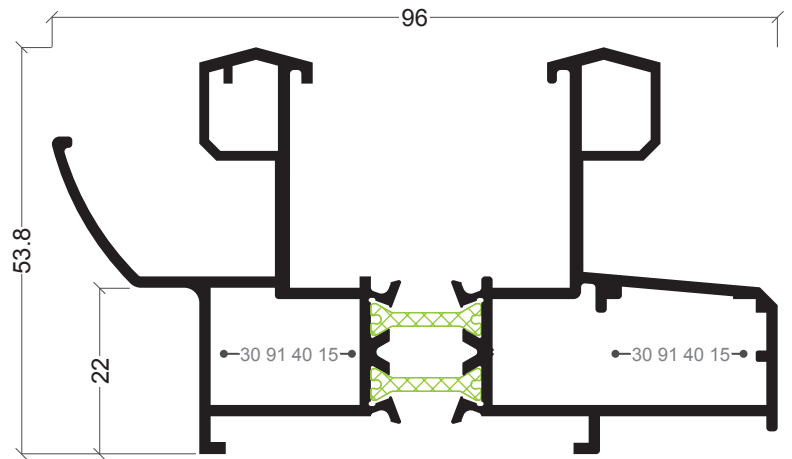

**CT-20**

Aro fixo perimetral  
Marco perimetral con recogida

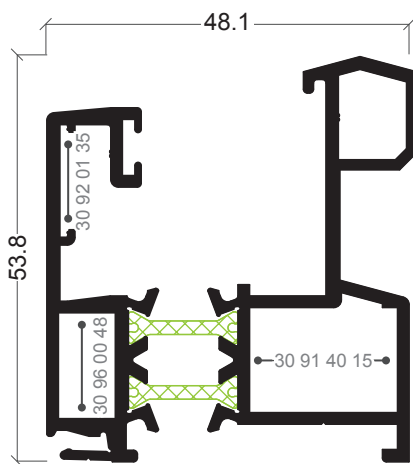

**CT-66**

Aro fixo mono-rail  
Marco mono-rail

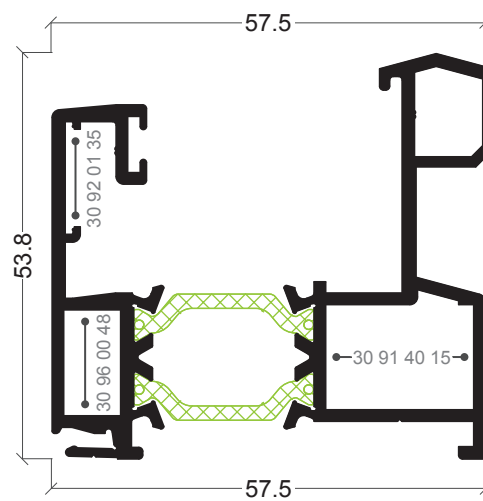

**CT-70**

Aro fixo mono-rail  
Marco mono-rail

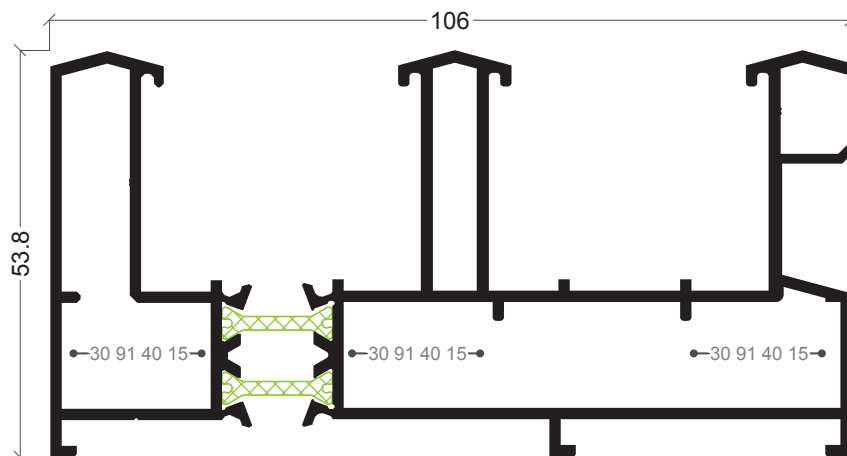

**CT-14**

Aro fixo perimetral tri-rail  
Marco perimetral tricarril

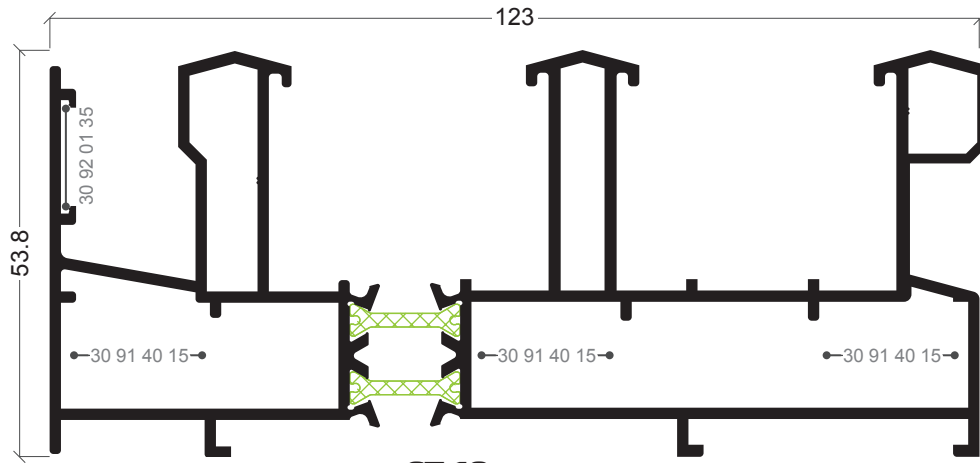

**CT-18**

Aro fixo perimetral tri-rail  
Marco perimetral tricarril con recogida

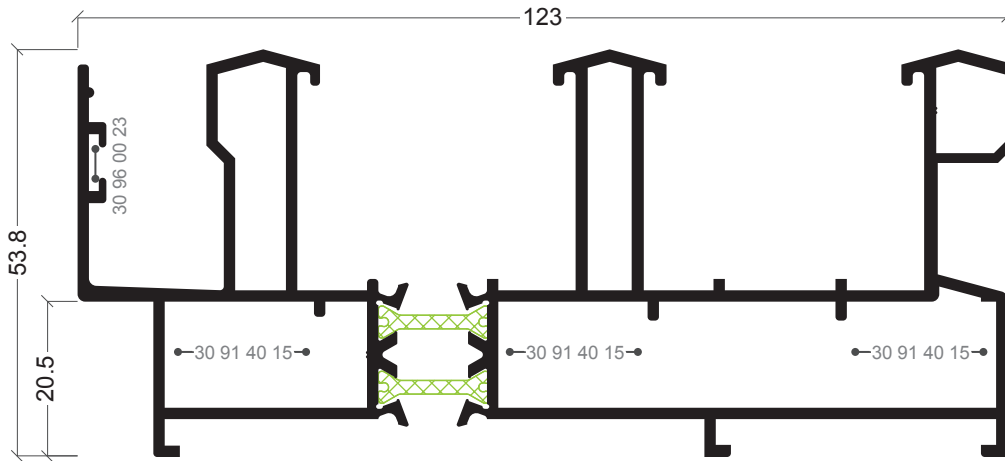

**CT-19**

Aro fixo perimetral tri-rail  
Marco perimetral tricarril con recogida

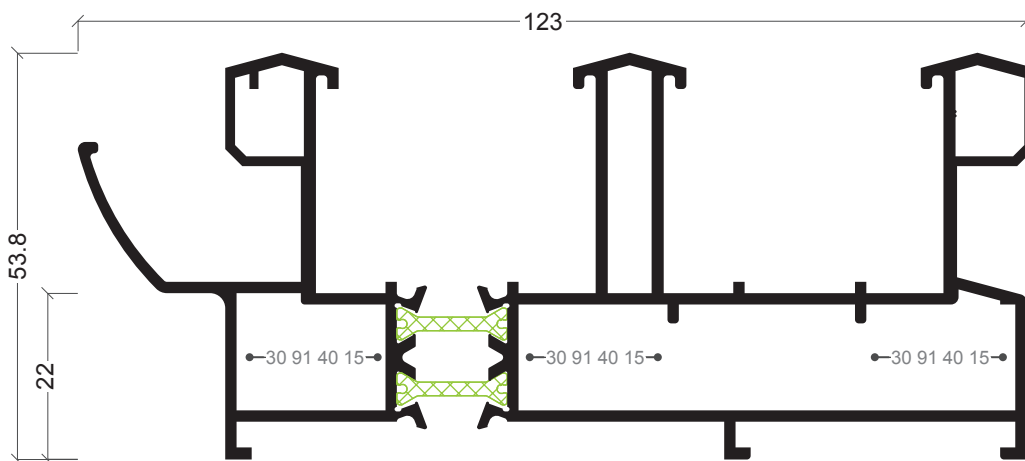

**CT-21**

Aro fixo perimetral tri-rail  
Marco perimetral tricarril con recogida

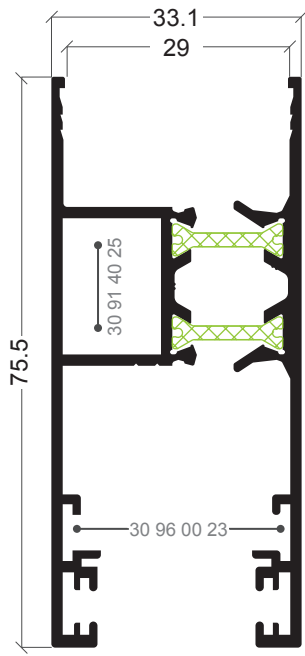

**CT-53**

Aro móvel perimetral recto  
Hoja perimetral recta

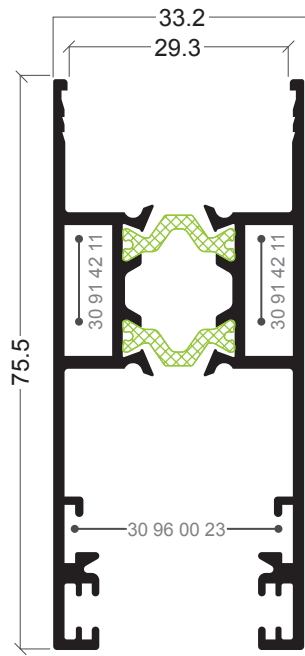

**CT-100**

Aro móvel perimetral recto  
Hoja perimetral recta

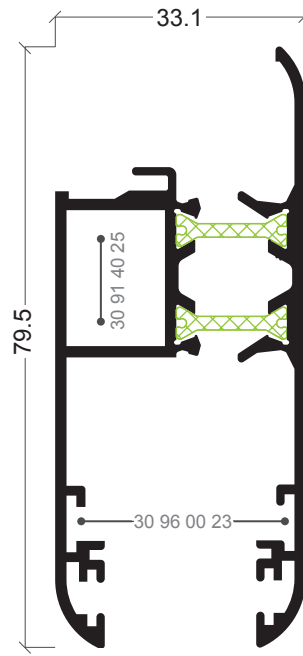

**CT-02**

Aro móvel perimetral com bite  
Hoja perimetral para junquillo

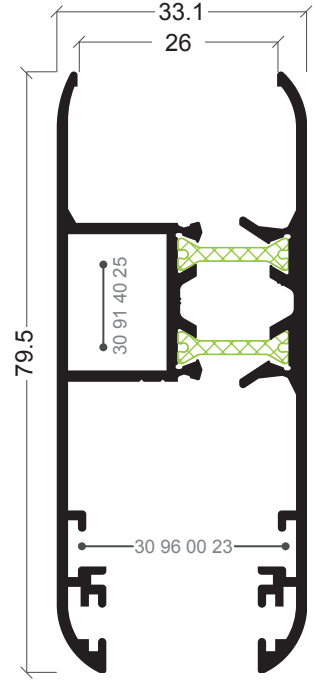

**CT-12**

Aro móvel perimetral  
Hoja perimetral sin junquillo

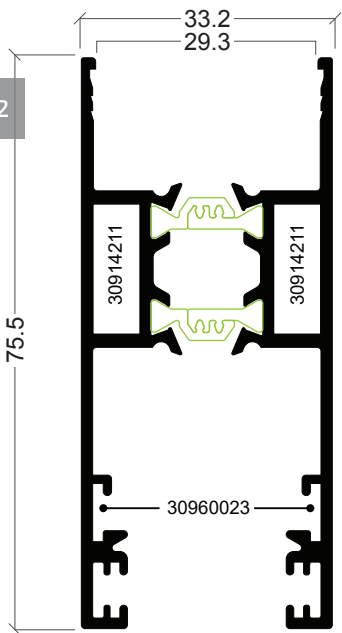

**CT-100/BI**

Aro móvel perimetral recto Anti Bi-metal  
Hoja perimetral recta Anti Bimetal

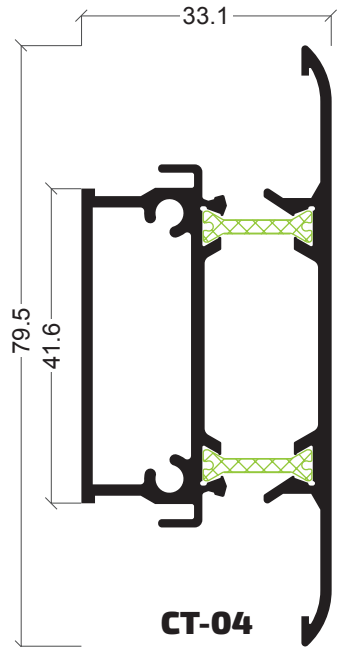

**CT-04**

Travessa com bite  
Travesaño hoja perimetral

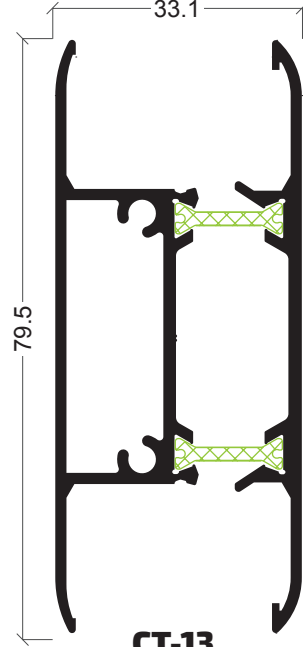

**CT-13**

Travessa sem bite  
Travesaño hoja perimetral

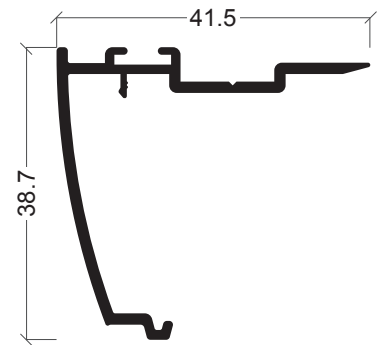

**CT-06**

Tampa cruzamento aro móvel  
Tope curva cruze 2 hojas

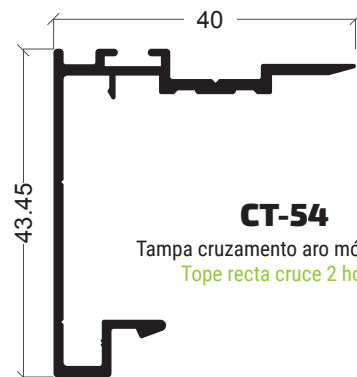

**CT-54**

Tampa cruzamento aro móvel recto  
Tope recta cruze 2 hojas

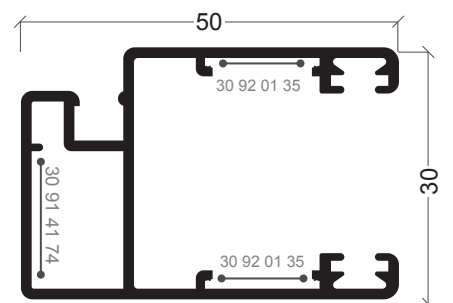

**CT-73**

Perfil para rede mosquiteira  
Perfil para mosquiteira

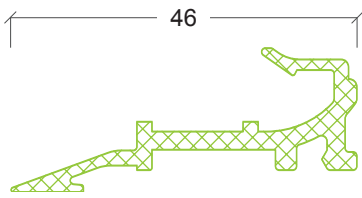

**CT-08**

Cruzamento móvel  
Cruce de hojas

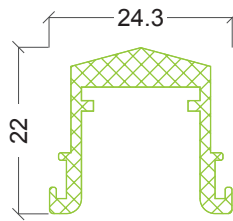

**CT-10**

União 3/4 folhas CT-02/12  
Unión 3/4 hojas CT-02/12

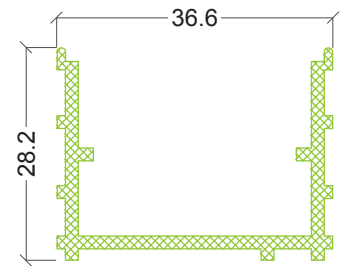

**CT-09**

Tampa aro fixo perimetral CT-01 ou similares  
Tope marco perimetral CT-01 o similar

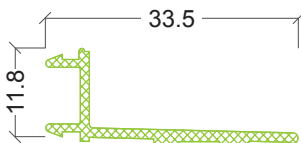

**CT-23**

Tampa aro fixo perimetral CT-41 ou similares  
Tope marco perimetral CT-41 o similar

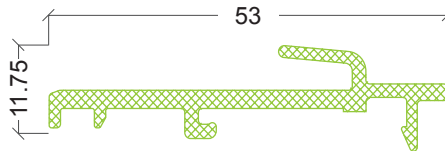

**CT-26**

Cruzamento móvel CT-37/39  
Engatillado hoja central

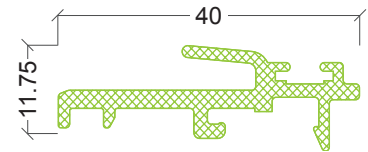

**CT-25**

Cruzamento móvel CT-36/38  
Engatillado hoja central

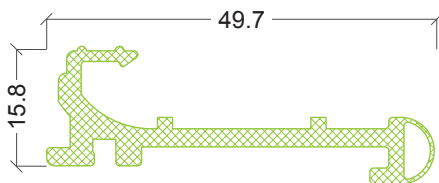

**CTe-04**

Cruzamento para perfil CTe-02  
Engatillado para perfil CTe-02

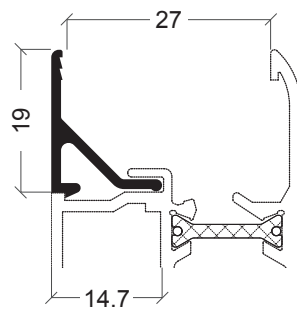

**CT-40**

Bite  
Junquillo

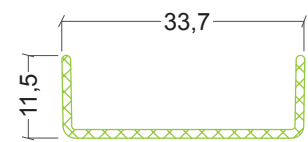

**CT-85**

Tampa para soleira/padreira  
Tapa para marco inf./sup.

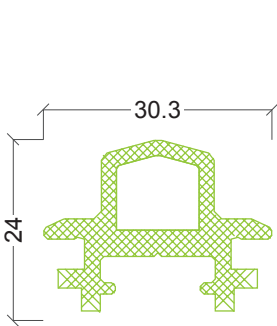

**CT-24**

União 3/4 folhas CT-35/53/100  
Unión 3/4 hojas CT-35/53/100

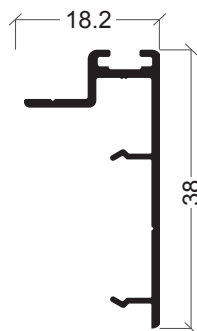

**CT-74**

Tampa  
Tope

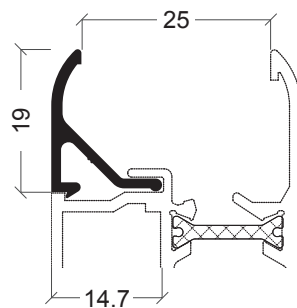

**CT-05**

Bite  
Junquillo

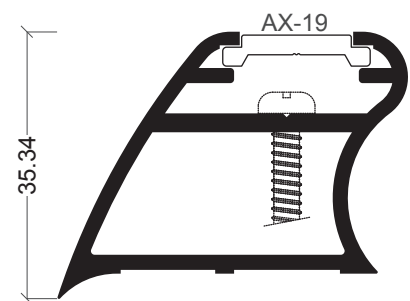

**CT-03**

Reforço  
Refuerzo hoja central

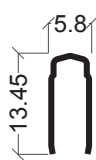

**CT-33**

Guia carril (aco inox 304)  
Guía carril (inox 304)

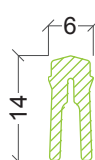

**CT-71**

Guia carril (poliamida)  
Guía carril (poliamida)

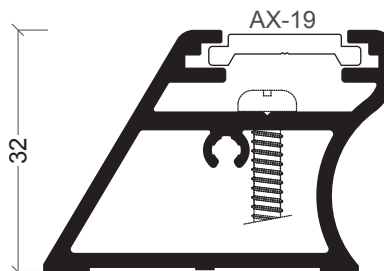

**CT-28**

Reforço  
Refuerzo hoja central

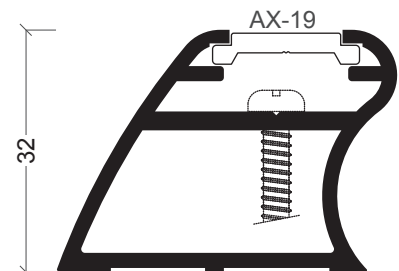

**CT-27**

Reforço  
Refuerzo hoja central



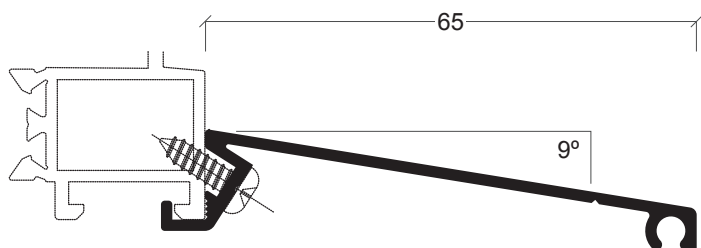

**CT-30**

Pingadeira 65 mm  
Alargadera 65 mm



**CT-102**

Prumo Central Minimal  
Prumo Central Minimal

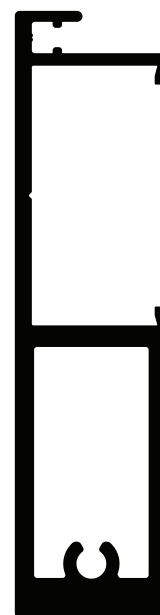

**CT-103**

Prumo central minimal reforçado  
Prumo Central minimal reforçado

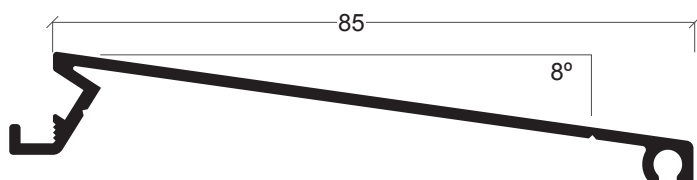

**CT-31**

Pingadeira 85 mm  
Alargadera 85 mm

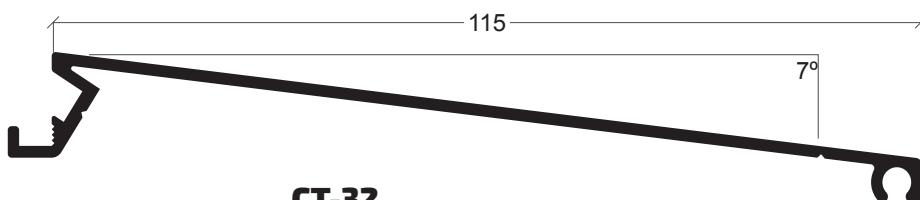

**CT-32**

Pingadeira 115 mm  
Alargadera 115 mm

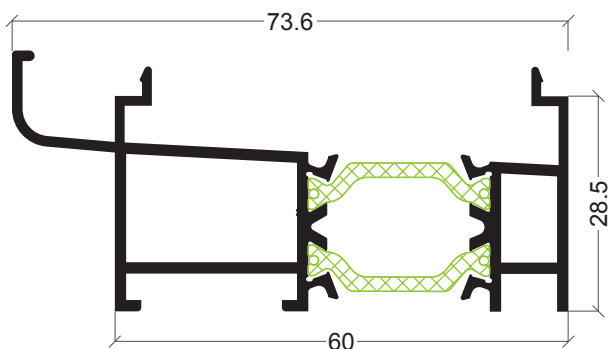

**CT-11**

Soleira condensação  
Condensación

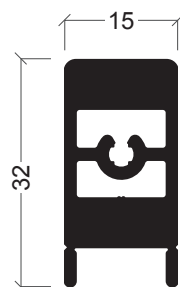

**KL-87**

Perfil de reforço para CT-103  
Perfil de refuerzo para CT-103

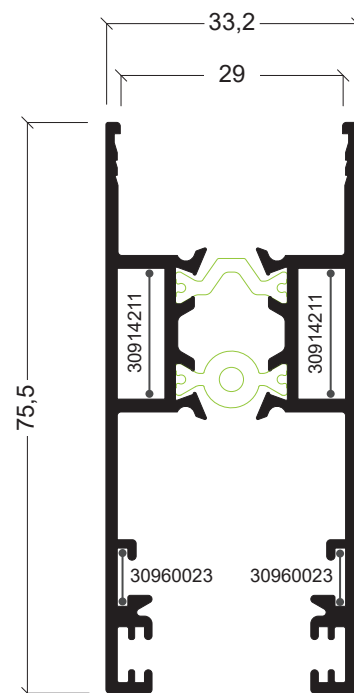

**CT-91**

Aro móvel  
Hoja



**AX-19**

Vareta  
Pletina falleba

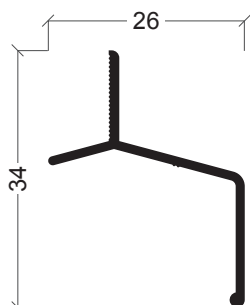

**CT-07**

Pingadeira superior  
Vierteaguas superior

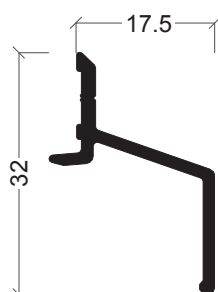

**CT-29**

Pingadeira superior  
Vierteaguas superior



**CT-94**

Perfil união  
Perfil unión

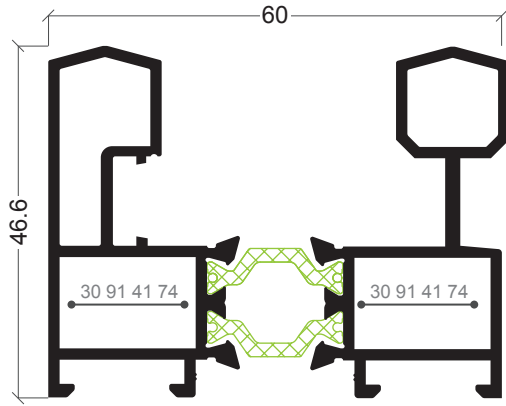

**CT-41**

Aro fixo perimetral  
Marco perimetral

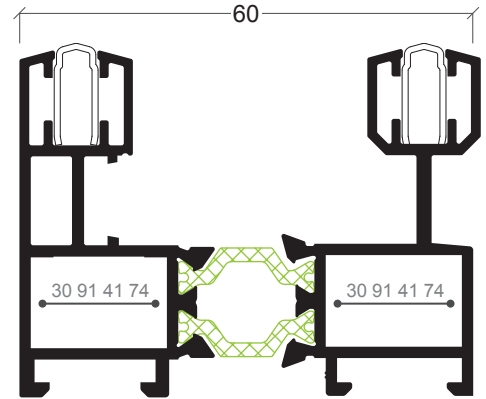

**CT-42**

Aro fixo perimetral  
Marco inferior balconera

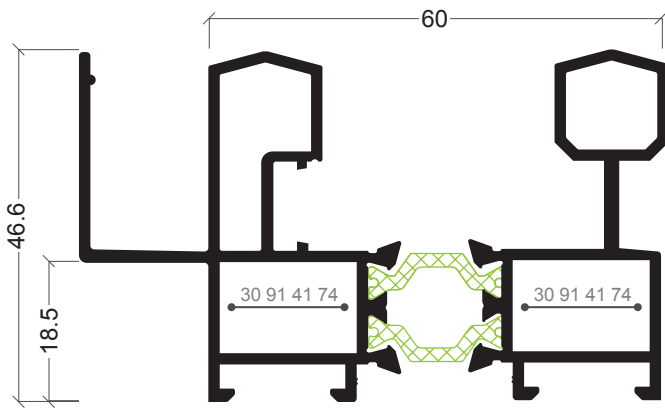

**CT-43**

Aro fixo perimetral  
Marco perimetral con recogida

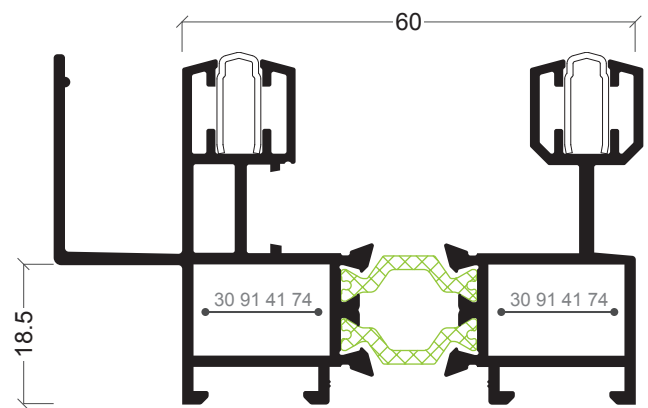

**CT-44**

Aro fixo perimetral  
Marco inferior con recogida

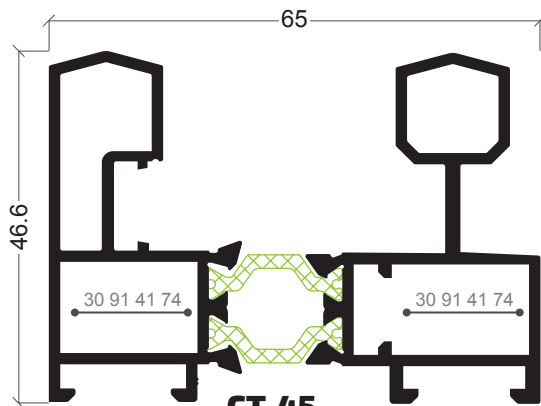

**CT-45**

Aro fixo perimetral  
Marco perimetral

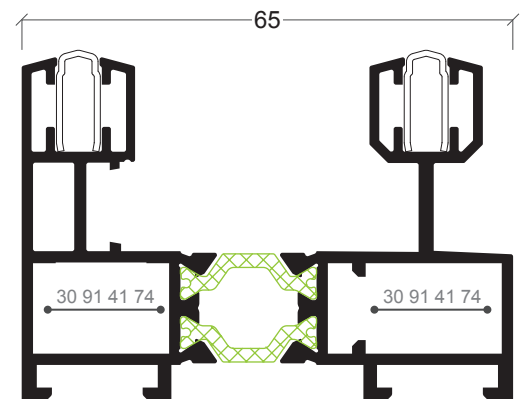

**CT-46**

Aro fixo perimetral  
Marco inferior balconera

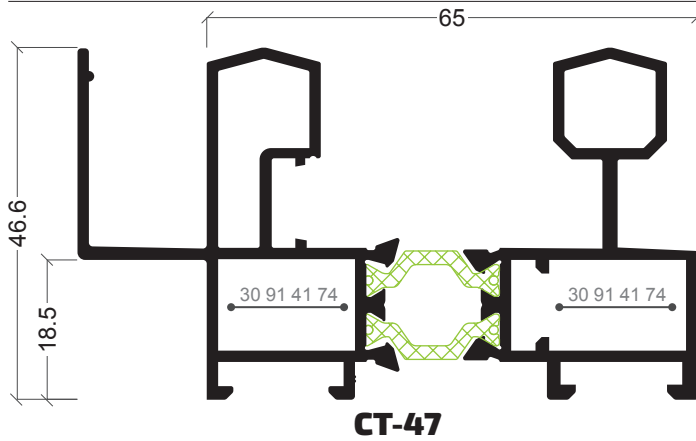

**CT-47**

Aro fijo perimetral  
Marco perimetral con recogida

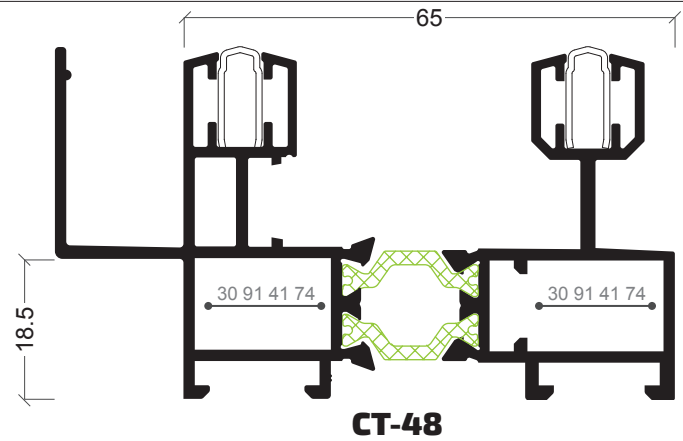

**CT-48**

Aro fijo perimetral  
Marco inferior balconera con recogida

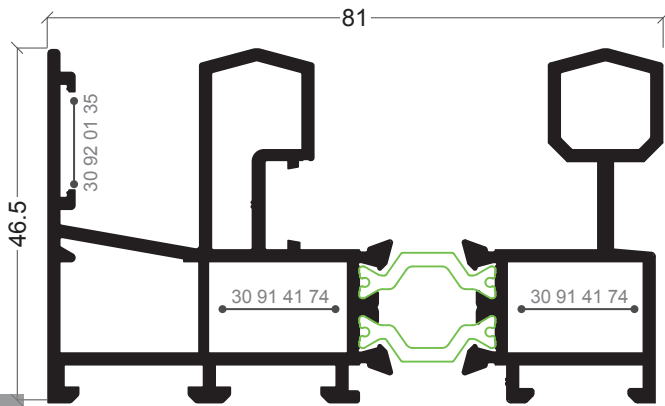

**CT-49**

Aro fijo perimetral  
Marco perimetral con recogida

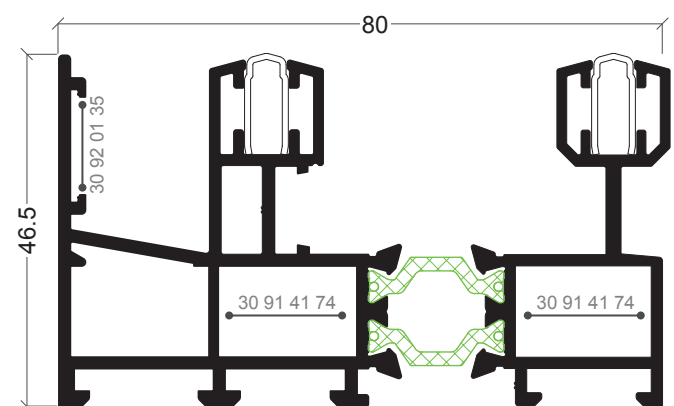

**CT-50**

Aro fijo perimetral  
Marco inferior balconera con recogida

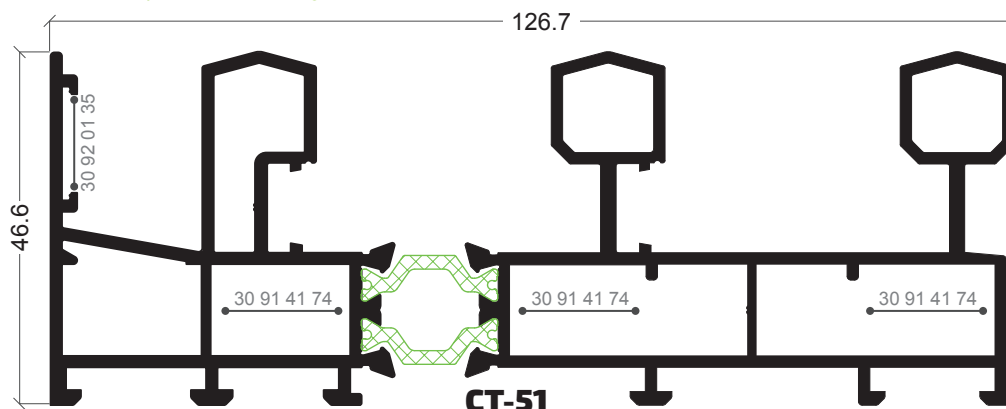

**CT-51**

Aro fijo perimetral tri-rail  
Marco tricarril con recogida

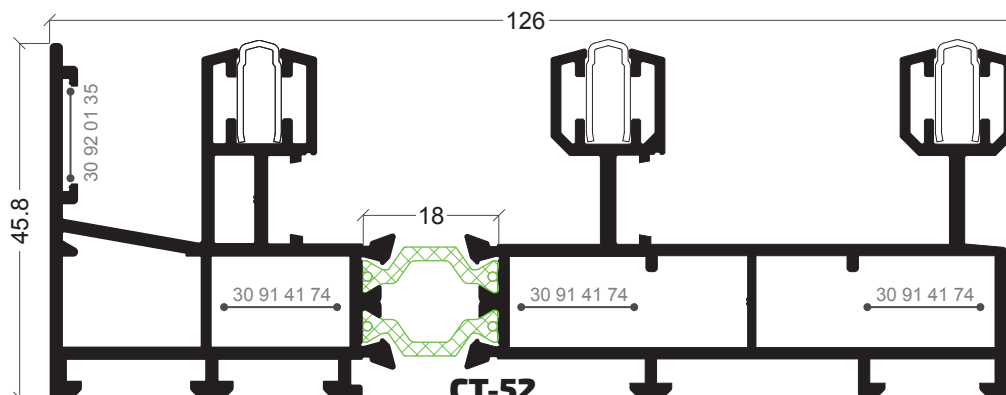

**CT-52**

Aro fijo perimetral tri-rail  
Marco tricarril balconera con recogida

306

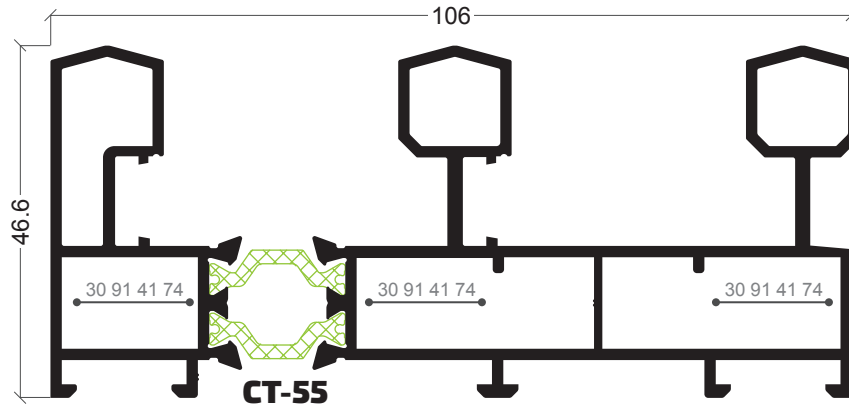

**CT-55**  
Aro fixo perimetral tri-rail  
Marco perimetral tricarril

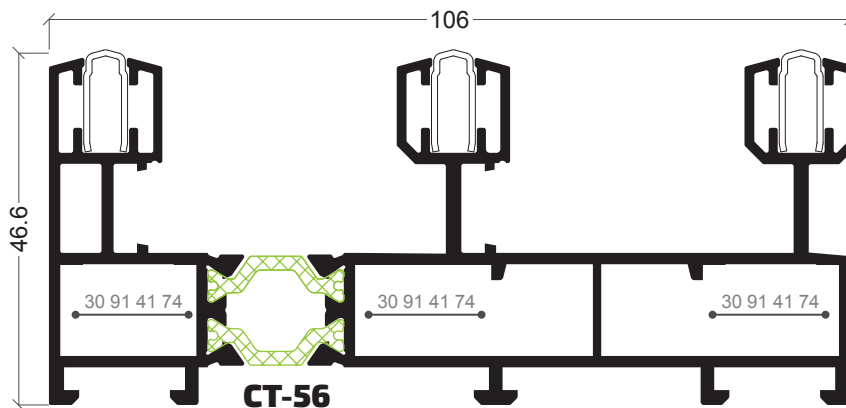

**CT-56**  
Aro fixo perimetral tri-rail  
Marco inferior balconera tricarril

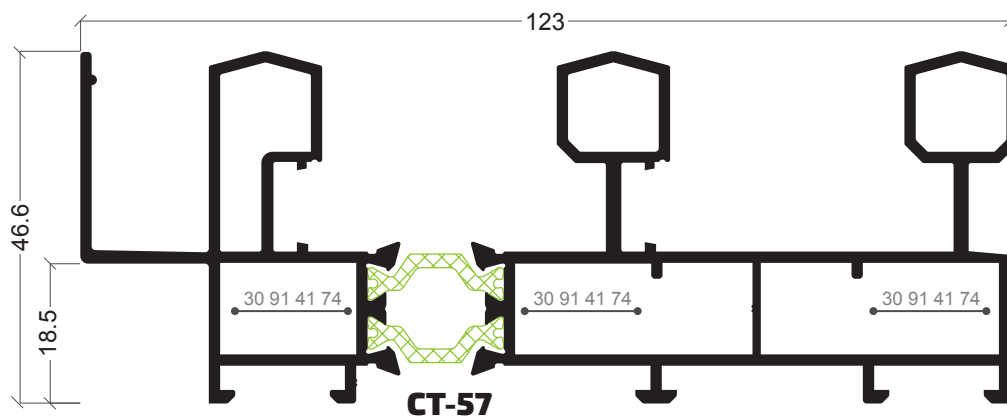

**CT-57**  
Aro fixo perimetral tri-rail  
Marco perimetral tricarril con recogida

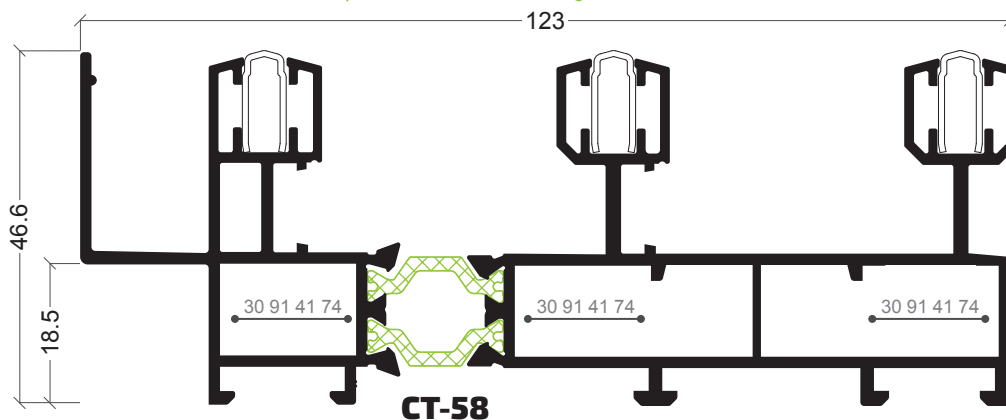

**CT-58**  
Aro fixo perimetral tri-rail  
Marco inferior tricarril con recogida

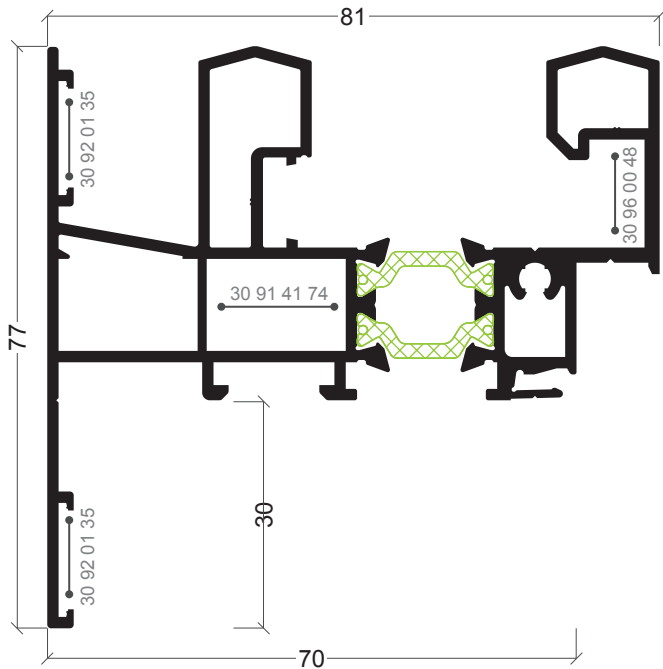

**CT-61**

Aro fixo perimetral c/ aba remate  
Marco perimetral con solape y enganche

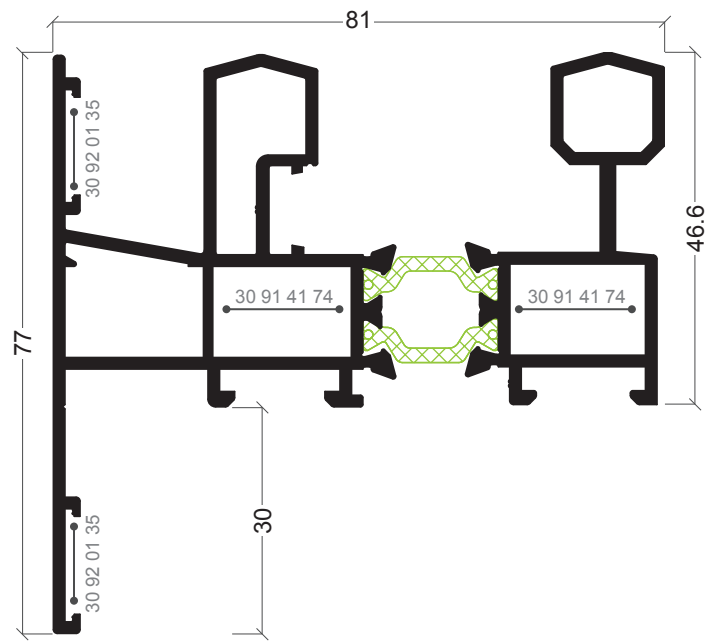

**CT-62**

Aro fixo perimetral c/ aba remate  
Marco perimetral con solape y enganche

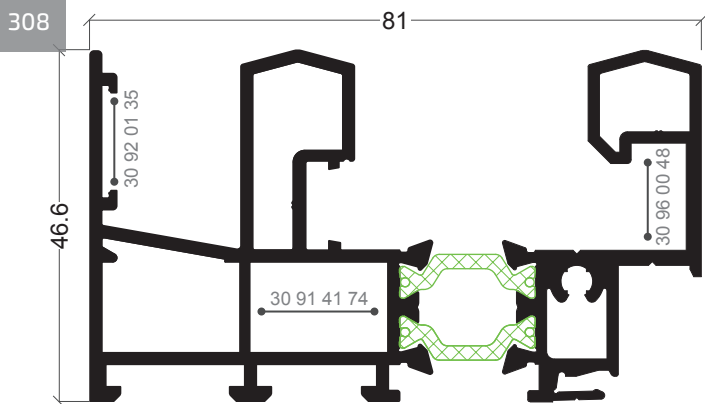

**CT-63**

Aro fixo perimetral  
Marco perimetral con enganche

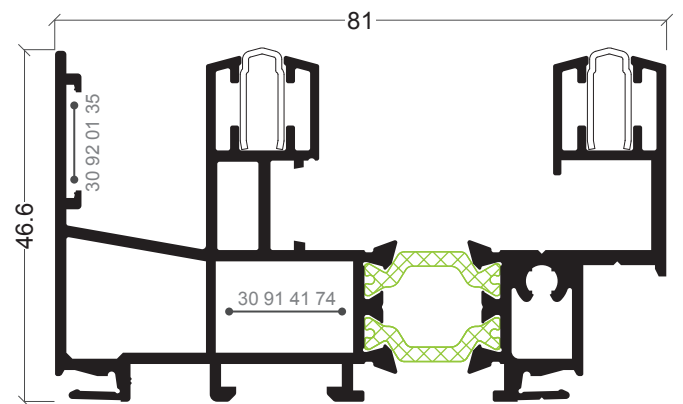

**CT-69**

Aro fixo perimetral  
Marco perimetral inferior con enganches

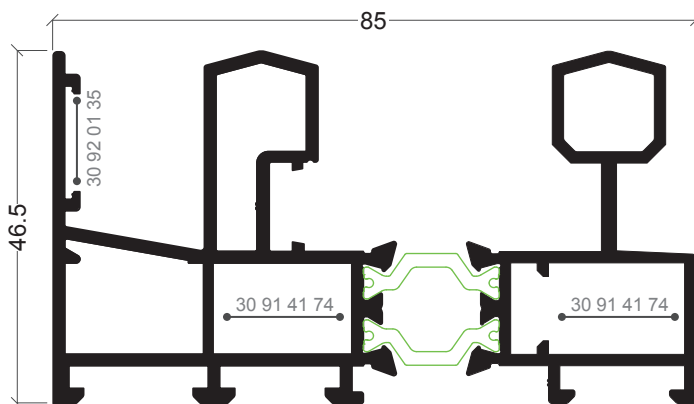

**CT-101**

Aro fixo  
Marco

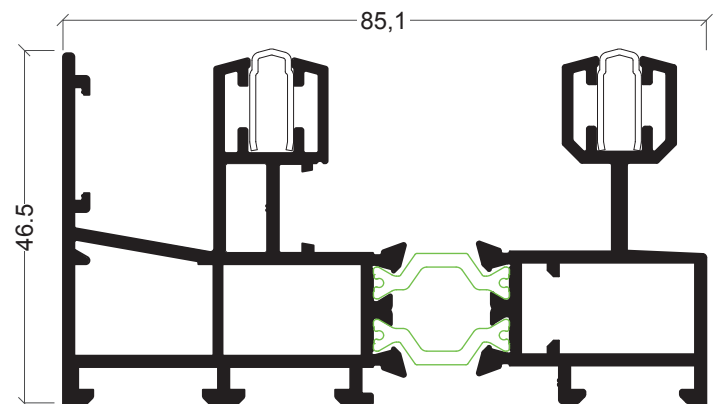

**CT-104**

Aro fixo  
Marco

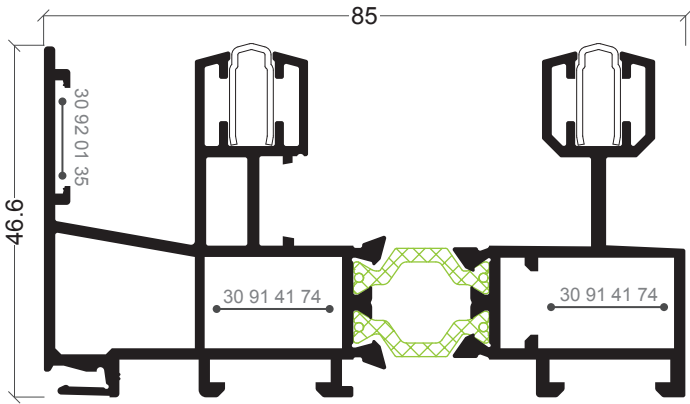

**CT-72**

Aro fixo perimetral  
Marco perimetral

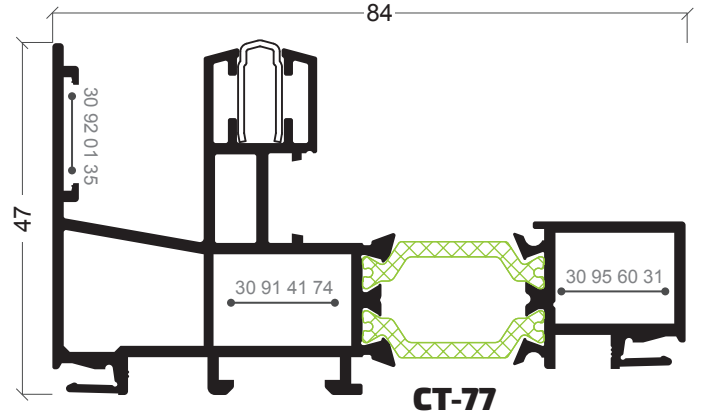

**CT-77**

Aro fixo galandage  
Marco galandage con enganches

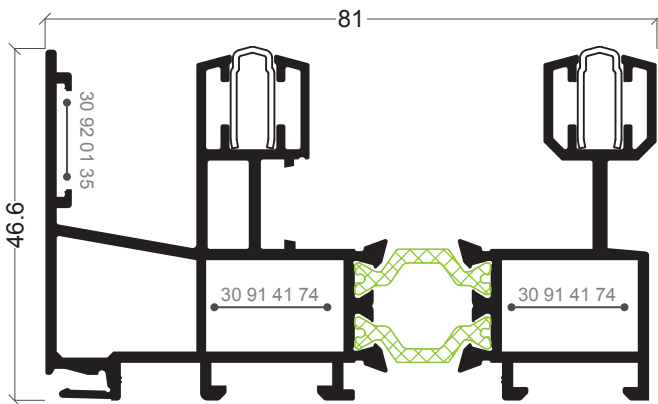

**CT-75**

Aro fixo bi-rail  
Marco perimetral c/ recogida y enganche int.

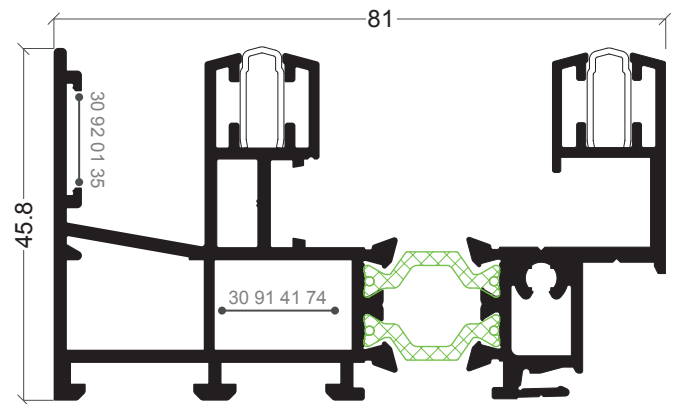

**CT-80**

Aro fixo bi-rail  
Marco bicarril con enganche ext.

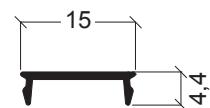

**KL-04**

Tampa  
Tapa

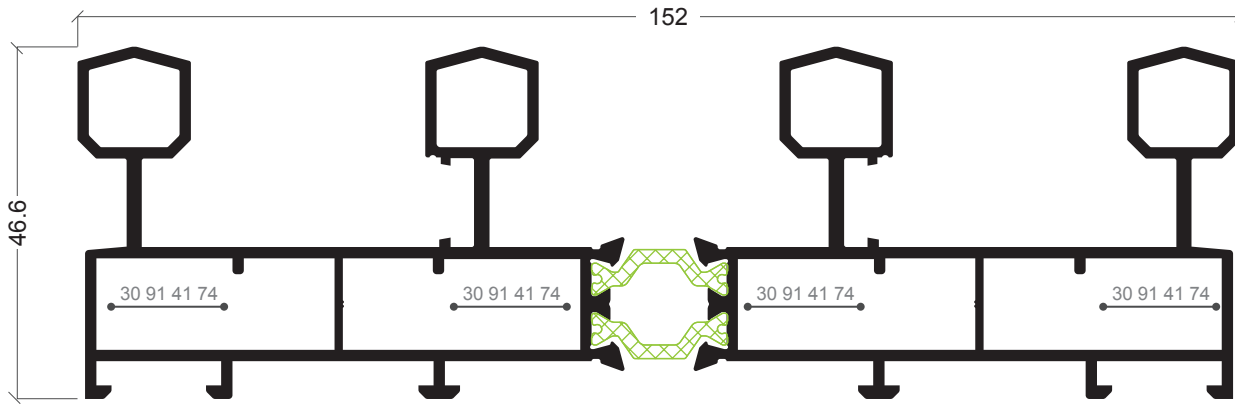

**CT-65**

Aro fixo quadri-rail  
Marco perimetral quatro carriles

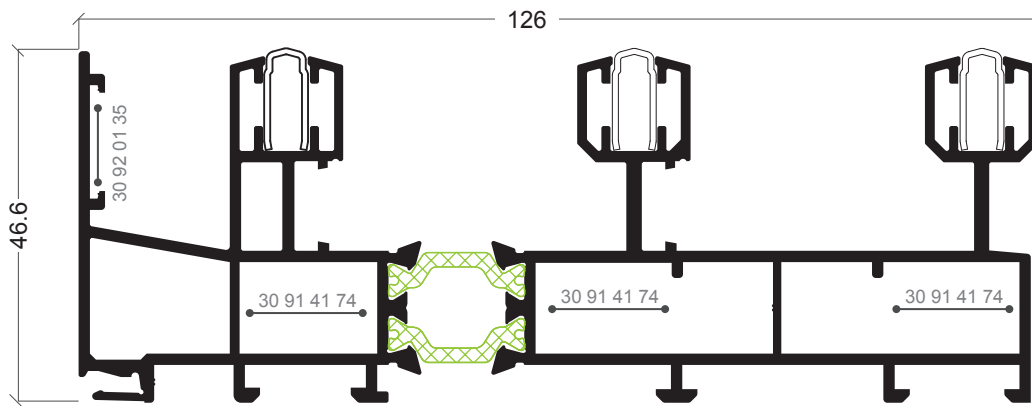

**CT-76**

Aro fixo tri-rail  
Marco inferior tricarril balconera  
con enganche int.

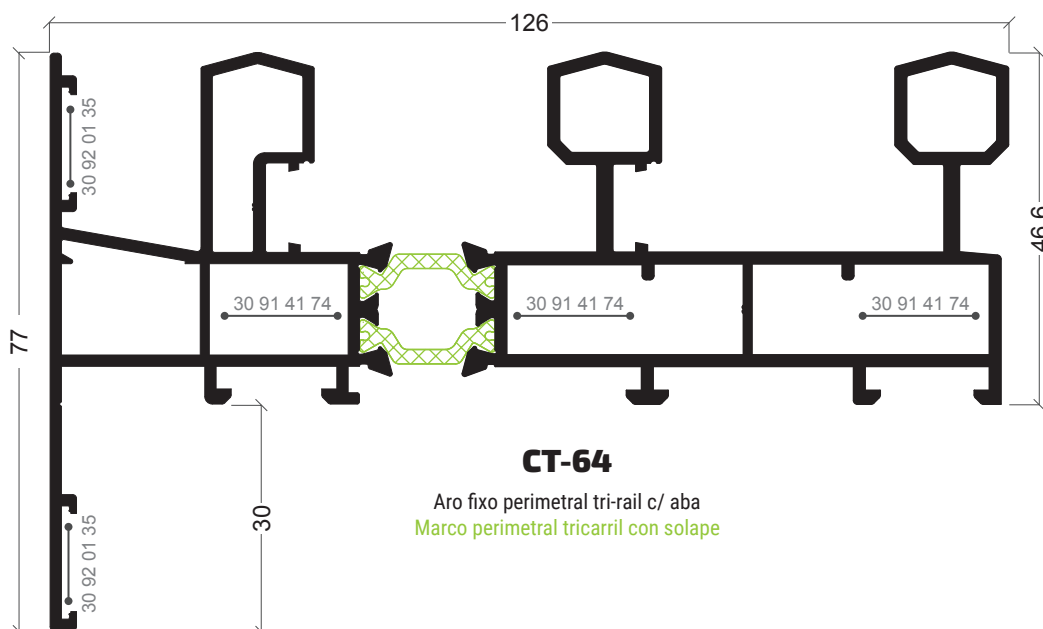

**CT-64**

Aro fixo perimetral tri-rail c/ aba  
Marco perimetral tricarril con solape

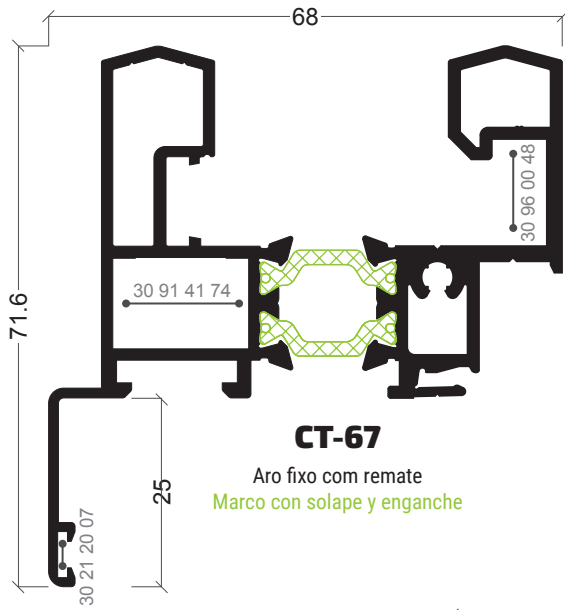

**CT-67**

Aro fixo com remate  
Marco com solape y enganche

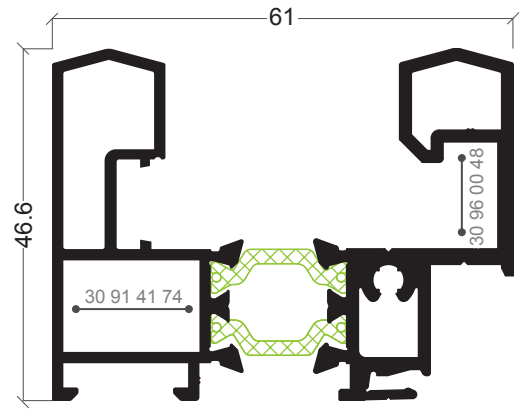

**CT-68**

Aro fixo com remate  
Marco ventana con enganche

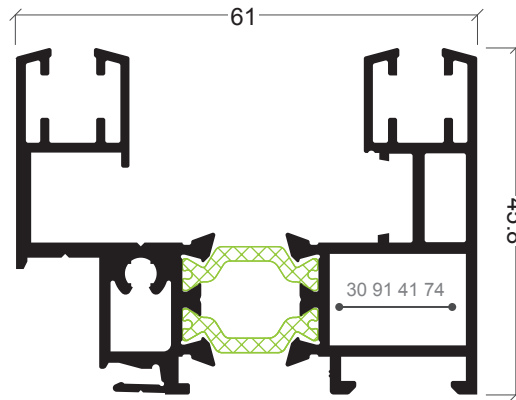

**CT-86**

Aro fixo  
Marco

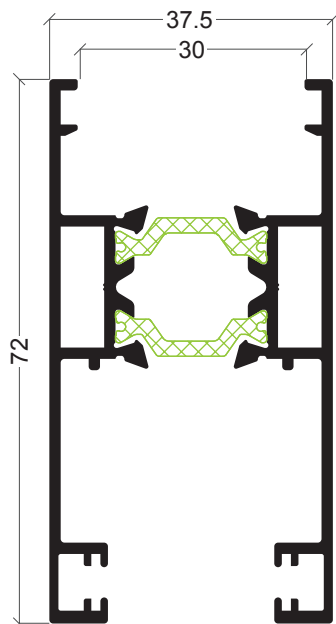

**CT-35**

Aro móvel lateral  
Hoja lateral

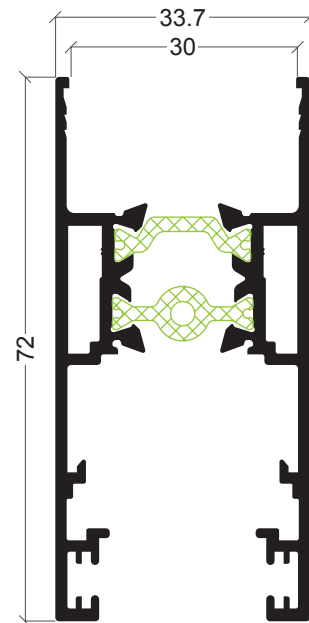

**CT-34**

Aro móvel carrinho  
Hoja de ruedas y superior



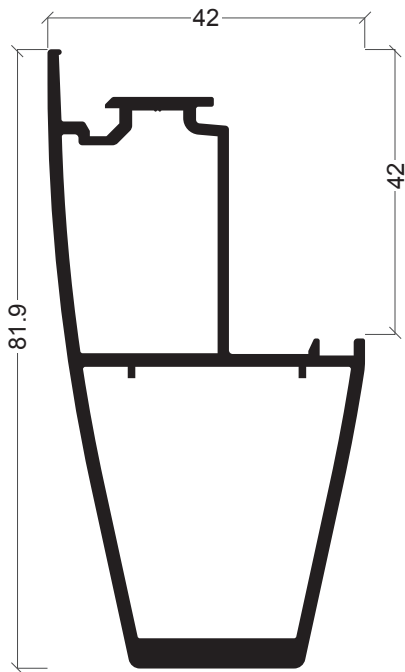

**CT-38**

Aro móvel central com reforço  
Hoja central con refuerzo

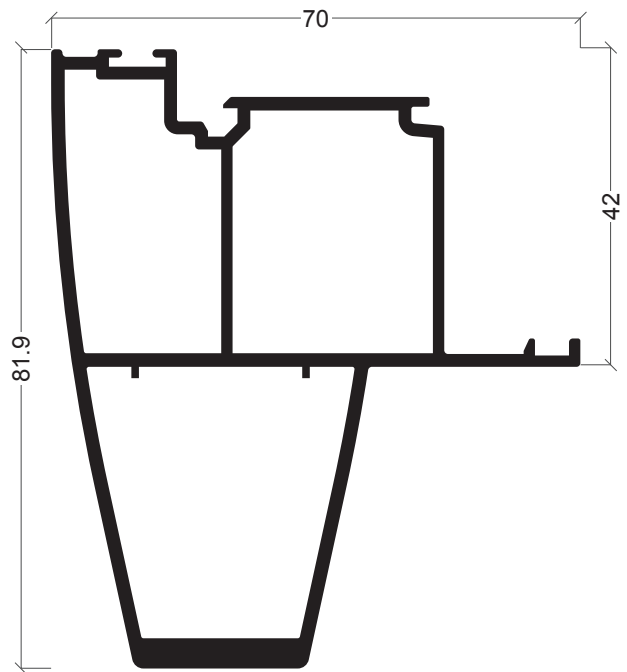

**CT-39**

Aro móvel central com reforço  
Hoja central con refuerzo

312

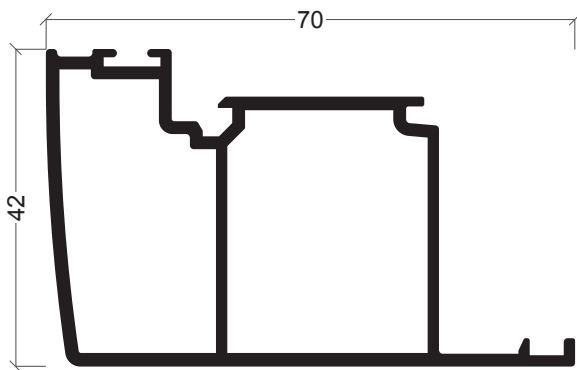

**CT-37**

Aro móvel central  
Hoja central balconera

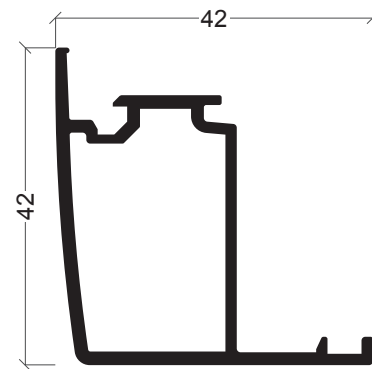

**CT-36**

Aro móvel central  
Hoja central ventana

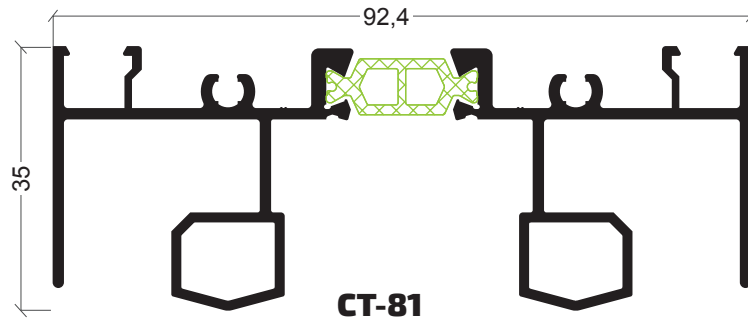

**CT-81**

Padieira  
Marco superior

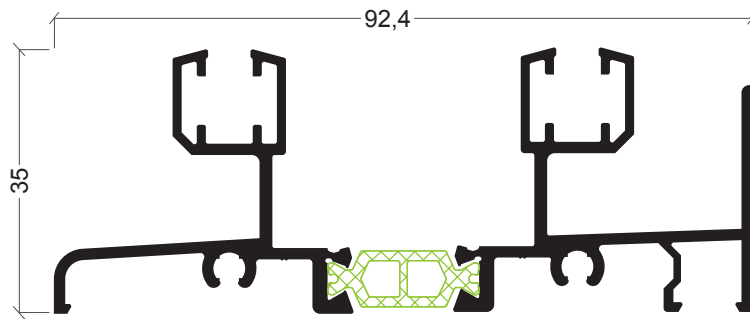

**CT-82**

Soleira  
Marco inferior

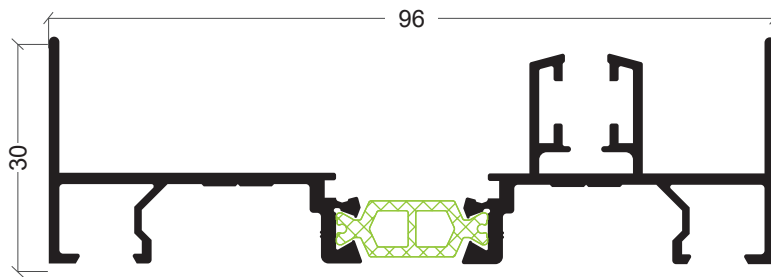

**CT-83**

Ombreira 115 mm  
Alargadera 115 mm

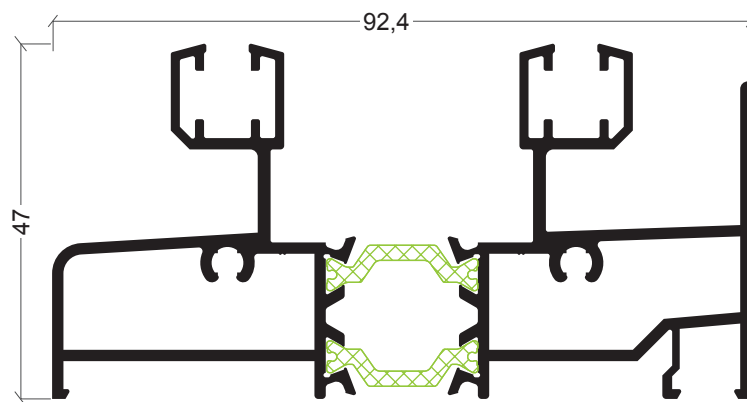

**CT-84**

Soleira  
Marco inferior

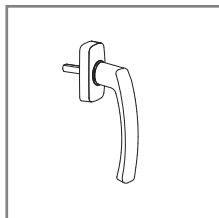

**30 60 16 40/41/42**

Puxador de Alumínio  
Manilha de Alumínio

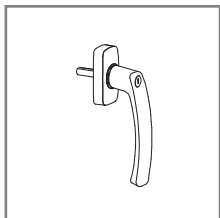

**30 60 16 43/44**

Puxador de Alumínio Champ AC/Inox AC  
Manilha de Alumínio Champ AC/Inox AC

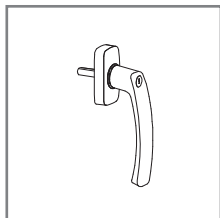

**30 60 16 45/46/47**

Puxador de Alumínio c/chave  
Manilha de Alumínio c/llave

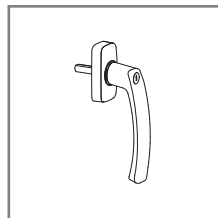

**30 60 16 47/48**

Puxador de Alumínio c/chave Nat. AC/Ch. AC.  
Manilha de Alumínio c/llave Nat. AC/Ch. AC.

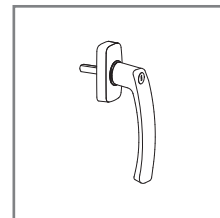

**30 60 16 49**

Puxador de Alumínio c/ chave Inox AC.  
Manilha de Alumínio c/ llave Inox AC.

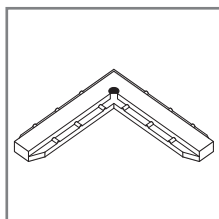

**30 21 20 07**

Esquadro de alinhamento  
Escuadra de alineamiento

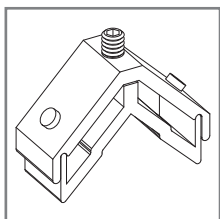

**30 91 40 15**

Esquadro aro fixo  
Escuadra marco

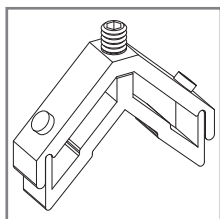

**30 91 40 25**

Esquadro aro móvel  
Escuadra hoja

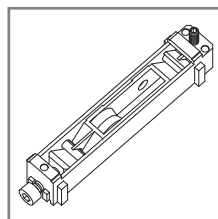

**30 91 40 35**

Rolamento simples (25Kg por rolamento)  
Rodamiento simples (25Kg por rodamiento)

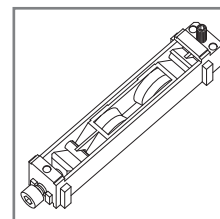

**30 91 40 36**

Rolamento duplo (50Kg por rolamento)  
Rodamiento doble (50Kg por rodamiento)

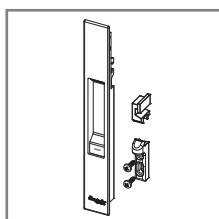

**30 91 40 39/40/41**

Fecho lateral manual natural branco/preto  
Cierre lateral manual natural/blanco/negro

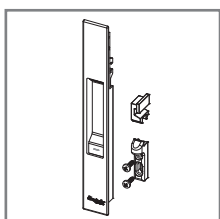

**30 91 40 42/43**

Fecho lateral de embutir branco/preto  
Cierre lateral de embutir blanco/negro

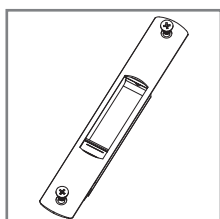

**30 91 40 45/46**

Fecho lateral com fixação branco/preto  
Cierre lateral con fijación blanco/negro

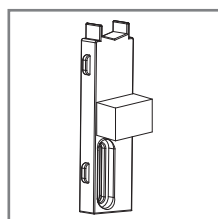

**30 91 40 50**

Guia lateral batente  
Guia lateral batiente

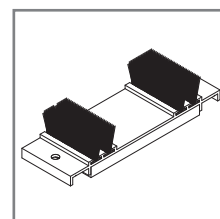

**30 91 40 70**

Cortaventos superior/inferior  
Cortavientos superior/inferior

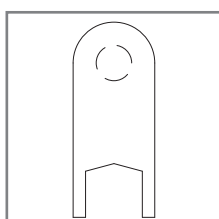

**30 91 41 00**

Tampa aro móvel recta  
Tope hoja recta

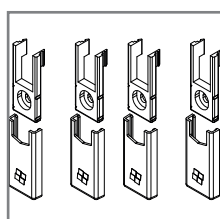

**30 91 41 01**

Conjunto Guias CT Minimal Preto  
Conjunto Guias CT Minimal Negro

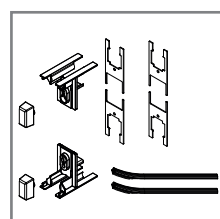

**30 91 41 02**

Kit lateral CT Minimal Preto  
Kit lateral CT Minimal Negro

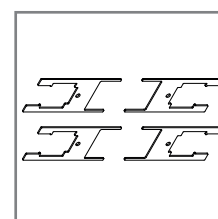

**30 91 41 03**

Kit estanquidade CT Minimal  
Kit Estanquidad CT Minimal

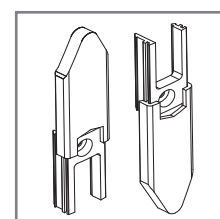

**30 91 41 05**

Jogo topos laterais  
Juego topes laterales

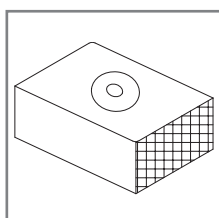

**30 91 41 10**

Taco anti-levantamento preto  
Taco antilevantamiento negro

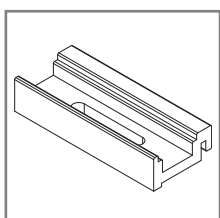

**30 91 41 20**

Calço n° 1 para multiponto CT-02/12/53  
Suplemento n° 1 para multipunto CT-02/12/53

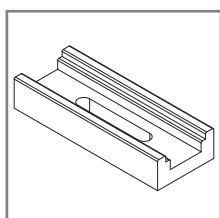

**30 91 41 21**

Calço n° 2 para multiponto CT-35  
Suplemento n° 2 para multipunto CT-35

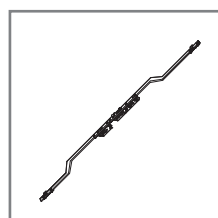

**30 91 41 22**

Ferragem MP c/ chave sem canhão  
Herraje MP c/ llave sin cilindro

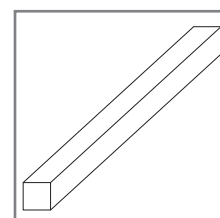

**30 91 41 23**

Perno 7x131 mm  
Perno 7x131 mm

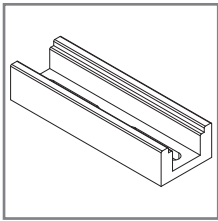

**30 91 41 24**

Calço nº 3 para 4F ou ferragens inox  
Suplemento nº 3 para 4F o ferrages inox



**30 91 41 29**

Barra 4 pontos (1800 mm)  
Barra 4 puntos (1800 mm)

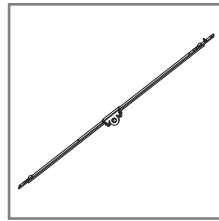

**30 91 41 30**

Barra 2 pontos (600 mm)  
Barra 2 puntos (600 mm)

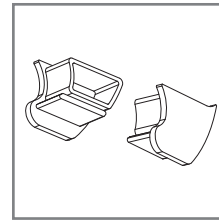

**30 91 41 35**

Jogo topos preto CT-03 / CT-27  
Juego topes negro CT-03 / CT-27

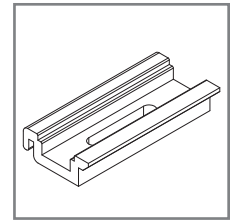

**30 91 41 39**

Calço nº6 para multiponto CT-100  
Suplemento nº6 para multipunto CT-100

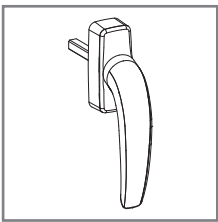

**30 91 41 47/48**

Cremona multi-ponto branco/preto  
Cremona multipunto blanco/negro

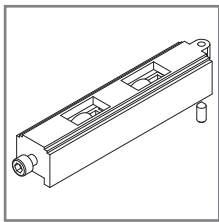

**30 91 41 49**

Rolamento duplo (75 kg por rolamento)  
Rodamiento doble (75 kg por rodamiento)

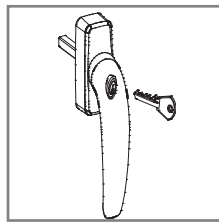

**30 91 41 56/57**

Cremona porta com chave branco/preto  
Cremona puerta con llave blanco/negro

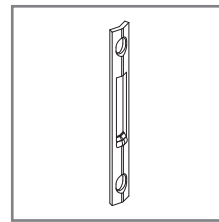

**30 91 41 61**

Ponto de fecho plano (para ferragem inox)  
Punto de cierre plano (para herraje inox)

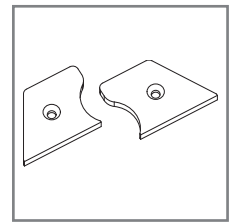

**30 91 41 65/66**

Jogo topos CT-28 branco/preto  
Juego topes CT-28 blanco/negro

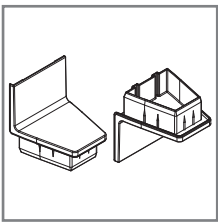

**30 91 41 67/68**

Jogo topos centrais (branco/preto)  
Juego topes centrales (blanco/negro)

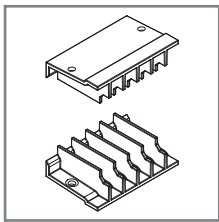

**30 91 41 69**

Cortaventos aro Benelux (CT-36/38)  
Cortavientos marco Benelux (CT-36/38)

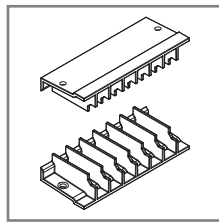

**30 91 41 70**

Cortaventos aro Benelux (CT-02/12/37/39/53)  
Cortavientos marco Benelux (CT-02/12/37/39/53)

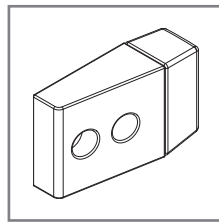

**30 91 41 71**

Topo limitador de abertura  
Tope limitador de apertura

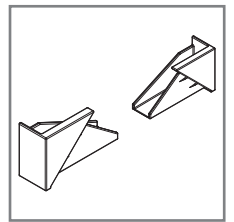

**30 91 41 72/73**

Jogo topos condensação móvel branco/preto  
Juego topes marco condensación blanco/negro

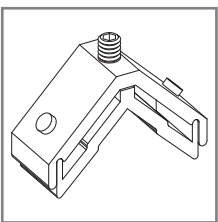

**30 91 41 74**

Esquadro aro perimetral Benelux  
Escuadra marco perimetral Benelux

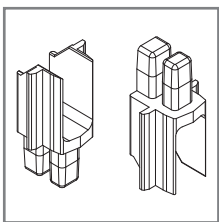

**30 91 41 89**

Conjunto topos CT-24 preto  
Conjunto topes CT-24 negro

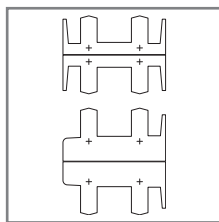

**30 91 41 93/94**

Kit estanquidade CT Euro nº 1 / CT Euro nº 2  
Kit estanquidad CT Euro nº 1 / CT Euro nº 2

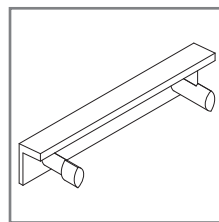

**30 91 41 96/97**

Goteira CT Euro branco/preto  
Vierteaguas CT Euro blanco/negro

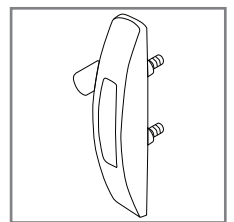

**30 91 42 00/01**

Fecho janela multiponto branco/preto  
Cierre ventana multipunto blanco/negro

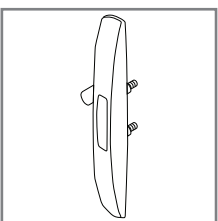

**30 91 42 05/06**

Fecho porta multiponto branco/preto  
Cierre puerta multipunto blanco/negro

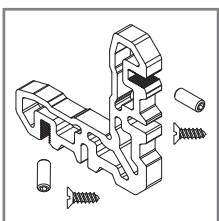

**30 91 42 11**

Esquadro de alumínio para perfil CT-100  
Escuadra de aluminio para el perfil CT-100

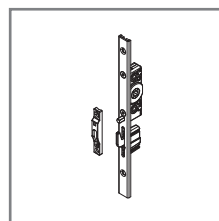

**30 91 42 20**

Barra Monoponto 1 gancho com falsa manobra  
Barra Monopunto 1 gancho

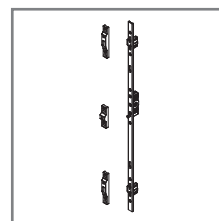

**30 91 42 21**

Barra Multiponto 2 ganchos com falsa manobra  
Barra Multipunto 2 ganchos

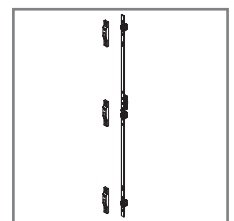

**30 91 42 22**

Barra Multiponto 3 ganchos com falsa manobra  
Barra Multipunto 3 ganchos

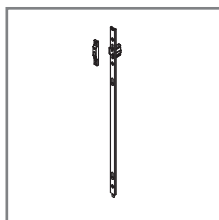

**30 91 42 23**

Extensão superior  
Extensión superior

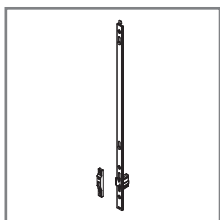

**30 91 42 24**

Extensão inferior para multiponto inox (400mm)  
Extensión inferior para multiponto inox (400mm)

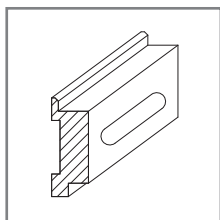

**30 91 42 25**

Calço nº5 para multiponto com falsa manobra (para perfil CT-100)  
Suplemento nº6 para multiponto (para perfil CT-100)

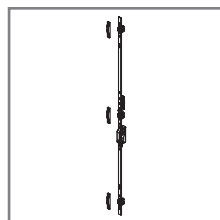

**30 91 42 26**

Barra Multiponto com chave em aço inox (1000mm) com falsa manobra  
Barra multipunto con clave inox (1000mm)

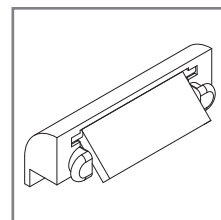

**30 92 01 02/03**

Goteira c/ válvula (preto/branco)  
Tapa salida de aguas c/ válvula negro / blanco

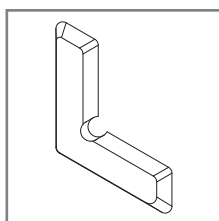

**30 92 01 35**

Esquadro de alinhamento  
Escuadra alineamiento

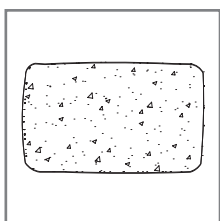

**30 92 04 70**

Espuma isolante  
Espuma aislante

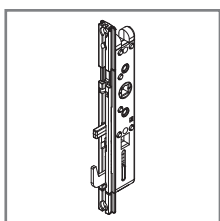

**30 92 07 30**

Ferragem MP regulável inox 1 ponto CT-35  
Herraje MP regulable inox 1 punto CT-35



**30 92 07 35**

Ferragem MP regulável inox 2 pontos CT-35  
Herraje MP regulable inox 2 puntos CT-35

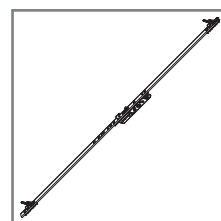

**30 92 07 40**

Ferragem MP regulável inox 3 pontos CT-35  
Herraje MP regulable inox 3 puntos CT-35



**30 92 07 45**

Ferragem MP regulável inox 3 pontos com chave CT-35  
Herraje MP regulable inox 3 puntos con llave CT-35

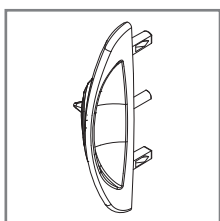

**30 92 07 50/55**

Cremone calipso interior branco/preto (para ferragem inox)  
Manilla calipso interior blanco/negro (p/ herraje inox)

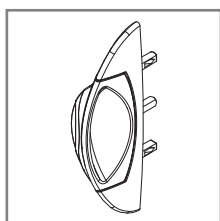

**30 92 07 60/65**

Cremone neptune interior branco/preto (para ferragem inox)  
Manilla neptune interior blanco/negro (p/ herraje inox)

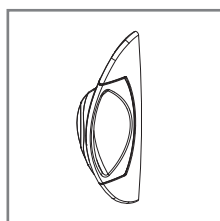

**30 92 07 70/75**

Cremone neptune exterior branco/preto (para ferragem inox)  
Manilla neptune exterior blanco/negro (p/ herraje inox)

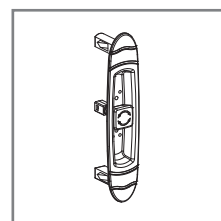

**30 92 07 80/85**

Fecho lateral hera branco/preto (para ferragem inox)  
Cierre lateral hera blanco/negro (p/ herraje inox)

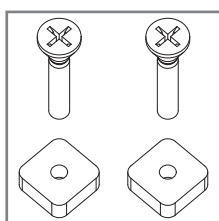

**30 92 07 96**

Placas para pontos de fecho multiponto com carris abertos  
Placas para puntos de cierre multipunto con carriles abiertos

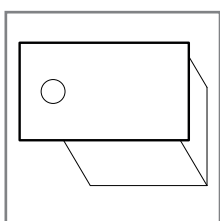

**30 94 60 35**

Topo para CT-103  
Tope para CT-103

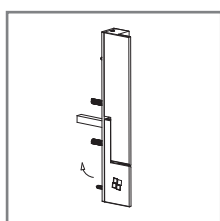

**30 94 60 97/98**

Fecho Minimalista Direito  
Cierre Minimalista Derecho

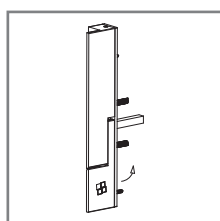

**30 94 60 99/30 94 61 00 30 94 61 60/61/62**

Fecho Minimalista Esquerdo  
Cierre Minimalista Izquierdo

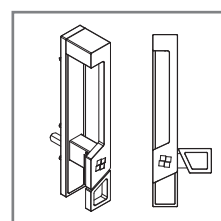

Asa Multiponto WIN Direita branco/preto/2AC  
Asa Multipunto WIN Derecha blanco/negro/2AC

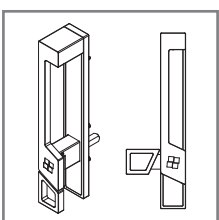

**30 94 61 63/64/65**

Asa Multiponto WIN Esquerda branco/preto/2AC  
Asa Multipunto WIN Izquierda blanco/negro/2AC

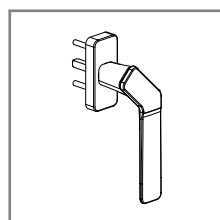

**30 95 60 26/28**

Cremone desviado MP direito branco/preto  
Manilla desplazado MP derecho blanco/negro

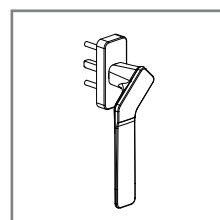

**30 95 60 27/29**

Cremone desviado MP esquerdo branco/preto  
Manilla desplazado MP izquierdo blanco/negro

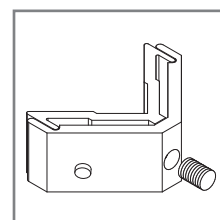

**30 95 60 31**

Esquadro descentrado 15x12  
Escuadra descentrada 15x12

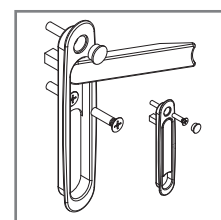

**30 95 60 37/38**

Fecho rotativo Multiponto branco/preto  
Cierre giratorio Multipunto blanco/negro

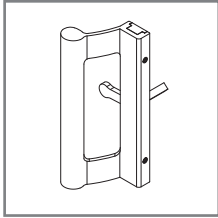

**30 95 60 44/45/46**

Asa Multiponto  
Asa Multipunto

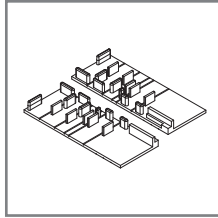

**30 95 60 60**

Conjunto de vedação preto  
Conjunto de vedación negro

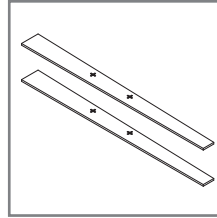

**30 95 60 61**

Conjunto de juntas  
Conjunto de juntas

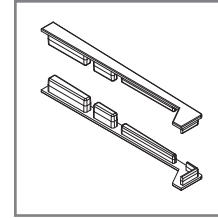

**30 95 60 62**

Conjunto de topos S-36  
Conjunto de topos S-36

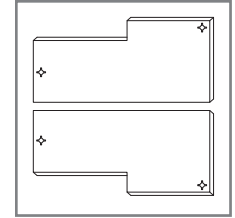

**30 95 60 63**

Conjunto de Juntas de estanquidade CW-28  
Conjunto de Juntas de estanquidad CW-28

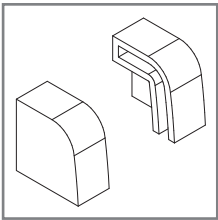

**30 96 00 12**

Jogo topos condensação CT-11/ARI-32  
Juego topos condensación CT-11/ARI-32

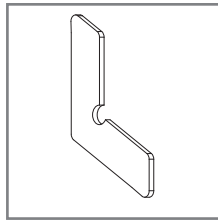

**30 96 00 23**

Esquadro de alinhamento  
Escuadra alineamiento

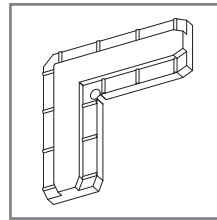

**30 96 00 43**

Esquadro de alinhamento  
Escuadra alineamiento

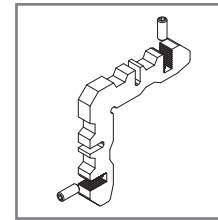

**30 96 00 48**

Esquadro de alinhamento 7x14 c/ parafusos  
Escuadra alineamiento 7x14 c/ tornillos

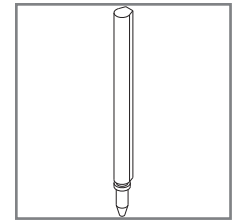

**30 96 00 55**

Perno alternativo para fixação de esquadro  
Perno alternativo para fijación de escuadra

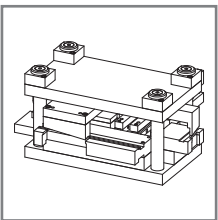

**33 94 29 99**

Cunho CT  
Troquel CT

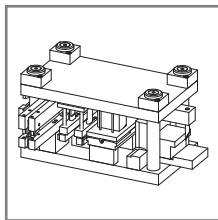

**33 94 30 00**

Cunho CT Benelux  
Troquel CT Benelux

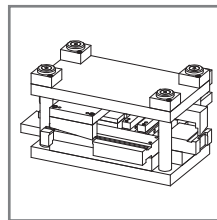

**33 94 30 10**

Cunho CT-Compact  
Troquel CT-Compact

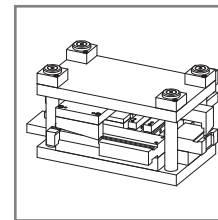

**33 94 30 30/40**

Cunho CT Euro  
Troquel CT Euro

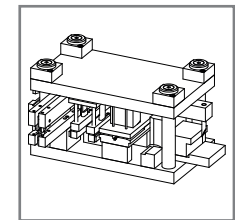

**33 94 30 50**

Cunho CT-100  
Troquel CT-100

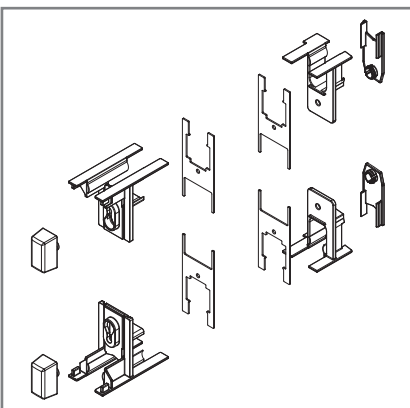

**30 91 41 81**

Kit topos de janela folhas laterais  
Benelux (1 folha)  
Kit topos de ventana hojas laterales  
Benelux (1 hoja)

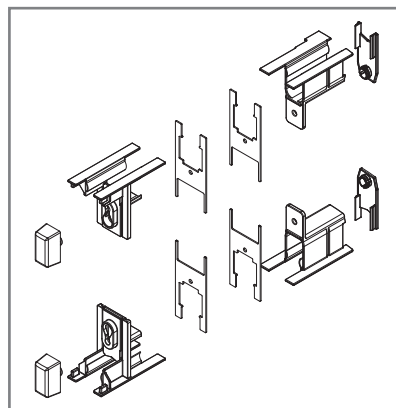

**30 91 41 82**

Kit topos de porta folhas laterais  
Benelux (1 folha)  
Kit topos de puerta hojas laterales  
Benelux (1 hoja)

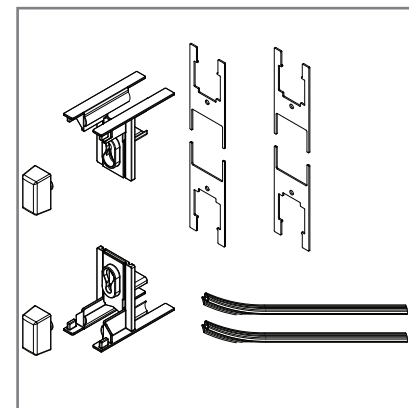

**30 91 41 02**

Kit lateral CT Minimal preto  
Kit lateral CT Minimal negro

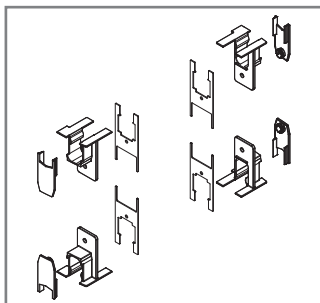

**30 91 41 83**

Kit topos de janela folha central  
Benelux (3ª folha)  
Kit topos de ventana hoja central  
Benelux (3ª hoja)

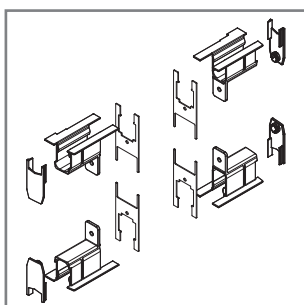

**30 91 41 84**

Kit topos de porta folha central  
Benelux (3ª folha)  
Kit topos de puerta hoja central  
Benelux (3ª hoja)

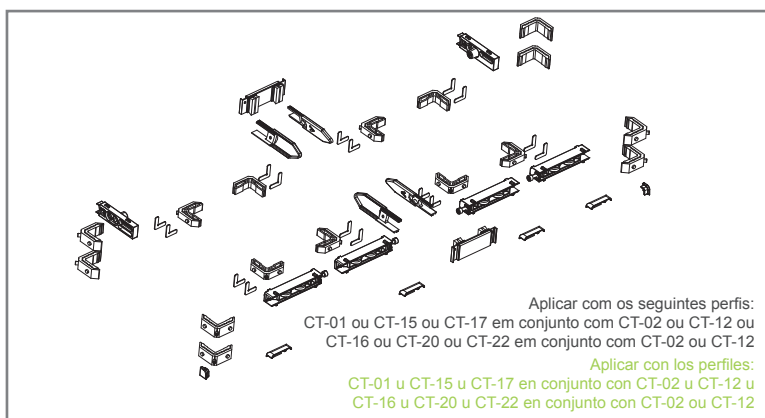

**30 91 41 85**

Kit de correr janela CT (2 folhas). Resistência até 50Kg/folha.  
Utilização em vãos de 2 folhas.  
Kit corredera ventana CT (2 hojas). Resistencia hasta 50Kg/  
hoja. Para huecos de 2 hojas.

**30 91 41 86**

Kit de correr janela CT (2 folhas). Resistência até 100Kg/folha.  
Utilização em vãos de 2 folhas.  
Kit corredera puerta CT (2 hojas). Resistencia hasta 100Kg/hoja.  
para huecos de 2 hojas.

Aplicar com os seguintes perfis:  
CT-01 ou CT-15 ou CT-17 em conjunto com CT-02 ou CT-12 ou  
CT-16 ou CT-20 ou CT-22 em conjunto com CT-02 ou CT-12

Aplicar con los perfiles:  
CT-01 u CT-15 u CT-17 en conjunto con CT-02 u CT-12 u  
CT-16 u CT-20 u CT-22 en conjunto con CT-02 ou CT-12

REFERÊNCIA • REFERENCIA	DESENHO • DISEÑO	DESCRIÇÃO • DESCRIPCIÓN
30 20 30 03		Junta isolante CT-01/11/15/17 • Junta aislante CT-01/11/15/17
30 25 44 15		Junta tapa canal CT-59 • Junta tapa canal CT-59
30 91 40 72		Junta U (vidrio 26mm) CT-53 • Junta U(vidrio 26mm) CT-53
30 91 40 73		Junta U CT-Benelux preto (vidrio 22mm) • Junta U CT-Benelux negro (vidrio 22mm)
30 91 40 74		Junta Central CT Minimal preto • Junta Central CT Minimal
30 91 41 87		Junta tapa canal aberto • Junta tapa carril abierto
30 91 41 88		Junta de correr • Junta corredera
30 91 41 95		Junta aro fixo lateral preto • Junta marco lateral negro
30 93 00 65		Junta interior para vidro (5 mm) • Junta interior para vidrio (8/9 mm)
30 93 00 66		Junta interior para vidro (4 mm) • Junta interior para vidrio (8/9 mm)
30 93 00 67		Junta interior para vidro (2 mm) • Junta interior para vidrio (8/9 mm)
30 93 00 68		Junta interior para vidro (6/7 mm) • Junta interior para vidrio (8/9 mm)
30 93 00 69		Junta interior para vidro (8/9 mm) • Junta interior para vidrio (8/9 mm)
30 95 00 40		Pelúcia 7x5.5 mm STOP-FIN • Burlete 7x5.5 mm STOP-FIN
30 95 00 50		Pelúcia 7x6 mm STOP-FIN • Burlete 7x6 mm STOP-FIN
30 95 00 70		Pelúcia 7x3.5 mm • Burlete 7x3.5 mm
30 95 00 10		Pelúcia 7x9 mm STOP-FIN • Burlete 7x9 mm STOP-FIN

**Janela 2 folhas correr com fecho lateral • Ventana 2 hojas corredera con cierre lateral**
**PERFIS • PERFIS**

DESENHO • DISEÑO	REF.	DESCRIÇÃO • DESCRIPCIÓN	CORTE CORTE	QUANTIDADE CANTIDAD	MEDIDAS • MEDIDA
	CT-41	Aro fixo perimetral Marco perimetral		2	L
			2	H-28.5 mm	
	CT-23	Tampa aro fixo Tope marco perimetral		2	L-40 mm
				2	H-68 mm
	CT-53	Aro móvel perimetral Hoja perimetral recta		4	L/2+1 mm
				4	H-101.5 mm
	CT-54	Tampa cruzamento 2 folhas Tope recta cruze 2 hojas		2	H-101.5 mm
	CT-29	Pingadeira superior Vierteaguas superior		1	L
	CT-08	União cruzamento 2 folhas Cruze de hojas		2	H-101.5 mm
	CT-11	Soleira de condensação Condensación		1	L

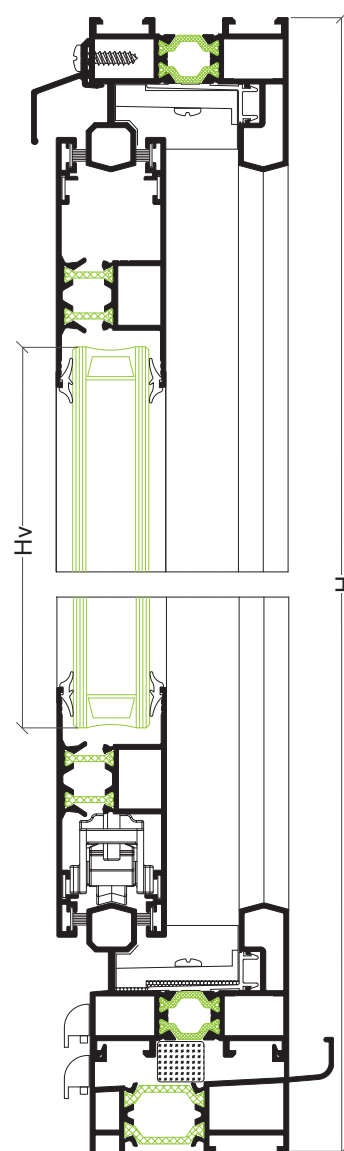
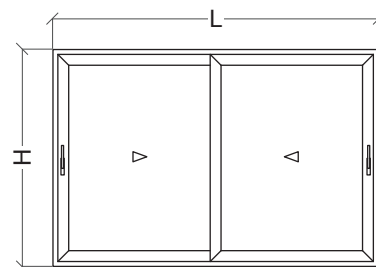

**ACESSÓRIOS E JUNTAS • ACCESORIOS Y JUNTAS**

REF.	DESCRIÇÃO • DESCRIPTION	QUANTIDADE CANTIDAD
30 91 41 74	Esquadro aro fixo • Escuadra marco	8
30 91 40 25	Esquadro aro móvel • Escuadra hoja	8
30 91 40 35	rolamento simples • Rodamiento simples	4
30 91 40 42	Fecho lateral • Cierre lateral	2
30 91 40 50	Guia lateral • Guía lateral	4
30 91 41 00	Tampa móvel recta • Tope hoja recta	4
30 91 41 70	Corta-ventos inferior/superior • Cortavientos inferior/superior	1
30 92 01 02	Goteiras • Tapa salida de aguas	4
30 96 00 12	Jogo topos condensação • Juego topos condensación	1
30 96 00 23	Esquadro alinhamento • Escuadra alineamiento	16
30 91 41 10	Taco anti-levantamento • Taco antilevantamiento	2
30 92 04 70	Espuma isolante • Espuma aislante	L
----	Junta vidro • Junta vidrio	4L+8H
30 95 00 40*	Pelúcia 7x5.5 mm • Buriete 7x5.5 mm	4L+6H

\* junta alternativa ref.: 30 91 41 88 • junta alternativa ref.: 30 91 41 88



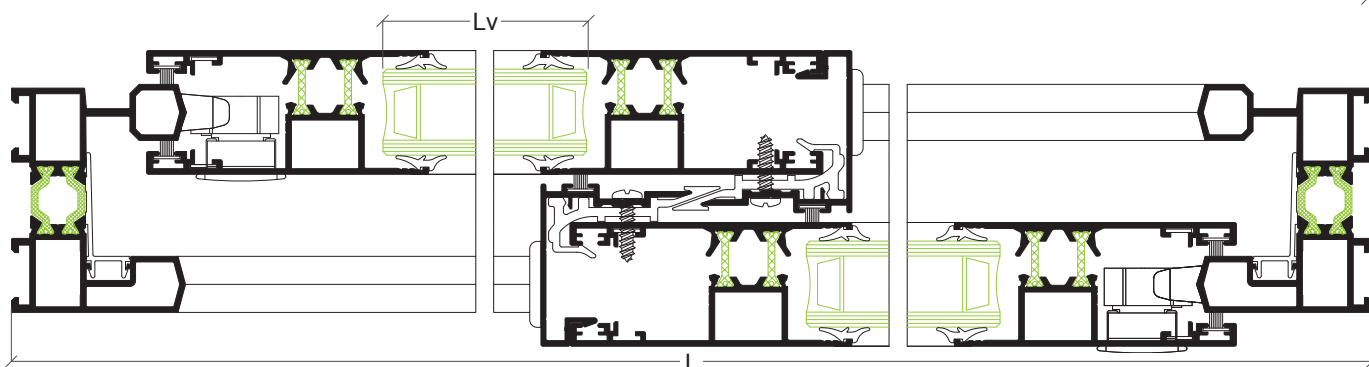







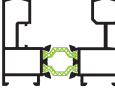



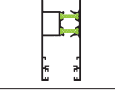

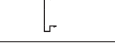
**VIDRO • VIDRIO**

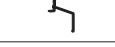
Hv = H-229 mm	Lv = L/2-126 mm
---------------	-----------------



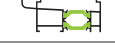

**Janela 4 folhas correr com fecho lateral • Ventana 4 hojas corredera con cierre lateral**
**PERFIS • PERFIS**

DESENHO • DESEÑO	REF.	DESCRIÇÃO • DESCRIPCIÓN	CORTE CORTE	QUANTIDADE CANTIDAD	MEDIDAS • MEDIDA
	CT-41	Aro fixo perimetral Marco perimetral		2	L
			2	H-28.5 mm	
	CT-23	Tampa aro fixo Tope marco perimetral		4	L-40 mm
			4	H-68 mm	
	CT-53	Aro móvel perimetral Hoja perimetral recta		8	L/4+16.5 mm
			8	H-101.5 mm	
	CT-54	Tampa cruzamento 2 folhas Tope recta cruze 2 hojas		4	H-101.5 mm
	CT-29	Pingadeira superior Vieriteaguas superior		1	L
	CT-08	Cruzamento móvel Cruce de hojas		4	H-101.5 mm
	CT-11	Soldeira de condensação Condensación		1	L
	CT-24	União 3/4 folhas Unión 3/4 hojas		1	L-171.5 mm

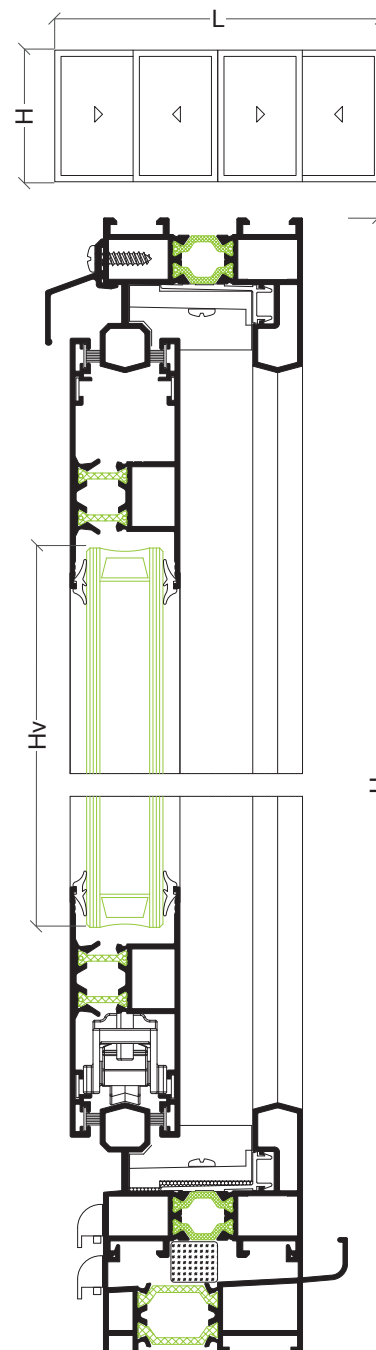

**ACESSÓRIOS E JUNTAS • ACCESORIOS Y JUNTAS**

REF.	DESCRIÇÃO • DESCRIPTION	QUANTIDADE CANTIDAD
30 91 41 74	Aro fixo perimetral • Escuadra marco	8
30 91 40 25	Esquadro aro móvel • Escuadra hoja	16
30 91 40 35	Rolamento simples • Rodamiento simples	8
30 91 40 42	Fecho lateral • Cierre lateral	3
30 91 40 50	Guia lateral • Guía lateral	6
30 91 41 70	Corta-ventos inferior/superior • Cortavientos inferior/superior	3
30 91 41 00	Tampa móvel recta • Tope hoja recta	8
30 92 01 02	Goteiras • Tapa salida de aguas	4
30 96 00 12	Jogo topos condensação • Juego topes condensación	1
30 96 00 23	Esquadro alinhamento • Escuadra alineamiento	32
30 91 41 10	Taco anti-levantamento • Taco antilevantamiento	3
30 92 04 70	Espuma isolante • Espuma aislante	L
----	Junta vidro • Junta vidrio	4L+16H
30 95 00 40*	Pelúcia 7x5.5 mm • Burlete 7x5.5 mm	4L+10H
30 91 41 89	Conjunto Topos CT-24 Preto • Conjunto T opos CT-24 Negro	1





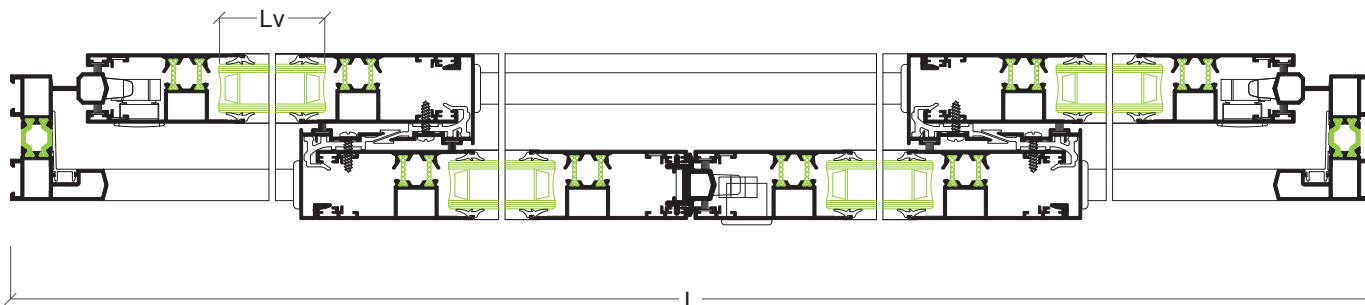





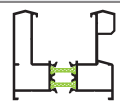

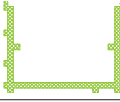





\* junta alternativa ref.: 30 91 41 88 • junta alternativa ref.: 30 91 41 88

**VIDRO • VIDRIO**

Hv = H-229 mm	Lv = L/4-110 mm
---------------	-----------------



**Porta 2 folhas correr multiponto • Puerta 2 hojas corredera multipunto**
**PERFIS • PERFIS**

DESENHO • DISEÑO	REF.	DESCRIÇÃO • DESCRIPCIÓN	CORTE CORTE	QUANTIDADE CANTIDAD	MEDIDAS • MEDIDA
	CT-01	Aro fixo perimetral Marco perimetral		2	L
				2	H
	CT-09	Tampa aro fixo Tope marco		2	L-45 mm
				2	H-45 mm
	CT-53	Aro móvel perimetral Hoja perimetral recta		4	L/2-7 mm
				4	H-87 mm
	CT-54	Tampa cruzamento 2 folhas Tope recta cruze 2 hojas		2	H-87 mm
	CT-07	Pingadeira superior Vierteaguas superior		1	L
	CT-08	União cruzamento 2 folhas Cruze de hojas		2	H-87 mm
	CT-28	Perfil de reforço Perfil de refuerzo		1	H-170 mm
	AX-19	Vareta (opcional) Pletina falleba (opcional)		1	H-170 mm

**ACESSÓRIOS E JUNTAS • ACCESORIOS Y JUNTAS**

REF.	DESCRIÇÃO • DESCRIPTION	QUANTIDADE CANTIDAD
30 91 40 15	Esquadro aro fixo • Escuadra marco	8
30 91 40 25	Esquadro aro móvel • Escuadra hoja	8
30 91 41 49	Rolamento duplo reforçado • Rodamiento doble refuerzado	4
----	Ferragem multiponto (600 ou 1800 mm) • Herraje multipunto (600 ou 1800 mm)	2
30 91 41 47	Cremona multiponto • Cremona multipunto	2
30 91 41 20	Calço nº 1 para multiponto • Suplemento nº 1 para multipunto	8 u 16
30 91 41 71	Limitador de abertura • Limitador de apertura	1
30 91 40 50	Guia lateral • Guía lateral	4
30 91 40 70	Corta ventos inferior/superior • Cortavientos inferior/superior	2
30 91 41 00	Tampa móvel recta • Tope hoja recta	4
30 92 01 02	Goteiras • Tapa salida de aguas	2
30 96 00 23	Esquadro alinhamento • Escuadra alineamiento	16
30 91 41 66	Joço topos CT-28 • Juego topos CT-28	2
----	Junta vidro • Junta vidrio	4L+8H
30 95 00 40*	Pelúcia 7x 5.5 mm • Burlete 7x5.5 mm	4L+6H







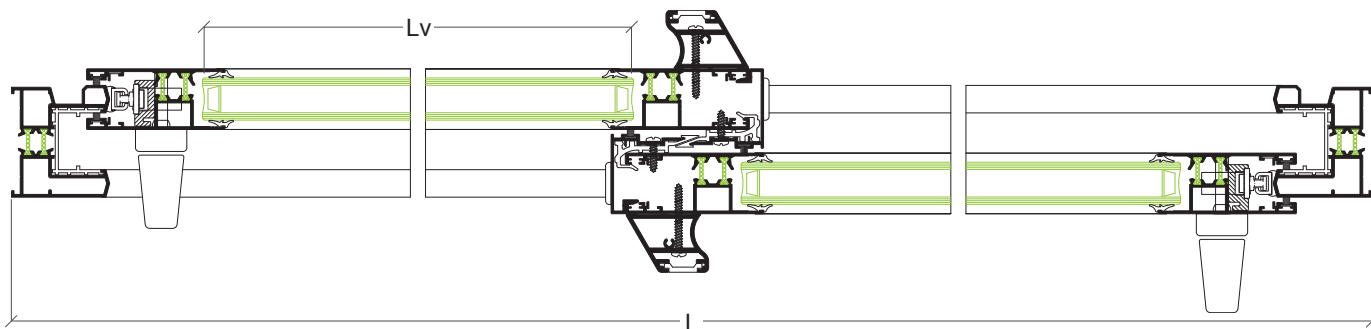
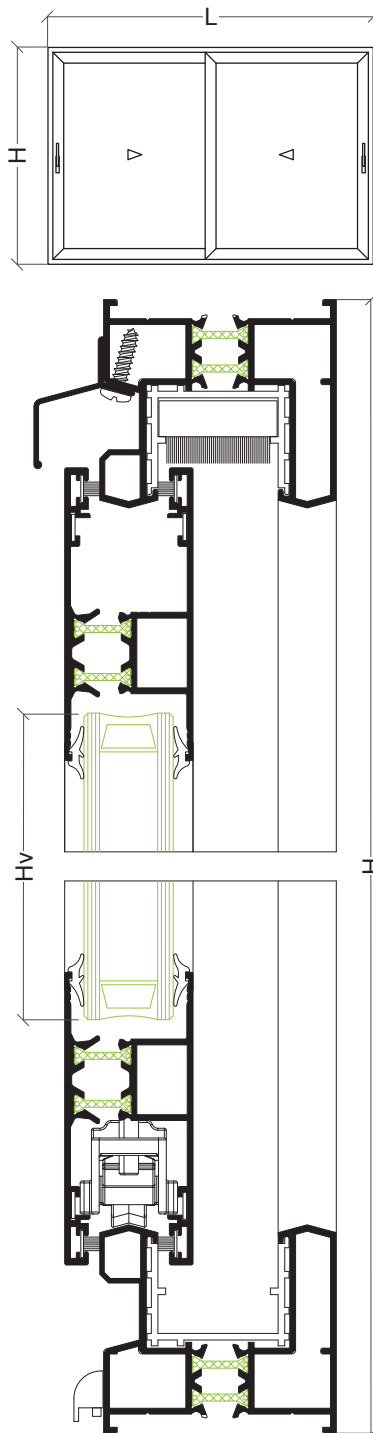





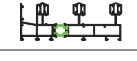

\* junta alternativa ref.: 30 91 41 88 • junta alternativa ref.: 30 91 41 88

**VIDRO • VIDRIO**

Hv = H-214 mm	Lv = L/2-134 mm
---------------	-----------------



**Porta 3 folhas correr tri-rail multiponto • Puerta 3 hojas corredera tricarril multipunto**
**PERFIS • PERFIS**

DESENHO • DISEÑO	REF.	DESCRIÇÃO • DESCRIPCIÓN	CORTE CORTE	QUANTIDADE CANTIDAD	MEDIDAS • MEDIDA
	CT-51	Aro fixo perimetral Marco tricarril con recogida		1	L
			2	H	
	CT-52	Aro fixo perimetral Marco tricarril balconera con recogida		1	L
	CT-23	Tampa aro fixo Tope marco perimetral		4	L-40 mm
				4	H-40 mm
	CT-53	Aro móvel perimetral Hoja perimetral recta		6	L/3+22.5 mm
				6	H-73 mm
	CT-54	Tampa cruzamento móvel Tope recta cruze 2 hojas		4	H-73 mm
	CT-29	Pingadeira superior Vierteaguas superior		1	L
	CT-08	Cruzamento móvel Cruce de hojas		4	H-73 mm
	CT-71	Guia carril (poliamida) Guía carril (poliamida)		3	L-93 mm

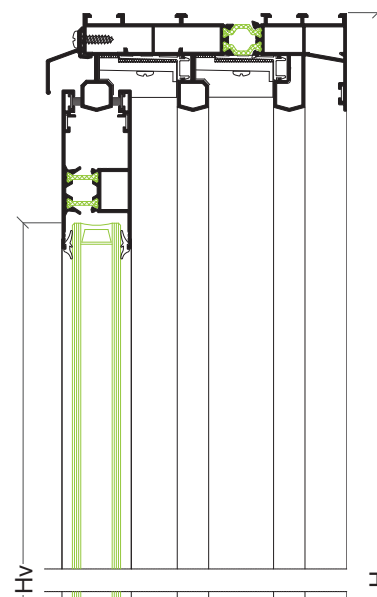
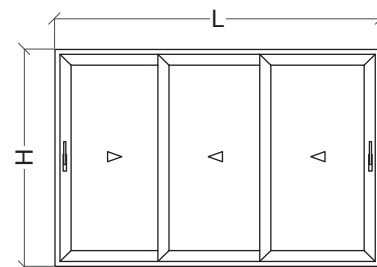

**ACESSÓRIOS E JUNTAS • ACCESORIOS Y JUNTAS**

REF.	DESCRIÇÃO • DESCRIPTION	QUANTIDADE CANTIDAD
30 91 41 74	Esquadro aro fixo • Escuadra marco	12
30 91 40 25	Esquadro aro móvel • Escuadra hoja	12
30 91 41 49	Rolamento duplo reforçado • Rodamiento doble reforzado	6
----	Ferragem multiponto (600 ou 1800 mm) • Herraje multipunto (600 ou 1800 mm)	2
30 91 41 47	Cremona multiponto • Cremona multipunto	2
30 91 41 20	Calço n° 1 para multiponto • Suplemento n° 1 para multipunto	8 ou 16
30 91 41 71	Limitador de abertura • Limitador de apertura	2
30 91 40 50	Guia lateral • Guía lateral	4
30 91 41 70	Corta-ventos inferior/superior • Cortavientos inferior/superior	2
30 91 41 00	Tampa guia recta • Tope guía recta	8
30 92 01 02	Goteiras • Tapa salida de aguas	4
30 96 00 23	Esquadro alinhamento • Escuadra alineamiento	24
----	Junta vidro • Junta vidrio	4L+12H
30 95 00 40*	Pelúcia 7x5.5 mm • Burlete 7x5.5 mm	4L+8H

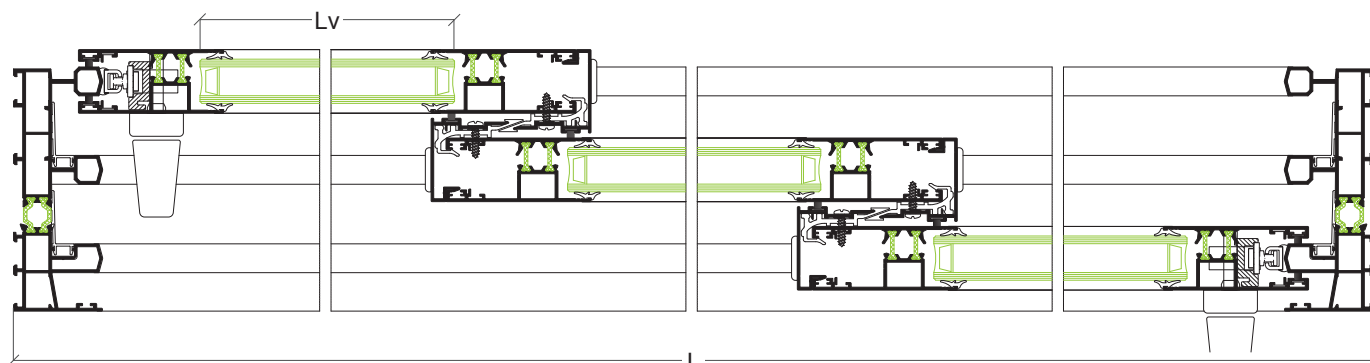

\* junta alternativa ref.: 30 91 41 88 • junta alternativa ref.: 30 91 41 88

**VIDRO • VIDRIO**

Hv = H-200 mm	Lv = L/3-104 mm
---------------	-----------------

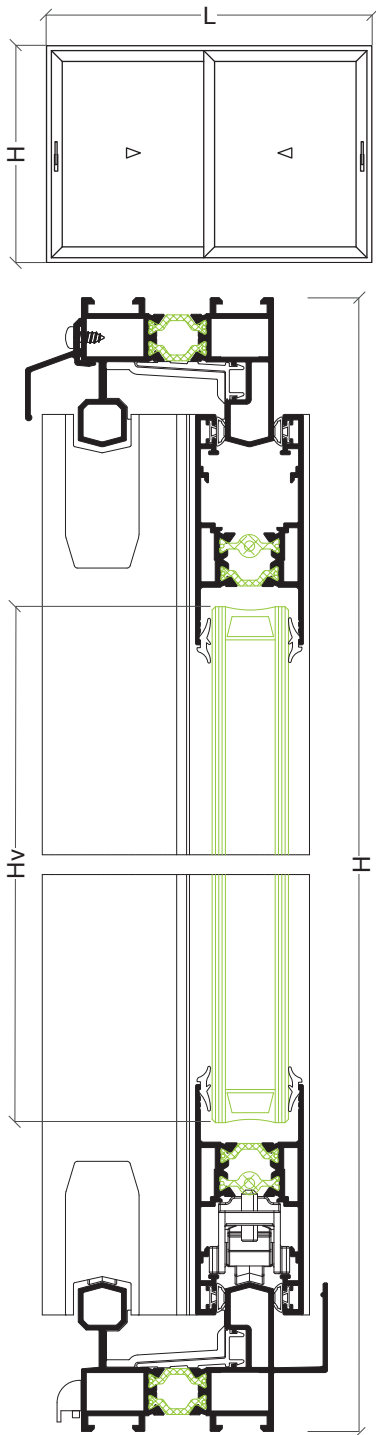

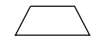
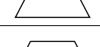
**Janela 2 folhas correr com fecho lateral • Ventana 2 hojas corredera con cierre lateral**

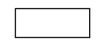
**PERFIS • PERFIS**

DESENHO • DISEÑO	REF.	DESCRIÇÃO • DESCRIPCIÓN	CORTE CORTE	QUANTIDADE CANTIDAD	MEDIDAS • MEDIDA
	CT-41	Aro fixo perimetral Marco perimetral		1	L
				2	H
	CT-43	Aro fixo perimetral condensação Marco perimetral recogida		1	L
	CT-23	Tampa aro fixo Tope marco perimetral		2	L-40 mm
				2	H-40 mm
	CT-34	Aro móvel carrinho Hoja de ruedas		4	L/2-93 mm
	CT-35	Aro móvel lateral Hoja lateral		2	H-74 mm
	CT-36	Aro móvel central Hoja central		2	H-74 mm
	CT-25	Cruzamento móvel Engatillado hoja central		2	H-74 mm
	CT-29	Pingadeira superior Verteaguas superior		1	L

**ACESSÓRIOS E JUNTAS • ACCESORIOS Y JUNTAS**

REF.	DESCRIÇÃO • DESCRIPTION	QUANTIDADE CANTIDAD
30 91 41 74	Esquadro aro fixo • Escuadra marco	8
30 91 40 35	Rolamento simples • Rodamiento simples	4
30 91 40 42	Fecho lateral • Cierre lateral	2
30 91 41 69	Jogo corta-ventos superior/inferior • Juego cortavientos superior/inferior	1
30 91 41 81	Kit topos janela • Kit topes ventana	2
30 92 01 02	Goteiras • Tapa salida de aguas	2
30 91 41 73	Jogo topos condensação • Juego topes condensación	1
30 91 41 10	Taco anti-levantamento • Taco antilevantamiento	2
30 91 41 88*	Junta de correr • Junta corredera	4L+6H

\* pelúcia alternativa ref.: 30 95 00 40 • junta alternativa ref.: 30 95 00 40

**VIDRO • VIDRIO**

Hv = H-192 mm	Lv = L/2-103 mm
---------------	-----------------

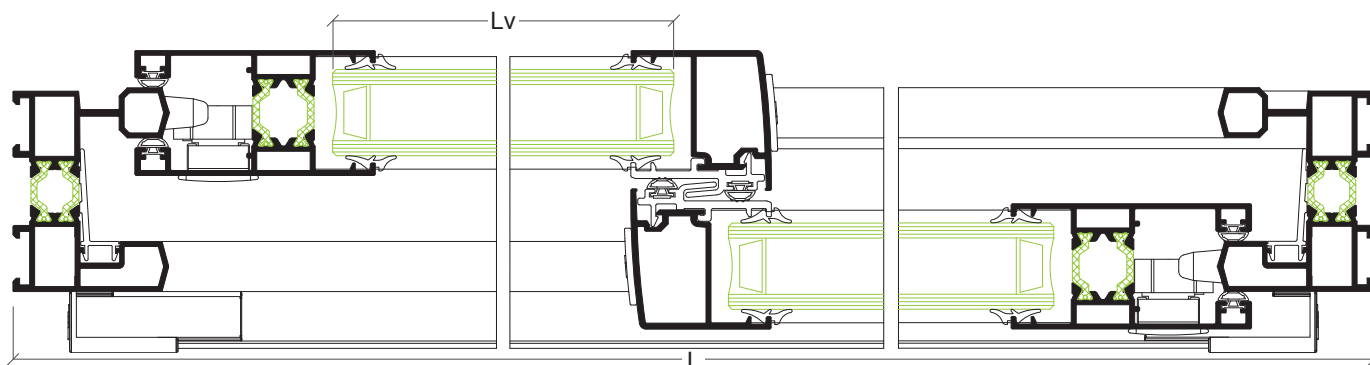

**Porta 2 folhas correr multiponto • Puerta 2 hojas corredera multipunto**

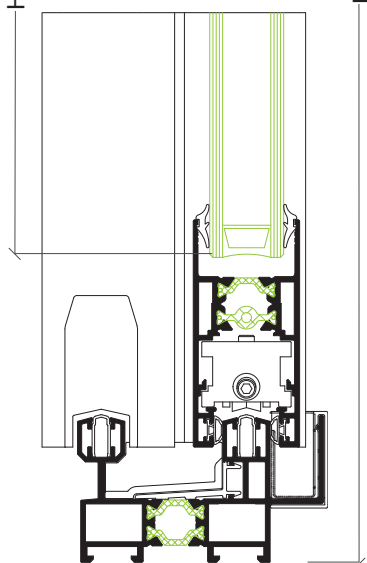
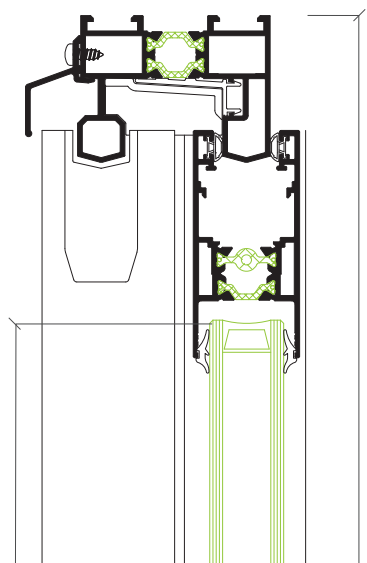
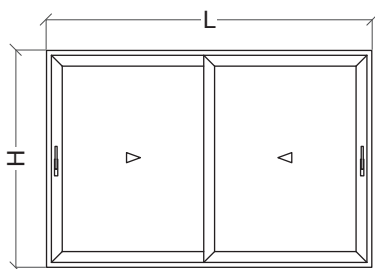

**PERFIS • PERFIS**

DESENHO • DISEÑO	REF.	DESCRIÇÃO • DESCRIPCIÓN	CORTE CORTE	QUANTIDADE CANTIDAD	MEDIDAS • MEDIDA
	CT-41	Aro fixo perimetral Marco perimetral		1	L
				2	H
	CT-44	Aro fixo perimetral condensação Marco inferior con recogida		1	L
	CT-33	Guia carril Guía carril		2	L-93 mm
	CT-23	Tampa aro fixo Tope marco perimetral		2	L-40 mm
				2	H-40 mm
	CT-34	Aro móvel carrinho Hoja de ruedas		4	L/2-107 mm
	CT-35	Aro móvel lateral Hoja lateral		2	H-74 mm
	CT-37	Aro móvel central Hoja central		1	H-74 mm
	CT-39	Aro móvel central com reforço Hoja central con refuerzo		1	H-74 mm
	CT-26	Cruzamento móvel Engatillado hoja central		2	H-74 mm
	CT-29	Pingadeira superior Verteaguas superior		1	L

**ACESSÓRIOS E JUNTAS • ACESORIOS Y JUNTAS**

REF.	DESCRIÇÃO • DESCRIPTION	QUANTIDADE CANTIDAD
30 91 41 74	Esquadro aro fixo • Escuadra marco	8
30 91 41 49	Rolamento duplo reforçado • Rodamiento doble reforzado	4
----	Ferragem multiponto (600 ou 1800 mm) • Herraje multipunto (600 ou 1800 mm)	2
30 91 41 47	Cremona multiponto • Cremona multipunto	2
30 91 41 21	Calço nº 2 para multiponto • Suplemento nº 2 para multipunto	8 u 16
30 91 41 71	Limitador de abertura • Limitador de apertura	1
30 91 41 70	Jogo corta-ventos superior/inferior • Juego cortavientos superior/inferior	1
30 91 41 82	Kit topos porta • Kit topos puerta	2
30 92 01 00	Goteiras • Tapa salida de agua	2
30 91 41 73	Jogo topos condensação • Juego topos condensación	1
30 91 41 67	Jogo topo central • Juego tope central	1
30 91 41 88*	Junta de correr • Junta corredera	4L+6H

\* pelúcia alternativa ref.: 30 95 00 40 • junta alternativa ref.: 30 95 00 40

**VIDRO • VIDRIO**

Hv = H-192 mm	Lv = L/2-119 mm
---------------	-----------------

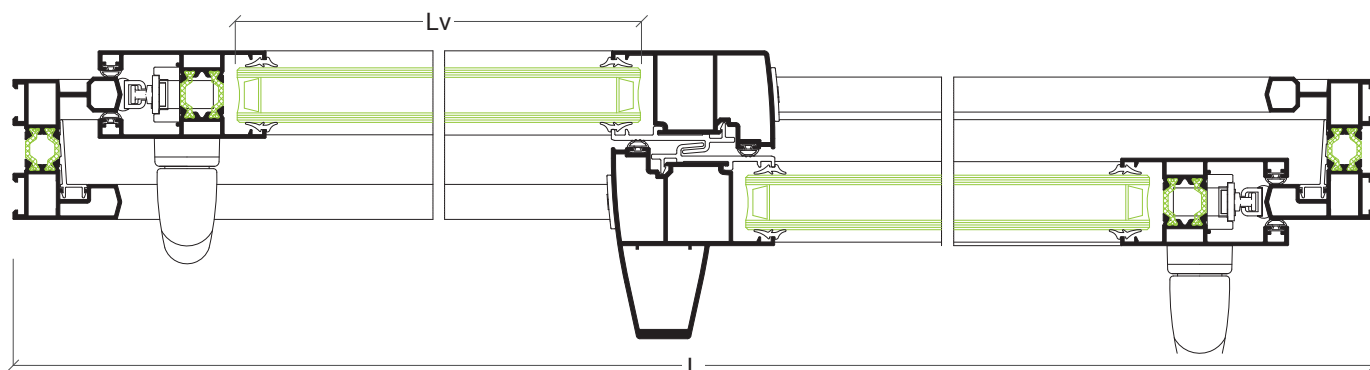

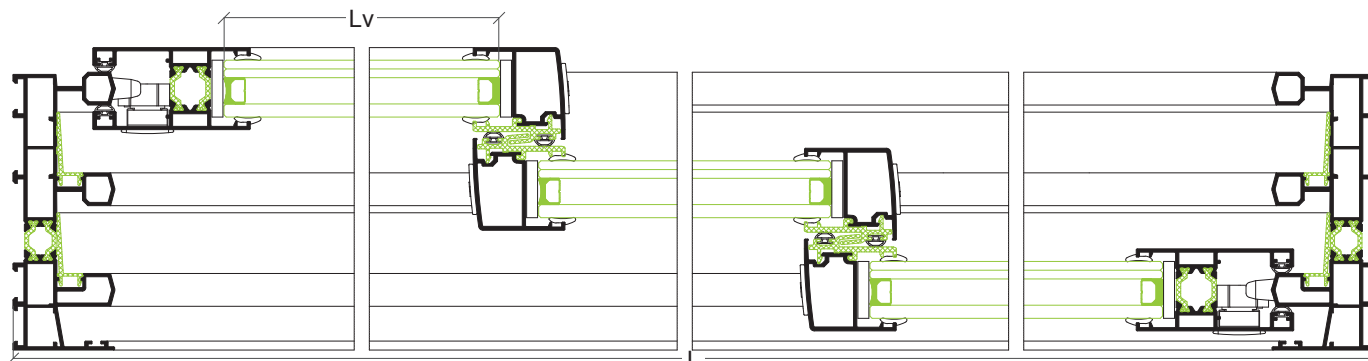
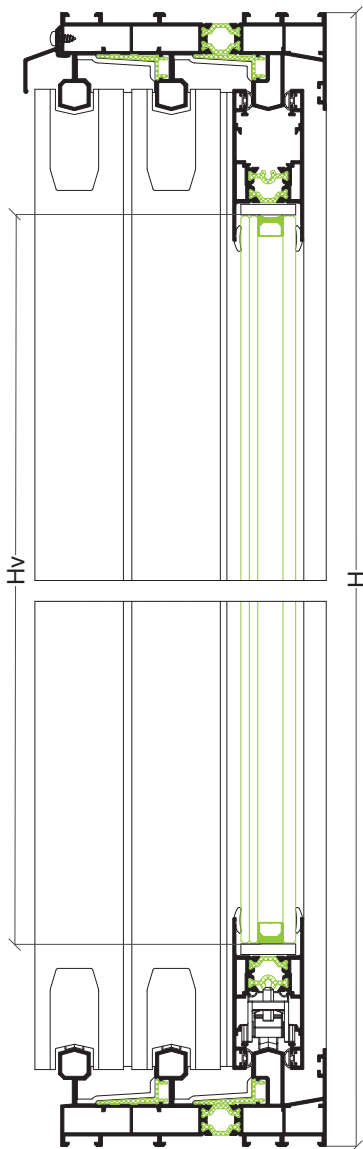
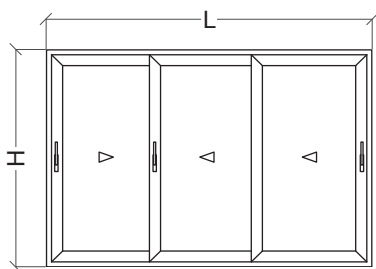
**Porta 3 folhas correr tri-rail com fecho lateral • Puerta 3 hojas corredera tricarril con cierre lateral**

**PERFIS • PERFIS**

DESENHO • DISEÑO	REF.	DESCRIÇÃO • DESCRIPCIÓN	CORTE CORTE	QUANTIDADE CANTIDAD	MEDIDAS • MEDIDA
	CT-51	Aro fixo perimetral Marco tricarril con recogida		2	L
			2	H	
	CT-23	Tampa aro fixo Tope marco perimetral		4	L-40 mm
				4	H-40 mm
	CT-34	Aro móvel carrinho Hoja de ruedas		6	L/3-64 mm
	CT-35	Aro móvel lateral Hoja lateral		2	H-74 mm
	CT-36	Aro móvel central Hoja central		4	H-74 mm
	CT-25	Cruzamento móvel Engatillado hoja central		4	H-74 mm
	CT-29	Pingadeira superior Vierteaguas superior		1	L

**ACESSÓRIOS E JUNTAS • ACCESORIOS Y JUNTAS**

REF.	DESCRIÇÃO • DESCRIPTION	QUANTIDADE CANTIDAD
30 91 41 74	Esquadro aro fixo • Escuadra marco	12
30 91 40 35	Rolamento simples • Rodamiento simples	6
30 91 40 42	Fecho lateral • Cierre lateral	2
30 91 41 69	Jogo cortaventos superior/inferior • Juego cortaventos superior/inferior	2
30 91 41 81	Kit topos janela folhas laterais • Kit topos ventana hojas laterales	2
30 91 41 83	Kit topos janela folhas centrais • Kit topos ventana hojas centrales	1
30 92 01 00	Goteiras • Tapa salida de agua	2
30 91 41 88 *	Junta de correr • Junta corredera	4L+8H

\* pelúcia alternativa ref.: 30 95 00 40 • junta alternativa ref.: 30 95 00 40

**VIDRO • VIDRIO**

Hv = H-193 mm	Lv = L/3-74 mm
---------------	----------------

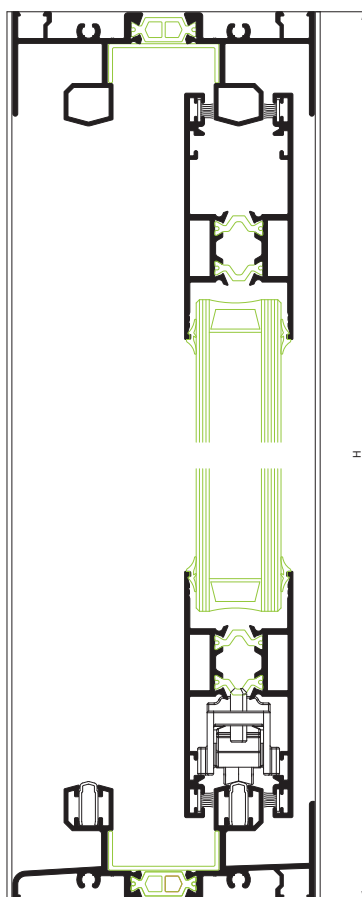
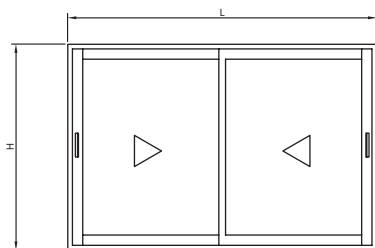
**Porta 2 folhas correr multiponto • Puerta 2 hojas corredera multipunto**

**PERFIS • PERFIS**

DESENHO • DISEÑO	REF.	DESCRIÇÃO • DESCRIPCIÓN	CORTE CORTE	QUANTIDADE CANTIDAD	MEDIDAS • MEDIDA
	CT-81	Padieira Marco perimetral		1	L-25 mm
	CT-82	Soleira Marco inferior con recogida		1	L-25 mm
	CT-83	Ombreira Guía carril		2	H
	CT-85	Tampa Tope marco perimetral		2	L-25 mm
	CT-33	Perfil Guia Hoja de ruedas		2	L-28 mm
	CT-100	Aro móvel carrinho Hoja lateral		4	(L/2)+18mm
	CT-54	Aro móvel lateral Hoja central		2	H-50 mm
	CT-08	Aro móvel central Hoja central con refuerzo		2	H-50 mm

**ACESSÓRIOS E JUNTAS • ACCESORIOS Y JUNTAS**

REF.	DESCRIÇÃO • DESCRIPTION	QUANTIDADE CANTIDAD
30 91 42 11	Esquadro • Escuadra	16
30 96 00 23	Esquadro de alinhamento • Escuadro de alineamiento	16
30 91 40 70	Corta-Vento • Corta-Viento	2
30 91 41 00	Tampa móvel • Tope	4
30 91 40 50	Guia Lateral • Guia Lateral	4
30 91 40 36	Rolamento Duplo • Rodamiento Doble	4
30 91 41 30	Barra 2 pontos • Barra 2 puntos	2
30 92 07 96	Placas para pontos de fecho • Placas para punto de cierre	4
30 91 41 39	Calço nº6 • Calzo nº6	8
30 94 60 98	Fecho minimalista direito • Cierre minimalista derecho	1
30 94 61 00	Fecho minimalista esquerdo • Cierre minimalista izquierdo	1
30 91 41 71	Topo limitador de abertura • Tope limitador de apertura	1
30 91 41 93	Kit de estanquidade nº1 • Kit de estanqueidad	1
30 91 41 97	Goteira • Goteo	2
30 91 41 95	Junta ombreira • Junta ombrera	2H
30 91 41 87	Junta tapa-canal • Junta tapa-canal	2H
30 95 00 50	Pelucia • Burlete	4L+6H
---	Junta para vidro • Junta para vidrio	4L+8H

**VIDRO • VIDRIO**

Hv = H-177 mm	Lv = (L/2)-107 mm
---------------	-------------------

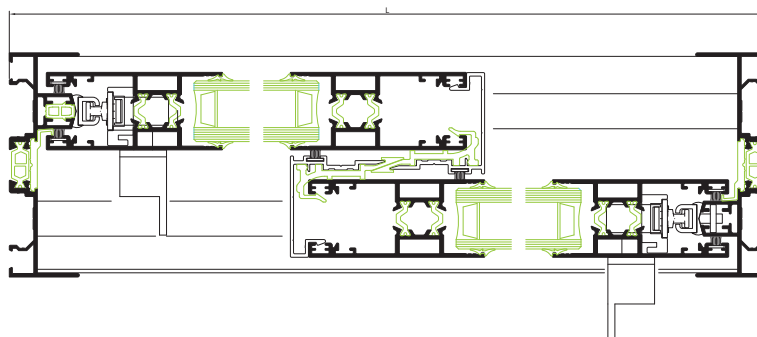

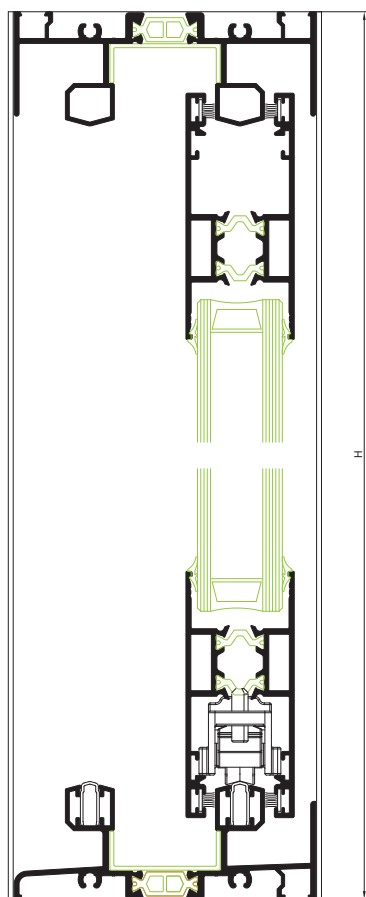
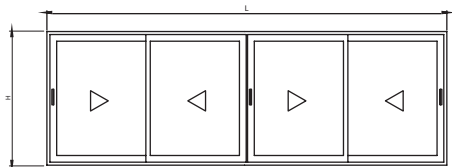
**Porta 4 folhas correr multiponto • Puerta 3 hojas corredera multipunto**

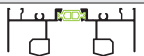
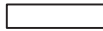
**PERFIS • PERFIS**

DESENHO • DISEÑO	REF.	DESCRIÇÃO • DESCRIPCIÓN	CORTE CORTE	QUANTIDADE CANTIDAD	MEDIDAS • MEDIDA
	CT-81	Padieira Marco perimetral		1	L-25 mm
	CT-82	Soleira Marco inferior con recogida		1	L-25 mm
	CT-83	Ombreira Guía carril		2	H
	CT-85	Tampa Tope marco perimetral		2	L-25 mm
	CT-33	Perfil Guia Hoja de ruedas		2	L-28 mm
	CT-100	Aro móvel carrinho Hoja lateral		8	(L/2)+26mm
				8	H-50 mm
	CT-54	Tampa cruzamento Tope		4	H-50 mm
	CT-08	União cruzamento Unión		4	H-50 mm
	CT-24	União de 4 folhas Unión 4 hojas		1	H-120 mm

**ACESSÓRIOS E JUNTAS • ACESORIOS Y JUNTAS**

REF.	DESCRIÇÃO • DESCRIPTION	QUANTIDADE CANTIDAD
30 91 42 11	Esquadro • Escuadra	32
30 96 00 23	Esquadro de alinhamento • Escuadro de alineamiento	32
30 91 40 70	Corta-Vento • Corta Viento	6
30 91 41 00	Tampa móvel • Tope	8
30 91 40 50	Guia Lateral • Guia Lateral	6
30 91 40 36	Rolamento Duplo • Rodamiento Doble	8
30 91 41 30	Barra 2 pontos • Barra 2 puntos	3
30 92 07 96	Placas para pontos de fecho • Placas para punto de cierre	6
30 91 41 24	Calço nº3 • Calzo nº3	4
30 91 41 39	Calço nº6 • Calzo nº6	8
30 94 60 98	Fecho minimalista direito • Cierre minimalista derecho	1
30 94 61 00	Fecho minimalista esquerdo • Cierre minimalista izquierdo	2
30 91 41 89	Conjunto topo para união 4 folhas • Conjunto top para unión 4 hojas	1
30 91 41 71	Topo limitador de abertura • Tope limitador de apertura	2
30 91 41 93	Kit de estanquidade nº1 • Kit de estanqueidad	1
30 91 41 97	Goteira • Goteo	4
30 91 41 95	Junta ombreira • Junta ombrera	2H
30 91 41 87	Junta tapa-canal • Junta tapa-canal	2H
30 95 00 50	Pelucia • Burlete	4L+10H
---	Junta para vidro • Junta para vidrio	4L+16H

**VIDRO • VIDRIO**

Hv = H-177 mm	Lv = (L/4)-101 mm
---------------	-------------------

