

www.anicolor.pt

**SISTEMA DE CORRER
COM RPT - 60 mm**

**SISTEMA CORREDERA
CON RPT - 60 mm**

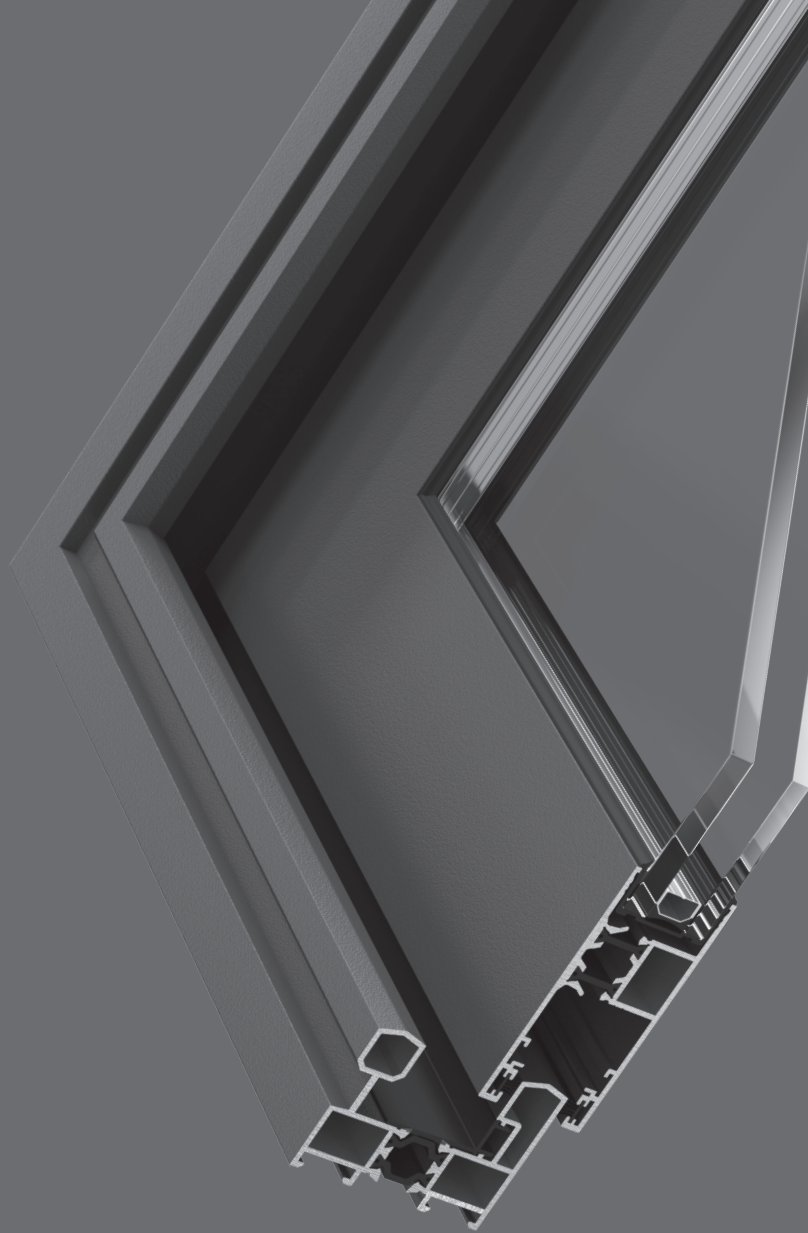

CT

 **anicolor**
Sistemas de Alumínio

SISTEMA CT

Sistema de correr com RPT - 60 mm

CARACTERÍSTICAS DO SISTEMA

Sistema de alumínio com rotura térmica para execução de vãos de correr.
 O sistema de correr CT possibilita a execução de 4 versões de caixilharia:
 · CT - Perimetral, CT - Benelux, CT - Euro e CT - Hotel

PERFIS DE ALUMÍNIO

Os perfis de alumínio são extrudidos na liga de alumínio 6060 para arquitetura de acordo com norma NP EN 12020-02.

Os perfis com rotura térmica são obtidos por inserção de varetas isolantes de poliamida 6.6 mm reforçadas com 25% de fibra de vidro.

Versátil sistema de rotura térmica com aros e folhas perimetrais ou de corte recto designado por Benelux, é o sistema indicado para as inovadoras soluções arquitectónicas da actualidade.

Espessura média dos perfis de alumínio de 1.5 mm.

AROS FIXOS

Secção do aro fixo perimetral de 2 guias de 60 mm para montagem a meia esquadria;
 Secção do aro fixo CT - Euro de 2 guias de 96mm para montagem em corte recto;
 Perfis com rotura térmica obtida por inserção de varetas isolantes de poliamida de 14.6 mm, 18 mm ou 20 mm;
 Perfil guia de deslizamento inferior em aço inoxidável 304 ou em poliamida, para evitar desgaste das peças.

AROS MÓVEIS

Secção dos aros móveis perimetrais de 33.1 mm para montagem a meia esquadria;
 Secção dos aros móveis corte recto de 37,5 mm;
 Enchimento de 18 mm a 26 mm para o sistema CT;
 Enchimento de 18mm a 27 mm para o sistema CT-BENELUX;
 Aros móveis de linha recta ou curva com ou sem bite;
 Estanqueidade assegurada através de junta em TPE e/ou pelúcia tipo Sin-Feal.

DIMENSIONAMENTO E MANOBRABILIDADE

Peso máximo de 150 kg por folha (com 2 rolamentos duplos);
 Possibilidades de abertura: 2, 3, 4 e 6 folhas com folhas móveis e/ou fixas;
 Rolamento duplo oscilante com regulação;
 Rolamentos de agulhas inox com eixo temperado retificado sendo possível a substituição sem desmontagem da folha;
 Suporte exterior com tratamento cataforese (anti-corrosivo);
 Abertura do vão com fecho lateral ou ferragem multi-ponto com 1 ou mais pontos de fecho.

PERFORMANCES

Sistema certificado por laboratório credenciado, notificado do ensaio tipo inicial (ITT) de acordo com a norma de produto EN 14351-1 para efeitos de Marcação CE.

Categorias alcançadas na avaliação do sistema CT tipologia janela:

1. Permeabilidade ao ar: Classe 3 (norma de ensaio EN 10207 e EN 1026)
2. Estanqueidade à água: Classe 7A (norma de ensaio EN 12208 e EN 1027)
3. Resistência ao vento: Classe C5 (norma de ensaio EN 12210 e EN 12211)

Categorias alcançadas na avaliação do sistema CT tipologia porta:

1. Permeabilidade ao ar: Classe 4 (norma de ensaio EN 10207 e EN 1026)
2. Estanqueidade à água: Classe 7A (norma de ensaio EN 12208 e EN 1027)
3. Resistência ao vento: Classe C2 (norma de ensaio EN 12210 e EN 12211)

Coefficiente de transmissão térmica de vão de 2 folhas com 1.80 m x 2.20 m com vidro Ug = 1.0 W/m²K com intercalar efeito "Warm Edge": Uw = 1.91 W/m²K

Coefficiente de atenuação acústica de vão de 2 folhas com vidro 6/14/33.1 acústico: Rw (C; Ctr) = 34 dB (-1; -6)

CT-Euro

Categorias alcançadas na avaliação do sistema CT tipologia janela:

1. Permeabilidade ao ar: Classe 4 (norma de ensaio EN 10207 e EN 1026)
2. Estanqueidade à água: Classe 7A (norma de ensaio EN 12208 e EN 1027)
3. Resistência ao vento: Classe C5 (norma de ensaio EN 12210 e EN 12211)

Coefficiente de atenuação acústica de vão de 2 folhas com vidro 33.2 silencio/10/44.2 silencio: Rw (C; Ctr) = 37 dB (-1; -3)

Zonas de aplicação segundo RCCTE (em função do valor Ug): I1, I2, I3, V1, V2, V3;

SISTEMA CT

Sistema corredera con RPT - 60 mm

CARACTERÍSTICAS DEL SISTEMA

Sistema de aluminio con rotura térmica para ejecución de huecos correderos.
 El sistema CT en funcionamiento permite la ejecución de 4 versiones de los marcos:
 CT - Perimetral
 CT - Benelux
 CT - Euro
 CT - Hotel

PERFILES DE ALUMINIO

Sistema de aluminio con rotura térmica para ejecución de huecos correderos.

MARCOS

Profundidad del marco perimetral de 2 guías de 60 mm para montaje a englete;
 Sección de marcos CT - Euro con 2 guías de 96 mm para montaje en sección recta;
 Perfiles con rotura térmica obtenida por inserción de pletina fallebas aislantes de poliamida de 14.6 mm u 18 mm;
 Perfil guía de deslizamiento inferior en acero inoxidable AISI 304 u en poliamida, para evitar el desgaste de las piezas.

HOJAS

Profundidad de las hojas perimetrales de 33.1 mm para montaje a englete;
 Sección de hojas de corte recto de 37,5 mm;
 Acristalamiento de 18 mm a 26 mm para el sistema CT;
 Acristalamiento de 18 mm a 27 mm para el sistema CT-BENELUX;
 Hojas de línea recta y curva con y sin junquillo;
 Estanqueidad asegurada mediante junta de TPE y/u burlete tipo Sin-Feal.

DIMENSIONAMIENTO Y MANIOBRABILIDAD

Peso máximo de 150 kg por hoja (con 2 rodamientos dobles);
 Posibilidades de apertura: 2, 3, 4 y 6 hojas con hojas correderas y/ó fijas;
 Rodamiento doble oscilante con regulación;
 Rodamientos de agujas inox con eje templado retificado siendo posible la sustitución sin desmontar la hoja;
 Soporte exterior con tratamiento anticorrosivo;
 Apertura del hueco con cierre lateral u herraje multicierre con 1 ó más puntos de cierre.

ENSAYOS

Sistema certificado por laboratorio credenciado, notificado para Ensayos Tipo Inicial (ITT) de acuerdo con la norma de producto EN 14351-1 para efectos de Marcado CE.

Categorías alcanzadas en los ensayos del sistema CT tipologia ventana:

1. Permeabilidad al aire: Clase 3 (norma de ensayo EN 1026)
2. Estanqueidad al agua: Clase 7A (norma de ensayo EN 1027)
3. Resistencia al viento: Clase C5 (norma de ensayo EN 12211)

Categorías alcanzadas en los ensayos del sistema CT tipologia puerta:

1. Permeabilidad al aire: Clase 4 (norma de ensayo EN 1026)
2. Estanqueidad al agua: Clase 7A (norma de ensayo EN 1027)
3. Resistencia al viento: Clase C2 (norma de ensayo EN 12211)

Coefficiente de transmisión térmica de hueco de 2 hojas con 1.80 m x 2.20 m con vidrio Ug = 1.0 W/m²K con intercalar efecto "Warm Edge": Uw = 1.91 W/m²K

Coefficiente de atenuación acústica de hueco de 2 hojas con vidrio 6/14/33.1 acústico: Rw (C; Ctr) = 34 dB (-1; -6)

CT-Euro

Categorías logradas en la evaluación del sistema de ventanas de tipologia de TC:

1. Permeabilidad al aire: Clase 4 (norma de prueba EN 10207 y EN 1026)
2. Estanqueidad al agua: Clase 7A (prueba estándar EN 12208 y EN 1027)
3. Resistencia al viento: Clase C5 (norma de prueba EN 12210 y EN 12211)

Coefficiente de atenuación acústica de 2 hojas con vidrio 33.2 silencio / 10 / 44,2 silencio: Rw (C; Ctr) = 37 dB (-1; -3)

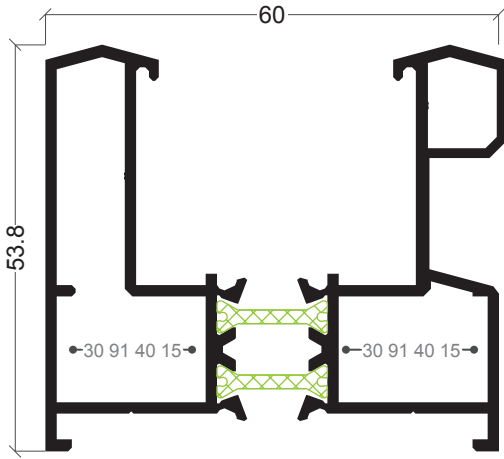

CT-01
Aro fixo perimetral
Marco perimetral

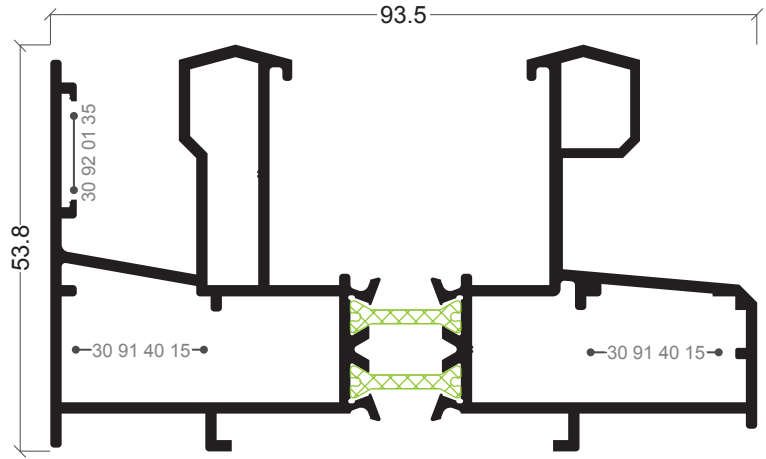

CT-16
Aro fixo perimetral
Marco perimetral con recogida

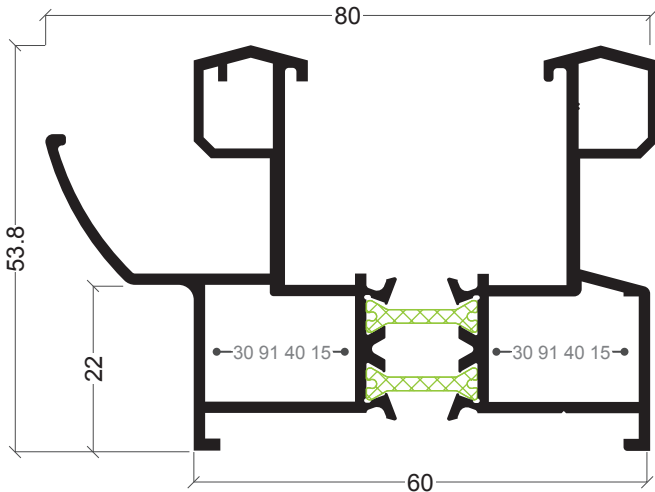

CT-15
Aro fixo perimetral
Marco perimetral con recogida

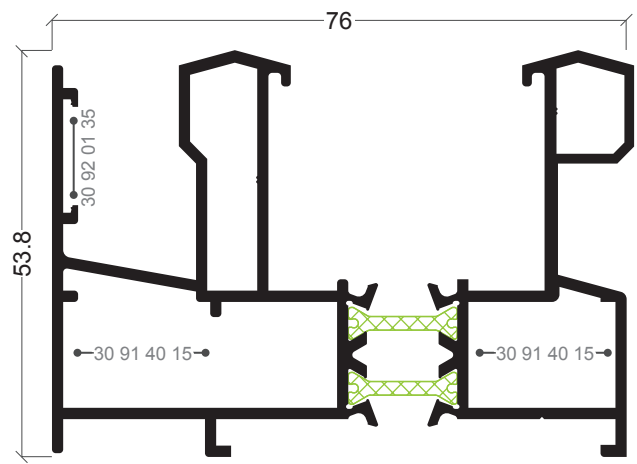

CT-22
Aro fixo perimetral
Marco perimetral con recogida

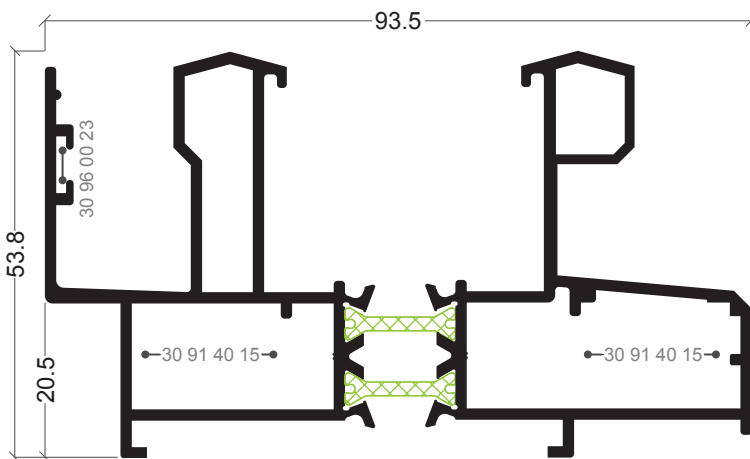

CT-17
Aro fixo perimetral
Marco perimetral con recogida

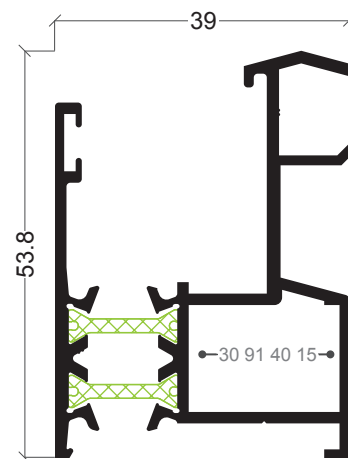

CT-59
Aro fixo perimetral mono-rail
Marco perimetral monocarril

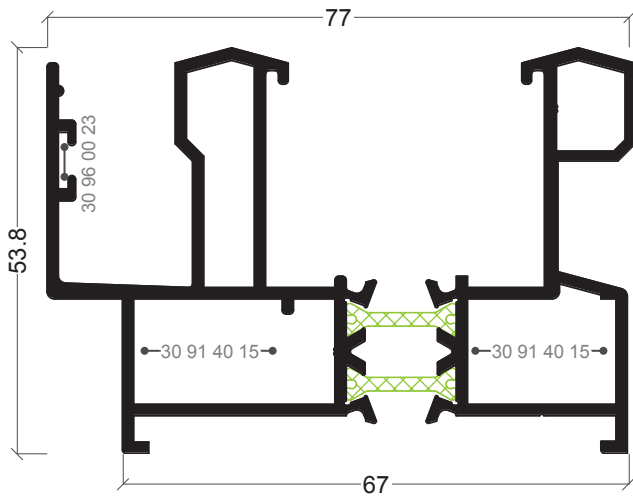

CT-60

Aro fixo perimetral
Marco perimetral con recogida

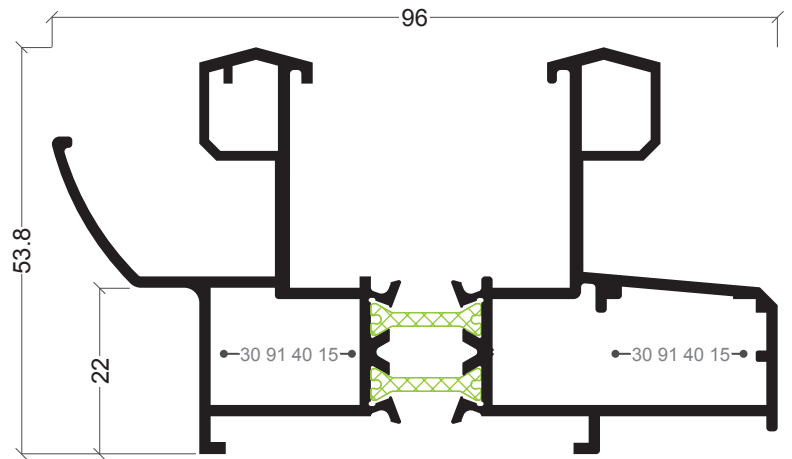

CT-20

Aro fixo perimetral
Marco perimetral con recogida

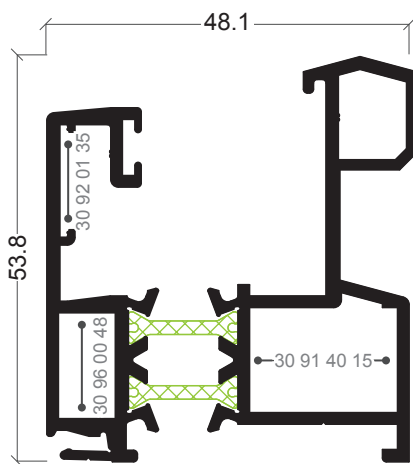

CT-66

Aro fixo mono-rail
Marco mono-rail

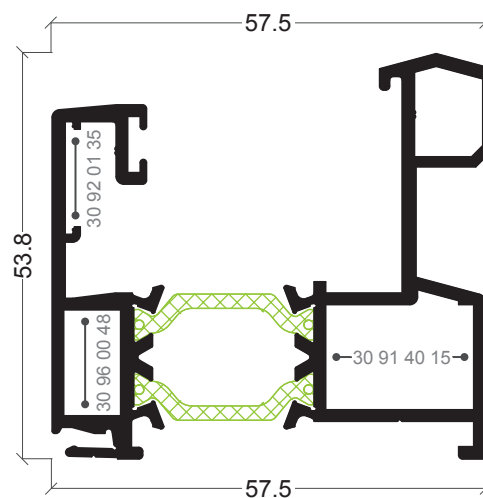

CT-70

Aro fixo mono-rail
Marco mono-rail

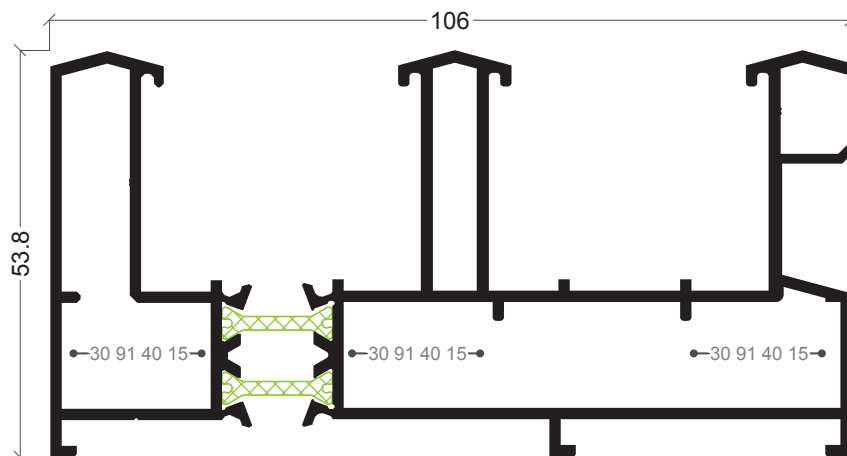

CT-14

Aro fixo perimetral tri-rail
Marco perimetral tricarril

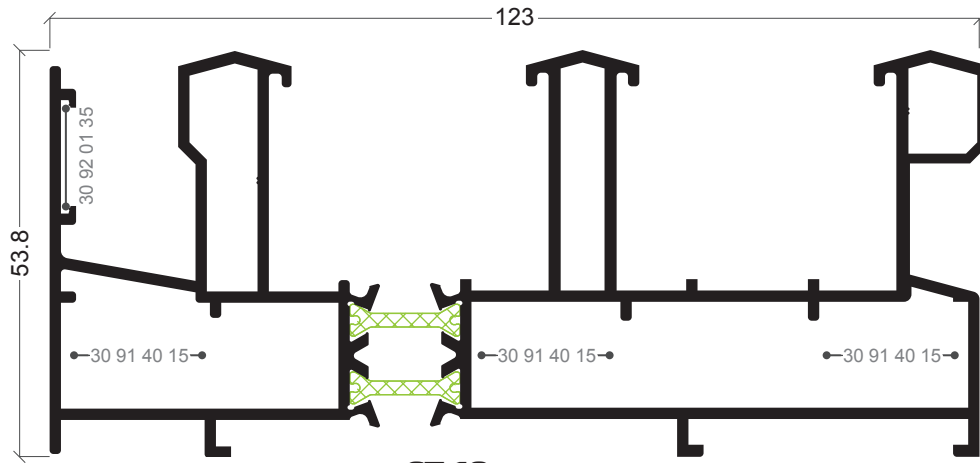

CT-18

Aro fixo perimetral tri-rail
Marco perimetral tricarril con recogida

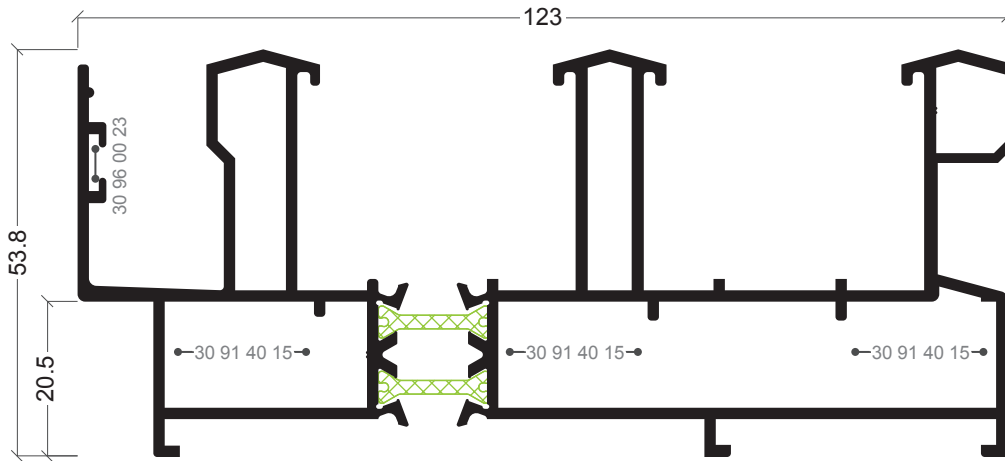

CT-19

Aro fixo perimetral tri-rail
Marco perimetral tricarril con recogida

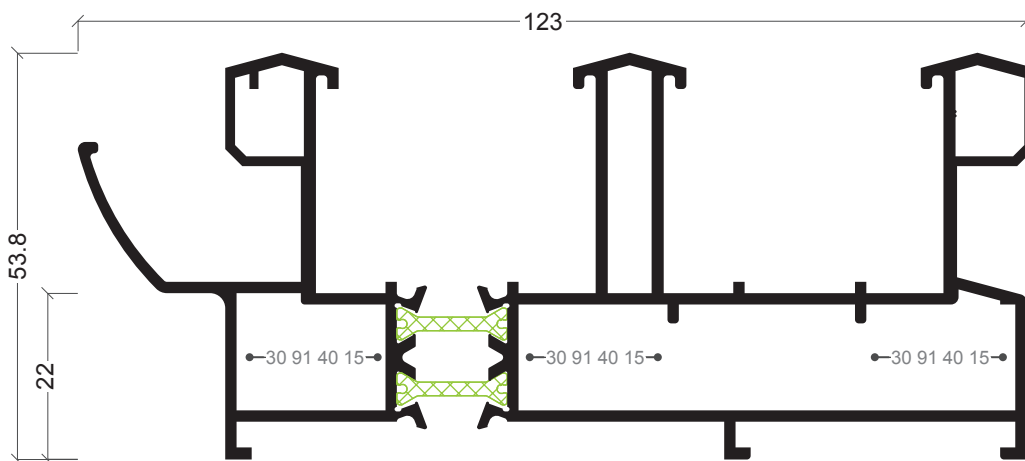

CT-21

Aro fixo perimetral tri-rail
Marco perimetral tricarril con recogida

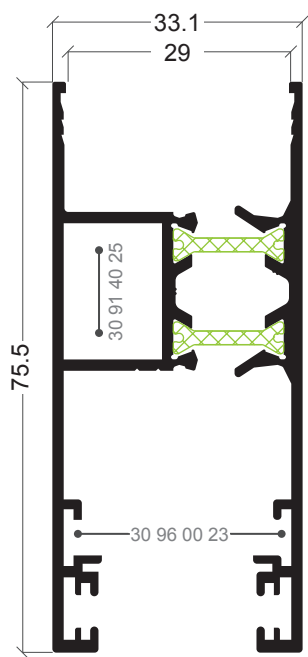

CT-53

Aro móvel perimetral recto
Hoja perimetral recta

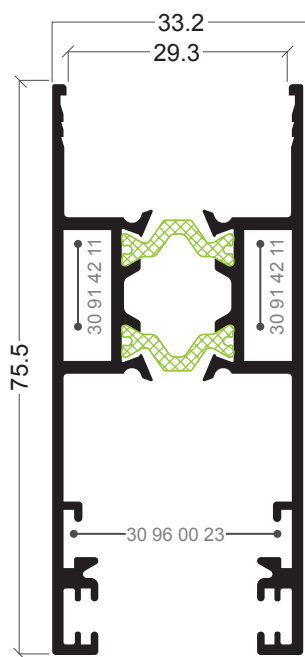

CT-100

Aro móvel perimetral recto
Hoja perimetral recta

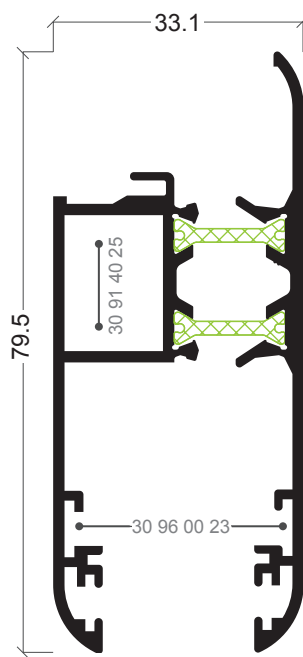

CT-02

Aro móvel perimetral com bite
Hoja perimetral para junquillo

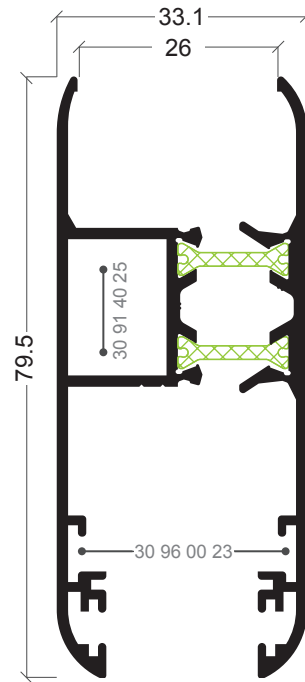

CT-12

Aro móvel perimetral
Hoja perimetral sin junquillo

302

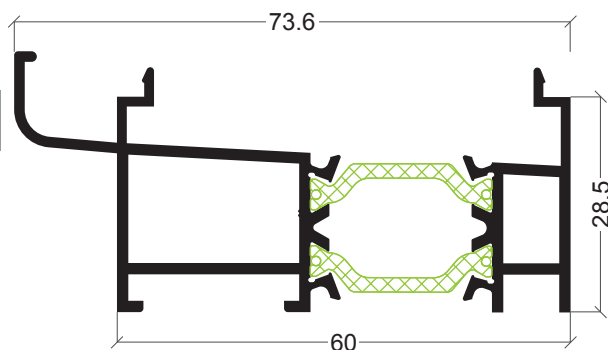

CT-11

Soleira condensação
Condensación

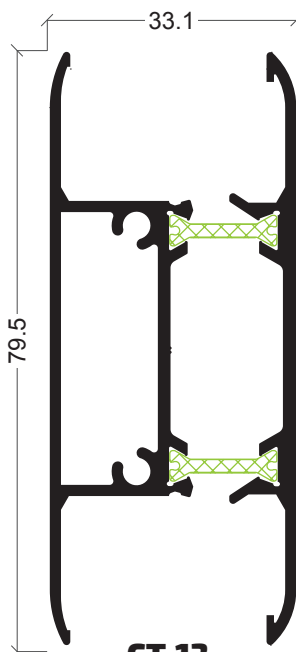

CT-13

Travessa sem bite
Travesaño hoja perimetral

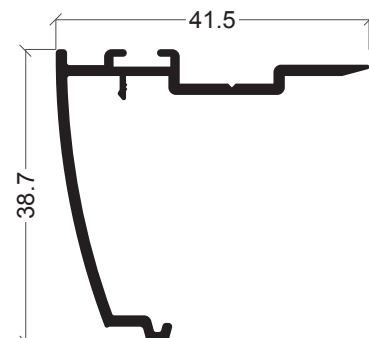

CT-06

Tampa cruzamento aro móvel
Tope curva cruze 2 folhas

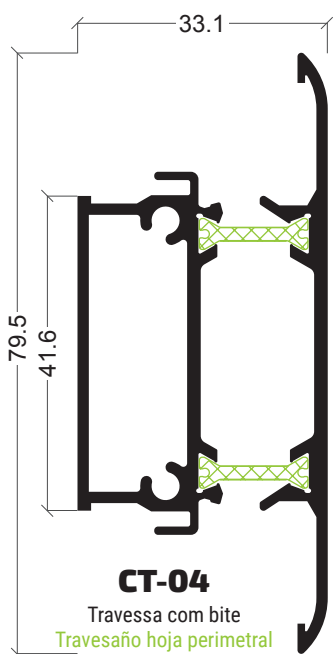

CT-04

Travessa com bite
Travesaño hoja perimetral

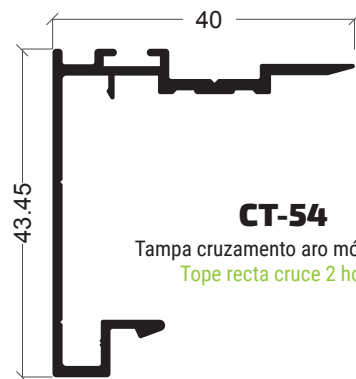

CT-54

Tampa cruzamento aro móvel recto
Tope recta cruze 2 folhas

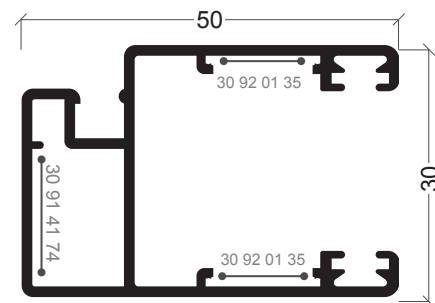

CT-73

Perfil para rede mosquiteira
Perfil para mosquiteira

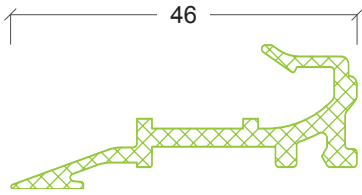

CT-08

Cruzamento móvel
Cruce de hojas

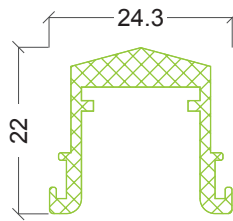

CT-10

União 3/4 folhas CT-02/12
Unión 3/4 hojas CT-02/12

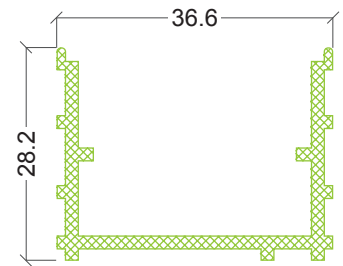

CT-09

Tampa aro fixo perimetral CT-01 ou similares
Tope marco perimetral CT-01 o similar

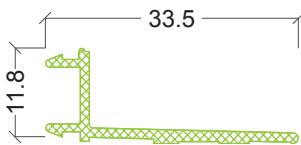

CT-23

Tampa aro fixo perimetral CT-41 ou similares
Tope marco perimetral CT-41 o similar

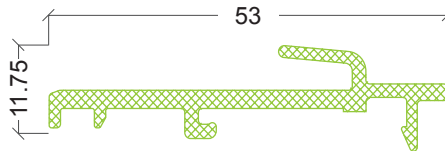

CT-26

Cruzamento móvel CT-37/39
Engatillado hoja central

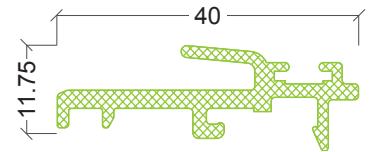

CT-25

Cruzamento móvel CT-36/38
Engatillado hoja central

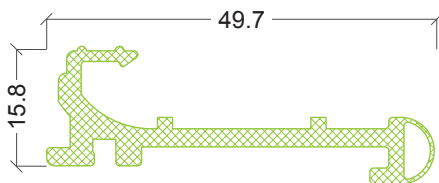

CTe-04

Cruzamento para perfil CTe-02
Engatillado para perfil CTe-02

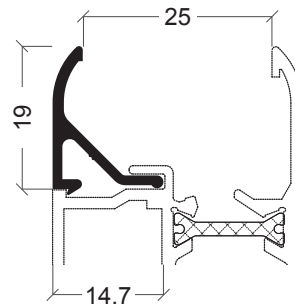

CT-05

Bite
Junquillo

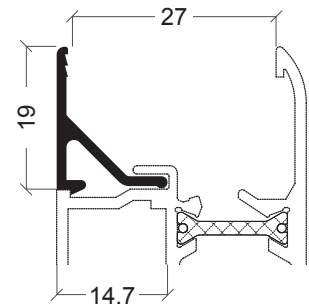

CT-40

Bite
Junquillo

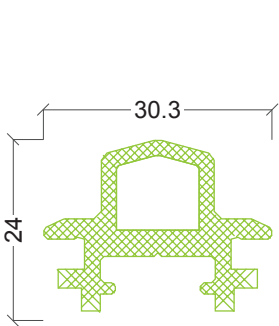

CT-24

União 3/4 folhas CT-35/53/100
Unión 3/4 hojas CT-35/53/100

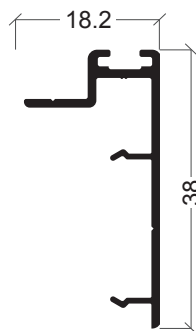

CT-74

Tampa
Tope

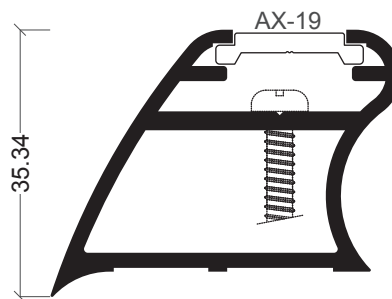

CT-03

Reforço
Refuerzo hoja central

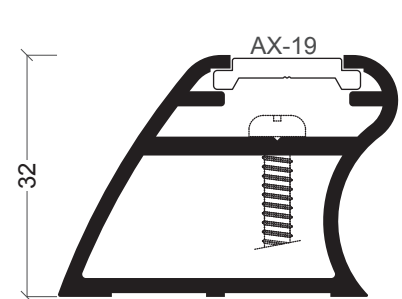

CT-27

Reforço
Refuerzo hoja central

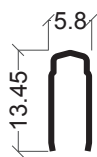

CT-33

Guia carril (aco inox 304)
Guía carril (inox 304)

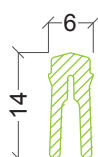

CT-71

Guia carril (poliamida)
Guía carril (poliamida)

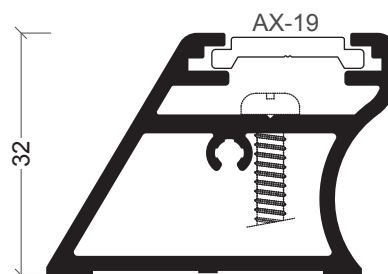

CT-28

Reforço
Refuerzo hoja central

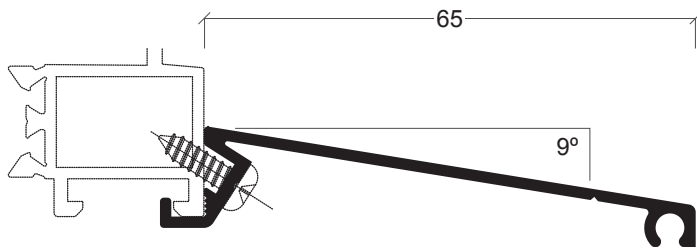

CT-30

Pingadeira 65 mm
Alargadera 65 mm

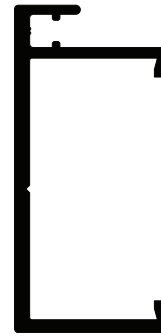

CT-102

Prumo Central Minimal
Prumo Central Minimal

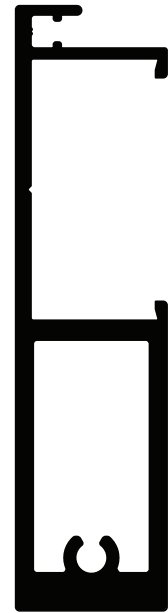

CT-103

Prumo central minimal reforçado
Prumo Central minimal reforçado

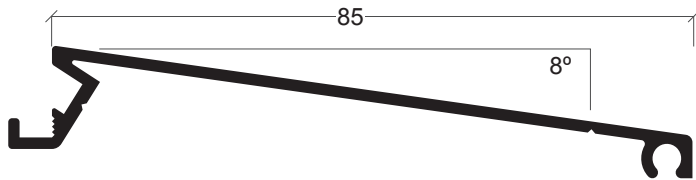

CT-31

Pingadeira 85 mm
Alargadera 85 mm

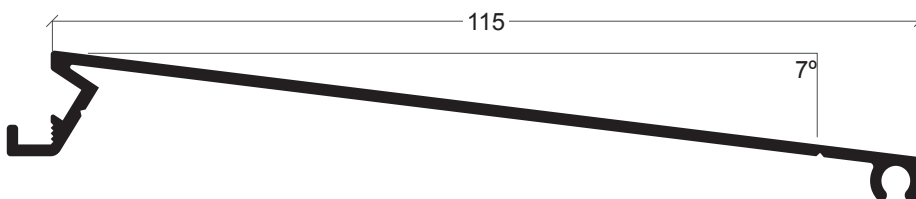

CT-32

Pingadeira 115 mm
Alargadera 115 mm

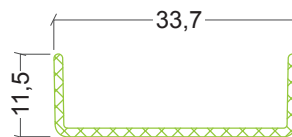

CT-85

Tampa para soleira/padieira
Tapa para marco inf./sup.

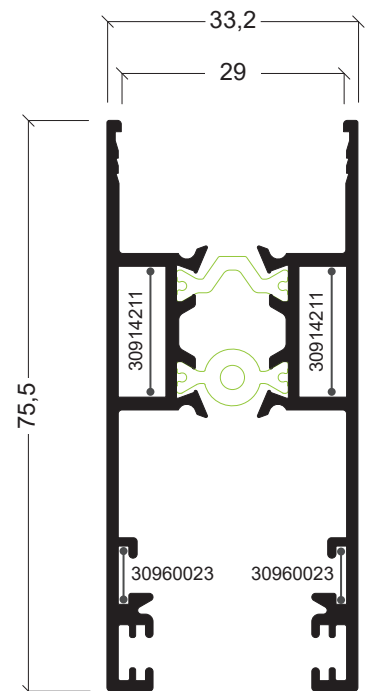

CT-91

Aro móvel
Hoja

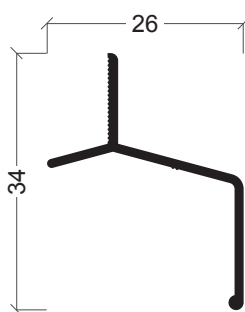

CT-07

Pingadeira superior
Vieriteguas superior

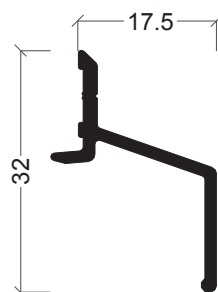

CT-29

Pingadeira superior
Vieriteguas superior



AX-19

Vareta
Pletina falleba



CT-94

Perfil união
Perfil unión

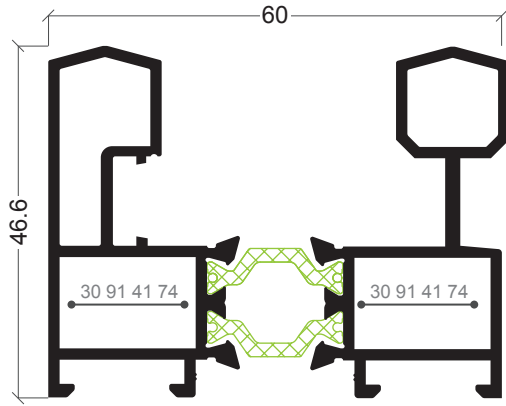

CT-41

Aro fixo perimetral
Marco perimetral

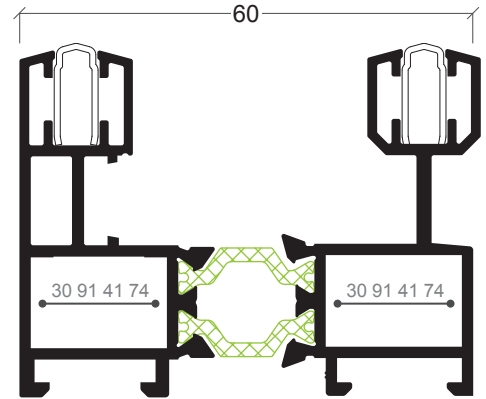

CT-42

Aro fixo perimetral
Marco inferior balconera

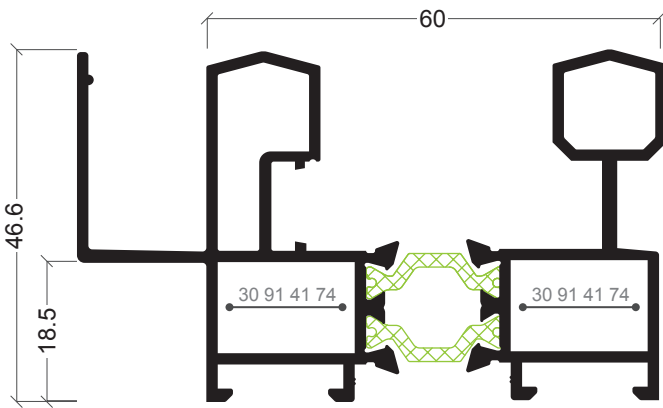

CT-43

Aro fixo perimetral
Marco perimetral con recogida

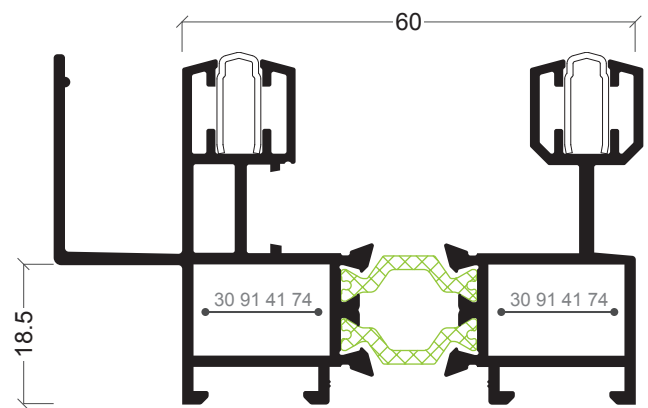

CT-44

Aro fixo perimetral
Marco inferior con recogida

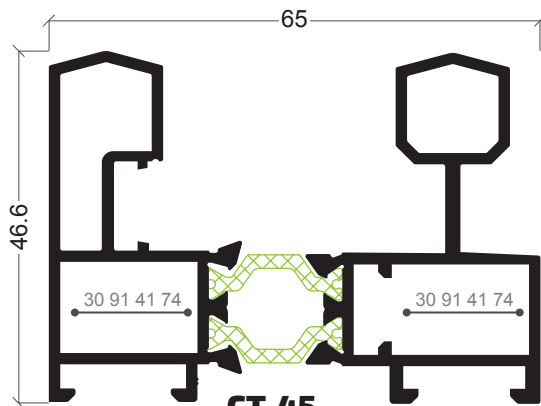

CT-45

Aro fixo perimetral
Marco perimetral

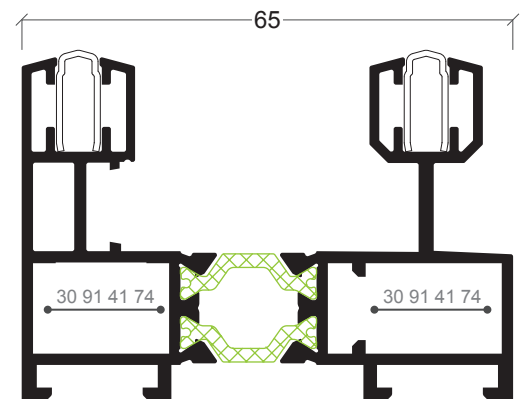

CT-46

Aro fixo perimetral
Marco inferior balconera

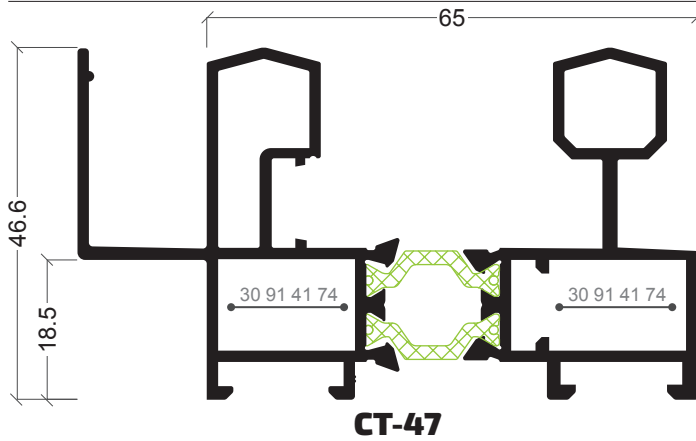

CT-47

Aro fijo perimetral
Marco perimetral con recogida

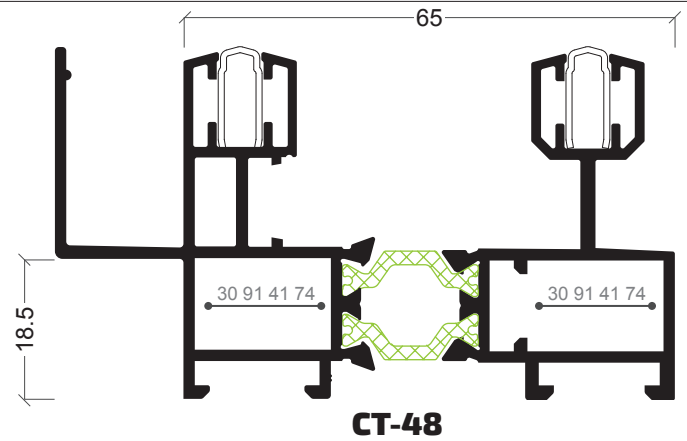

CT-48

Aro fijo perimetral
Marco inferior balconera con recogida

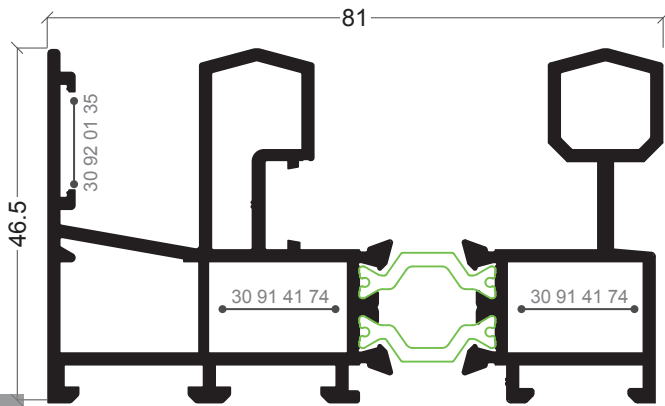

CT-49

Aro fijo perimetral
Marco perimetral con recogida

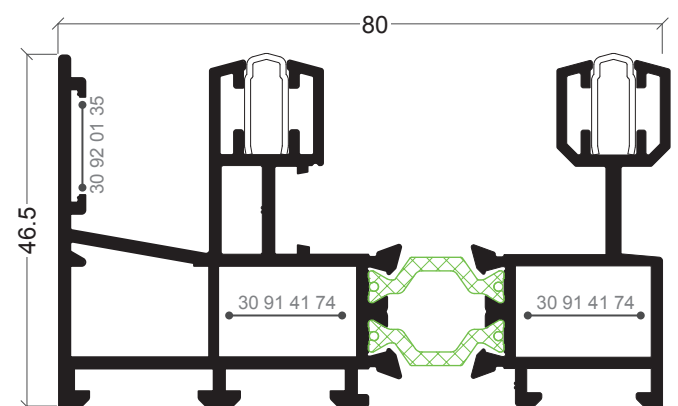

CT-50

Aro fijo perimetral
Marco inferior balconera con recogida

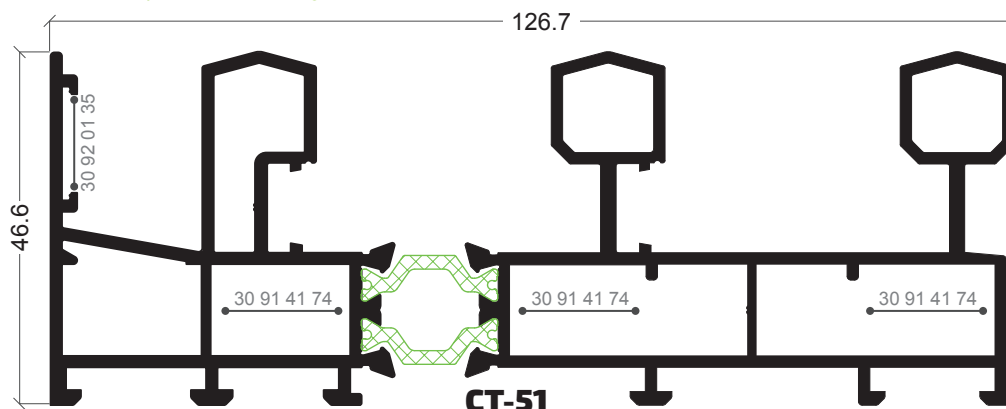

CT-51

Aro fijo perimetral tri-rail
Marco tricarril con recogida

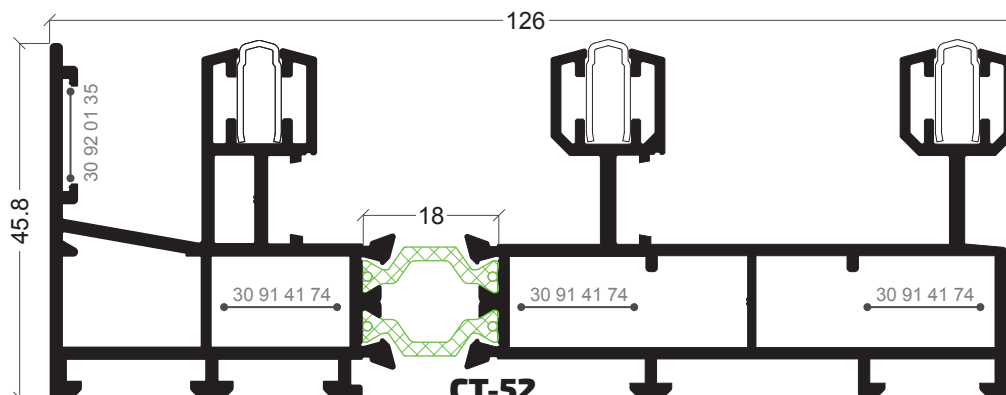

CT-52

Aro fijo perimetral tri-rail
Marco tricarril balconera con recogida

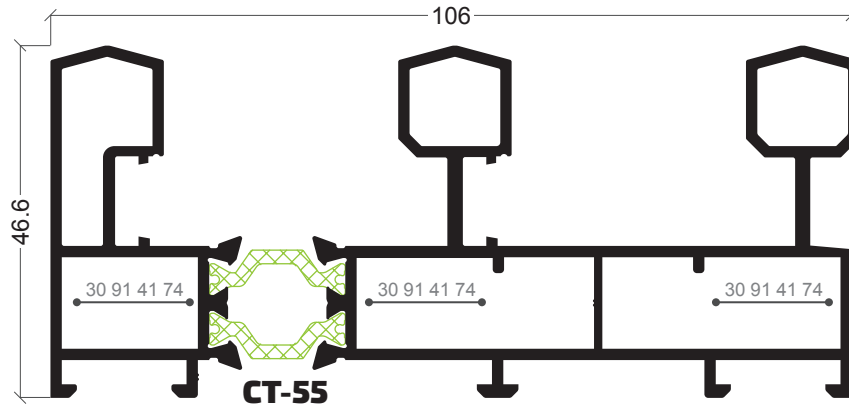

CT-55
Aro fixo perimetral tri-rail
Marco perimetral tricarril

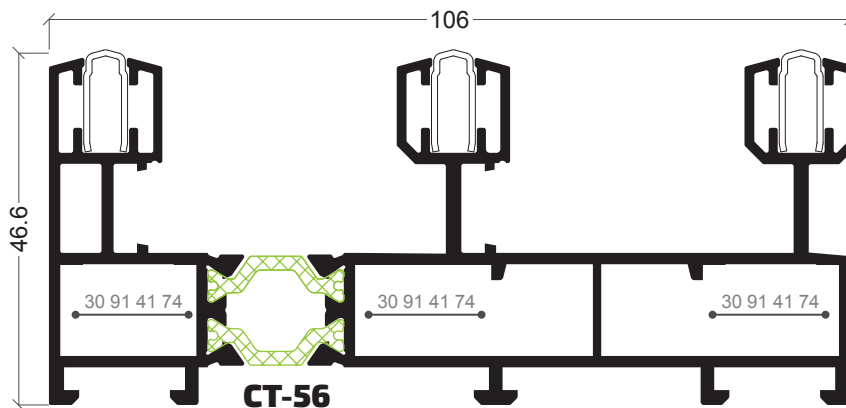

CT-56
Aro fixo perimetral tri-rail
Marco inferior balconera tricarril

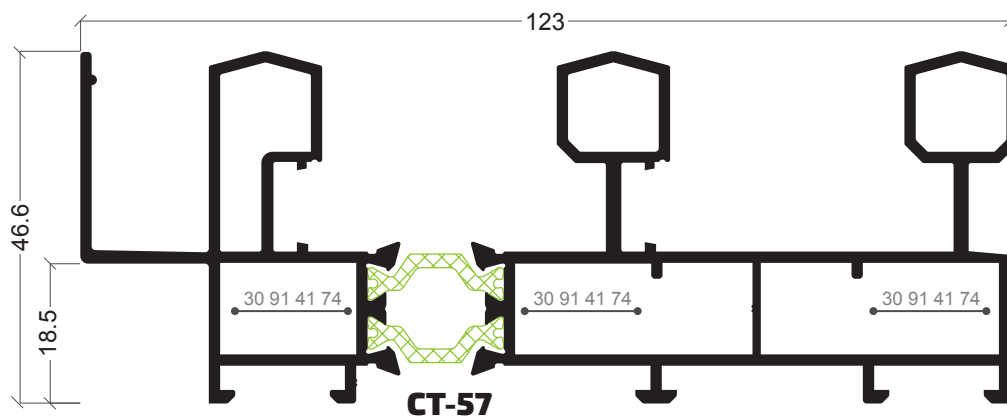

CT-57
Aro fixo perimetral tri-rail
Marco perimetral tricarril con recogida

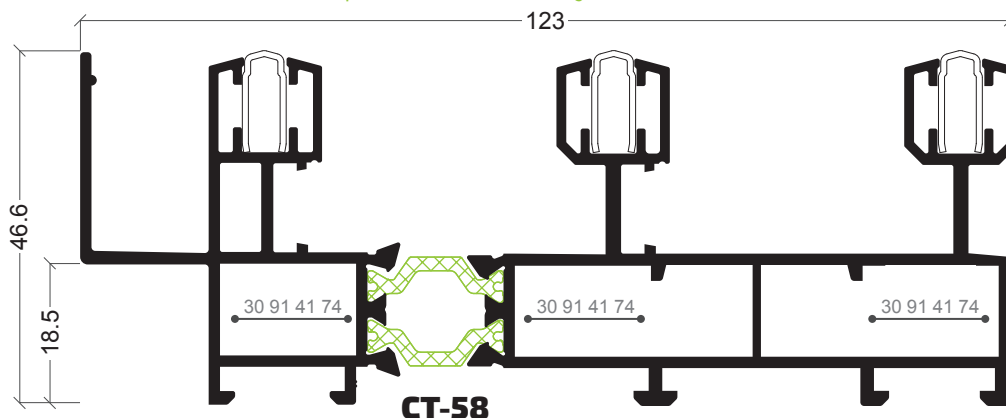

CT-58
Aro fixo perimetral tri-rail
Marco inferior tricarril con recogida

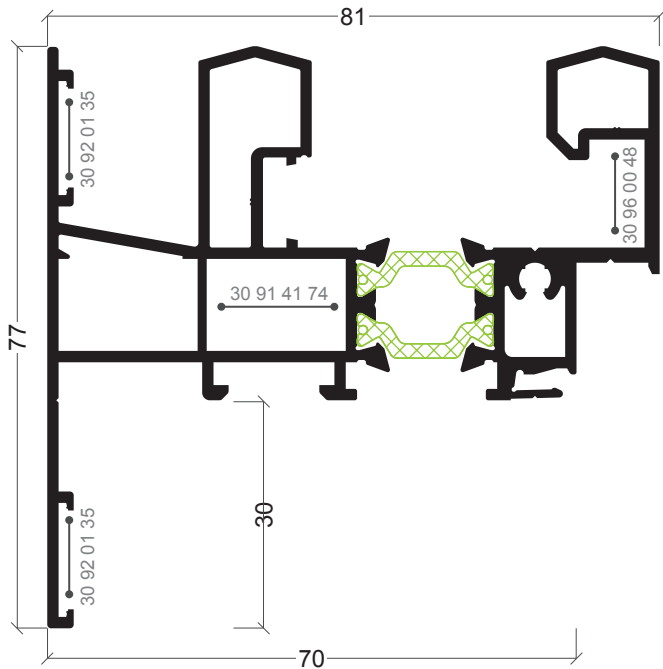

CT-61

Aro fijo perimetral c/ aba remate
Marco perimetral con solape y enganche

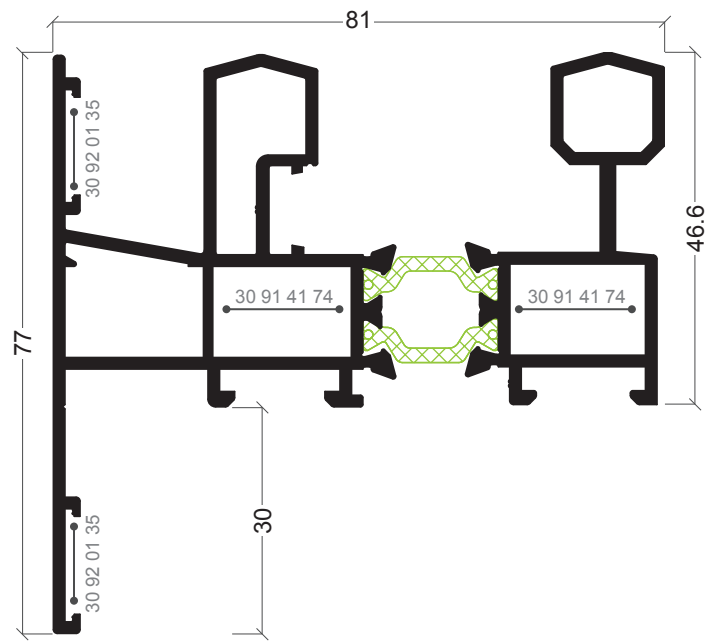

CT-62

Aro fijo perimetral c/ aba remate
Marco perimetral con solape y enganche

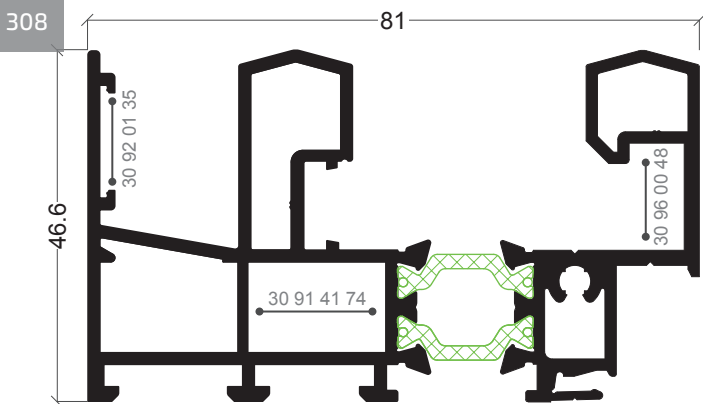

CT-63

Aro fijo perimetral
Marco perimetral con enganche

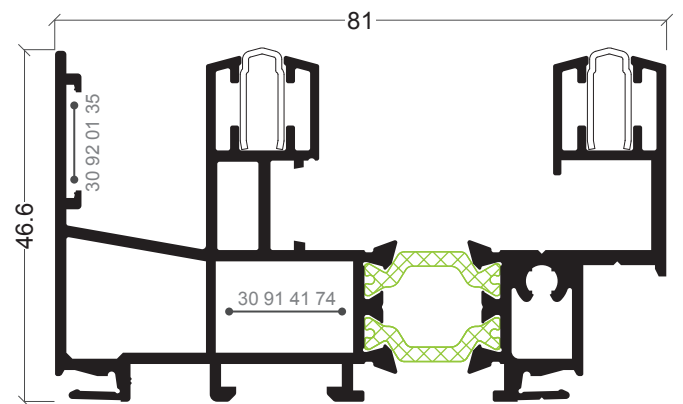

CT-69

Aro fijo perimetral
Marco perimetral inferior con enganches

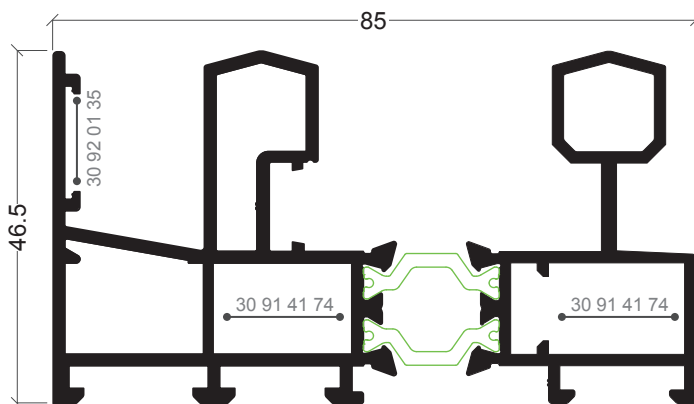

CT-101

Aro fijo
Marco

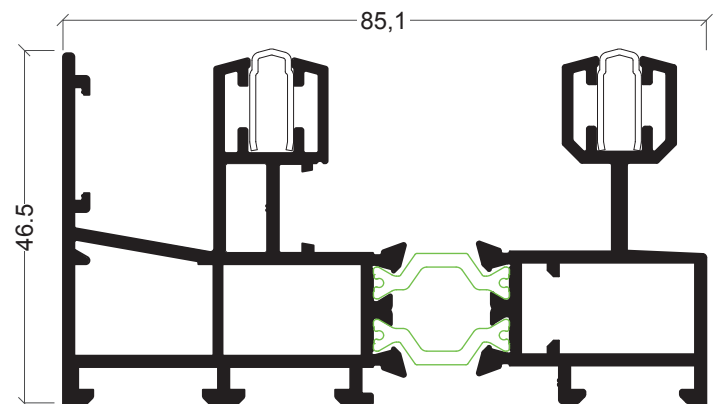

CT-104

Aro fijo
Marco

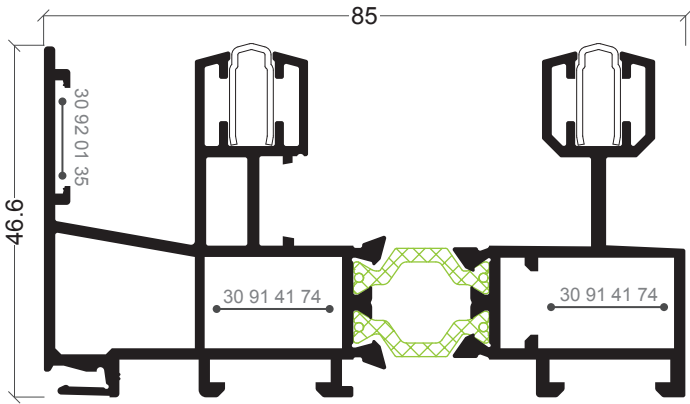

CT-72

Aro fixo perimetral
Marco perimetral

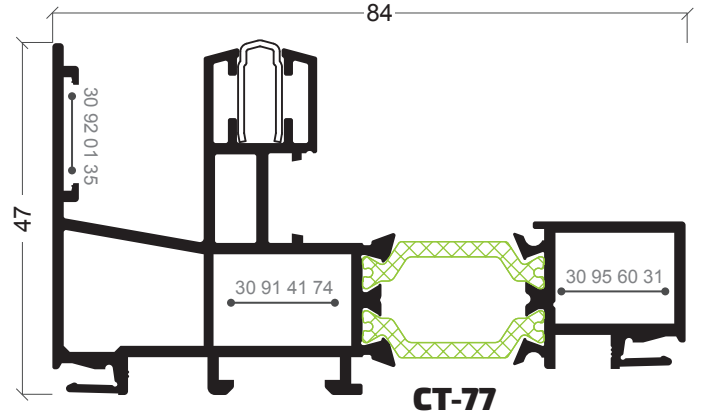

CT-77

Aro fixo galandage
Marco galandage con enganches

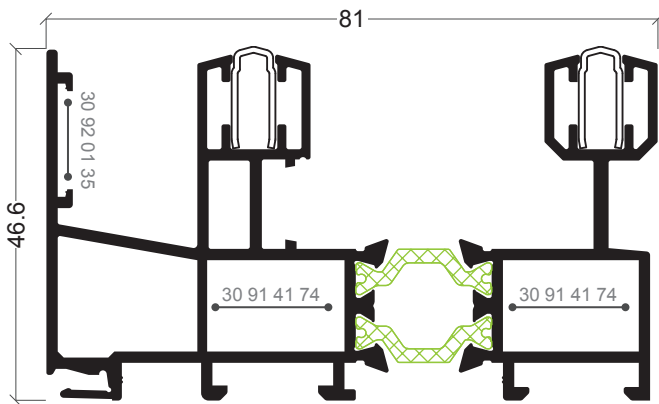

CT-75

Aro fixo bi-rail
Marco perimetral c/ recogida y enganche int.

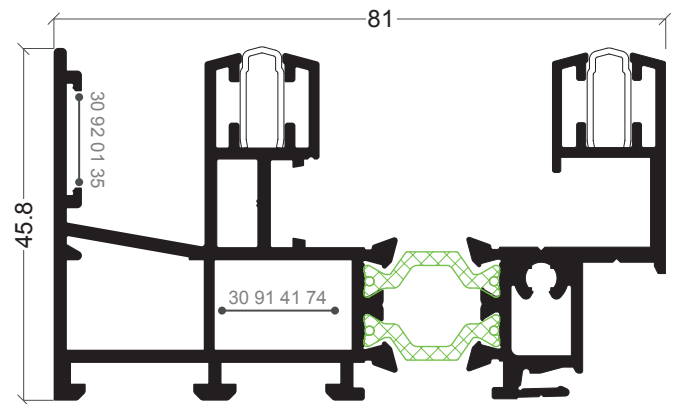

CT-80

Aro fixo bi-rail
Marco bicarril con enganche ext.

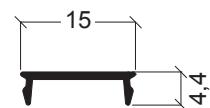

KL-04

Tampa
Tapa

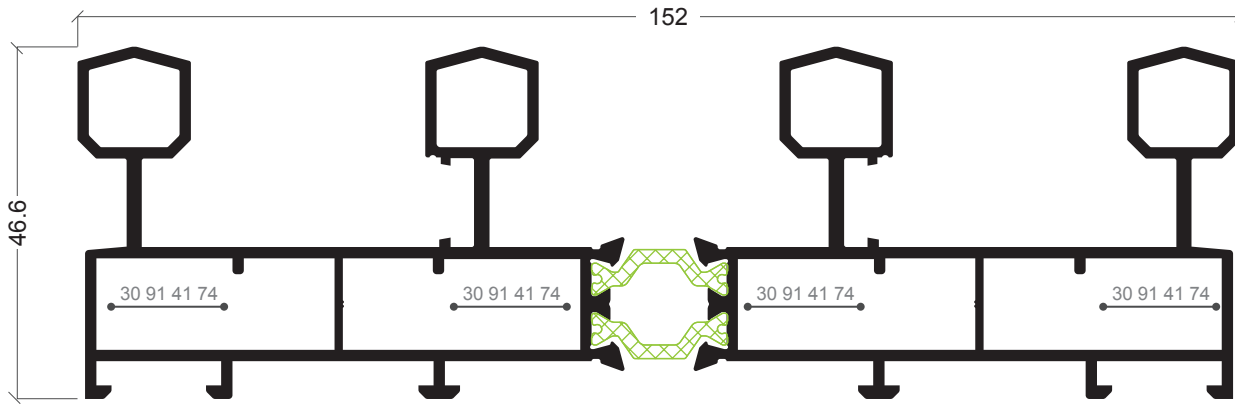

CT-65

Aro fixo quadri-rail
Marco perimetral quatro carriles

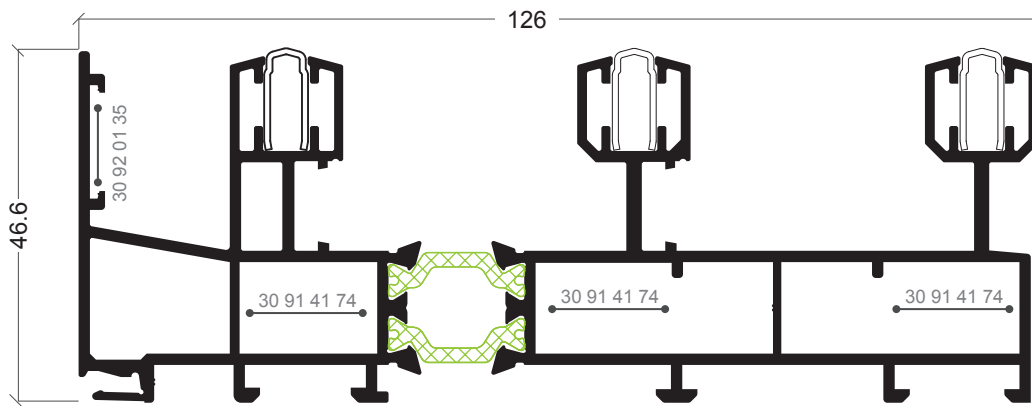

CT-76

Aro fixo tri-rail
Marco inferior tricarril balconera
con enganche int.

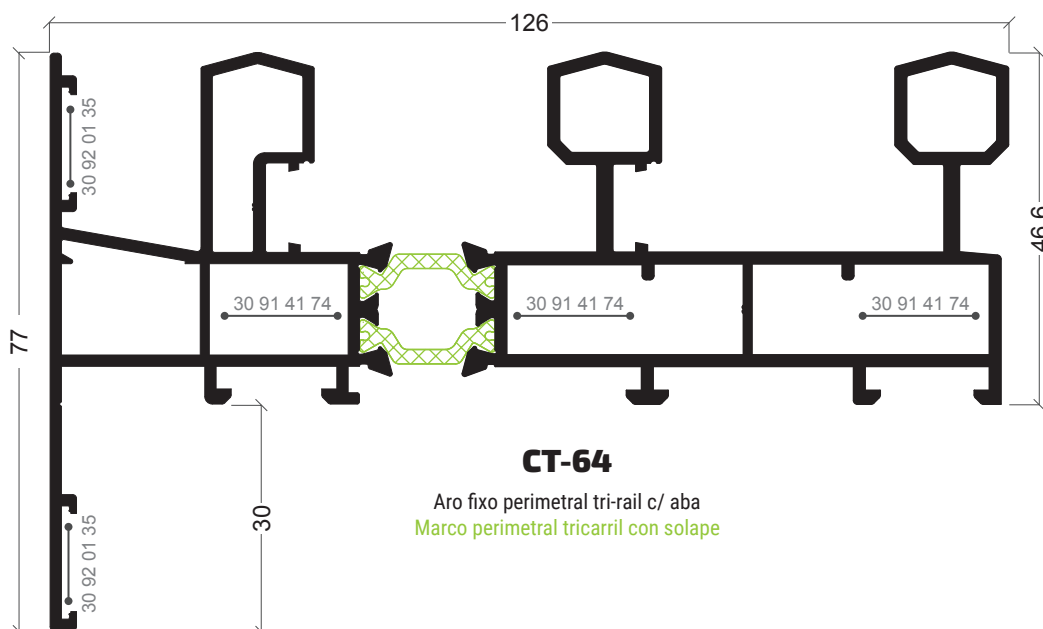

CT-64

Aro fixo perimetral tri-rail c/ aba
Marco perimetral tricarril con solape

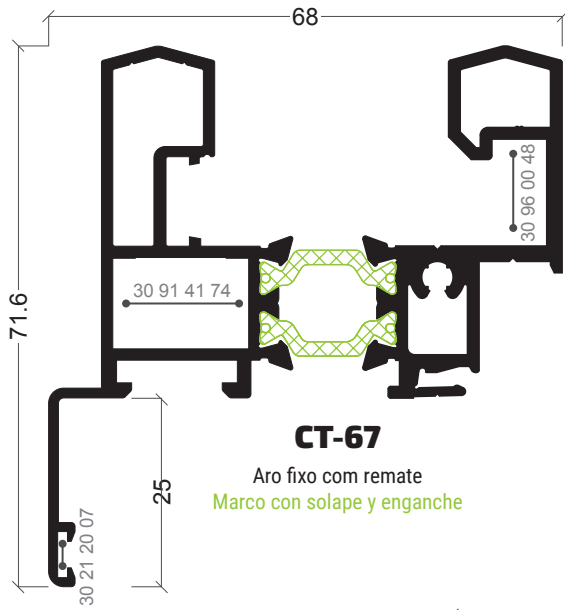

CT-67
Aro fixo com remate
Marco com solape y enganche

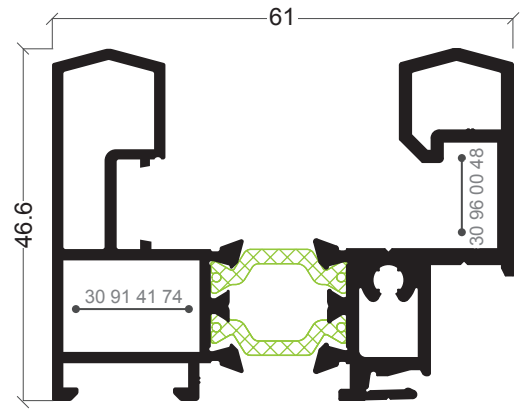

CT-68
Aro fixo com remate
Marco ventana con enganche

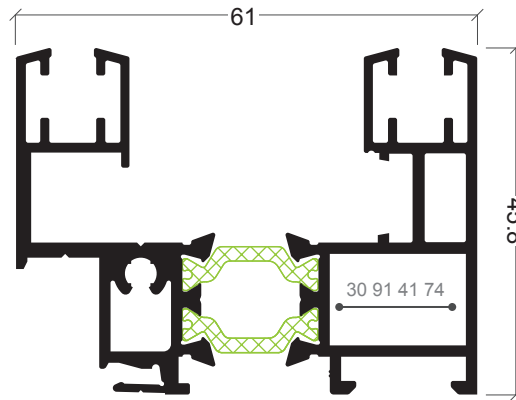

CT-86
Aro fixo
Marco

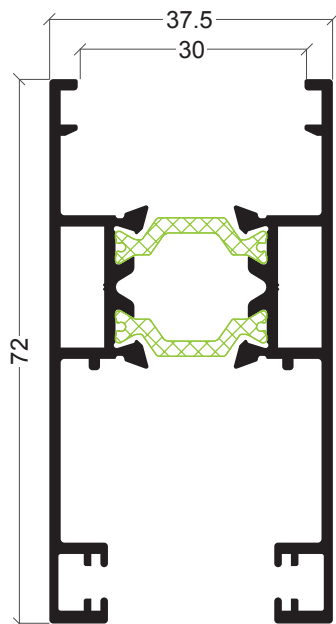

CT-35
Aro móvel lateral
Hoja lateral

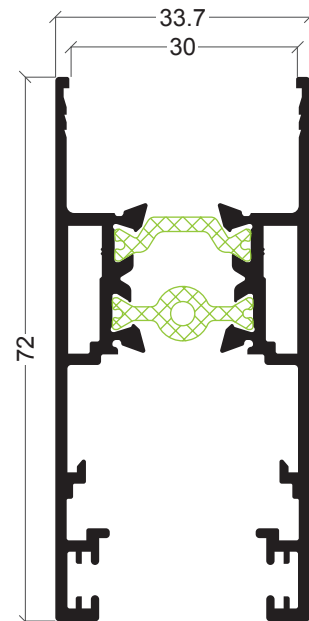

CT-34
Aro móvel carrinho
Hoja de rodas y superior

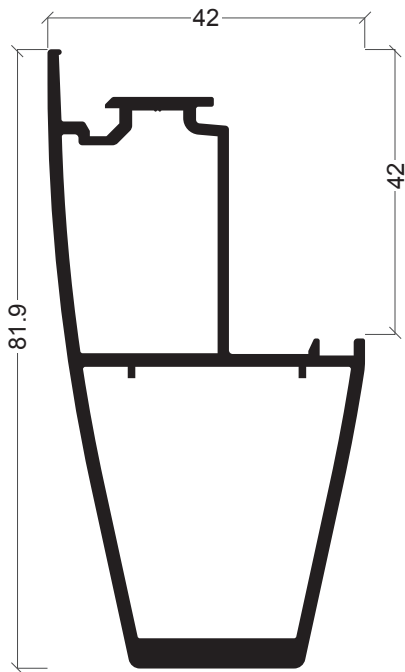

CT-38

Aro móvel central com reforço
Hoja central con refuerzo

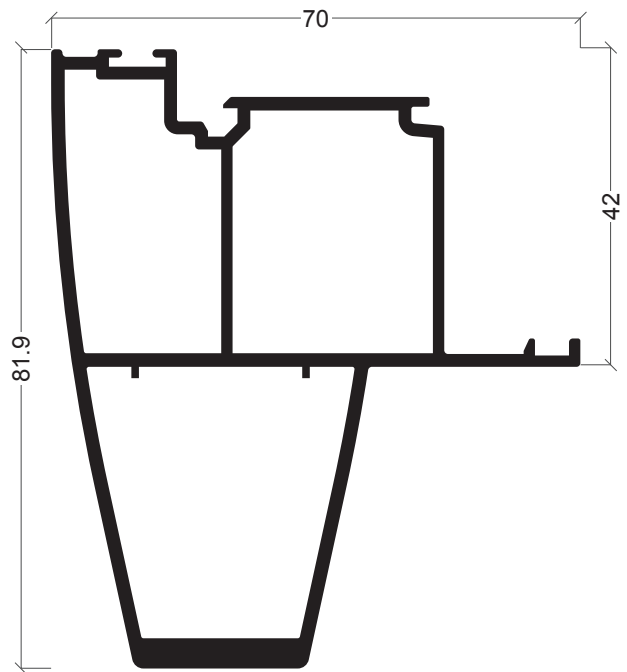

CT-39

Aro móvel central com reforço
Hoja central con refuerzo

312

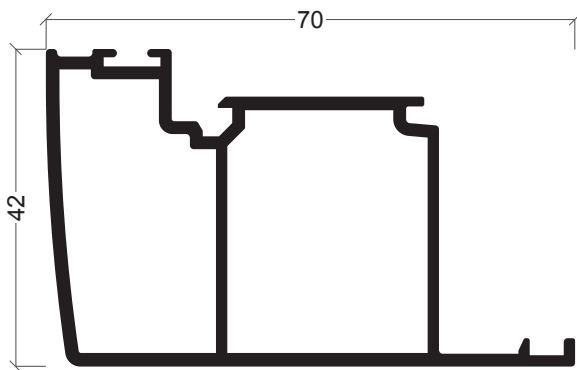

CT-37

Aro móvel central
Hoja central balconera

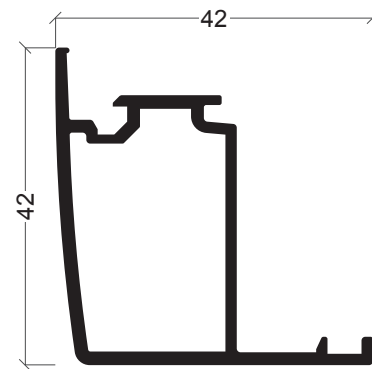

CT-36

Aro móvel central
Hoja central ventana

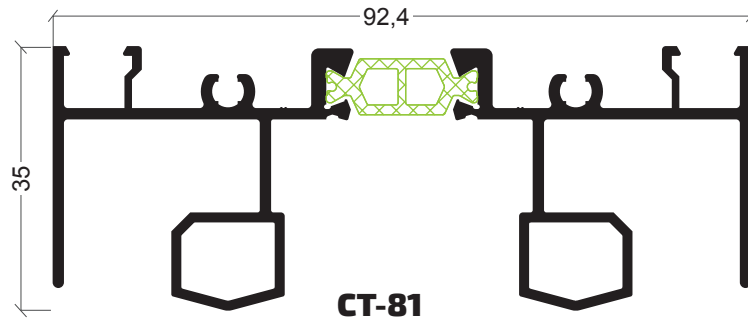

CT-81

Padieira
Marco superior

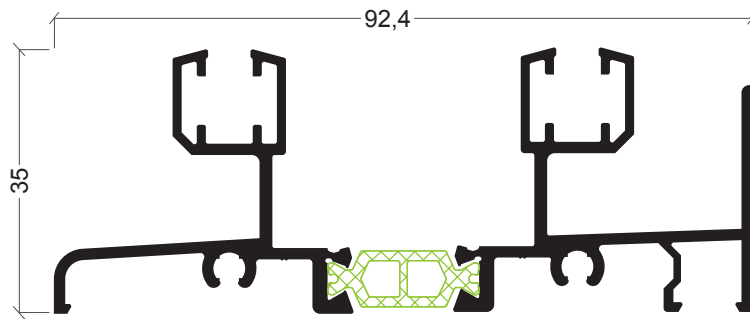

CT-82

Soleira
Marco inferior

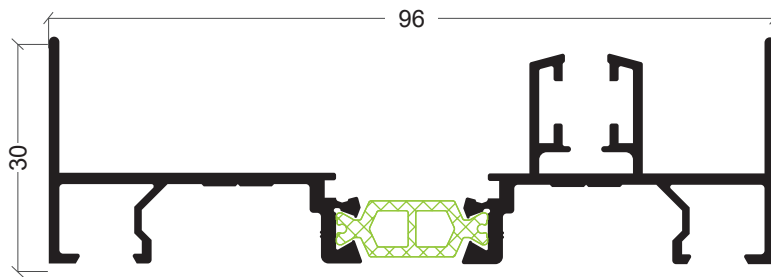

CT-83

Ombreira 115 mm
Alargadera 115 mm

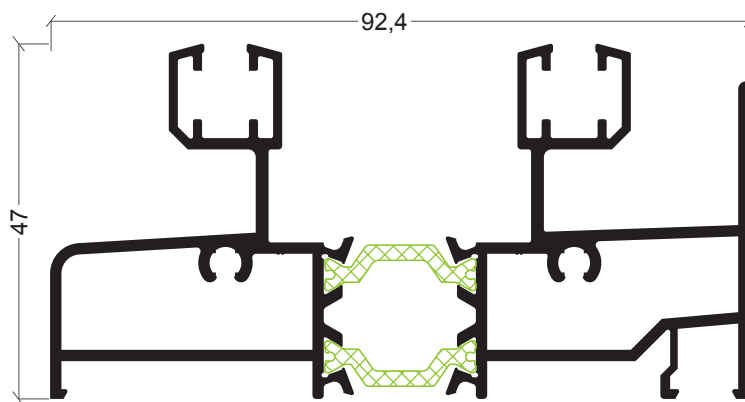

CT-84

Soleira
Marco inferior

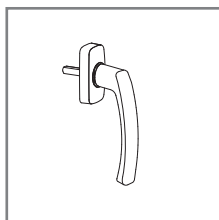

30 60 16 40/41/42

Puxador de Alumínio
Manilha de Alumínio

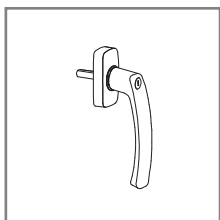

30 60 16 43/44

Puxador de Alumínio Champ AC/Inox AC
Manilha de Alumínio Champ AC/Inox AC

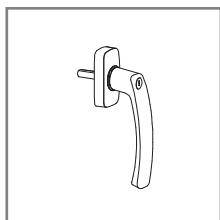

30 60 16 45/46/47

Puxador de Alumínio c/chave
Manilha de Alumínio c/llave

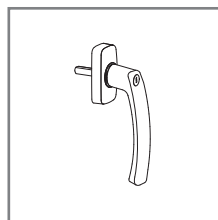

30 60 16 47/48

Puxador de Alumínio c/chave Nat. AC/Ch. AC.
Manilha de Alumínio c/llave Nat. AC/Ch. AC.

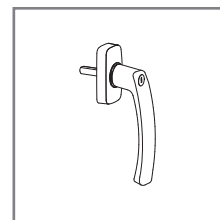

30 60 16 49

Puxador de Alumínio c/ chave Inox AC.
Manilha de Alumínio c/ llave Inox AC.

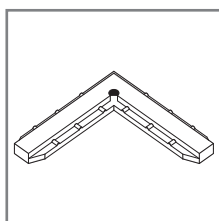

30 21 20 07

Esquadro de alinhamento
Escuadra de alineamiento

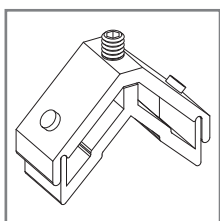

30 91 40 15

Esquadro aro fixo
Escuadra marco

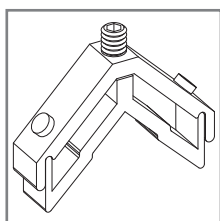

30 91 40 25

Esquadro aro móvel
Escuadra hoja

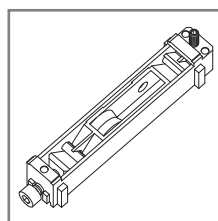

30 91 40 35

Rolamento simples (25Kg por rolamento)
Rodamiento simples (25Kg por rodamiento)

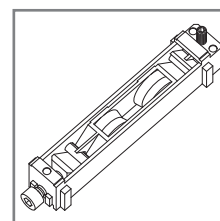

30 91 40 36

Rolamento duplo (50Kg por rolamento)
Rodamiento doble (50Kg por rodamiento)

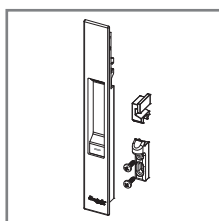

30 91 40 39/40/41

Fecho lateral manual natural branco/preto
Cierre lateral manual natural/blanco/negro

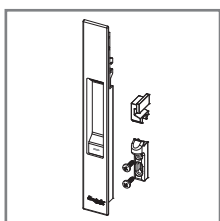

30 91 40 42/43

Fecho lateral de embutir branco/preto
Cierre lateral de embutir blanco/negro

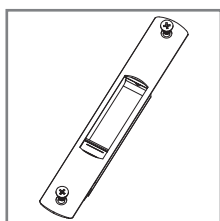

30 91 40 45/46

Fecho lateral com fixação branco/preto
Cierre lateral con fijación blanco/negro

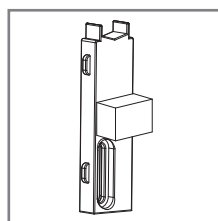

30 91 40 50

Guia lateral batente
Guia lateral batiente

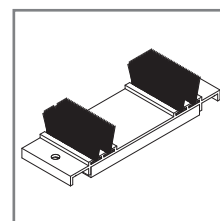

30 91 40 70

Cortaventos superior/inferior
Cortavientos superior/inferior

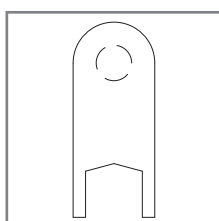

30 91 41 00

Tampa aro móvel recta
Tope hoja recta

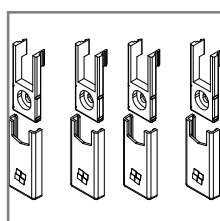

30 91 41 01

Conjunto Guias CT Minimal Preto
Conjunto Guias CT Minimal Negro

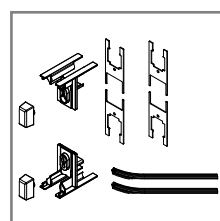

30 91 41 02

Kit lateral CT Minimal Preto
Kit lateral CT Minimal Negro

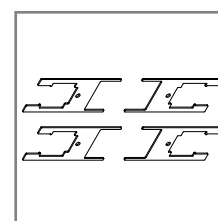

30 91 41 03

Kit estanquidade CT Minimal
Kit Estanquidad CT Minimal

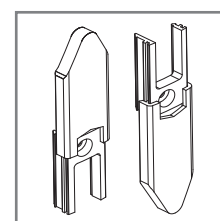

30 91 41 05

Jogo topos laterais
Juego topes laterales

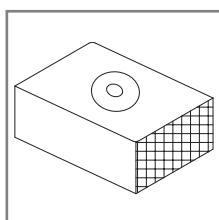

30 91 41 10

Taco anti-levantamento preto
Taco antilevantamiento negro

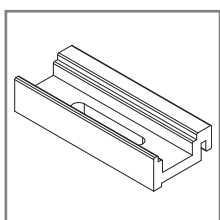

30 91 41 20

Calço n° 1 para multiponto CT-02/12/53
Suplemento n° 1 para multipunto CT-02/12/53

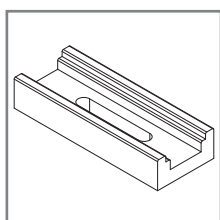

30 91 41 21

Calço n° 2 para multiponto CT-35
Suplemento n° 2 para multipunto CT-35

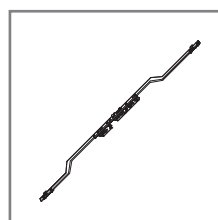

30 91 41 22

Ferragem MP c/ chave sem canhão
Herraje MP c/ llave sin cilindro

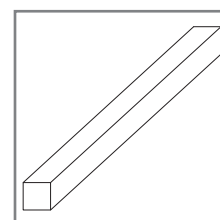

30 91 41 23

Perno 7x131 mm
Perno 7x131 mm

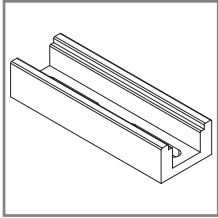

30 91 41 24

Calço nº 3 para 4F ou ferragens inox
Suplemento nº 3 para 4F o ferrages inox

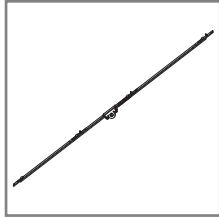

30 91 41 29

Barra 4 pontos (1800 mm)
Barra 4 puntos (1800 mm)

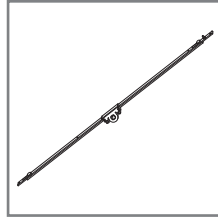

30 91 41 30

Barra 2 pontos (600 mm)
Barra 2 puntos (600 mm)

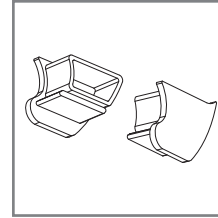

30 91 41 35

Jogo topos preto CT-03 / CT-27
Juego topes negro CT-03 / CT-27

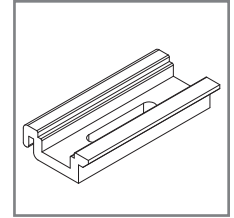

30 91 41 39

Calço nº6 para multiponto CT-100
Suplemento nº6 para multipunto CT-100

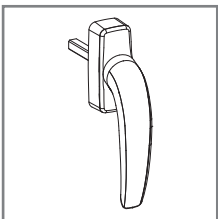

30 91 41 47/48

Cremona multi-ponto branco/preto
Cremona multipunto blanco/negro

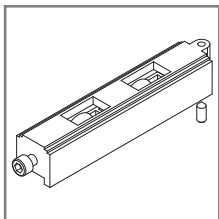

30 91 41 49

Rolamento duplo (75 kg por rolamento)
Rodamiento doble (75 kg por rodamiento)

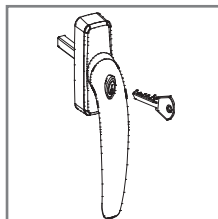

30 91 41 56/57

Cremona porta com chave branco/preto
Cremona puerta con llave blanco/negro

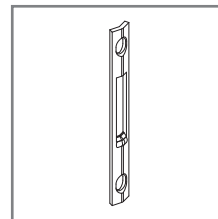

30 91 41 61

Ponto de fecho plano (para ferragem inox)
Punto de cierre plano (para herraje inox)

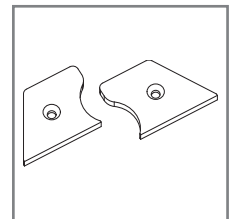

30 91 41 65/66

Jogo topos CT-28 branco/preto
Juego topes CT-28 blanco/negro

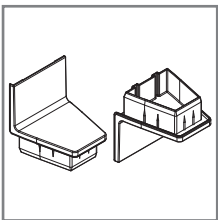

30 91 41 67/68

Jogo topos centrais (branco/preto)
Juego topes centrales (blanco/negro)

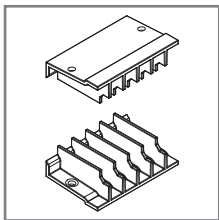

30 91 41 69

Cortaventos aro Benelux (CT-36/38)
Cortavientos marco Benelux (CT-36/38)

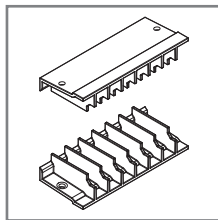

30 91 41 70

Cortaventos aro Benelux (CT-02/12/37/39/53)
Cortavientos marco Benelux (CT-02/12/37/39/53)

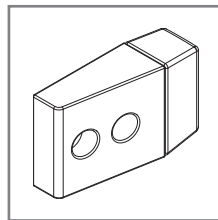

30 91 41 71

Topo limitador de abertura
Tope limitador de apertura

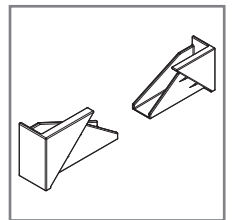

30 91 41 72/73

Jogo topos condensação móvel branco/preto
Juego topes marco condensación blanco/negro

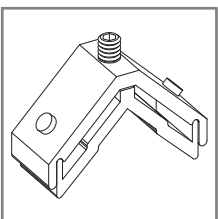

30 91 41 74

Esquadro aro perimetral Benelux
Escuadra marco perimetral Benelux

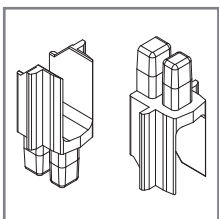

30 91 41 89

Conjunto topos CT-24 preto
Conjunto topes CT-24 negro

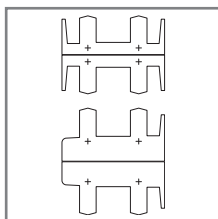

30 91 41 93/94

Kit estanquidade CT Euro nº 1 / CT Euro nº 2
Kit estanquidad CT Euro nº 1 / CT Euro nº 2

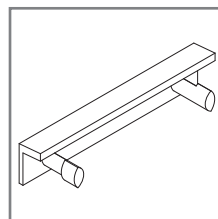

30 91 41 96/97

Goteira CT Euro branco/preto
Vierteaguas CT Euro blanco/negro

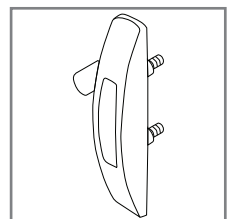

30 91 42 00/01

Fecho janela multiponto branco/preto
Cierre ventana multipunto blanco/negro

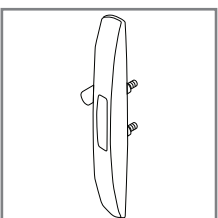

30 91 42 05/06

Fecho porta multiponto branco/preto
Cierre puerta multipunto blanco/negro

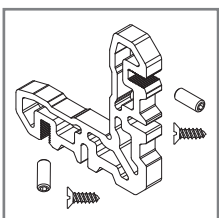

30 91 42 11

Esquadro de alumínio para perfil CT-100
Escuadra de aluminio para el perfil CT-100

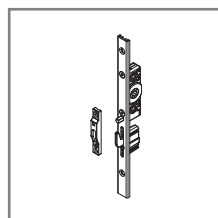

30 91 42 20

Barra Monoponto 1 gancho com falsa manobra
Barra Monopunto 1 gancho

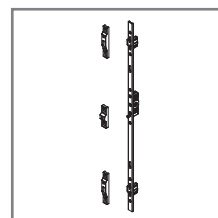

30 91 42 21

Barra Multiponto 2 ganchos com falsa manobra
Barra Multipunto 2 ganchos

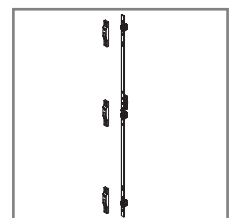

30 91 42 22

Barra Multiponto 3 ganchos com falsa manobra
Barra Multipunto 3 ganchos

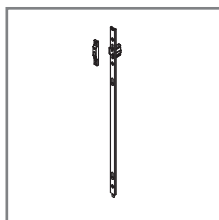

30 91 42 23

Extensão superior
Extensión superior

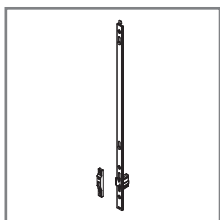

30 91 42 24

Extensão inferior para multiponto inox (400mm)
Extensión inferior para multiponto inox (400mm)

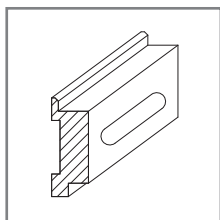

30 91 42 25

Calço nº5 para multiponto com falsa manobra (para perfil CT-100)
Suplemento nº6 para multiponto (para perfil CT-100)

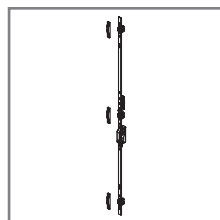

30 91 42 26

Barra Multiponto com chave em aço inox (1000mm) com falsa manobra
Barra multipunto con clave inox (1000mm)

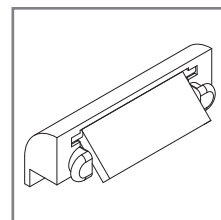

30 92 01 02/03

Goteira c/ válvula (preto/branco)
Tapa salida de aguas c/ válvula negro / blanco

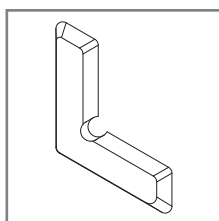

30 92 01 35

Esquadro de alinhamento
Escuadra alineamiento

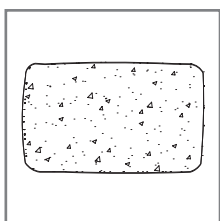

30 92 04 70

Espuma isolante
Espuma aislante

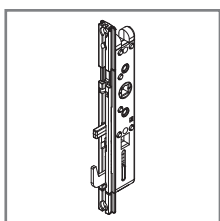

30 92 07 30

Ferragem MP regulável inox 1 ponto CT-35
Herraje MP regulable inox 1 punto CT-35



30 92 07 35

Ferragem MP regulável inox 2 pontos CT-35
Herraje MP regulable inox 2 puntos CT-35

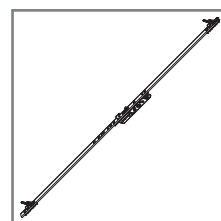

30 92 07 40

Ferragem MP regulável inox 3 pontos CT-35
Herraje MP regulable inox 3 puntos CT-35



30 92 07 45

Ferragem MP regulável inox 3 pontos com chave CT-35
Herraje MP regulable inox 3 puntos con llave CT-35

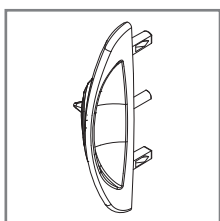

30 92 07 50/55

Cremone calipso interior branco/preto (para ferragem inox)
Manilla calipso interior blanco/negro (p/ herraje inox)

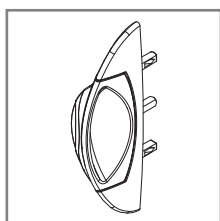

30 92 07 60/65

Cremone neptune interior branco/preto (para ferragem inox)
Manilla neptune interior blanco/negro (p/ herraje inox)

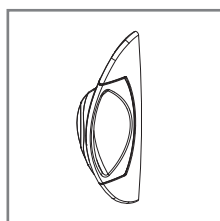

30 92 07 70/75

Cremone neptune exterior branco/preto (para ferragem inox)
Manilla neptune exterior blanco/negro (p/ herraje inox)

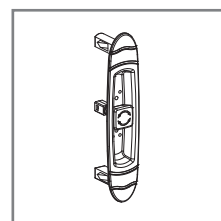

30 92 07 80/85

Fecho lateral hera branco/preto (para ferragem inox)
Cierre lateral hera blanco/negro (p/ herraje inox)

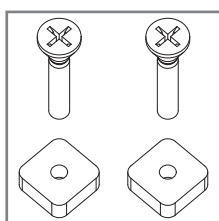

30 92 07 96

Placas para pontos de fecho multiponto com carris abertos
Placas para puntos de cierre multipunto con carriles abiertos

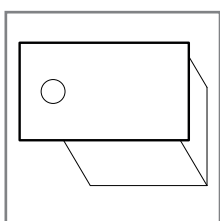

30 94 60 35

Topo para CT-103
Tope para CT-103

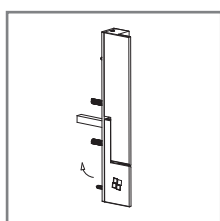

30 94 60 97/98

Fecho Minimalista Direito
Cierre Minimalista Derecho

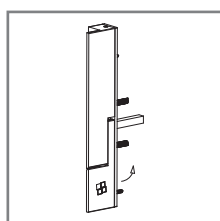

30 94 60 99/30 94 61 00 30 94 61 60/61/62

Fecho Minimalista Esquerdo
Cierre Minimalista Izquierdo

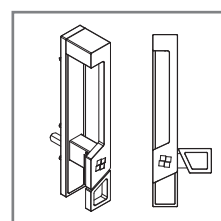

Asa Multiponto WIN Direita branco/preto/2AC
Asa Multipunto WIN Derecha blanco/negro/2AC

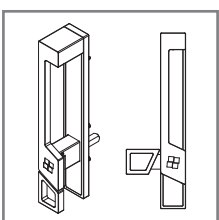

30 94 61 63/64/65

Asa Multiponto WIN Esquerda branco/preto/2AC
Asa Multipunto WIN Izquierda blanco/negro/2AC

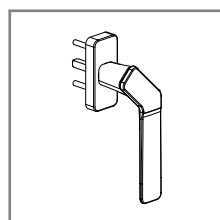

30 95 60 26/28

Cremone desviado MP direito branco/preto
Manilla desplazado MP derecho blanco/negro

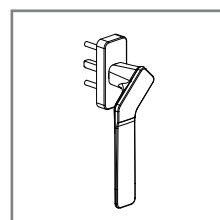

30 95 60 27/29

Cremone desviado MP esquerdo branco/preto
Manilla desplazado MP izquierdo blanco/negro

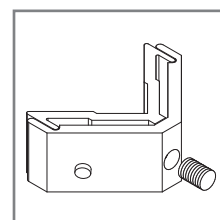

30 95 60 31

Esquadro descentrado 15x12
Escuadra descentrada 15x12

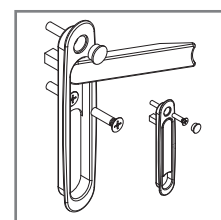

30 95 60 37/38

Fecho rotativo Multiponto branco/preto
Cierre giratorio Multipunto blanco/negro

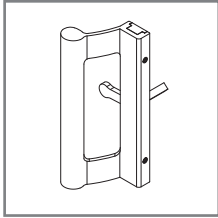

30 95 60 44/45/46

Asa Multiponto
Asa Multipunto

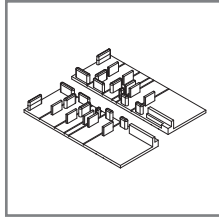

30 95 60 60

Conjunto de vedação preto
Conjunto de vedación negro

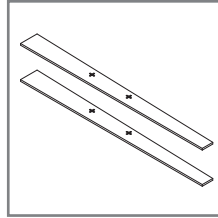

30 95 60 61

Conjunto de juntas
Conjunto de juntas

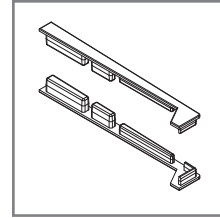

30 95 60 62

Conjunto de topos S-36
Conjunto de topos S-36

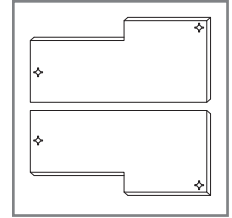

30 95 60 63

Conjunto de Juntas de estanquidade CW-28
Conjunto de Juntas de estanquidad CW-28

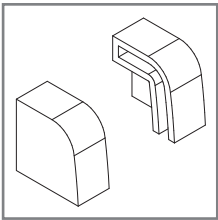

30 96 00 12

Jogo topos condensação CT-11/ARI-32
Juego topos condensación CT-11/ARI-32

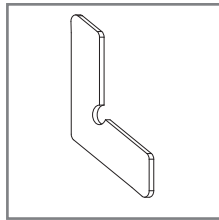

30 96 00 23

Esquadro de alinhamento
Escuadra alineamiento

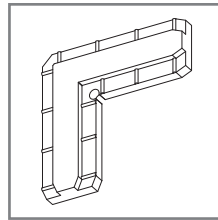

30 96 00 43

Esquadro de alinhamento
Escuadra alineamiento

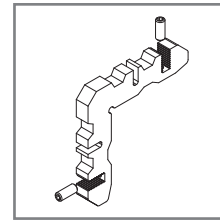

30 96 00 48

Esquadro de alinhamento 7x14 c/ parafusos
Escuadra alineamiento 7x14 c/ tornillos

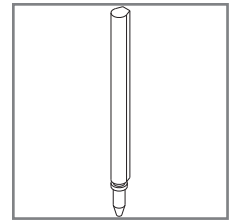

30 96 00 55

Perno alternativo para fixação de esquadro
Perno alternativo para fijación de escuadra

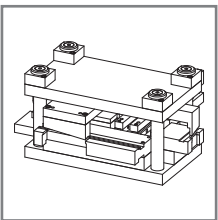

33 94 29 99

Cunho CT
Troquel CT

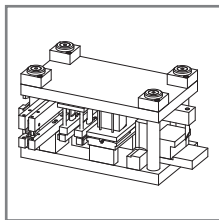

33 94 30 00

Cunho CT Benelux
Troquel CT Benelux

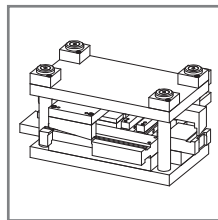

33 94 30 10

Cunho CT-Compact
Troquel CT-Compact

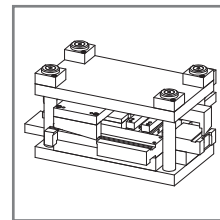

33 94 30 30/40

Cunho CT Euro
Troquel CT Euro

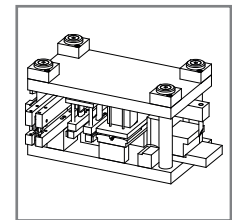

33 94 30 50

Cunho CT-100
Troquel CT-100

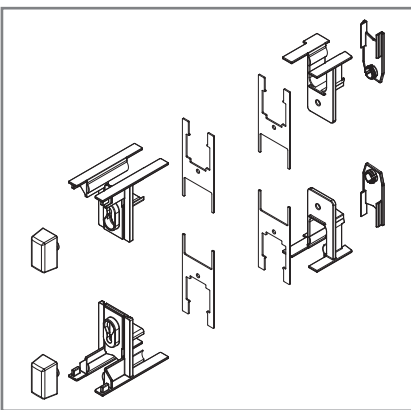

30 91 41 81

Kit topos de janela folhas laterais
Benelux (1 folha)
Kit topos de ventana hojas laterales
Benelux (1 hoja)

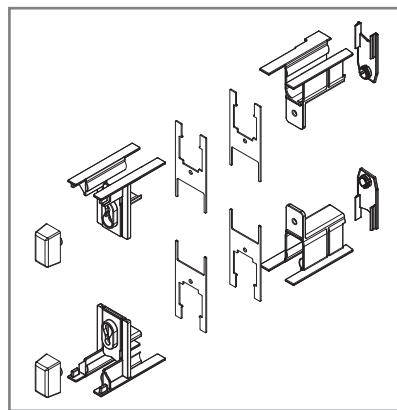

30 91 41 82

Kit topos de porta folhas laterais
Benelux (1 folha)
Kit topos de puerta hojas laterales
Benelux (1 hoja)

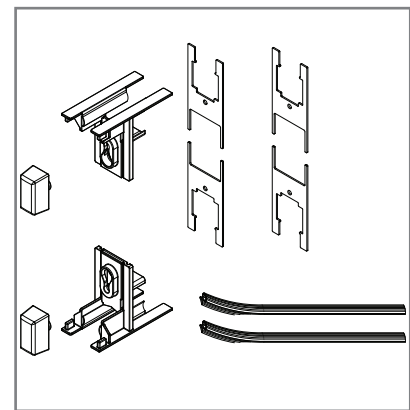

30 91 41 02

Kit lateral CT Minimal preto
Kit lateral CT Minimal negro

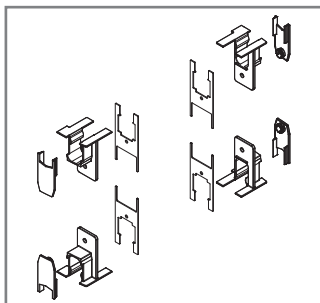

30 91 41 83

Kit topos de janela folha central
Benelux (3ª folha)
Kit topos de ventana hoja central
Benelux (3ª hoja)

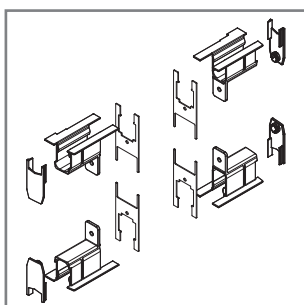

30 91 41 84

Kit topos de porta folha central
Benelux (3ª folha)
Kit topos de puerta hoja central
Benelux (3ª hoja)

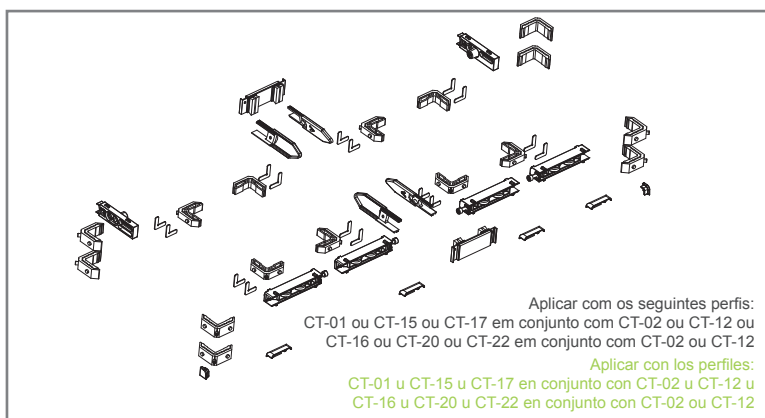

Aplicar com os seguintes perfis:
CT-01 ou CT-15 ou CT-17 em conjunto com CT-02 ou CT-12 ou
CT-16 ou CT-20 ou CT-22 em conjunto com CT-02 ou CT-12

Aplicar con los perfiles:
CT-01 u CT-15 u CT-17 en conjunto con CT-02 u CT-12 u
CT-16 u CT-20 u CT-22 en conjunto con CT-02 ou CT-12

30 91 41 85

Kit de correr janela CT (2 folhas). Resistência até 50Kg/folha.
Utilização em vãos de 2 folhas.
Kit corredera ventana CT (2 hojas). Resistencia hasta 50Kg/
hoja. Para huecos de 2 hojas.

30 91 41 86

Kit de correr janela CT (2 folhas). Resistência até 100Kg/folha.
Utilização em vãos de 2 folhas.
Kit corredera puerta CT (2 hojas). Resistencia hasta 100Kg/hoja.
para huecos de 2 hojas.

REFERÊNCIA - REFERENCIA	DESENHO - DISEÑO	DESCRIÇÃO - DESCRIPCIÓN
30 20 30 03		Junta isolante CT-01/11/15/17 • Junta aislante CT-01/11/15/17
30 25 44 15		Junta tapa canal CT-59 • Junta tapa canal CT-59
30 91 40 72		Junta U (vidrio 26mm) CT-53 • Junta U(vidrio 26mm) CT-53
30 91 40 73		Junta U CT-Benelux preto (vidrio 22mm) • Junta U CT-Benelux negro (vidrio 22mm)
30 91 40 74		Junta Central CT Minimal preto • Junta Central CT Minimal
30 91 41 87		Junta tapa canal aberto • Junta tapa carril abierto
30 91 41 88		Junta de correr • Junta corredera
30 91 41 95		Junta aro fixo lateral preto • Junta marco lateral negro
30 93 00 65		Junta interior para vidro (5 mm) • Junta interior para vidrio (8/9 mm)
30 93 00 66		Junta interior para vidro (4 mm) • Junta interior para vidrio (8/9 mm)
30 93 00 67		Junta interior para vidro (2 mm) • Junta interior para vidrio (8/9 mm)
30 93 00 68		Junta interior para vidro (6/7 mm) • Junta interior para vidrio (8/9 mm)
30 93 00 69		Junta interior para vidro (8/9 mm) • Junta interior para vidrio (8/9 mm)
30 95 00 40		Pelúcia 7x5.5 mm STOP-FIN • Burlete 7x5.5 mm STOP-FIN
30 95 00 50		Pelúcia 7x6 mm STOP-FIN • Burlete 7x6 mm STOP-FIN
30 95 00 70		Pelúcia 7x3.5 mm • Burlete 7x3.5 mm
30 95 00 10		Pelúcia 7x9 mm STOP-FIN • Burlete 7x9 mm STOP-FIN

Janela 2 folhas correr com fecho lateral • Ventana 2 hojas corredera con cierre lateral
PERFIS • PERFIS

DESENHO • DISEÑO	REF.	DESCRIÇÃO • DESCRIPCIÓN	CORTE CORTE	QUANTIDADE CANTIDAD	MEDIDAS • MEDIDA
	CT-41	Aro fixo perimetral Marco perimetral		2	L
			2	H-28.5 mm	
	CT-23	Tampa aro fixo Tope marco perimetral		2	L-40 mm
				2	H-68 mm
	CT-53	Aro móvel perimetral Hoja perimetral recta		4	L/2+1 mm
				4	H-101.5 mm
	CT-54	Tampa cruzamento 2 folhas Tope recta cruze 2 hojas		2	H-101.5 mm
	CT-29	Pingadeira superior Vierteaguas superior		1	L
	CT-08	União cruzamento 2 folhas Cruze de hojas		2	H-101.5 mm
	CT-11	Soleira de condensação Condensación		1	L

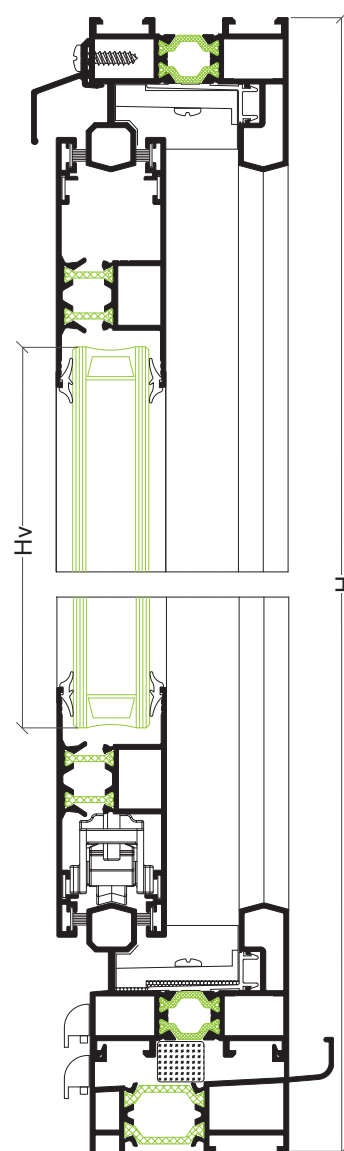
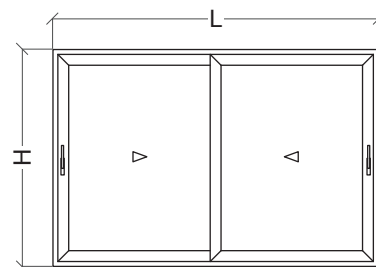

ACESSÓRIOS E JUNTAS • ACCESORIOS Y JUNTAS

REF.	DESCRIÇÃO • DESCRIPTION	QUANTIDADE CANTIDAD
30 91 41 74	Esquadro aro fixo • Escuadra marco	8
30 91 40 25	Esquadro aro móvel • Escuadra hoja	8
30 91 40 35	rolamento simples • Rodamiento simples	4
30 91 40 42	Fecho lateral • Cierre lateral	2
30 91 40 50	Guia lateral • Guía lateral	4
30 91 41 00	Tampa móvel recta • Tope hoja recta	4
30 91 41 70	Corta-ventos inferior/superior • Cortavientos inferior/superior	1
30 92 01 02	Goteiras • Tapa salida de aguas	4
30 96 00 12	Jogo topos condensação • Juego topos condensación	1
30 96 00 23	Esquadro alinhamento • Escuadra alineamiento	16
30 91 41 10	Taco anti-levantamento • Taco antilevantamiento	2
30 92 04 70	Espuma isolante • Espuma aislante	L
----	Junta vidro • Junta vidrio	4L+8H
30 95 00 40*	Pelúcia 7x5.5 mm • Buriete 7x5.5 mm	4L+6H





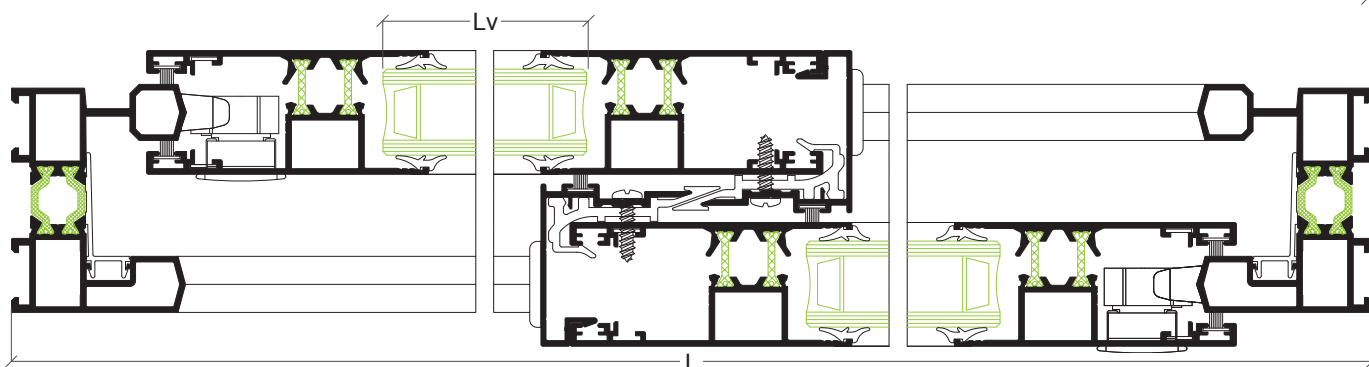





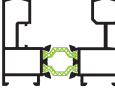



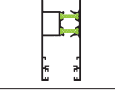

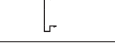
* junta alternativa ref.: 30 91 41 88 • junta alternativa ref.: 30 91 41 88

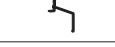
VIDRO • VIDRIO

Hv = H-229 mm	Lv = L/2-126 mm
---------------	-----------------

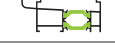

Janela 4 folhas correr com fecho lateral • Ventana 4 hojas corredera con cierre lateral
PERFIS • PERFIS

DESENHO • DESEÑO	REF.	DESCRIÇÃO • DESCRIPCIÓN	CORTE CORTE	QUANTIDADE CANTIDAD	MEDIDAS • MEDIDA
	CT-41	Aro fixo perimetral Marco perimetral		2	L
			2	H-28.5 mm	
	CT-23	Tampa aro fixo Tope marco perimetral		4	L-40 mm
			4	H-68 mm	
	CT-53	Aro móvel perimetral Hoja perimetral recta		8	L/4+16.5 mm
			8	H-101.5 mm	
	CT-54	Tampa cruzamento 2 folhas Tope recta cruze 2 hojas		4	H-101.5 mm
	CT-29	Pingadeira superior Vieriteaguas superior		1	L
	CT-08	Cruzamento móvel Cruce de hojas		4	H-101.5 mm
	CT-11	Soldeira de condensação Condensación		1	L
	CT-24	União 3/4 folhas Unión 3/4 hojas		1	L-171.5 mm

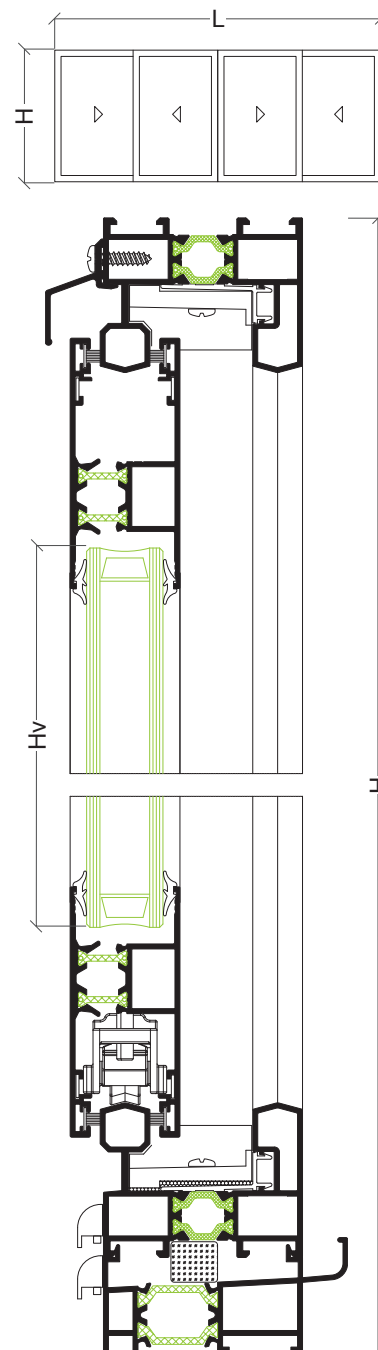

ACESSÓRIOS E JUNTAS • ACCESORIOS Y JUNTAS

REF.	DESCRIÇÃO • DESCRIPTION	QUANTIDADE CANTIDAD
30 91 41 74	Aro fixo perimetral • Escuadra marco	8
30 91 40 25	Esquadro aro móvel • Escuadra hoja	16
30 91 40 35	Rolamento simples • Rodamiento simples	8
30 91 40 42	Fecho lateral • Cierre lateral	3
30 91 40 50	Guia lateral • Guía lateral	6
30 91 41 70	Corta-ventos inferior/superior • Cortavientos inferior/superior	3
30 91 41 00	Tampa móvel recta • Tope hoja recta	8
30 92 01 02	Goteiras • Tapa salida de aguas	4
30 96 00 12	Jogo topos condensação • Juego topes condensación	1
30 96 00 23	Esquadro alinhamento • Escuadra alineamiento	32
30 91 41 10	Taco anti-levantamento • Taco antilevantamiento	3
30 92 04 70	Espuma isolante • Espuma aislante	L
----	Junta vidro • Junta vidrio	4L+16H
30 95 00 40*	Pelúcia 7x5.5 mm • Burlete 7x5.5 mm	4L+10H
30 91 41 89	Conjunto Topos CT-24 Preto • Conjunto T opos CT-24 Negro	1





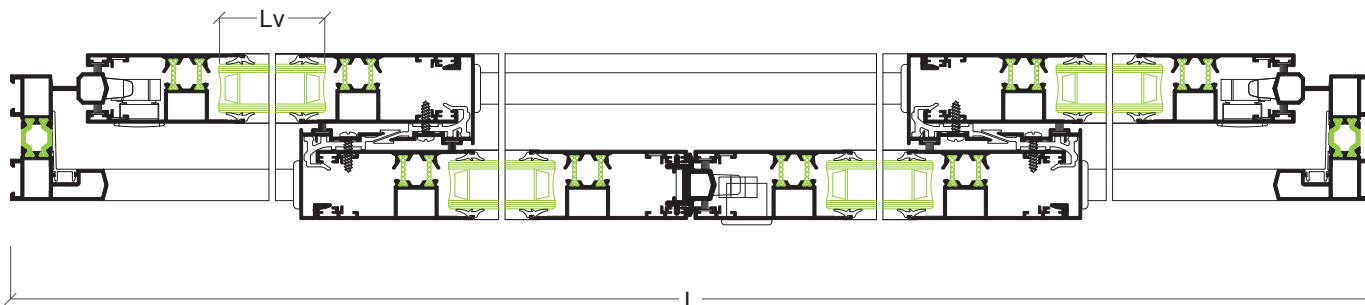





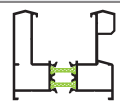

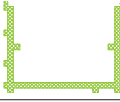





* junta alternativa ref.: 30 91 41 88 • junta alternativa ref.: 30 91 41 88

VIDRO • VIDRIO

Hv = H-229 mm	Lv = L/4-110 mm
---------------	-----------------



Porta 2 folhas correr multiponto • Puerta 2 hojas corredera multipunto
PERFIS • PERFIS

DESENHO • DISEÑO	REF.	DESCRIÇÃO • DESCRIPCIÓN	CORTE CORTE	QUANTIDADE CANTIDAD	MEDIDAS • MEDIDA
	CT-01	Aro fixo perimetral Marco perimetral		2	L
				2	H
	CT-09	Tampa aro fixo Tope marco		2	L-45 mm
				2	H-45 mm
	CT-53	Aro móvel perimetral Hoja perimetral recta		4	L/2-7 mm
				4	H-87 mm
	CT-54	Tampa cruzamento 2 folhas Tope recta cruze 2 hojas		2	H-87 mm
	CT-07	Pingadeira superior Vierteaguas superior		1	L
	CT-08	União cruzamento 2 folhas Cruze de hojas		2	H-87 mm
	CT-28	Perfil de reforço Perfil de refuerzo		1	H-170 mm
	AX-19	Vareta (opcional) Pletina falleba (opcional)		1	H-170 mm

ACESSÓRIOS E JUNTAS • ACCESORIOS Y JUNTAS

REF.	DESCRIÇÃO • DESCRIPTION	QUANTIDADE CANTIDAD
30 91 40 15	Esquadro aro fixo • Escuadra marco	8
30 91 40 25	Esquadro aro móvel • Escuadra hoja	8
30 91 41 49	Rolamento duplo reforçado • Rodamiento doble reforzado	4
----	Ferragem multiponto (600 ou 1800 mm) • Herraje multipunto (600 ou 1800 mm)	2
30 91 41 47	Cremona multiponto • Cremona multipunto	2
30 91 41 20	Calço nº 1 para multiponto • Suplemento nº 1 para multipunto	8 u 16
30 91 41 71	Limitador de abertura • Limitador de apertura	1
30 91 40 50	Guia lateral • Guía lateral	4
30 91 40 70	Corta ventos inferior/superior • Cortavientos inferior/superior	2
30 91 41 00	Tampa móvel recta • Tope hoja recta	4
30 92 01 02	Goteiras • Tapa salida de aguas	2
30 96 00 23	Esquadro alinhamento • Escuadra alineamiento	16
30 91 41 66	Joço topos CT-28 • Juego topos CT-28	2
----	Junta vidro • Junta vidrio	4L+8H
30 95 00 40*	Pelúcia 7x 5.5 mm • Burlete 7x5.5 mm	4L+6H





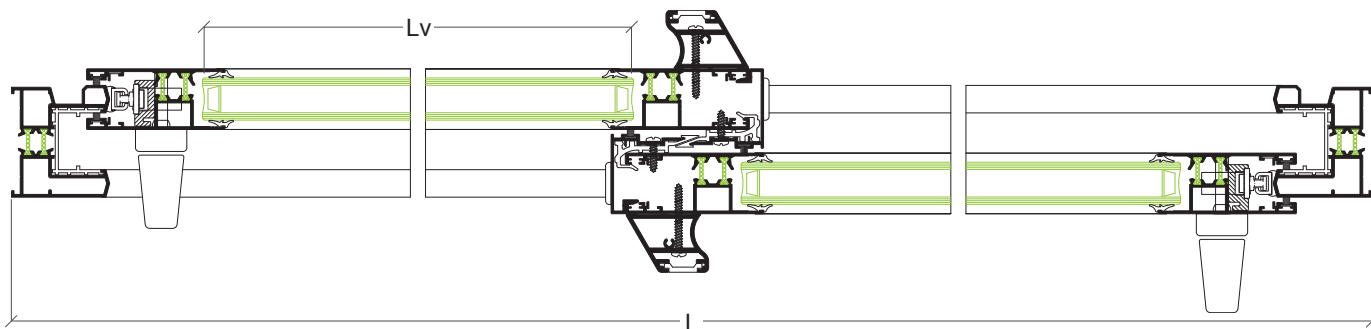
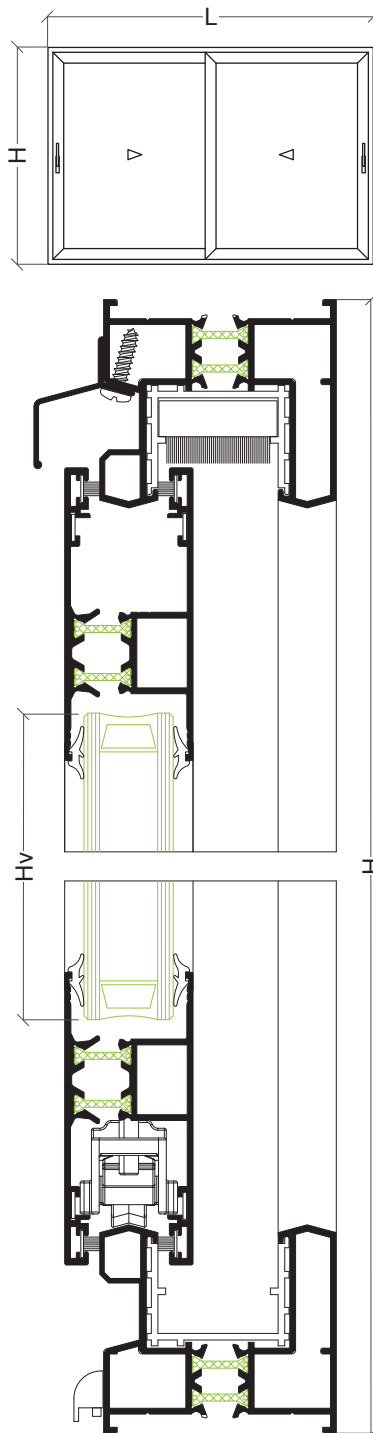

* junta alternativa ref.: 30 91 41 88 • junta alternativa ref.: 30 91 41 88

VIDRO • VIDRIO

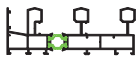
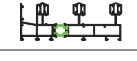
Hv = H-214 mm	Lv = L/2-134 mm
---------------	-----------------



Porta 3 folhas correr tri-rail multiponto • Puerta 3 hojas corredera tricarril multipunto
PERFIS • PERFIS

DESENHO • DISEÑO	REF.	DESCRIÇÃO • DESCRIPCIÓN	CORTE CORTE	QUANTIDADE CANTIDAD	MEDIDAS • MEDIDA
	CT-51	Aro fixo perimetral Marco tricarril con recogida		1	L
			2	H	
	CT-52	Aro fixo perimetral Marco tricarril balconera con recogida		1	L
	CT-23	Tampa aro fixo Tope marco perimetral		4	L-40 mm
				4	H-40 mm
	CT-53	Aro móvel perimetral Hoja perimetral recta		6	L/3+22.5 mm
				6	H-73 mm
	CT-54	Tampa cruzamento móvel Tope recta cruze 2 hojas		4	H-73 mm
	CT-29	Pingadeira superior Vierteaguas superior		1	L
	CT-08	Cruzamento móvel Cruce de hojas		4	H-73 mm
	CT-71	Guia carril (poliamida) Guía carril (poliamida)		3	L-93 mm

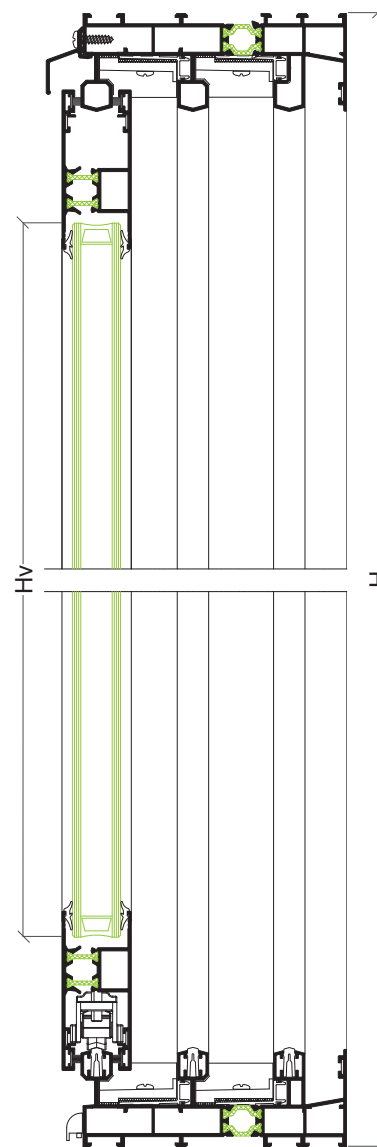
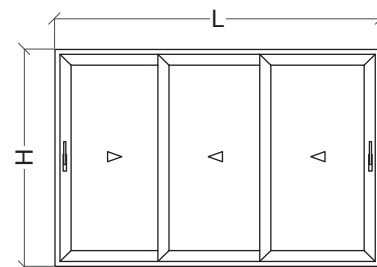

ACESSÓRIOS E JUNTAS • ACCESORIOS Y JUNTAS

REF.	DESCRIÇÃO • DESCRIPTION	QUANTIDADE CANTIDAD
30 91 41 74	Esquadro aro fixo • Escuadra marco	12
30 91 40 25	Esquadro aro móvel • Escuadra hoja	12
30 91 41 49	Rolamento duplo reforçado • Rodamiento doble reforzado	6
----	Ferragem multiponto (600 ou 1800 mm) • Herraje multipunto (600 ou 1800 mm)	2
30 91 41 47	Cremona multiponto • Cremona multipunto	2
30 91 41 20	Calço nº 1 para multiponto • Suplemento nº 1 para multipunto	8 ou 16
30 91 41 71	Limitador de abertura • Limitador de apertura	2
30 91 40 50	Guia lateral • Guía lateral	4
30 91 41 70	Corta-ventos inferior/superior • Cortavientos inferior/superior	2
30 91 41 00	Tampa guia recta • Tope guía recta	8
30 92 01 02	Goteiras • Tapa salida de aguas	4
30 96 00 23	Esquadro alinhamento • Escuadra alineamiento	24
----	Junta vidro • Junta vidrio	4L+12H
30 95 00 40*	Pelúcia 7x5.5 mm • Burlete 7x5.5 mm	4L+8H

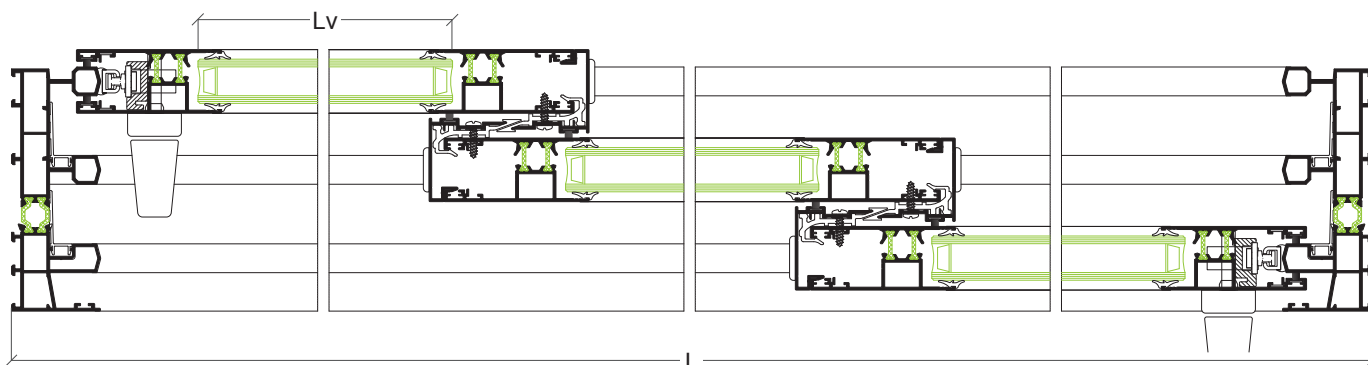

* junta alternativa ref.: 30 91 41 88 • junta alternativa ref.: 30 91 41 88

VIDRO • VIDRIO

Hv = H-200 mm	Lv = L/3-104 mm
---------------	-----------------

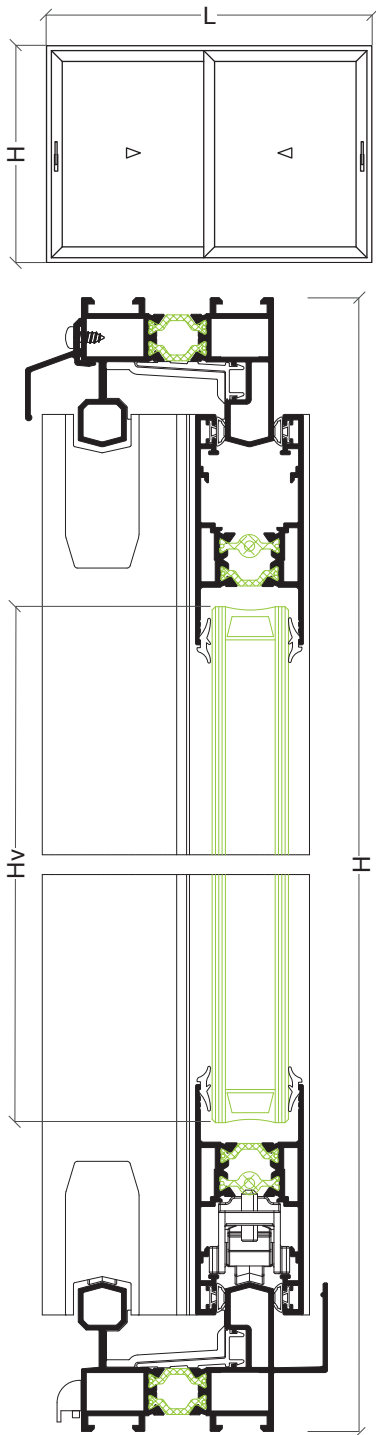

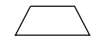
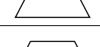
Janela 2 folhas correr com fecho lateral • Ventana 2 hojas corredera con cierre lateral

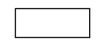
PERFIS • PERFIS

DESENHO • DISEÑO	REF.	DESCRIÇÃO • DESCRIPCIÓN	CORTE CORTE	QUANTIDADE CANTIDAD	MEDIDAS • MEDIDA
	CT-41	Aro fixo perimetral Marco perimetral		1	L
				2	H
	CT-43	Aro fixo perimetral condensação Marco perimetral recogida		1	L
	CT-23	Tampa aro fixo Tope marco perimetral		2	L-40 mm
				2	H-40 mm
	CT-34	Aro móvel carrinho Hoja de ruedas		4	L/2-93 mm
	CT-35	Aro móvel lateral Hoja lateral		2	H-74 mm
	CT-36	Aro móvel central Hoja central		2	H-74 mm
	CT-25	Cruzamento móvel Engatillado hoja central		2	H-74 mm
	CT-29	Pingadeira superior Verteaguas superior		1	L

ACESSÓRIOS E JUNTAS • ACCESORIOS Y JUNTAS

REF.	DESCRIÇÃO • DESCRIPTION	QUANTIDADE CANTIDAD
30 91 41 74	Esquadro aro fixo • Escuadra marco	8
30 91 40 35	Rolamento simples • Rodamiento simples	4
30 91 40 42	Fecho lateral • Cierre lateral	2
30 91 41 69	Jogo corta-ventos superior/inferior • Juego cortavientos superior/inferior	1
30 91 41 81	Kit topos janela • Kit topes ventana	2
30 92 01 02	Goteiras • Tapa salida de aguas	2
30 91 41 73	Jogo topos condensação • Juego topos condensación	1
30 91 41 10	Taco anti-levantamento • Taco antilevantamiento	2
30 91 41 88*	Junta de correr • Junta corredera	4L+6H

* pelúcia alternativa ref.: 30 95 00 40 • junta alternativa ref.: 30 95 00 40

VIDRO • VIDRIO

Hv = H-192 mm	Lv = L/2-103 mm
---------------	-----------------

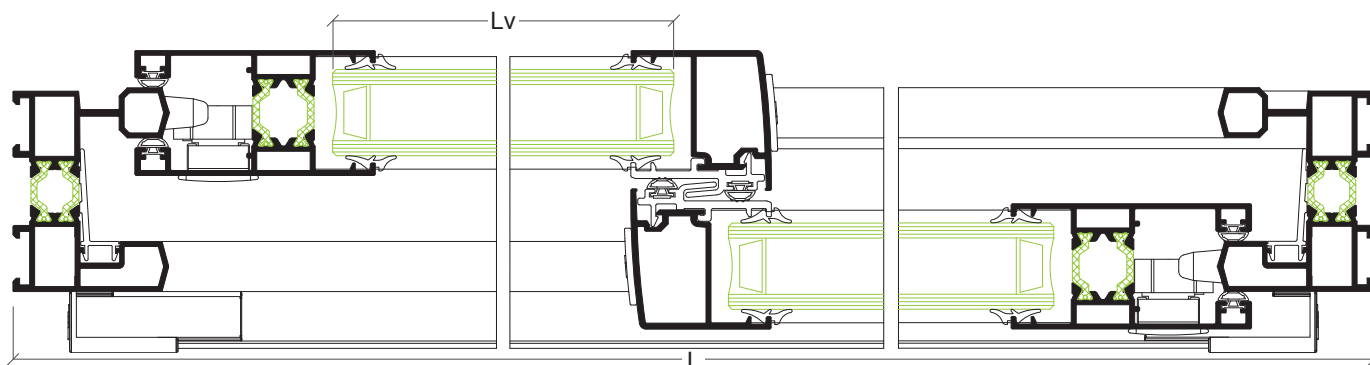

Porta 2 folhas correr multiponto • Puerta 2 hojas corredera multipunto

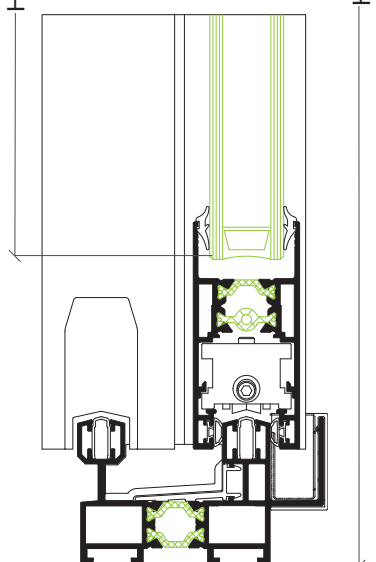
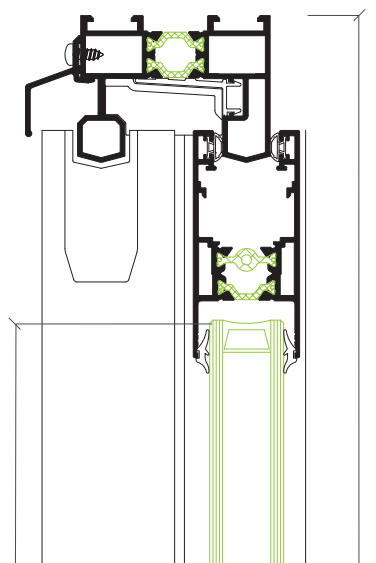
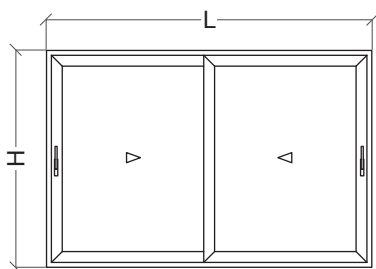

PERFIS • PERFIS

DESENHO • DISEÑO	REF.	DESCRIÇÃO • DESCRIPCIÓN	CORTE CORTE	QUANTIDADE CANTIDAD	MEDIDAS • MEDIDA
	CT-41	Aro fixo perimetral Marco perimetral		1	L
			2	H	
	CT-44	Aro fixo perimetral condensação Marco inferior con recogida		1	L
	CT-33	Guia carril Guía carril		2	L-93 mm
	CT-23	Tampa aro fixo Tope marco perimetral		2	L-40 mm
				2	H-40 mm
	CT-34	Aro móvel carrinho Hoja de ruedas		4	L/2-107 mm
	CT-35	Aro móvel lateral Hoja lateral		2	H-74 mm
	CT-37	Aro móvel central Hoja central		1	H-74 mm
	CT-39	Aro móvel central com reforço Hoja central con refuerzo		1	H-74 mm
	CT-26	Cruzamento móvel Engatillado hoja central		2	H-74 mm
	CT-29	Pingadeira superior Verteaguas superior		1	L

ACESSÓRIOS E JUNTAS • ACESORIOS Y JUNTAS

REF.	DESCRIÇÃO • DESCRIPTION	QUANTIDADE CANTIDAD
30 91 41 74	Esquadro aro fixo • Escuadra marco	8
30 91 41 49	Rolamento duplo reforçado • Rodamiento doble reforzado	4
----	Ferragem multiponto (600 ou 1800 mm) • Herraje multipunto (600 ou 1800 mm)	2
30 91 41 47	Cremona multiponto • Cremona multipunto	2
30 91 41 21	Calço nº 2 para multiponto • Suplemento nº 2 para multipunto	8 u 16
30 91 41 71	Limitador de abertura • Limitador de apertura	1
30 91 41 70	Jogo corta-ventos superior/inferior • Juego cortavientos superior/inferior	1
30 91 41 82	Kit topos porta • Kit topos puerta	2
30 92 01 00	Goteiras • Tapa salida de agua	2
30 91 41 73	Jogo topos condensação • Juego topos condensación	1
30 91 41 67	Jogo topo central • Juego tope central	1
30 91 41 88*	Junta de correr • Junta corredera	4L+6H

* pelúcia alternativa ref.: 30 95 00 40 • junta alternativa ref.: 30 95 00 40

VIDRO • VIDRIO

Hv = H-192 mm	Lv = L/2-119 mm
---------------	-----------------

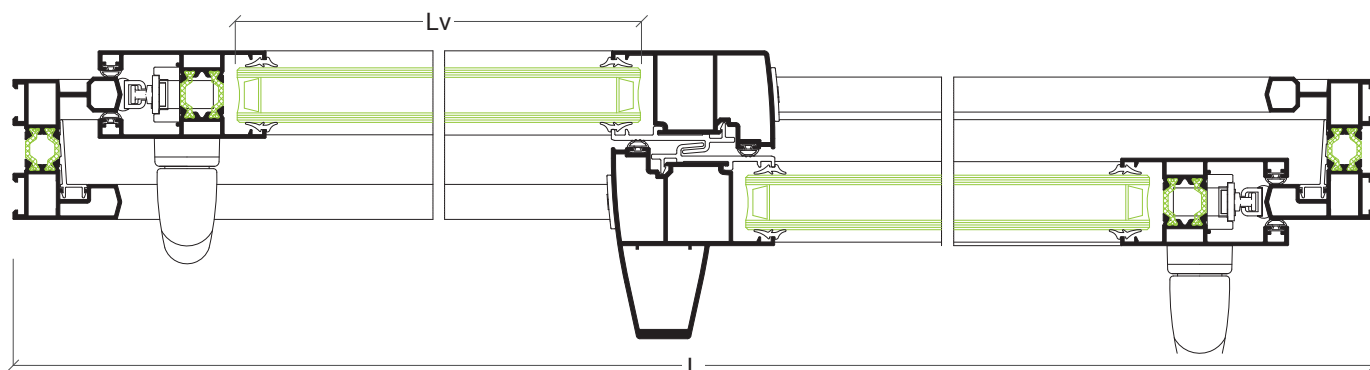

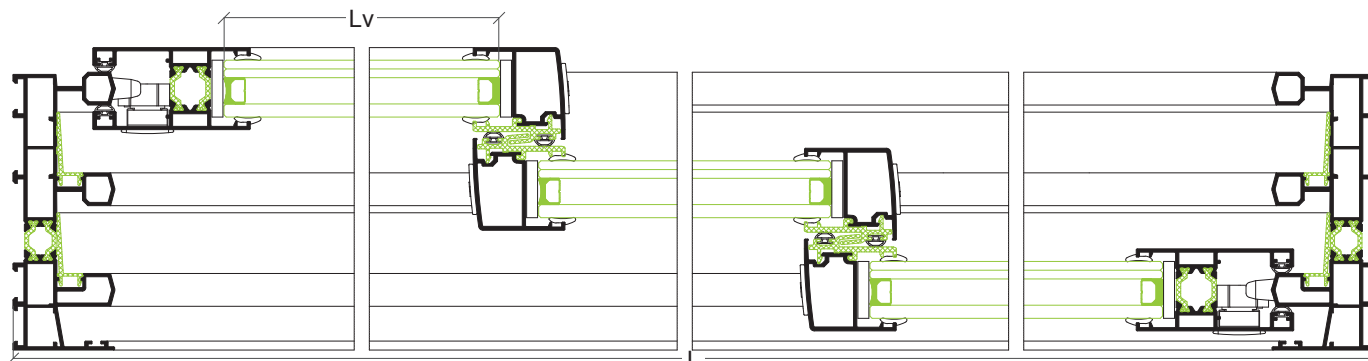
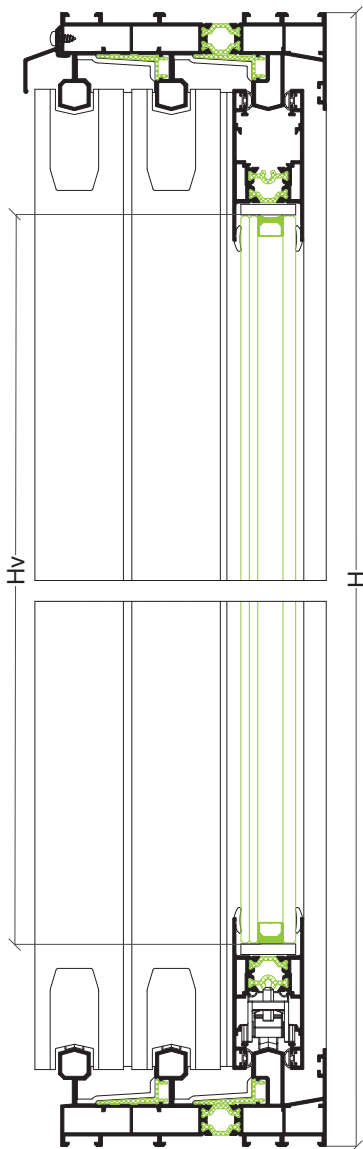
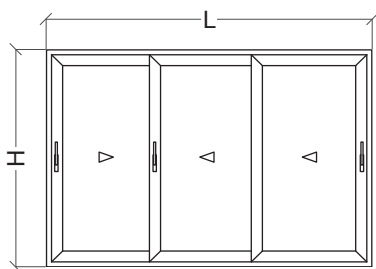
Porta 3 folhas correr tri-rail com fecho lateral • Puerta 3 hojas corredera tricarril con cierre lateral

PERFIS • PERFIS

DESENHO • DISEÑO	REF.	DESCRIÇÃO • DESCRIPCIÓN	CORTE CORTE	QUANTIDADE CANTIDAD	MEDIDAS • MEDIDA
	CT-51	Aro fixo perimetral Marco tricarril con recogida		2	L
			2	H	
	CT-23	Tampa aro fixo Tope marco perimetral		4	L-40 mm
				4	H-40 mm
	CT-34	Aro móvel carrinho Hoja de ruedas		6	L/3-64 mm
	CT-35	Aro móvel lateral Hoja lateral		2	H-74 mm
	CT-36	Aro móvel central Hoja central		4	H-74 mm
	CT-25	Cruzamento móvel Engatillado hoja central		4	H-74 mm
	CT-29	Pingadeira superior Vierteaguas superior		1	L

ACESSÓRIOS E JUNTAS • ACCESORIOS Y JUNTAS

REF.	DESCRIÇÃO • DESCRIPTION	QUANTIDADE CANTIDAD
30 91 41 74	Esquadro aro fixo • Escuadra marco	12
30 91 40 35	Rolamento simples • Rodamiento simples	6
30 91 40 42	Fecho lateral • Cierre lateral	2
30 91 41 69	Jogo cortaventos superior/inferior • Juego cortaventos superior/inferior	2
30 91 41 81	Kit topos janela folhas laterais • Kit topos ventana hojas laterales	2
30 91 41 83	Kit topos janela folhas centrais • Kit topos ventana hojas centrales	1
30 92 01 00	Goteiras • Tapa salida de agua	2
30 91 41 88 *	Junta de correr • Junta corredera	4L+8H

* pelúcia alternativa ref.: 30 95 00 40 • junta alternativa ref.: 30 95 00 40

VIDRO • VIDRIO

Hv = H-193 mm	Lv = L/3-74 mm
---------------	----------------

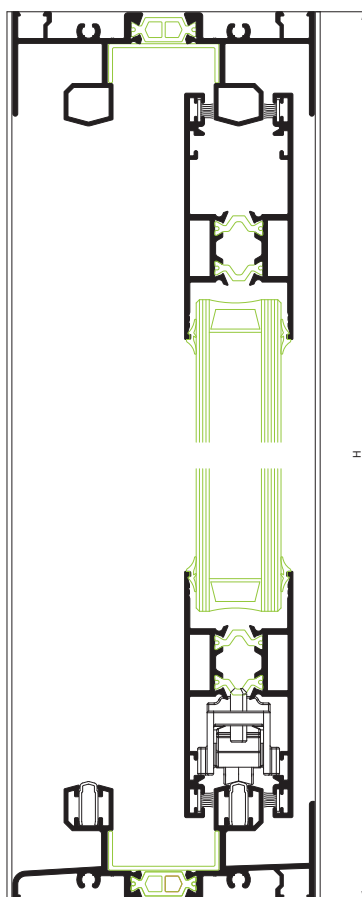
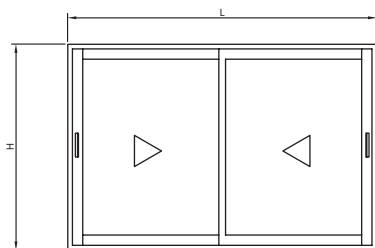
Porta 2 folhas correr multiponto • Puerta 2 hojas corredera multipunto

PERFIS • PERFIS

DESENHO • DISEÑO	REF.	DESCRIÇÃO • DESCRIPCIÓN	CORTE CORTE	QUANTIDADE CANTIDAD	MEDIDAS • MEDIDA
	CT-81	Padieira Marco perimetral		1	L-25 mm
	CT-82	Soleira Marco inferior con recogida		1	L-25 mm
	CT-83	Ombreira Guía carril		2	H
	CT-85	Tampa Tope marco perimetral		2	L-25 mm
	CT-33	Perfil Guia Hoja de ruedas		2	L-28 mm
	CT-100	Aro móvel carrinho Hoja lateral		4	(L/2)+18mm
	CT-54	Aro móvel lateral Hoja central		2	H-50 mm
	CT-08	Aro móvel central Hoja central con refuerzo		2	H-50 mm

ACESSÓRIOS E JUNTAS • ACESORIOS Y JUNTAS

REF.	DESCRIÇÃO • DESCRIPTION	QUANTIDADE CANTIDAD
30 91 42 11	Esquadro • Escuadra	16
30 96 00 23	Esquadro de alinhamento • Escuadro de alineamiento	16
30 91 40 70	Corta-Vento • Corta-Viento	2
30 91 41 00	Tampa móvel • Tope	4
30 91 40 50	Guia Lateral • Guia Lateral	4
30 91 40 36	Rolamento Duplo • Rodamiento Doble	4
30 91 41 30	Barra 2 pontos • Barra 2 puntos	2
30 92 07 96	Placas para pontos de fecho • Placas para punto de cierre	4
30 91 41 39	Calço nº6 • Calzo nº6	8
30 94 60 98	Fecho minimalista direito • Cierre minimalista derecho	1
30 94 61 00	Fecho minimalista esquerdo • Cierre minimalista izquierdo	1
30 91 41 71	Topo limitador de abertura • Tope limitador de apertura	1
30 91 41 93	Kit de estanquidade nº1 • Kit de estanqueidad	1
30 91 41 97	Goteira • Goteo	2
30 91 41 95	Junta ombreira • Junta ombrera	2H
30 91 41 87	Junta tapa-canal • Junta tapa-canal	2H
30 95 00 50	Pelucia • Burlete	4L+6H
---	Junta para vidro • Junta para vidrio	4L+8H

VIDRO • VIDRIO

Hv = H-177 mm	Lv = (L/2)-107 mm
---------------	-------------------

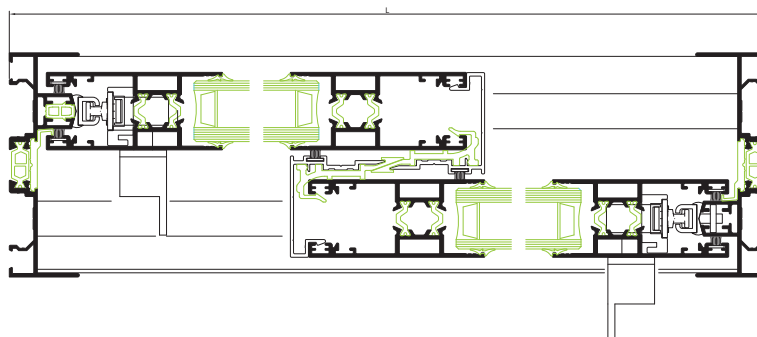

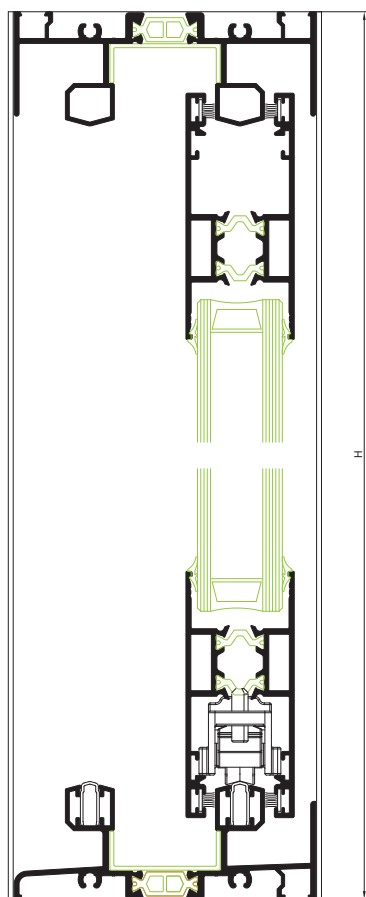
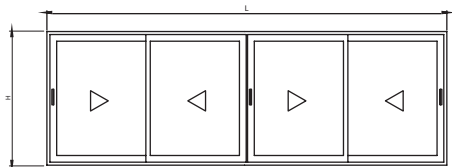
Porta 4 folhas correr multiponto • Puerta 3 hojas corredera multipunto

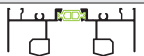
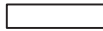
PERFIS • PERFIS

DESENHO • DISEÑO	REF.	DESCRIÇÃO • DESCRIPCIÓN	CORTE CORTE	QUANTIDADE CANTIDAD	MEDIDAS • MEDIDA
	CT-81	Padieira Marco perimetral		1	L-25 mm
	CT-82	Soleira Marco inferior con recogida		1	L-25 mm
	CT-83	Ombreira Guía carril		2	H
	CT-85	Tampa Tope marco perimetral		2	L-25 mm
	CT-33	Perfil Guia Hoja de ruedas		2	L-28 mm
	CT-100	Aro móvel carrinho Hoja lateral		8	(L/2)+26mm
				8	H-50 mm
	CT-54	Tampa cruzamento Tope		4	H-50 mm
	CT-08	União cruzamento Unión		4	H-50 mm
	CT-24	União de 4 folhas Unión 4 hojas		1	H-120 mm

ACESSÓRIOS E JUNTAS • ACESORIOS Y JUNTAS

REF.	DESCRIÇÃO • DESCRIPTION	QUANTIDADE CANTIDAD
30 91 42 11	Esquadro • Escuadra	32
30 96 00 23	Esquadro de alinhamento • Escuadro de alineamiento	32
30 91 40 70	Corta-Vento • Corta Viento	6
30 91 41 00	Tampa móvel • Tope	8
30 91 40 50	Guia Lateral • Guia Lateral	6
30 91 40 36	Rolamento Duplo • Rodamiento Doble	8
30 91 41 30	Barra 2 pontos • Barra 2 puntos	3
30 92 07 96	Placas para pontos de fecho • Placas para punto de cierre	6
30 91 41 24	Calço nº3 • Calzo nº3	4
30 91 41 39	Calço nº6 • Calzo nº6	8
30 94 60 98	Fecho minimalista direito • Cierre minimalista derecho	1
30 94 61 00	Fecho minimalista esquerdo • Cierre minimalista izquierdo	2
30 91 41 89	Conjunto topo para união 4 folhas • Conjunto top para unión 4 hojas	1
30 91 41 71	Topo limitador de abertura • Tope limitador de apertura	2
30 91 41 93	Kit de estanquidade nº1 • Kit de estanqueidad	1
30 91 41 97	Goteira • Goteo	4
30 91 41 95	Junta ombreira • Junta ombrera	2H
30 91 41 87	Junta tapa-canal • Junta tapa-canal	2H
30 95 00 50	Pelucia • Burlete	4L+10H
---	Junta para vidro • Junta para vidrio	4L+16H

VIDRO • VIDRIO

Hv = H-177 mm	Lv = (L/4)-101 mm
---------------	-------------------

