

Sistema

CP

Sistema CP

Sistema de correr - 45 mm

Características do sistema

Sistemas de alumínio para execução de vãos de correr.

Perfis de alumínio

Os perfis de alumínio são extrudidos na liga de alumínio 6060 para arquitetura de acordo com norma NP EN 12020-02.

Espessura média dos perfis de alumínio de 1.5 mm.

Aros fixos

Secção do aro fixo perimetral de 2 guias de 40, 45 ou 60 mm para montagem a meia esquadria;

Secção do aro fixo perimetral de 3 guias de 80 mm para montagem a meia esquadria.

Aros móveis

Secção dos aros móveis perimetrais de 26 ou 27.5 mm para montagem a meia esquadria;

Enchimento de 4 mm a 18 mm;

Aros móveis de linha recta ou curva;

Estanquidade assegurada através de pelúcia tipo Fin-Seal.

Dimensionamento e manobralidade

Peso máximo de 100 kg por folha (com 2 rolamentos duplos);

Possibilidades de abertura: 2, 3, 4 e 6 folhas, com folhas móveis e/ou fixas;

Sistema compatível com os sistemas de batente AZ e AX.

Performances

Sistema certificado por laboratório notificado do ensaio tipo inicial (ITT) de acordo com a norma de produto EN 14351-1 para efeitos de Marcação CE.

Categorias alcançadas na avaliação do sistema CP tipologia janela:

1. Permeabilidade ao ar: Classe 3 (norma de ensaio EN 1026)
2. Estanquidade à água: Classe 7A (norma de ensaio EN 1027)
3. Resistência ao vento: Classe C3 (norma de ensaio EN 12211)

Categorias alcançadas na avaliação do sistema CP tipologia porta:

1. Permeabilidade ao ar: Classe 4 (norma de ensaio EN 1026)
2. Estanquidade à água: Classe 7A (norma de ensaio EN 1027)
3. Resistência ao vento: Classe C1 (norma de ensaio EN 12211)

Coefficiente de transmissão térmica de vão de 2 folhas com 1.20 m x 2.20 m com vidro $U_g = 1.8 \text{ W/m}^2\text{K}$:

• $U_w = 3.34 \text{ W/m}^2\text{K}$

Coefficiente de atenuação acústica de vão de 2 folhas com vidro 4/10/4:

• $R_w (C; C_{tr}) = 28 \text{ dB} (-1; -1)$

Zonas de aplicação segundo RCCTE (em função do valor U_g): I1, I2, I3, V1, V2, V3;

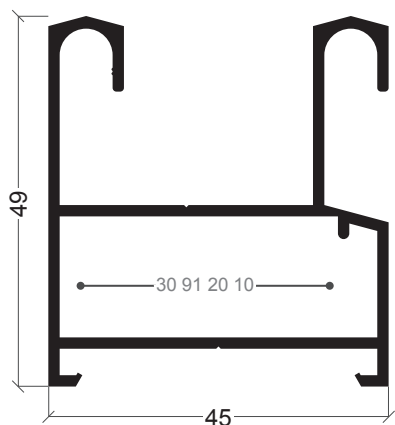

CP-01
Aro fixo

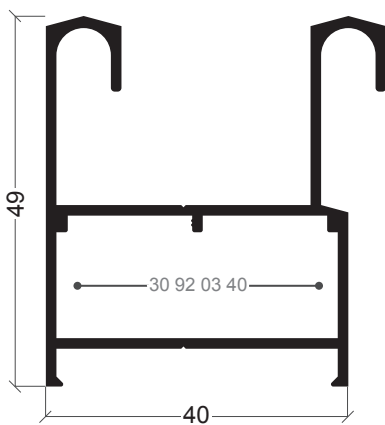

CP-17
Aro fixo

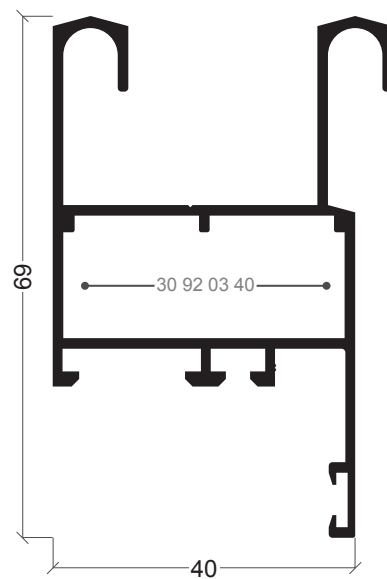

CP-18
Aro fixo

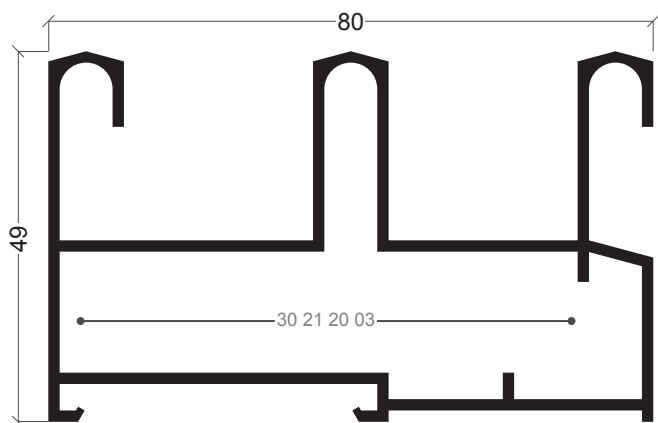

CP-05
Aro fixo

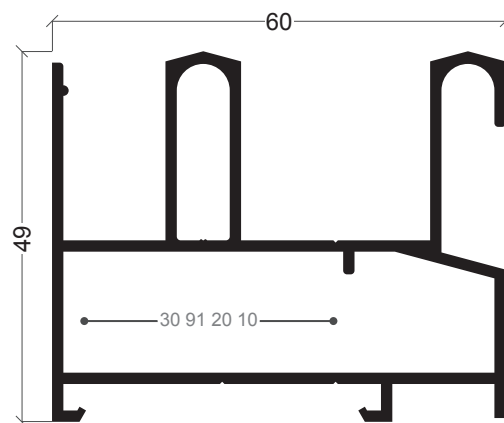

CP-10
Aro fixo

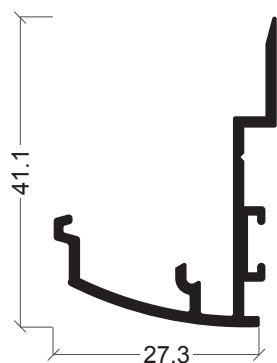

CP-12
Tampa cruzamento CP-11/20

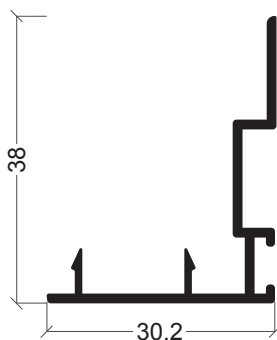

CP-15
Tampa cruzamento CP-13

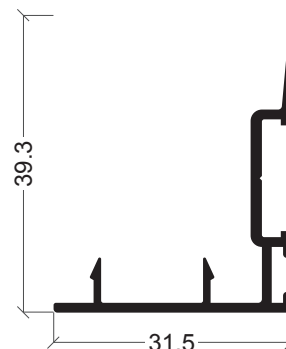

CP-03
Tampa cruzamento CP-02/04/07

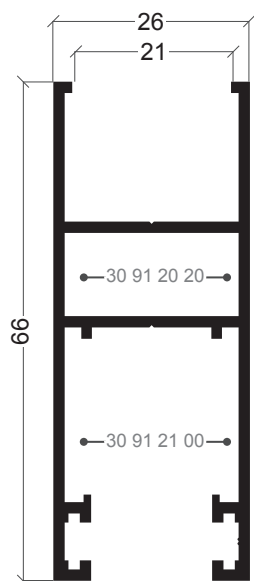

CP-02
Aro móvel

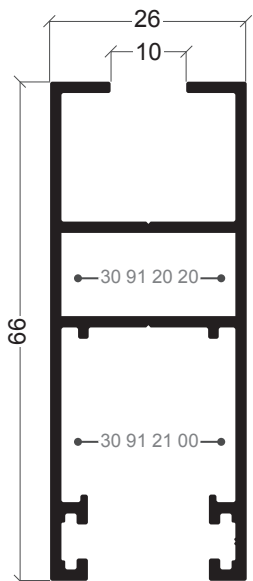

CP-04
Aro móvel

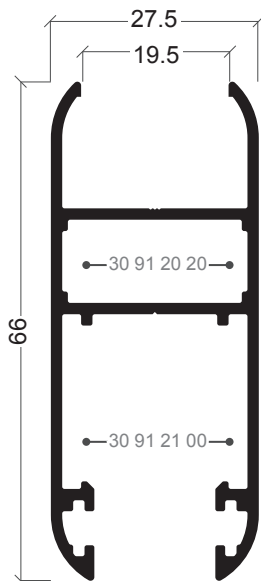

CP-11
Aro móvel

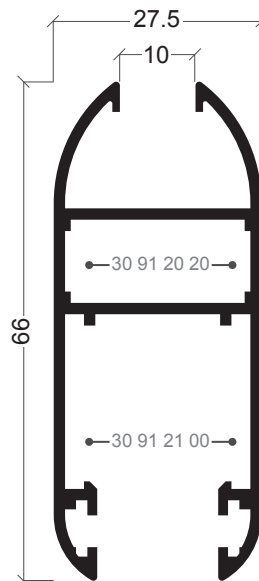

CP-20
Aro móvel

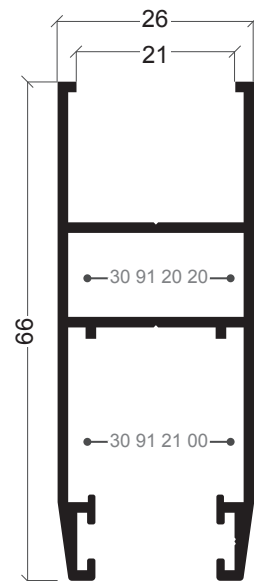

CP-13
Aro móvel

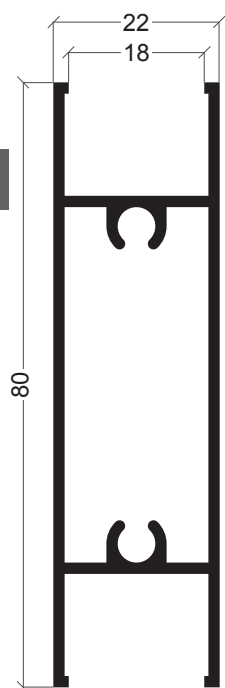

CP-08
Travessa

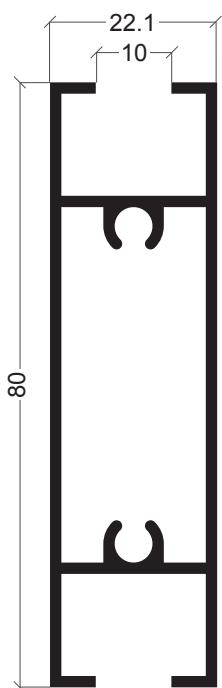

CP-09
Travessa

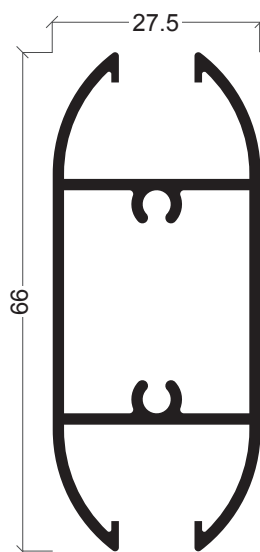

CP-22
Travessa

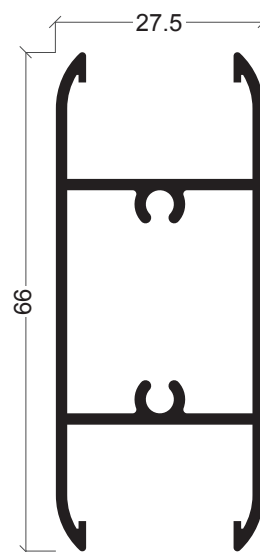

CP-23
Travessa

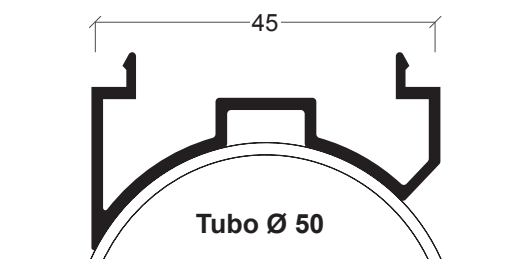

CP-16
Comp. p/ ângulo

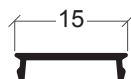

KL-04
Tampa

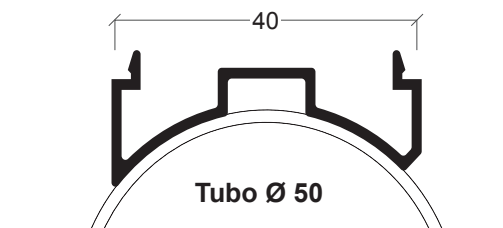

CP-19
Comp. p/ ângulo

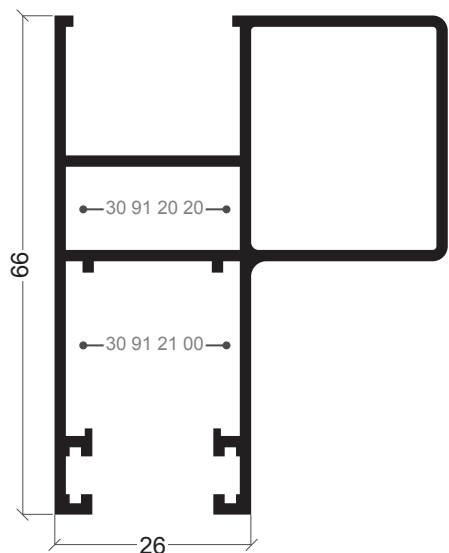

CP-07
Aro móvel com reforço

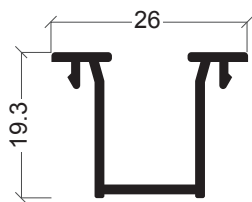

CP-14
Redutor vidro simples



AX-19
Vareta

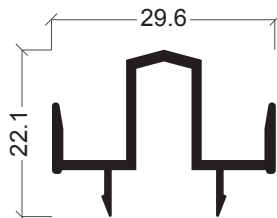

CP-06
União 3/4 F

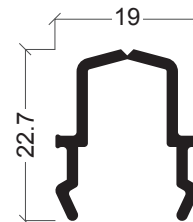

CP-21
União 3/4 F

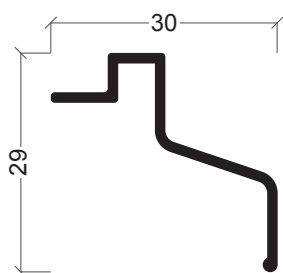

AXi-45
Pingadeira superior

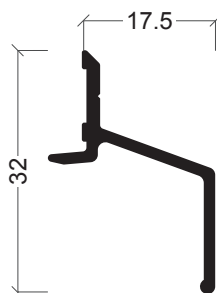

CT-29
Pingadeira superior

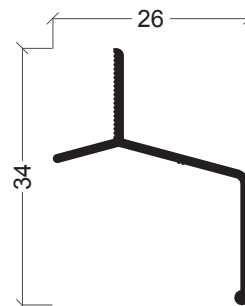

CT-07
Pingadeira superior

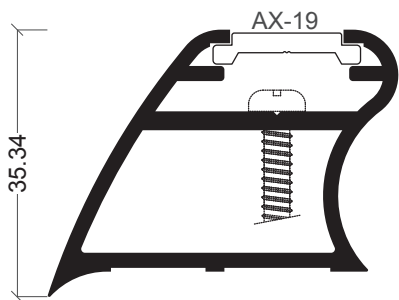

CT-03
Reforço

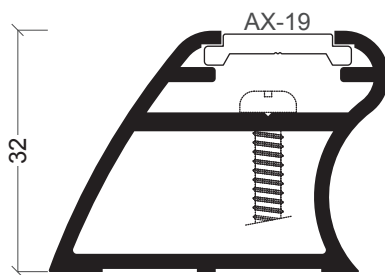

CT-27
Reforço

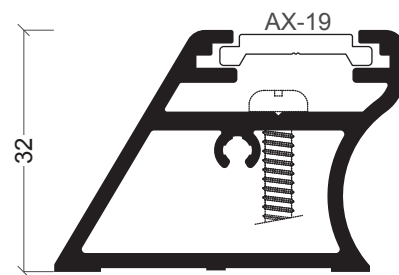

CT-28
Reforço

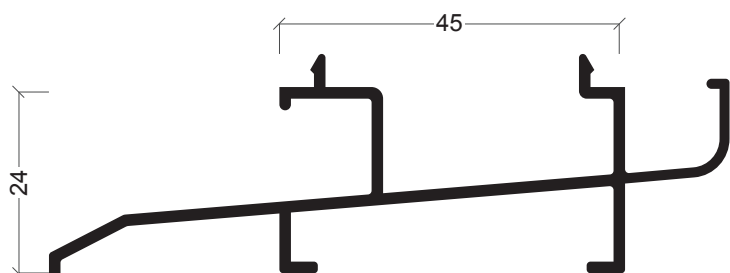

AX-17
Soleira condensação

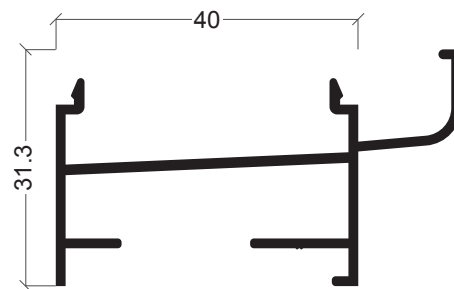

AZ-19
Soleira condensação

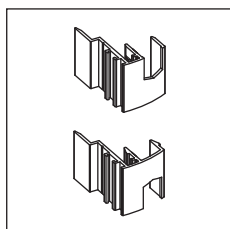

30 20 20 02

Jogo tampas centrais
CP-12

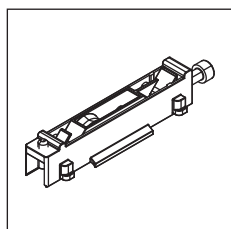

30 20 20 03

Rolamentos simples
(25 kg)

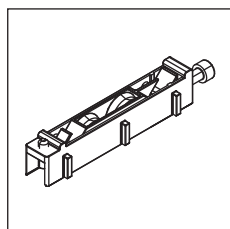

30 20 20 05

Rolamentos duplos
(25 kg)

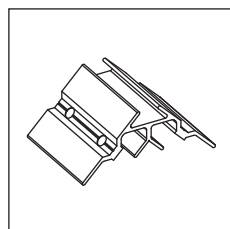

30 21 20 03

Esquadro CP-05

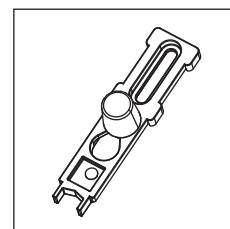

30 21 20 04

Guia lateral batente

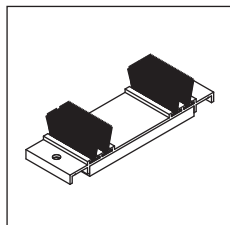

30 21 20 05

Corta-ventos CP-05/10

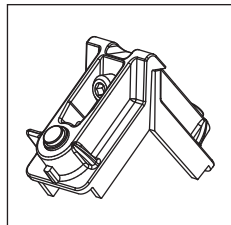

30 91 20 10

Esquadro CP-01/10

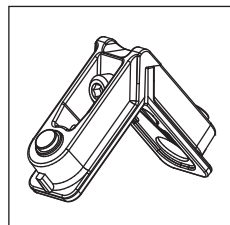

30 91 20 20

Esquadro aro móvel

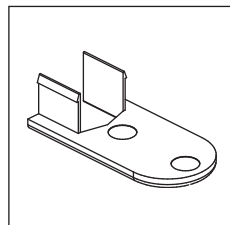

30 91 20 40

Tampa guia lateral

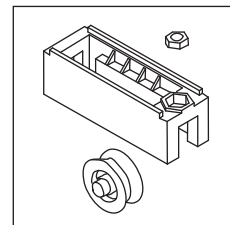

30 91 20 50

Rolamentos (20 kg)

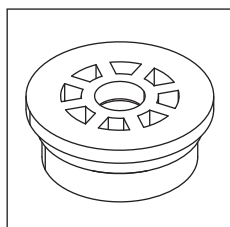

30 91 20 60

Canal

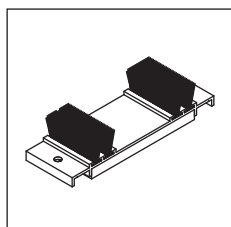

30 91 20 70

Corta-ventos
CP-01/05/17/18

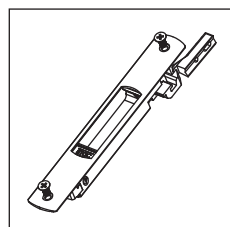

30 91 20 80/81

Fecho lateral branco/
preto

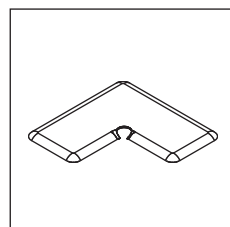

30 91 21 00

Esquadro alinhamento
móvel

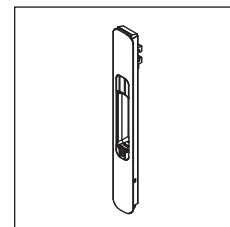

30 91 40 39/40/41

Fecho lateral manual
natural/branco/preto

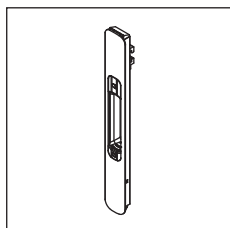

30 91 40 42/43

Fecho lateral automatico
branco/preto

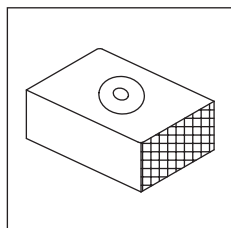

30 91 41 10

Taco anti-levantamento
preto

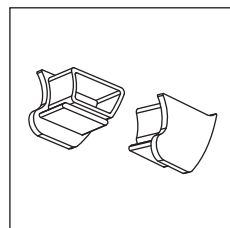

30 91 41 35

Jogo tampas CT-03

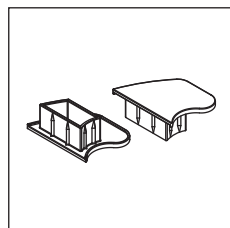

30 91 41 63/64

Jogo topos CT-27
branco/preto

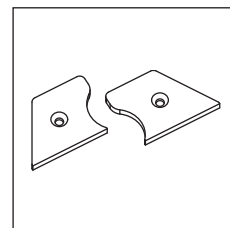

30 91 41 65/66

Jogo topos CT-28
branco/preto

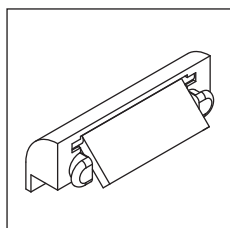

30 92 01 02/03

Goteiras branco/preto

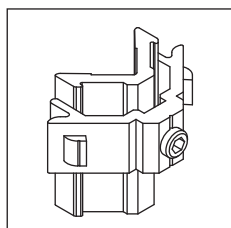

30 92 03 40

Esquadro janela
CP-17/18

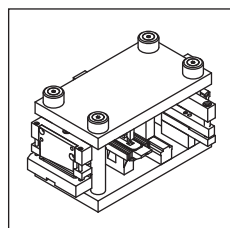

33 92 99 99

Cunho CP

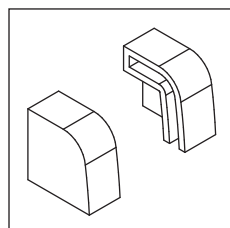

30 96 00 12

Jogo topos condensação

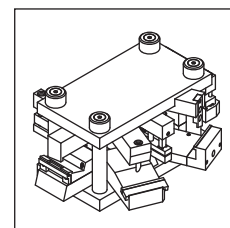

33 96 79 99







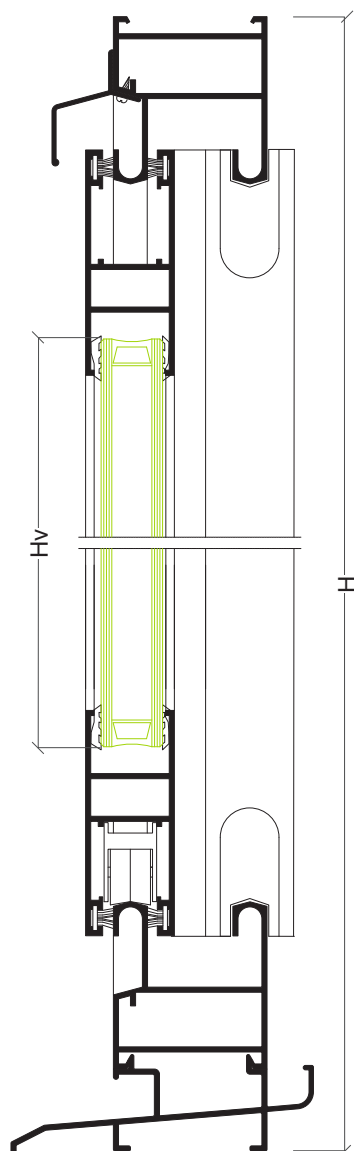
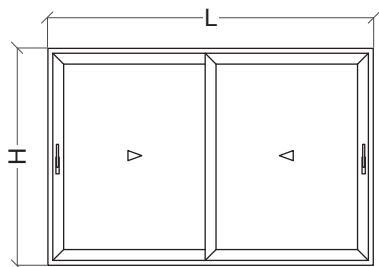







Cunho CE para
CP-17/18

Referência	Desenho	Descrição
30 93 00 65		Junta interior para vidro (5 mm)
30 93 00 66		Junta interior para vidro (4 mm)
30 93 00 67		Junta interior para vidro (2 mm)
30 93 00 68		Junta interior para vidro (6/7 mm)
30 93 00 69		Junta interior para vidro (8/9 mm)
30 95 00 30		Pelúcia 7x7 mm

Janela 2 folhas correr



Perfis

Desenho	Ref	Descrição	Corte	Quant	Medida
	CP-01	Aro fixo		2	L
				2	H-24 mm
	CP-02	Aro móvel		4	L/2-6 mm
				4	H-103 mm
	CP-03	Tampa de cruzamento CP-02		1	H-103 mm
	CT-07	Pingadeira		1	L
	AX-17	Soleira de condensação		1	L
	KL-04	Tampa		2	H-103 mm

Acessórios e Juntas

Referência	Descrição	Quantidade
30 21 20 04	Guia lateral batente	4
30 91 20 10	Esquadro CP-01	4
30 91 20 20	Esquadro aro móvel	8
30 91 20 40	Tampa guia lateral	4
30 91 20 50	Rolamentos	4
30 91 20 60	Canal	2
30 91 20 70	Corta ventos superior/inferior	2
30 91 20 80	Fecho lateral	2
30 91 21 00	Esquadros alinhamento	16
30 96 00 12	Jogo topos condensação	1
30 92 01 02	Goteira com válvula	2
30 91 41 10	Taco anti-levantamento	2
30 95 00 30	Pelúcia 7x7 mm	4L/6H
-----	Junta para vidro	4L/8H

387

Vidro

Hv = H-208 mm	Lv = L/2-111 mm
---------------	-----------------

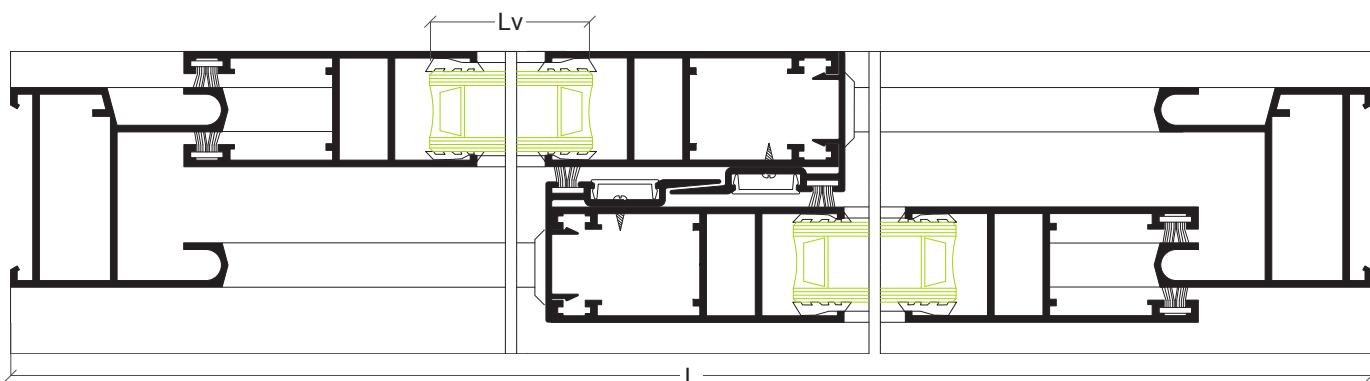

Janela 3 folhas correr tri-rail

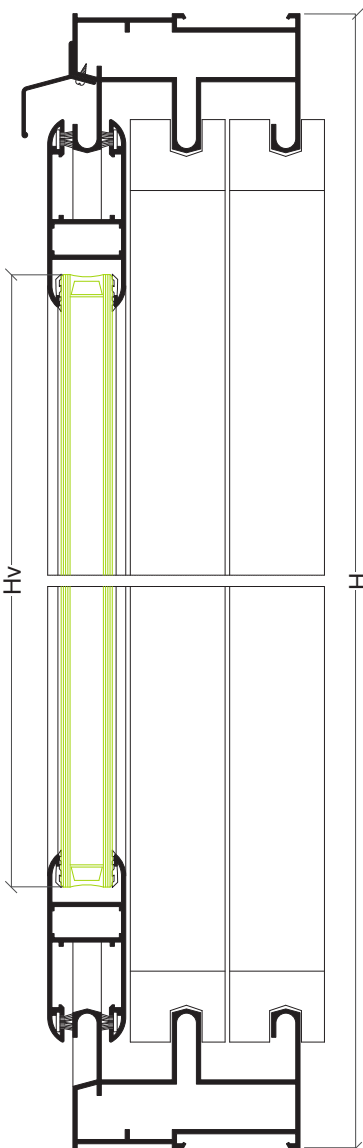
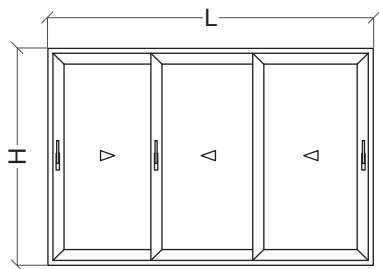

Perfis

Desenho	Ref	Descrição	Corte	Quant	Medida
	CP-05	Aro fixo		2	L
				2	H
	CP-11	Aro móvel		6	L/3+15 mm
				6	H-75 mm
	CP-12	Tampa de cruzamento CP-11		4	H-125 mm
	CT-07	Pingadeira		1	L

Acessórios e Juntas

Referência	Descrição	Quantidade
30 20 20 02	Jogo tampas centrais	4
30 21 20 03	Esquadro aro fixo	4
30 21 20 04	Guia lateral batente	4
30 21 20 05	Corta-ventos superior/inferior	2
30 91 20 20	Esquadro aro móvel	12
30 91 20 50	Rolamentos	6
30 91 20 60	Canal	4
30 91 20 70	Corta-ventos superior/inferior	2
30 91 20 80	Fecho lateral	2
30 91 21 00	Esquadros alinhamento	24
30 92 01 02	Goteira com válvula	3
30 91 41 10	Taco anti-levantamento	2
30 95 00 30	Pelúcia 7x7 mm	4L/6H
----	Junta para vidro	4L/12H

Vidro

Hv = H-184 mm	Lv = L/3-94 mm
---------------	----------------

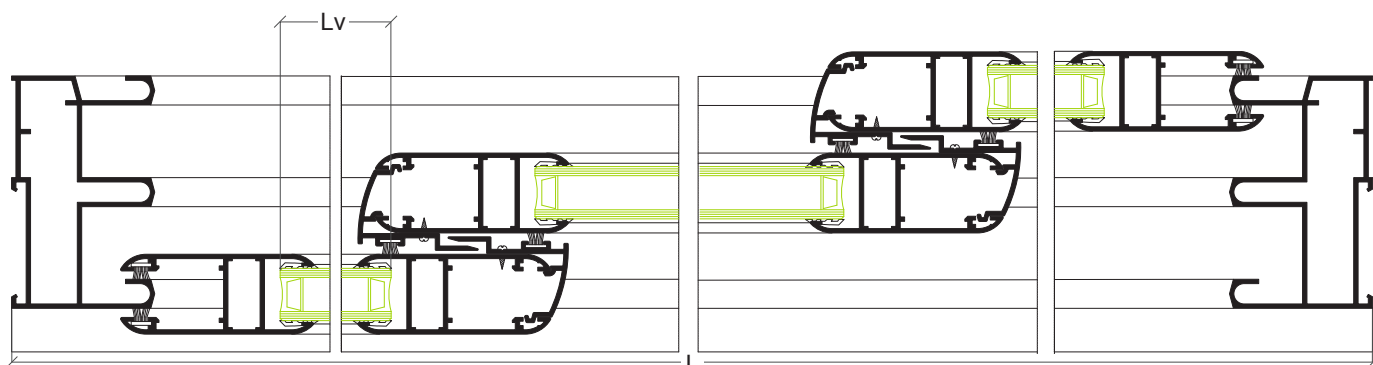

Janela 4 folhas correr

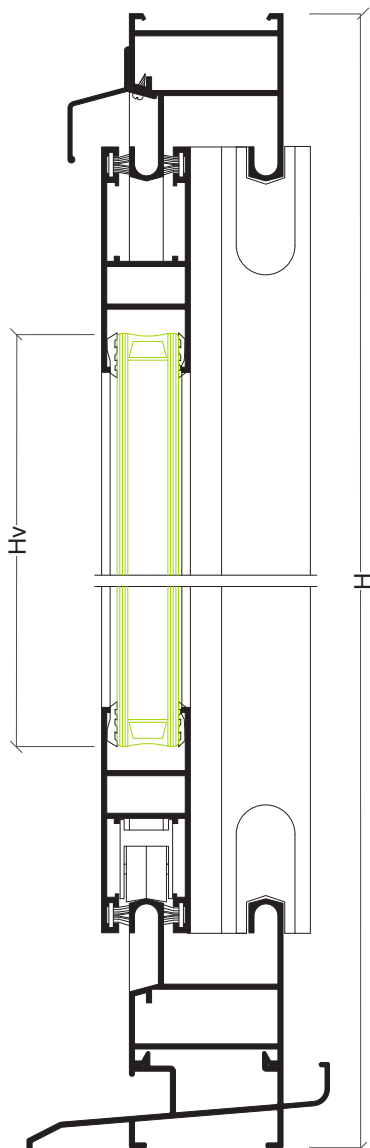
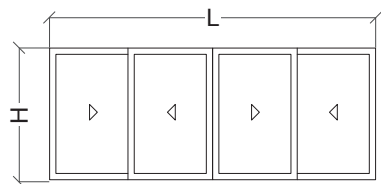

Perfis

Desenho	Ref	Descrição	Corte	Quant	Medida
	CP-01	Aro fixo		2	L
				2	H-24 mm
	CP-02	Aro móvel		8	L/4+11.5 mm
				8	H-103 mm
	CP-03	Tampa de cruzamento CP-02		4	H-103 mm
	CT-07	Pingadeira		1	L
	CP-06	União 4 folhas		1	H-103 mm
	AX-17	Soleira de condensação		1	L
	KL-04	Tampa		4	H-103 mm

Acessórios e Juntas

Referência	Descrição	Quantidade
30 21 20 04	Guia lateral batente	6
30 91 20 10	Esquadro aro fixo	4
30 91 20 20	Esquadro aro móvel	16
30 91 20 40	Tampa lateral	8
30 91 20 50	Rolamentos	8
30 91 20 60	Canal	4
30 91 20 70	Corta ventos superior/inferior	6
30 91 20 80	Fecho lateral	3
30 91 21 00	Esquadro alinhamento	32
30 91 00 12	Jogo topos condensação	1
30 92 01 02	Goteira com válvula	4
30 91 41 10	Taco anti-levantamento	2
30 95 00 30	Pelúcia 7x7 mm	4L/10H
-----	Junta para vidro	4L/16H

389

Vidro



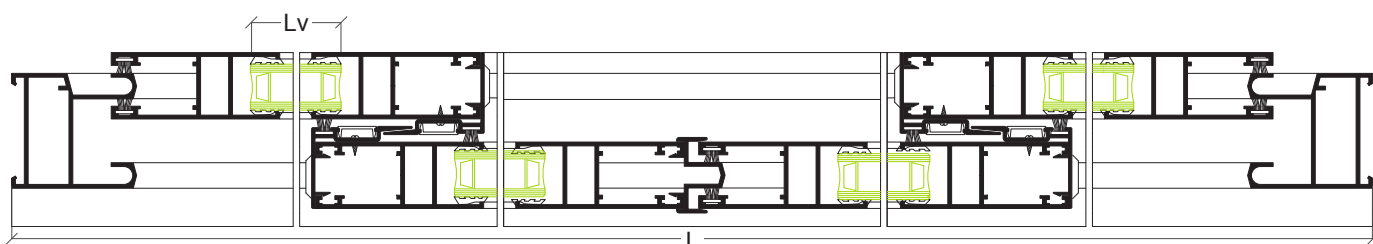



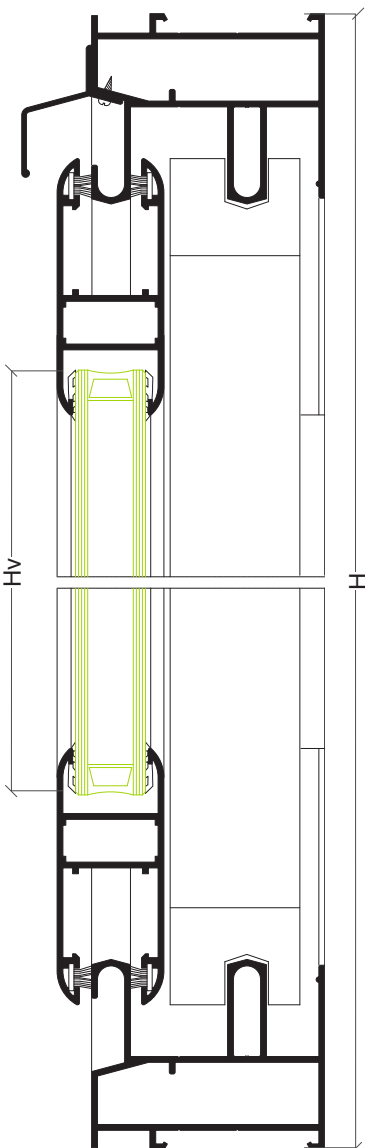
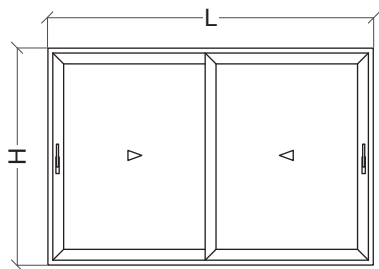







Hv = H-208 mm	Lv = L/4-94 mm
---------------	----------------



Porta 2 folhas correr



Perfis

Desenho	Ref	Descrição	Corte	Quant	Medida
	CP-10	Aro fixo		2	L
				2	H
	CP-11	Aro móvel		4	L/2-7 mm
				4	H-75 mm
	CP-12	Tampa de cruzamento CP-11		2	H-125 mm
	CT-07	Pingadeira		1	L
	AX-19	Vareta		2	H-206 mm
	CT-03	Reforço		2	H-206 mm

Acessórios e Juntas

Referência	Descrição	Quantidade
30 20 20 02	Jogo tampas centrais	2
30 20 20 04	Rolamentos duplos	4
30 21 20 04	Guia lateral batente	4
30 21 20 05	Corta-ventos superior/inferior	2
30 91 20 10	Esquadro aro fixo	4
30 91 20 20	Esquadro aro móvel	8
30 91 41 35	Jogo tampas CT-03	2
30 91 20 60	Canal	2
30 91 21 80	Fecho lateral	2
30 91 21 00	Esquadro alinhamento	16
30 92 01 02	Goteira com válvula	2
30 91 41 10	Taco anti-levantamento	2
30 95 00 30	Pelúcia 7x7 mm	4L/6H
-----	Junta para vidro	4L/16H

Vidro

Hv = H-184 mm	Lv = L/2-116 mm
---------------	-----------------

