

[www.anicolor.pt](http://www.anicolor.pt)

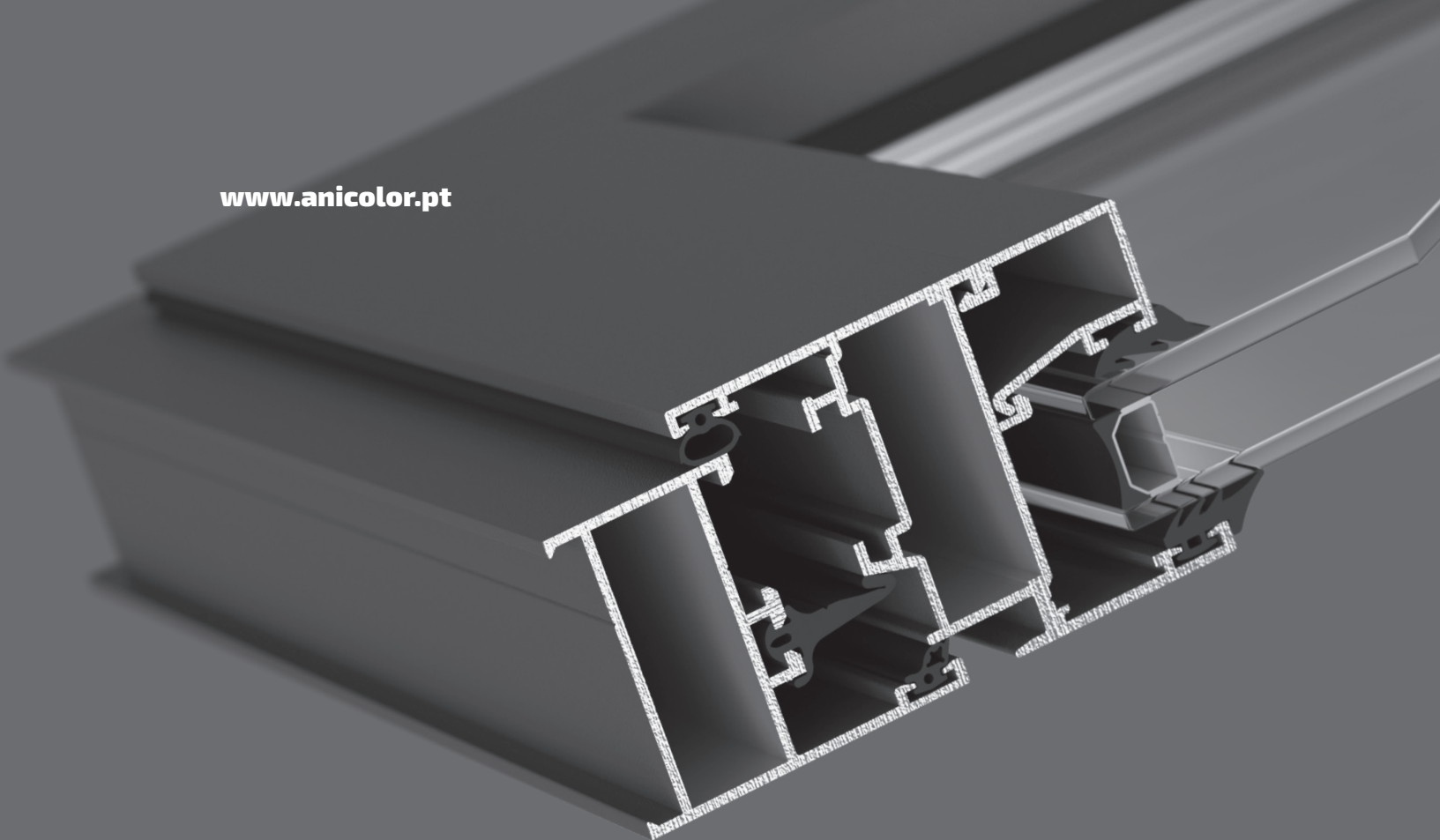

## SISTEMA DE BATENTE DE CÂMARA EUROPEIA - 40 MM

SISTEMA PRACTICABLE  
DE CANAL EUROPEO - 40 MM

**AZ**

## SISTEMA AZ

Sistema de batente de câmara europeia - 40 mm

### CARACTERÍSTICAS DO SISTEMA

Sistema de batente de câmara europeia e tripla vedação em EPDM (exterior, central, interior).

O sistema AZ possibilita a execução de 4 versões de caixilharia:

Linha recta, linha curva, linha tradição e linha oval.

### PERFIS DE ALUMÍNIO

Os perfis de alumínio são extrudidos na liga de alumínio 6060 para arquitectura de acordo com norma NP EN 12020-02.

Espessura média dos perfis de alumínio de 1,3 mm para janelas e 1,5 mm para portas.

### AROS FIXOS

Secção dos aros fixos de 40 mm ou 72 mm;

Aros fixos com esquadro para montagem a meia esquadria.

### AROS MÓVEIS

Secção dos aros móveis de 48 mm;

Enchimento para vidro simples ou duplo de 4 mm a 32 mm;

Aros móveis de linha recta, curva, tradição sem bite ou oval sem bite;

Aros móveis com esquadro para montagem a meia esquadria;

Perfil inversor de linha recta ou tradição.

### DIMENSIONAMENTO E MANOBRABILIDADE

Dimensões mínimas - máximas de folha: 375 mm - 1700 mm (L); 410 mm - 2700 mm (H);

Peso máximo de 110 kg por folha com oscilo-batente;

Peso máximo de 90 kg por folha para janelas de abrir;

Peso máximo de 150 kg por folha com dobradiça porta;

Possibilidades de abertura: batente interior (com ou sem oscilo-batente),

32 exterior, basculante, projectante, pivotante, harmónio e oscilo-paralela;

Estanquidade assegurada através de juntas triplas em EPDM.

### PERFORMANCES

Sistema certificado por laboratório credenciado, notificado para Ensaio Tipo Inicial (ITT) de acordo com a norma de produto EN 14351-1:2006+A1:2011 para efeitos de Marcação CE.

Categorias alcançadas na avaliação do sistema AZ tipologia janela:

1. Permeabilidade ao ar: Classe 4 (norma de ensaio EN 10207 e EN 1026)
2. Estanquidade à água: Classe 9A (norma de ensaio EN 12208 e EN 1027)
3. Resistência ao vento: Classe C5 (norma de ensaio EN EN 12210 e EN 12211)

Categorias alcançadas na avaliação do sistema AZ tipologia porta:

1. Permeabilidade ao ar: Classe 3 (norma de ensaio EN 10207 e EN 1026)
2. Estanquidade à água: Classe 8A (norma de ensaio EN 12208 e EN 1027)
3. Resistência ao vento: Classe C2 (norma de ensaio EN 12210 e EN 12211)
4. Resistência à torção estática: Apto 350N (norma de ensaio EN 14609)

Coefficiente de transmissão térmica de vão de 2 folhas com 1.20 m x 1.50 m com vidro  $U_g = 1.4 \text{ W/m}^2\text{K}$ :

•  $U_w = 2.92 \text{ W/m}^2\text{K}$

Coefficiente de atenuação acústica de vão de 2 folhas com vidro 4/12/4:

•  $R_w (C; C_{tr}) = 33 \text{ dB} (-1; -4)$

Zonas de aplicação segundo RCCTE (em função do valor  $U_g$ ): I1, I2, I3, V1, V2, V3;

## Sistema AZ

Sistema practicable de canal europeo - 40 mm

### CARACTERÍSTICAS DEL SISTEMA

Sistema practicable de canal europeo y tripla vedación en EPDM (exterior, central, interior).

El sistema AZ possibilita la ejecución de 4 versiones de carpintería:

Linea recta, linea curva, linea rústica e linea oval.

### PERFILES DE ALUMINIO

Los perfiles de aluminio son extrudidos en aleación de aluminio 6060 para arquitectura de acuerdo con la norma NP EN 12020-02.

Espesor medio de los perfiles de aluminio de 1,3 mm para ventanas y 1,5 mm para puertas.

### MARCOS

Profundidad de los marcos de 40 mm ou 72 mm;

Marcos con escuadras para montaje a englete.

### HOJAS

Profundidad de las hojas de 48 mm;

Acristalamiento para vidrio simples ó doble de 4 mm a 32 mm;

Hojas de linea recta, curva, tradicion sin junquillo o ovalizada sin junquillo;

Hojas con escuadra para montaje a englete;

Perfil inversor de linea recta u rústico.

### DIMENSIONAMIENTO Y MANIOBRABILIDAD

Dimensiones mínimas - máximas de hoja: 375 mm - 1700 mm (L); 410 mm - 2700 mm (H);

Peso máximo de 110 kg por hoja con oscilobatiente;

Peso máximo de 90 kg por hoja para ventanas practicables;

Peso máximo de 150 kg por hoja con bisagra de puerta;

Possibilidades de apertura: practicable interior (con u sin oscilobatiente),

exterior, abatible, proyectante, pivotante, plegable y oscilo-paralela;

Estanquidad assegurada mientras juntas triples de EPDM.

### ENSAYOS

Sistema certificado por laboratório credenciado, notificado para Ensayos Tipo Inicial (ITT) de acuerdo con la norma de producto EN 14351-1:2006+A1:2011 para efectos de Marcado CE.

Categorias alcanzadas en los ensayos del sistema AZ tipologia ventana:

1. Permeabilidad al aire: Clase 4 (norma de ensayo EN 10207 y EN 1026)
2. Estanquidad al agua: Clase 9A (norma de ensayo EN 12208 y EN 1027)
3. Resistencia al viento: Clase C5 (norma de ensayo EN 12210 y EN 12211)

Categorias alcanzadas en los ensayos del sistema AZ tipologia puerta:

1. Permeabilidad al aire: Clase 3 (norma de ensayo EN 10207 y EN 1026)
2. Estanquidad al agua: Clase 8A (norma de ensayo EN 12208 y EN 1027)
3. Resistencia al viento: Clase C2 (norma de ensayo EN 12210 y EN 12211)
4. Resistencia a la torsión estática: Apto 350N (norma de ensayo EN 14609)

Coefficiente de transmisión termica para hueco de 2 hojas con 1.20 m x 1.50 m con vidrio  $U_g = 1.4 \text{ W/m}^2\text{K}$ :

•  $U_w = 2.92 \text{ W/m}^2\text{K}$

Coefficiente de atenuación acustica para hueco de 2 hojas con vidrio 4/12/4:

•  $R_w (C; C_{tr}) = 33 \text{ dB} (-1; -4)$

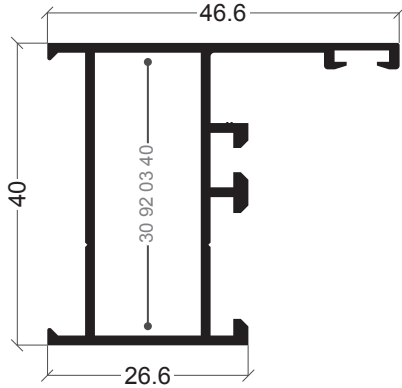

**AZ-03**  
Aro fixo  
Marco ventana

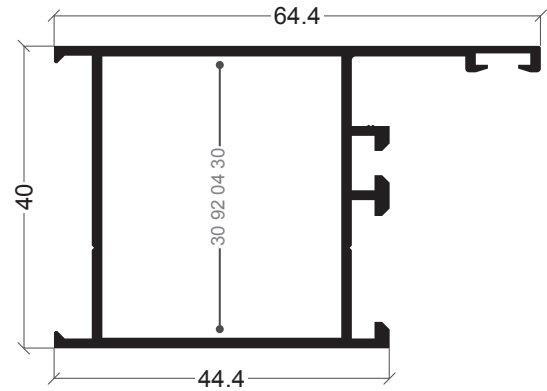

**AZ-11**  
Aro fixo  
Marco puerta

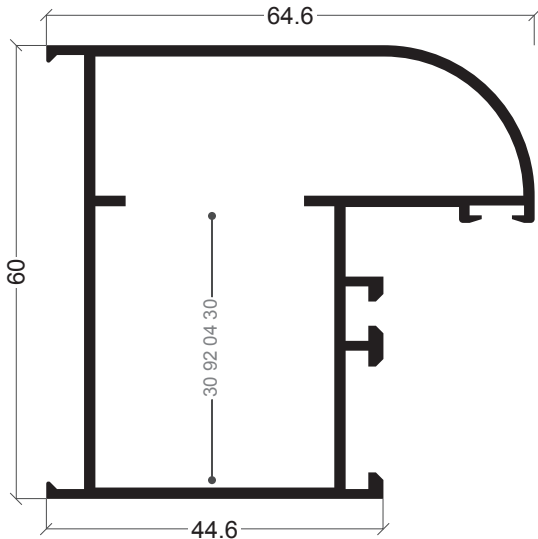

**AZ-48**  
Aro fixo  
Marco de escaparate

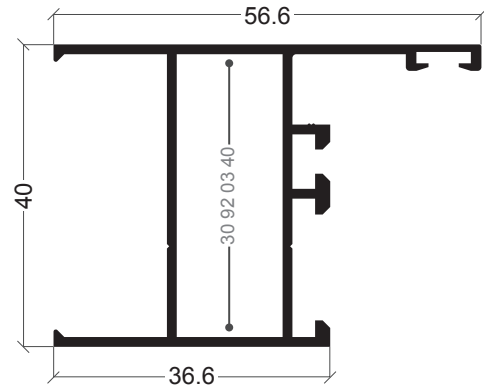

**AZ-33**  
Aro fixo  
Marco ventana y puerta

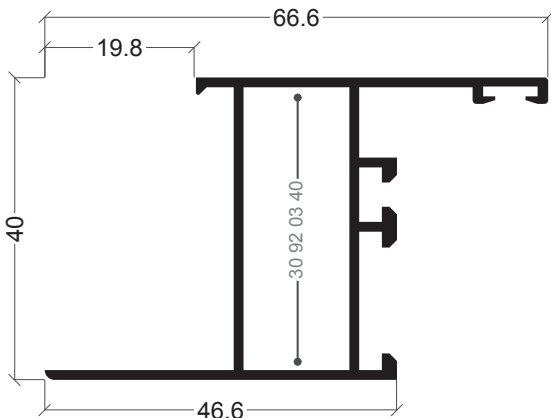

**AZ-21**  
Aro fixo com remate  
Marco con solape

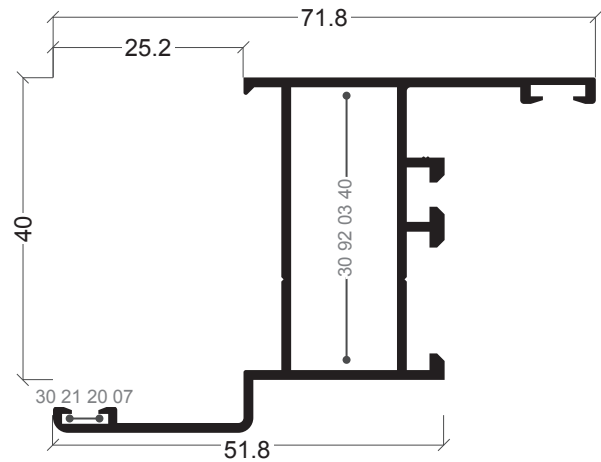

**AZ-02**  
Aro fixo com remate  
Marco con solape

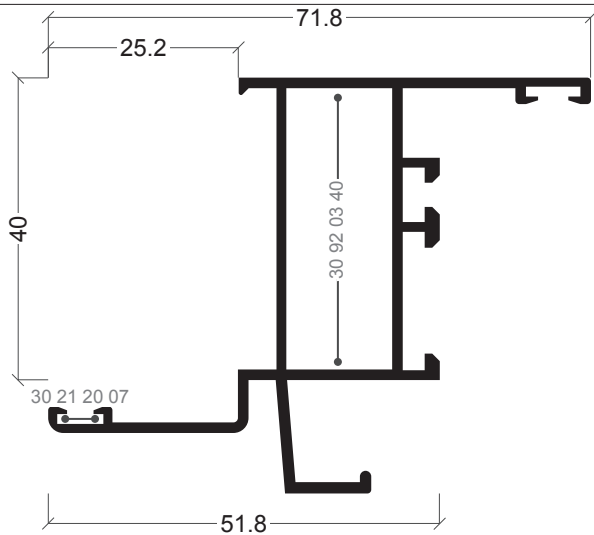

**AZ-34**

Aro fixo c/ remate e condensação  
Marco c/ solape y condensación

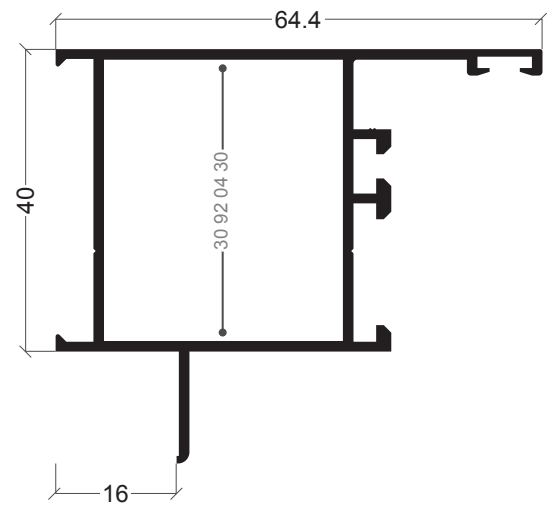

**AZ-46**

Aro fixo para apanelado  
Marco con precerco

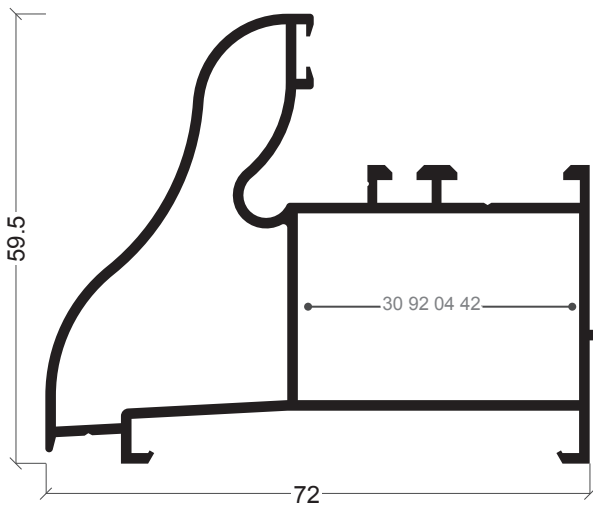

**AZ-51**

Aro fixo para apanelado  
Marco rustico ventana  
\* não permite aplicação de oscilo-batente

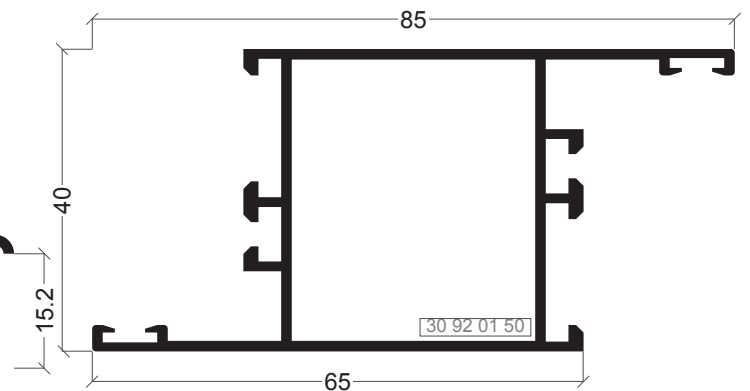

**AZ-13**

Aro fixo abertura exterior fixo lateral  
Marco ap. exterior con fijo lateral

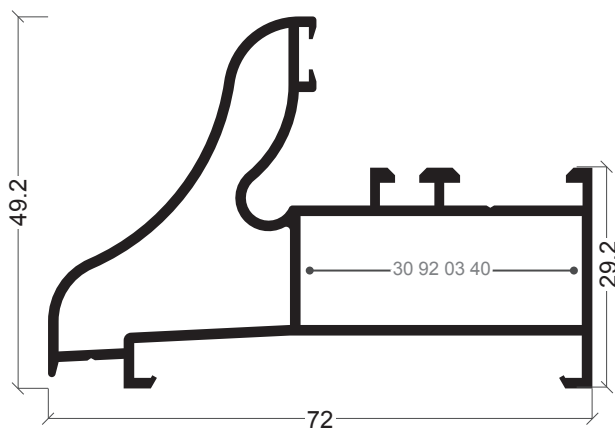

**AZ-39**

Aro fixo  
Marco rustico ventana

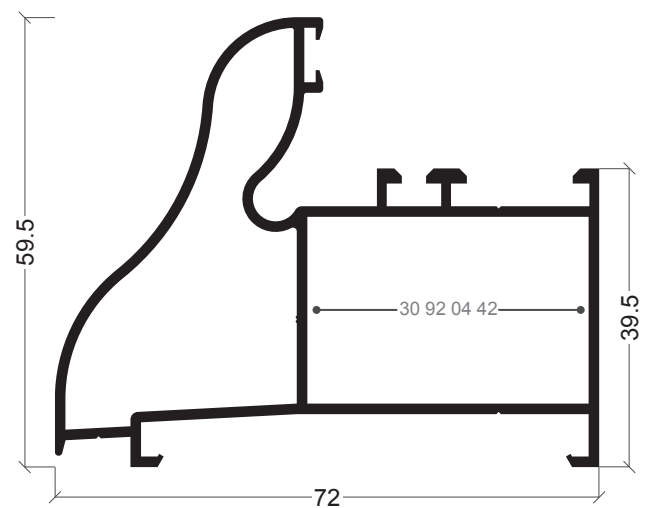

**AZ-40**

Aro fixo  
Marco rustico puerta

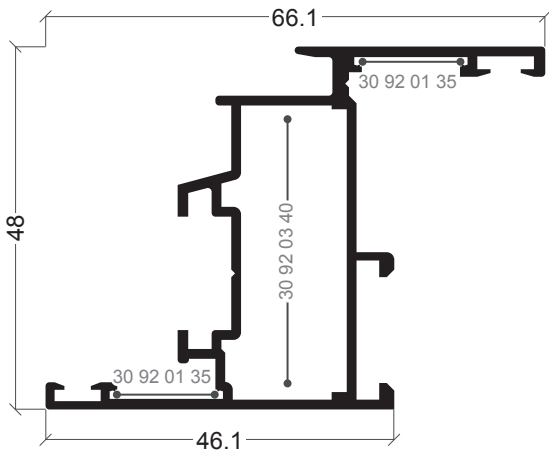

**AZ-67**

Aro móvel  
Hoja ventana

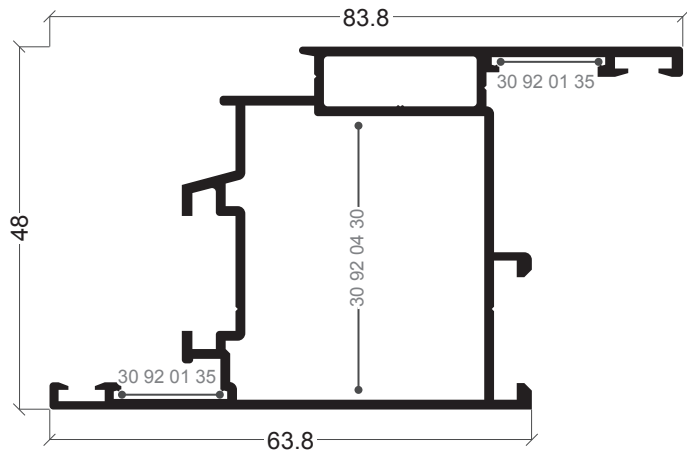

**AZ-62**

Aro móvel  
Hoja puerta

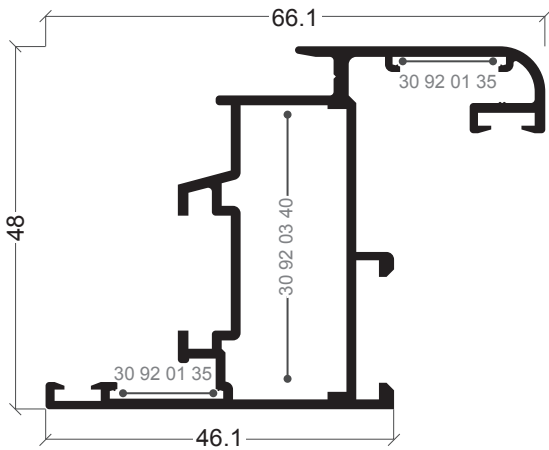

**AZ-05**

Aro móvel  
Hoja ventana

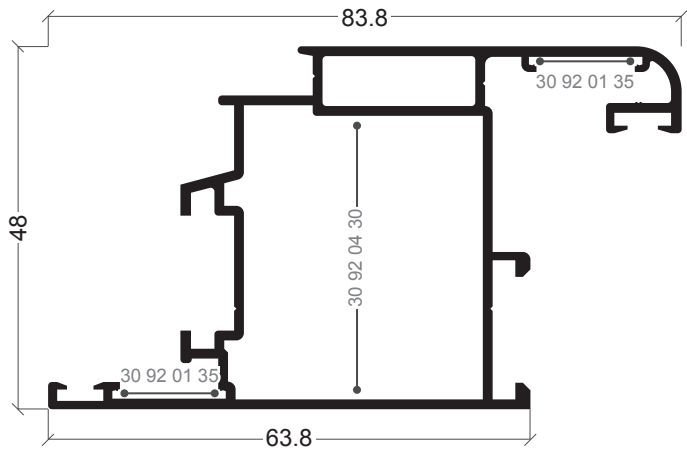

**AZ-10**

Aro móvel  
Hoja puerta

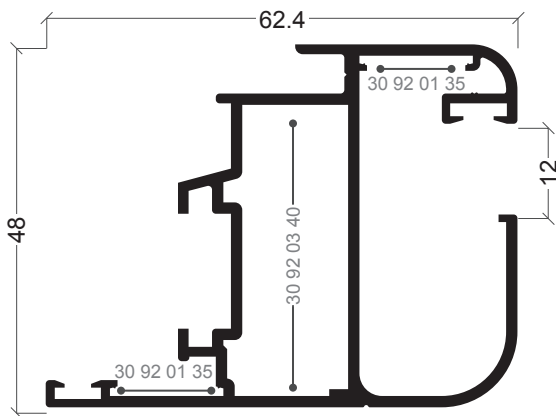

**AZ-50**

Aro móvel  
Hoja ventana sin junquillo

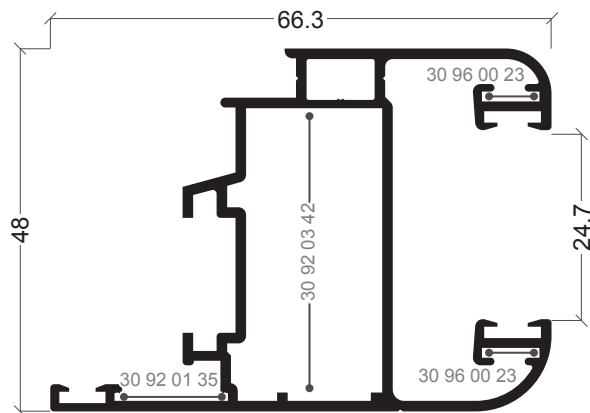

**AZ-32**

Aro móvel  
Hoja ventana sin junquillo

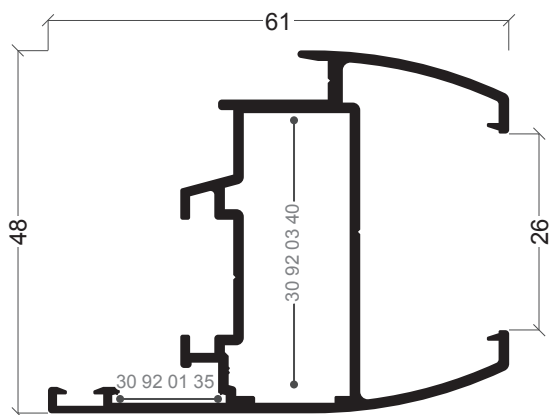

**AZ-71**  
Aro móvel  
Hoja ventana sin junquillo

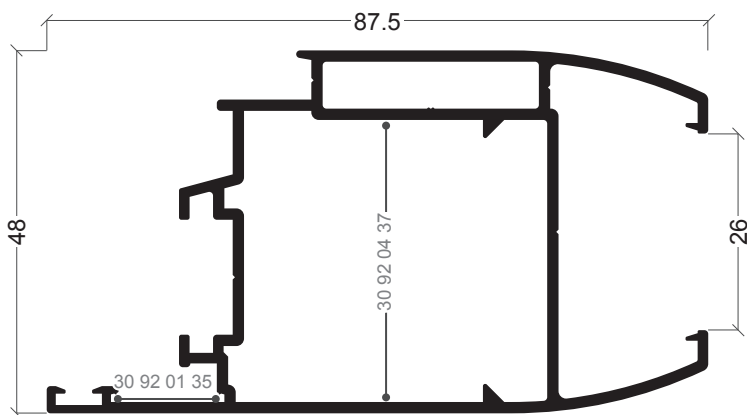

**AZ-72**  
Aro móvel  
Hoja puerta sin junquillo

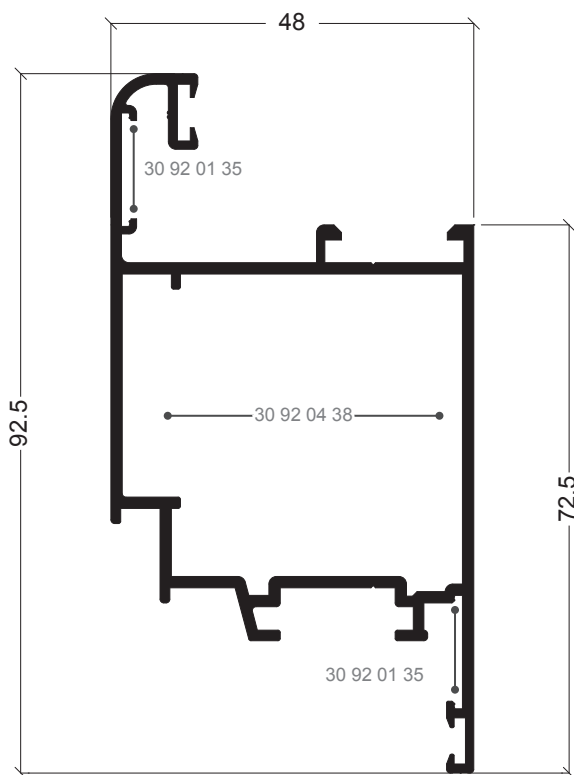

**AZ-81**  
Aro móvel  
Hoja

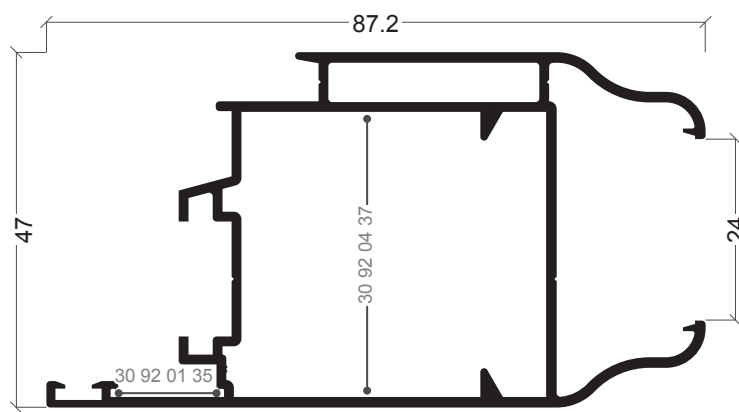

**AZ-53**  
Aro móvel  
Hoja puerta sin junquillo

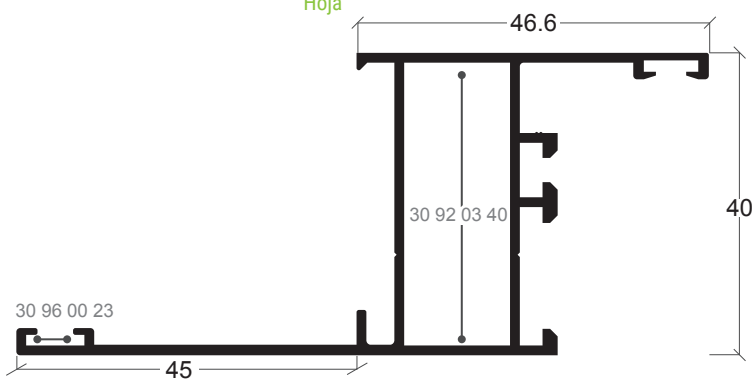

**AZ-82**  
Aro fixo com remate  
Marco con solape

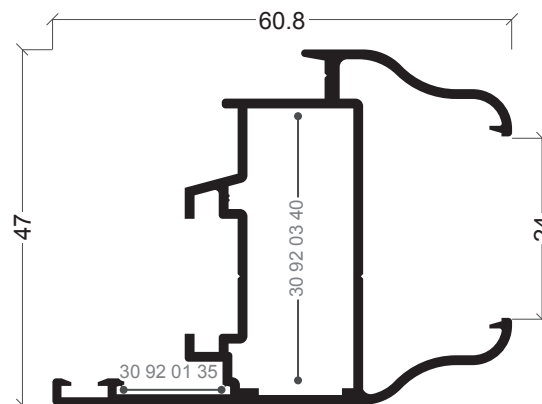

**AZ-52**  
Aro móvel  
Hoja ventana sin junquillo



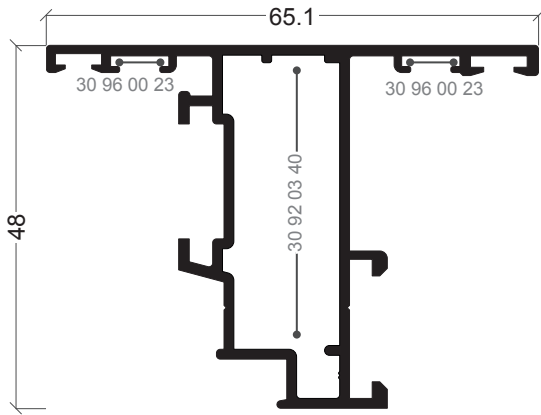

**AZ-68**

Aro móvel abertura exterior  
Hoja ventana apertura exterior

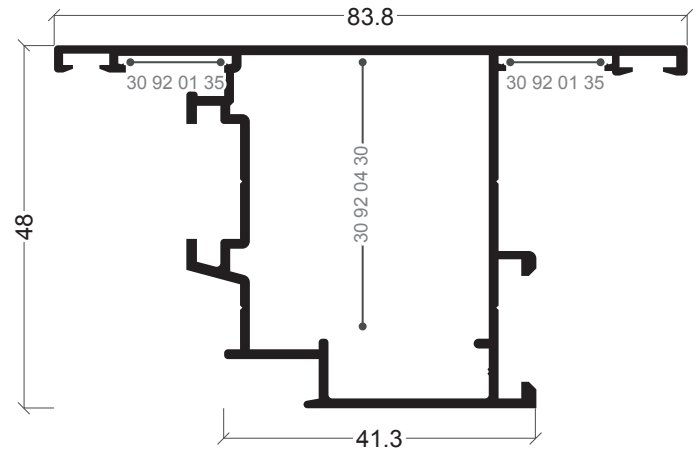

**AZ-63**

Aro móvel abertura exterior  
Hoja ventana apertura exterior

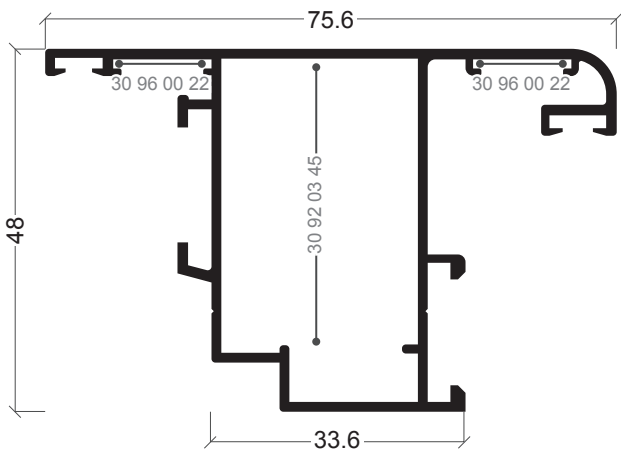

**AZ-15**

Aro móvel abertura exterior  
Hoja ventana apertura exterior

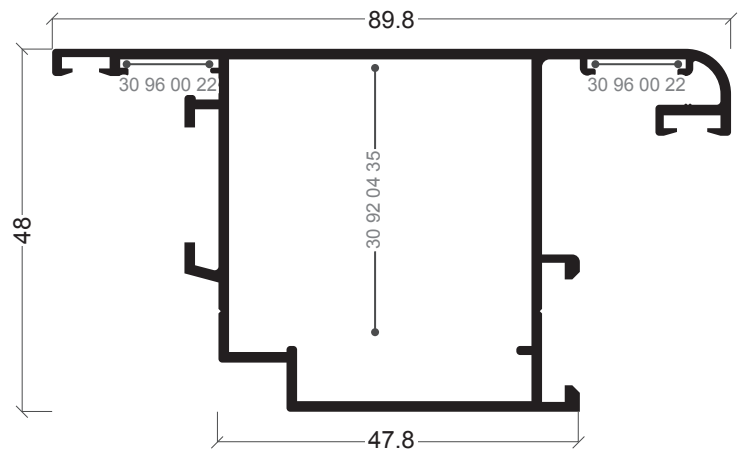

**AZ-14**

Aro móvel abertura exterior  
Hoja ventana apertura exterior

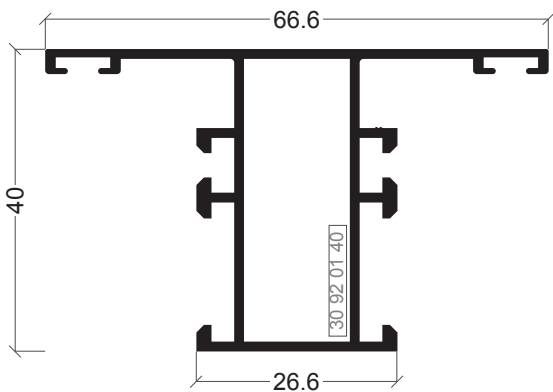

**AZ-01**

Travessa  
Travesaño ventana

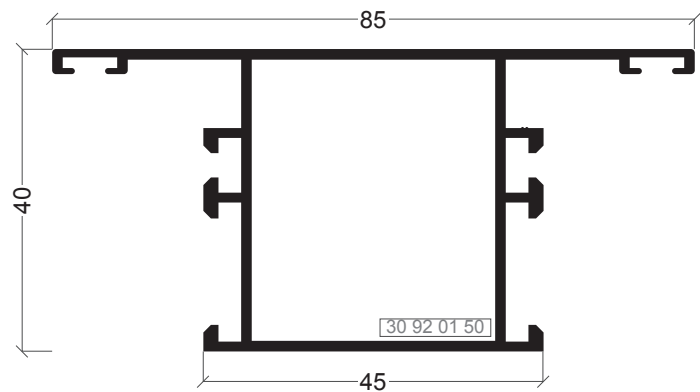

**AZ-09**

Travessa  
Travesaño puerta

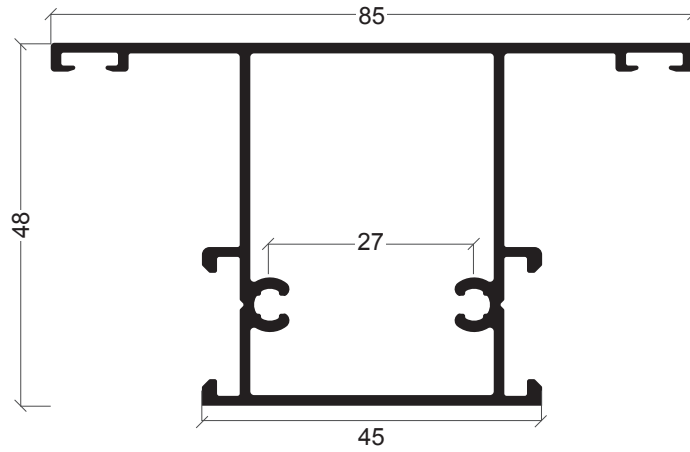

**AZ-78**

Travessa AZ-62/63/67  
Travesaño AZ-62/63/67

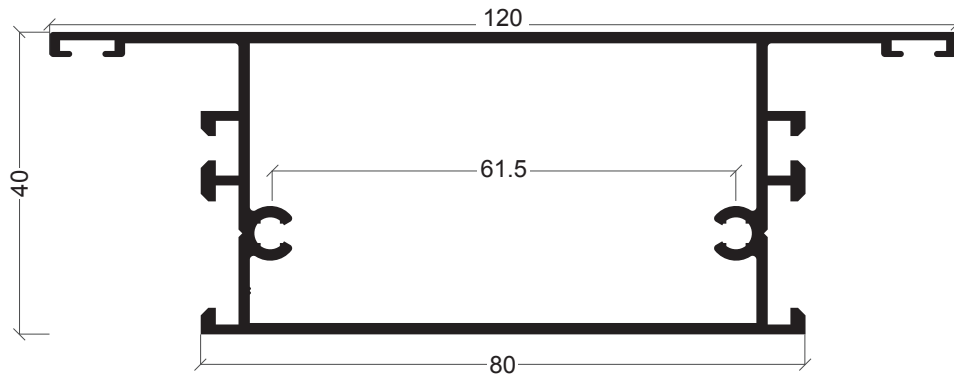

**AZ-12**

Travessa  
Zócalo puerta

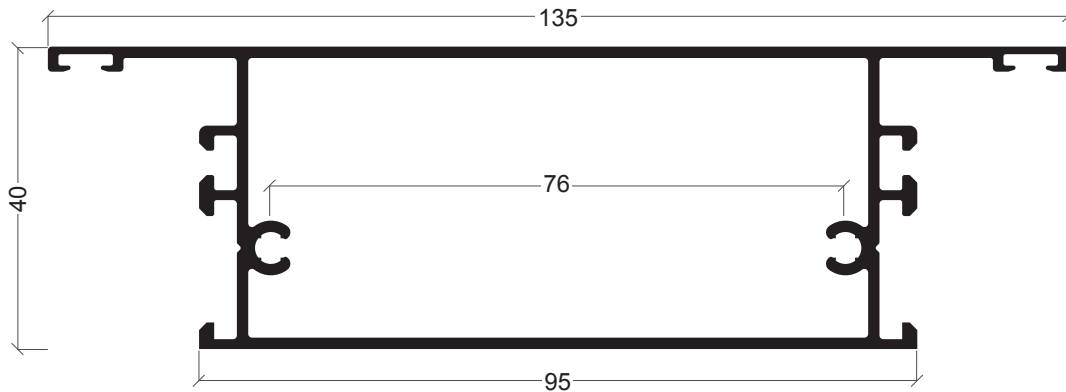

**AZ-73**

Travessa  
Zócalo puerta

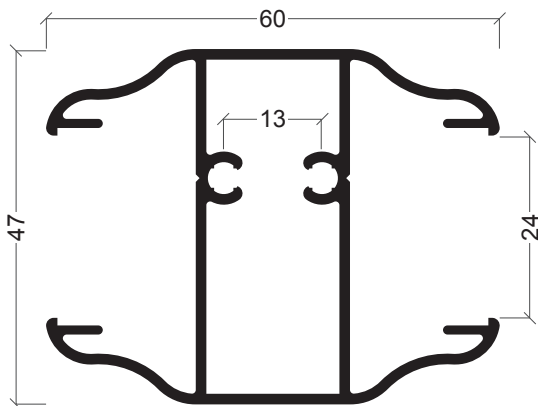

**AZ-56**

Travessa  
Travesaño rustico

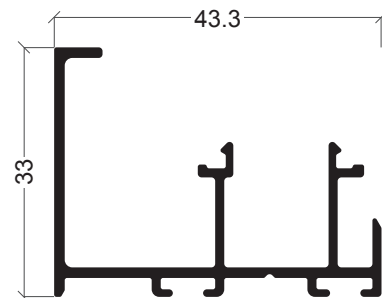

**AZ-75**

Remate almofada  
Remate puerta

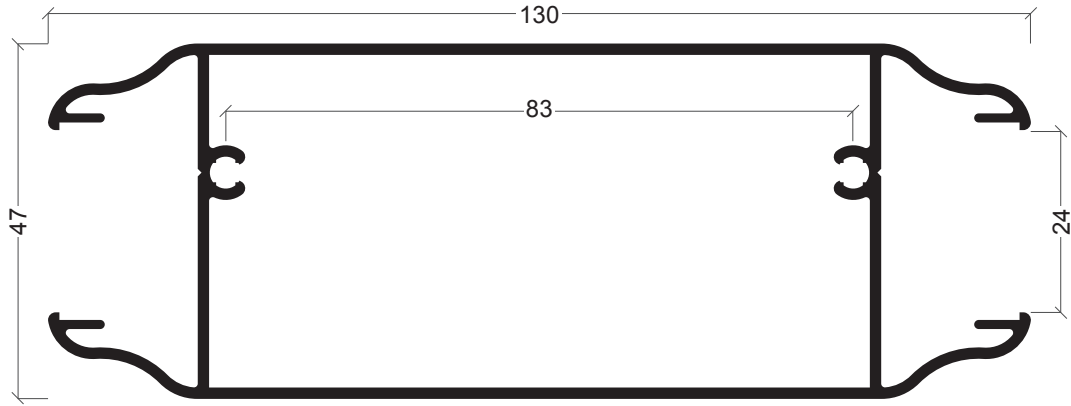

**AZ-54**  
Travessa  
Zócalo 130x47mm

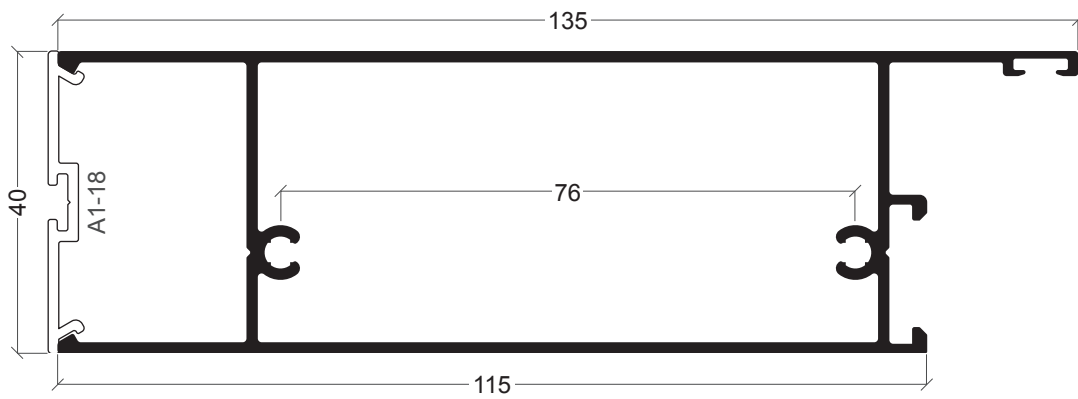

**AZ-74**  
Almofada  
Zócalo 135x40mm

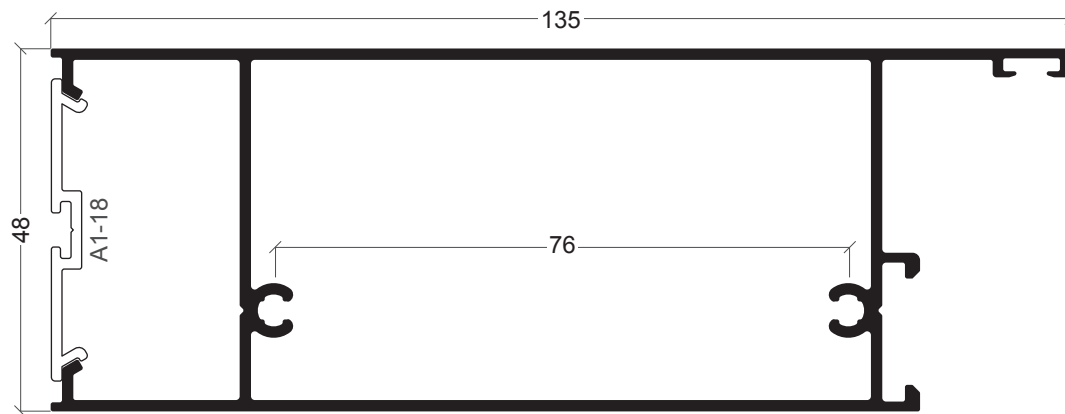

**AZ-77**  
Almofada  
Zócalo 135x48mm

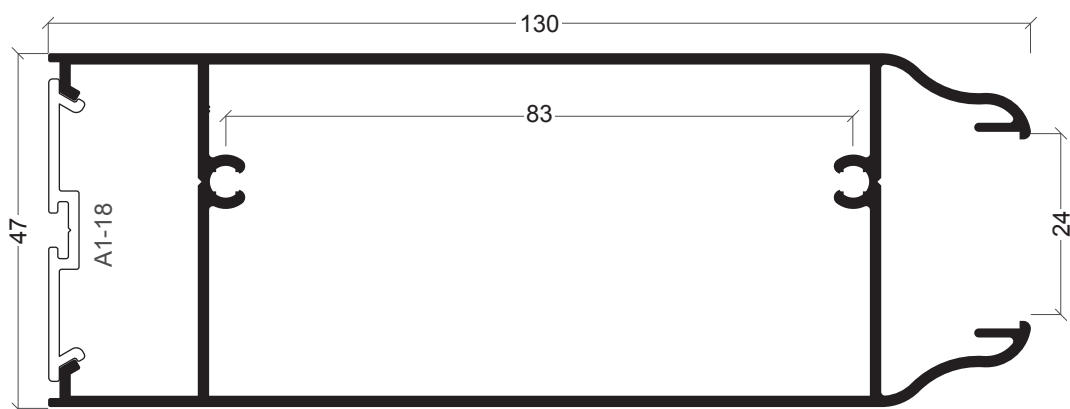

**AZ-55**

Almofada  
Zócalo rustico

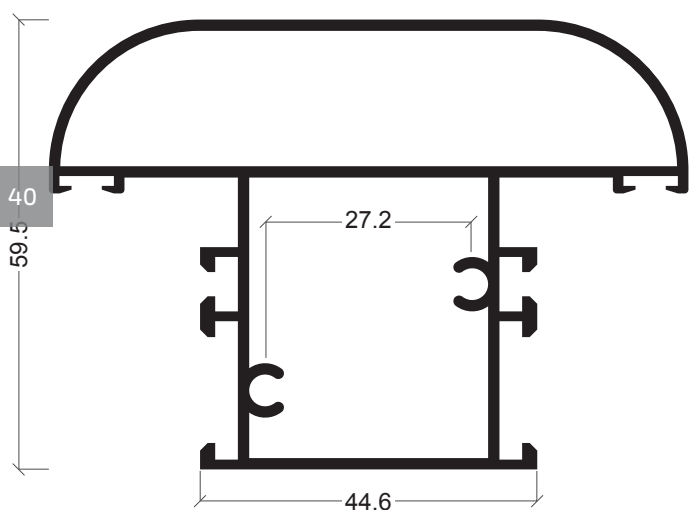

**AZ-49**

Travessa  
Zanca de escaparate

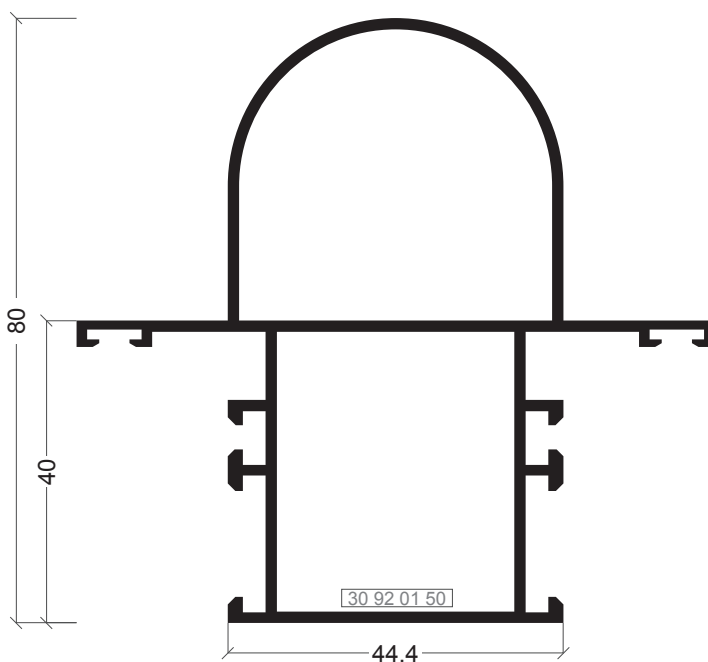

**AZ-57**

Montante / Travessa  
Rigidizador / Travesaño

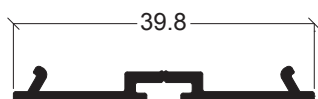

**A1-18**

Perfil de remate  
Perfil de solape

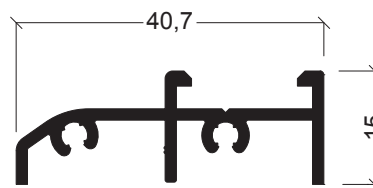

**AX-83**

Soleira  
Acople inferior

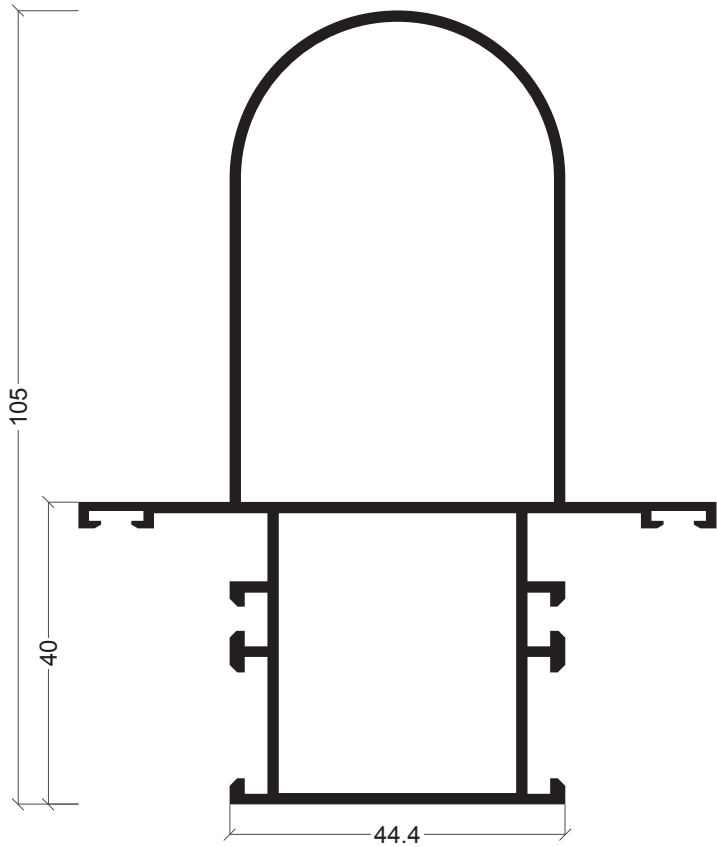

**AZ-58**

Montante  
Rigidizador 105mm curvo

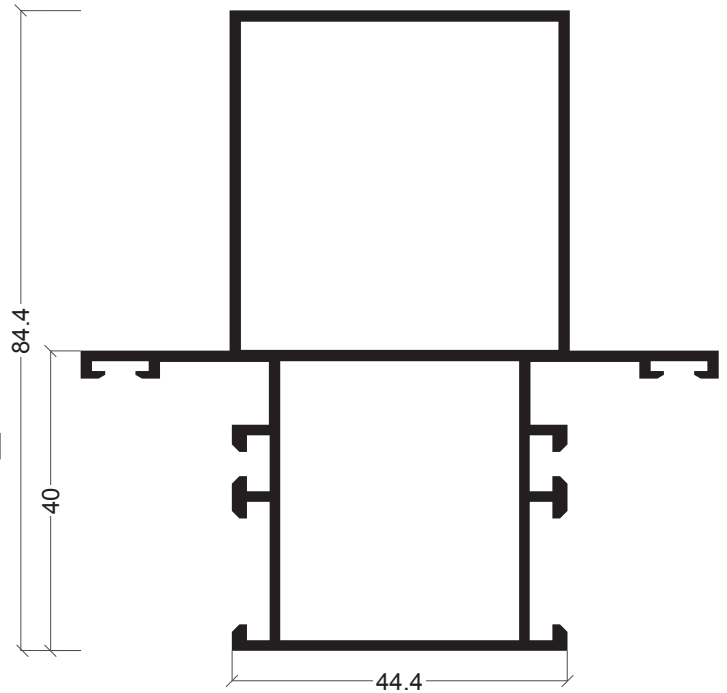

**AZ-64**

Montante  
Rigidizador 85mm recto

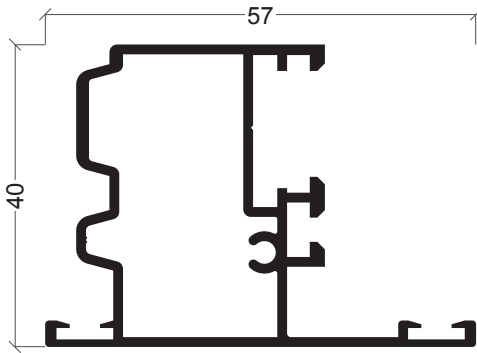

**AZ-04**

Inversor  
Inversor

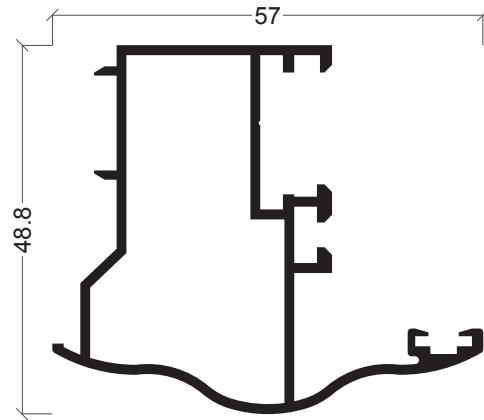

**AZ-65**

Inversor  
Inversor rustico

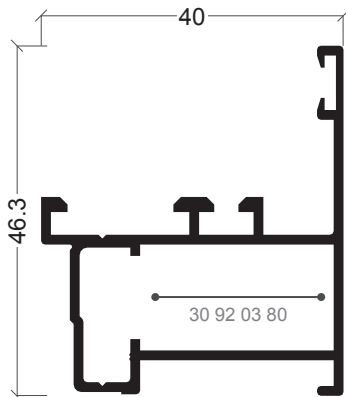

**AZ-76**

Inversor sentido de abertura  
Inversor sentido abertura

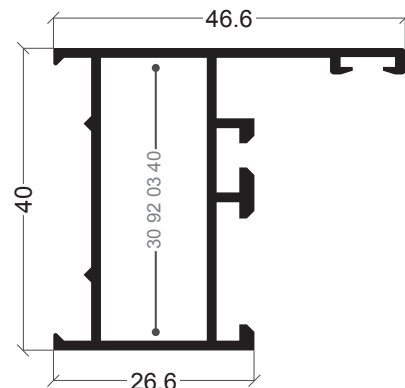

**AZ-16**

Aro fixo pivotante  
Marco abertura pivotante

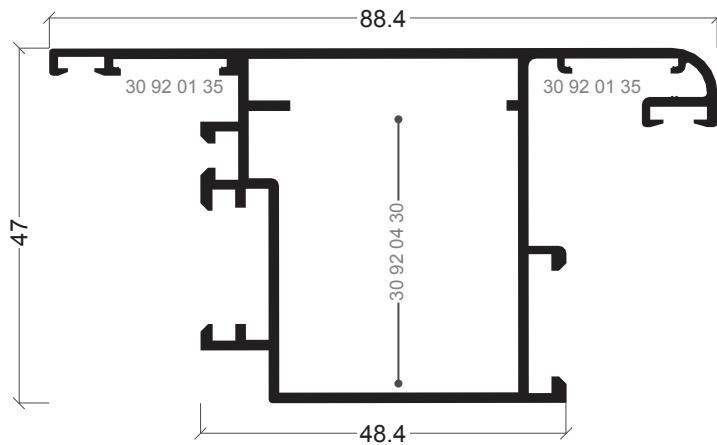

**AZ-17**

Aro móvel pivotante  
Hoja pivotante

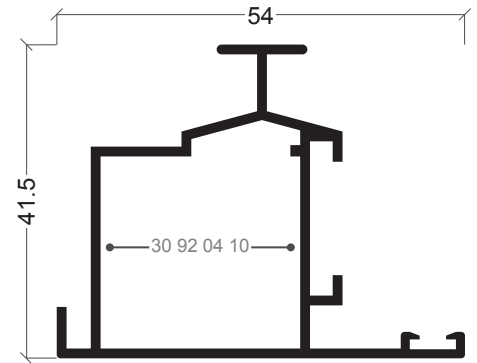

**AZ-18**

Inversor pivotante  
Perfil pivotante

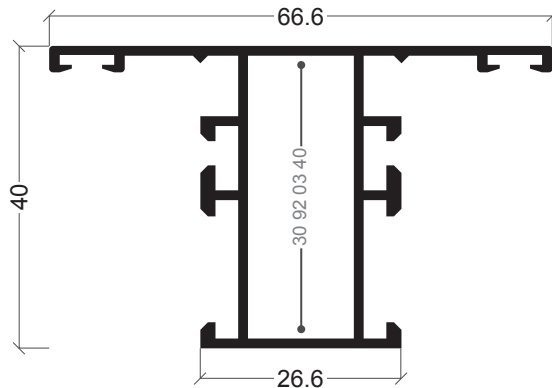

**AZ-31**

Travessa pivotante  
Travesaño pivotante

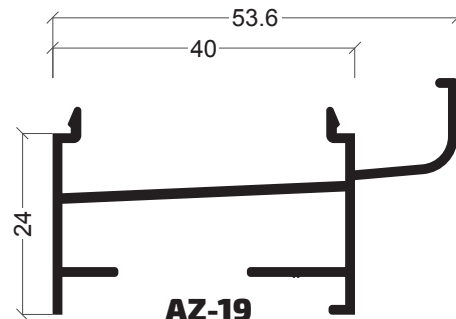

**AZ-19**

Soleira condensação  
Condensación

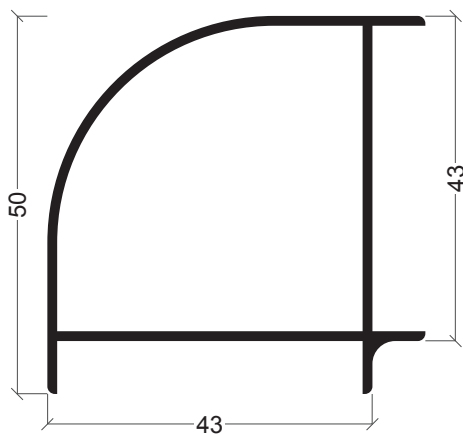

**AZ-25**

Canto 90°  
Esquinero 90° curvo

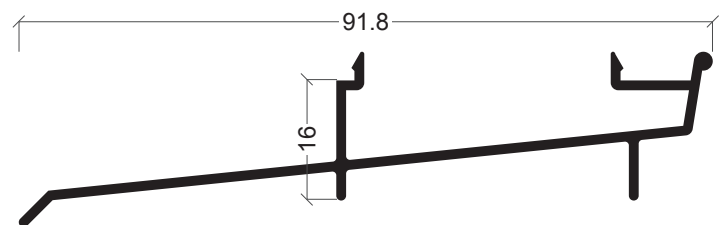

**AZ-26**

Soleira condensação  
Condensación

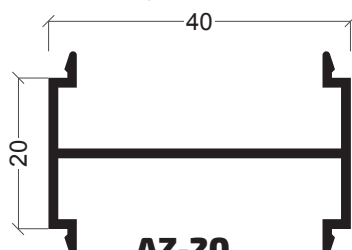

**AZ-20**

União de aros  
Unión de marcos

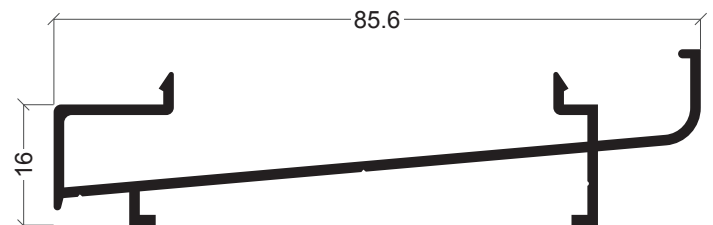

**AZ-66**

Soleira condensação  
Condensación

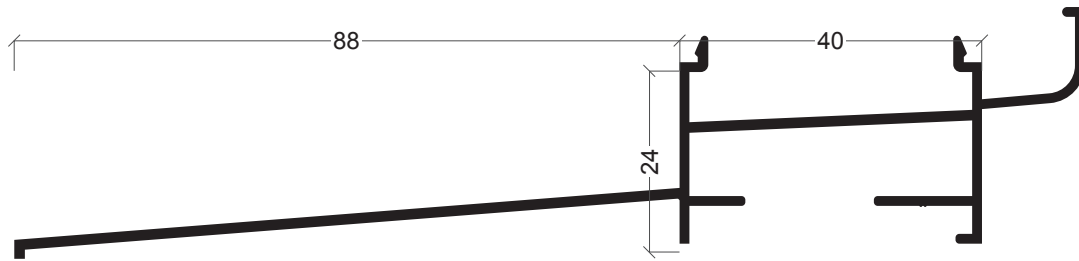

**AZ-80**

Soleira condensação  
Alargadera 80mm

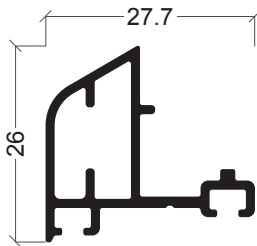

**AZ-79**

Pingadeira  
Vieriteaguas puerta

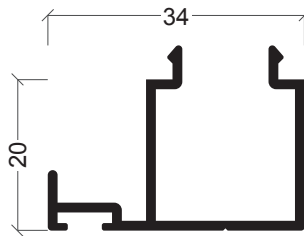

**AZ-59**

Bite de remate  
Junquillo acople

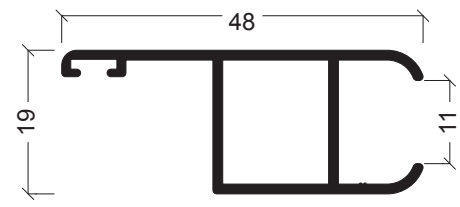

**AZ-22**

Aro móvel portada interior  
Hoja portada interior

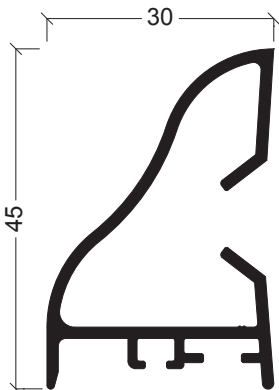

**AZ-70**

Pingadeira  
Vieriteaguas puerta

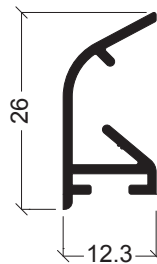

**AZ-60**

Pingadeira  
Vieriteaguas puerta

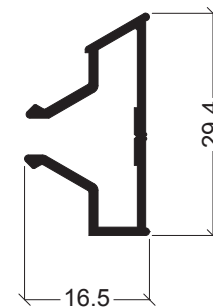

**AZ-61**

Clip Pingadeira  
Suplemento vieriteaguas

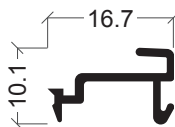

**AX-33**

Mola bite  
Grapa junquillo



**AX-19**

Vareta  
Pletina falleba

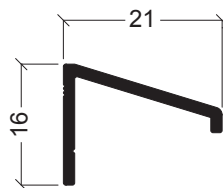

**A1-46**

Pingadeira  
Alargadera

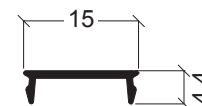

**KL-04**

Tampa  
Tope

**PORTADAS · MALLORQUINAS**

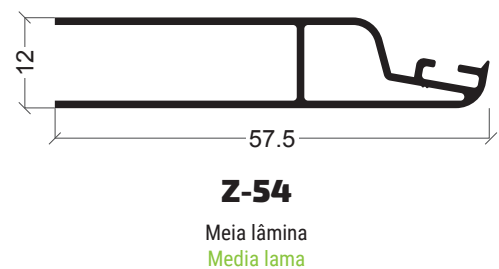
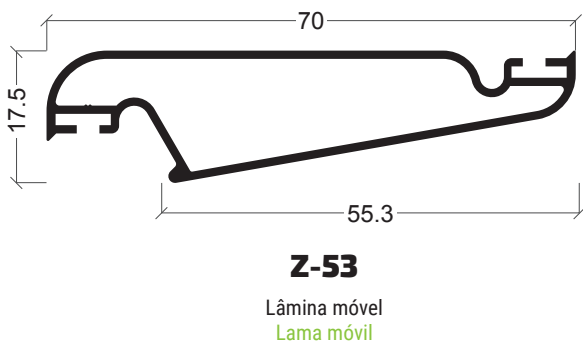
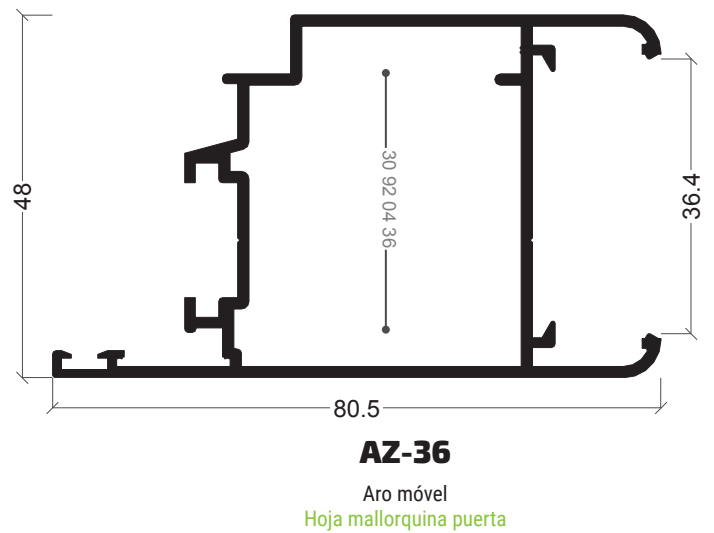
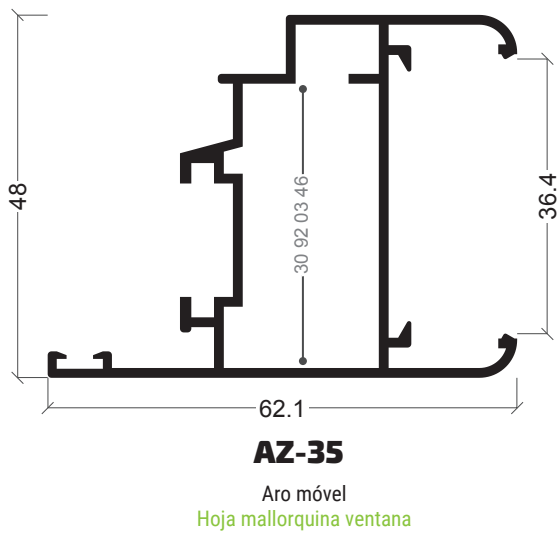
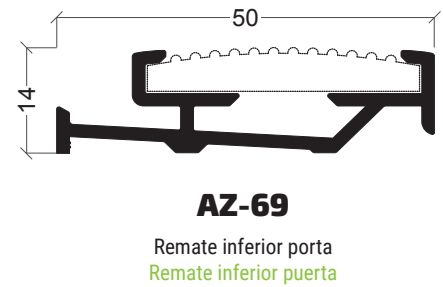
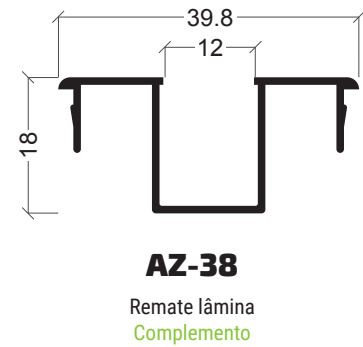
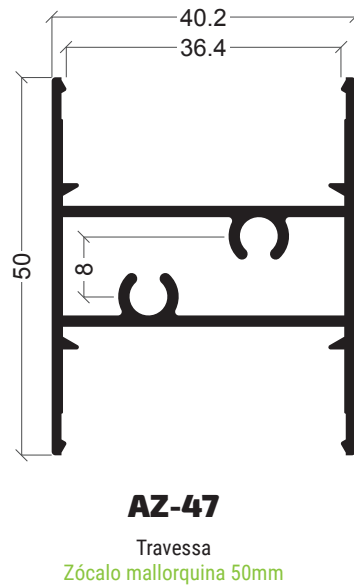
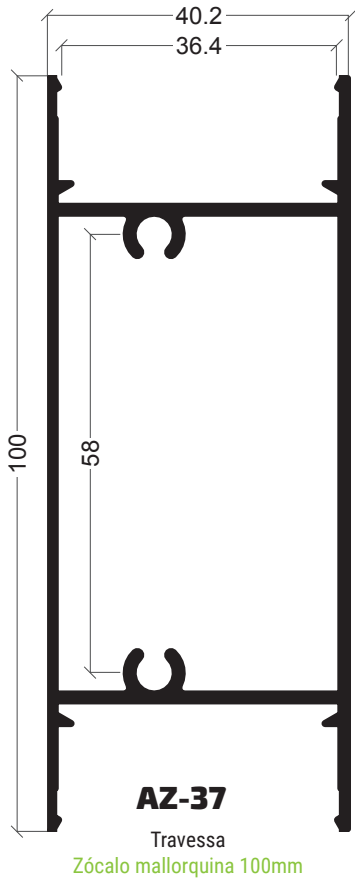



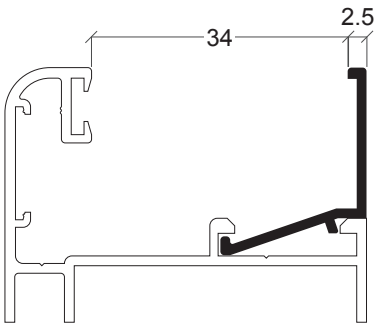

**AX-69**

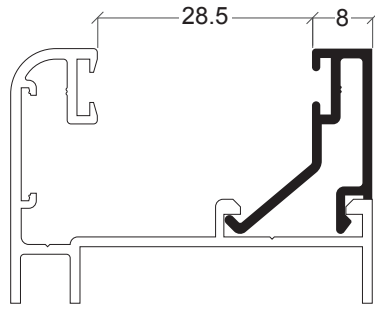

**AX-74**

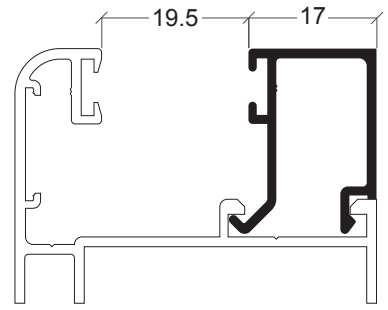

**AX-46**

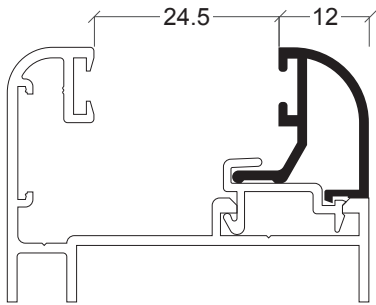

**AX-37**

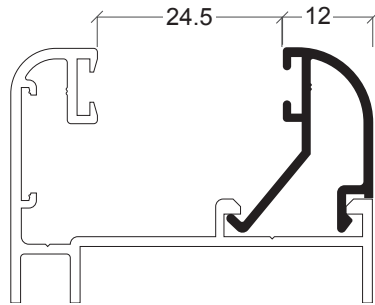

**AZ-08**

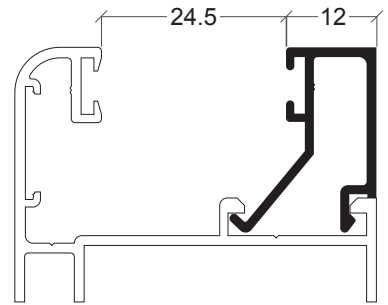

**AX-36**

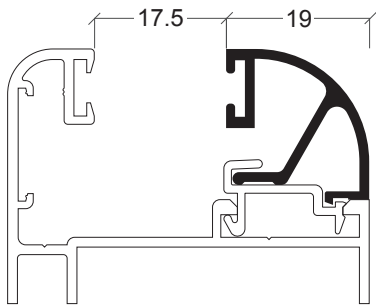

**AX-30**

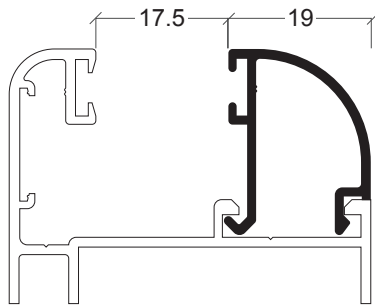

**AZ-07**

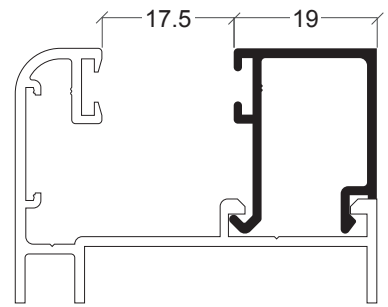

**AX-35**

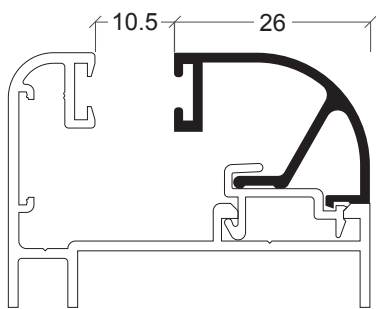

**AX-29**

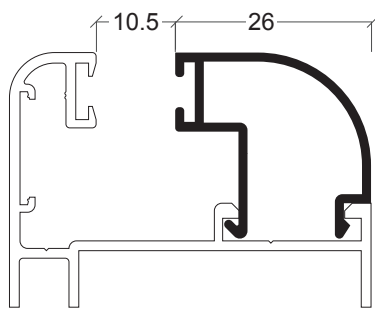

**AZ-06**

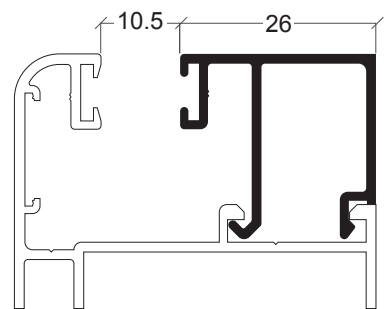

**AX-31**

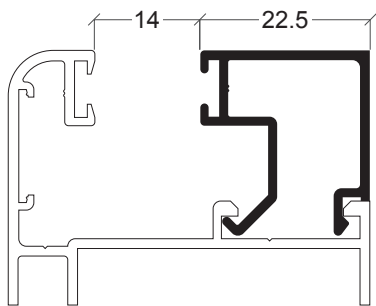

**AX-78**

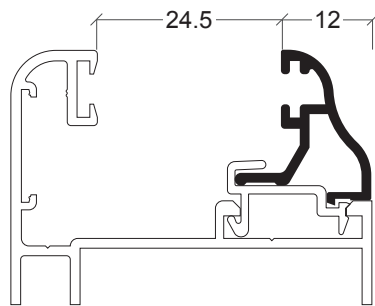

**AX-72**

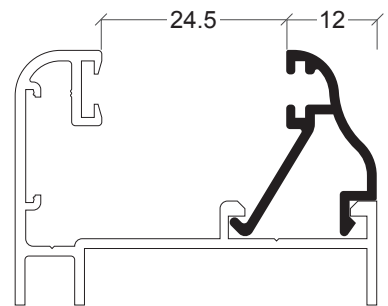

**AX-73**

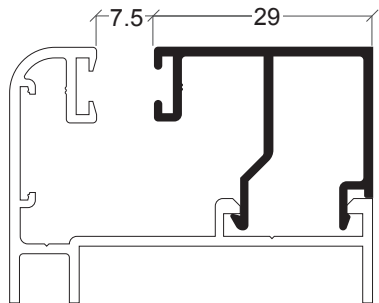

**AX-81**

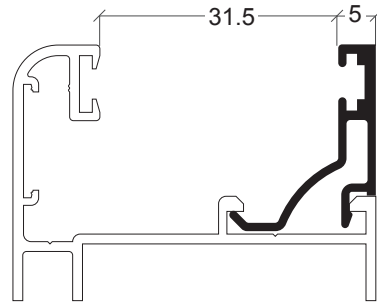

**AX-82**

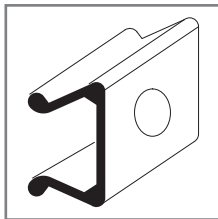

**30 03 40 00**

Mola para AZ-60  
Grapa para AZ-60

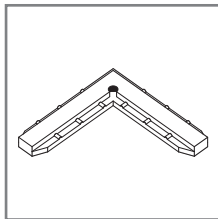

**30 21 20 07**

Esquadro alinhamento  
Escuadra alineamiento

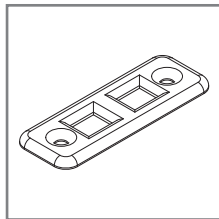

**30 24 30 75**

Contra-fecho duplo inferior inox  
Cerradero doble inferior inox

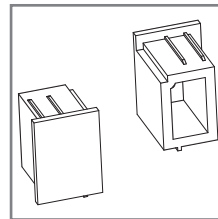

**30 91 21 20**

Jogo topos condensação para Y-20  
Juego topos condensación para Y-20

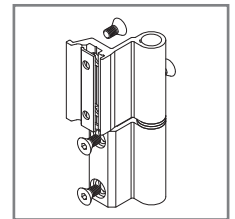

**30 92 00 20/21**

Dobradiça C.E. branco/preto  
Bisagra C.E. blanco/negro

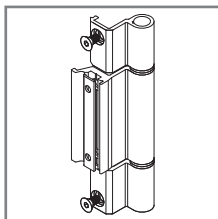

**30 92 00 26/27/28**

Dobradiça três nós (bruto/branco/preto)  
Bisagra tres nodos (crudo/blanco/negro)

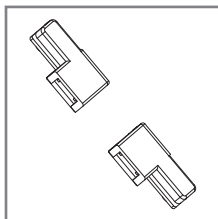

**30 92 00 30**

Transmissão barra cremone  
Transmisión pletina falleba

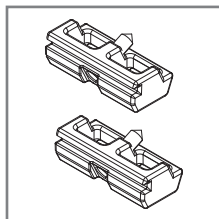

**30 92 00 50**

Contra-fecho  
Contra-cierre

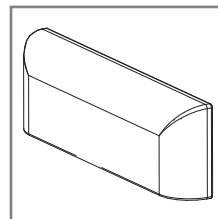

**30 92 01 00/01**

Goteira preto/branco  
Tapa salida de aguas negro/blanco

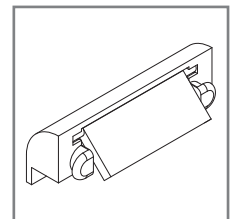

**30 92 01 02/03**

Goteira com válvula preto/branco  
Tapa salida de aguas negro/blanco

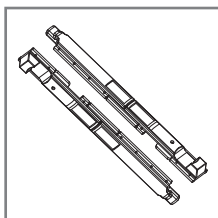

**30 92 01 20**

Jogo fecho C.E.  
Juego cierre C.E.

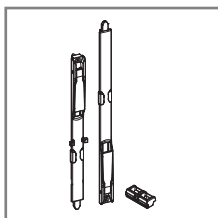

**30 92 01 21**

Compasso oscilo 300/400/500  
Compás oscilo 300/400/500

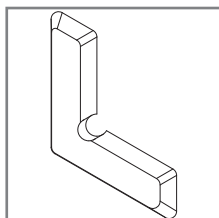

**30 92 01 35**

Esquadro alinhamento aro móvel  
Escuadra alineamiento hoja

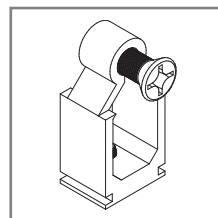

**30 92 01 40**

União topos janela  
Tope zanca ventana

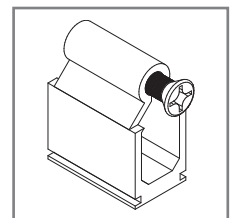

**30 92 01 50**

União topos porta  
Tope zanca puerta

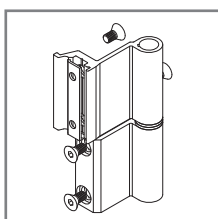

**30 92 01 70/80**

Dobradiça 3 folhas branco/preto  
Bisagra 3 hojas blanco/negro

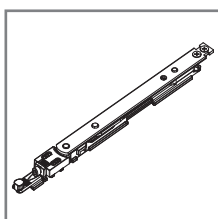

**30 92 02 10/11/12**

Fecho para micro-ventilação  
Cierre para micro-ventilación

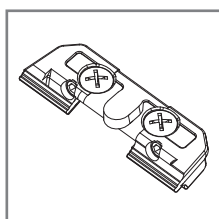

**30 92 02 15**

Kit oscilo-batente branco/preto  
Kit oscilo-batiente blanco/negro

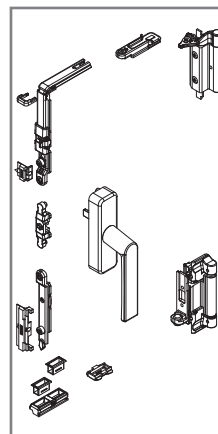

**30 92 02 20/21**

Kit 2ª folha oscilo-batente branco/preto  
Kit 2ª hoja oscilo-batiente blanco/negro

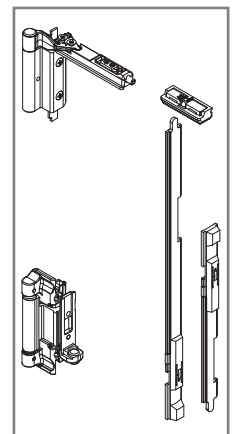

**30 92 02 24/25**

Kit 2ª folha oscilo-batente branco/preto  
Kit 2ª hoja oscilo-batiente blanco/negro

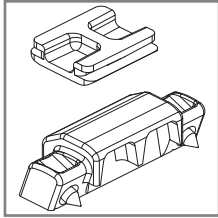

**30 92 02 60**

Apóio da folha  
Apoyo de la hoja

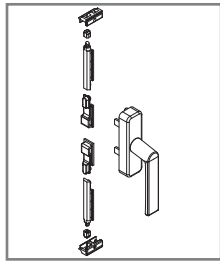

**30 92 03 10/11**

Kit cremone branco/preto  
Kit Cremona blanco/negro

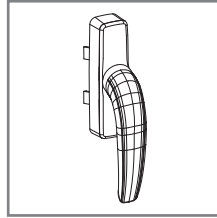

**30 92 03 20/21**

Cremone abertura exterior branco/preto  
Cremona abertura exterior blanco/negro

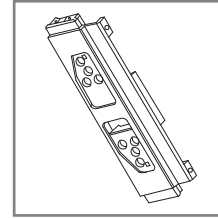

**30 92 03 30**

Jogo transmissão abertura exterior  
Juego transmisión apertura exterior

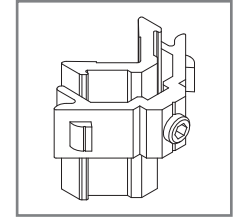

**30 92 03 40**

Esquadro janela  
Escuadra ventana

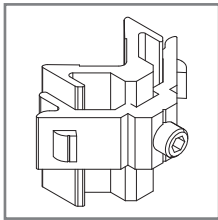

**30 92 03 42**

Esquadro AZ-32  
Escuadra AZ-32

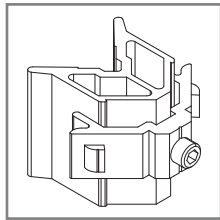

**30 92 03 45**

Esquadro AZ-15  
Escuadra AZ-15

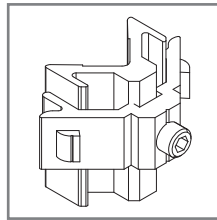

**30 92 03 46**

Esquadro AZ-35  
Escuadra AZ-35

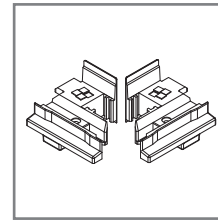

**30 92 03 51**

Jogo topos inversor AZ-4  
Juego topos inversor AZ-04

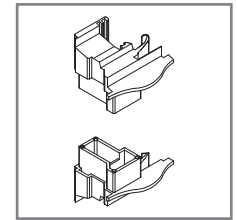

**30 92 03 55**

Jogo topos inversor AZ-65  
Juego topos inversor AZ-65

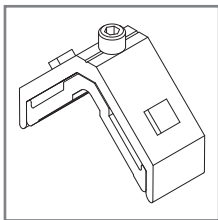

**30 92 04 10**

Esquadro AZ-18  
Escuadra AZ-18

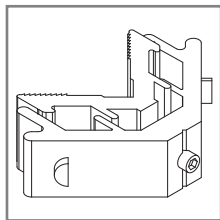

**30 92 04 25**

Esquadro AZ-22  
Escuadra AZ-22

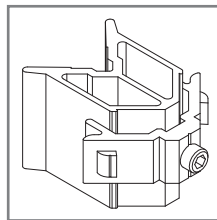

**30 92 04 30**

Esquadro porta  
Escuadra puerta

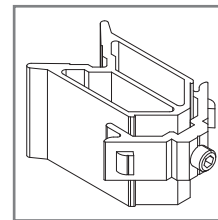

**30 92 04 35**

Esquadro AZ-14  
Escuadra AZ-14

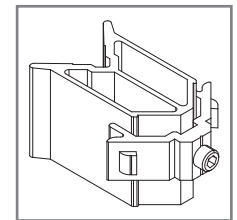

**30 92 04 36**

Esquadro AZ-36  
Escuadra AZ-36

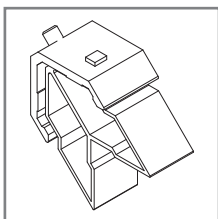

**30 92 04 37**

Esquadro AZ-53/72  
Escuadra AZ-53/72

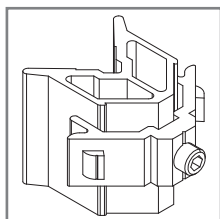

**30 92 04 42**

Esquadro aro porta AZ tradição  
Escuadra marco puerta AZ rústico

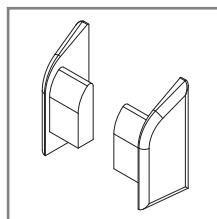

**30 92 05 00**

Jogo topos AZ-60  
Juego topos AZ-60

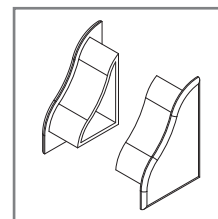

**30 92 05 01**

Jogo topos AZ-70  
Juego topos AZ-70

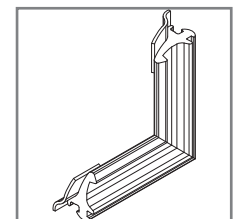

**30 92 05 02**

Canto Vulcanizado AZ/AX  
Angulo Vulcanizado AZ/AX

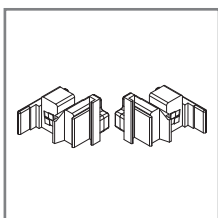

**30 92 05 05**

Jogo topos AZ-75  
Juego topos AZ-75

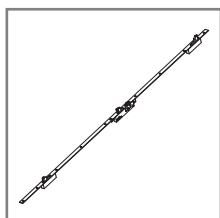

**30 92 05 10**

Fechadura 3 pontos  
Cierre 3 puntos

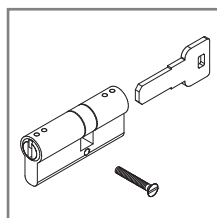

**30 92 05 40**

Canhão fechadura  
Bombillo cierre

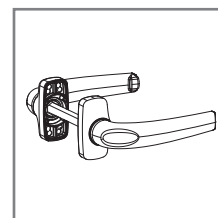

**30 92 05 60/61**

Puxador duplo branco/preto  
Manilla doble blanco/negro

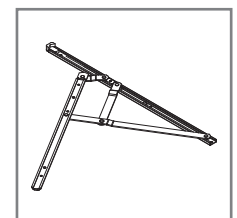

**30 92 06 00**

Compasso projectante deslizante (35kg)  
Compás projectante deslizante (35Kg)

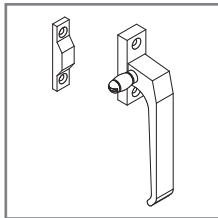

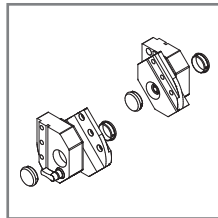
**30 92 06 10/11**

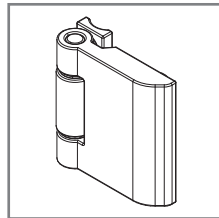
 Cremona de lingueta branco/preto  
 Cremona de presión blanco/negro

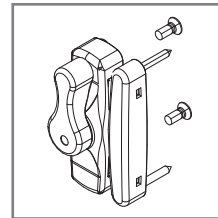
**30 92 07 10/11**

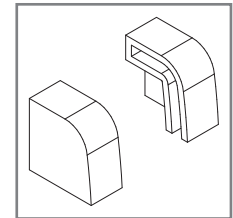
 Jogo pivotante preto/branco (60kg)  
 Juego pivotante negro/blanco (60kg)

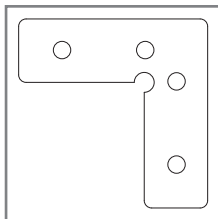
**30 92 08 20/21**

 Dobradiça AZ-22 branco/preto  
 Bisagra AZ-22 blanco/negro

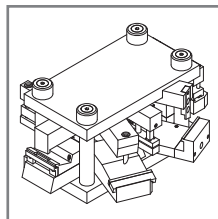
**30 92 08 30/31**

 Fecho veda luz branco/preto  
 Cierre veda luz blanco/negro

**30 96 00 12**























 Jogo topos condensação soleira  
 Juego topos condensación

**30 96 00 22**

 Esquadro alinhamento especial  
 Escuadra alineamiento especial

**33 96 79 99**



 Cunho C.E.  
 Troquel C.E.

## PORTA-LÂMINAS PARA CAIXA DE 36 MM • PORTA-LAMAS PARA HUECO DE 36 MM

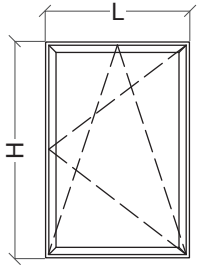
REFERÊNCIA • REFERENCIA	Nº DE LÂMINAS • Nº DE LAMAS	ALTURA MÍNIMA DE CORTE (MM) ALTO MÍNIMO DE CUERTE (MM)	ALTURA NOMINAL (MM) ALTO NOMINAL (MM)	ALTURA JANELA (MÍNIMO) ALTO VENTANA (MÍNIMO)	ALTURA JANELA (MÁXIMO) ALTO VENTANA (MÁXIMO)
30 92 09 40	6	400	460	570	630
30 92 09 41	7	460	520	630	690
30 92 09 42	8	520	580	690	750
30 92 09 43	9	580	640	750	810
30 92 09 44	10	640	700	810	870
30 92 09 45	11	700	760	870	930
30 92 09 46	12	760	820	930	990
30 92 09 47	13	820	880	990	1050
30 92 09 48	14	880	940	1050	1110
30 92 09 49	15	940	1000	1110	1170
30 92 09 50	16	1000	1060	1170	1230
30 92 09 51	17	1060	1120	1230	1290
30 92 09 52	18	1120	1180	1290	1350
30 92 09 53	19	1180	1240	1350	1410
30 92 09 54	20	1240	1300	1410	1470
30 92 09 55	21	1300	1360	1470	1530
30 92 09 56	22	1360	1420	1530	1590
30 92 09 57	23	1420	1480	1590	1650
30 92 09 58	24	1480	1540	1650	1710
30 92 09 59	25	1540	1600	1710	1770

REFERÊNCIA • REFERENCIA	DESENHO • DISEÑO	DESCRIÇÃO • DESCRIPCIÓN
30 00 95 15		Junta vedação inferior curta AZ-70/79 • Junta vedación inferior curta AZ-70/79
30 60 00 17		Junta exterior vidro plana 2 mm preto • Junta exterior vidrio plana 2mm negro
30 92 04 70		Espuma isolante • Espuma aislante
30 93 00 20		Junta tapa canal AZ 69 preto • Junta tapa canal AZ 69 negro
30 93 00 50		Junta central • Junta central
30 93 00 60		Vedante exterior de vidro (opcional) • Vedante exterior de acristalamiento (opcional)
30 93 00 62		Junta exterior plana • Junta exterior plana
30 93 00 65		Junta interior para vidro 5 mm • Junta interior para acristalamiento 5 mm
30 93 00 66		Junta interior para vidro 4 mm • Junta interior para acristalamiento 4 mm
30 93 00 67		Junta interior para vidro 2 mm • Junta interior para acristalamiento 2 mm
30 93 00 68		Junta interior para vidro 6/7 mm • Junta interior para acristalamiento 6/7 mm
30 93 00 69		Junta interior para vidro 8/9 mm • Junta interior para acristalamiento 8/9 mm
30 93 00 70		Vedante interior de vidro (opcional) • Vedante interior de acristalamiento (opcional)
30 93 00 81		Junta vedação inferior A1-18 • Junta vedación inferior A1-18
30 93 00 82		Junta vedação inferior AZ-70/79 • Junta vedación inferior AZ-70/79
30 93 00 84		Junta para pingadeiras AZ-60 e AZ-70 • Junta para goteos AZ-60 e AZ-70
30 93 00 90		Junta exterior • Junta exterior
30 93 01 20		Junta interior • Junta interior
30 93 01 40		Junta lâminas • Junta de lamas
30 94 01 46		Junta para veda-luz AZ-22 • Junta para AZ-22
30 95 00 10		Pelúcia 7x9 mm • Burlete 7x9 mm
30 95 00 40		Pelúcia 7x5.5 mm • Burlete 7x5.5 mm
30 93 00 85		Junta vedação interior longa preta • Junta vedación interior longa negra

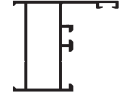
**Janela 1 folha abrir e oscilo-batente • Ventana 1 hoja practicable y oscilobatiente**

**PERFIS • PERFIS**

DESENHO • DISEÑO	REF.	DESCRIÇÃO • DESCRIPCIÓN	CORTE • CORTE	QUANTIDADE CANTIDAD	MEDIDAS • MEDIDA
	AZ-03	Aro fixo • Marco ventana		2	L
				2	H-24 mm
	AZ-67	Aro móvel • Hoja ventana		2	L-41 mm
				2	H-65 mm
	---	Bite • Junquillo		2	L-133.5 mm
				2	H-197.5 mm
	AX-19	Vareta • Pletina falleba		2	Apro. H/2 mm
	AZ-19	Soleira de condensação • Condensación		1	L

**ACESSÓRIOS E JUNTAS • ACCESORIOS Y JUNTAS**

REF.	DESCRIÇÃO • DESCRIPTION	QUANTIDADE • CANTIDAD	
		ABRIR PRATICABLE	OSCILO-BATENTE OSCILOBATIENTE
30 92 00 20	Dobradiças C.E. • Bisagra C.E.	2	---
30 92 01 00	Goteiras • Tapa salida de aguas	2	2
30 92 01 35	Esquadro alinhamento aro móvel • Escuadra alineamiento hoja	8	8
30 92 02 (xx)	Compasso O.B. • Compás O.B.	---	1
30 92 02 20	Kit oscilo-batente • Kit oscilo-batiente	---	1
30 92 02 60	Apoio da folha • Apoyo de la hoja	1	---
30 92 03 10	Kit cremone • Kit Cremona	1	---
30 92 03 40	Esquadro janela • Escuadra ventana	8	8
30 96 00 12	Jogo topos condensação • Juego topos condensación	1	1
30 93 00 50	Junta central • Junta central	2L+2H	
30 93 00 90	Junta exterior • Junta exterior	2L+2H	
30 93 01 20	Junta interior • Junta interior	2L+2H	
---	Junta exterior vidro • Junta exterior acristalamiento	2L+2H	
---	Junta interior vidro • Junta interior acristalamiento	2L+2H	
30 92 05 02	Cantos Vulcanizados • Angulo vulcanizado	4	

**VIDRO • VIDRIO**

Hv = H-171 mm	Lv = L-147 mm
---------------	---------------

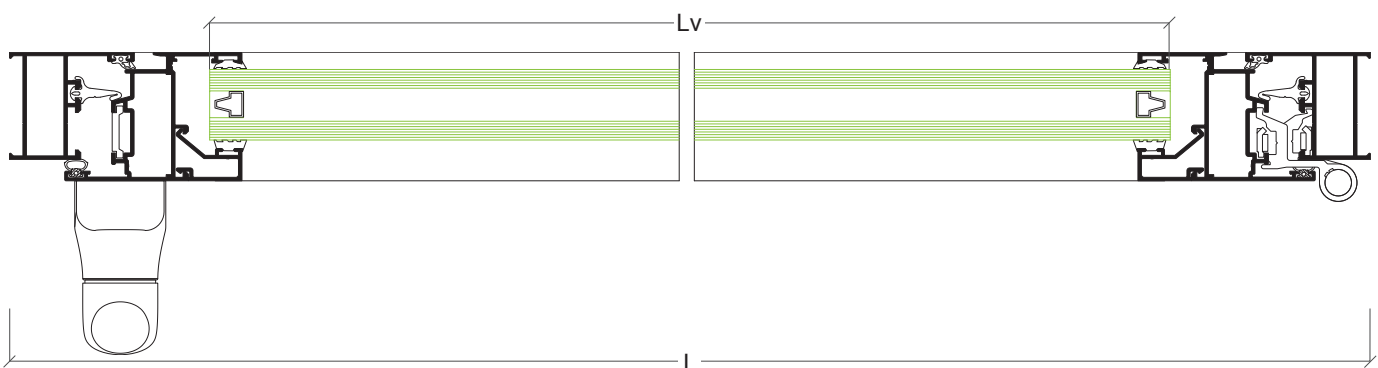
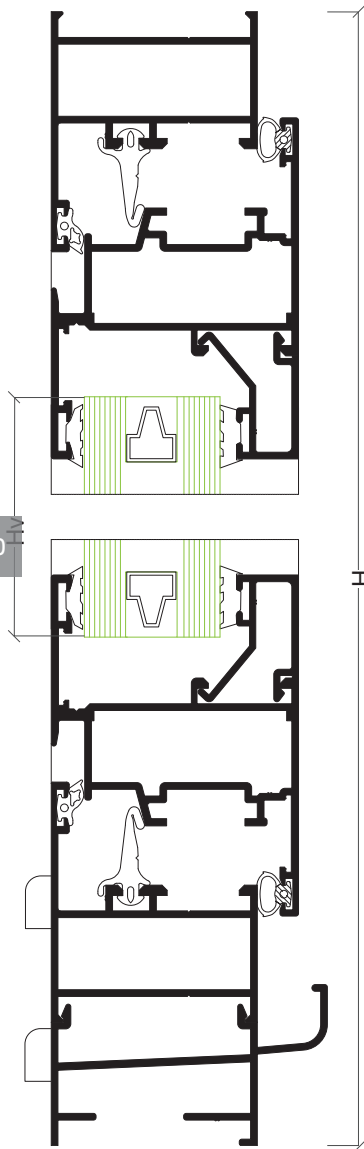

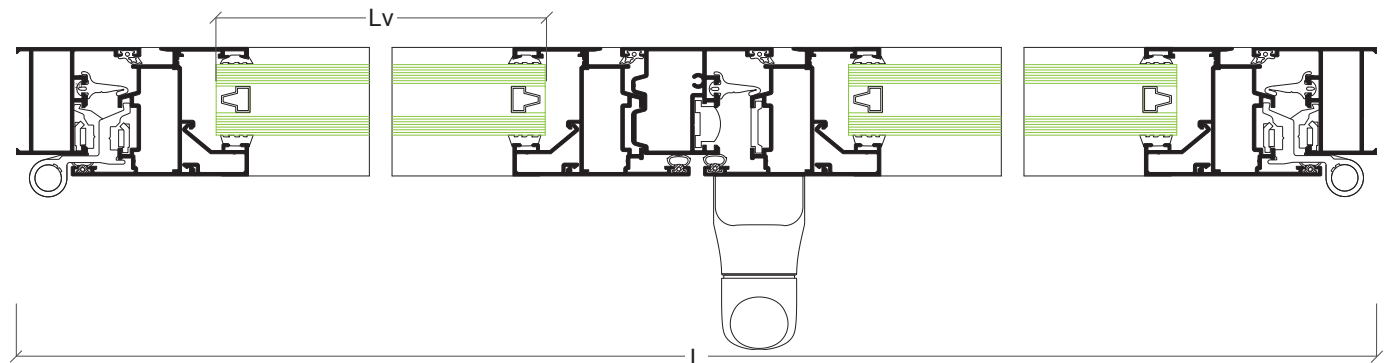
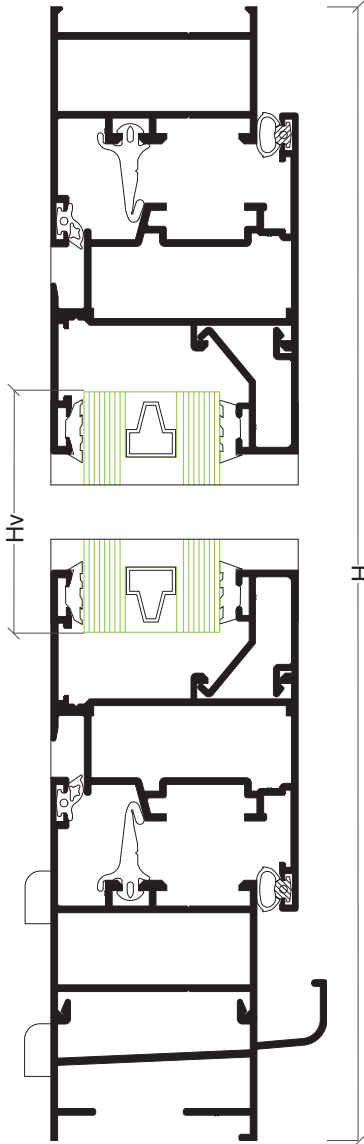
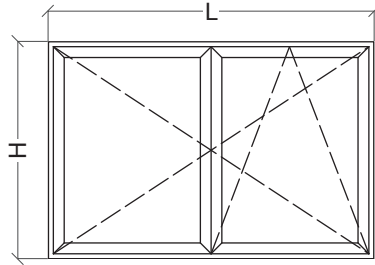
**Janela 2 folhas abrir e oscilo-batente • Ventana 2 hojas practicable y oscilo-batiente**

**PERFIS • PERFIS**

DESENHO • DISEÑO	REF.	DESCRIÇÃO • DESCRIPCIÓN	CORTE • CORTE	QUANTIDADE • CANTIDAD	MEDIDAS • MEDIDA
	AZ-03	Aro fixo • Marco	 	2	L
	AZ-67	Aro móvel • Hoja	 	4	L/2-23 mm
	AZ-04	Inversor • Inversor		1	H-133 mm
	---	Bite • Junquillo	 	4	L/2-115.5 mm
	AX-19	Vareta • Junquillo		2	Apro. H/2 mm
	AZ-19	Soleira de condensação • Condensación		1	L



**ACESSÓRIOS E JUNTAS • ACCESORIOS Y JUNTAS**

REF.	DESCRIÇÃO • DESCRIPTION	QUANTIDADE • CANTIDAD	
		ABRIR PRÁTICABLE	OSCILO-BATENTE OSCIOBATIENTE
30 92 00 20	Dobradiças C.E. • Bisagra C.E.	4	---
30 92 01 00	Goteiras • Tapa salida de aguas	2	2
30 92 01 20	Jogo fecho C.E. • Juego cierre C.E.	1	---
30 92 01 35	Esquadro alinhamento aro móvel • Escuadro alineamiento hoja	16	16
30 92 02 (xx)	Compasso O.B. • Compás O.B.	---	1
30 92 02 20	Kit oscilo-batente • Kit oscilo-batiente	---	1
30 92 02 24	Kit 2ª folha oscilo-batente • Kit 2ª hoja oscilo-batiente	---	1
30 92 02 60	Apoio da folha • Apoyo de hoja	1	1
30 92 03 10	Kit cremone • Kit cremona	1	---
30 92 03 40	Esquadro janela • Escuadro ventana	12	12
30 92 03 51	Jogo topos inversor • Juego topos inversor	1	1
30 96 00 12	Jogo topos condensação • Juego topos condensación	1	1
30 93 00 50	Junta central • Junta central	2L+3H	
30 93 00 90	Junta exterior • Junta exterior	2L+4H	
30 93 01 20	Junta interior • Junta interior	2L+4H	
---	Junta exterior vidro • Junta exterior vidrio	2L+4H	
---	Junta interior vidro • Junta interior vidrio	2L+4H	
30 92 05 02	Cantos Vulcanizados • Angulo vulcanizado	4	

**VIDRO • VIDRIO**

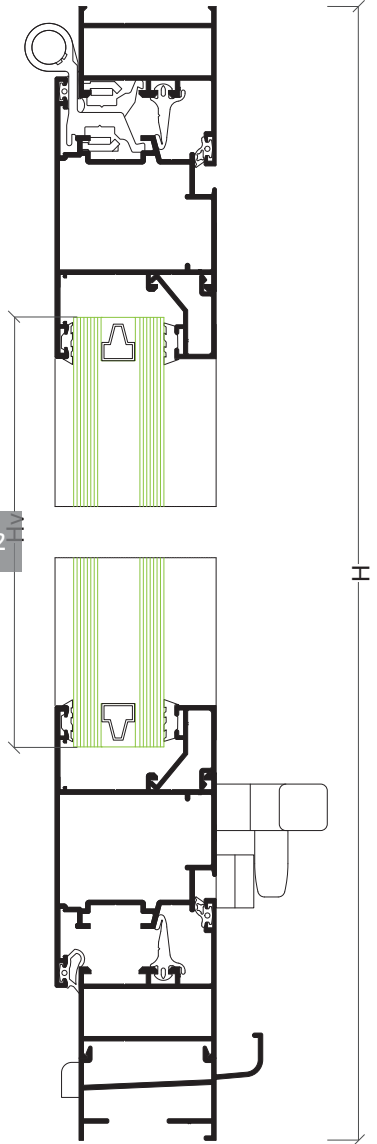
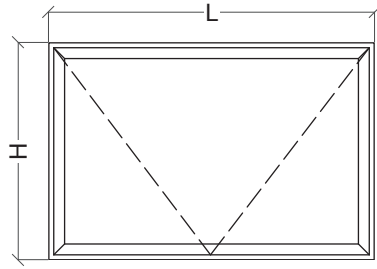
Hv = H-171 mm	Lv = L/2-129 mm
---------------	-----------------

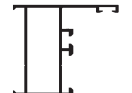
**Janela 1 folha projectante • Janela 1 folha projectante**

**PERFIS • PERFIS**

DESENHO • DISEÑO	REF.	DESCRIÇÃO • DESCRIPCIÓN	CORTE • CORTE	QUANTIDADE • CANTIDAD	MEDIDAS • MEDIDA
	AZ-03	Aro fixo • Marco		2	L
	AZ-63	Aro móvel • Hoja		2	H-24 mm
	AZ-63	Aro móvel • Hoja		2	L-41 mm
	AZ-63	Aro móvel • Hoja		2	H-65 mm
	---	Bite • Junquillo		2	L-168.5 mm
	AX-19	Vareta • Pletina falleba		2	H-192.5 mm
	AZ-19	Soleira de condensação • Condensación		2	Apro. H/2 mm
	AZ-19	Soleira de condensação • Condensación		1	L

**ACESSÓRIOS E JUNTAS • ACCESORIOS Y JUNTAS**

REF.	DESCRIÇÃO • DESCRIPTION	QUANTIDADE • CANTIDAD
30 92 00 20	Dobradiças C.E. • Bisagra C.E.	2
30 92 01 00	Goteiras • Tapa salida de aguas	2
30 92 03 40	Esquadro janela • Escuadro ventana	4
30 92 04 30	Esquadro móvel • Escuadro hoja	4
30 92 04 85	Jogo compassos projectante • Juego compás projectante	1
30 92 06 10	Cremona de lingueta • Cremona de lingueta	2
30 96 00 12	Jogo topos condensação • Juego topos condensación	1
30 92 01 35	Esquadro alinhamento • Escuadro alineamiento	8
30 93 00 90	Junta interior • Junta interior	2L+2H
30 93 01 20	Junta exterior • Junta exterior	2L+2H
---	Junta exterior vidro • Junta exterior vidrio	2L+2H
---	Junta interior vidro • Junta interior vidrio	2L+2H
30 93 00 50	Junta central • Junta central	2L+2H
30 92 05 02	Cantos Vulcanizados • Angulo vulcanizado	4

**VIDRO • VIDRIO**

Hv = H-206 mm	Lv = L-182 mm
---------------	---------------

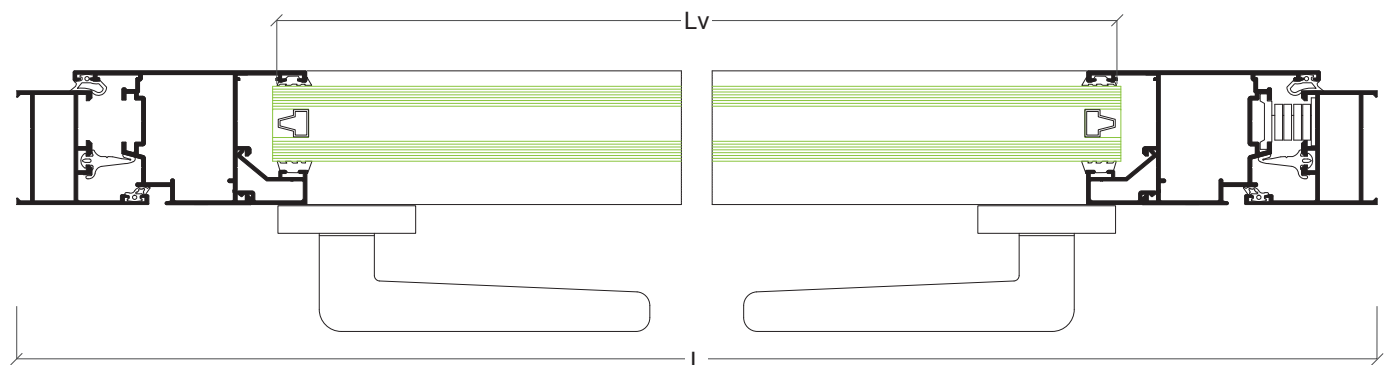

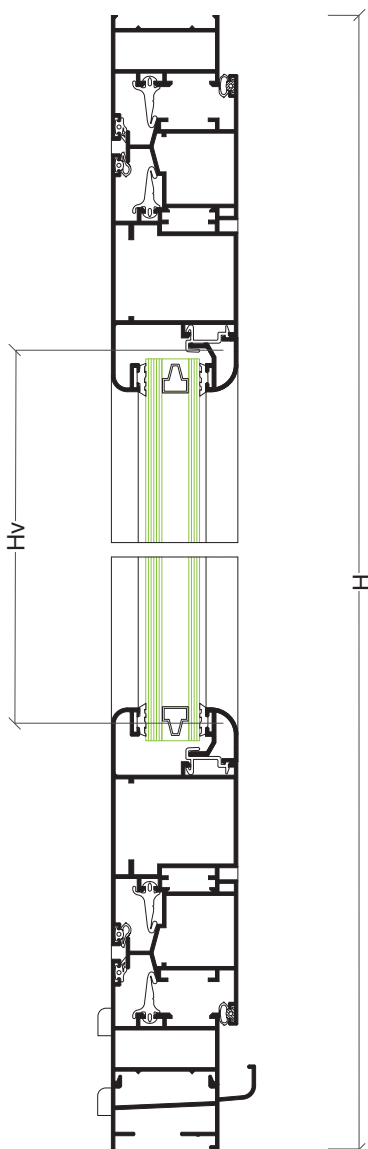
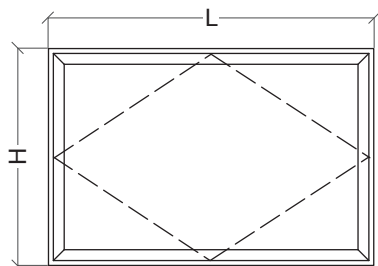

**Janela pivotante horizontal • Ventana pivotante horizontal**

**PERFIS • PERFIS**

DESENHO • DISEÑO	REF.	DESCRIÇÃO • DESCRIPCIÓN	CORTE • CORTE	QUANTIDADE CANTIDAD	MEDIDAS • MEDIDA
	AZ-16	Aro fixo pivotante		2	L
		Marco pivotante		2	H-24 mm
	AZ-17	Aro móvel pivotante		2	L-104 mm
		Hoja pivotante		2	H-128 mm
	AZ-18	Inversor pivotante superior		1	L-45 mm
		Inversor pivotante superior		2	H/2-22,5 mm
	AZ-18	Inversor pivotante inferior		1	L-45 mm
		Inversor pivotante inferior		2	H/2-22,5 mm
	---	Bite redondo • Junquillo curvo		2	L-240 mm
	---	Bite redondo clip Junquillo curvo clip		2	H-255 mm
	AX-33	Mola bite • Grapa junquillo		A cada 300 mm Cada 300 mm	80 mm
	AZ-19	Soleira de condensação Condensación		1	L

**ACESSÓRIOS E JUNTAS • ACCESORIOS Y JUNTAS**

REF.	DESCRIÇÃO • DESCRIPTION	QUANTIDADE • CANTIDAD
30 92 01 00	Goteiras • Tapa salida de aguas	4
30 92 03 40	Esquadro janela • Escuadra ventana	4
30 92 04 10	Esquadro AZ-18 • Escuadra AZ-18	4
30 92 04 30	Esquadro porta • Escuadra puerta	4
30 92 07 10	Jogo pivotante • Juego pivotante	1
30 96 00 12	Jogo topos condensação • Juego topos condensación	1
30 92 06 11	Cremona de lingueta • Cremona de presión	2
30 93 00 50	Junta central • Junta central	4L+4H
30 93 00 90	Junta exterior • Junta exterior	2L+2H
30 93 01 20	Junta interior • Junta interior	4L+4H
---	Junta exterior vidro • Junta exterior acristalamiento	2L+2H
---	Junta interior vidro • Junta interior acristalamiento	2L+2H
30 92 01 35	Esquadro alinhamento aro móvel • Escuadra alineamiento hoja	8
30 92 05 02	Cantos Vulcanizados • Angulo vulcanizado	8

**VIDRO • VIDRIO**

Hv = H-278 mm	Lv = L-254 mm
---------------	---------------

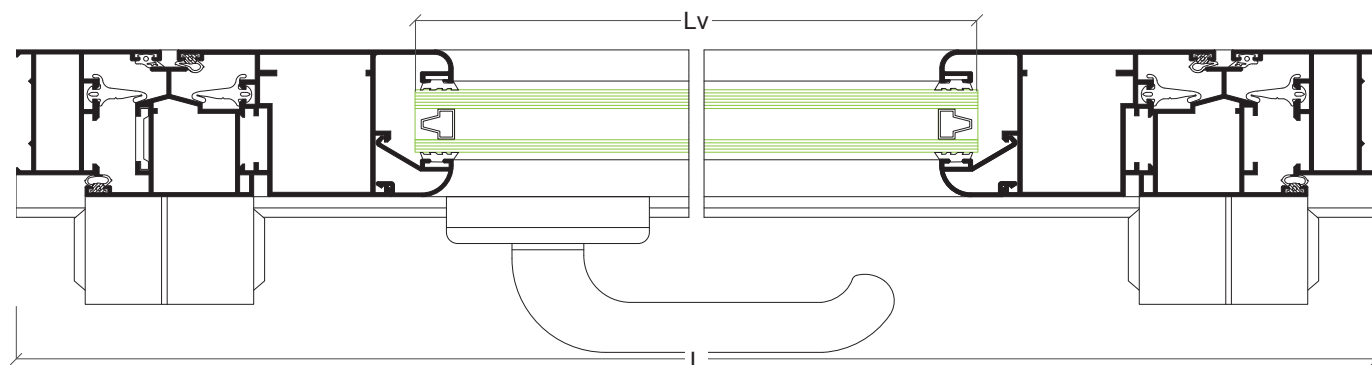

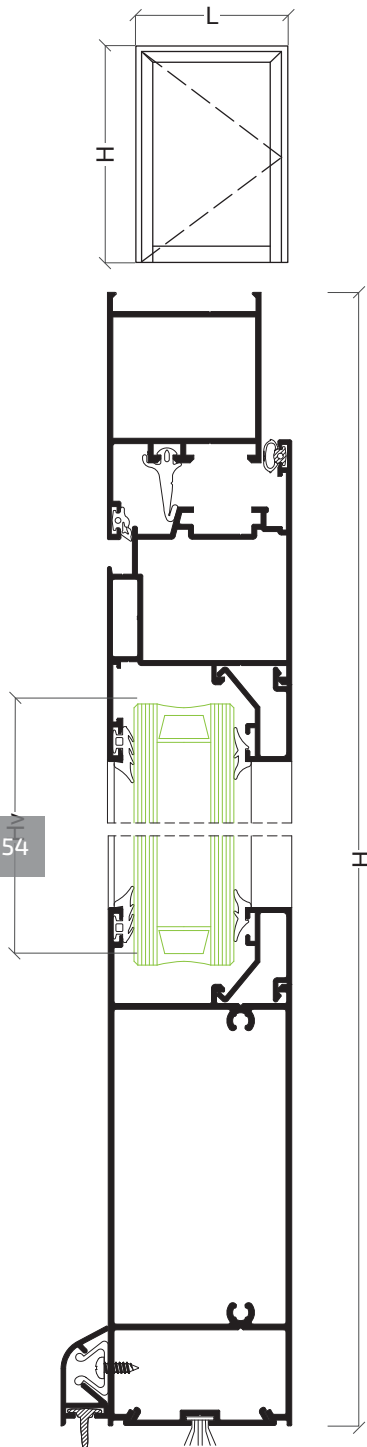
**Porta 1 folha • Puerta 1 hoja**

**PERFIS • PERFIS**

DESENHO • DISEÑO	REF.	DESCRIÇÃO • DESCRIPCIÓN	CORTE • CORTE	QUANTIDADE CANTIDAD	MEDIDAS • MEDIDA
	AZ-11	Aro fixo • Marco		1	L
				2	H
	AZ-62	Aro móvel • Hoja		1	L-77 mm
				2	H-44 mm
	---	Bite • Junquillo		2	L-204.5 mm
				2	H-263 mm
	AZ-60	Pingadeira • Alargadera		1	L-149 mm
	AZ-77	Almofada • Zócalo		1	L-194 mm
	A1-18	Bite remate • Junquillo remate		1	L-204,5 mm

**ACESSÓRIOS E JUNTAS • ACCESORIOS Y JUNTAS**







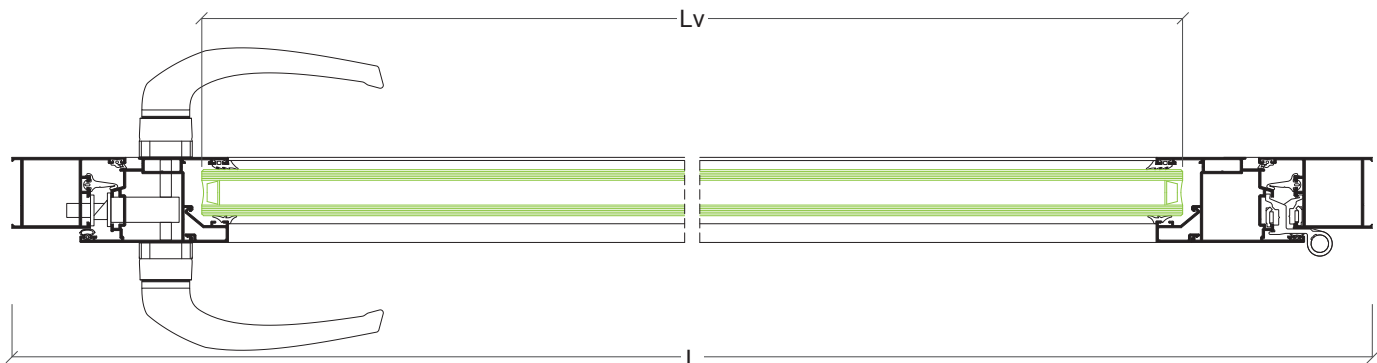

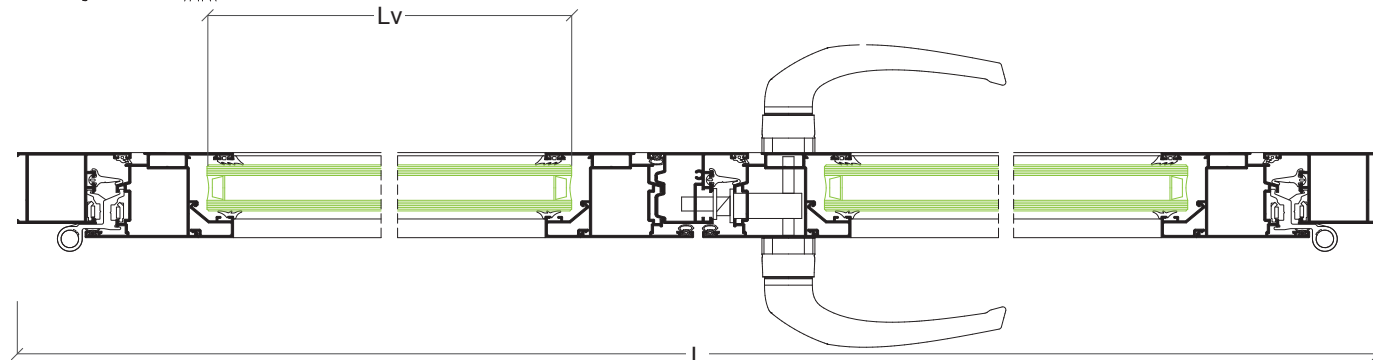
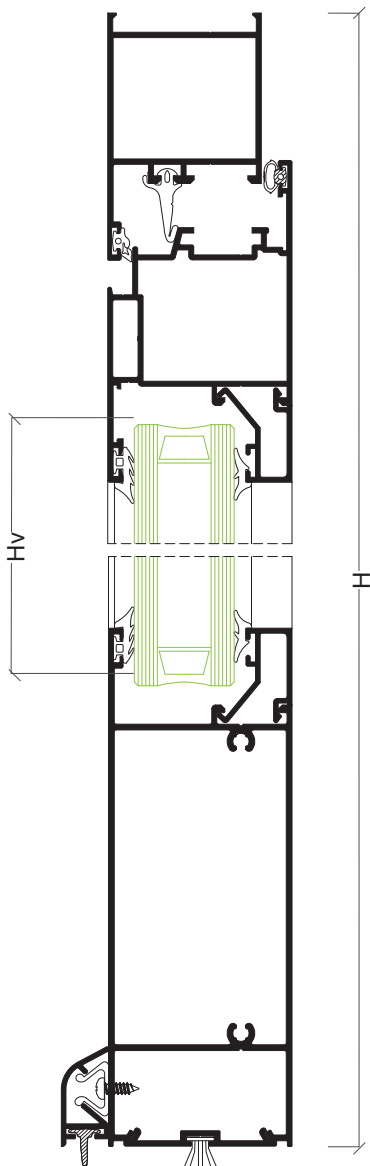
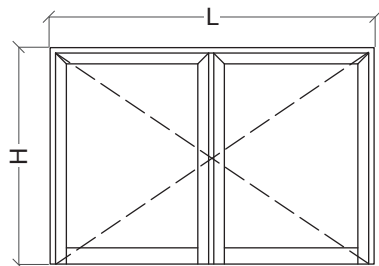

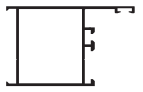

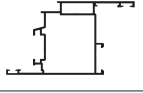

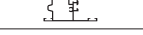
REF.	DESCRIÇÃO • DESCRIPTION	QUANTIDADE • CANTIDAD
30 92 00 20	Dobradiças C.E. • Bisagra C.E.	3
30 92 01 00	Goteiras • Tapa salida de aguas	2
30 92 04 30	Esquadro porta • Escuadra porta	4
30 92 05 10	Fechadura 3 pontos • Fechadura 3 puntos	1
30 92 05 40	Canhão fechadura • Bombillo cierre	1
30 92 05 60	Puxador duplo • Manilla doble	1
30 93 00 50	Junta central • Junta central	1L-2H
30 93 00 90	Junta exterior • Junta exterior	1L-2H
30 93 01 20	Junta interior • Junta interior	1L-2H
30 92 05 00	Jogo topos • Juego topes	1
---	Junta exterior vidro • Junta exterior acristalamiento	2L+2H
---	Junta interior vidro • Junta interior acristalamiento	2L+2H
30 60 16 55	Escudo de alumínio • Espejo de aluminio	2
30 92 05 02	Cantos Vulcanizados • Angulo vulcanizado	2
30 03 40 00	Mola para pingadeira • Grapa para vierteaguas	a cada 150 mm • a cada 150 mm
30 95 00 10	Pelúcia 7x9 mm • Burlete 7x9 mm	L
30 93 00 84	Junta para pingadeira • Junta para goteos	L
30 92 01 35	Esquadro alinhamento • Escuadra alineamiento hoja	4

**VIDRO • VIDRIO**

Hv = H-237 mm	Lv = L-218 mm
---------------	---------------



**Porta 2 folhas • Puerta 2 hojas**

**PERFIS • PERFIS**

DESENHO • DESEÑO	REF.	DESCRIÇÃO • DESCRIPCIÓN	CORTE • CORTE	QUANTIDADE • CANTIDAD	MEDIDAS • MEDIDA
	AZ-11	Aro fixo • Marco		1	L
				2	H
	AZ-62	Aro móvel • Hoja		2	L/2-41 mm
				4	H-44 mm
	AZ-04	Inversor • Inversor		1	H-78 mm
	AZ-77	Almofada • Zócalo		2	L/2-160 mm
	A1-18	Bite remate • Junquillo remate		2	L/2-168 mm
	---	Bite • Junquillo		4	L/2-168 mm
				4	H-263 mm
	AZ-60	Pingadeira • Vierendeaguas puerta		1	L/2-113 mm
				1	L/2-40 mm

**ACESSÓRIOS E JUNTAS • ACCESORIOS Y JUNTAS**

REF.	DESCRIÇÃO • DESCRIPTION	QUANTIDADE • CANTIDAD
30 92 00 20	Dobradiças C.E. • Bisagra C.E.	6
30 03 40 00	Mola para pingadeira • Grapa para vierendeaguas	a cada 150 mm • a cada 150 mm
30 92 01 20	Jogo fecho C.E. • Juego cierre C.E.	1
30 92 03 51	Jogo topos inversor • Juego topos inversor	1
30 92 04 30	Esquadro porta • Escuadra puerta	6
30 92 05 10	Fechadura 3 pontos • Cierre 3 puntos	1
30 92 05 40	Canhão fechadura • Bombillo cierre	1
30 92 05 60	Puxador duplo • Manilla doble	1
30 93 00 50	Junta central • Junta central	1L+3H
30 93 00 90	Junta exterior • Junta exterior	1L+4H
30 93 01 20	Junta interior • Junta interior	1L+4H
30 95 00 10	Pelúcia 7x9 mm • Burlete 7x9 mm	L
---	Junta exterior vidro • Junta exterior acristalamiento	2L+4H
---	Junta interior vidro • Junta interior acristalamiento	2L+4H
30 92 05 00	Jogo topos • Juego topes	1
30 92 05 02	Cantos Vulcanizados • Angulo vulcanizado	2
30 92 01 35	Esquadro alinhamento • Escuadra alineamiento hoja	4
30 60 16 55	Escudo de alumínio • Espejo de aluminio	2
30 93 00 84	Junta para pingadeira • Junta para goteos	L

**VIDRO • VIDRIO**

Hv = H-237 mm	Lv = L/2-183 mm
---------------	-----------------

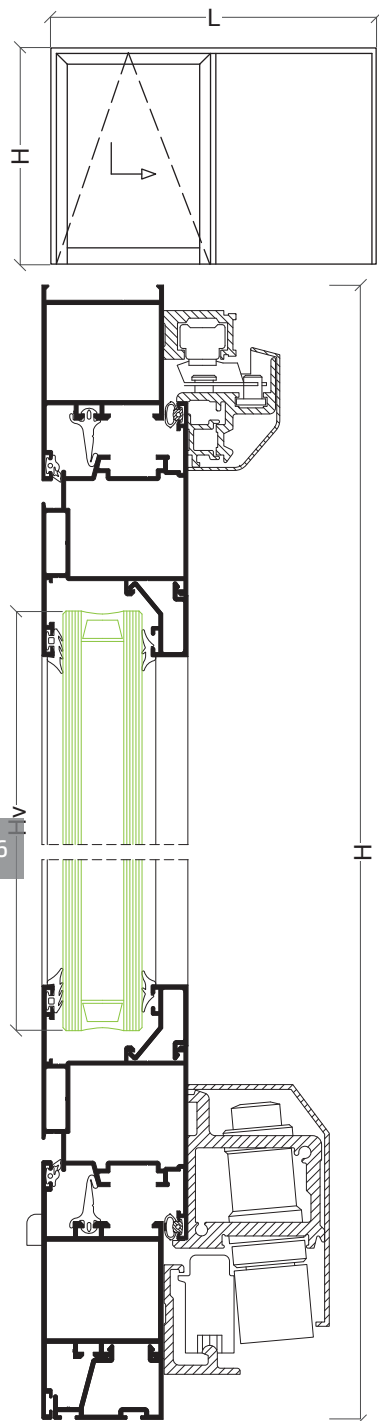
**Porta oscilo-paralela com fixo lateral • Porta oscilo-paralela con fijo lateral**

**PERFIS • PERFIS**

DESENHO • DISEÑO	REF.	DESCRIÇÃO • DESCRIPCIÓN	CORTE • CORTE	QUANTIDADE CANTIDAD	MEDIDAS • MEDIDA
	AZ-11	Aro fixo • Marco		1	L
				2	H
	AZ-62	Aro móvel • Hoja		2	L1-55 mm
				2	H-97.5 mm
	---	Bite (folha) • Junquillo (hoja)		2	L1-183 mm
				2	H-265.5 mm
	---	Bite (fixo) • Junquillo (fijo)		2	L/2 - 87 mm
				2	H-129 mm
	AX-19	Vareta • Pletina falleba		2	Apro. L1 mm
				1+1	Apro. H+H/2 mm
	AZ-09	Travessa • Travesaño		1	L-80 mm
	AX-15	Bite remate • Junquillo remate		1	L-89 mm

**ACESSÓRIOS E JUNTAS • ACCESORIOS Y JUNTAS**

REF.	DESCRIÇÃO • DESCRIPTION	QUANTIDADE • CANTIDAD
30 92 01 00	Goteiras • Tapa salida de aguas	4
30 92 01 50	União topos porta • Unión topos porta	2
30 92 04 30	Esquadro porta • Escuadra porta	6
---	Kit oscilo-paralela • Kit oscilo-paralela	1
30 92 01 35	Esquadro alinhamento • Escuadra alineamiento	8
30 93 00 50	Junta central • Junta central	L+2H
30 93 00 90	Junta exterior • Junta exterior	L+2H
30 93 01 20	Junta interior • Junta interior	L+2H
---	Junta exterior vidro • Junta exterior acristalamiento	2L+4H
---	Junta interior vidro • Junta interior acristalamiento	2L+4H
30 92 05 02	Cantos Vulcanizados • Anquilo vulcanizado	4







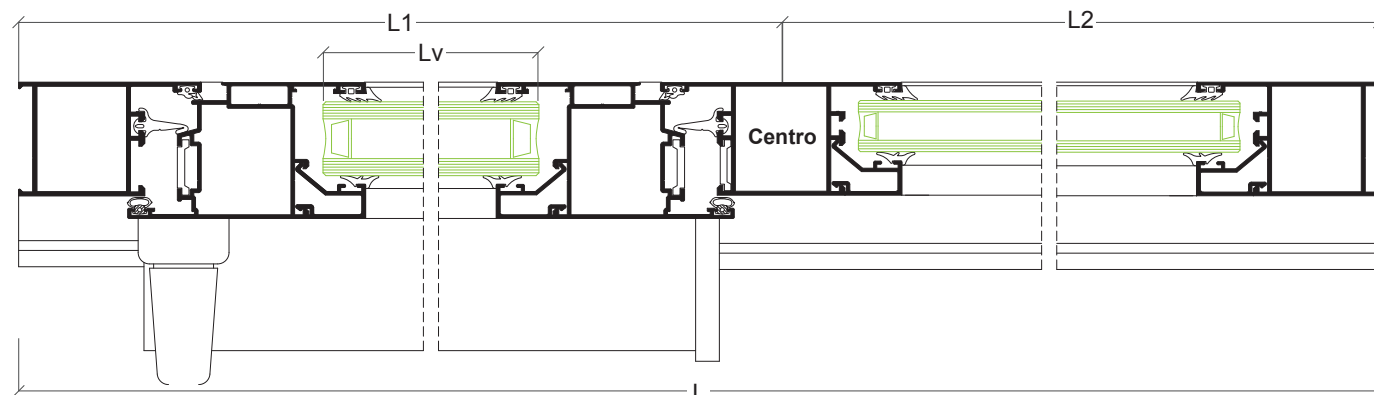

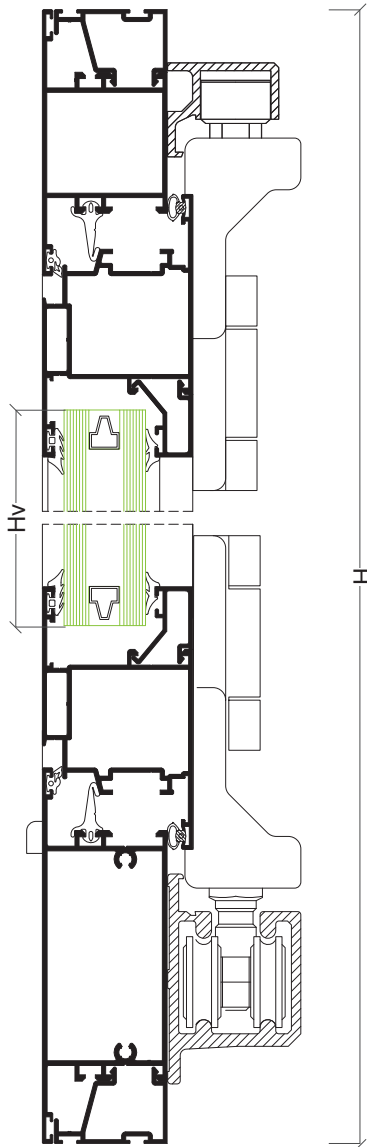
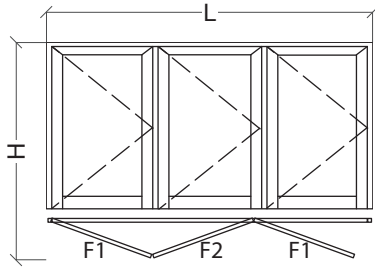

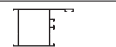

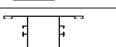



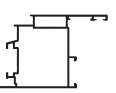





**VIDRO • VIDRIO**

Hv folha = H-239 mm • Hv hoja = H-239 mm	Lv folha = L1-196 mm • Lv hoja = L1-196 mm
Hv fixo = H-103 mm • Hv fijo = H-103 mm	Lv fixo = L2-81 mm • Lv fijo = L2-81 mm
Para vidros iguais L1 = L/2+58 mm • Para acristalamientos iguales L1 = L/2+58 mm	

	Mínimo	Máximo
Largura da folha • Largo de hoja	700 mm	1650 mm
Altura da folha • Alto de hoja	850 mm	2400 mm
Peso máximo por folha 160 kg • Peso máximo por hoja 160 kg		

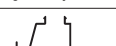

**Porta 3 folhas harmónio • Puerta 3 hojas plegable**

**PERFIS • PERFIS**

DESENHO • DISEÑO	REF.	DESCRIÇÃO • DESCRIPCIÓN	CORTE • CORTE	QUANTIDADE CANTIDAD	MEDIDAS • MEDIDA
	AZ-11	Aro fixo • Marco		2	H
	AZ-09	Travessa • Travesaño		1	L-80 mm
	AZ-12	Travessa • Travesaño		1	L-80 mm
	AZ-62	Aro móvel • Hoja		4	F1 consultar • F1 consultar
				2	F2 consultar • F2 consultar
	AZ-62	Aro móvel • Hoja		6	Consultar • Consultar
				---	Bite • Junquillo
		F2 consultar • F2 consultar			
	AX-19	Vareta • Pletina falleba		1+1	H+H
	AZ-04	Inversor • Inversor		3	consultar • consultar
	---	Bite • Junquillo			consultar • consultar
					consultar • consultar
	AX-15	Bite remate • Junquillo remate		2	L-89 mm

**ACESSÓRIOS E JUNTAS • ACCESORIOS Y JUNTAS**

REF.	DESCRIÇÃO • DESCRIPTION	QUANTIDADE • CANTIDAD
30 92 01 00	Goteiras • Tapa salida de aguas	4
30 92 01 20	Jogo fecho C.E. • Juego cierre C.E.	1
30 92 01 50	União topos porta • Unión topos porta	2
30 92 03 51	Jogo topos inversor • Juego topos inversor	2
30 92 04 30	Esquadro porta • Escuadra puerta	12
---	Kit harmónio (3+0) • Kit plegable (3+0)	1
30 92 01 35	Esquadro alinhamento • Escuadra alineamiento	24
30 93 00 50	Junta central • Junta central	2L+4H
30 93 00 90	Junta exterior • Junta exterior	2L+6H
30 93 01 20	Junta interior • Junta interior	2L+6H
---	Junta exterior vidro • Junta exterior acristalamiento	2L+6H
---	Junta interior vidro • Junta interior acristalamiento	2L+6H
30 92 05 02	Cantos Vulcanizados • Angulo vulcanizado	4

57

**VIDRO • VIDRIO**

	Vidro H1 = consultar Acristalamiento H1 = consultar	Vidro Lv1/Lv2 = consultar Acristalamiento Lv1/Lv2 = consultar
	Mínimo	Máximo
Largura da folha • Largo hoja	600 mm	900 mm
Altura da folha • Alto hoja	850 mm	2400 mm
Peso máximo por folha 80 kg • Peso máximo por hoja 80 kg		

