

www.anicolor.pt

**SISTEMA DE BATENTE
DE CÂMARA EUROPEIA - 45 mm**

**SISTEMA PRACTICABLE
DE CANAL EUROPEO - 45 mm**

AX

 **anicolor**
Sistemas de Alumínio

SISTEMA AX

Sistema de batente de câmara europeia - 45 mm

CARACTERÍSTICAS DO SISTEMA

O sistema AX possibilita a execução de 3 versões de caixilharia:

1. linha recta com câmara europeia com tripla vedação
2. linha curva com câmara europeia com tripla vedação
3. linha Milénio – portas de entradas uso intensivo com dupla vedação

PERFIS DE ALUMÍNIO

Os perfis de alumínio são extrudidos na liga de alumínio 6060 para arquitectura de acordo com norma NP EN 12020-02.

Espessura média dos perfis de alumínio de 1.5 mm para janelas e de 1.7mm / 2mm para portas.

AROS FIXOS

Secção dos aros fixos de 45 mm;

Aros fixos com esquadro para montagem a meia esquadria.

AROS MÓVEIS

Secção dos aros móveis de 45mm ou 53 mm.

Enchimento para vidro simples ou duplo desde 4 mm até 30 mm.

Aros móveis de linha recta ou curva ou coplanar para linha Milénio.

Aro móvel com esquadro para montagem a meia esquadria.

DIMENSIONAMENTO E MANOBRABILIDADE

Dimensões mínimas - máximas de folha: 375 mm - 1700 mm (L); 410 mm - 2700 mm (H).

Dimensões mínimas - máximas de folha (Milénio): 400 mm - 1500 mm (L); 600 mm - 3000 mm (H).

Peso máximo de 110 kg por folha com oscilo-batente.

Peso máximo de 90 kg por folha para janelas de abrir.

Peso máximo de 180 kg por folha com dobradiça porta.

Possibilidades de abertura: interior com ou sem oscilo-batente com micro-ventilação, exterior, basculante, projectante, pivotante, harmónico e oscilo-paralela.

Portas Milénio para abertura interior, exterior, vaivém e com opção de sistema anti-entaldamento de dedos.

4 PERFORMANCES

Sistema certificado por laboratório credenciado, notificado para Ensaio Tipo Inicial (ITT) de acordo com a norma de produto EN 14351-1:2006+A2:2016 para efeitos de Marcação CE.

Categorias alcançadas na avaliação do sistema AX tipologia janela:

1. Permeabilidade ao ar: Classe 4 (norma de ensaio EN 10207 e EN 1026)
2. Estanquidade à água: Classe E900 (norma de ensaio EN 12208 e EN 1027)
3. Resistência ao vento: Classe C5 (norma de ensaio EN 12210 e EN 12211)

Categorias alcançadas na avaliação do sistema AX tipologia porta:

1. Permeabilidade ao ar: Classe 4 (norma de ensaio EN 10207 e EN 1026)
2. Estanquidade à água: Classe 7A (norma de ensaio EN 12208 e EN 1027)
3. Resistência ao vento: Classe C2 (norma de ensaio EN 12210 e EN 12211)

Categorias alcançadas na avaliação do sistema Milénio tipologia porta de 2 folhas:

1. Permeabilidade ao ar: Classe 2 (norma de ensaio EN 10207 e EN 1026)
2. Estanquidade à água: NPD (norma de ensaio EN 12208 e EN 1027)
3. Resistência ao vento: Classe C3 (norma de ensaio EN 12210 e EN 12211)
4. Resistência ao impacto: Classe 5 (norma de ensaio EN 13049)

Coefficiente de transmissão térmica de janela de 2 folhas com 1.20 m x 1.50 m com vidro Ug = 1.4 W/m²K; Uw = 2.92 W/m²K

Coefficiente de atenuação acústica de janela de 2 folhas com vidro 5/14/5: Rw (C; Ctr) = 36 dB (-2; -5)

Coefficiente de transmissão térmica de porta Milénio de 2 folhas com 1.80 m x 2.20 m com vidro Ug = 1.4 W/m²K; Uw = 3.12 W/m²K

Coefficiente de atenuação acústica de porta Milénio de 2 folhas com vidro laminado: Rw (C; Ctr) = 37 dB (-1; -4)

Zonas de aplicação segundo os regulamentos REH e RECS (em função do valor Ug): I1, I2, I3, V1, V2, V3.

SISTEMA AX

Sistema practicable de canal europeo - 45 mm

CARACTERÍSTICAS DEL SISTEMA

El sistema AX permite la ejecución de 3 versiones de marcos:

1. línea recta con cámara europea con triple sello
2. Línea curva de cámara europea con triple sello
3. Línea Milénio - puertas de entrada de uso intensivo con doble junta

PERFILES DE ALUMINIO

Los perfiles de aluminio están extrudidos en la aleación de aluminio 6060 para arquitectura según la norma NP EN 12020-02.

Espesor medio de los perfiles de aluminio de 1,5 mm para ventanas y 1,7 mm / 2 mm para puertas.

ANILLOS FIJOS

Sección de llanta fija de 45 mm;

Marcos fijos con escuadra para montaje a inglete.

ANILLOS MÓVILES

Sección de anillos móviles de 45 mm o 53 mm.

Relleno para vidrio simple o doble de 4 mm a 30 mm.

Aros móviles de línea recta o curva o coplanar para línea Milénio.

Marco móvil con escuadra para montaje de inglete.

TAMAÑO Y MANIOBRABILIDAD

Dimensiones mínimas - hojas máximas: 375 mm - 1700 mm (W); 410 mm - 2700 mm (alto).

Dimensiones mínimas - hojas máximas (Millennium): 400 mm - 1500 mm (L); 600 mm - 3000 mm (alto).

Peso máximo de 110 kg por hoja con tope de giro.

Peso máximo de 90 kg por hoja para apertura de ventanas.

Peso máximo de 180 kg por hoja con bisagra de puerta.

Possibilidades de abertura: interior con o sin tope oscilante con microventilación, exterior, basculante, saliente, pivotante, armónico y oscilante pewartalelo.

Puertas Millennium para interior, exterior, apertura recíproca y con opción de sistema anti-pelliczo.

PRESTACIONES

Sistema certificado por un laboratorio acreditado, notificado para Pruebas Iniciales de Tipo (ITT) según la norma de producto EN 14351-1: 2006 + A2: 2016 a los efectos del Marcado CE.

2. Estanquidad al agua: Clase E900 (prueba estándar EN 12208 y EN 1027)
3. Resistencia al viento: Clase C5

Categorías logradas en la evaluación de la ventana de tipología del sistema AX:

1. Permeabilidad al aire: Clase 4 (norma de prueba EN 10207 y EN 1026)
2. Estanquidad al agua: Clase E900 (prueba estándar EN 12208 y EN 1027)
3. Resistencia al viento: Clase C5 (norma de prueba EN 12210 y EN 12211)

Categorías logradas en la evaluación del sistema de tipología de puertas AX:

1. Permeabilidad al aire: Clase 4 (norma de prueba EN 10207 y EN 1026)
2. Estanquidad al agua: Clase 7A (prueba estándar EN 12208 y EN 1027)
3. Resistencia al viento: Clase C2 (prueba estándar EN 12210 y EN 12211)

Categorías alcanzadas en la evaluación de la tipología del sistema Millennium puerta 2 hojas:

1. Permeabilidad al aire: Clase 2 (norma de prueba EN 10207 y EN 1026)
2. Estanquidad al agua: NPD (prueba estándar EN 12208 y EN 1027)
3. Resistencia al viento: Clase C3 (norma de prueba EN 12210 y EN 12211)
4. Resistencia al impacto: Clase 5 (norma de prueba EN 13049)

Coefficiente de transmisión térmica de ventana de 2 hojas con 1,20 m x 1,50 m con vidrio Ug = 1,4 W / m²K; Uw = 2,92 W / m²K

Coefficiente de atenuación de sonido de ventana de 2 ventanas con vidrio 5/14/5: Rw (C; Ctr) = 36 dB (-2; -5)

Coefficiente de transferencia térmica de puerta Millennium de 2 hojas con 1,80 m x 2,20 m con vidrio Ug = 1,4 W / m²K; Uw = 3,12 W / m²K

Coefficiente de atenuación acústica de puerta Millennium de 2 hojas con vidrio laminado: Rw (C; Ctr) = 37 dB (-1; -4)

Campos de aplicación según normativa REH y RECS (en función del valor Ug): I1, I2, I3, V1, V2, V3.

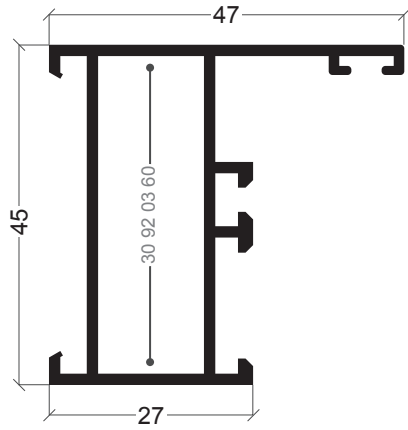

AX-03

Aro fixo
Marco ventana

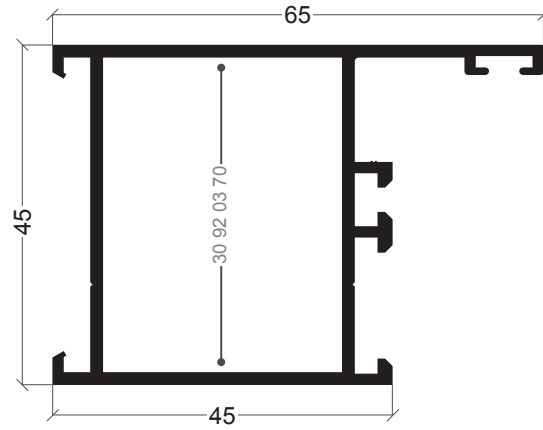

AX-08

Aro fixo
Marco puerta

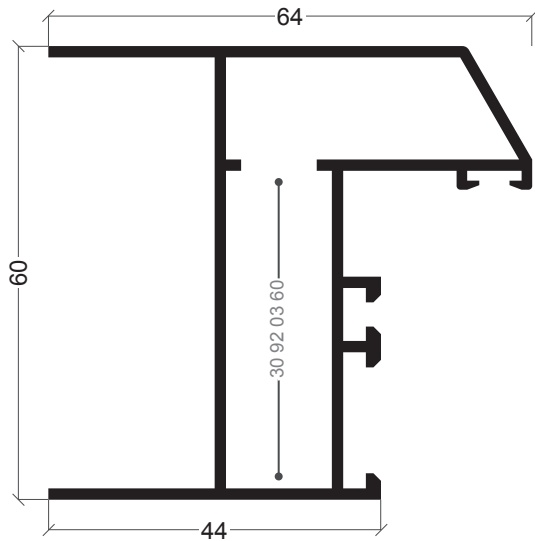

AX-14

Aro fixo
Marco puerta

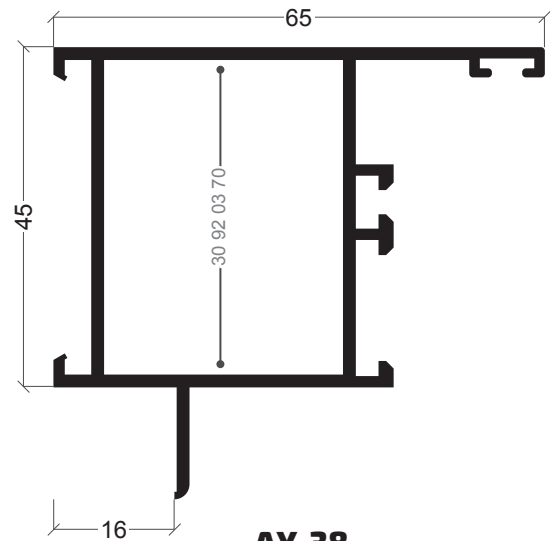

AX-38

Aro fixo para apainelado
Marco puerta con precerco

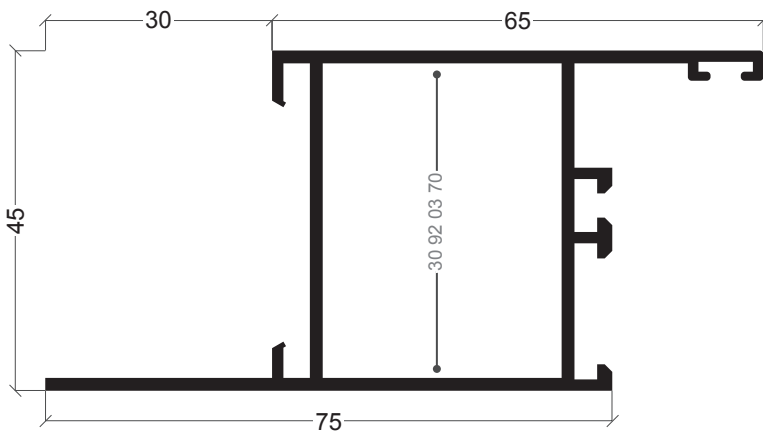

AX-41

Aro fixo com remate
Marco puerta con solape

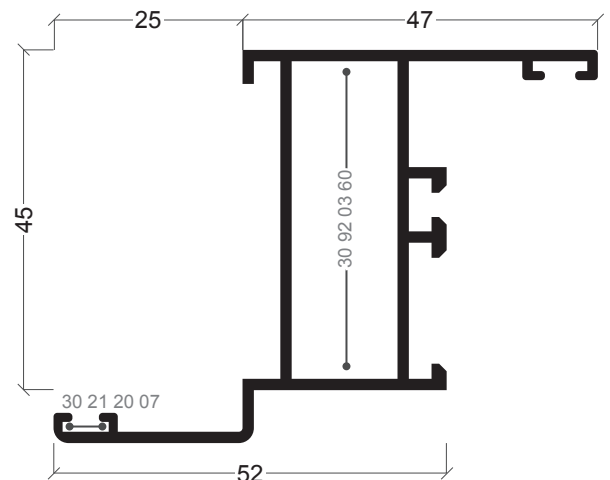

AX-26

Aro fixo com remate
Marco ventana con solape

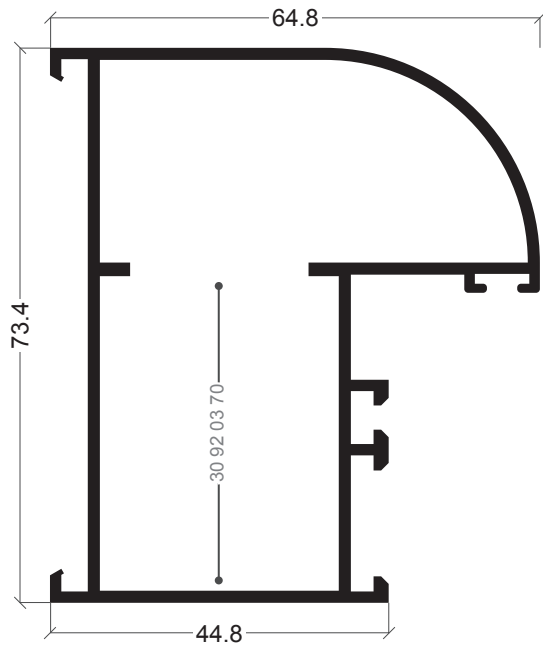

AX-52

Aro fixo com reforço
Marco com escarpate

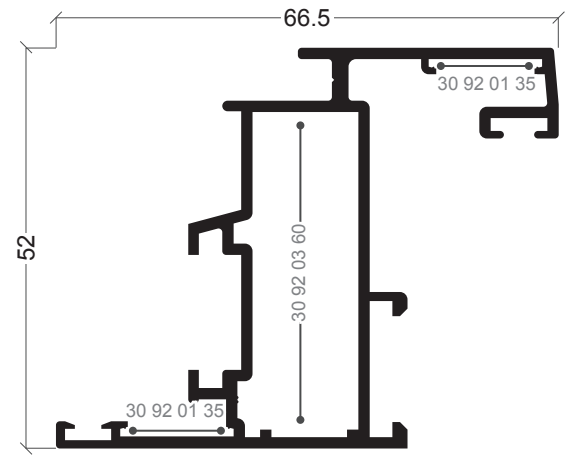

AX-02

Aro móvel
Hoja ventana

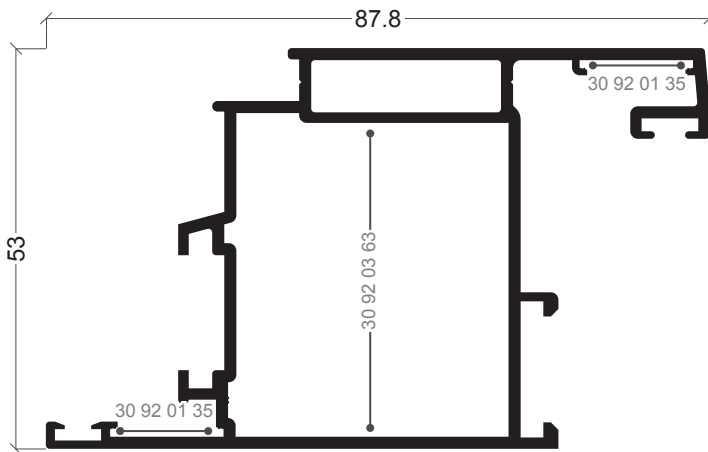

AX-07

Aro móvel
Hoja puerta

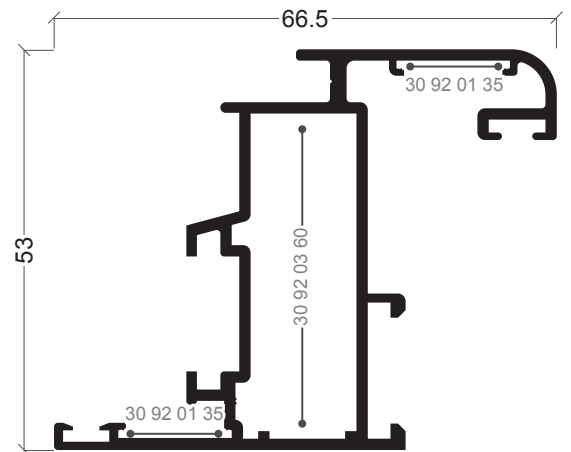

AX-05

Aro móvel
Hoja ventana

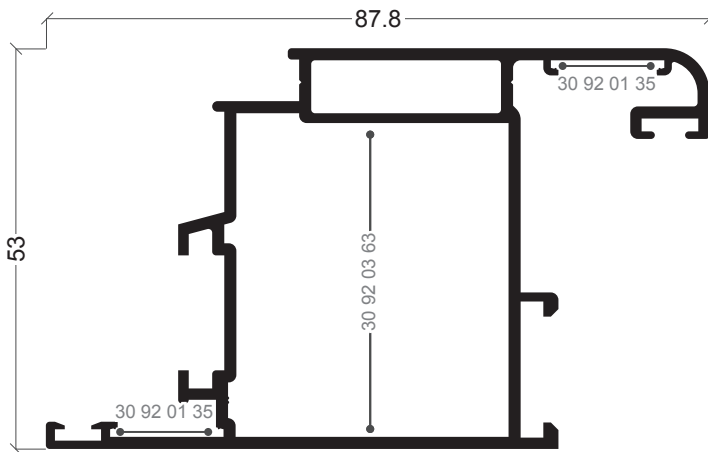

AX-10

Aro móvel
Hoja puerta

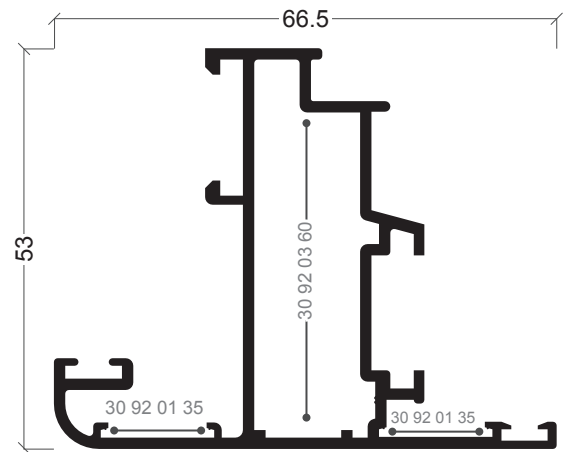

AX-04

Aro móvel
Hoja ventana

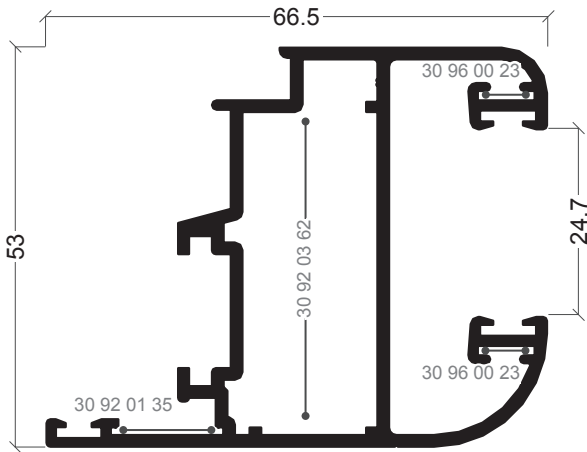

AX-53

Aro móvel
Hoja ventana sin junquillo

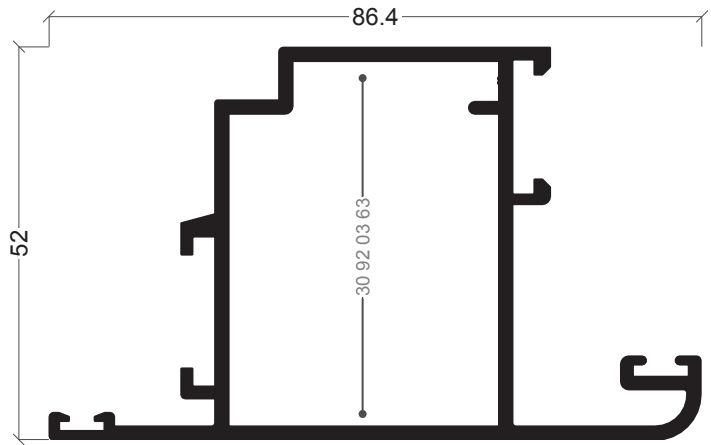

AX-09

Aro móvel abertura exterior
Hoja puerta abertura exterior

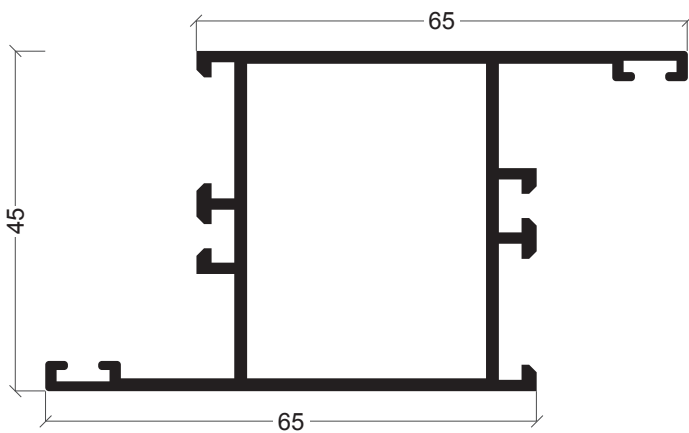

AX-47

Aro abertura exterior com fixo
Marco abertura exterior con fijo

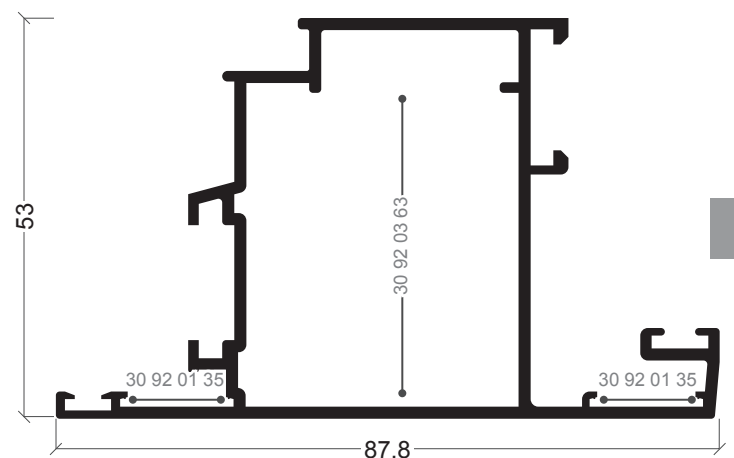

AX-06

Aro móvel abertura exterior
Hoja abertura exterior

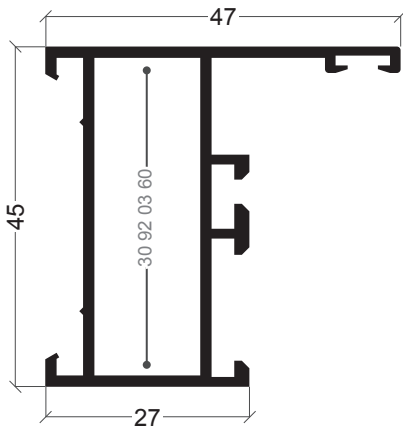

AX-51

Aro fixo pivotante
Marco pivotante

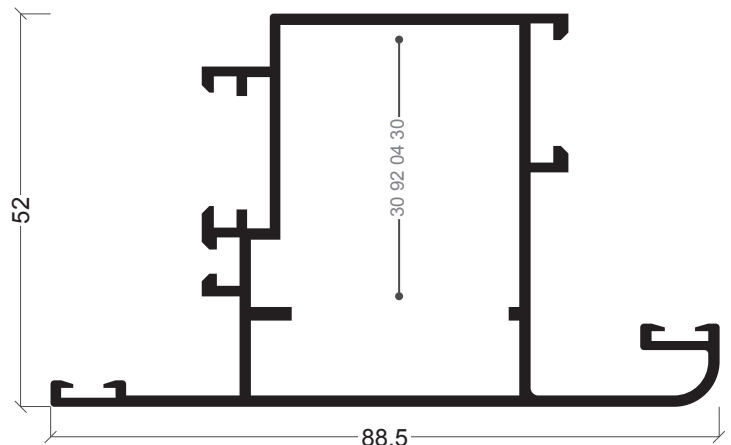

AX-54

Aro móvel pivotante
Hoja pivotante

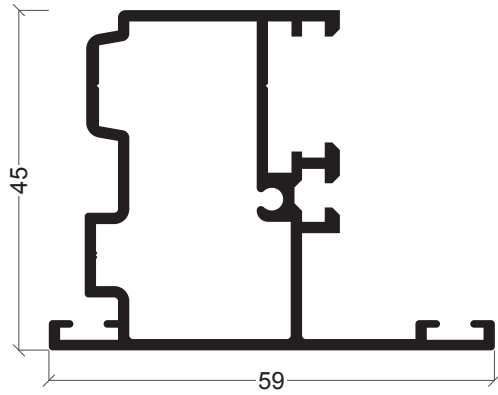

AX-11

Inversor
Inversor

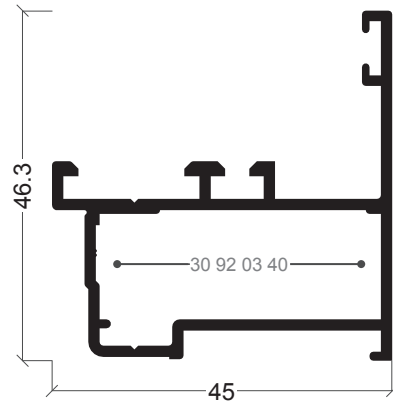

AX-79

Inversor sentido de abertura
Inversor apertura exterior

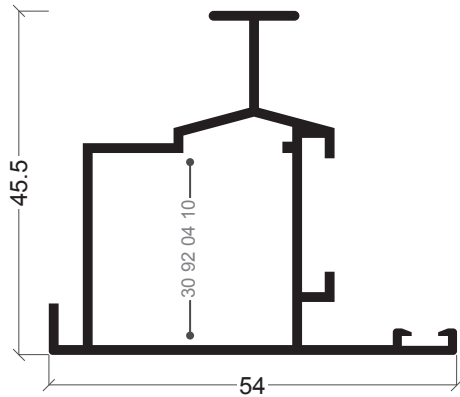

AX-55

Inversor pivotante
Inversor apertura pivotante

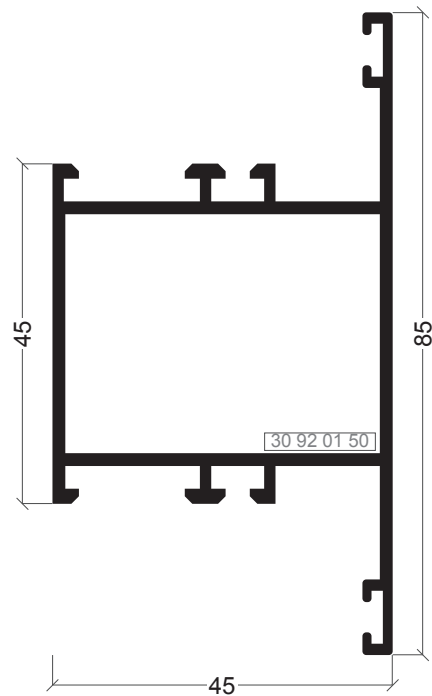

AX-28

Travessa
Travesaño puerta

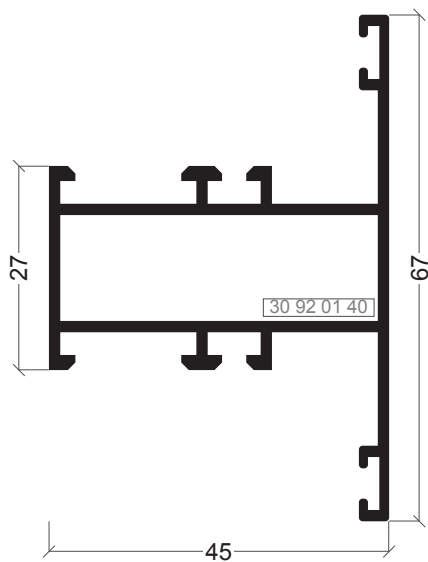

AX-01

Travessa
Travesaño ventana

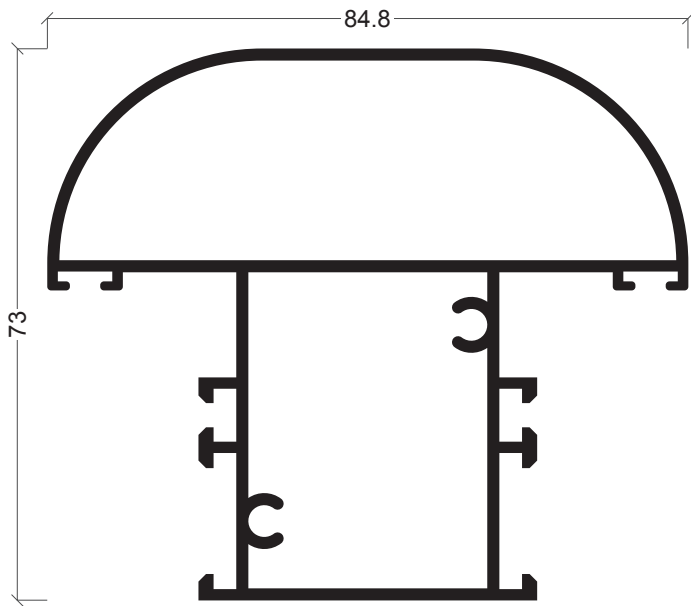

AX-56

Travessa com reforço
Zanca de escapearate

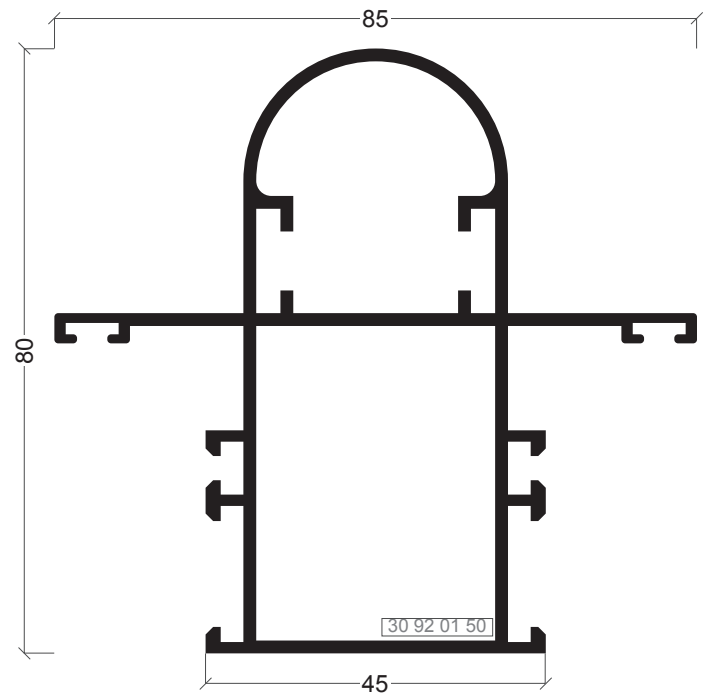

AX-24

Montante/ Travessa
Rigizador 80mm curvo

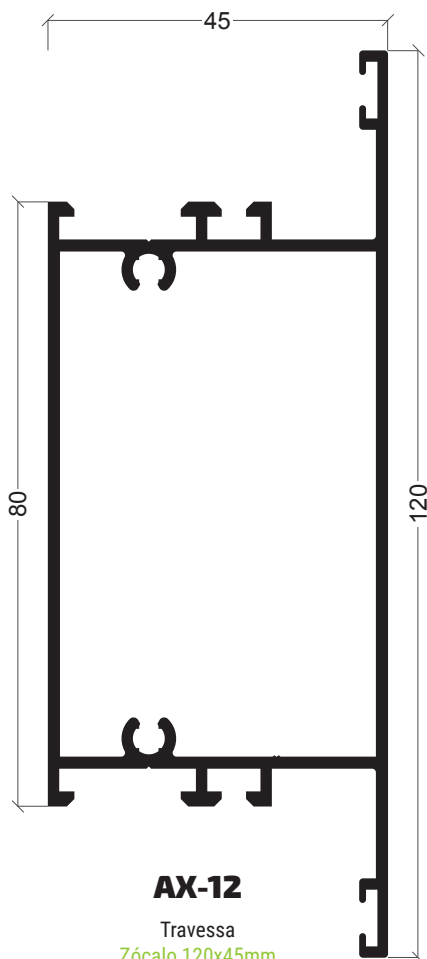

AX-12

Travessa
Zócalo 120x45mm

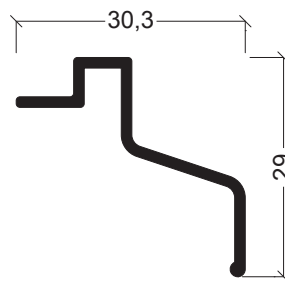

AXi-45

Pingadeira
Vierteaguas

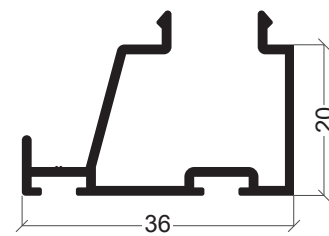

AX-15

Bite remate
Junquillo acople

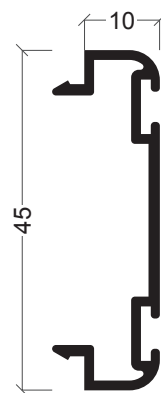

AX-42

Complemento vaivém
Complemento para vaivém

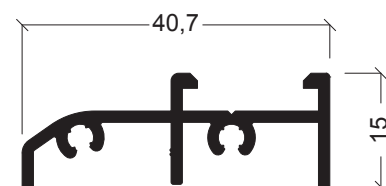

AX-83

Soleira
Acople inferior

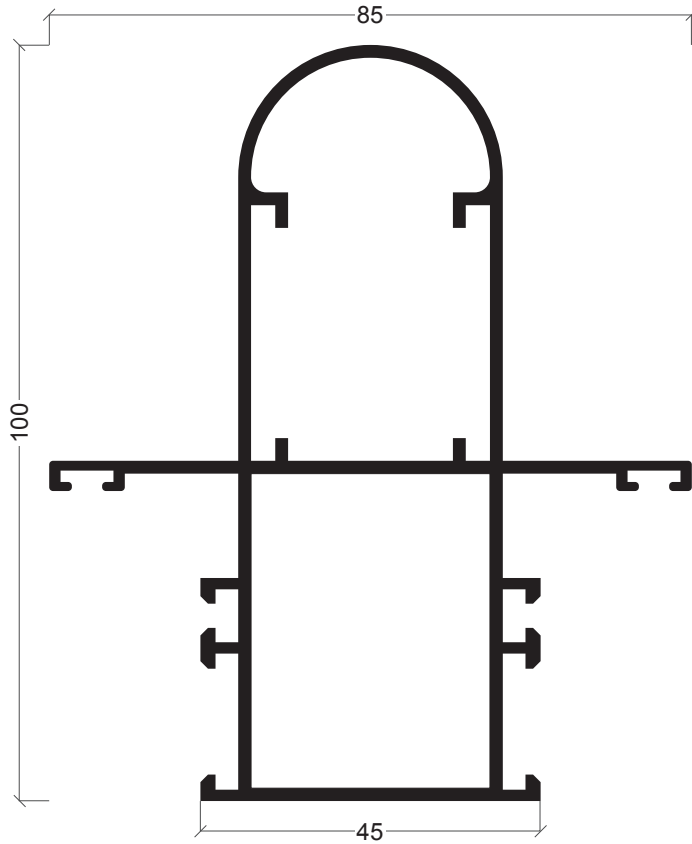

AX-25

Montante
Rigidizador 100m curvo

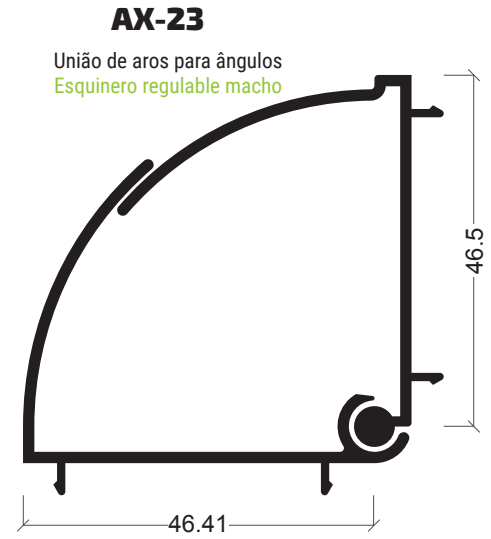

AX-23

União de aros para ângulos
Esquinero regulable macho

AX-22

União de aros para ângulos
Esquinero regulable hembra

10

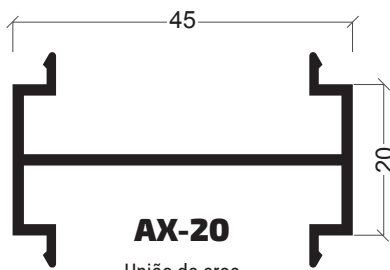

AX-20

União de aros
Unión de marcos



AX-19

Vareta
Pletina falleba

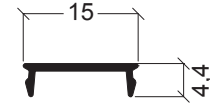

KL-04

Tampa
Tapa

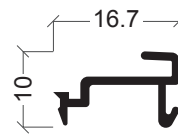

AX-33

Mola bite
Grapa junquillo



CT-94

Perfil de união
Perfil de unión

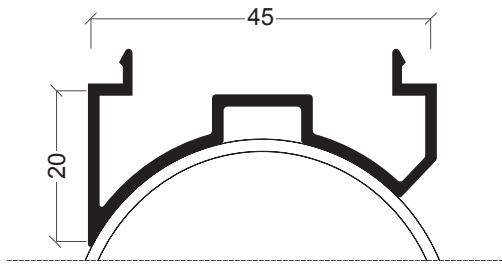

CP-16

Ângulo com tubo 50 mm
Acople a tubo 50 mm

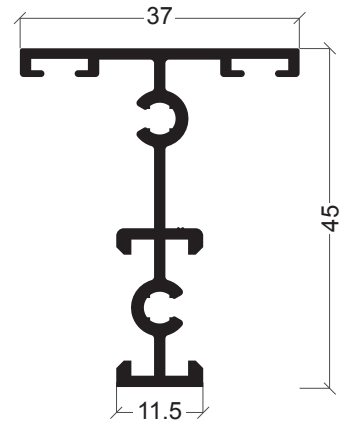

AX-57

Divisor de vidro
Divisor vidro

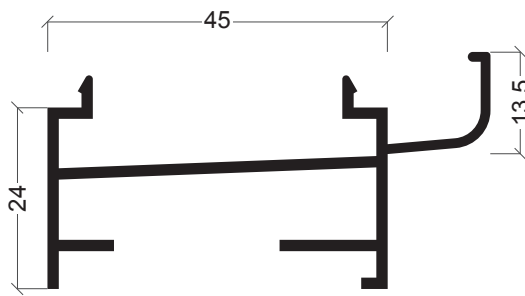

AX-58

Soleira condensação
Condensación

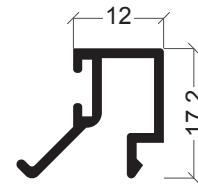

AX-70

Bite para AX-57
Junquillo para AX-57

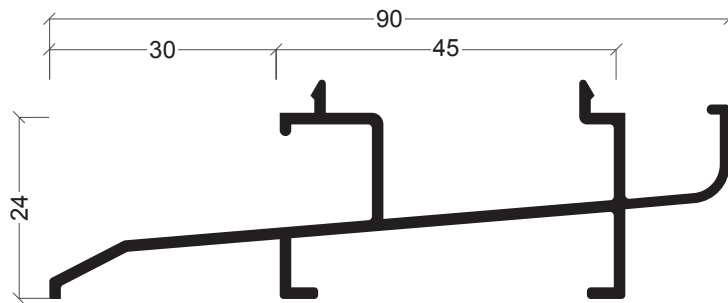

AX-17

Soleira condensação
Condensación con alargadera

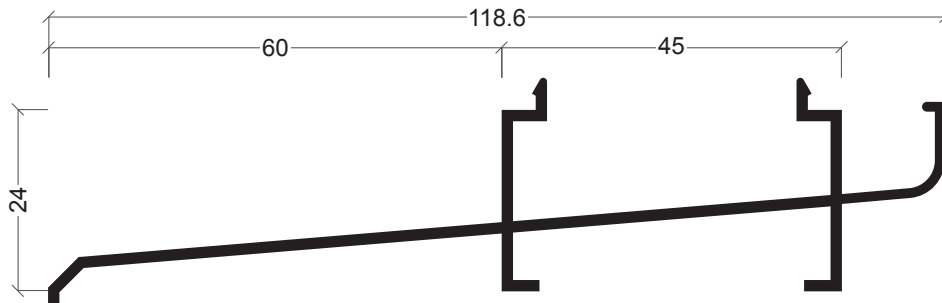

AX-18

Soleira condensação
Condensación con alargadera

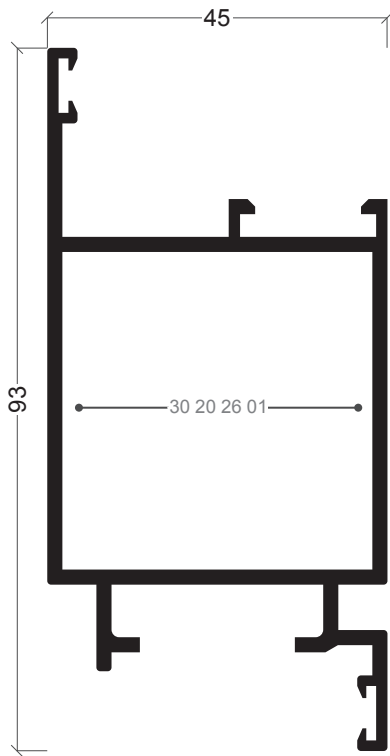

AX-65
Aro móvel
Hoja puerta

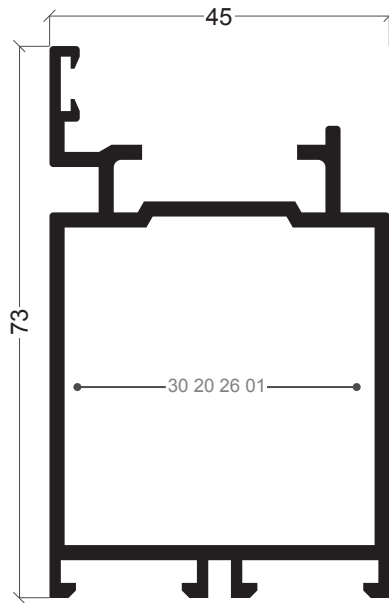

AX-64
Aro fixo
Marco puerta

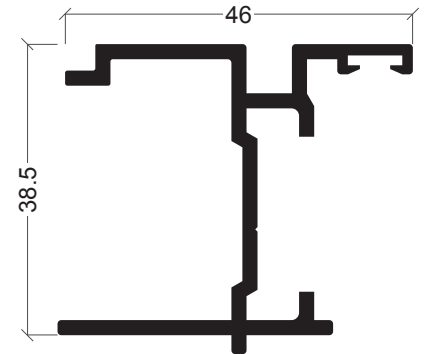

AX-62
Suplemento abertura exterior
Suplemento apertura exterior

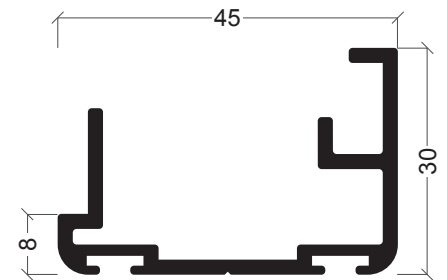

AX-71
Suplemento vaivém
Acople vaivém

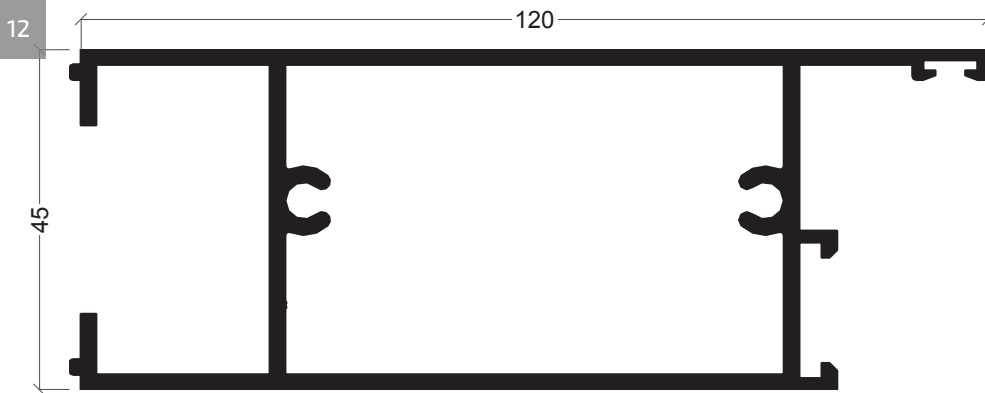

AX-68
Almofada
Zócalo inferior

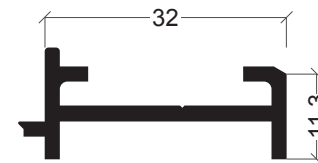

AX-61
Suplemento abertura interior
Suplemento apertura interior

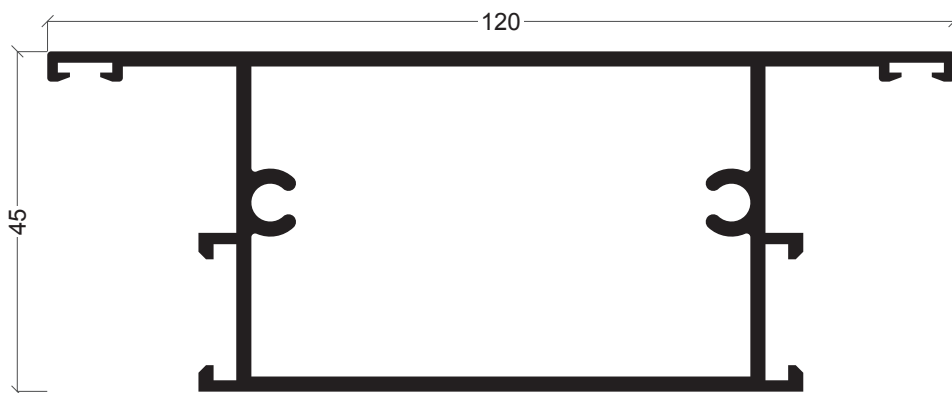

AX-67
Travessa
Zócalo 120x45mm



AX-63
Remate pavimento
Remate al pavimento

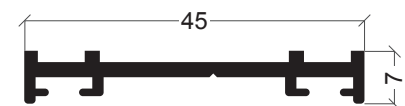

AX-60
Vedação inferior
Acople zócalo inferior

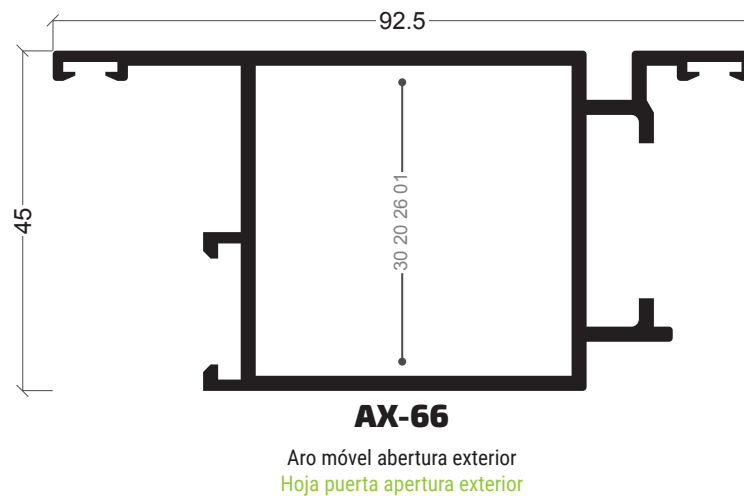
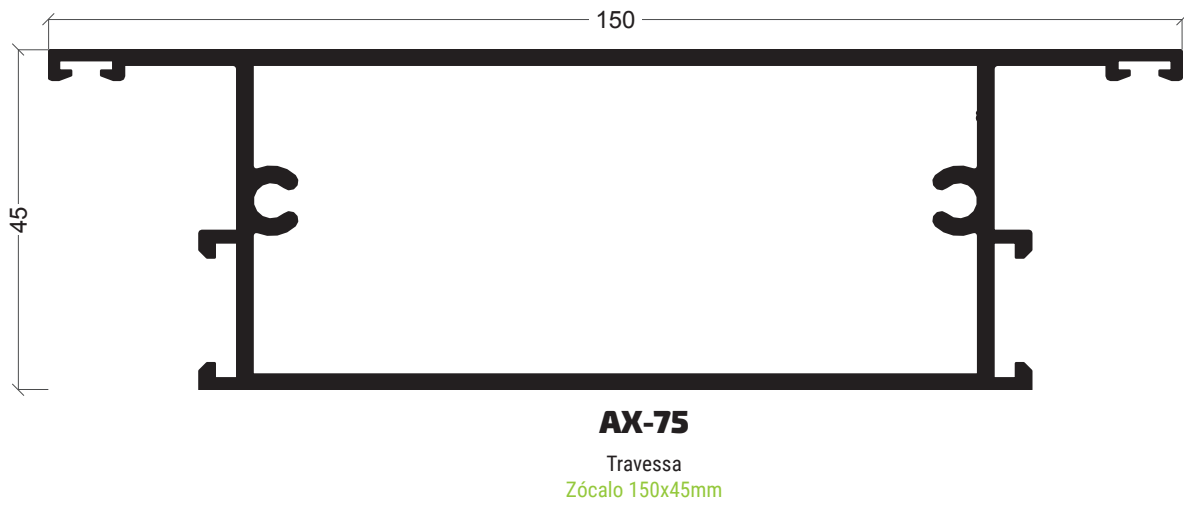
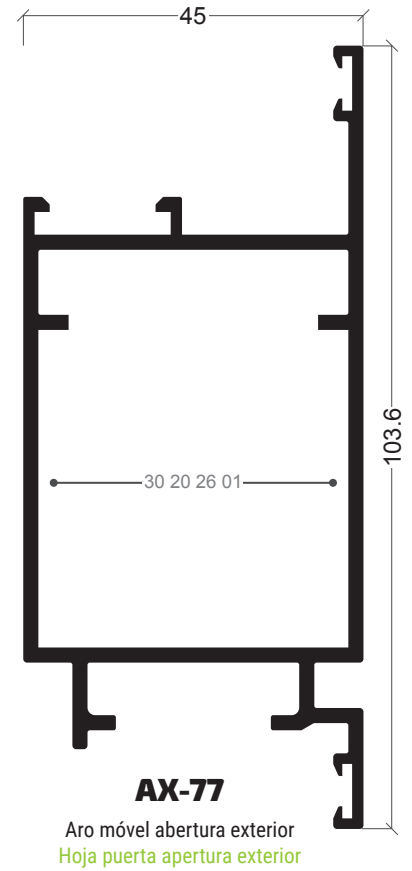
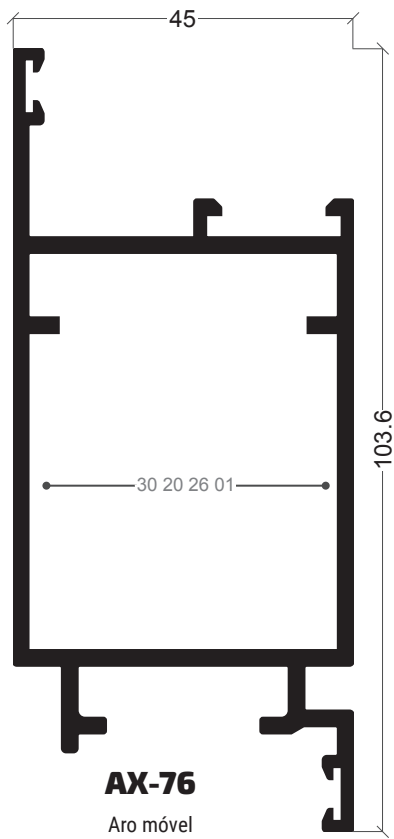

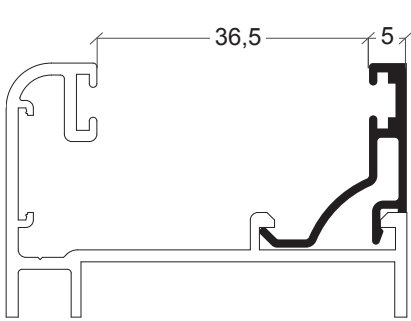

AX-82

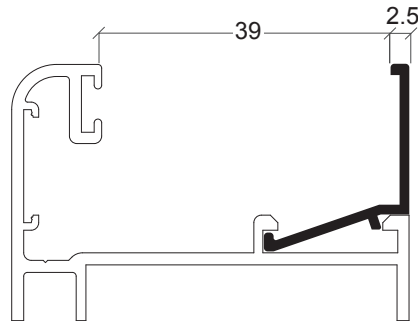

AX-69

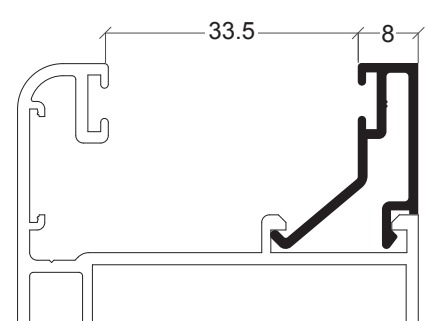

AX-74

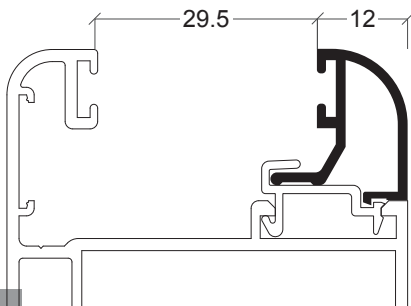

AX-37

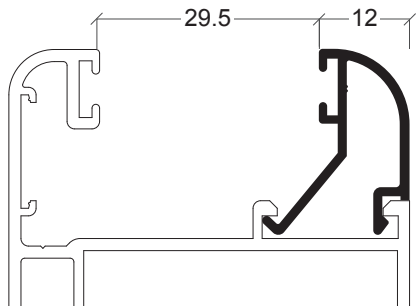

AZ-08

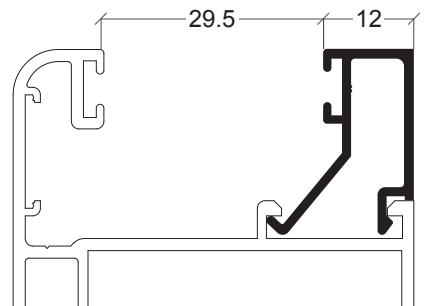

AX-36

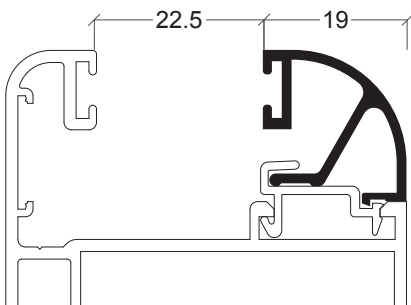

AX-30

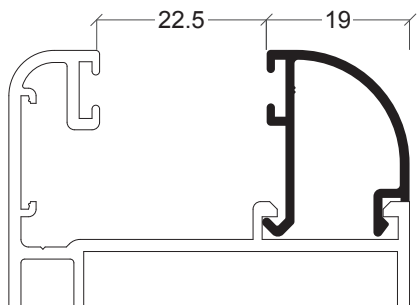

AZ-07

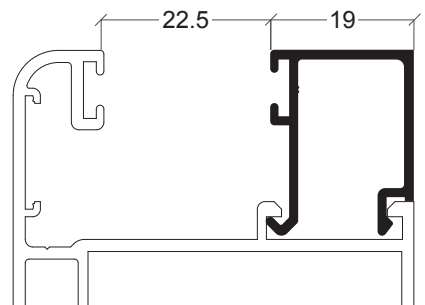

AX-35

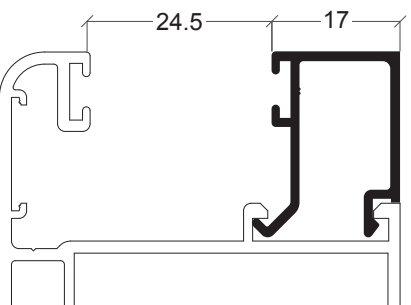

AX-46

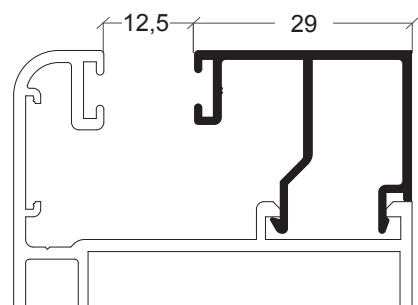

AX-81

14

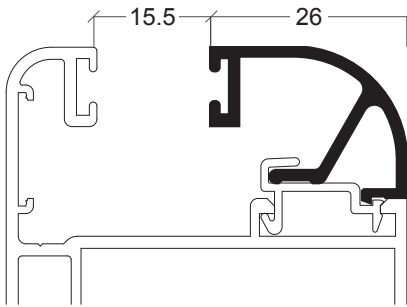

AX-29

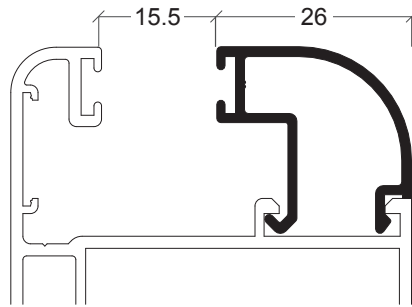

AZ-06

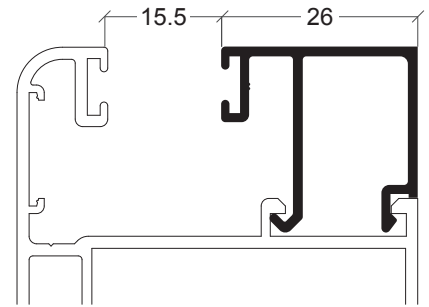

AX-31

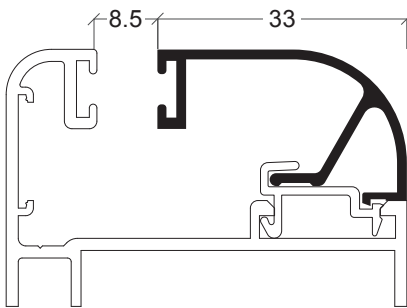

AX-39

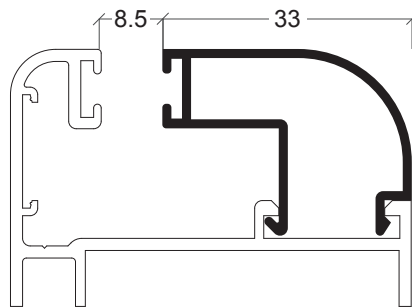

AZ-28

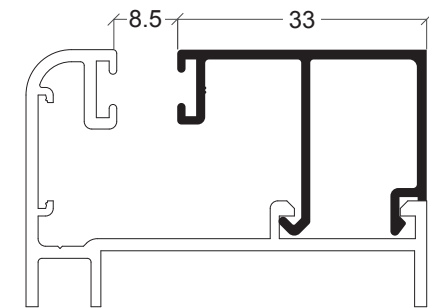

AX-34

15

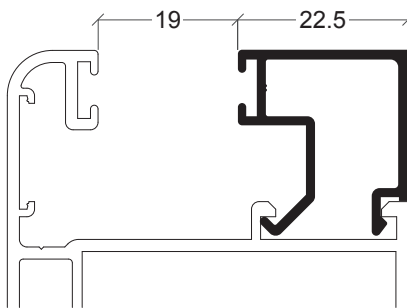

AX-78

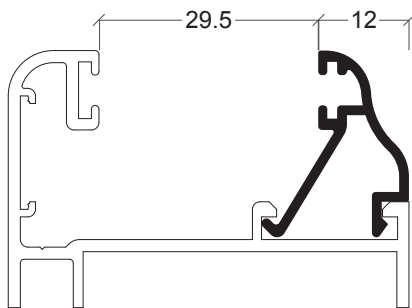

AX-73

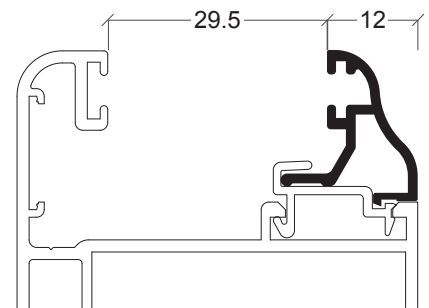

AX-72

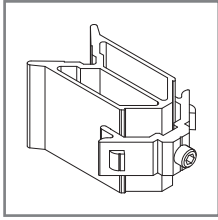

30 20 26 01

Esquadro porta milénio
Escuadra puerta milénio

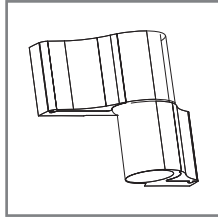

30 20 26 02/06

Dobradiça abas desiguais branca/preta
Bisagra cuerpos desiguales blanca/negra

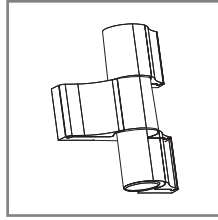

30 20 26 05/07

Dobradiças 3 abas desiguais branco/preto
Bisagras 3 cuerpos desiguales blanco/negro

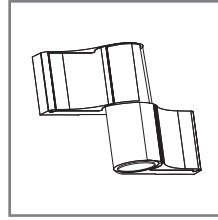

30 20 26 09/12

Dobradiça abas iguais preta/branca
Bisagra cuerpos iguales negra/blanca

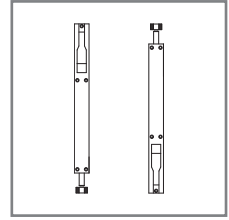

30 20 26 10/11

Fecho 2ª folha pequeno/grande
Cierre 2ª hoja pequeno/grande

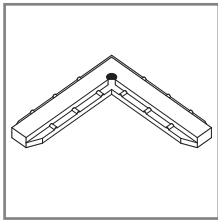

30 21 20 07

Esquadro de alinhamento
Escuadra de alineamiento

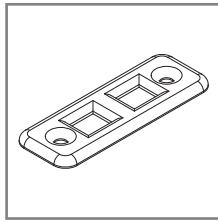

30 24 30 75

Contra-fecho duplo inferior inox
Cerradero doble inferior inox

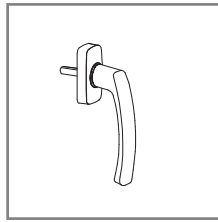

30 60 16 40/41/42

Puxador de Alumínio branco/preto/2AC
Manilla de Alumínio branco/negro/2AC

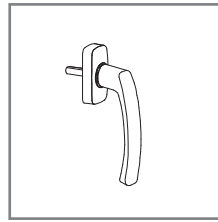

30 60 16 43/44

Puxador de Alumínio Champ AC/Inox AC
Manilla de Alumínio Champ AC/Inox AC

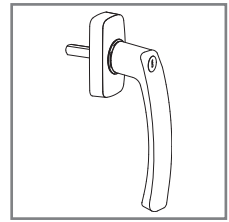

30 60 16 47/48

Puxador de alumínio com chave 2 ac/
champ ac
Manilla de aluminio con llave 2 ac/champ ac

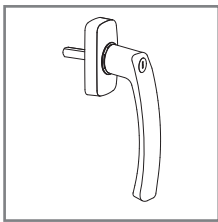

30 60 16 49

Puxador de alumínio com chave inox ac
Manilla de aluminio con llave inox ac

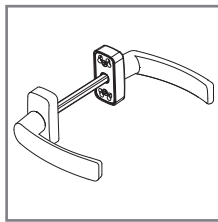

30 60 16 50/51

Puxador duplo de alumínio branco/preto
Manilla doble de aluminio blanco/negro

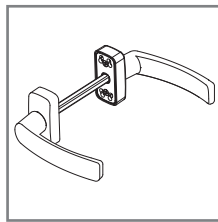

30 60 16 52/53

Puxador duplo de alumínio 2 ac/champ ac
Manilla doble de aluminio 2 ac/champ ac

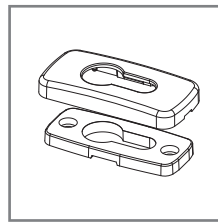

30 60 16 55/56/57

Escudo de alumínio
Escudo de alumínio

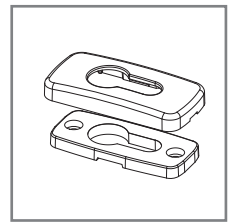

30 60 16 58/59

Escudo de alumínio
Escudo de alumínio

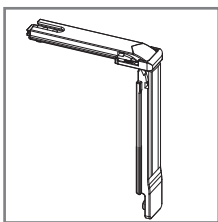

30 90 20 42

Ângulo de Reenvio
Angulo de Reenvio

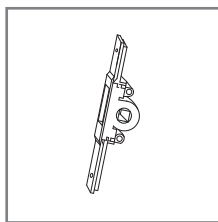

30 90 20 44

Transmissão para Abertura Exterior
Trasmisión para Apertura Exterior

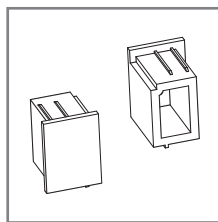

30 91 21 20

Jogo topos condensação Y-20
Juego topes condensación Y-20

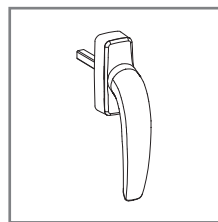

30 91 41 47/48

Cremone Multiponto branco/preto
Cremone Multipunto blanco/negro

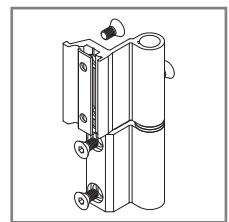

30 92 00 20/21

Dobradiça C.E. branco/preto
Bisagra C.E. blanco/negro

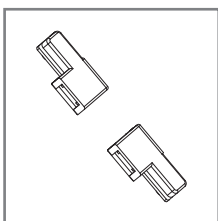

30 92 00 30

Transmissão barra cremone
Trasmisión barra cremone

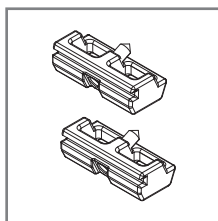

30 92 00 50

Complemento fecho
Complemento cierre

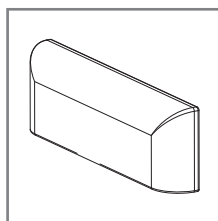

30 92 01 00/01

Goteiras branco/preto
Tapa salida de aguas blanco/negro

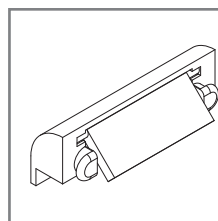

30 92 01 02/03

Goteira c/valvula preto/branco
Goteo c/valvula negro/blanco

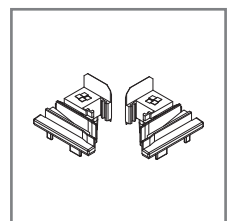

30 92 01 13

Jogo topos inversor com furo
Juego topes inversor con agujero

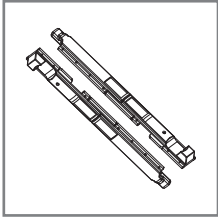

30 92 01 20

Jogo fecho C.E.
Juego cierre C.E.

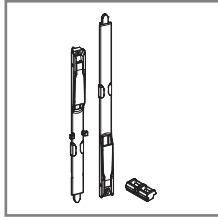

30 92 01 21

Jogo fecho C.E.
Juego cierre C.E.

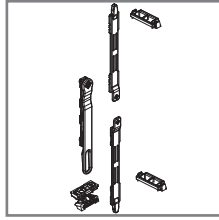

30 92 01 23

Jogo Passadores Bidirecional CE
Juego Passadores Bidirecional CE

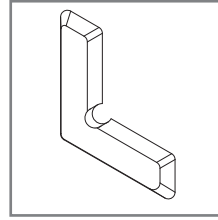

30 92 01 35

Esquadro alinhamento aro móvel
Escuadra alineamiento hoja

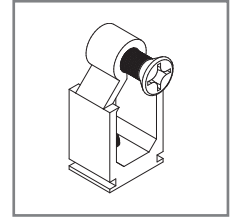

30 92 01 40

União topos janela
Unión topos ventana

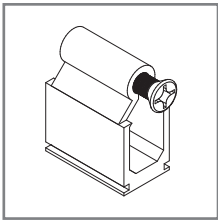

30 92 01 50

União topos porta
Unión topos puerta

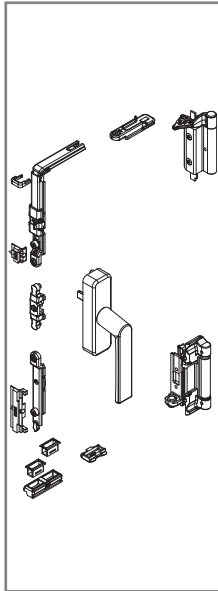

30 92 02 20/21

Kit oscilobatente branco/preto
Kit oscilobatente blanco/negro

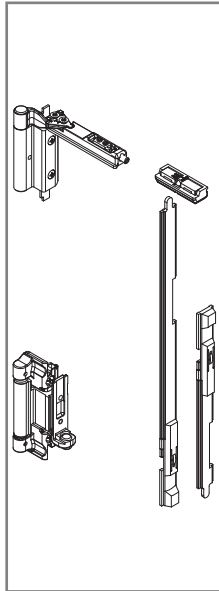

30 92 02 24/25

Kit 2ª folha oscilobatente branco/preto
Kit 2ª hoja oscilobatente blanco/negro

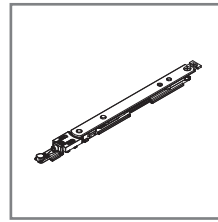

30 92 02 10/11/12

Compasso oscilo 300/400/500
Compás oscilo 300/400/500

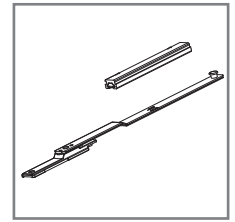

30 92 02 13

Compasso suplementar OB
Compasso suplementar OB

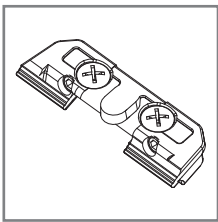

30 92 02 15

Fecho para micro-ventilação
Cierre para microventilación

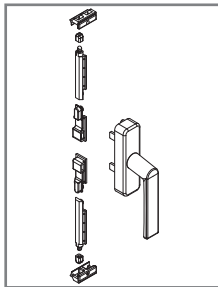

30 92 03 10

Kit cremone branco/preto
Kit cremona blanco/negro

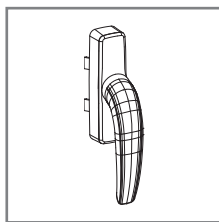

30 92 03 20/21

Cremone abertura exterior branco/preto
Cremona abertura exterior blanco/negro

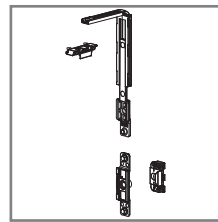

30 92 02 45

Kit fecho vertical 3º ponto
Kit cierre vertical 3º punto

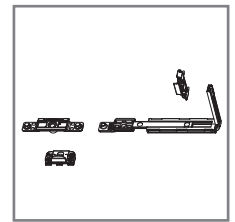

30 92 02 47

Kit fecho horizontal 3º ponto
Kit cierre horizontal 3º punto

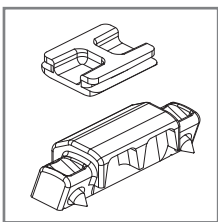

30 92 02 60

Apoio da folha
Apoyo hoja

30 92 03 10

Kit cremone branco/preto
Kit cremona blanco/negro

30 92 03 20/21

Cremone abertura exterior branco/preto
Cremona abertura exterior blanco/negro

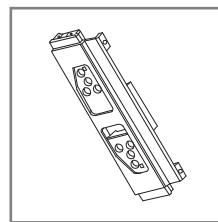

30 92 03 30

Jogo transmissão abertura exterior
Juego transmisión abertura exterior

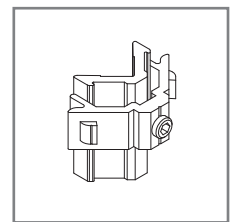

30 92 03 40

Esquadro janela
Escuadra ventana

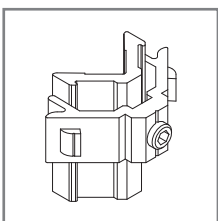

30 92 03 60

Esquadro janela
Escuadra ventana

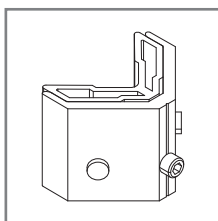

30 92 03 62

Esquadro aro móvel AX-53
Escuadra AX-53

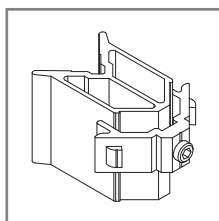

30 92 03 63

Esquadro aro móvel AX-06/07/09/10
Escuadra AX-06/07/09/10

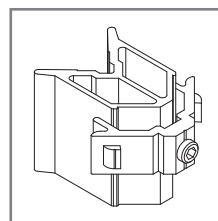

30 92 03 70

Esquadro porta
Escuadra puerta

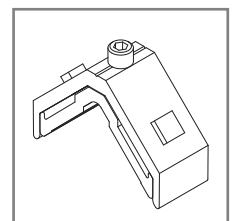

30 92 04 10

Esquadro inversor pivotante
Escuadra inversor pivotante

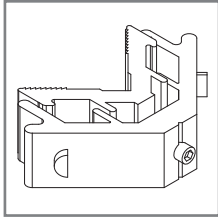

30 92 04 25

Esquadro AZ-22
Escuadro AZ-22

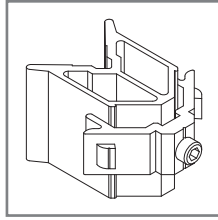

30 92 04 30

Esquadro móvel pivotante
Escuadra hoja pivotante

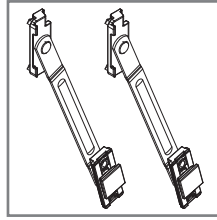

30 92 04 75

Jogo compassos basculante
Juego compás abatible

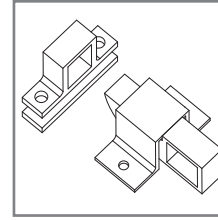

30 92 04 76

Fecho clack
Cierre clack

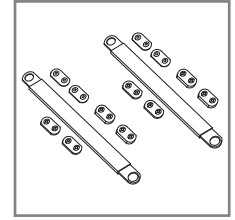

30 92 04 85

Jogo compasso
Juego compás

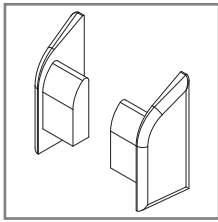

30 92 05 00

Jogo topos
Juego topes

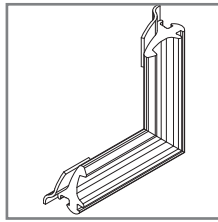

30 92 05 02

Canto vulcanizado AZ/AX
Angulo Vulcanizado AZ/AX

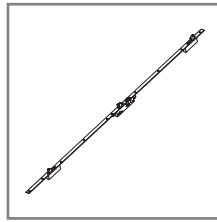

30 92 05 10/11

Fechadura 3 pontos 35 mm/30 mm
Cierre 3 puntos 35 mm/30 mm

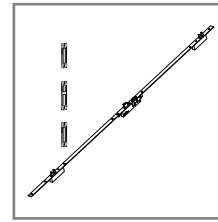

30 92 05 12

Fechadura 3 pontos AX Milénio
Cierre 3 puntos AX Milénio

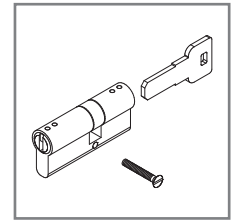

30 92 05 40

Canhão fechadura
Bombillo cierre

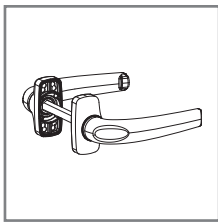

30 92 05 60/61

Puxador duplo branco/preto
Manilla doble blanco/negro

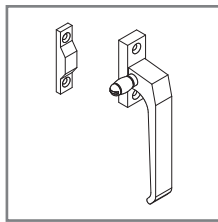

30 92 06 10/11

Cremona de lingueta branco/preto
Cremona de lingueta blanco/negro

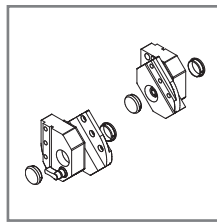

30 92 07 10/11

Jogo pivotante preto/branco (60 kg)
Juego pivotante negro/blanco (60 kg)

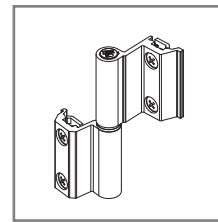

30 92 22 76/77

Dobradiça C/Afinação Branco/Preto
Bisagra regulable Blanco/Negro

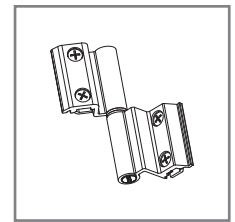

30 92 22 78/79

Dobradiça C/Afinação 3ªFolha Branco/Preto
Bisagra regulable 3ª Hoja Blanco/Negro

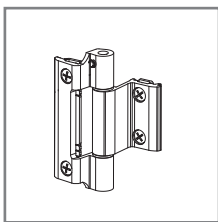

30 92 22 80/81

Dobradiça 3 Nós Reversível Branco/Preto
Bisagra 3 Nudos Reversible Blanco/Negro

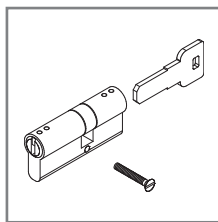

30 93 02 45

Canhão fechadura
Bombillo cierre

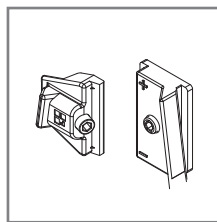

30 95 52 15

Fecho suplem. lado dobradiças
Punto de cierre suplementario

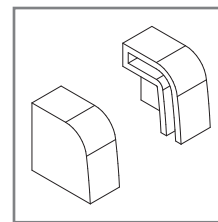

30 96 00 12

Jogo topos condensação
Juego topas condensación

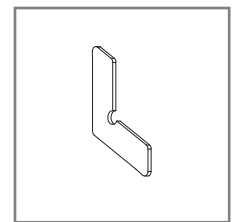

30 96 00 23

Esquadro de alinhamento
Escuadro de alineación

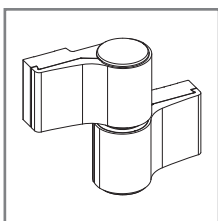

30 96 00 32

Dobradiça dupla lisa 80 mm (preto)
Bisagra doble lisa 80 mm (negro)

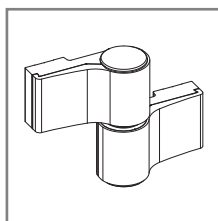

30 96 00 34

Dobradiça dupla anti-entalamento (preto)
Bisagra doble anti-presión (negro)

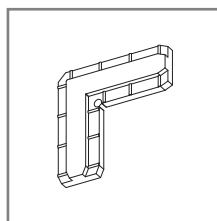

30 96 00 43

Esquadro de alinhamento
Escuadro de alineación

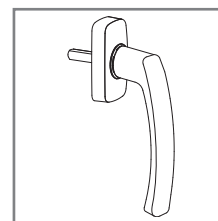

31 70 16 40

Puxador de alumínio
Manilla de aluminio

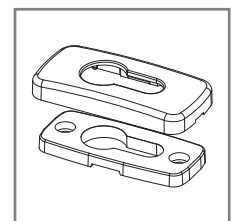





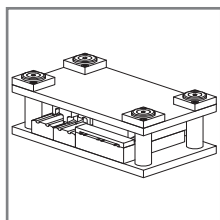

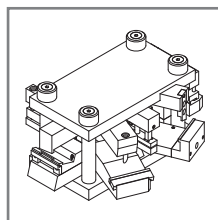

















31 70 16 43

Escudo de alumínio em bruto
Espejo de aluminio en crudo

33 96 69 99

 Cunho AX-Milénio
 Troquel AX-Milénio

33 96 79 99

 Cunho CE
 Troquel CE

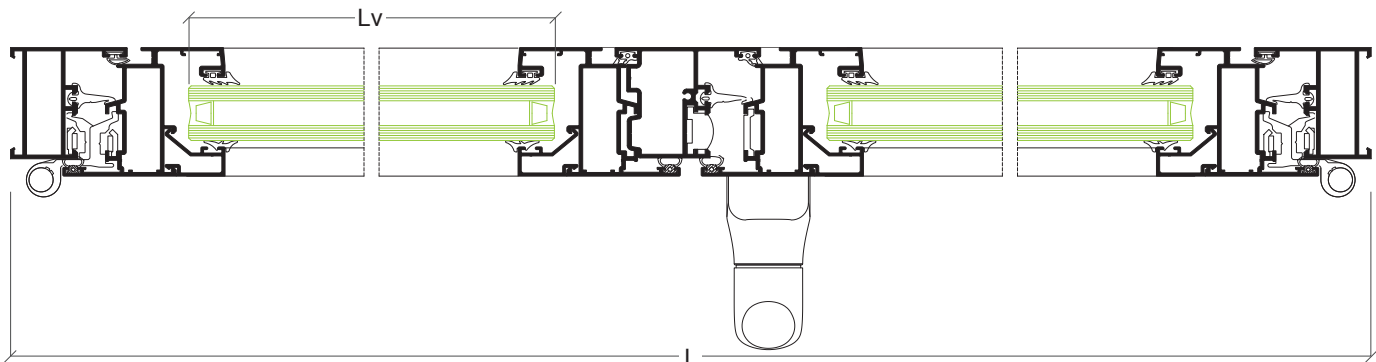
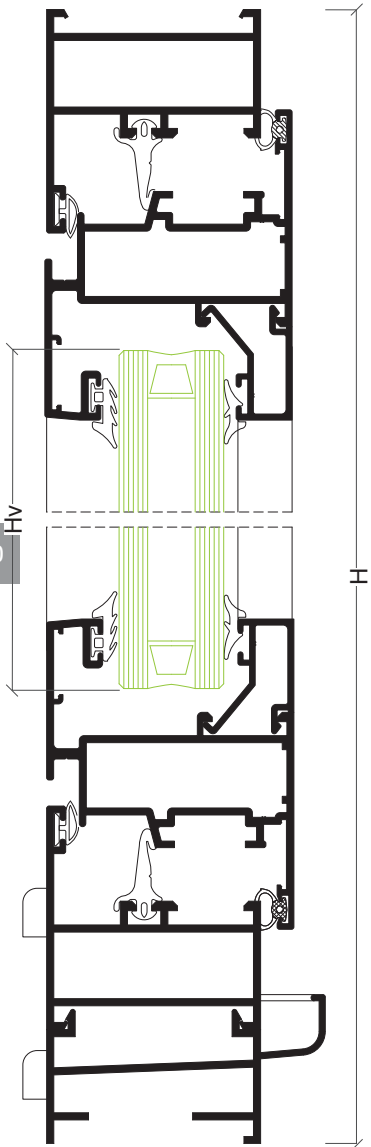
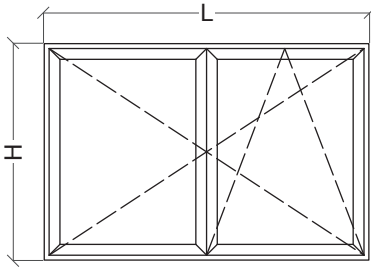
REFERÊNCIA • REFERENCIA	DESENHO • DISEÑO	DESCRIÇÃO • DESCRIPCIÓN
30 00 95 15		Junta vedação interior curta • Junta estanqueidad interior curta
30 20 26 03		Junta interior/exterior • Junta interior/exterior
30 20 26 14		Junta anti-entalamento 4.40 mts (preto) • Junta anti-presión 4.40 mts (negro)
30 60 00 17		Junta exterior vidro plana 2mm preto • Junta exterior vidro plana 2mm negro
30 93 00 50		Junta central • Junta central
30 93 00 60		Vedante exterior do vidro (opcional) • Junta exterior vidrio (opcional)
30 93 00 61		Junta de estanquidade exterior vidro 2 mm • Junta estanqueidad exterior vidrio 2 mm
30 93 00 62		Junta plana para vidro • Junta plana para vidrio
30 93 00 65		Junta interior para vidro (5 mm) • Junta interior para vidrio (5 mm)
30 93 00 66		Junta interior para vidro (4 mm) • Junta interior para vidrio (4 mm)
30 93 00 67		Junta interior para vidro (2 mm) • Junta interior para vidrio (2 mm)
30 93 00 68		Junta interior para vidro (6/7 mm) • Junta interior para vidrio (6/7 mm)
30 93 00 69		Junta interior para vidro (8/9 mm) • Junta interior para vidrio (8/9 mm)
30 93 00 70		Vedante interior do vidro (opcional) • Junta interior del vidrio (opcional)
30 93 00 81		Junta vedação inferior • Junta estanqueidad inferior
30 93 00 82		Junta vedação inferior • Junta estanqueidad inferior
30 93 00 84		Junta para pingadeiras AZ-60 e AZ-70 • Junta para goteos AZ-60 e AZ-70
30 93 00 85		Junta de vedação interior longa • Junta de vedación interior larga
30 93 00 90		Junta exterior • Junta exterior
30 93 01 20		Junta interior • Junta interior
30 93 01 30		Junta exterior (abertura exterior/projectante) • Junta exterior (apertura exterior/proyectante)
30 94 01 46		Junta interior e exterior • Junta interior y exterior
30 95 00 10		Pelúcia 7x9 mm • Burlete 7x9 mm
30 95 00 40		Pelúcia 7x5.5 mm • Burlete 7x5.5 mm

Janela 2 folhas abrir e oscilo-batente • Ventana 2 hojas practicable y oscilo-batiente

PERFIS • PERFILES

DESENHO • DISEÑO	REF.	DESCRIÇÃO • DESCRIPCIÓN	CORTE • CORTE	QUANTIDADE CANTIDAD	MEDIDAS • MEDIDA
	AX-03	Aro fixo • Marco ventana	 	2	L
	AX-02	Aro móvel • Hoja ventana	 	4	L/2-24 mm
	AX-11	Inversor • Inversor		1	H-134 mm
	---	Bite • Junquillo	 	4	L/2-117 mm
	AX-58	Soleira de condensação • Condensación		4	H-199 mm
	AX-19	Vareta • Pletina falleba		1	L
	AX-19	Vareta • Pletina falleba		2	Apro. H/2 mm

ACESSÓRIOS E JUNTAS • ACCESORIOS Y JUNTAS

REF.	DESCRIÇÃO • DESCRIPTION	QUANTIDADE • CANTIDAD	
		ABRIR PRATICABLE	OSCILO-BATENTE OSCILOBATIENTE
30 92 00 20	Dobradiças C.E. • Bisagras C.E.	4	---
30 92 01 00	Goteiras • Tapa salida de aguas	4	4
30 92 01 13	Jogo topos inversor • Juego tapas inversor	1	1
30 92 01 20	Jogo fecho C.E. • Juego cierre C.E.	1	---
30 92 01 35	Esquadro alinhamento aro móvel • Escuadra alineamiento hoja	16	16
30 92 02 XX	Compasso O.B. • Compás O.B.	---	1
30 92 02 20	Kit oscilo-batente • Kit oscilobatiente	---	1
30 92 02 24	Kit 2ª folha oscilo-batente • Kit 2ª hoja oscilobatiente	---	1
30 92 02 60	Apoio da folha • Apoyo de la hoja	2	---
30 92 03 10	Kit cremone • Kit cremona	1	---
30 92 03 60	Esquadro janela • Escuadra ventana	12	12
30 96 00 12	Jogo topos condensação • Juego tapas condensación	1	
30 93 00 50	Junta central • Junta central	2L+3H	
30 93 00 90	Junta exterior • Junta exterior	2L+4H	
30 93 01 20	Junta interior • Junta interior	2L+4H	
---	Junta exterior vidro • Junta exterior vidrio	2L+4H	
---	Junta interior vidro • Junta interior vidrio	2L+4H	
30 92 05 02	Canto vulcanizado • Anqulo vulcanizado	4	

VIDRO • VIDRIO

Hv = H-173 mm	Lv = L/2-131 mm
---------------	-----------------

Janela projectante • Ventana proyectante
PERFIS • PERFIS

DESENHO • DISEÑO	REF.	DESCRIÇÃO • DESCRIPCIÓN	CORTE • CORTE	QUANTIDADE CANTIDAD	MEDIDAS • MEDIDA
	AX-03	Aro fixo • Marco ventana		2	L
			2	H-24 mm	
	AX-06	Aro móvel • Hoja ventana		2	L-42 mm
			2	H-66 mm	
	---	Bite • Junquillo		2	L-178 mm
				4	H-242 mm
	AX-58	Soleira de condensação • Condensación		1	L

ACESSÓRIOS E JUNTAS • ACCESORIOS Y JUNTAS

REF.	DESCRIÇÃO • DESCRIPTION	QUANTIDADE CANTIDAD
30 92 00 20	Dobradiças C.E. • Bisagras C.E.	2
30 92 01 00	Goteiras • Tapa salida de aguas	2
30 92 03 60	Esquadro janela • Escuadra ventana	4
30 92 03 63	Esquadro porta • Escuadra puerta	4
30 93 00 50	Junta central (facultativa) • Junta central (opcional)	2L+2H
30 92 01 35	Esquadro alinhamento aro móvel • Escuadra alineamiento hoja	8
30 92 04 85	Jogo compasso projectante • Juego compás proyectante	1
30 92 06 10	Cremona lingueta • Cremona	2
30 96 00 12	Jogo topos condensação • Juego topes condensación	1
30 93 01 20	Junta interior • Junta interior	2L+2H
30 93 00 90	Junta exterior • Junta exterior	2L+2H
---	Junta exterior vidro • Junta exterior vidrio	2L+2H
---	Junta interior vidro • Junta interior vidrio	2L+2H
30 92 05 02	Canto vulcanizado • Angulo vulcanizado	4

VIDRO • VIDRIO



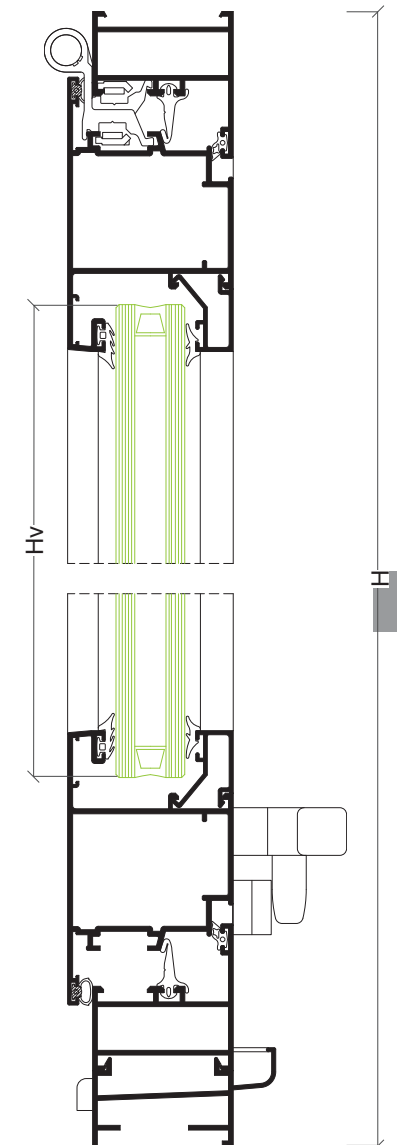
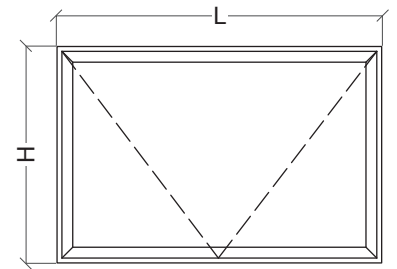



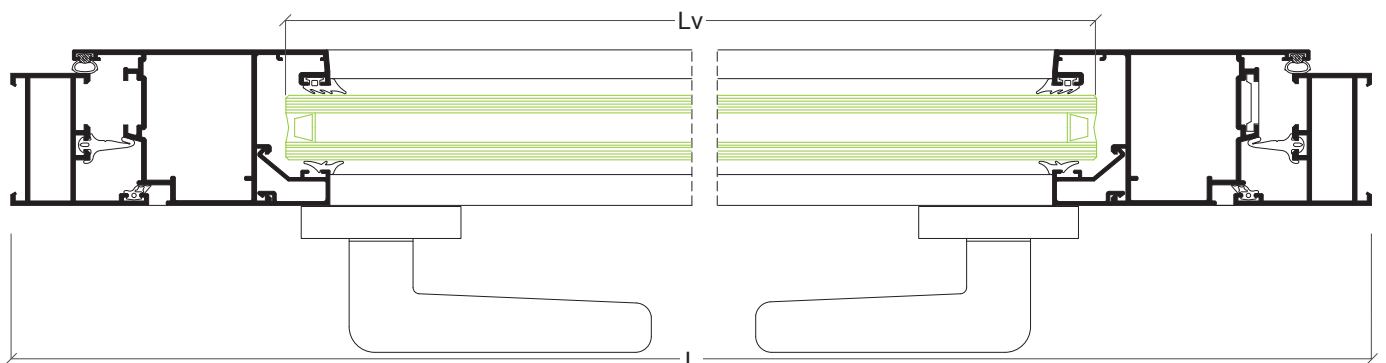

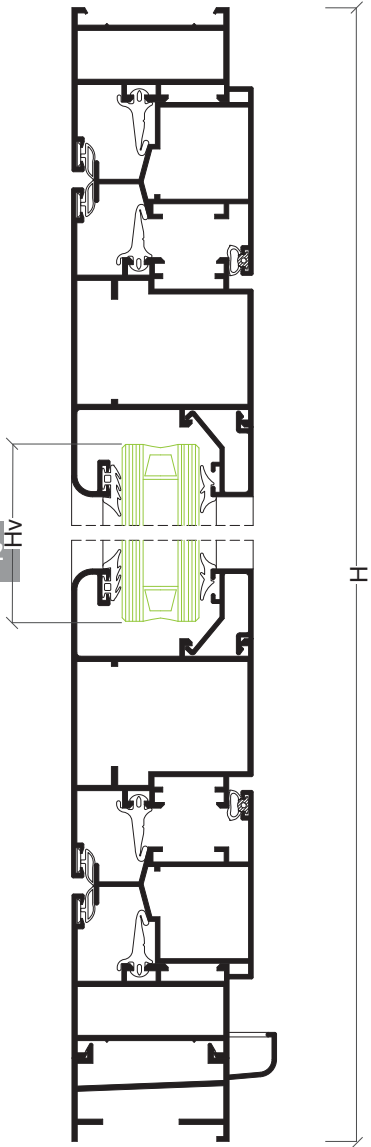
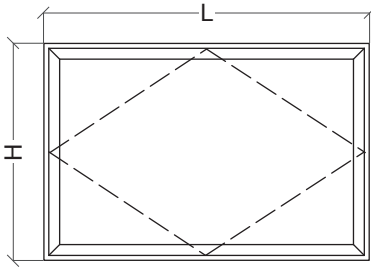

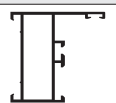

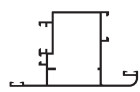

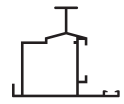
Hv = H-216 mm	Lv = L-192 mm
---------------	---------------

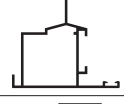

21



Janela pivotante horizontal • Ventana pivotante horizontal

PERFIS • PERFIS

DESENHO • DISEÑO	REF.	DESCRIÇÃO • DESCRIPCIÓN	CORTE • CORTE	QUANTIDADE CANTIDAD	MEDIDAS • MEDIDA
	AX-51	Aro fixo pivotante • Marco pivotante		2	L
				2	H-24 mm
	AX-54	Aro móvel pivotante • Hoja pivotante		2	L-103 mm
				2	H-127 mm
	AX-55	Inversor superior • Inversor superior		1	L-44 mm
				2 (1+1)	H/2-34 mm
	AX-55	Inversor inferior • Inversor inferior		1	L-44 mm
				2 (1+1)	H/2-34 mm
	---	Bite • Junquillo		2	L-240 mm
				2	H-304 mm
	AX-58	Soleira de condensação • Condensación		1	L

ACESSÓRIOS E JUNTAS • ACCESORIOS Y JUNTAS

REF.	DESCRIÇÃO • DESCRIPTION	QUANTIDADE CANTIDAD
30 92 01 00	Goteiras • Tapa salida de aguas	4
30 92 03 60	Esquadro janela • Escuadra janela	4
30 92 04 10	Esquadro inversor pivotante • Escuadra inversor pivotante	4
30 92 04 30	Esquadro porta • Escuadra puerta	4
30 92 07 10	Jogo pivotante • Juego pivotante	1
30 92 06 11	Cremona lingueta • Cremona lingueta	2
30 93 00 50	Junta central • Junta central	4L+4H
30 93 01 20	Junta interior • Junta interior	4L+4H
30 93 00 90	Junta exterior • Junta exterior	2L+2H
---	Junta exterior vidro • Junta exterior vidrio	2L+2H
---	Junta interior vidro • Junta interior vidrio	2L+2H
30 96 00 12	Jogo topos condensação • Juego topos condensación	1
30 92 05 02	Canto vulcanizado • Angulo vulcanizado	8

VIDRO • VIDRIO

Hv = H-278 mm	Lv = L-254 mm
---------------	---------------

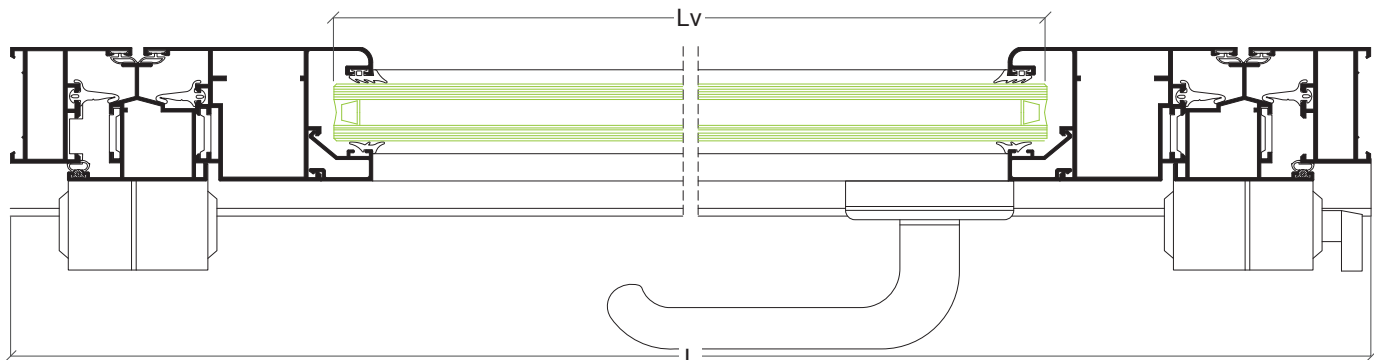

Porta 1 folha • Puerta 1 hoja
PERFIS • PERFIS

DESENHO • DESEÑO	REF.	DESCRIÇÃO • DESCRIPCIÓN	CORTE • CORTE	QUANTIDADE CANTIDAD	MEDIDAS • MEDIDA
	AX-08	Aro fixo • Marco puerta		1	L
				2	H
	AX-07	Aro móvel • Hoja puerta		1	L-78 mm
				2	H-45 mm
	AX-12	Travessa • Zócalo 120x45mm		1	L-205 mm
	AX-15	Bire remate • Junquillo acople		1	L-213.5 mm
	---	Bite • Junquillo		2	L-213.5 mm
				2	H-253 mm
	AZ-60	Pingadeira • Vierendeaguas puerta		1	L-148 mm
	AZ-61	Suplemento • Suplemento vierendeaguas		1	L-254 mm

ACESSÓRIOS E JUNTAS • ACCESORIOS Y JUNTAS

REF.	DESCRIÇÃO • DESCRIPTION	QUANTIDADE CANTIDAD
30 92 00 20	Dobradiças C.E. • Bisagras C.E.	3
30 92 01 35	Esquadro alinhamento móvel • Escuadra alineamiento hoja	4
30 92 03 63	Esquadro móvel • Escuadra hoja	2
30 92 03 70	Esquadro porta • Escuadra puerta	2
30 92 05 10	Fechadura 3 pontos • Cierre 3 puntos	1
30 92 05 40	Canhão fechadura • Bombillo cierre	1
30 92 05 60	Puxador duplo • Manilla doble	1
30 92 01 00	Goteira • Tapa salida de aguas	2
30 92 05 00	Jogo topos • Juego tapas	1
30 93 00 50	Junta central • Junta central	1L+2H
30 93 00 90	Junta exterior • Junta exterior	1L+2H
30 93 01 20	Junta interior • Junta interior	1L+2H
30 95 00 10	Pelúcia 7x9 mm • Burlete 7x9 mm	2L
---	Junta exterior vidro • Junta exterior vidrio	2L+2H
---	Junta interior vidro • Junta interior vidrio	2L+2H
30 93 00 84	Junta para pingadeiras • Junta para goteos	L
30 92 05 02	Canto vulcanizado • Angulo vulcanizado	2

VIDRO • VIDRIO



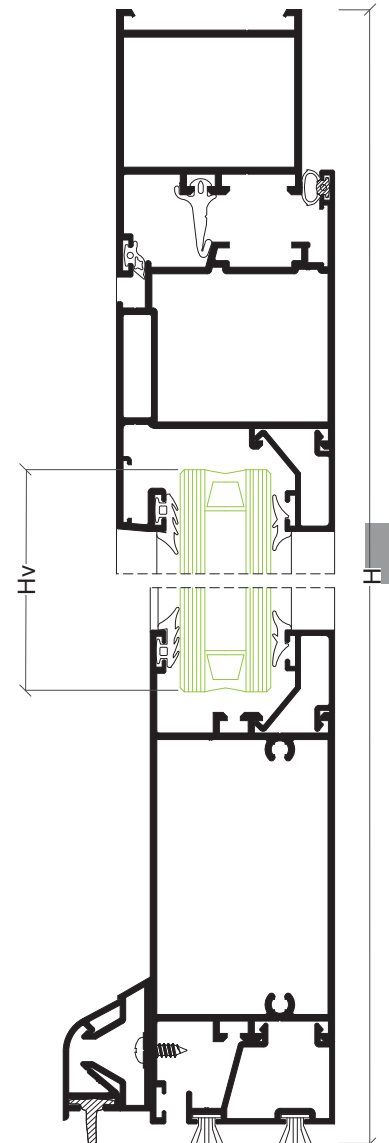
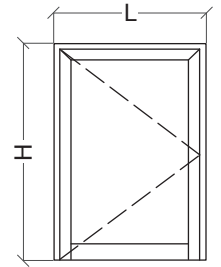



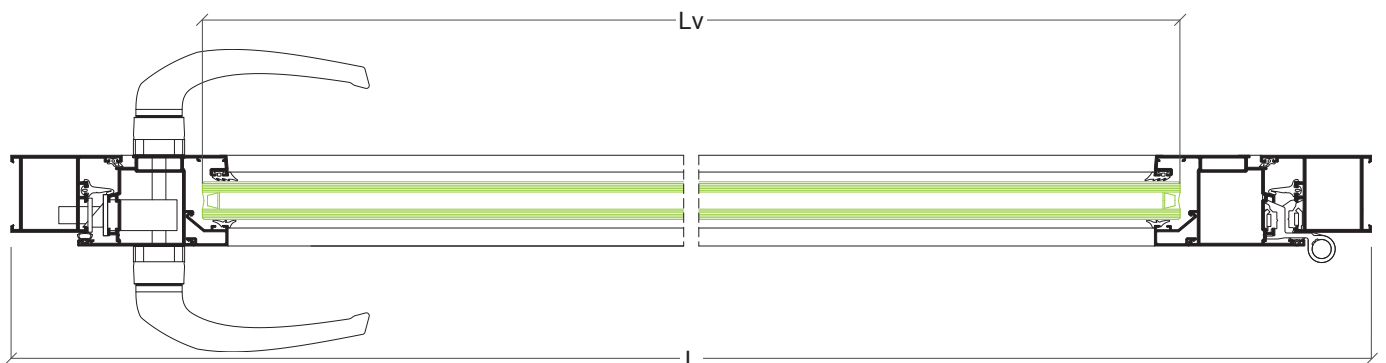

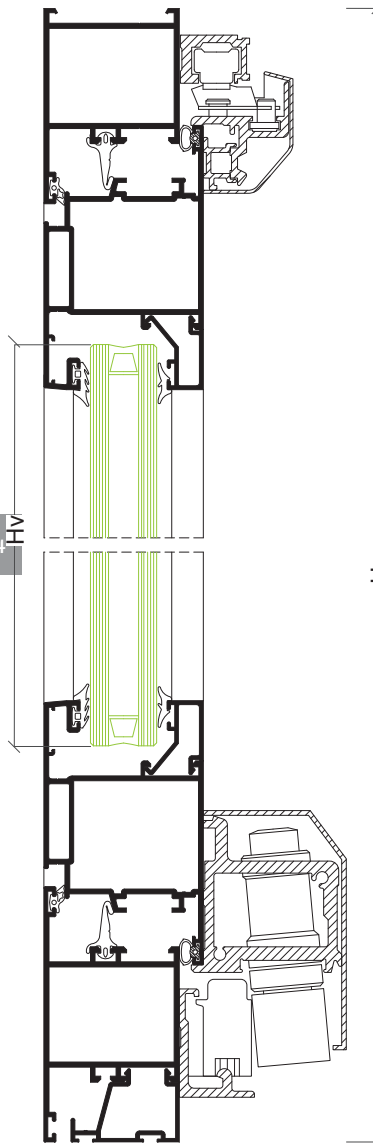
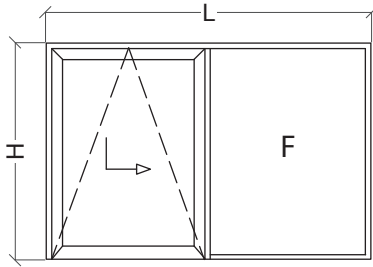

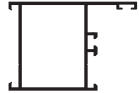

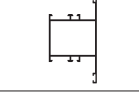









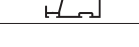



Hv = H-227 mm	Lv = L-227 mm
---------------	---------------

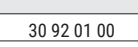

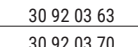
23

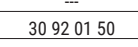

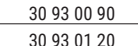
Porta oscilo-paralela com fixo lateral • Puerta oscilo-paralela con fijo lateral

PERFIS • PERFIS

DESENHO • DISEÑO	REF.	DESCRIÇÃO • DESCRIPCIÓN	CORTE • CORTE	QUANTIDADE CANTIDAD	MEDIDAS • MEDIDA
	AX-08	Aro fixo • Marco puerta		1	L
	AX-28	Travessa • Travesaño puerta		2	H
	AX-28	Travessa • Travesaño puerta		1	L-81 mm
	AX-07	Aro móvel • Hoja puerta		1	H-101 mm
	AX-07	Aro móvel • Hoja puerta		2	L1-55.5 mm
	AX-07	Aro móvel • Hoja puerta		2	H-98 mm
	---	Bite • Junquillo		2	L1-191 mm
	---	Bite • Junquillo		2	H-273.5 mm
	---	Bite • Junquillo		2	L2-67.5 mm
	---	Bite • Junquillo		2	H-150 mm
	AX-15	Bite remate • Junquillo acople		1	L-90 mm
	AX-19	Vareta • Pletina falleba		1	Apro. L1
	AX-19	Vareta • Pletina falleba		2	Apro. L1

ACESSÓRIOS E JUNTAS • ACCESORIOS Y JUNTAS

REF.	DESCRIÇÃO • DESCRIPTION	QUANTIDADE CANTIDAD
30 92 01 00	Goteiras • Tapa salida de aguas	4
30 92 01 35	Esquadro alinhamento móvel • Escuadra alineamiento hoja	8
30 92 03 63	Esquadro móvel AX-10 • Escuadra hoja AX-10	4
30 92 03 70	Esquadro porta • Escuadra puerta	6
---	Kit oscilo-paralela • Kit oscilo-paralela	1
30 92 01 50	União porta • Unión puerta	4
30 93 00 50	Junta central • Junta central	L+2H
30 93 00 90	Junta exterior • Junta exterior	L+2H
30 93 01 20	Junta interior • Junta interior	L+2H
---	Junta exterior vidro • Junta exterior vidrio	2L+4H
---	Junta interior vidro • Junta interior vidrio	2L+4H
30 92 05 02	Canto vulcanizado • Angulo vulcanizado	4





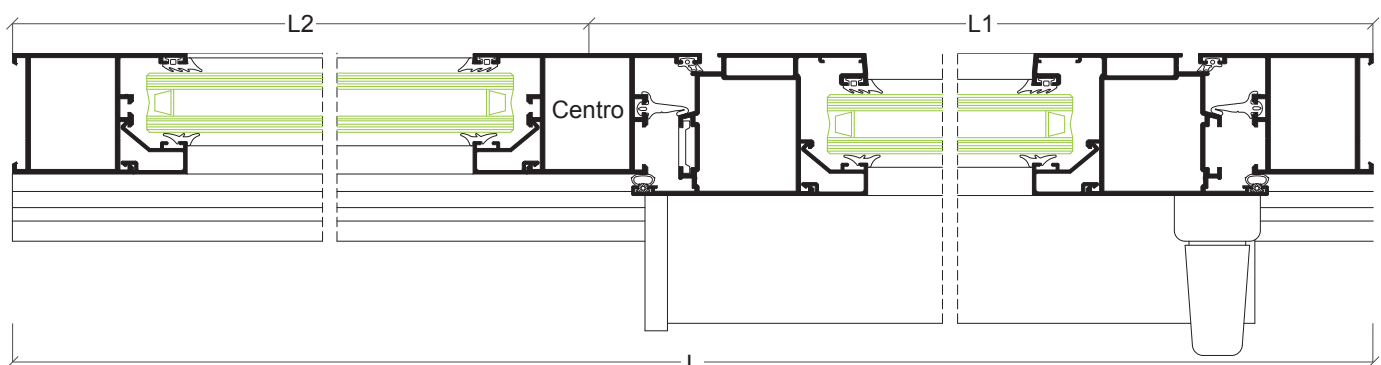

	MÍNIMO • MÍNIMO	MÁXIMO • MÁXIMO
Largura da folha • Largo de la hoja	700 mm	1650 mm
Altura da folha • Alto de la hoja	850 mm	2400 mm
Peso máximo por folha 150 Kg • Peso máximo por hoja 150 kg		

VIDRO • VIDRIO

Hv Folha = H-248 mm	Lv Folha = L1-205 mm
Hv Fixo = H-124 mm	Lv Fixo = L2-82 mm



Porta 3 folhas harmónio • Puerta 3 hojas plegable
PERFIS • PERFIS

DESENHO • DESEÑO	REF.	DESCRIÇÃO • DESCRIPCIÓN	CORTE • CORTE	QUANTIDADE CANTIDAD	MEDIDAS • MEDIDA
	AX-08	Aro fixo • Marco puerta		2	H
	AX-28	Travessa • Travesaño puerta		1	L-81 mm
	AX-07	Aro móvel • Hoja puerta		4	F1 consultar
				2	F2 consultar
				6	consultar
	AX-11	Inversor • Inversor		2	consultar
	---	Bite • Junquillo		2	consultar
				2	consultar
	AX-15	Bite remate • Junquillo acople		2	L
	AX-19	Vareta • Pletina falleba		1+1	H+H
	AX-12	Travessa • Zócalo 120x45mm		1	L-81 mm

ACESSÓRIOS E JUNTAS • ACCESORIOS Y JUNTAS

REF.	DESCRIÇÃO • DESCRIPTION	QUANTIDADE CANTIDAD
30 92 01 00	Goteiras • Tapa salida de aguas	4
30 92 01 13	Jojo topos inversor • Juego tapas inversor	2
30 92 01 35	Esquadro alinhamento móvel • Escuadra alineamiento hoja	24
30 92 03 63	Esquadro móvel • Escuadra hoja	12
30 92 03 70	Esquadro porta • Escuadra puerta	12
---	Kit harmónio (3+0) • Kit plegable (3+0)	1
30 93 00 50	Junta central • Junta central	2L+4H
30 93 00 90	Junta exterior • Junta exterior	2L+6H
30 93 01 20	Junta interior • Junta interior	2L+6H
---	Junta exterior vidro • Junta exterior vidrio	2L+4H
---	Junta interior vidro • Junta interior vidrio	2L+4H
30 92 05 02	Canto vulcanizado • Angulo vulcanizado	4
30 92 01 50	União porta • Unión puerta	2

	MÍNIMO • MÍNIMO	MÁXIMO • MÁXIMO
Largura da folha • Largo de la hoja	600 mm	900 mm
Altura da folha • Alto de la hoja	850 mm	2400 mm

Peso máximo por folha 80 Kg • Peso máximo por hoja 80 kg

VIDRO • VIDRIO

Hv = consultar	Lv 1 = consultar
	Lv 2 = consultar

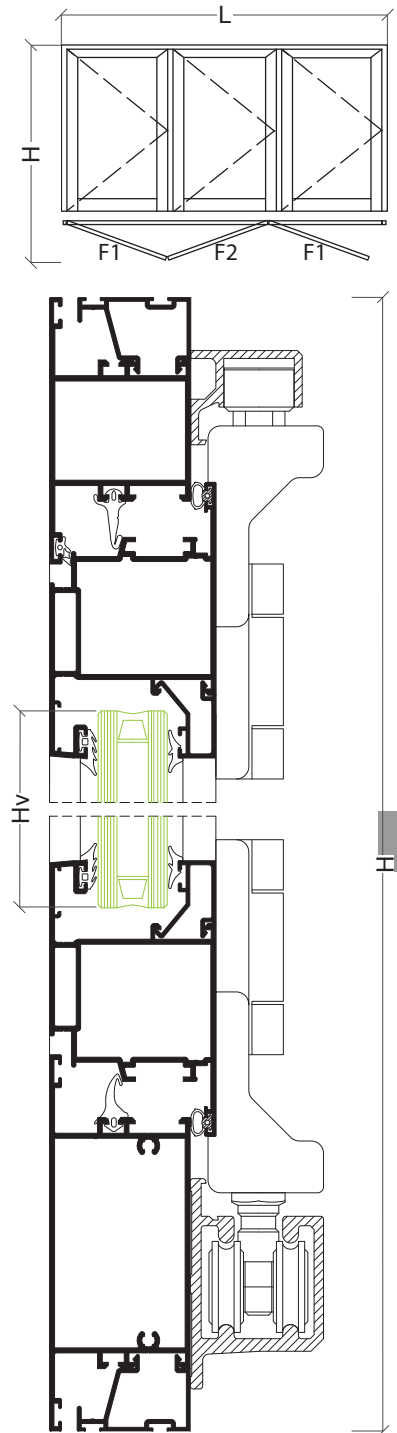
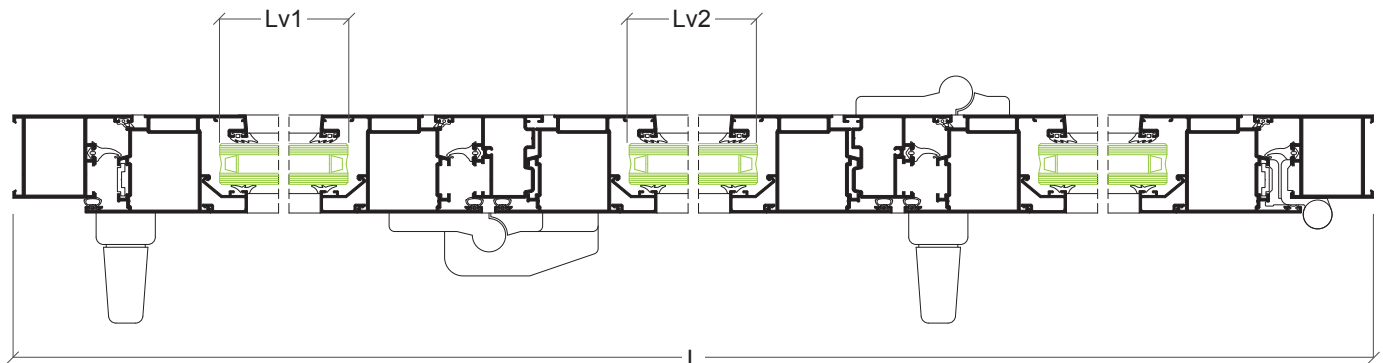

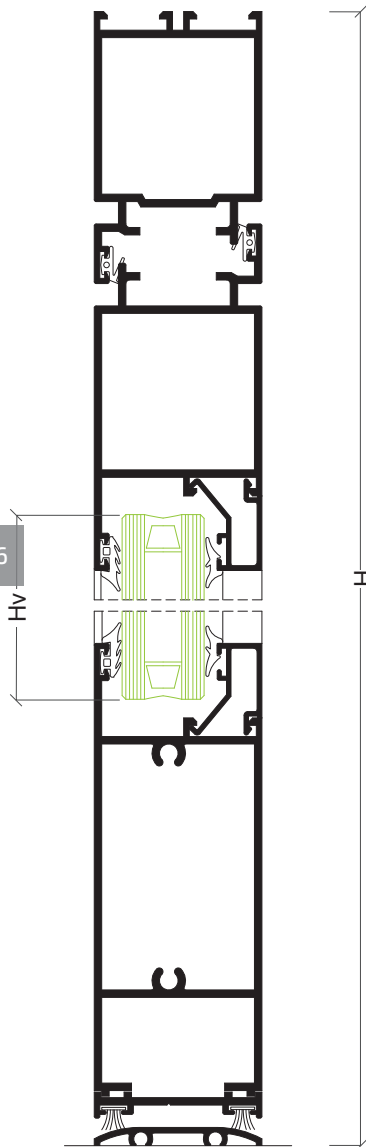
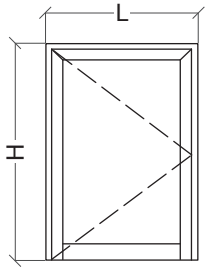
Porta 1 folha • Puerta 1 hoja

PERFIS • PERFIS

DESENHO • DISEÑO	REF.	DESCRIÇÃO • DESCRIPCIÓN	CORTE • CORTE	QUANTIDADE CANTIDAD	MEDIDAS • MEDIDA
	AX-64	Aro fixo • Marco puerta		1	L
				2	H
	AX-65	Ao fixo • Hoja puerta		1	L-114 mm
				2	H-72 mm
	AX-68	Almofadas • Zócalo interior		1	L-250 mm
	---	Bite • Junquillo		2	L-260 mm
				2	H-285 mm
	AX-60	Vedação inferior • Acople zócalo inferior		1	L-114 mm
	AX-63	Remate pavimento • Remate al pavimento		1	L-105 mm

ACESSÓRIOS E JUNTAS • ACCESORIOS Y JUNTAS







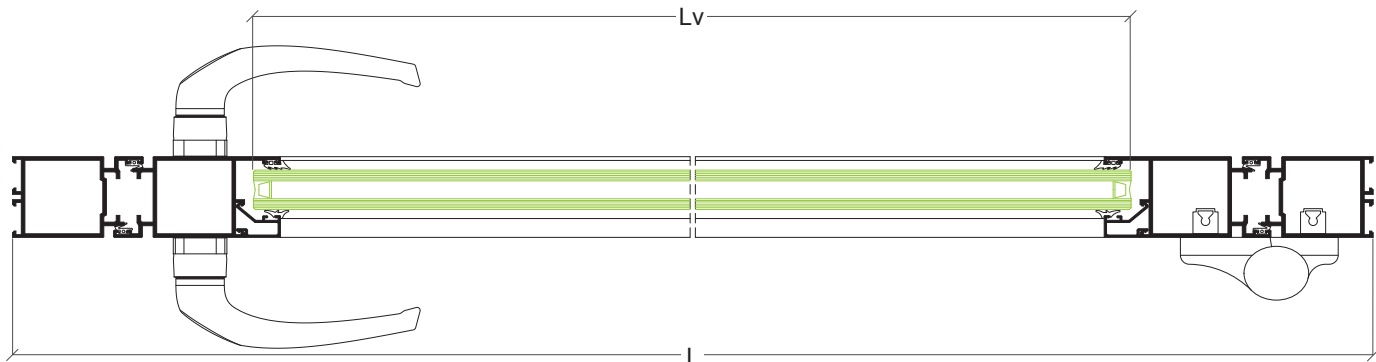

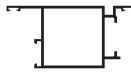

REF.	DESCRIÇÃO • DESCRIPTION	QUANTIDADE CANTIDAD
30 20 26 01	Esquadro porta • Escuadra puerta	4
30 20 26 02	Dobradiças • Bisagras	3
30 92 05 12	Fechadura • Cierre	1
30 93 02 45	Canhão de fechadura • Bombillo cierre	1
30 60 16 55	Escudo de alumínio • Escudo de aluminio	2
30 92 05 60	Puxador duplo • Manilla doble	1
30 20 26 03	Junta interior • Junta interior	2L+4H
30 95 00 10	Pelúcia 7x9 mm • Burlete 7x9 mm	2L
---	Junta exterior vidro • Junta exterior vidrio	2L+2H
---	Junta interior vidro • Junta interior vidrio	2L+2H

VIDRO • VIDRIO

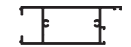
Hv = H-259 mm	Lv = L-274 mm
---------------	---------------



Porta 1 folha abertura exterior • Puerta 1 hoja apertura exterior
PERFIS • PERFIS

DESENHO • DISEÑO	REF.	DESCRIÇÃO • DESCRIPCIÓN	CORTE • CORTE	QUANTIDADE CANTIDAD	MEDIDAS • MEDIDA
	AX-64	Aro fixo • Marco hoja		1	L
				2	H
	AX-66	Aro móvel abertura exterior Hoja apertura exterior		1	L-114 mm
				2	H-72 mm
	AX-68	Almofada • Zócalo interior		1	L-250 mm
	---	Bite • Junquillo		2	L-260 mm
				2	H-285 mm
	AX-60	Vedação inferior • Acople zócalo inferior		1	L-114 mm
	AX-63	remate pavimento • Remate al pavimento		1	L-105 mm

ACESSÓRIOS E JUNTAS • ACCESORIOS Y JUNTAS

REF.	DESCRIÇÃO • DESCRIPTION	QUANTIDADE CANTIDAD
30 20 26 01	Esquadro porta • Escuadra puerta	4
30 20 26 02	Dobradiças • Bisagras	3
30 92 05 12	Fechadura • Cierre	1
30 93 02 45	Canhão de fechadura • Bombillo cierre	1
30 60 16 55	Escudo de alumínio • Escudo de alumínio	2
30 92 05 60	Puxador duplo • Manilla doble	1
30 20 26 03	Junta interior • Junta interior	2L+4H
30 95 00 10	Pelúcia 7x9 mm • Burlete 7x9 mm	2L
---	Junta exterior vidro • Junta exterior vidrio	2L+2H
---	Junta interior vidro • Junta interior vidrio	2L+2H

VIDRO • VIDRIO

Hv = H-259 mm	Lv = L-274 mm
---------------	---------------

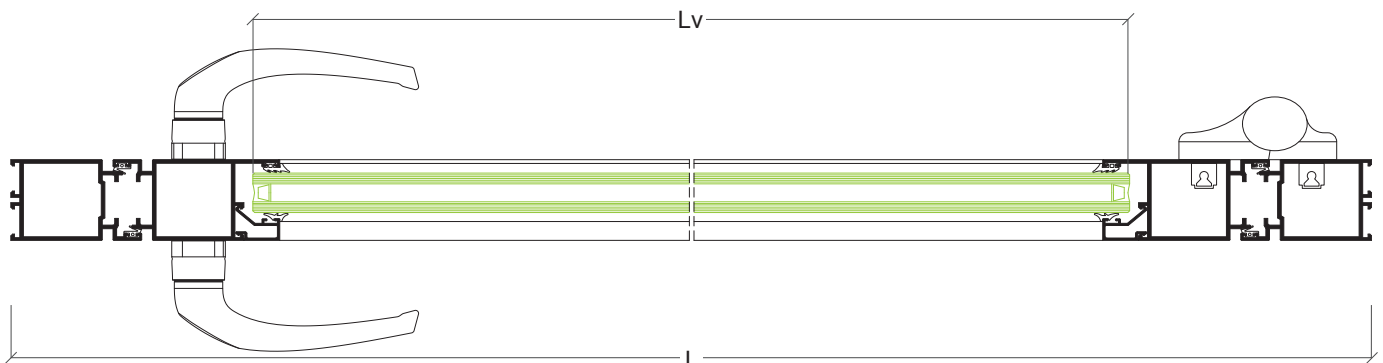
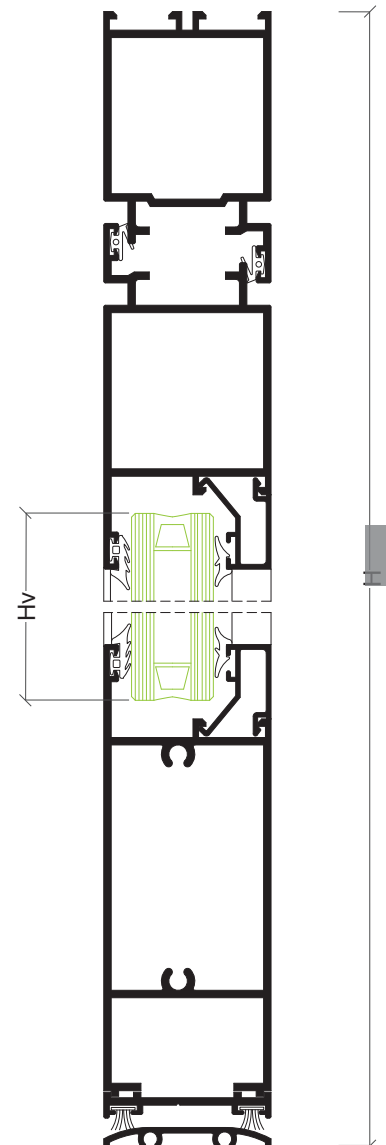
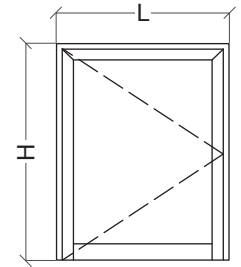

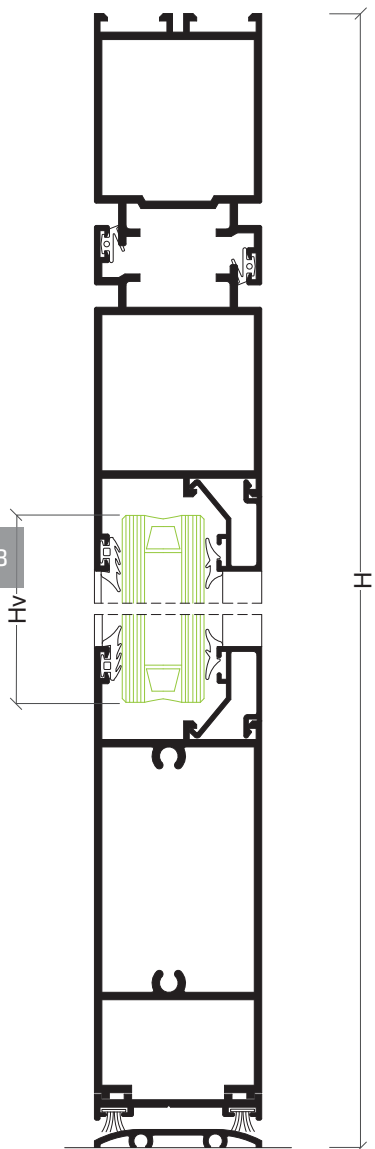
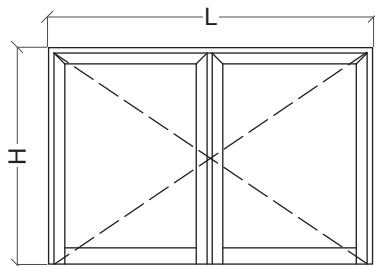
Porta 2 folhas abertura exterior • Puerta 2 hojas apertura exterior

PERFIS • PERFIS

DESENHO • DISEÑO	REF.	DESCRIÇÃO • DESCRIPCIÓN	CORTE • CORTE	QUANTIDADE CANTIDAD	MEDIDAS • MEDIDA
	AX-64	Aro fixo • Marco puerta		1	L
	AX-65	Aro móvel • Hoja puerta		2	H
	AX-66	Aro móvel abertura exterior Hoja apertura exterior		1	H-72 mm
	AX-66	Aro móvel abertura exterior Hoja apertura exterior		2	L/2-49 mm
	AX-66	Aro móvel abertura exterior Hoja apertura exterior		3	H-72 mm
	AX-68	Almofada • Zócalo interior		2	L/2-185 mm
	---	Bite • Junquillo		4	L/2-195 mm
	---	Bite • Junquillo		4	H-285 mm
	AX-60	Vedação inferior • Acople zócalo inferior		2	L/2-49 mm
	AX-63	remate pavimento • Remate al pavimento		1	L-105 mm

ACESSÓRIOS E JUNTAS • ACCESORIOS Y JUNTAS

REF.	DESCRIÇÃO • DESCRIPTION	QUANTIDADE CANTIDAD
30 20 26 01	Esquadro porta • Escuadra puerta	6
30 20 26 02	Dobradiças • Bisagras	6
30 20 26 10	Fecho 2ª folha pequeno • Cierre 2ª hoja pequeño	1
30 20 26 11	fecho 2ª folha grande • Cierre 2ª hoja grande	1
30 92 05 12	Fechadura • Cierre	1
30 93 02 45	Canhão de fechadura • Bombillo cierre	1
30 60 16 55	Escudo de alumínio • Escudo de aluminio	2
30 92 05 60	Puxador duplo • Manilla doble	1
30 20 26 03	Junta interior • Junta interior	2L+6H
30 95 00 10	Pelúcia 7x9 mm • Burlete 7x9 mm	2L
---	Junta exterior vidro • Junta exterior vidrio	2L+2H
---	Junta interior vidro • Junta interior vidrio	2L+2H
30 24 30 75	Contra Fecho • Cierre	1

VIDRO • VIDRIO



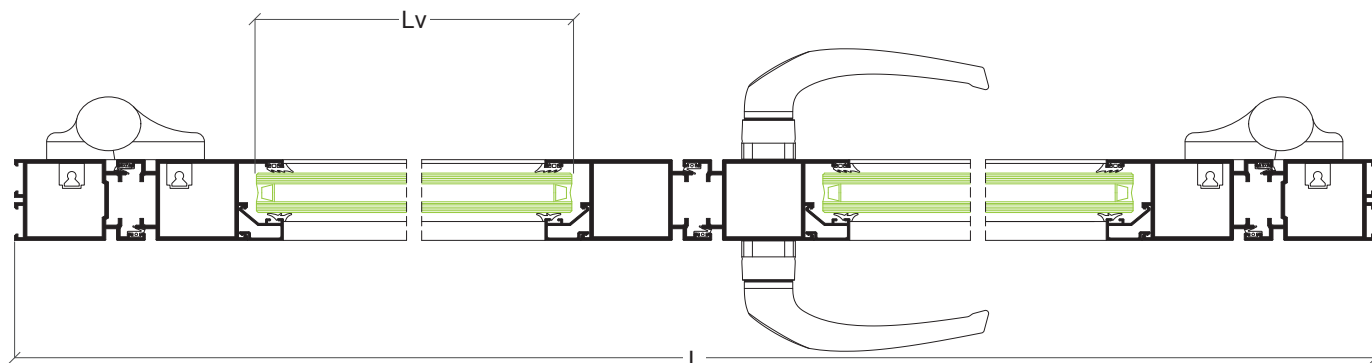











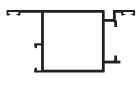

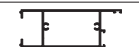
Hv = H-259 mm	Lv = L/2-209 mm
---------------	-----------------



Porta 2 folhas abertura exterior com junta anti-entalamento

Puerta 2 hojas apertura exterior con junta anti-presión

PERFIS • PERFIS

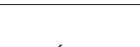
DESENHO • DISEÑO	REF.	DESCRIÇÃO • DESCRIPCIÓN	CORTE • CORTE	QUANTIDADE CANTIDAD	MEDIDAS • MEDIDA
	AX-64	Aro fixo • Marco puerta		1	L
	AX-65	Aro móvel • Hoja puerta		2	H
	AX-66	Aro móvel abertura exterior Hoja apertura exterior		2	L/2-85 mm
	AX-68	Almofada • Zócalo interior		3	H-72 mm
	AX-68	Almofada • Zócalo interior		2	L/2-222 mm
	---	Bite • Junquillo		4	L/2-231 mm
	---	Bite • Junquillo		4	H-285 mm
	AX-60	Vedação inferior • Acople zócalo inferior		2	L/2-49 mm
	AX-63	Remate pavimento • Remate al pavimento		1	L-105 mm

ACESSÓRIOS E JUNTAS • ACCESORIOS Y JUNTAS

REF.	DESCRIÇÃO • DESCRIPTION	QUANTIDADE CANTIDAD
30 20 26 01	Esquadro porta • Escuadra puerta	6
30 96 00 34	Dobradiça dupla anti-entalamento • Bisagra doble anti-presión	6
30 20 26 10	Fecho 2ª folha pequeno • Cierre 2ª hoja pequeño	1
30 20 26 11	Fecho 2ª folha grande • Cierre 2ª hoja grande	1
30 92 05 12	Fechadura • Cierre	1
30 93 02 45	Canhão de fechadura • Bombillo cierre	1
30 60 16 55	Escudo de alumínio • Escudo de aluminio	2
30 92 05 60	Puxador duplo • Manilla doble	1
30 20 26 14	Junta anti-entalamento • Junta anti-presión	4H
30 20 26 03	Junta interior • Junta interior	2L+2 H
30 95 00 10	Pelúcia 7x9 mm • Burlete 7x9 mm	2L
---	Junta exterior vidro • Junta exterior vidrio	2L+2H
---	Junta interior vidro • Junta interior vidrio	2L+2H
30 24 30 75	Contra Fecho • Cierre	1

VIDRO • VIDRIO

Hv = H-259 mm	Lv = L/2-209 mm
---------------	-----------------

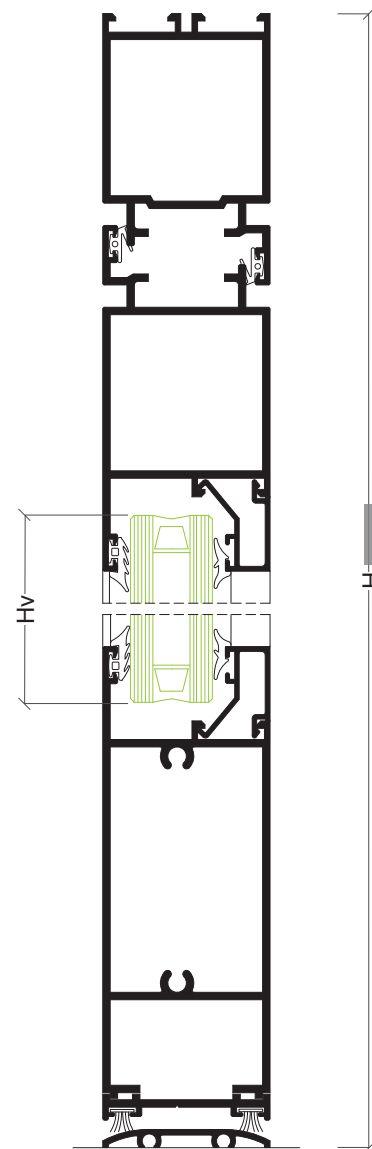
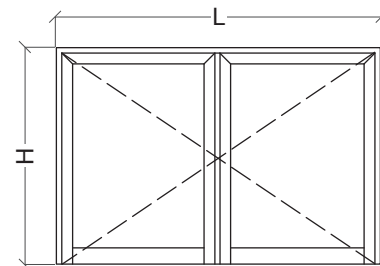

29

