

www.anicolor.pt

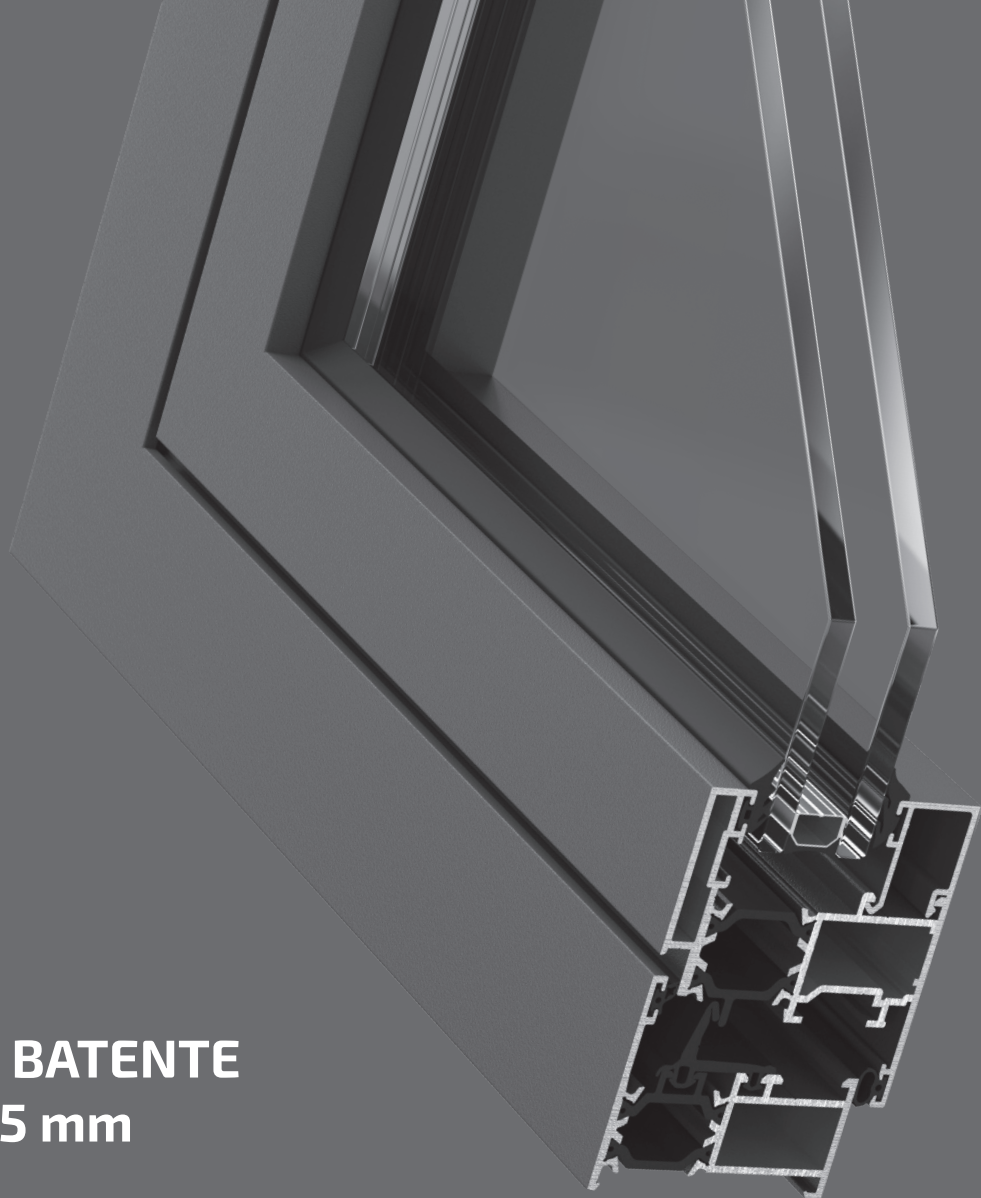

**SISTEMA DE BATENTE
COM RPT - 55 mm**

**SISTEMA PRACTICABLE DE CANAL EUROPEO
COM RPT - 55 mm**

ATi

 **anicolor**
Sistemas de Alumínio

SISTEMA ATI

Sistema de batente com RPT - 55 mm

CARACTERÍSTICAS DO SISTEMA

Sistema de batente com rotura térmica e de elevadas prestações térmicas e acústicas. O sistema ATI possibilita a execução de 4 versões de caixilharia:

1. linha recta;
2. linha curva;
3. linha tradição;
4. linha oval.

O sistema ATI permite a aplicação de vidros duplos de alto rendimento de modo a responder às exigências de isolamento térmico e acústico.

PERFIS DE ALUMÍNIO

Os perfis de alumínio são extrudidos na liga de alumínio 6060 para arquitetura de acordo com norma NP EN 12020-02.

Perfis com rotura térmica obtida por inserção de varetas isolantes de poliamida tipo ómega de 24 mm reforçadas com 25% de fibra de vidro.

Espessura média dos perfis de alumínio de 1.5 mm para janelas e de 1.7 mm para portas;

AROS FIXOS

Secção dos aros fixos de 55 mm ou 80 mm;

Aros fixos com esquadro para montagem a meia esquadria;

Aros fixos tradicionais para mercado interno;

Aros fixos com clip exterior e aba de remate direta de 25 mm ou 45 mm para o mercado francês;

Aros fixos com clip exterior e interior para aplicação de remate para o mercado francês.

AROS MÓVEIS

Secção dos aros móveis de 63 mm;

Enchimento para vidro desde 10 mm a 47 mm;

Aros móveis de linha recta, curva, tradição ou oval (sem bite);

Aros móveis com esquadro para montagem a meia esquadria;

Perfil inversor de linha recta.

38 DIMENSIONAMENTO E MANIOBRABILIDADE

Dimensões mínimas - máximas de folha: 400 mm - 1500 mm (L); 400 mm - 2700 mm (H);

Possibilidades de abertura: fixo, batente interior 1 ou 2 folhas com oscilo-batente, exterior, basculante, projectante, harmónio e oscilo-paralela;

Estanquidade assegurada através de juntas triplas em EPDM.

PERFORMANCES

Sistema certificado por laboratório credenciado, notificado para Ensaios Tipo Inicial (ITT) de acordo com a norma de produto EN 14351-1 para efeitos de Marcação CE.

Categorias alcançadas na avaliação do sistema ATI tipologia janela:

1. Permeabilidade ao ar: Classe 4 (norma de ensaio EN 10207 e EN 1026)
2. Estanquidade à água: Classe 9A (norma de ensaio EN 12208 e EN 1027)
3. Resistência ao vento: Classe C5 (norma de ensaio EN 12210 e EN 12211)

Categorias alcançadas na avaliação do sistema ATI tipologia porta:

1. Permeabilidade ao ar: Classe 4 (norma de ensaio EN 10207 e EN 1026)
2. Estanquidade à água: Classe E750 (norma de ensaio EN 12208 e EN 1027)
3. Resistência ao vento: Classe C2 (norma de ensaio EN 12210 e EN 12211)
4. Resistência à torção estática: Apto 350N (norma de ensaio EN 14609)

Coefficiente de transmissão térmica de vão de 2 folhas com 1.20 m x 1.50 m com vidro

Ug = 0.7 W/m²K, com intercalar efeito "Warm Edge":

Uw = 1.57 W/m²K

Coefficiente de atenuação acústica de vão de 2 folhas com vidro 4/14 (gás argón)/6:

Rw (C; Ctr) = 38 dB (-5; -9)

Zonas de aplicação segundo RCCTE (em função do valor Ug): I1, I2, I3, V1, V2, V3.

SISTEMA ATI

Sistema practicable de canal europeo com RPT - 55 mm

CARACTERÍSTICAS DEL SISTEMA

Sistema practicable con rotura térmica y de elevado rendimiento térmico y acústico. El sistema ATI possibilita la ejecución de 4 versiones de carpintería:

1. línea recta;
2. línea curva;
3. línea rústica;
4. línea oval.

El sistema AXI permite la aplicación de vidrios dobles de alto rendimiento por forma a responder a los requisitos de aislamiento térmico y acústico.

PERFILES DE ALUMINIO

Los perfiles de aluminio son extrudidos en aleación de aluminio 6060 para arquitectura de acuerdo con la norma NP EN 12020-02. Perfiles con rotura térmica obtenida por inserción de varillas aislantes de poliamida de 24mm reforzadas con 25% de fibra de vidrio.

Espesor medio de los perfiles de aluminio de 1.5 mm para ventanas y de 1.7 mm para puertas.

MARCOS

Profundidad de los marcos de 55 mm u 80 mm;

Marcos con escuadra para montaje a englete;

Marcos rústicos;

Marcos con enganche y solape de 25 mm u 45 mm;

Marcos con enganche y interior para aplicación de solape.

HOJAS

Profundidad de las hojas de 63 mm;

Acristalamiento para vidrio de 10 mm a 37 mm;

Hojas de línea recta, curva, rústica u oval (sin junquillo);

Hojas con escuadras para montaje a englete;

Perfil inversor de línea recta.

DIMENSIONAMIENTO Y MANIOBRABILIDAD

Dimensiones mínimas - máximas de hoja: 400 mm - 1500 mm (L); 400 mm - 2700 mm (H);

Possibilidades de abertura: fijo, practicable interior 1 u 2 hojas con oscilobatiente, exterior, abATible, proyectante, plegable y oscilo-paralela;

Estanquidad asegurada mientras juntas triples de EPDM;

ENSAYOS

Sistema certificado por laboratorio credenciado, notificado para Ensayos Tipo Inicial (ITT) de acuerdo con la norma de producto EN 14351-1 para efectos de Marcado CE.

Categorias alcanzadas en los ensayos del sistema ATI tipologia ventana:

1. Permeabilidad al aire: Clase 4 (norma de ensayo EN 10207 y EN 1026)
2. Estanquidad al agua: Clase 9A (norma de ensayo EN 12208 y EN 1027)
3. Resistencia al viento: Clase C5 (norma de ensayo EN 12210 y EN 12211)

Categorias alcanzadas en los ensayos del sistema ATI tipologia puerta:

1. Permeabilidad al aire: Clase 4 (norma de ensayo EN 10207 y EN 1026)
2. Estanquidad al agua: Clase E750 (norma de ensayo EN 12208 y EN 1027)
3. Resistencia al viento: Clase C2 (norma de ensayo EN 12210 y EN 12211)
4. Resistencia a la torsión estática: Apto 350N (norma de ensayo EN 14609)

Coefficiente de transmisión térmica de hueco de 2 hojas con 1.20 m x 1.50 m con vidrio Ug =

0.7 W/m²K, con intercalar efecto "Warm Edge": Uw = 1.57 W/m²K

Coefficiente de atenuación acústica de hueco de 2 hojas con vidrio 4/14 (gas argón)/6: Rw

(C; Ctr) = 38 dB (-5; -9)

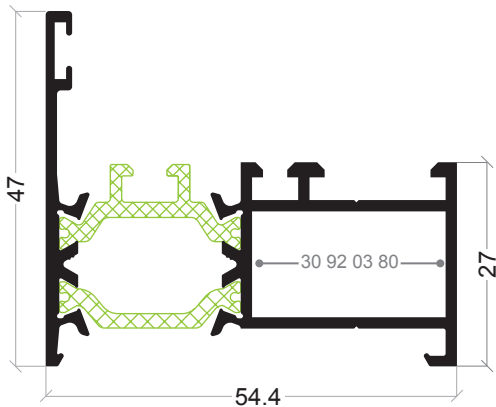

ATi-03

Aro fixo
Marco ventana

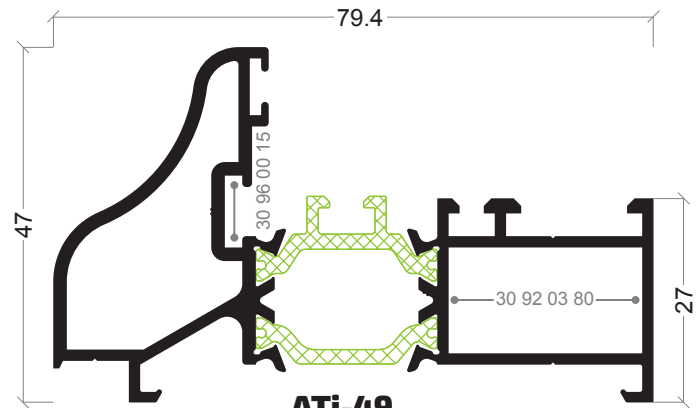

ATi-49

Aro fixo tradição
Marco ventana rústico

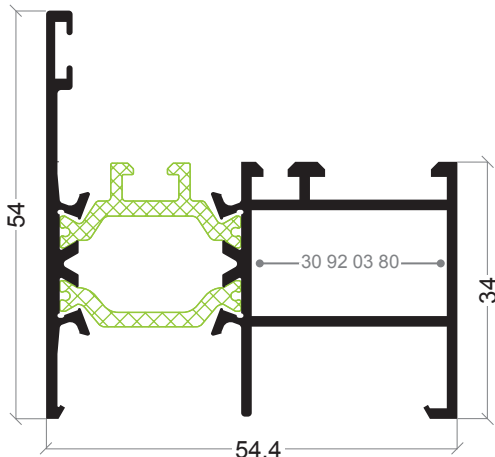

ATi-81

Aro fixo
Marco ventana intermédio

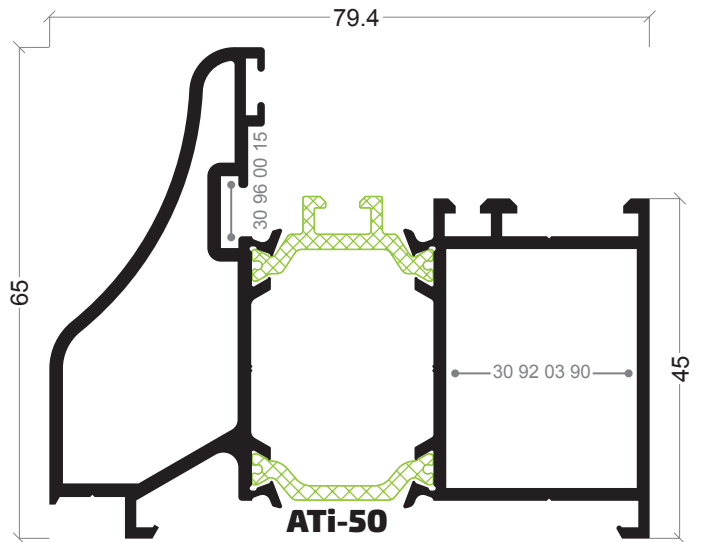

ATi-50

Aro fixo tradição
Marco puerta rústico

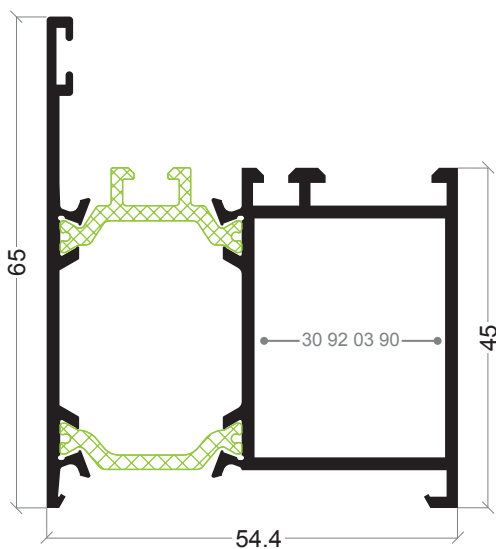

ATi-08

Aro fixo
Marco puerta

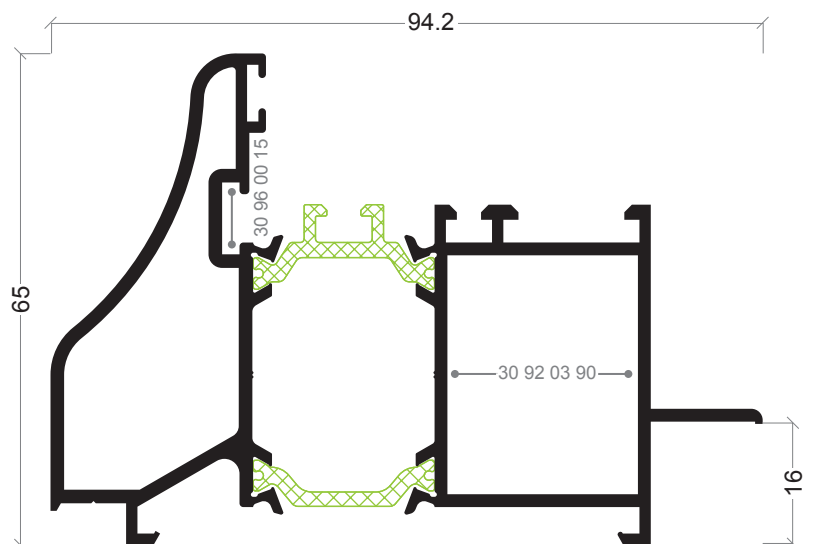

ATi-51

Aro fixo tradição para apanelado
Marco puerta rústico c/ precerco

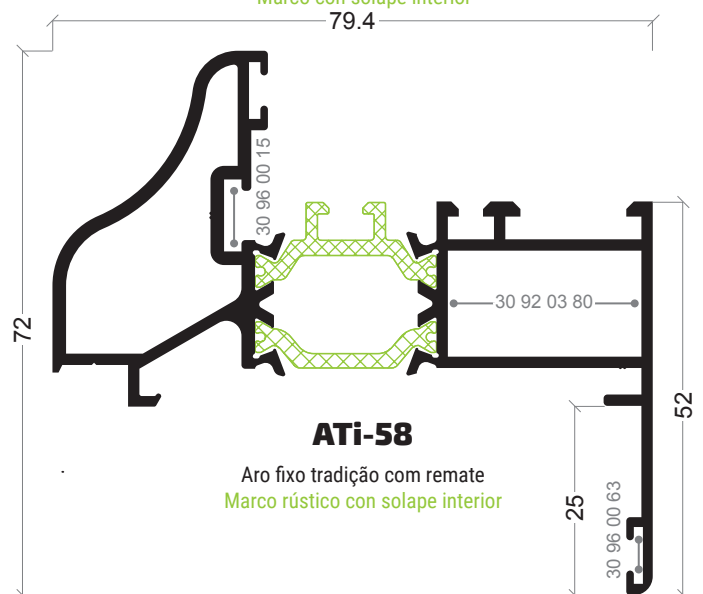
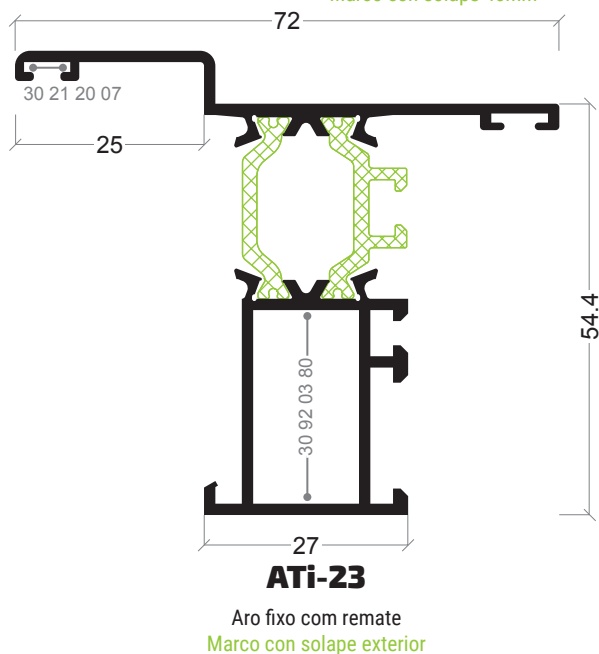
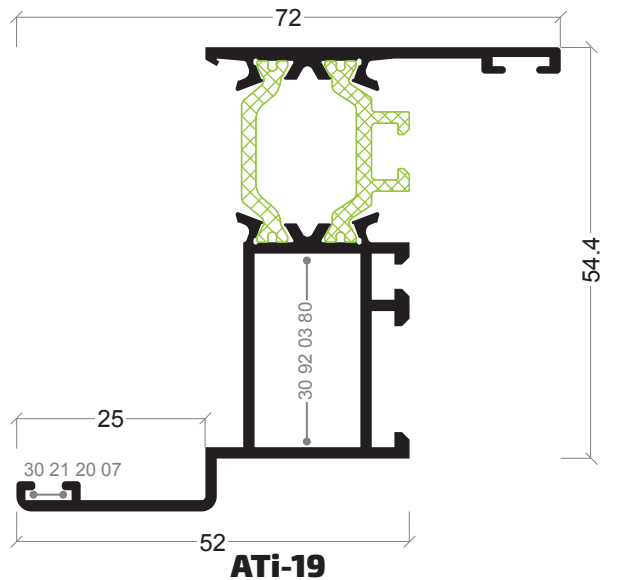
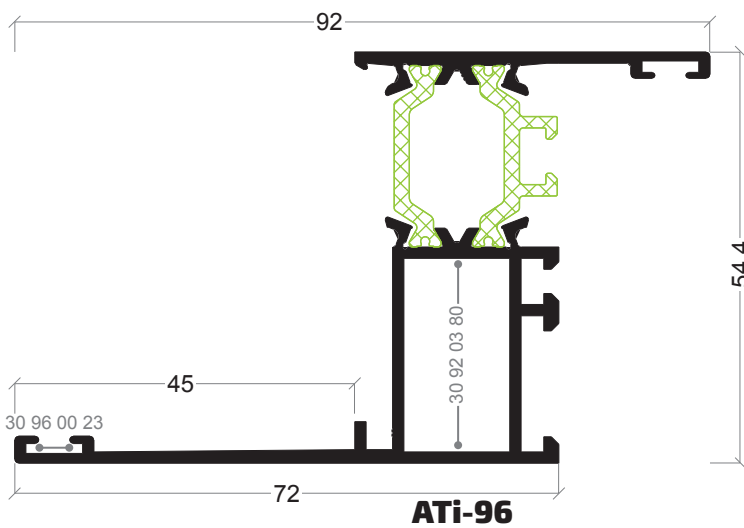
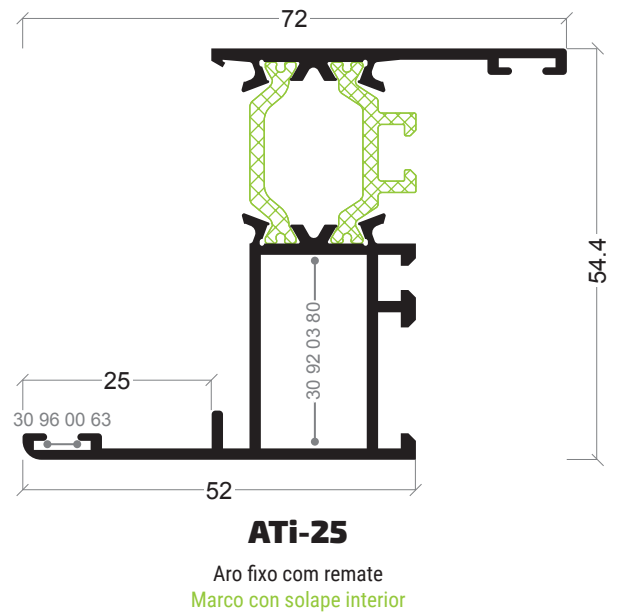
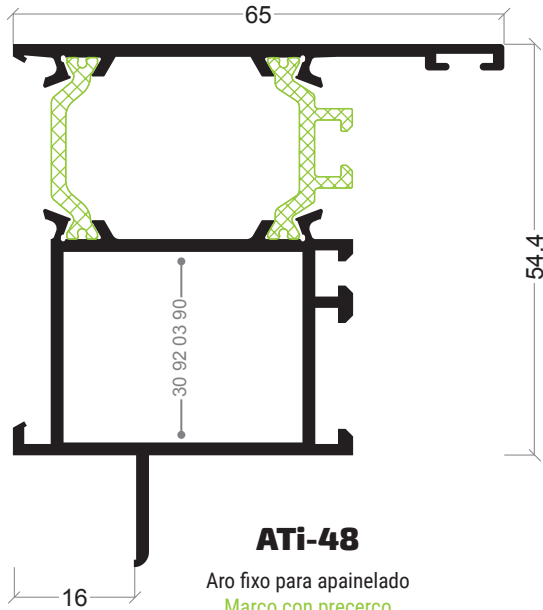

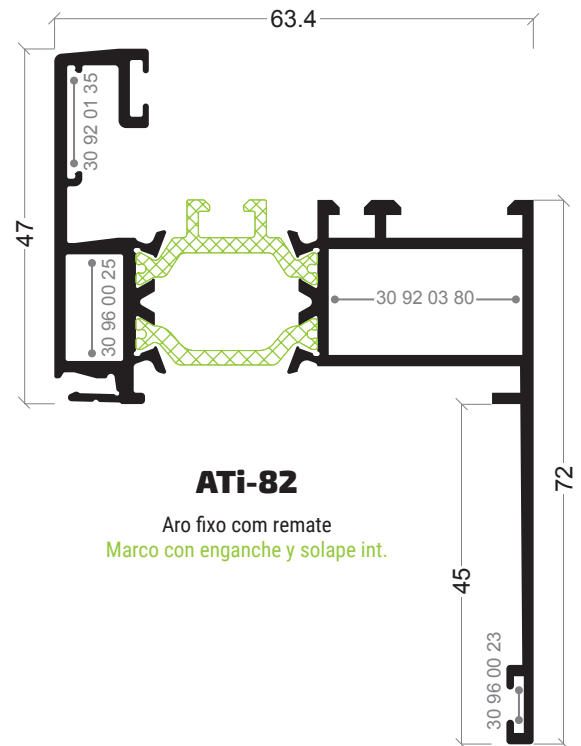
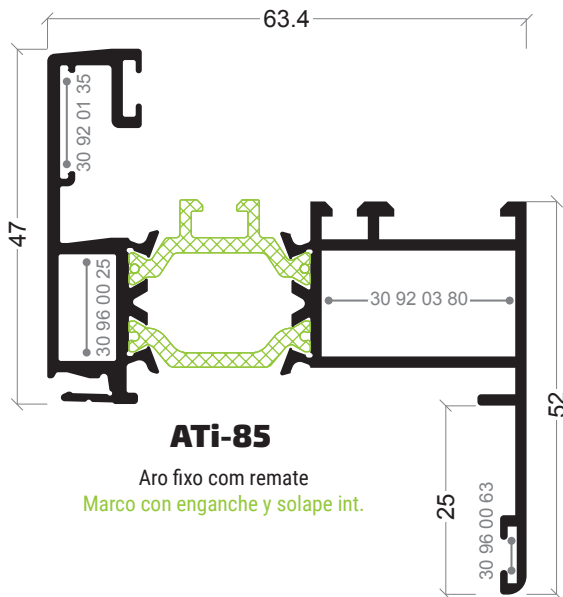
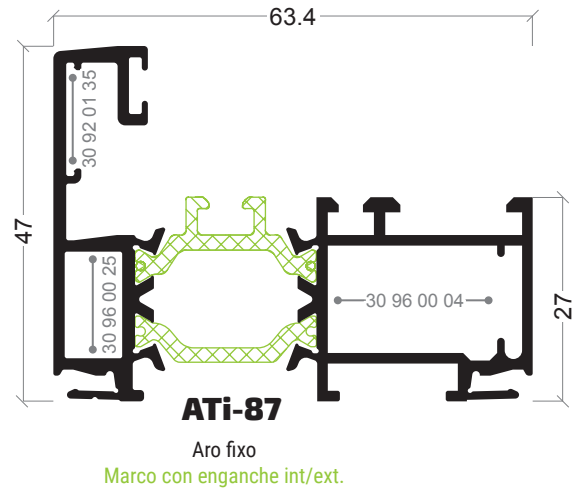
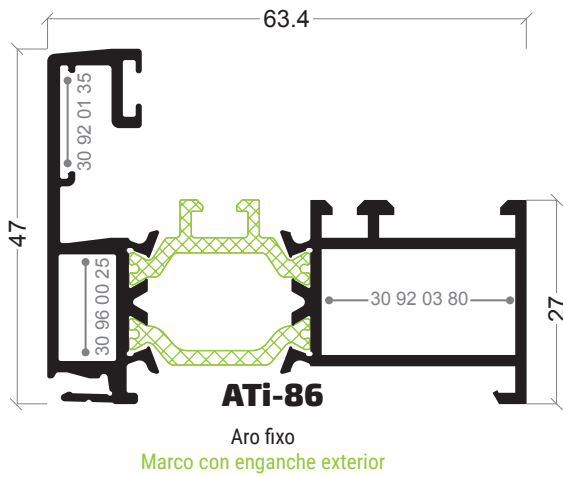
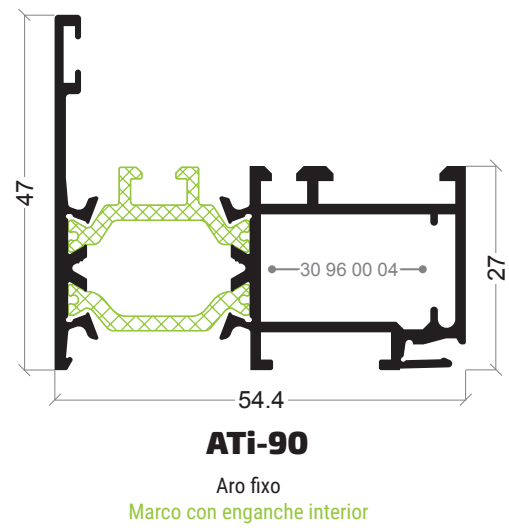
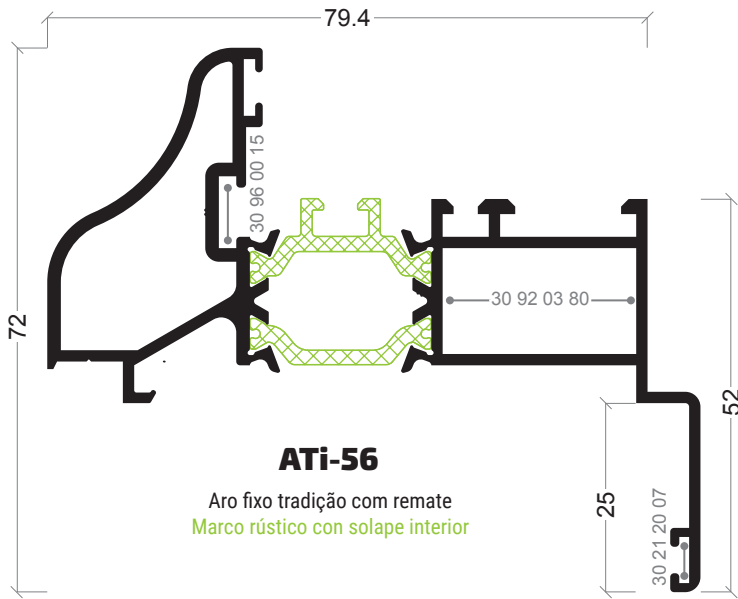

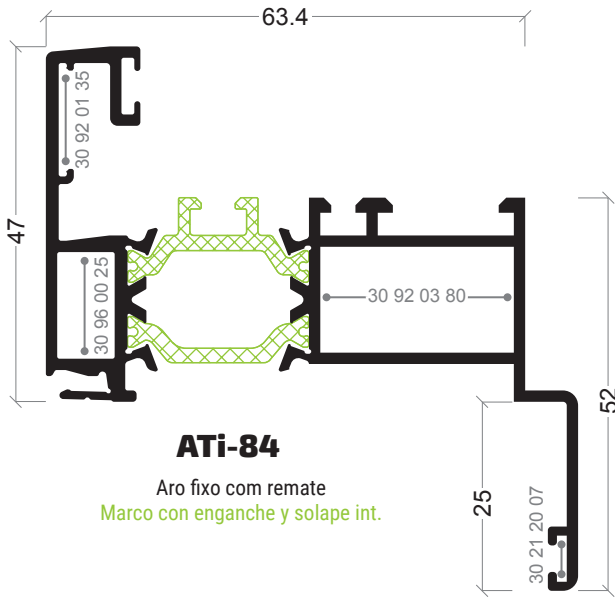

ATi-84

Aro fixo com remate
Marco con enganche y solape int.

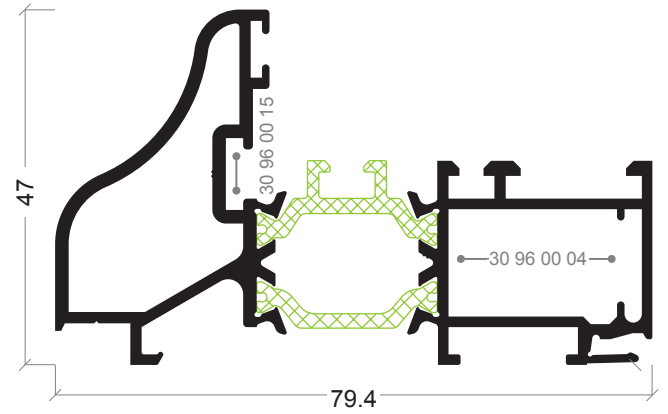

ATi-92

Aro fixo tradição
Marco rustico con enganche int.

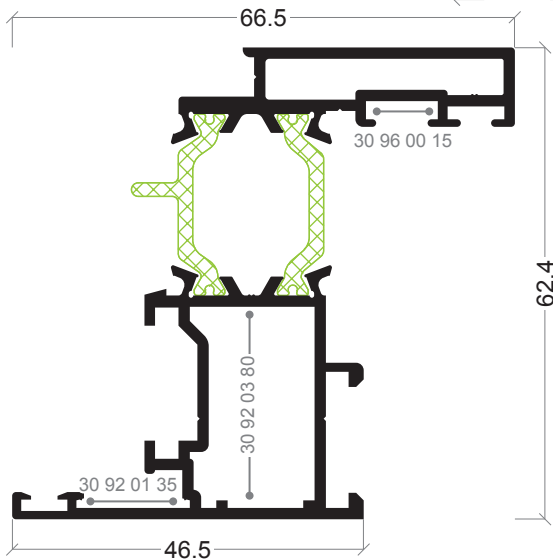

ATi-64

Aro móvel
Hoja ventana

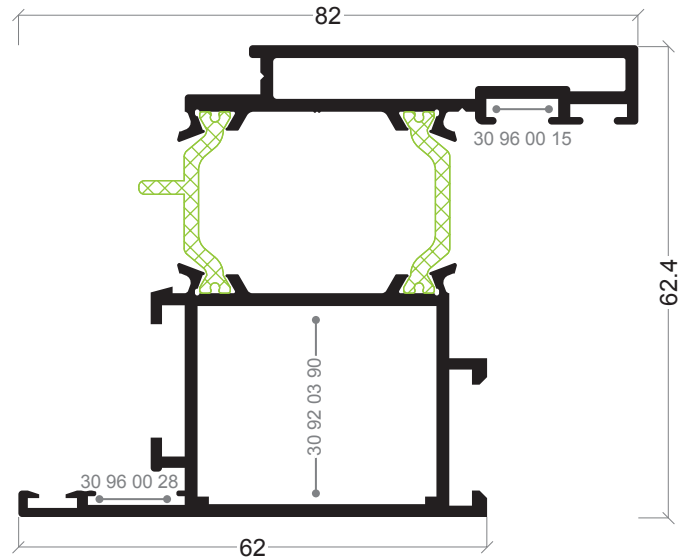

ATi-65

Aro móvel
Hoja puerta

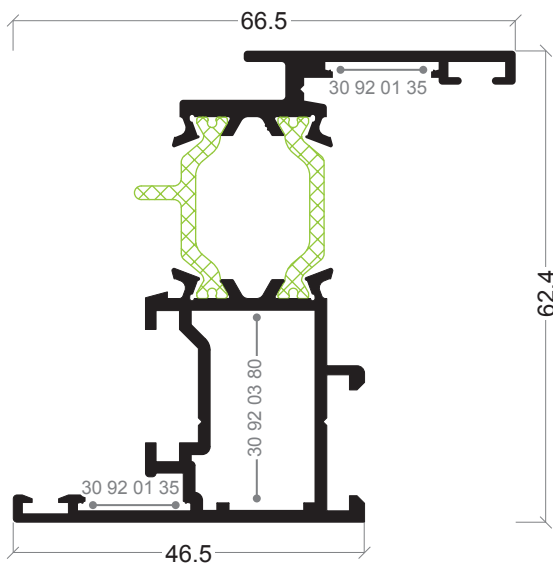

ATi-02

Aro móvel
Hoja ventana

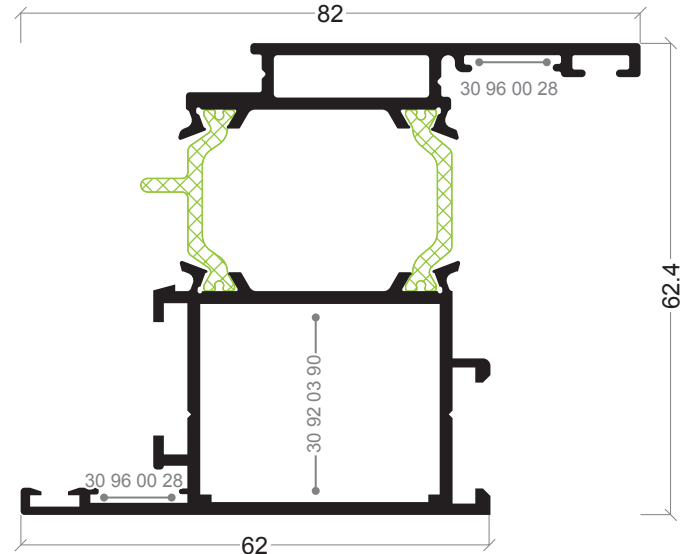

ATi-07

Aro móvel
Hoja puerta

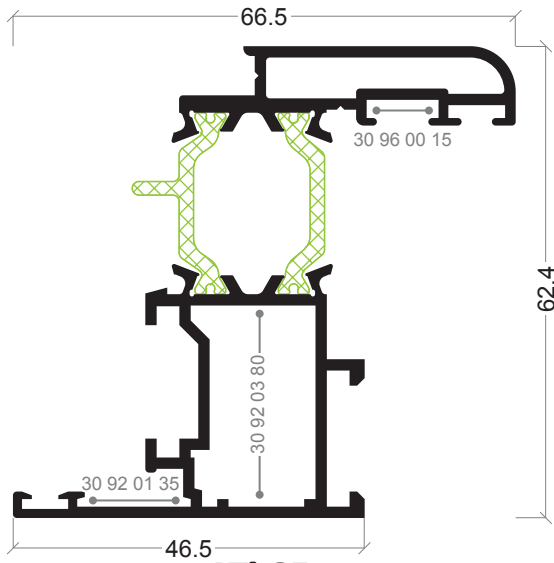

ATi-05

Aro móvel
Hoja ventana

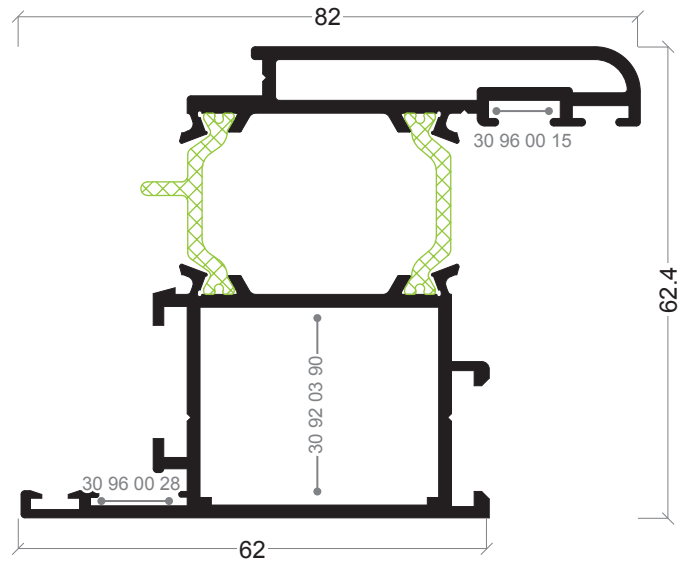

ATi-10

Aro móvel
Hoja puerta

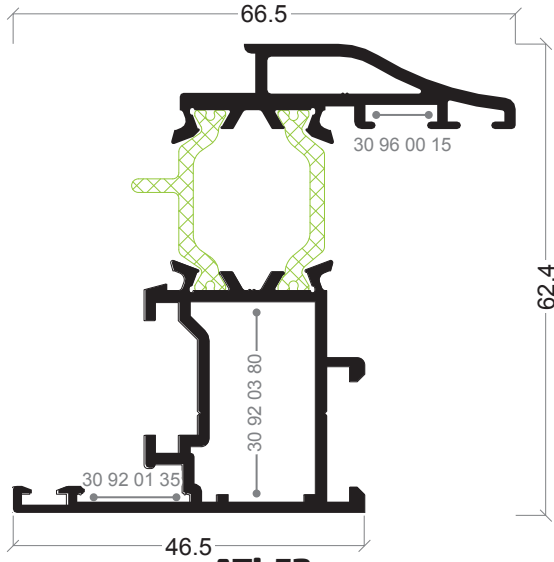

ATi-52

Aro móvel tradição
Hoja ventana rústico

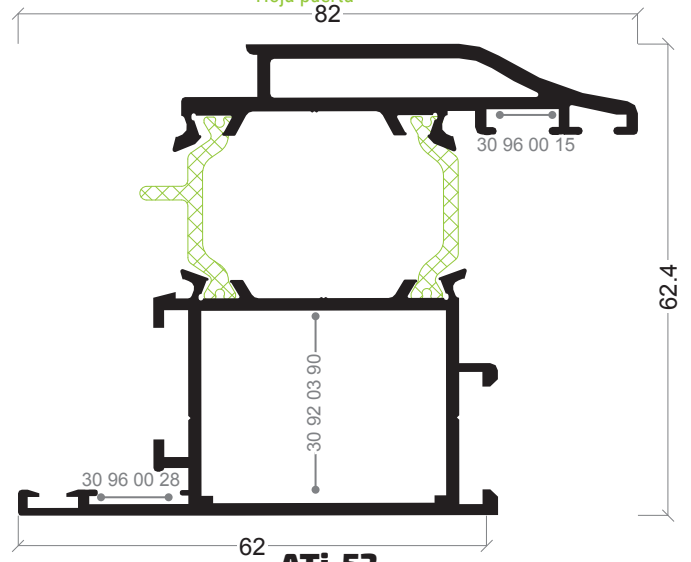

ATi-53

Aro móvel tradição
Hoja puerta rústico

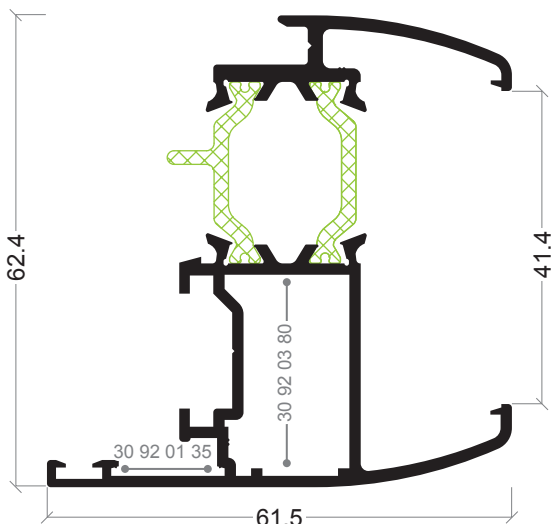

ATi-76

Aro móvel sem bite
Hoja ventana sin junquillo

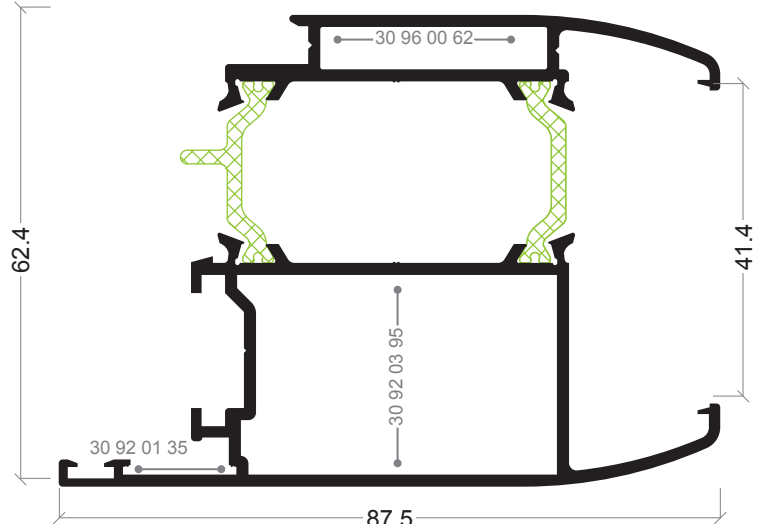

ATi-77

Aro móvel sem bite
Hoja puerta sin junquillo

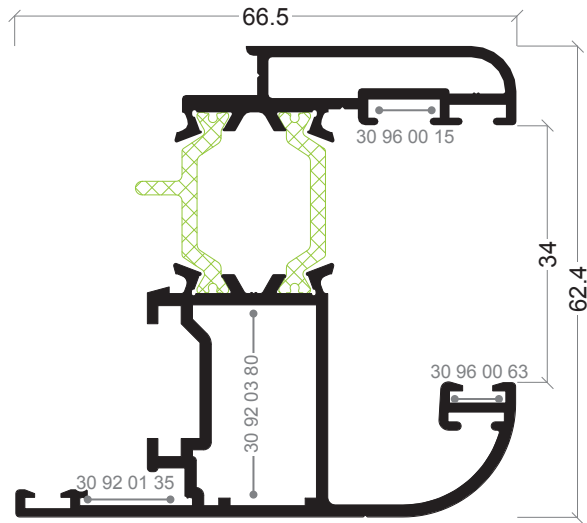

ATi-44

Aro móvil
Hoja ventana sin junquillo

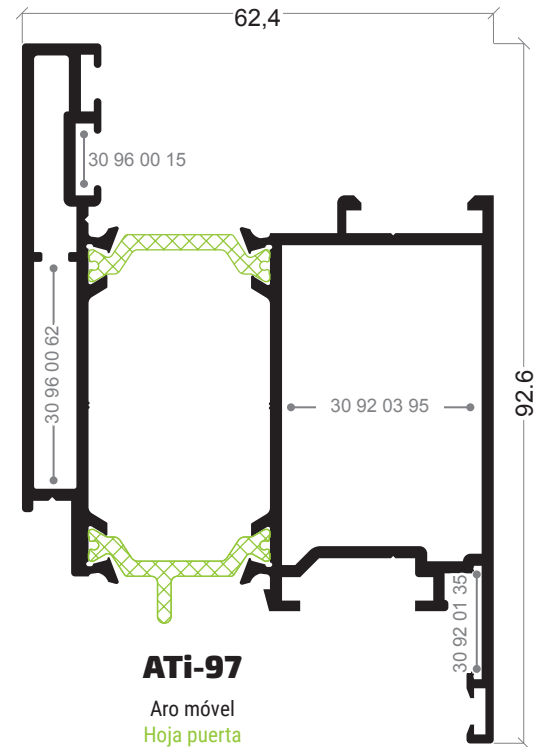

ATi-97

Aro móvil
Hoja puerta

44

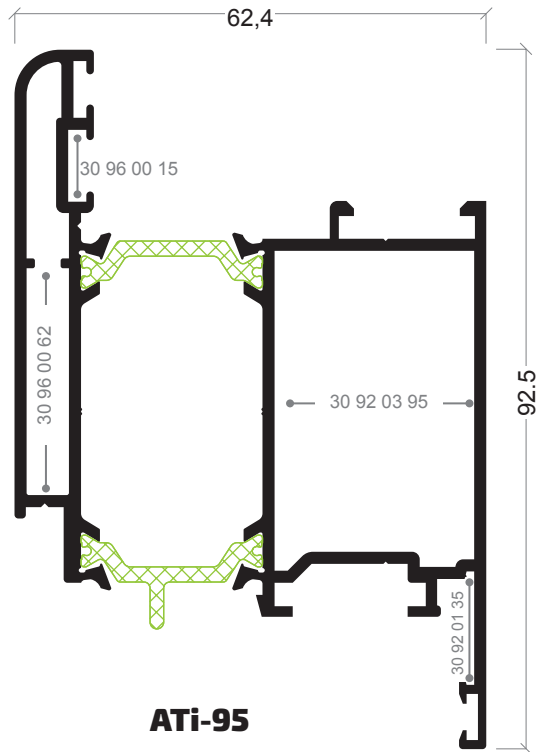

ATi-95

Aro móvil
Hoja puerta

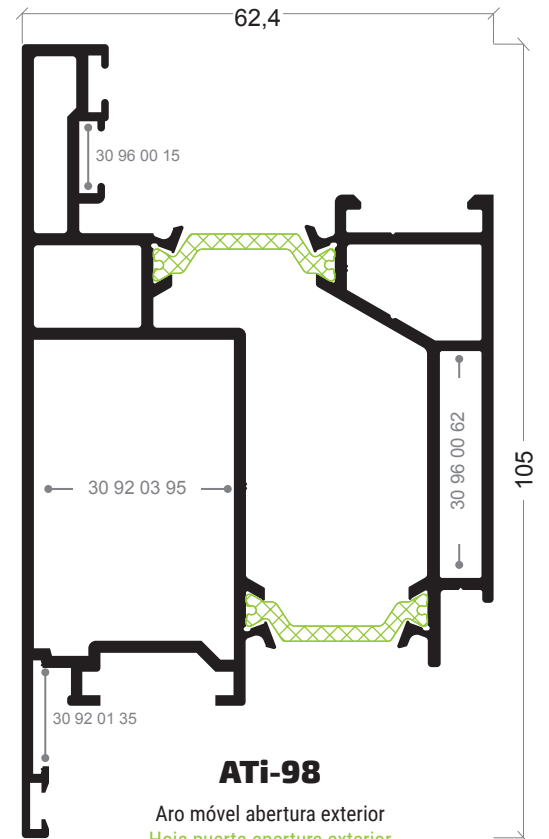

ATi-98

Aro móvil abertura exterior
Hoja puerta apertura exterior

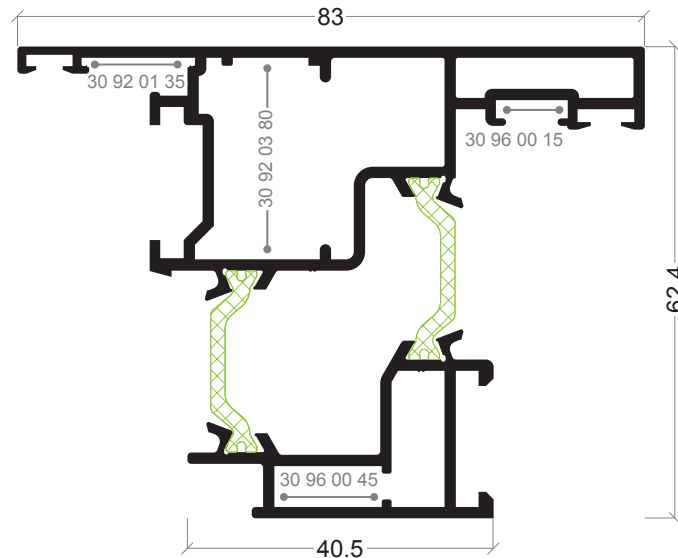

ATi-60

Aro móvel abertura exterior
Marco abertura exterior

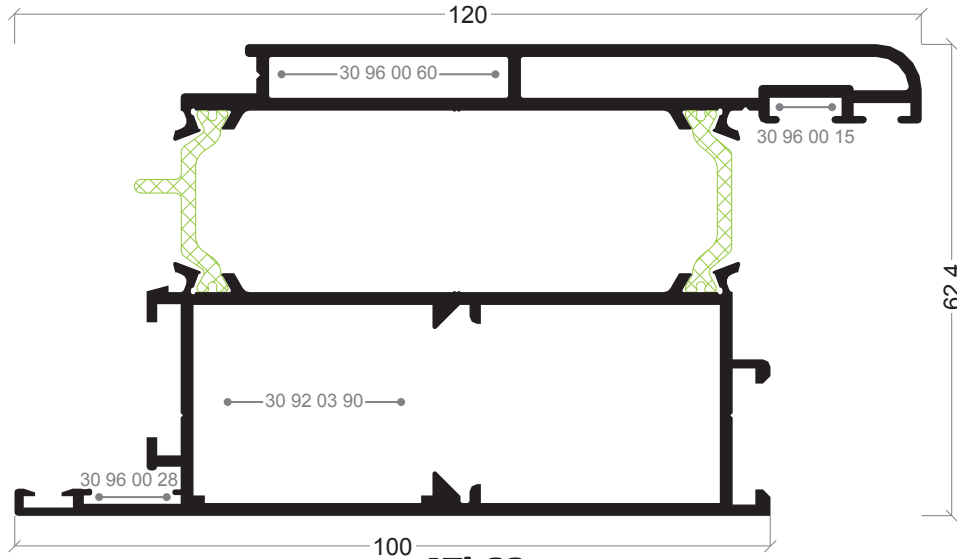

ATi-66

Aro móvel
Hoja puerta

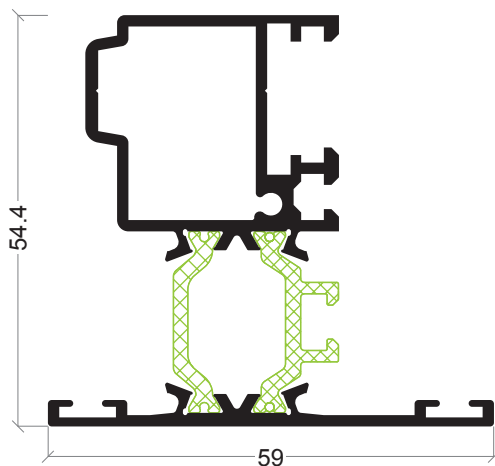

ATi-04

Inversor
Inversor

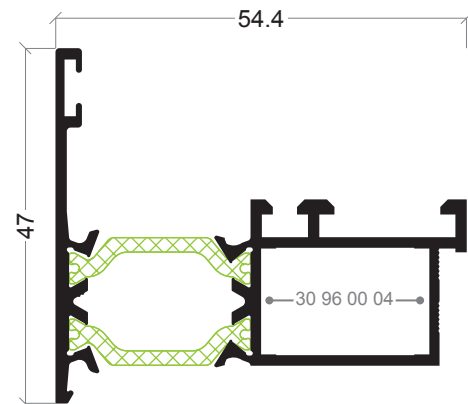

ATi-75

Inversor abertura exterior
Inversor abertura exterior

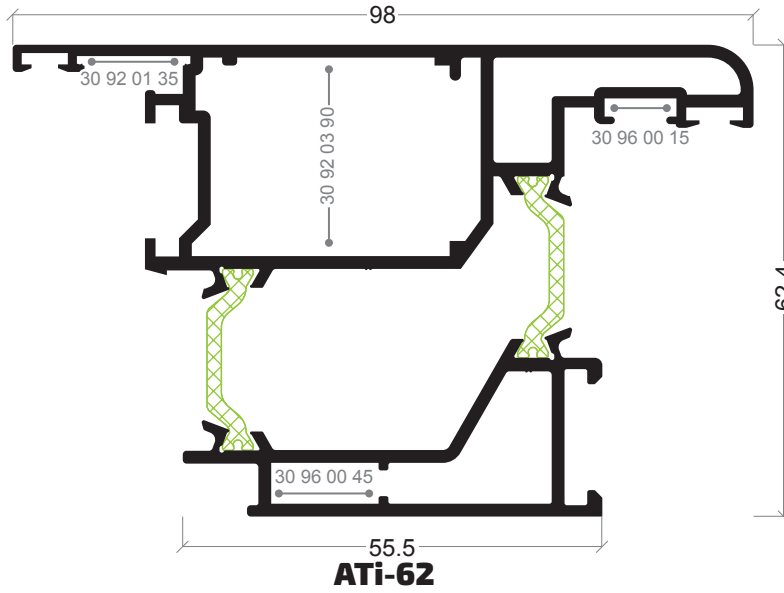

Aro móvel abertura exterior
Hoja apertura exterior

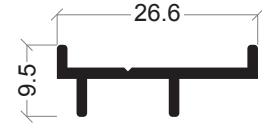

AXi-32

Complemento abertura projetante
Complemento abertura proyectante

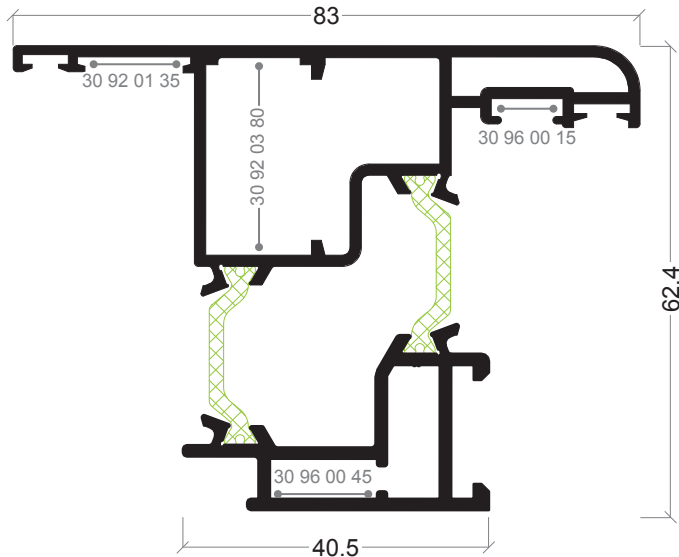

Aro móvel projetante
Marco proyectante

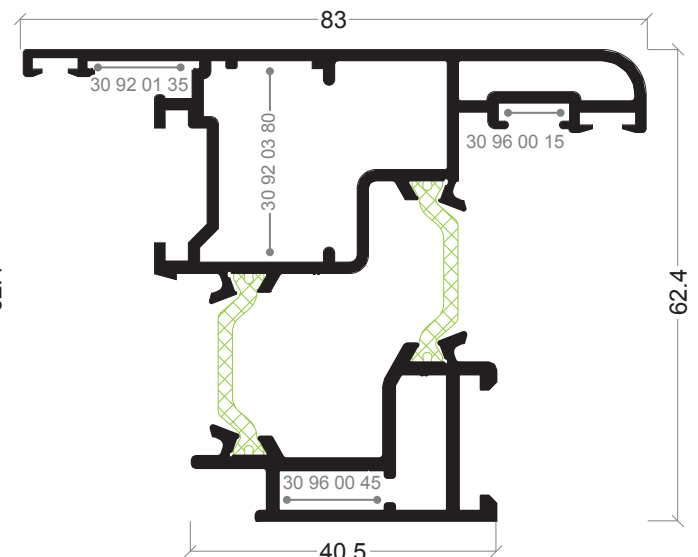

Aro móvel abertura exterior
Hoja apertura exterior

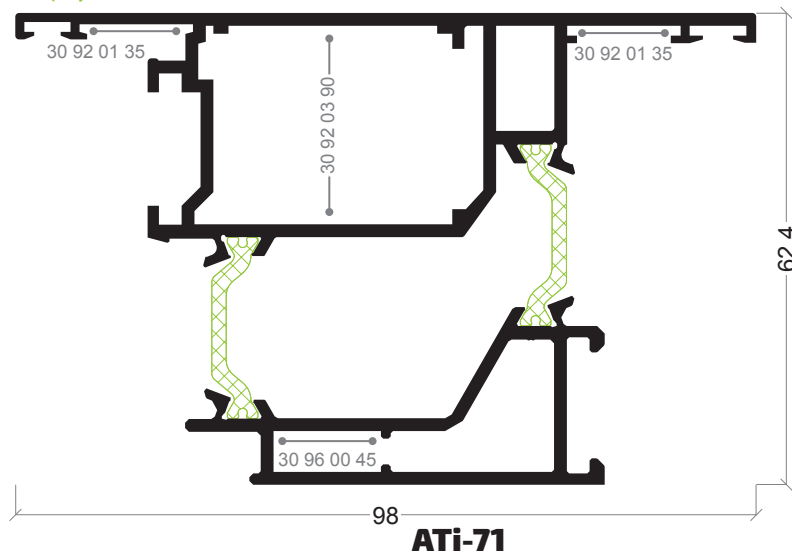

Aro móvel abertura exterior
Hoja apertura exterior

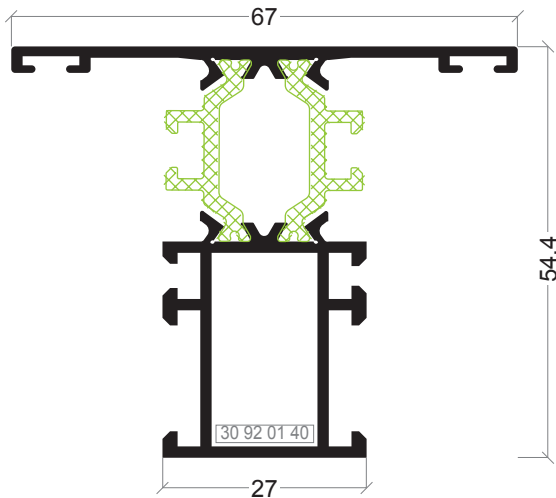

ATi-01

Travessa
Travesaño ventana

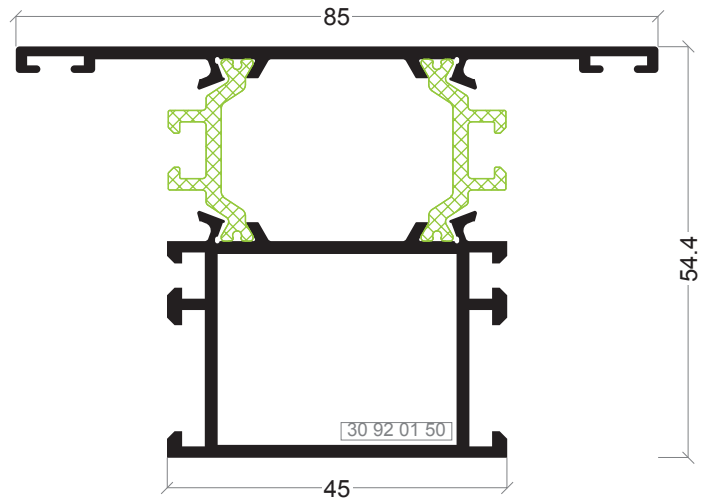

ATi-06

Travessa
Travesaño puerta

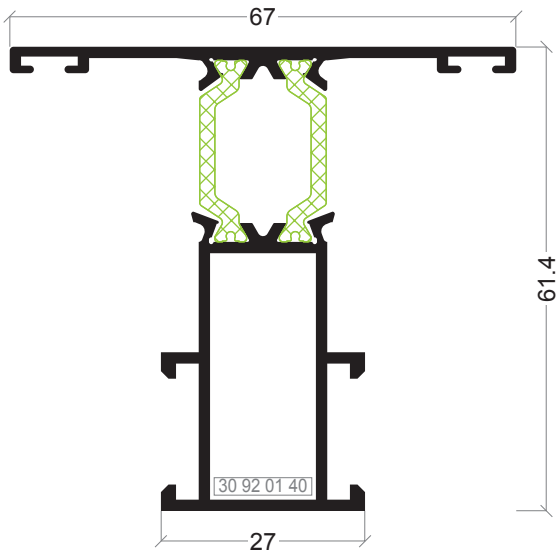

ATi-09

Travessa
Travesaño ventana

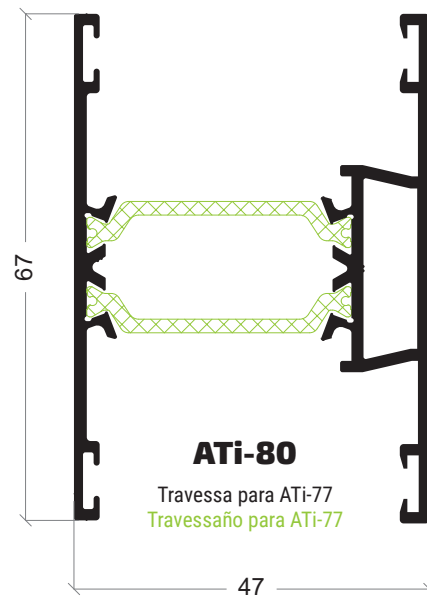

ATi-80

Travessa para ATi-77
Travesaño para ATi-77

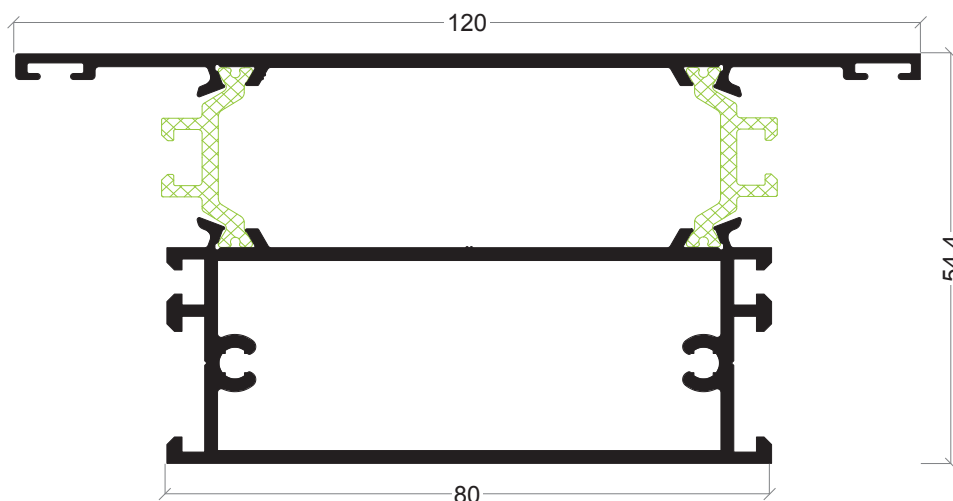

ATi-12

Travessa
Zócalo 120x55mm

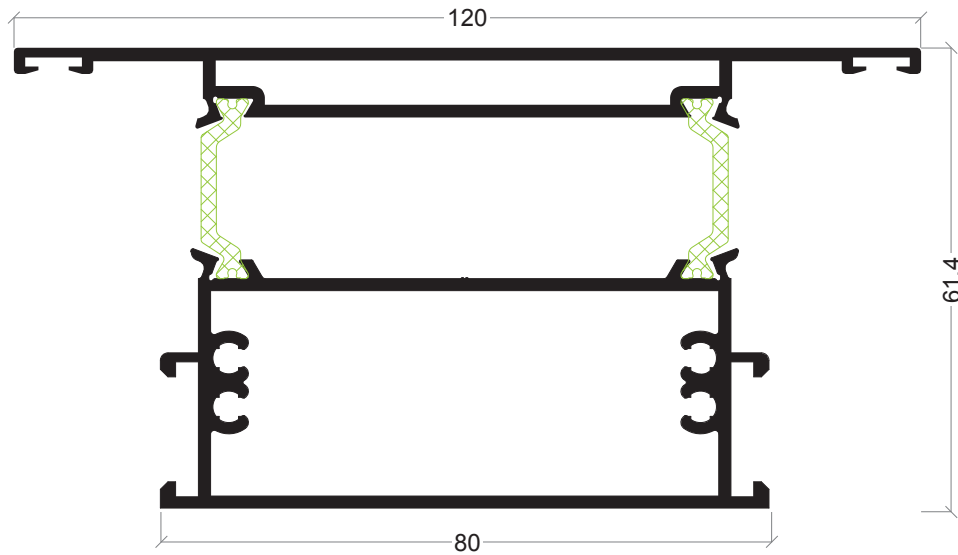

ATi-14

Travessa
Zócalo 120x62mm

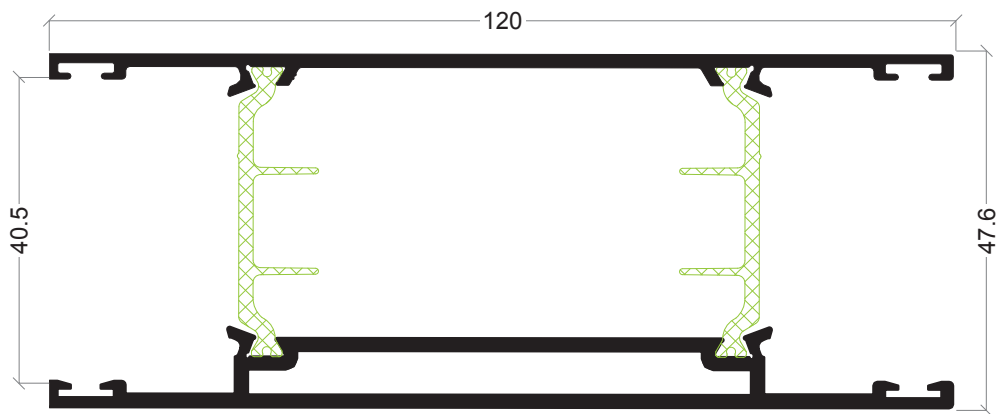

ATi-79

Travessa
Travesaño para ATi-77

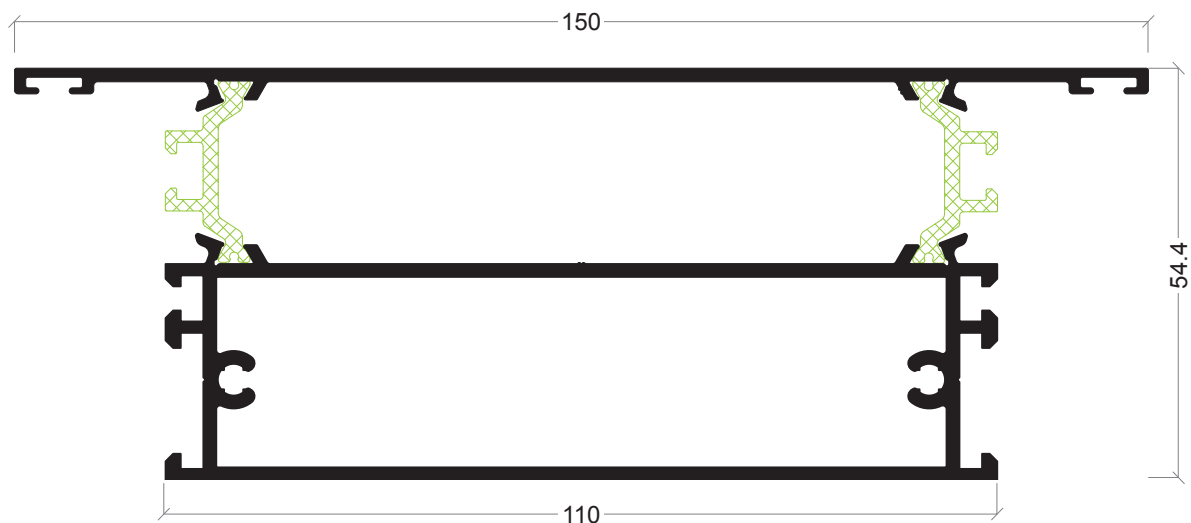

ATi-13

Travessa
Zócalo 150x55mm

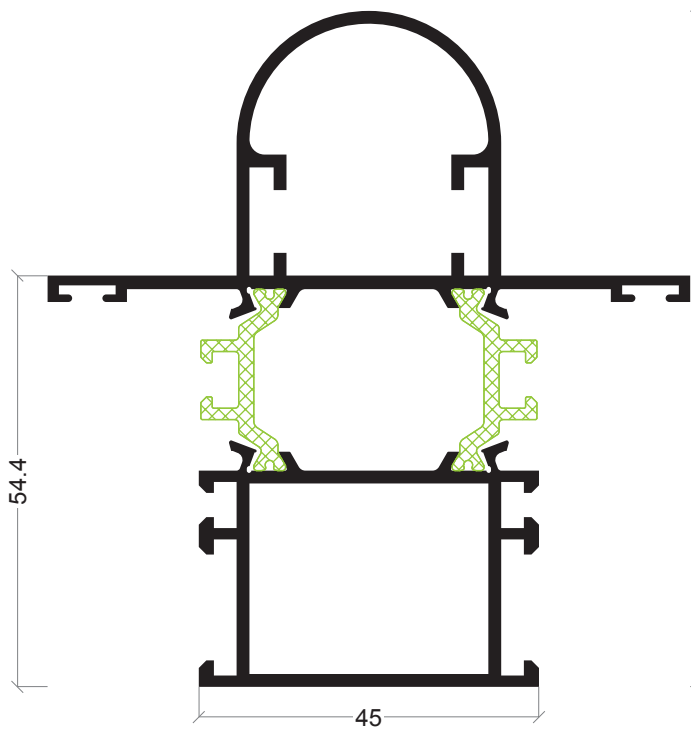

ATi-17
Montante curvo
Rigidizador 90mm curvo

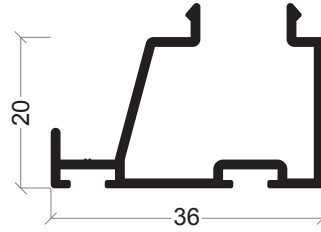

AX-15
Bite remate
Junquillo acople

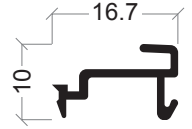

AX-33
Mola bite
Grapa junquillo



AX-19
Vareta
Pletina falleba



CT-94
Perfil de união
Perfil de unión

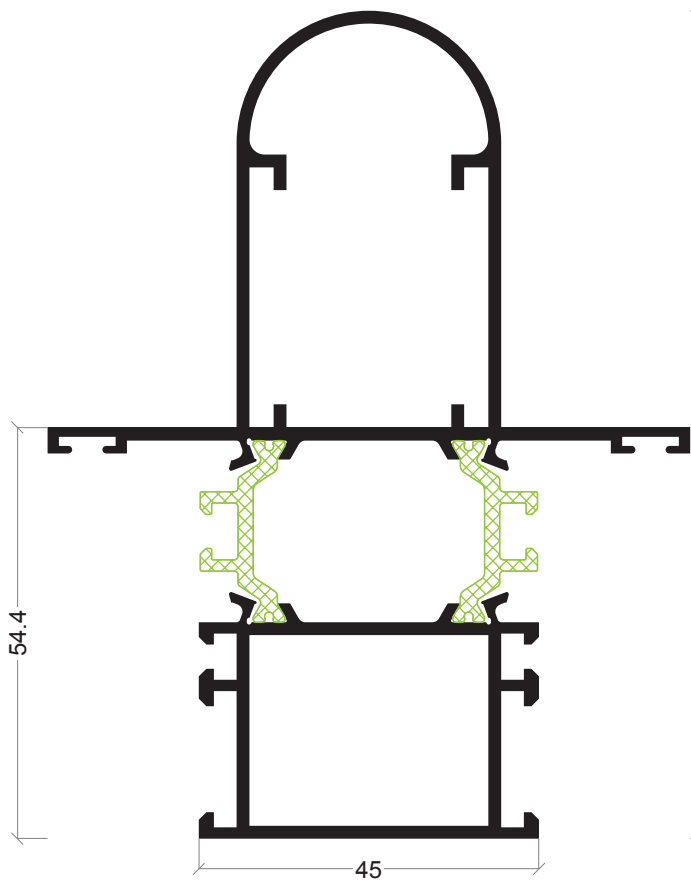

ATi-18
Montante curvo
Rigidizador 110mm curvo

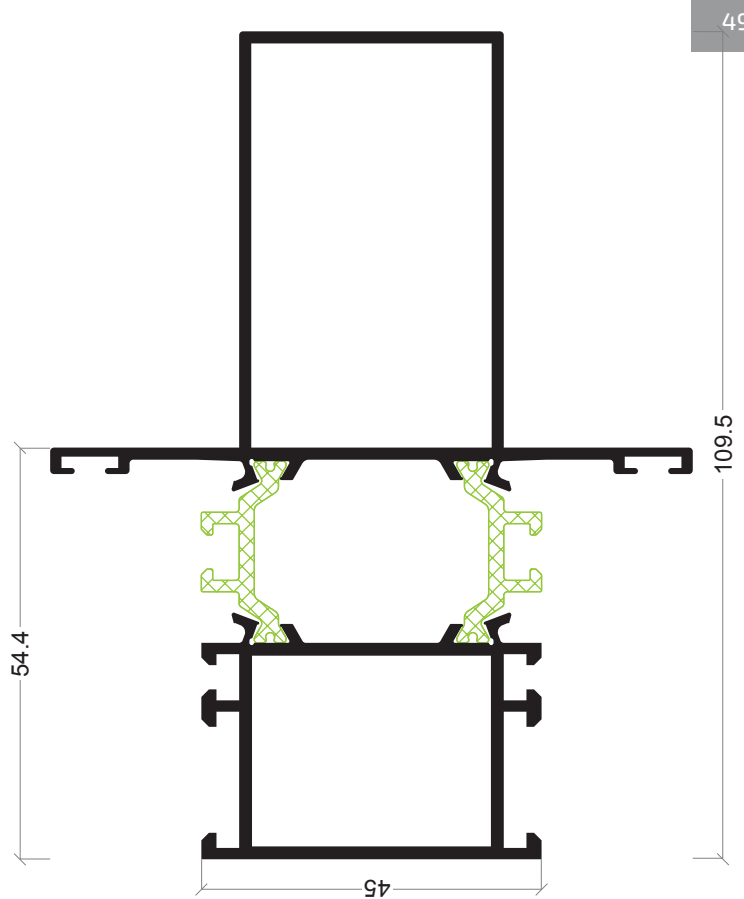

ATi-78
Montante recto
Rigidizador 110mm recto

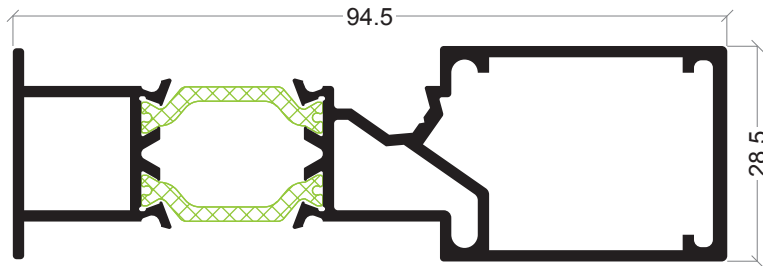

ATi-67

União de aros com reforço
Unión de marcos con refuerzo

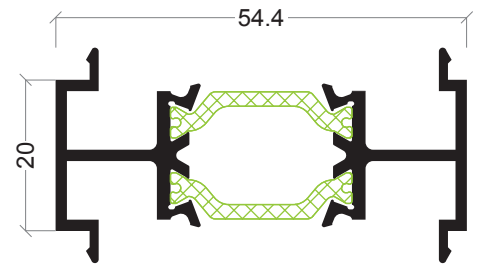

ATi-15

União de aros
Unión de marcos

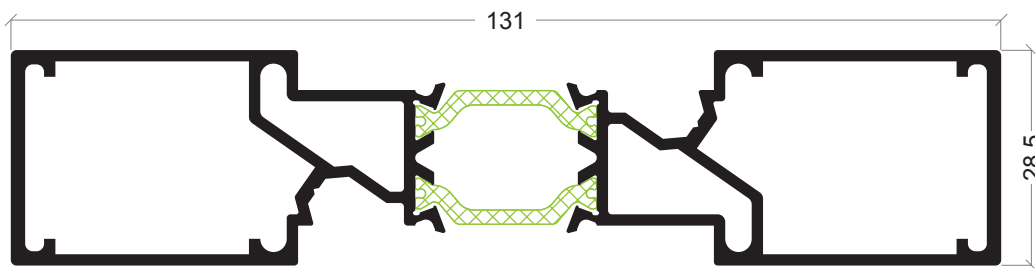

ATi-68

União de aros com reforço
Unión de marcos con doble refuerzo

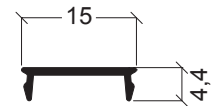

KL-04

Tampa
Tope

50

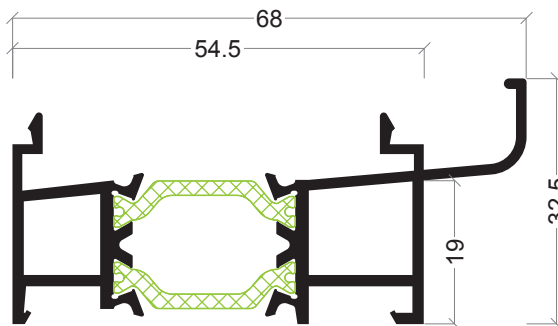

ATi-57

Soleira condensação
Condensación con alargadera

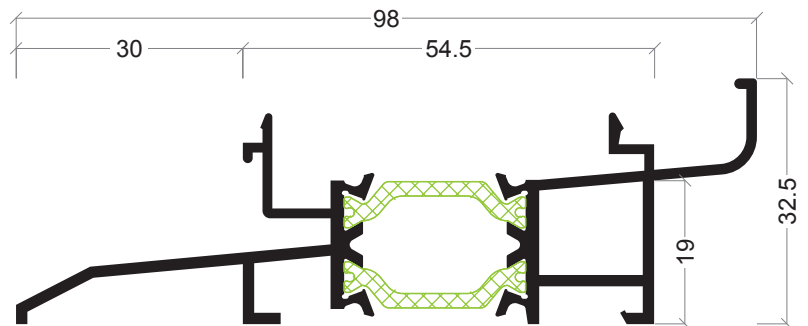

ATi-29

Soleira condensação
Condensación con alargadera

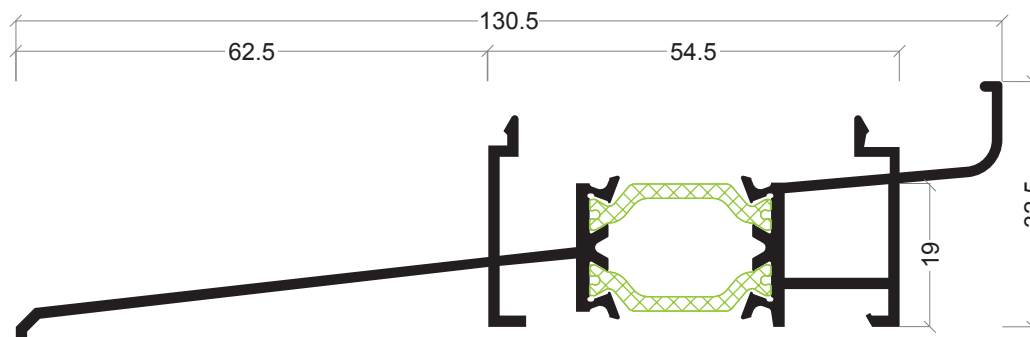

ATi-30

Soleira condensação
Condensación con alargadera

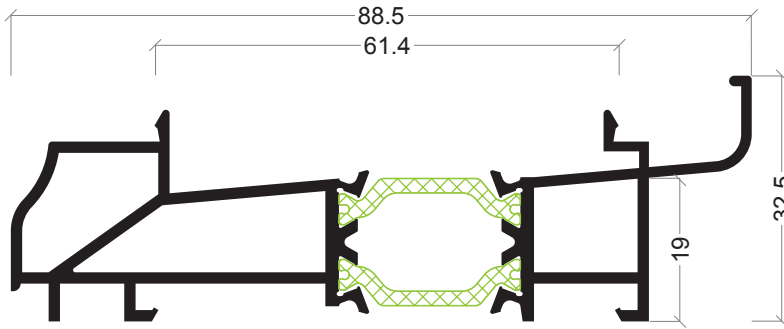

ATi-55

Soleira condensação
Condensación rústica

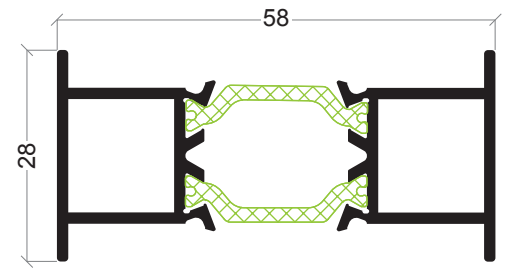

ATi-54

União de aros
Unión de marcos

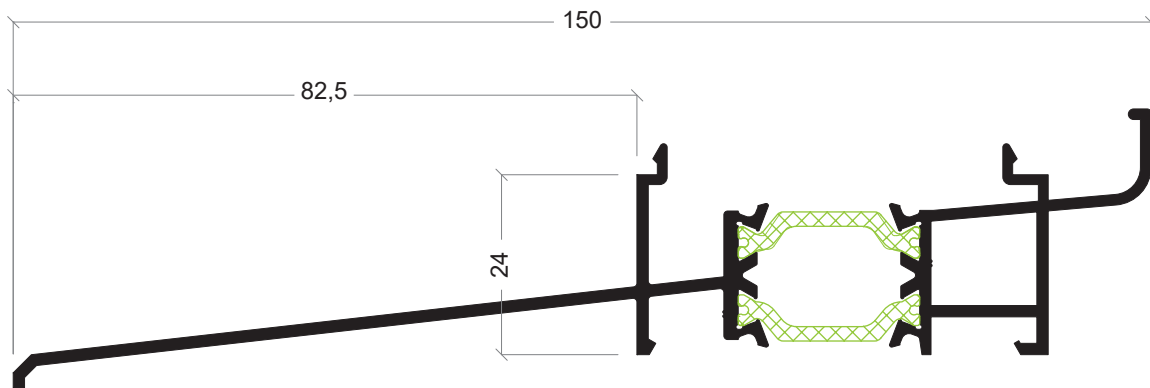

ATi-28

Soleira condensação
Condensación con alargadera

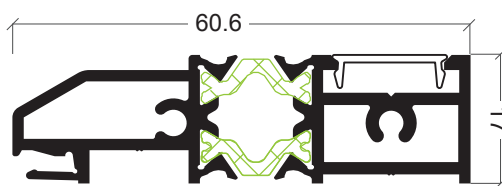

ARi-99

Soleira
Acople inferior

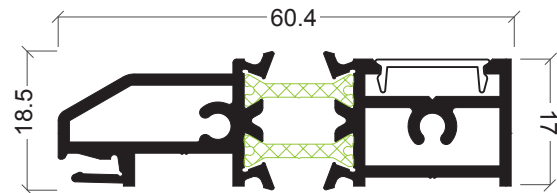

ARi-96

Soleira
Acople inferior

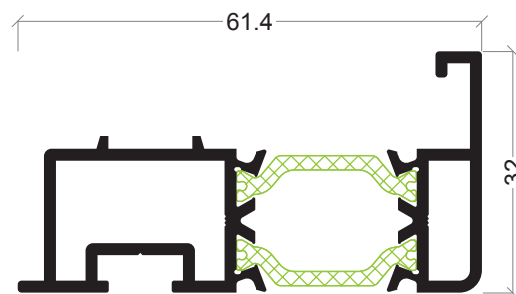

ATi-42

Remate almofada
Acople de hoja p/ zocalo inferior

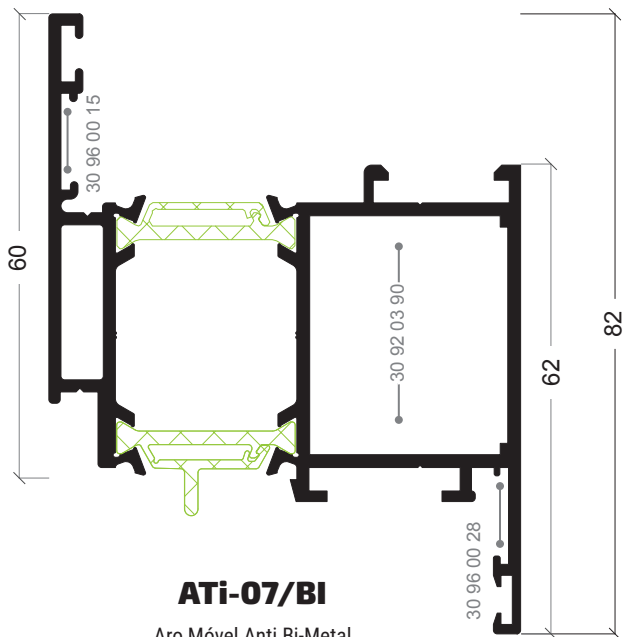

ATi-07/BI
Aro Móvel Anti Bi-Metal
Hoja Ant Bi-Metal

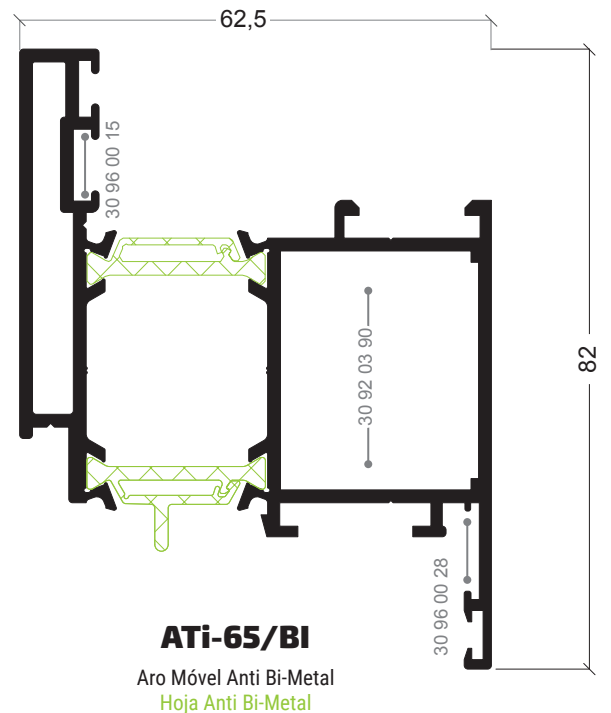

ATi-65/BI
Aro Móvel Anti Bi-Metal
Hoja Anti Bi-Metal

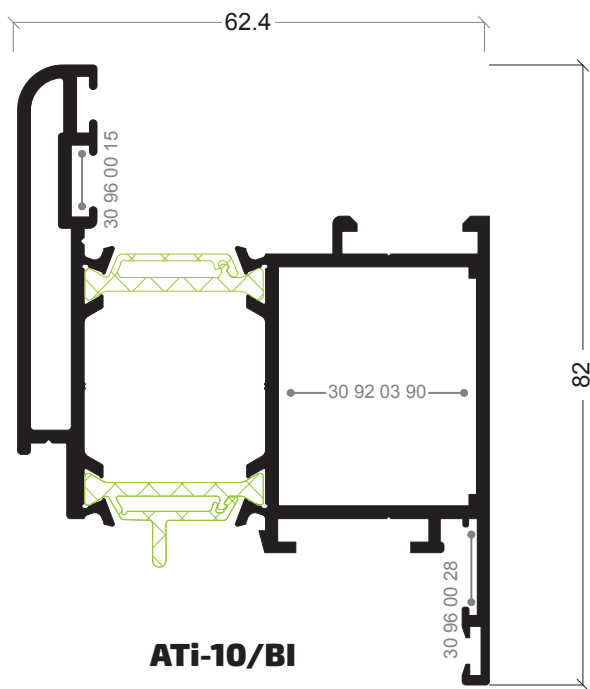

ATi-10/BI
Aro Móvel Anti Bi-Metal
Hoja Anti Bi-Metal

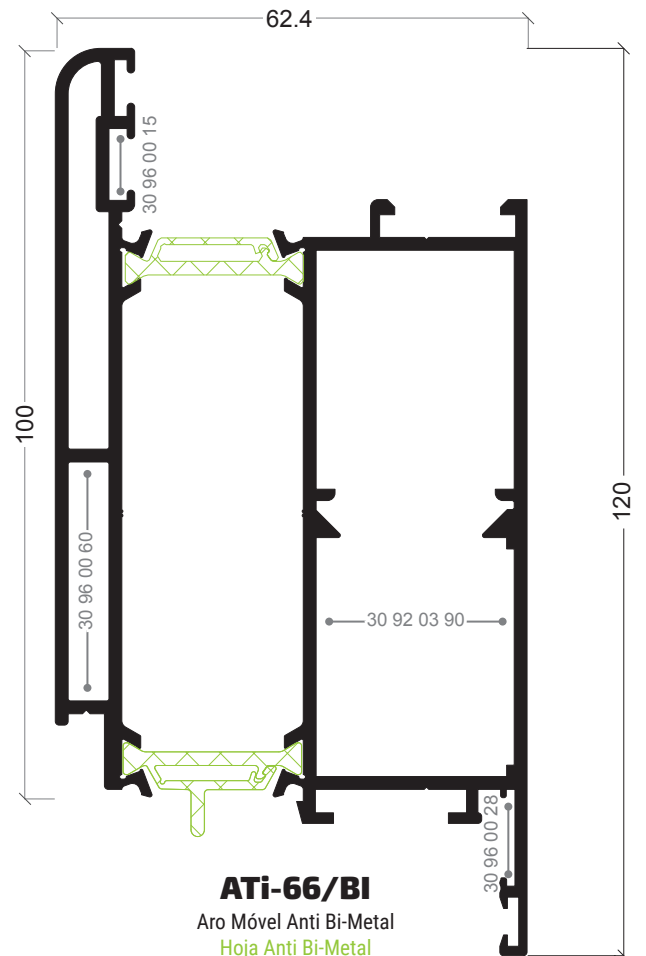

ATi-66/BI
Aro Móvel Anti Bi-Metal
Hoja Anti Bi-Metal

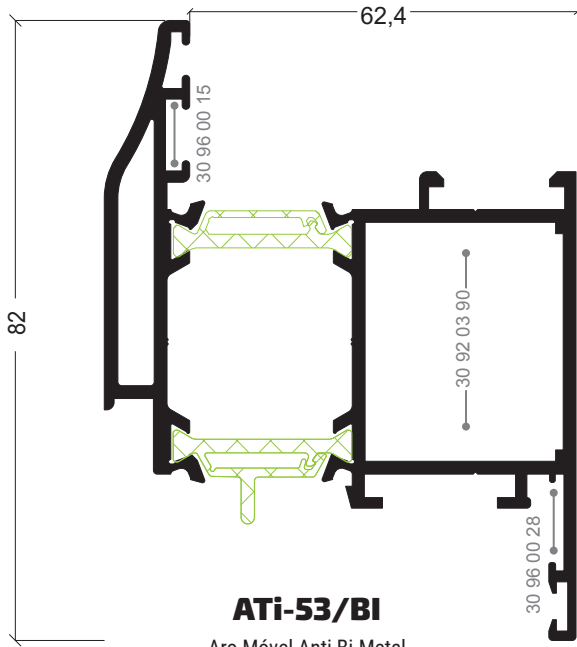

ATi-53/BI
Aro Móvel Anti Bi-Metal
Hoja Anti Bi-Metal

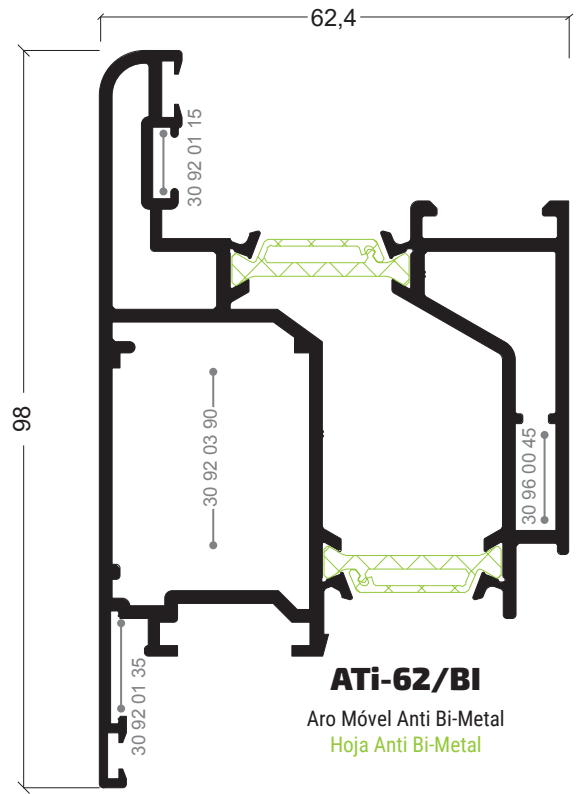

ATi-62/BI
Aro Móvel Anti Bi-Metal
Hoja Anti Bi-Metal

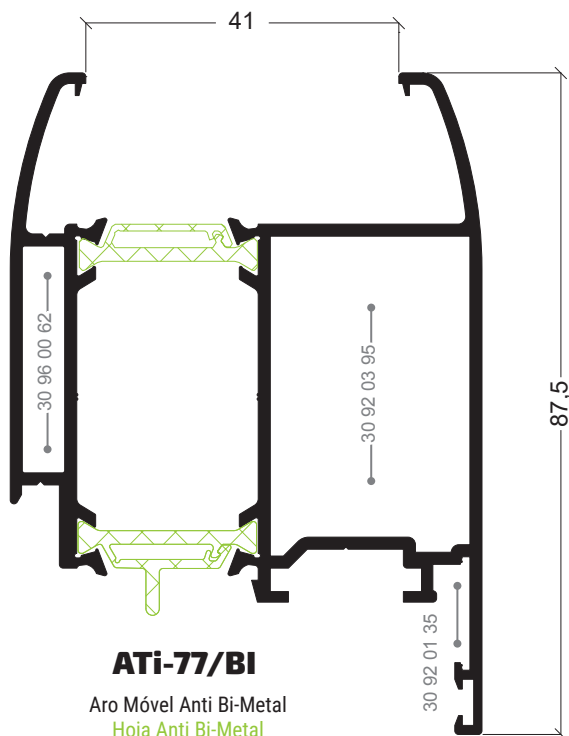

ATi-77/BI
Aro Móvel Anti Bi-Metal
Hoja Anti Bi-Metal

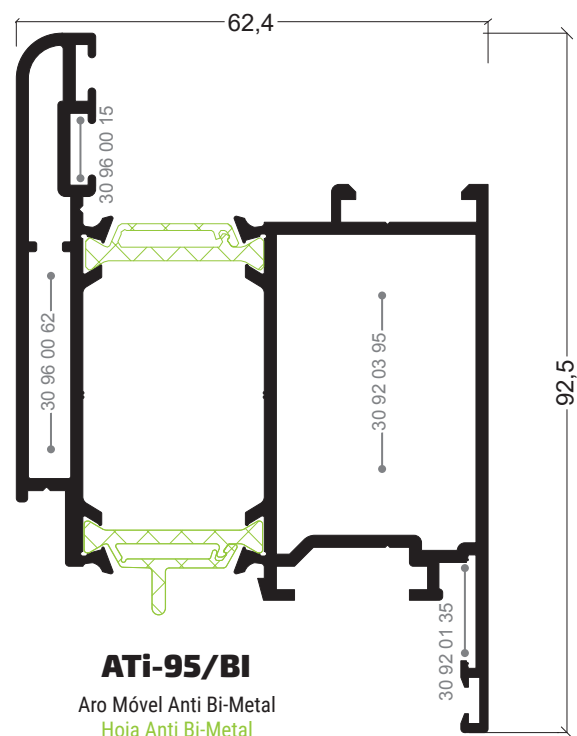

ATi-95/BI
Aro Móvel Anti Bi-Metal
Hoja Anti Bi-Metal

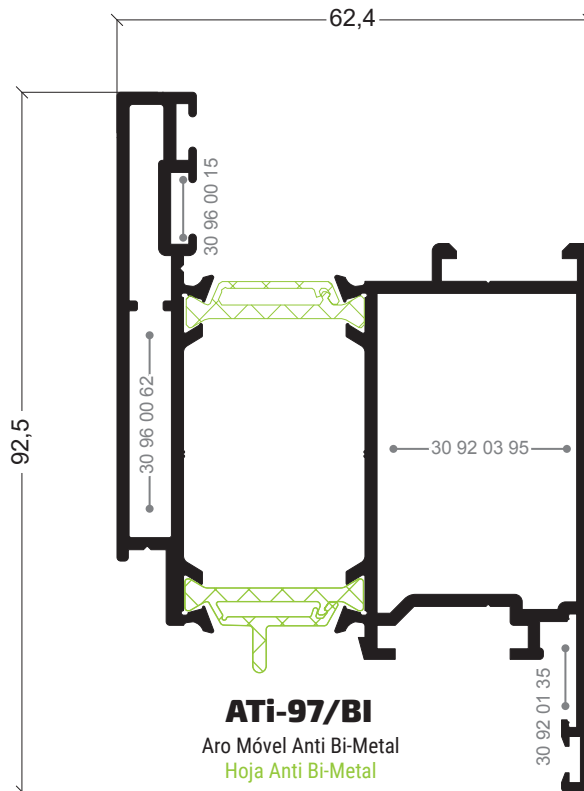
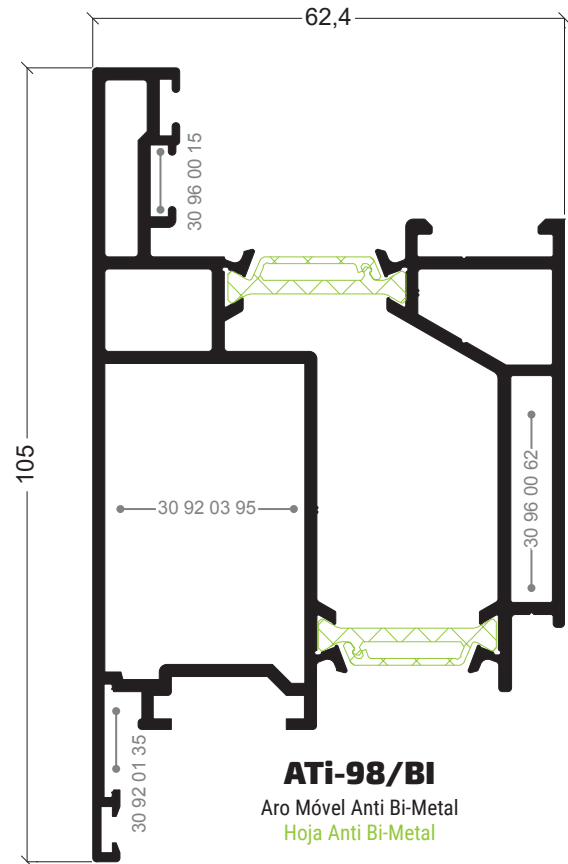
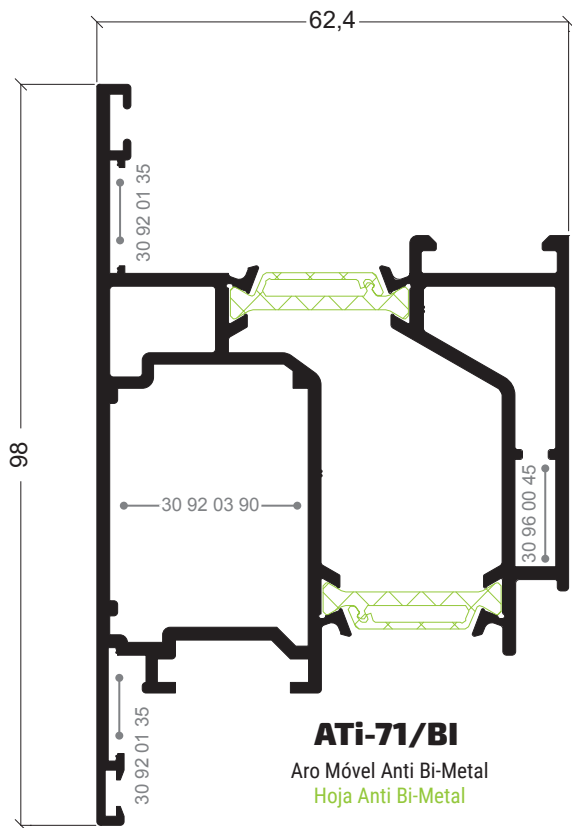

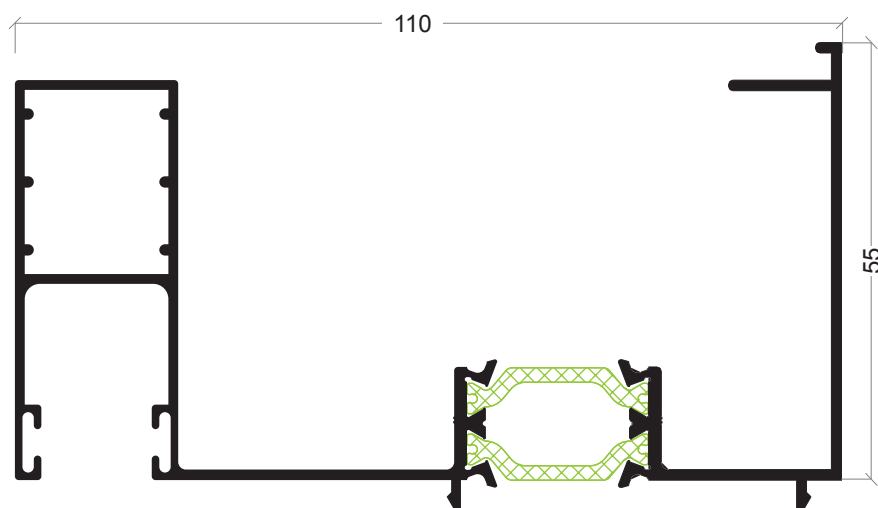

ATi-93

Pré-aro com calha estore
Guia de persiana

55

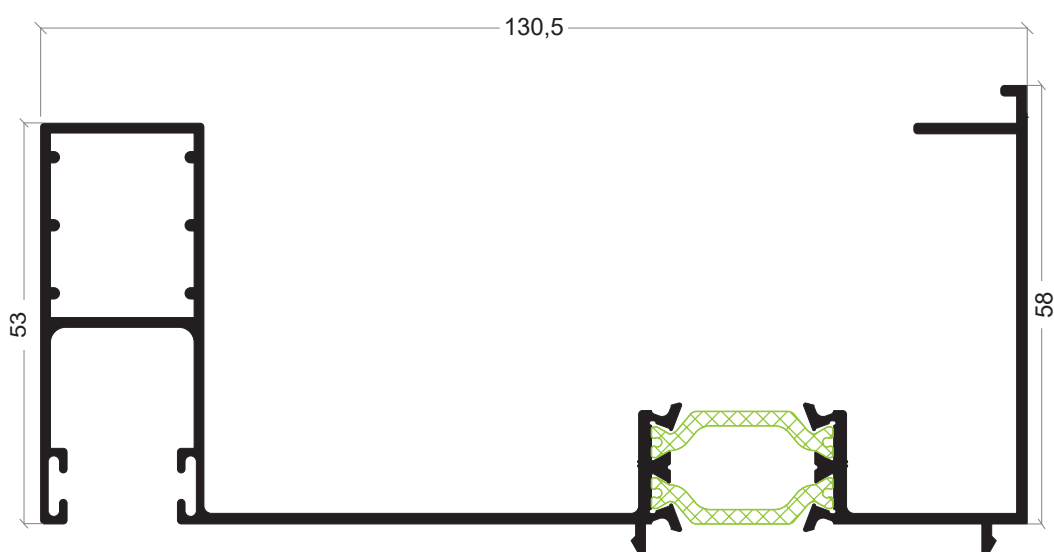

ATi-100

Pré-aro com calha estore
Guia de persiana

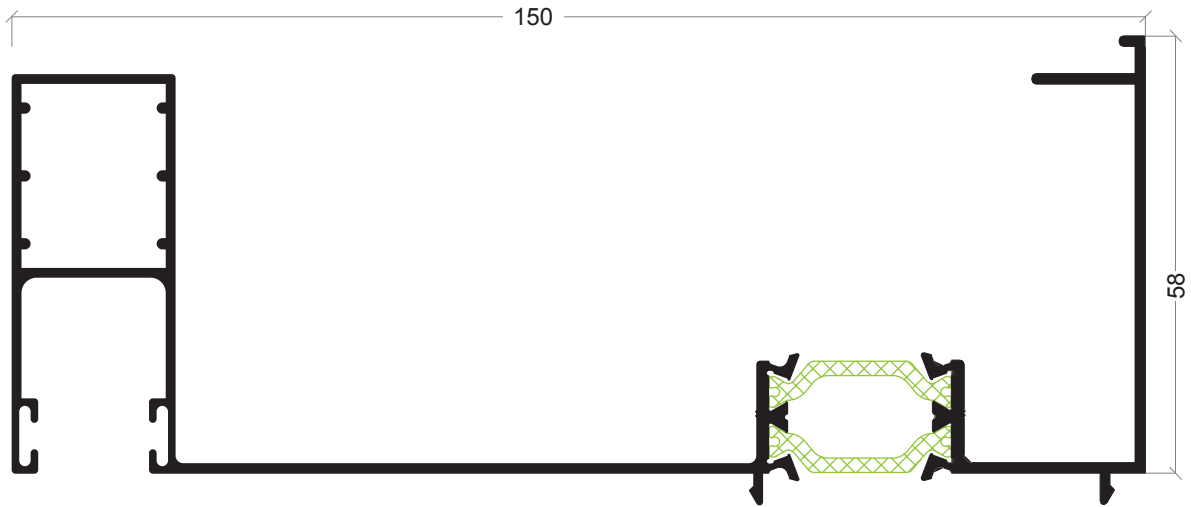

ATi-94

Pré-aro com calha estore
Guia de persiana

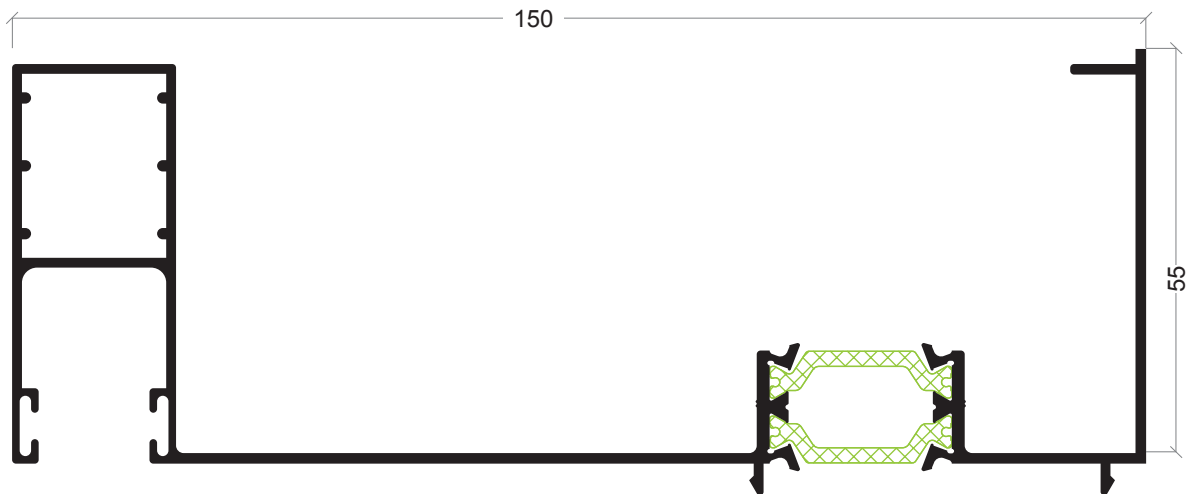

ATi-99

Pré-aro com calha estore
Guia de persiana

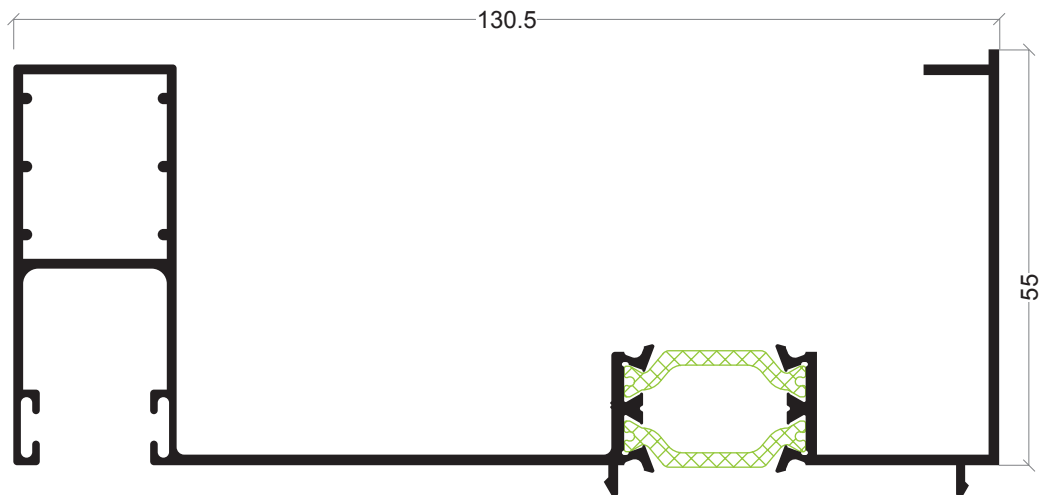

ATi-11

Pré-aro com calha estore
Guia de persiana

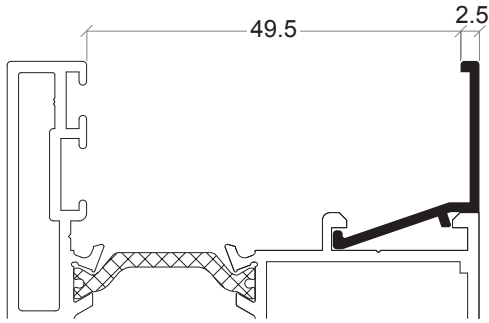

AX-69

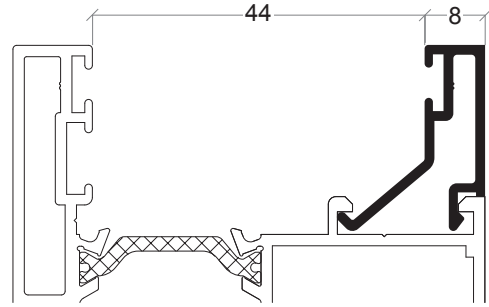

AX-74

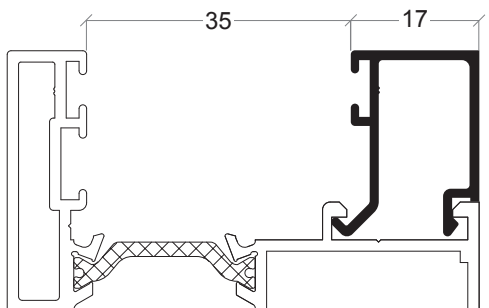

AX-46

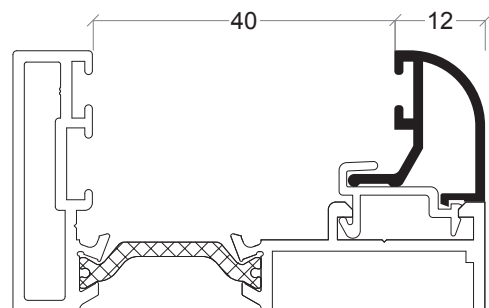

AX-37

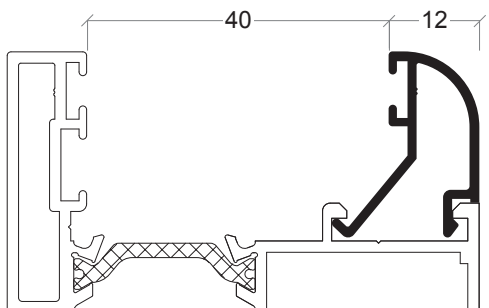

AZ-08

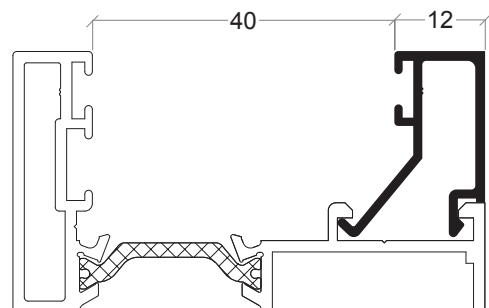

AX-36

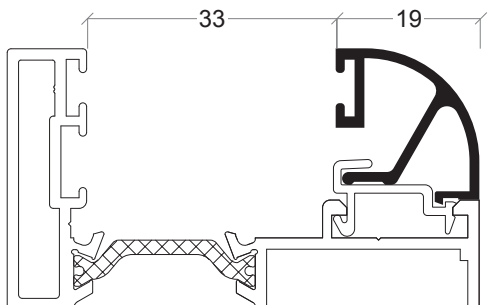

AX-30

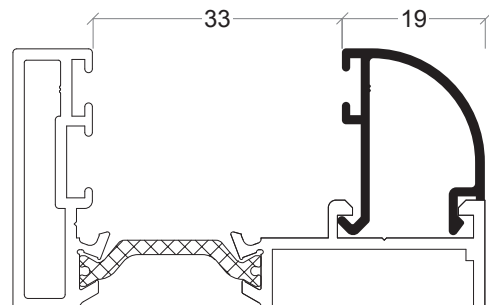

AZ-07

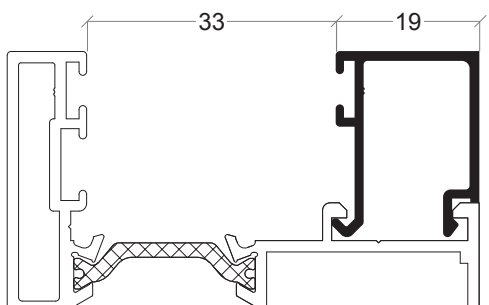

AX-35

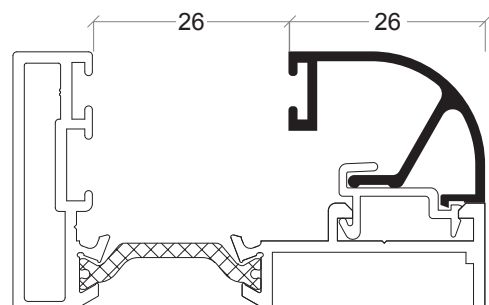

AX-29

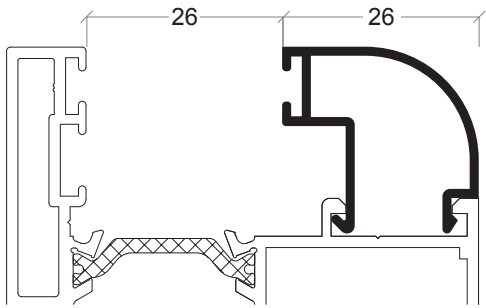

AZ-06

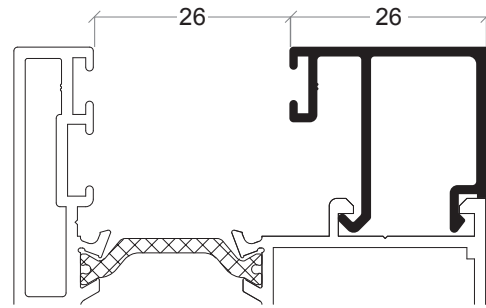

AX-31

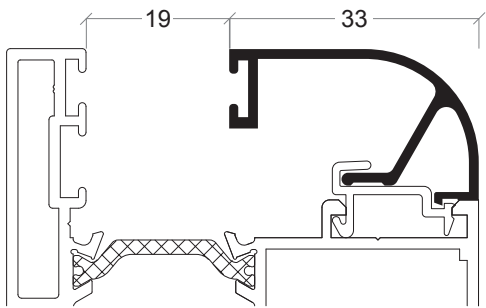

AX-39

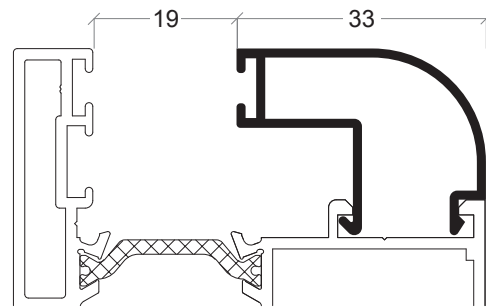

AZ-28

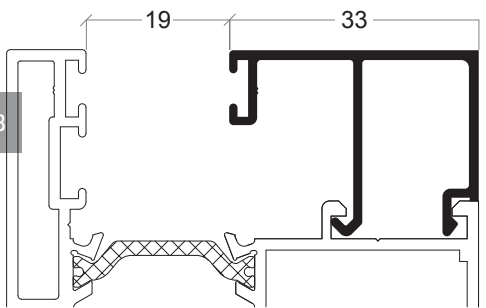

AX-34

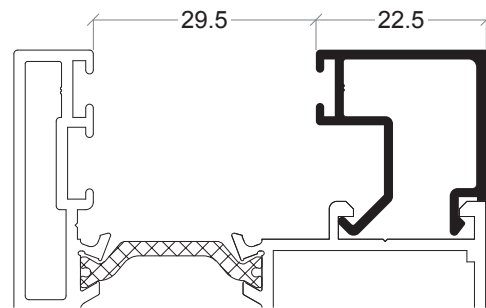

AX-78

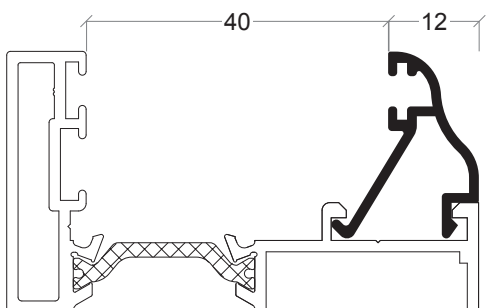

AX-73

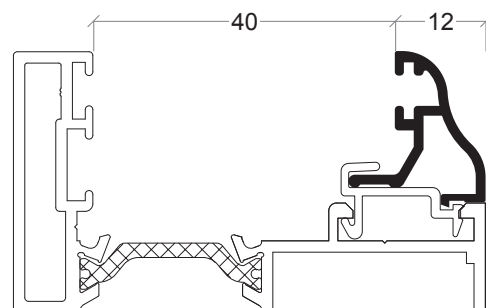

AX-72

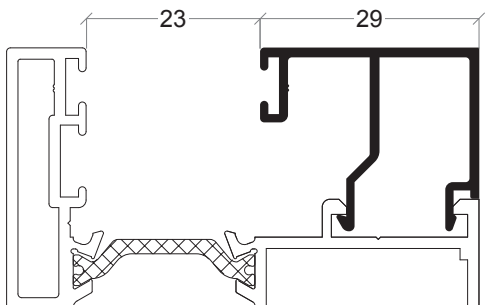

AX-81

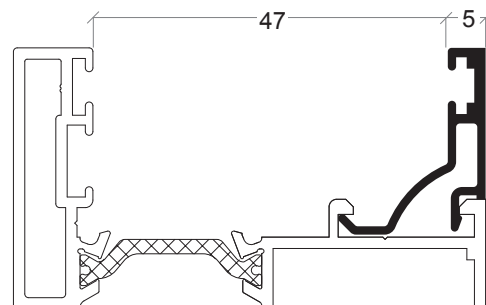

AX-82

58

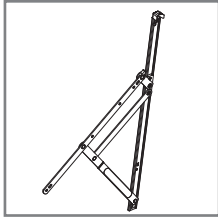

30 00 95 20

Jogo compasso fachada (120 Kg)
Juego compasso fachada (120 Kg)

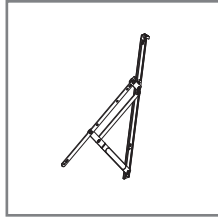

30 00 95 71

Jogo compasso (75kg)
Juego compasso (75kg)

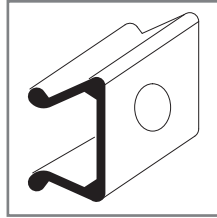

30 03 40 00

Mola para AZ-60
Grapa para AZ-60

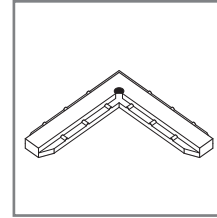

30 21 20 07

Esquadro de alinhamento
Escuadra de alineamiento

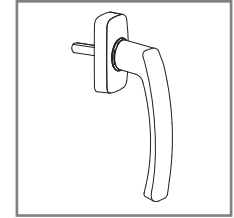

30 60 16 40/41

Puxador de alumínio branco/preto
Manilla de aluminio blanco/negro

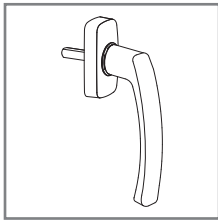

30 60 16 42/43

Puxador de alumínio 2 ac/champ ac
Manilla de aluminio 2 ac/champ ac

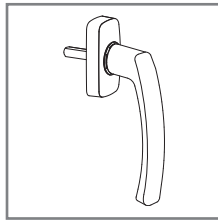

30 60 16 44

Puxador de alumínio inox ac
Manilla de aluminio inox ac

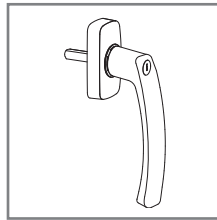

30 60 16 45/46

Puxador de alumínio com chave branco/preto
Manilla de aluminio con llave blanco/negro

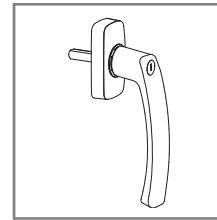

30 60 16 47/48

Puxador de alumínio com chave 2 ac/champ ac
Manilla de aluminio con llave 2 ac/champ ac

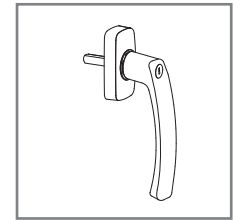

30 60 16 49

Puxador de alumínio com chave inox ac
Manilla de aluminio con llave inox ac

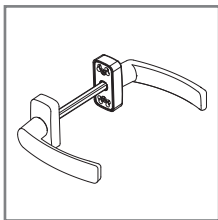

30 60 16 50/51

Puxador duplo de alumínio branco/preto
Manilla doble de aluminio blanco/negro

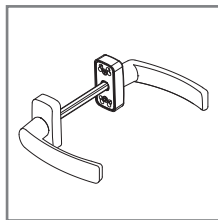

30 60 16 52/53

Puxador duplo de alumínio 2 ac/champ ac
Manilla doble de aluminio 2 ac/champ ac

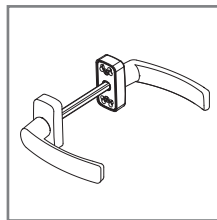

30 60 16 54

Puxador duplo de alumínio inox ac
Manilla doble de aluminio inox ac

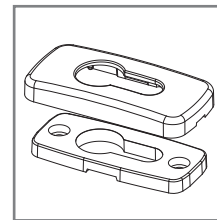

30 60 16 55/56

Escudo de alumínio branco/preto
Espejo de aluminio blanco/negro

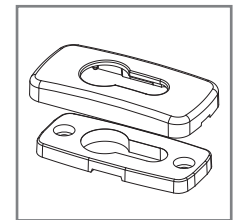

30 60 16 57/58

Escudo de alumínio 2 ac/champ ac
Espejo de aluminio 2 ac/champ ac

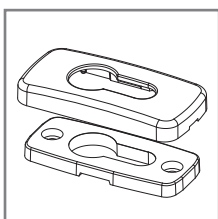

30 60 16 59

Escudo de alumínio inox ac
Espejo de aluminio inox ac

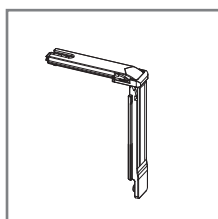

30 90 20 42

Ângulo de reenvio
Angulo de reenvio

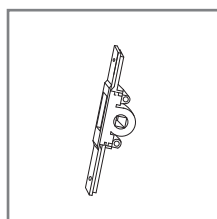

30 90 20 44

Transmissão para abertura exterior
Trasmisión para apertura exterior

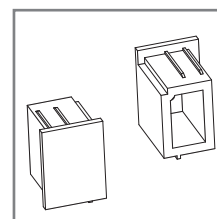

30 91 21 20

Jogo topos condensação Y-20
Juego topes condensación Y-20

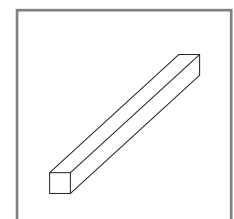

30 91 41 23

Perno 7 x 131 mm
Perno 7 x 131 mm

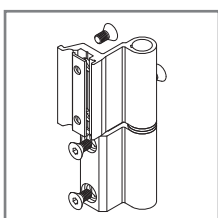

30 92 00 20/21

Dobradiça C.E. branco/preto
Bisagra C.E. blanco/negro

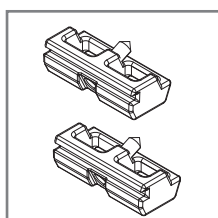

30 92 00 50

Complemento fecho
Complemento cierre

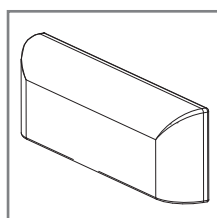

30 92 01 00/01

Goteiras branco/preto
Vierteaguas blanco/negro

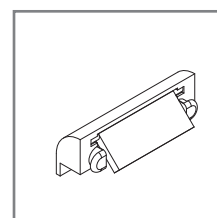

30 92 01 02/03

Goteira c/valvula preto/branco
Goteo c/valvula negro/blanco

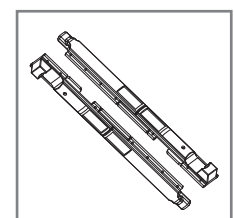

30 92 01 20

Jogo fecho C.E.
Juego cierre C.E.

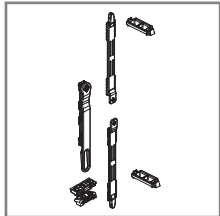

30 92 01 23

Jogo de passadores bidireccional C.E.
Juego de pasadores bidireccional C.E.

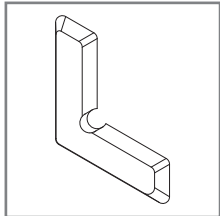

30 92 01 35

Jogo fecho C.E.
Escuadra alineamiento

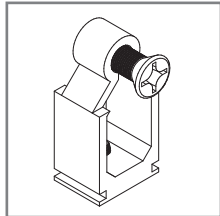

30 92 01 40

União topos janela
Unión topos ventana

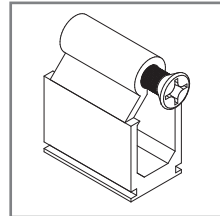

30 92 01 50

União topos porta
Unión topos puerta

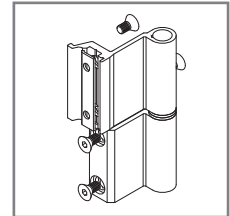

30 92 01 70/80

Dobradiça 3 folhas branco/preto
Bisagra 3 hojas blanco/negro

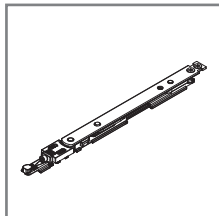

30 92 02 10/11/12

Compasso oscilo 300/400/500
Compás oscilo 300/400/500

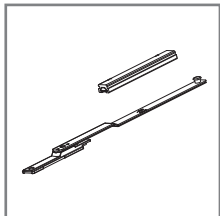

30 92 02 13

Compasso suplementar OB
Compás suplementar OB

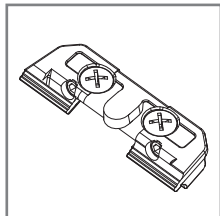

30 92 02 15

Esquadro alinhamento
Cierre para microventilación

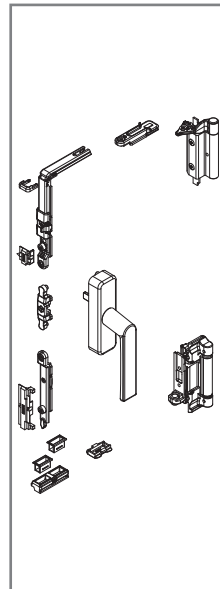

30 92 02 20/21

Kit oscilobatente branco/preto
Kit oscilobatiente blanco/negro

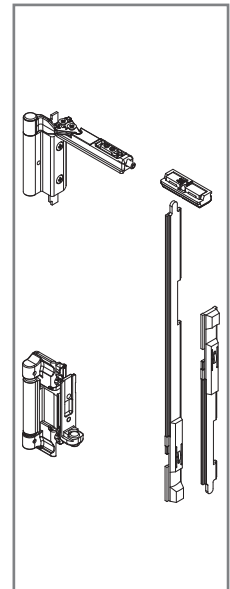

30 92 02 24/25

Kit 2ª folha oscilobatente branco/preto
Kit 2ª hoja oscilobatiente blanco/negro

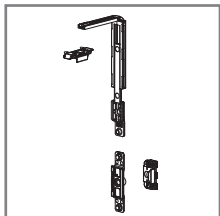

30 92 02 45

Kit fecho vertical 3º ponto
Kit cierre vertical 3º punto

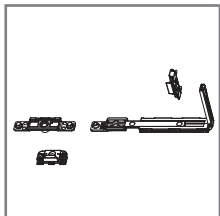

30 92 02 47

Kit fecho horizontal 3º ponto
Kit cierre horizontal 3º punto

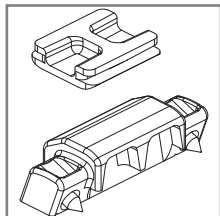

30 92 02 60

Apoio da folha
Apoyo hoja

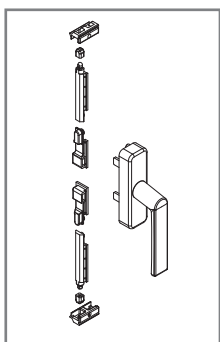

30 92 03 10/11

Kit cremone branco/preto
Kit manilla blanco/negro

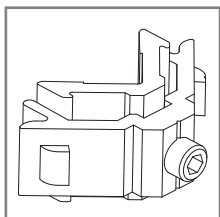

30 92 03 80

Esquadro janela
Escuadra ventana

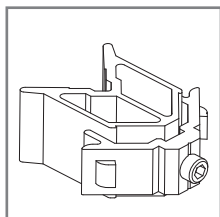

30 92 03 90

Esquadro porta
Escuadra puerta

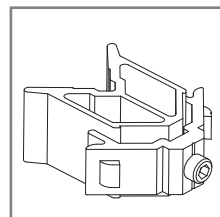

30 92 03 95

Esquadro folha porta
Escuadra hoja puerta

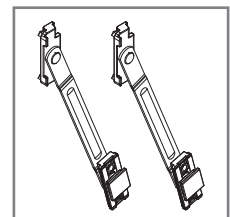

30 92 04 75

Jogo compassos basculante
Juego compás abatible

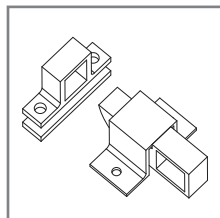

30 92 04 76/77

Fecho clack (branco/preto)
Cierre clack (blanco/negro)

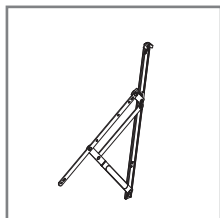

30 92 04 80

Jogo Compassos Projectante-Deslizante(50kg)
Compás projectante Deslizante (50kg)

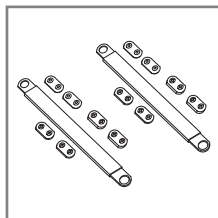

30 92 04 85

Jogo compasso
Juego compás

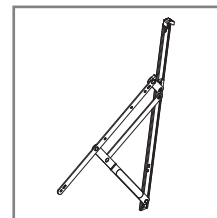

30 92 04 90

Compasso SEN-550 (até 65Kg/folha)
Compás SEN-550 (hasta 65Kg /hoja)

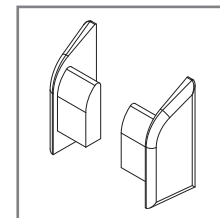

30 92 05 00

Jogo topos
Juego topes

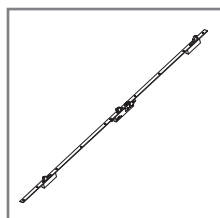

30 92 05 10

Fechadura 3 pontos 35 mm
Cerradura 3 puntos 35 mm

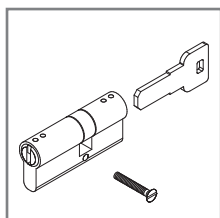

30 92 05 52

Canhão de segurança
Bombillo cierre

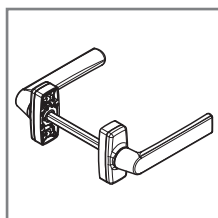

30 92 05 60/61

Puxador duplo branco/preto
Manilla doble blanco/negro

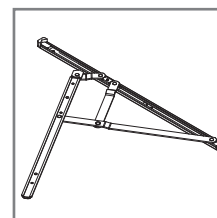

30 92 06 00

Compasso projectante deslizante (35kg)
Compás projectante deslizante (35kg)

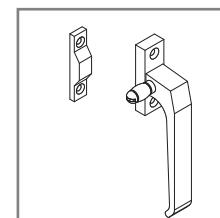

30 92 06 10/11

Cremone de lingueta branco/preto
Manilla de presión blanco/negro

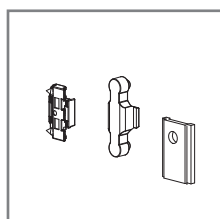

30 92 22 43

Ponto fecho suplementar
Punto cierre suplementario

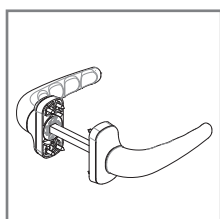

30 92 22 82/83

Cremone duplo branco/preto
Manilla doble blanco/ negro

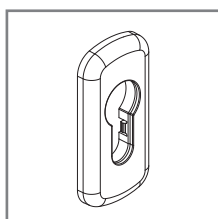

30 92 22 85/86

Escudo para chapa-testas branco/preto
Contracierre bombillo blanco/negro

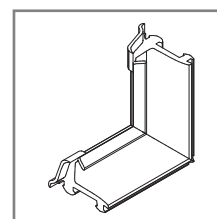

30 93 50 12

Canto vulcanizado com tapa-canal ATI
Angulo vulcanizado con tapa-canal ATI

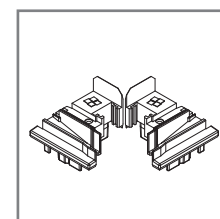

30 93 50 21

Conjunto topos inversores com furo ATI
Conjunto topes inversores con agujero ATI

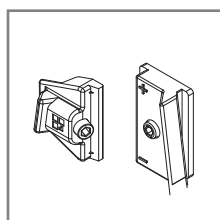

30 95 52 15

Fecho suplem. lado dobradiças
Punto de cierre suplementario

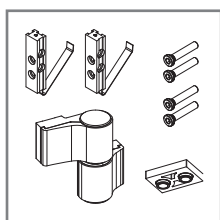

30 96 00 17/21

Dobradiça com ressalto (branco/preto)
Bisagra con resalto (blanco/negro)

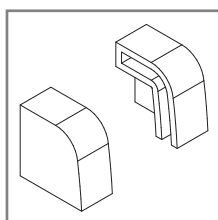

30 96 00 12

Jogo topos condensação
Juego topes condensación

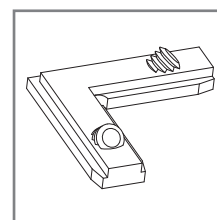

30 96 00 15

Esquadro de alinhamento
Escuadra de alineamiento

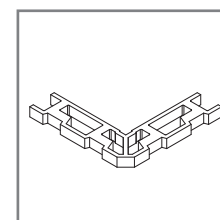

30 96 00 25

Esquadro exterior aro fixo F. Oculta
Escuadro exterior Marco H. Oculta

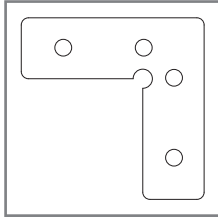

30 96 00 28

Esquadro alinhamento especial
ATI-07/10/53/65/66
Escuadra alineamiento especial
ATI-07/10/53/65/66

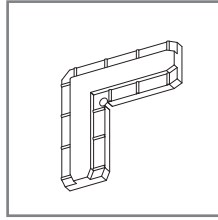

30 96 00 43

Esquadro de alinhamento
Escuadro de alineación

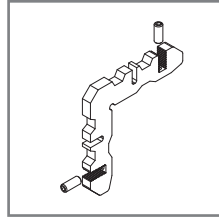

30 96 00 45

Esquadro alinhamento exterior com parafusos
Escuadra alineamiento exterior con tornillos

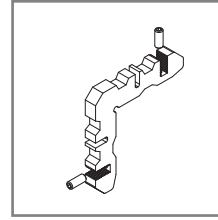

30 96 00 48

Esquadro de alinhamento 7x14 c/ parafusos
Escuadra alineamiento 7x14 c/ tornillos

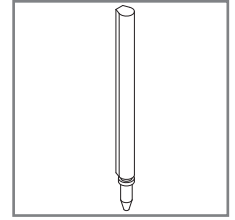

30 96 00 55

Perno alternativo para fixação de esquadro
Perno alternativo para fijación de escuadra

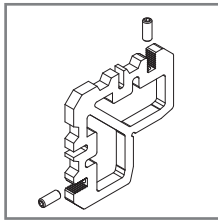

30 96 00 60

Esquadro de alinhamento 5.2x31.6 com parafusos
Escuadra alineamiento 5.2x31.6 con tornillos

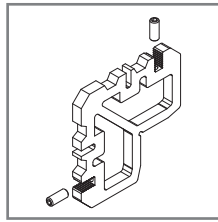

30 96 00 62

Esquadro alinhamento exterior
Escuadra alineamiento exterior

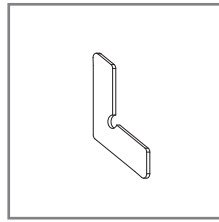

30 96 00 63

Esquadro alinhamento
Escuadra alineamiento

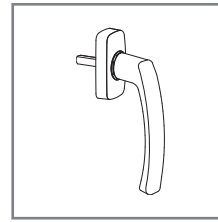

31 70 16 40

Puxador de alumínio em bruto
Manilla de aluminio en crudo

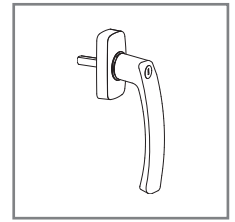

31 60 16 42

Puxador de alumínio com chave em bruto
Manilla de aluminio con llave en crudo

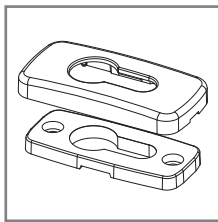

31 70 16 43

Escudo de alumínio em bruto
Espejo de aluminio en crudo

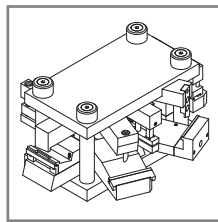





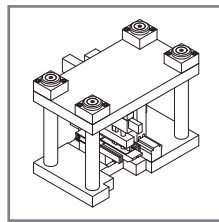

















33 96 79 99

Cunho C.E.
Troquel C.E.





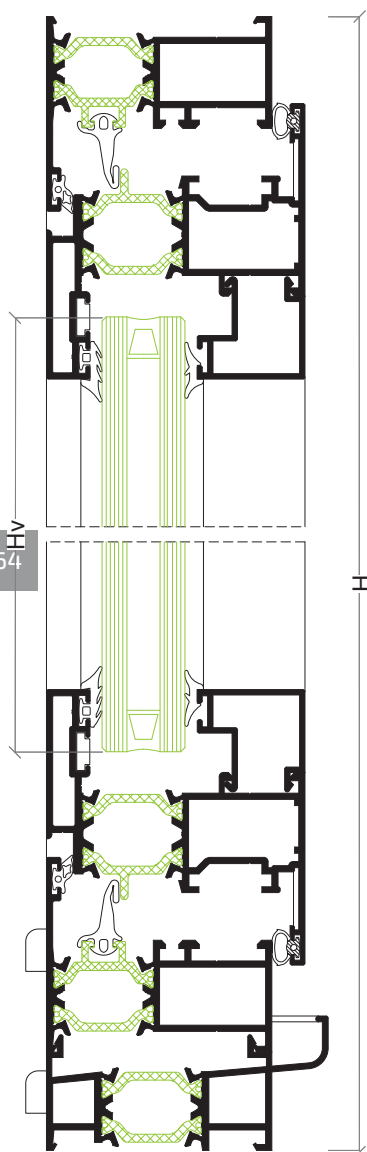
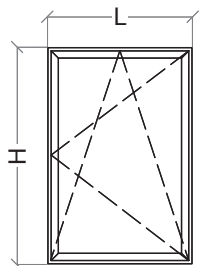

33 96 87 99

Cunho esquadros interior/exterior
Troquel escuadras interior/exterior

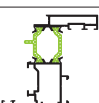
REFERÊNCIA • REFERENCIA	DESENHO • DISEÑO	DESCRIÇÃO • DESCRIPCIÓN
30 00 95 15		Junta vedação inferior curta • Junta estanqueidad inferior
30 60 00 17		Junta exterior vidro plana 2 mm preto • Junta exterior vidrio plana 2 mm negro
30 92 04 70		Espuma isolante • Espuma aislante
30 93 00 60		Vedante exterior do vidro (opcional) • Junta exterior del vidrio (opcional)
30 93 00 61		Junta de vedação exterior • Junta de estanqueidad exterior
30 93 00 62		Junta exterior plana • Junta exterior plana
30 93 00 65		Junta interior para vidro (5 mm) • Junta interior para vidrio (5 mm)
30 93 00 66		Junta interior para vidro (4 mm) • Junta interior para vidrio (4 mm)
30 93 00 67		Junta interior para vidro (2 mm) • Junta interior para vidrio (2 mm)
30 93 00 68		Junta interior para vidro (6/7 mm) • Junta interior para vidrio (6/7 mm)
30 93 00 69		Junta interior para vidro (8/9 mm) • Junta interior para vidrio (8/9 mm)
30 93 00 70		Vedante interior do vidro (opcional) • Junta interior vidrio (opcional)
30 93 00 80		Junta de vedação inferior ATi-42 • Junta de estanqueidad inferior ATi-42
30 93 00 82		Junta de vedação inferior • Junta de estanqueidad inferior
30 93 00 84		Junta para pingadeiras AZ-60 e AZ-70 • Junta para viertaguas AZ-60 e AZ-70
30 93 00 90		Junta exterior • Junta exterior
30 93 01 20		Junta interior • Junta interior
30 96 00 18		Junta interior (abertura projectante/deslizante) • Junta interior (apertura proyectante/deslizante)
30 93 50 10		Junta central ATi • Junta central ATi
30 93 50 11		Junta central / Tapa canal ATi • Junta central / Tapa canal ATi
30 95 00 10		Pelúcia 7x9 mm Stop-fin • Burlete 7x9 mm Stop-fin
30 95 00 40		Pelúcia 7x5.5 mm Stop-fin • Burlete 7x5.5 mm Stop-fin
30 95 00 50		Pelúcia 7x6 mm Stop-fin • Burlete 7x6 mm Stop-fin

Janela 1 folha abrir e oscilo-batente • Ventana 1 hoja practicable y oscilobatiente

PERFIS • PERFIS

DESENHO • DISEÑO	REF.	DESCRIÇÃO • DESCRIPCIÓN	CORTE • CORTE	QUANTIDADE CANTIDAD	MEDIDAS • MEDIDA
	ATI-03	Aro fixo • Marco		2	L
				2	H-24 mm
	ATI-64	Aro móvel • Hoja		2	L-42 mm
				2	H-66 mm
	ATI-57	Soleira condensação • Condensación		1	L
	AX-19	Vareta • Pletina falleba		1+1	Apro. L+H
	---	Bite • Junquillo		2	L-135 mm
				2	H-199 mm

ACESSÓRIOS E JUNTAS • ACCESORIOS Y JUNTAS







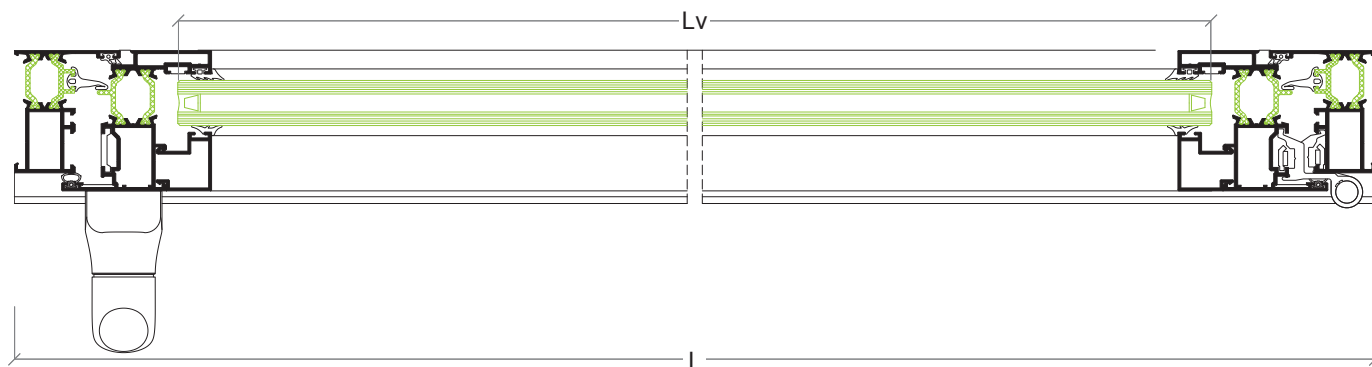

REF.	DESCRIÇÃO • DESCRIPTION	QUANTIDADE • CANTIDAD	
		ABRIR PRATICABLE	OSCILO-BATENTE OSCILOBATIENTE
30 92 00 20	Dobradiças C.E. • Bisagras C.E.	2	---
30 92 01 00	Goteiras • Vierendeaguas	4	4
30 92 01 35	Esquadro alinhamento aro móvel • Escuadra alineamiento hoja	4	4
30 92 02 (xx)	Compasso O.B. • Compás O.B.	---	1
30 92 02 20	Kit oscilo-batente • Kit oscilobatiente	---	1
30 92 02 60	Apoio da folha • Apoyo de la hoja	1	---
30 92 03 10	Kit cremone • Kit manilla	1	---
30 92 03 80	Esquadro janela • Escuadra ventana	8	8
30 96 00 12	Jogo topos condensação • Juego topos condensación	1	1
30 96 00 15	Esquadro alinhamento móvel • Escuadra alineamiento hoja	4	4
30 92 04 70	Espuma isolante • Espuma aislante	L	L
30 93 00 90	Junta exterior • Junta exterior	2L+2H	
30 93 50 10	Junta central • Junta central	2L+2H	
30 93 01 20	Junta interior • Junta interior	2L+2H	
---	Junta exterior vidro • Junta exterior vidrio	2L+2H	
---	Junta interior vidro • Junta interior vidrio	2L+2H	

VIDRO • VIDRIO

Hv = H-174 mm	Lv = L-149 mm
---------------	---------------



Janela 2 folhas abrir e oscilo-batente • Ventana 2 hojas practicable y oscilobatiente
PERFIS • PERFIS

DESENHO • DISEÑO	REF.	DESCRIÇÃO • DESCRIPCIÓN	CORTE CORTE	QUANTIDADE CANTIDAD	MEDIDAS • MEDIDA
	ATI-03	Aro fixo • Marco		2	L
	ATI-64	Aro móvel • Hoja		4	H-24 mm
	ATI-64	Aro móvel • Hoja		4	L/2-24 mm
	ATI-57	Soleira condensação • Condensación		1	L
	AX-19	Vareta • Pletina falleba		1+1	Apro. L+H
	---	Bite • Junquillo		4	L/2-117 mm
	---	Bite • Junquillo		4	H-199 mm
	ATI-04	Inversor • Inversor		1	H-134 mm

ACESSÓRIOS E JUNTAS • ACCESORIOS Y JUNTAS

REF.	DESCRIÇÃO • DESCRIPTION	QUANTIDADE • CANTIDAD	
		ABRIR PRATICABLE	OSCILO-BATENTE OSCILOBATIENTE
30 92 00 20	Dobradiças C.E. • Bisaqras C.E.	4	---
30 92 01 00	Goteiras • Vierendeaguas	4	4
30 92 01 20	Jogo fecho C.E. • Juego Cierre C.E.	1	---
30 92 01 35	Esquadro alinhamento aro móvel • Escuadra alineamiento hoja	8	8
30 92 02 (xx)	Compasso O.B. • Compás O.B.	---	1
30 92 02 20	Kit oscilo-batente • Kit oscilobatiente	---	1
30 92 02 24	Kit 2ª folha oscilo-batente • Kit 2ª hoja oscilobatiente	---	1
30 92 02 60	Apoio da folha • Apoyo de la hoja	1	---
30 92 03 10	Kit cremone • Kit manilla	1	---
30 92 03 80	Esquadro janela • Escuadra ventana	12	12
30 93 50 21	Jogo topos inversor • Juego topos inversor	1	1
30 96 00 12	Jogo topos condensação • Juego topos condensación	1	1
30 96 00 15	Esquadro alinhamento móvel • Escuadra alineamiento hoja	8	8
30 92 04 70	Espuma isolante • Espuma aislante	L	L
30 93 00 90	Junta exterior • Junta exterior	2L+4H	
30 93 05 10	Junta central • Junta central	2L+3H	
30 93 01 20	Junta interior • Junta interior	2L+4H	
---	Junta exterior vidro • Junta exterior vidrio	2L+4H	
---	Junta interior vidro • Junta interior vidrio	2L+4H	

VIDRO • VIDRIO

Hv = H-220 mm	Lv = L/2-131 mm
---------------	-----------------

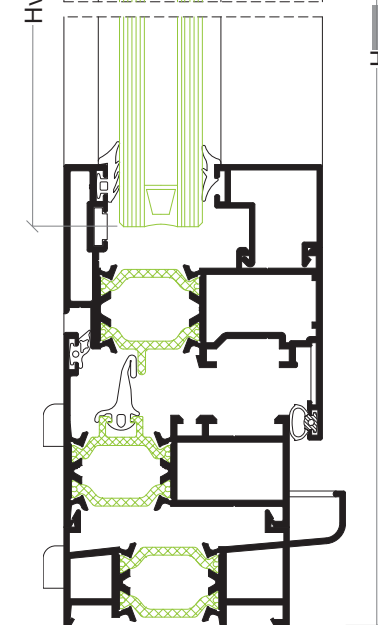
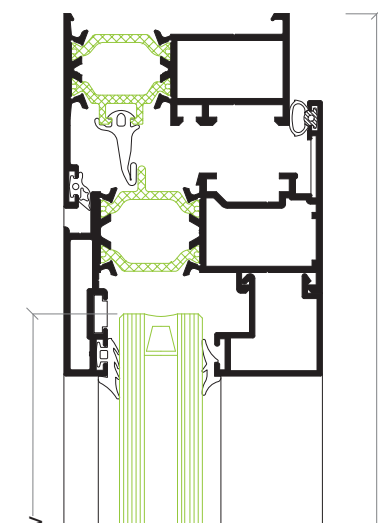
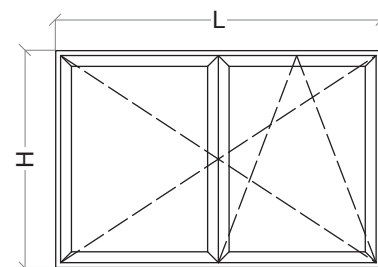

65

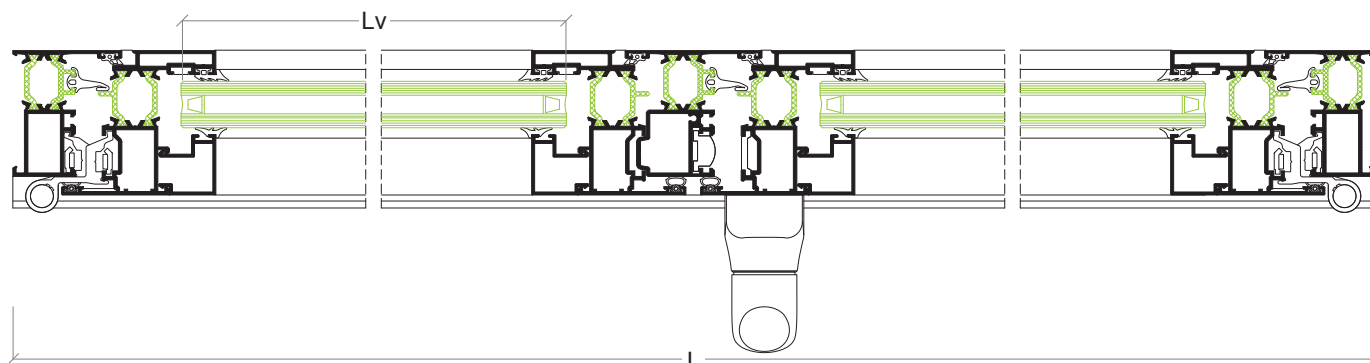

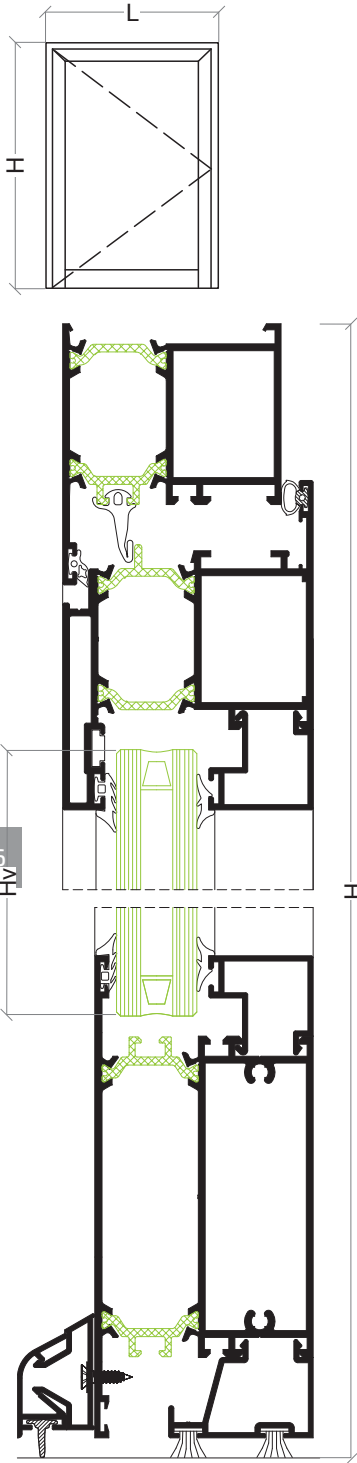
Porta 1 folha • Puerta 1 hoja

PERFIS • PERFIS

DESENHO • DESEÑO	REF.	DESCRIÇÃO • DESCRIPCIÓN	CORTE • CORTE	QUANTIDADE CANTIDAD	MEDIDAS • MEDIDA
	ATI-08	Aro fixo • Marco		1	L
				2	H
	ATI-65	Folha • Hoja		1	L-78 mm
				2	H-44 mm
	ATI-12	Travessa • Travessaño		1	L-193 mm
	AX-15	Bite remate • Junquillo acople		1	L-202 mm
	---	Bite • Junquillo		2	L-202 mm
				2	H-246 mm
	AZ-60	Pingadeira • Vierteaguas		1	L-145 mm
	AZ-61	Clip pingadeira • Suplemento vierteaguas		1	L-242 mm

ACESSÓRIOS E JUNTAS • ACCESORIOS Y JUNTAS

REF.	DESCRIÇÃO • DESCRIPTION	QUANTIDADE CANTIDAD
30 92 00 20	Dobradiças C.E. • Bisagras C.E.	3
30 92 03 90	Esquadro porta • Escuadra puerta	4
30 92 05 10	Fechadura 3 pontos • Cierre 3 puntos	1
30 92 05 52	Canhão fechadura • Bombillo cierre	1
30 92 05 60	Puxador duplo • Manilla doble	1
30 96 00 15	Esquadro alinhamento móvel • Escuadra alineamiento hoja	2
30 92 05 00	Jogo topos • Juego topes	1
30 96 00 28	Esquadro alinhamento • Escuadra alineamiento	2
30 93 00 84	Junta para pingadeiras AZ-60 e AZ-70 • Junta para vierteaguas AZ-60 e AZ-70	L
30 93 00 90	Junta exterior • Junta exterior	1L+2H
30 93 05 10	Junta central • Junta central	1L+2H
30 93 01 20	Junta interior • Junta interior	1L+2H
30 95 00 10	Pelúcia 7x9 mm • Burlete 7x9 mm	2L
---	Junta exterior vidro • Junta exterior vidrio	2L+2H
---	Junta interior vidro • Junta interior vidrio	2L+2H

VIDRO • VIDRIO

Hv = H-220 mm	Lv = L-216 mm
---------------	---------------

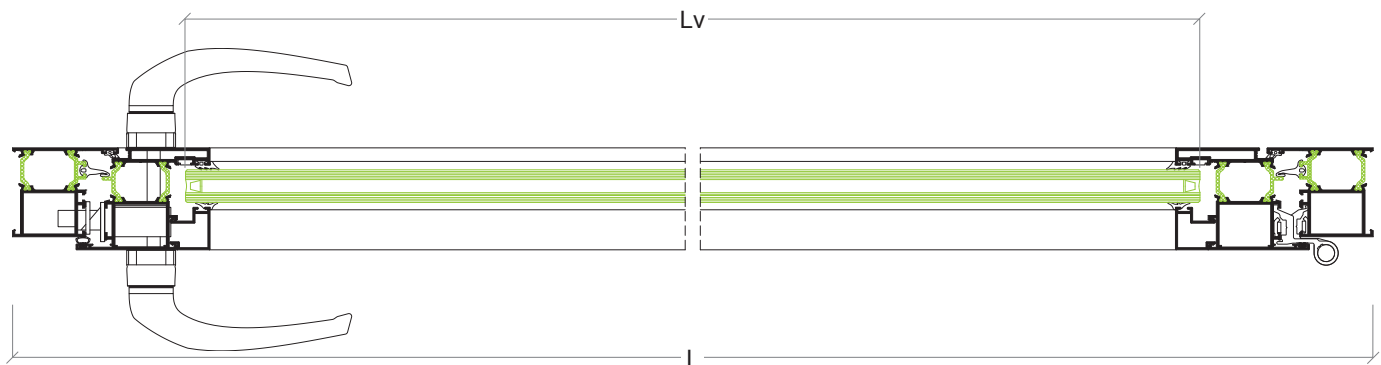

Porta 2 folhas • Puerta 2 hojas
PERFIS • PERFIS

DESENHO • DISEÑO	REF.	DESCRIÇÃO • DESCRIPCIÓN	CORTE CORTE	QUANTIDADE CANTIDAD	MEDIDAS • MEDIDA
	ATI-08	Aro • Marco		1	L
				4	H
	ATI-65	Folha • Hoja		2	L/2-42 mm
				4	H-44 mm
	ATI-04	Inversor • Inversor		1	H-78 mm
	ATI-12	Travessa • Zócalo 120x55mm		2	L/2-157 mm
	AX-15	Bite remate • Junquillo acople		2	L/2-166 mm
	---	Bite • Junquillo		4	L/2-166 mm
				4	H-246 mm
	AZ-60	Pingadeira • Vierteaguas		1	Aprox. L/2
				1	Aprox. L/2
	AZ-61	Clip pingadeira • Suplemento vierteaguas		2	L/2-206 mm

ACESSÓRIOS E JUNTAS • ACCESORIOS Y JUNTAS







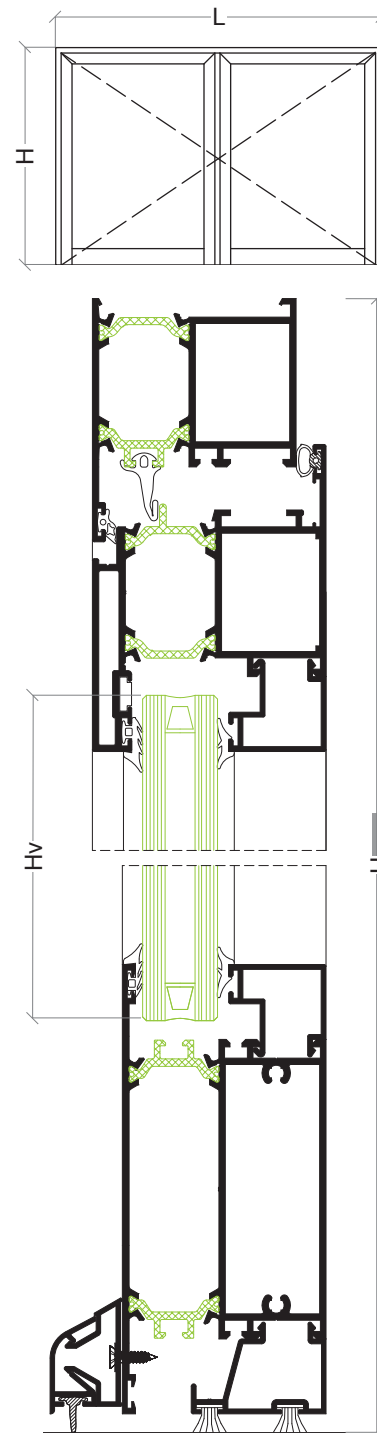
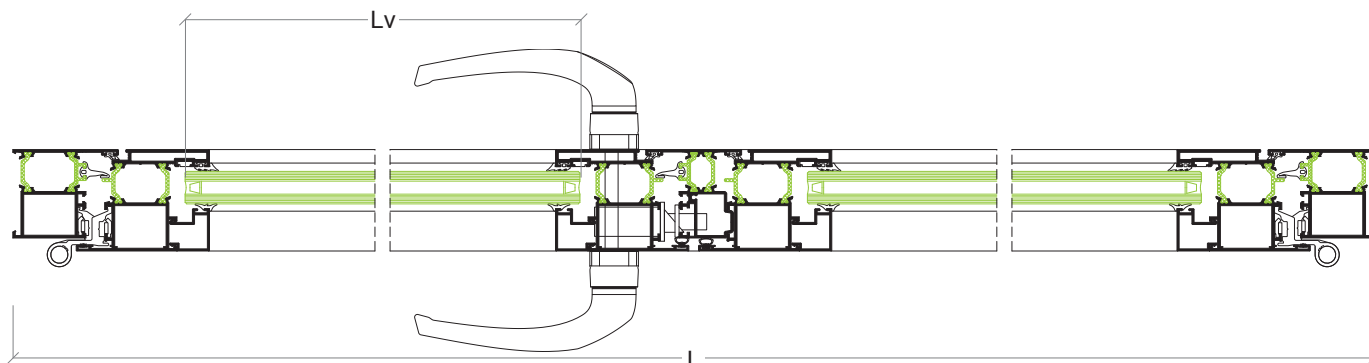

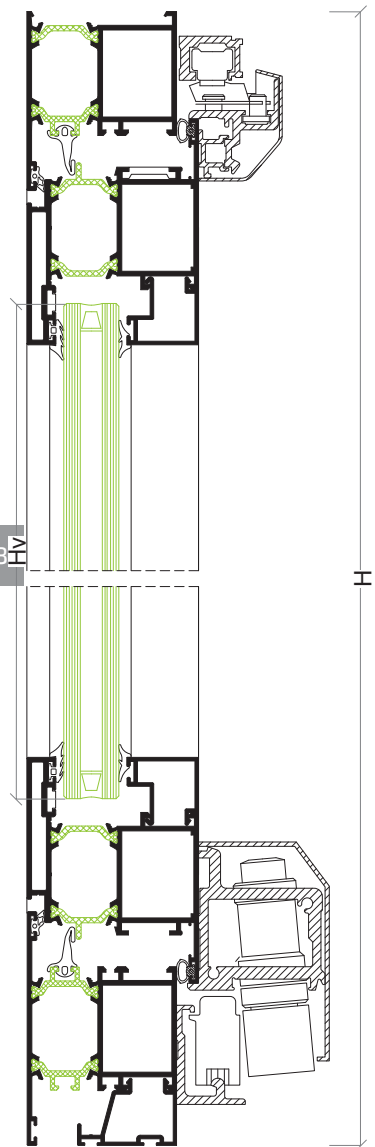
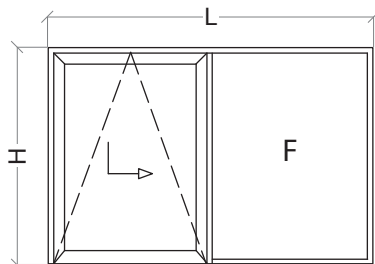

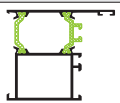

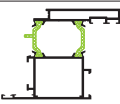
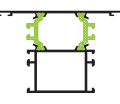



REF.	DESCRIÇÃO • DESCRIPTION	QUANTIDADE CANTIDAD
30 92 00 20	Dobradiças C.E. • Bisagras C.E.	6
30 92 01 12	Jogo topos inversor • Juego topos inversor	1
30 92 01 20	Jogo fecho C.E. • Juego Cierre C.E.	1
30 92 03 90	Esquadro porta • Escuadra puerta	6
30 92 05 10	Fechadura 3 pontos • Cierre 3 puntos	1
30 92 05 52	Canhão fechadura • Bombillo cierre	1
30 92 05 60	Puxador duplo • Manilla doble	1
30 96 00 15	Esquadro alinhamento móvel • Escuadra alineamiento hoja	4
30 92 05 00	Jogo topos • Juego topos	1
30 96 00 28	Esquadro alinhamento • Escuadra alineamiento	2
30 93 00 84	Junta para pingadeiras AZ-60 e AZ-70 • Junta para vierteaguas AZ-60 e AZ-70	L
30 93 00 90	Junta exterior • Junta exterior	1L+4H
30 93 05 10	Junta central • Junta central	1L+3H
30 93 01 20	Junta interior • Junta interior	L+4H
30 95 00 10	Pelúcia 7x9 mm • Burlete 7x9 mm	2L
---	Junta exterior vidro • Junta exterior vidrio	2L+2H
---	Junta interior vidro • Junta interior vidrio	2L+2H

VIDRO • VIDRIO

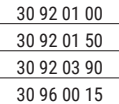
Hv = H-220 mm	Lv = L-180 mm
---------------	---------------

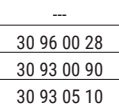

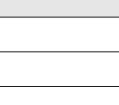
Porta oscilo-paralela com fixo lateral • Puerta oscilo-paralela con fijo lateral

PERFIS • PERFIS

DESENHO • DISEÑO	REF.	DESCRIÇÃO • DESCRIPCIÓN	CORTE • CORTE	QUANTIDADE CANTIDAD	MEDIDAS • MEDIDA
	ATI-08	Aro fixo • Marco		1	L
	ATI-65	Aro móvel • Hoja		2	L1-56 mm
	ATI-65	Aro móvel • Hoja		2	H-98 mm
	ATI-06	Travessa • Travessaño		1	L-81 mm
	ATI-06	Travessa • Travessaño		1	H-101 mm
	AX-15	Bite remate • Junquillo acople		1	L-90 mm
	AX-19	Vareta • Pletina falleba		1+1	Apro. L+H
	---	Bite (folha) • Junquillo (hoja)		2	L1-180 mm
	---	Bite (folha) • Junquillo (hoja)		2	H-262 mm
	---	Bite (fixo) • Junquillo (fijo)		2	L2-67.5 mm
	---	Bite (fixo) • Junquillo (fijo)		2	H-150 mm

ACESSÓRIOS E JUNTAS • ACCESORIOS Y JUNTAS

REF.	DESCRIÇÃO • DESCRIPTION	QUANTIDADE CANTIDAD
30 92 01 00	Goteiras • Vierendeaguas	4
30 92 01 50	União topos porta • Unión topos puerta	2
30 92 03 90	Esquadro porta • Escuadra puerta	6
30 96 00 15	Esquadro alinhamento móvel • Escuadra alineamiento hoja	4
---	Kit oscilo-paralela • Kit oscilo-paralelo	1
30 96 00 28	Esquadro de alinhamento • Escuadra alineamiento	4
30 93 00 90	Junta exterior • Junta exterior	2L1+2H
30 93 05 10	Junta central • Junta central	2L1+2H
30 93 01 20	Junta interior • Junta interior	2L1+2H
---	Junta exterior vidro • Junta exterior vidrio	2L+2H
---	Junta interior vidro • Junta interior vidrio	2L+2H

	MÍNIMO • MÍNIMO	MÁXIMO • MÁXIMO
Largura da folha • Largo de la hoja	700 mm	1650 mm
Altura da folha • Alto de la hoja	850 mm	2400 mm







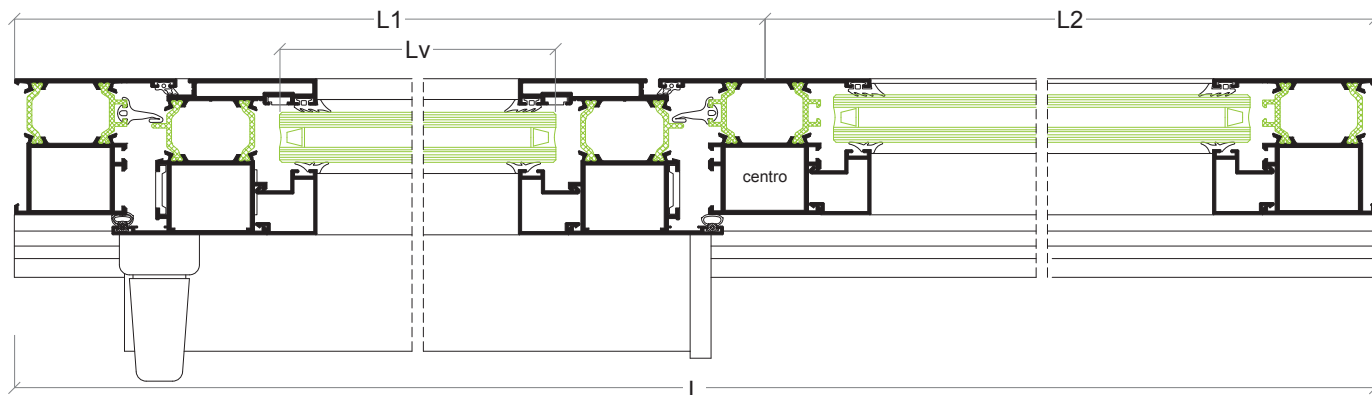











Peso máximo por folha 150 Kg • Peso máximo por hoja 150 kg

VIDRO • VIDRIO

Hv hoja = H-236 mm	Lv hoja = L1-193 mm
Hv fijo = H-124 mm	Lv fijo = L2-81 mm



Porta 3 folhas harmónio • Puerta 3 hojas plegable
PERFIS • PERFIS

DESENHO • DISEÑO	REF.	DESCRIÇÃO • DESCRIPCIÓN	CORTE CORTE	QUANTIDADE CANTIDAD	MEDIDAS • MEDIDA
	ATI-08	Aro fíco • Marco		2	H
	ATI-06	Travessa • Travesanõ		1	L-81 mm
	AXi-12	Travessa • Zócalo 120x55mm		1	L-81
	ATI-65	Aro móvel • Hoja		6	(consultar)
				6	(consultar)
	ATI-04	Inversor • Inversor		2	(consultar)
	AX-15	Bite remate • Junquillo acople		2	L-90 mm
	AX-19	Vareta • Pletina falleba		2	2H
	---	Bite • Junquillo		6	(consultar)
				6	(consultar)

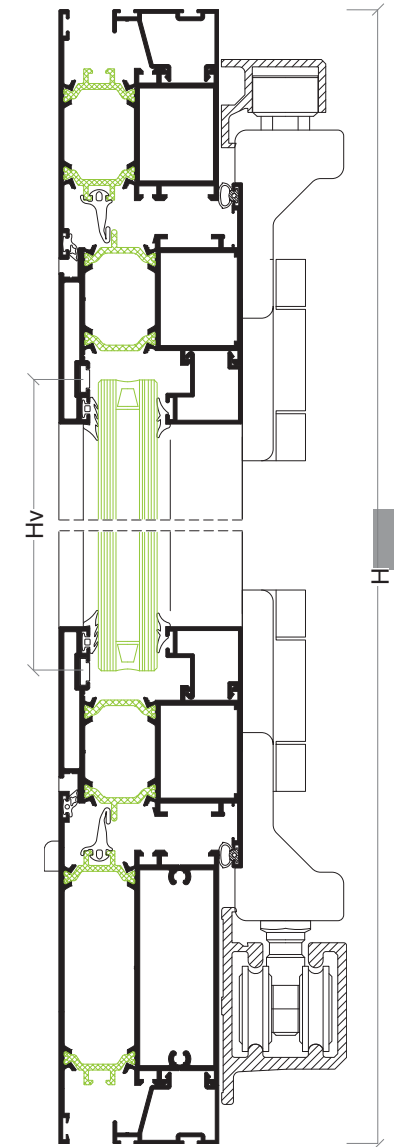
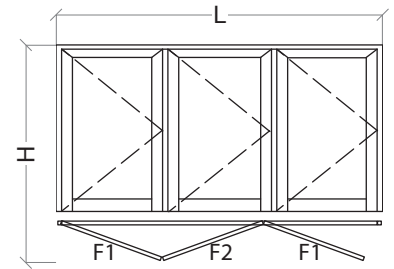
ACESSÓRIOS E JUNTAS • ACCESORIOS Y JUNTAS

REF.	DESCRIÇÃO • DESCRIPTION	QUANTIDADE CANTIDAD
30 92 01 50	União topos porta • Unión tope puerta	2
30 92 01 00	Goteiras • Vientaguas	6
30 93 50 21	Jogo topos inversor • Juego topes inversor	2
30 92 03 90	Esquadro porta • Escuadra puerta	12
---	Kit harmónio (3+0) • Kit plegable (3+0)	1
30 92 01 20	Jogo de fecho C.E. • Juego cierre C.E.	1
30 96 00 28	Esquadro de alinhamento • Escuadra alineamiento	12
30 96 00 15	Esquadro aro móvel exterior • Escuadra hoja exterior	12
30 93 00 90	Junta exterior • Junta exterior	2L+6H
30 93 05 10	Junta central • Junta central	2L+4H
30 93 01 20	Junta interior • Junta interior	2L+6H
---	Junta exterior vidro • Junta exterior vidrio	2L+6H
---	Junta interior vidro • Junta interior vidrio	2L+6H

	MÍNIMO • MÍNIMO	MÁXIMO • MÁXIMO
Largura da folha • Largo de la hoja	700 mm	900 mm
Altura da folha • Alto de la hoja	850 mm	2400 mm

Peso máximo por folha 80 Kg • Peso máximo por hoja 80 kg

VIDRO • VIDRIO

Hv = consultar	Lv F1 = consultar
	Lv F2 = consultar

