

www.anicolor.pt

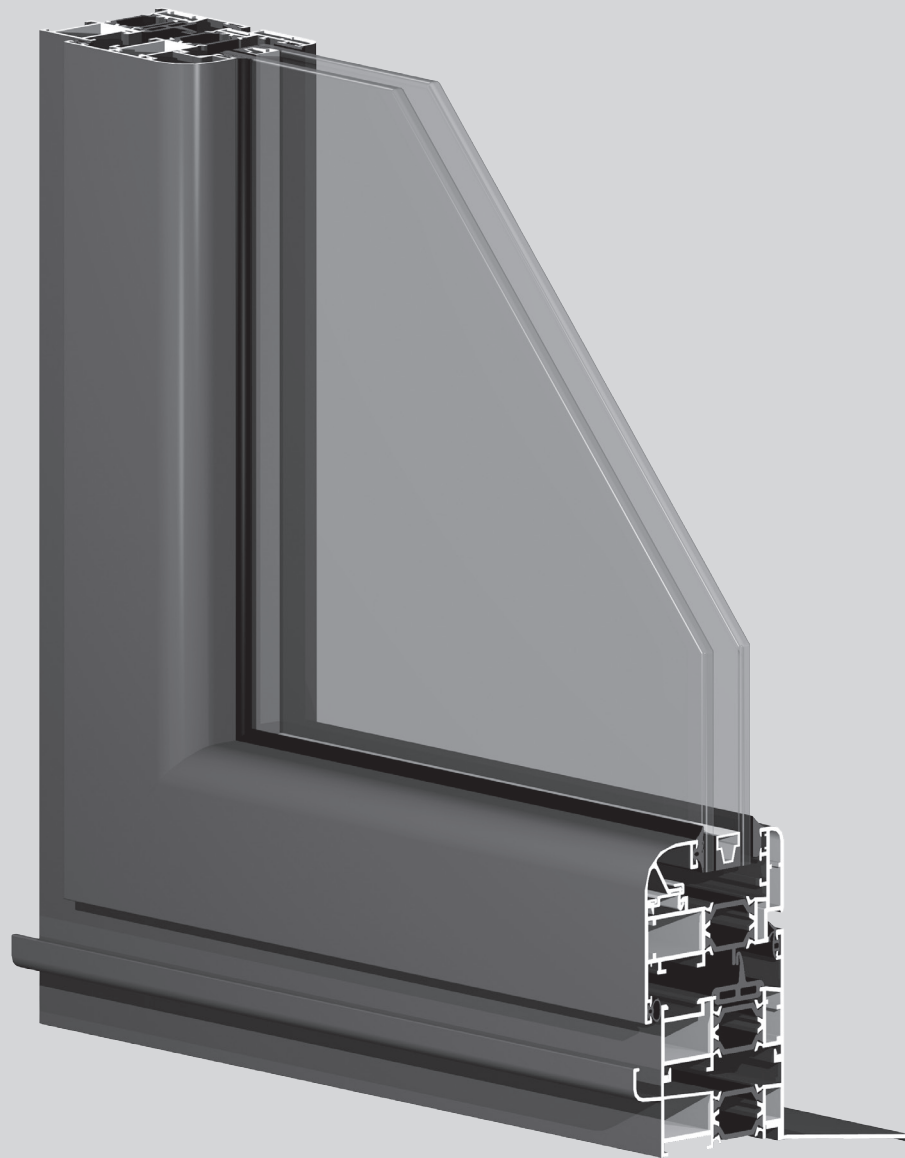

1

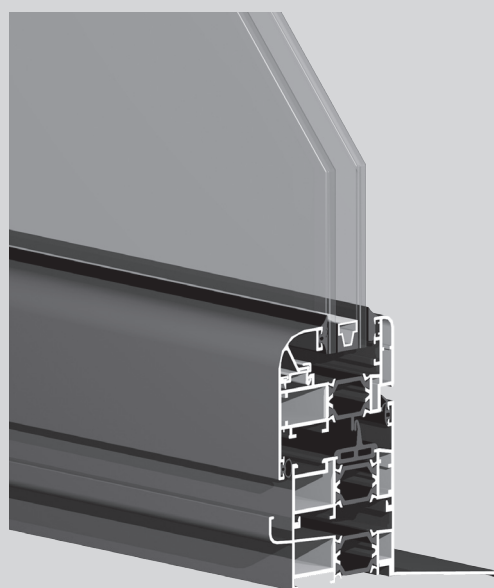

Sistema

ARi

Sistema ARi

Sistema de batente com RPT - 60 mm

Características do sistema

Sistema de batente com rotura térmica e de elevadas prestações térmicas e acústicas.

O sistema ARi possibilita a execução de 5 versões de caixilharia:

1. linha recta;
2. linha curva;
3. linha tradição;
4. linha oval;
5. Folha Oculta.

O sistema ARi permite a aplicação de vidros duplos ou triplos de alto rendimento de modo a responder às exigências de isolamento térmico e acústico.

A versão ARi Folha Oculta permite a ocultação do aro móvel.

Perfis de alumínio

Os perfis de alumínio são extrudidos na liga de alumínio 6060 para arquitectura de acordo com norma NP EN 12020-02.

Rotura térmica obtida por inserção de varetas isolantes de poliamida tipo ómega de 24 mm, reforçadas com 25% de fibra de vidro.

Espessura média dos perfis de alumínio de 1.5 mm para janelas e de 1.7 mm para portas.

Aros fixos

Secção dos aros fixos de 60 mm ou 84.5 mm com tripla câmara;

Aros fixos com esquadros duplos para montagem a meia esquadria;

Aros fixos tradicionais para mercado interno;

Aros fixos com clip exterior e aba de remate direta de 25 mm ou 45 mm;

Aros fixos com clip exterior e interior para aplicação de remate de 30 mm.

Aros móveis

Secção dos aros móveis de 68 mm com tripla câmara;

Enchimento para vidro duplo ou triplo de 10 mm a 45 mm para o sistema ARi;

Enchimento para vidro duplo até 23 mm para o sistema ARi Folha Oculta;

Aros móveis de linha recta, curva, tradição ou oval (sem bite);

Aros móveis com esquadros duplos para montagem a meia esquadria;

Perfil inversor de linha recta.

Dimensionamento e manobralidade

Dimensões mínimas - máximas de folha: 400 mm - 1500 mm (L); 400 mm - 2700 mm (H);

Possibilidades de abertura: fixo, batente interior 1 ou 2 folhas com oscilo-batente, exterior, basculante, projectante, pivotante, harmónio e oscilo-paralela;

Estanquidade assegurada através de juntas triplas em EPDM.

Performances

Sistema certificado por laboratório notificado para Ensaio Tipo Inicial (ITT) de acordo com a norma de produto EN 14351-1 para efeitos de Marcação CE.

Categorias alcançadas na avaliação do sistema ARi tipologia janela:

1. Permeabilidade ao ar: Classe 4 (norma de ensaio EN 1026)
2. Estanquidade à água: Classe E750 (norma de ensaio EN 1027)
3. Resistência ao vento: Classe C5 (norma de ensaio EN 12211)

Categorias alcançadas na avaliação do sistema ARi tipologia porta:

1. Permeabilidade ao ar: Classe 4 (norma de ensaio EN 1026)
2. Estanquidade à água: Classe 9A (norma de ensaio EN 1027)
3. Resistência ao vento: Classe C3 (norma de ensaio EN 12211)
4. Resistência à torção estática: Apto 350N (norma de ensaio EN 14609)

Categorias alcançadas na avaliação do sistema ARi-Folha Oculta tipologia janela:

1. Permeabilidade ao ar: Classe 3 (norma de ensaio EN 1026)
2. Estanquidade à água: Classe 7A (norma de ensaio EN 1027)
3. Resistência ao vento: Classe C5 (norma de ensaio EN 12211)

Coefficiente de transmissão térmica de vão de 2 folhas, sistema Ari, com 1.20 m x 1.50 m com vidro $U_g = 0.7 \text{ W/m}^2\text{K}$, com intercalar efeito "Warm Edge":

• $U_w = 1.54 \text{ W/m}^2\text{K}$

Coefficiente de transmissão térmica de vão de 2 folhas, sistema ARi Folha Oculta com 1.80 m x 2.20 m com vidro $U_g = 1.1 \text{ W/m}^2\text{K}$, com intercalar efeito "Warm Edge":

• $U_w = 1.70 \text{ W/m}^2\text{K}$

Coefficiente de atenuação acústica de vão de 2 folhas com vidro 4/16 (gás Argon)/6:

• $R_w (C; C_{tr}) = 34 \text{ dB} (-1; -4)$

Zonas de aplicação segundo RCCTE (em função do valor U_g): I1, I2, I3, V1, V2, V3.

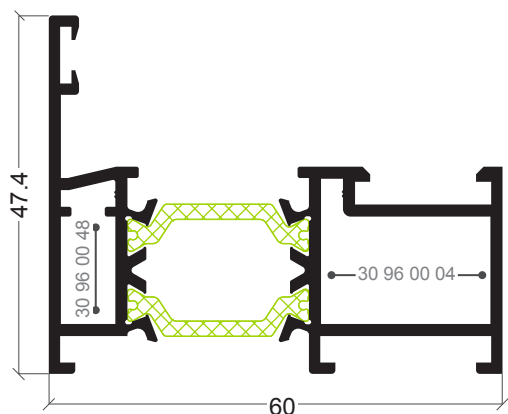

ARi-03
Aro fixo

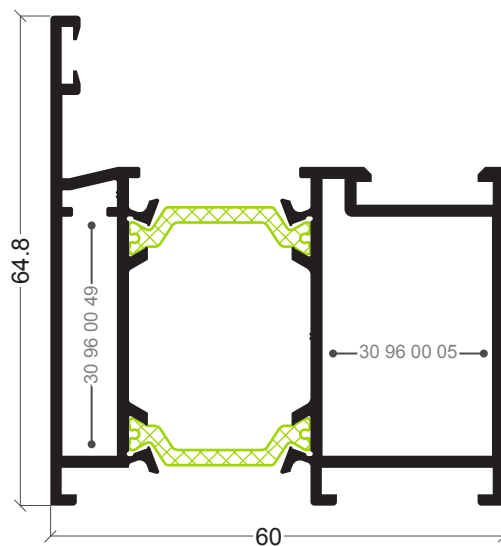

ARi-08
Aro fixo

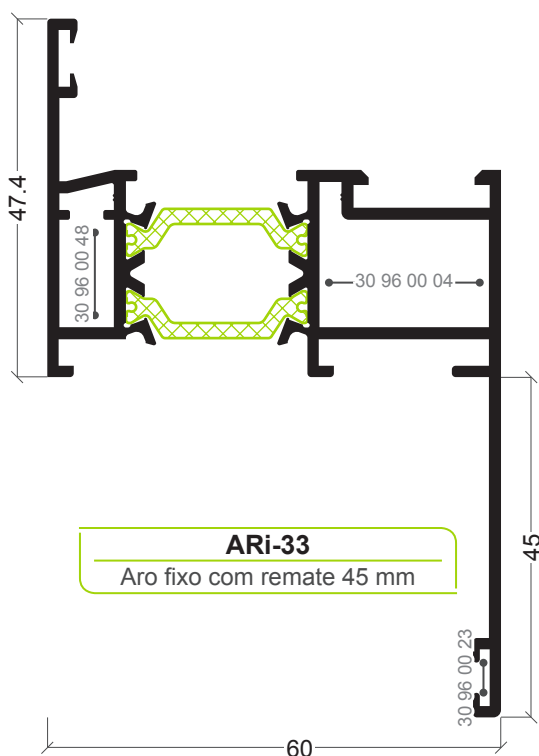

ARi-33
Aro fixo com remate 45 mm

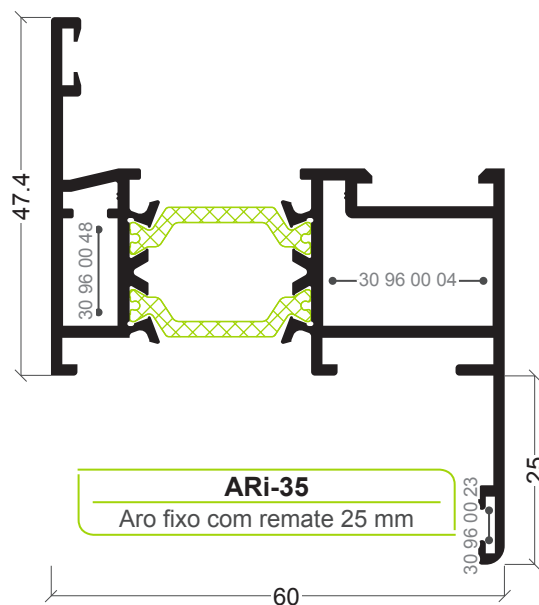

ARi-35
Aro fixo com remate 25 mm

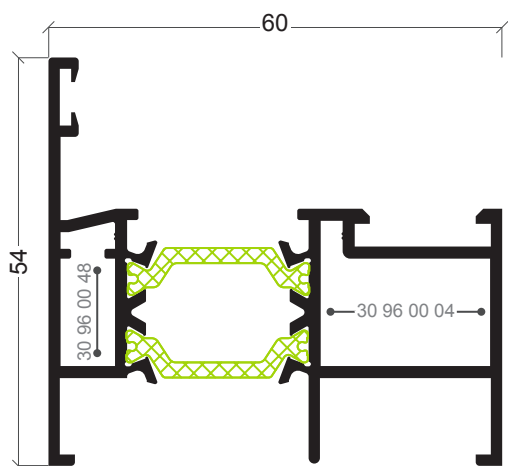

ARi-81
Aro fixo

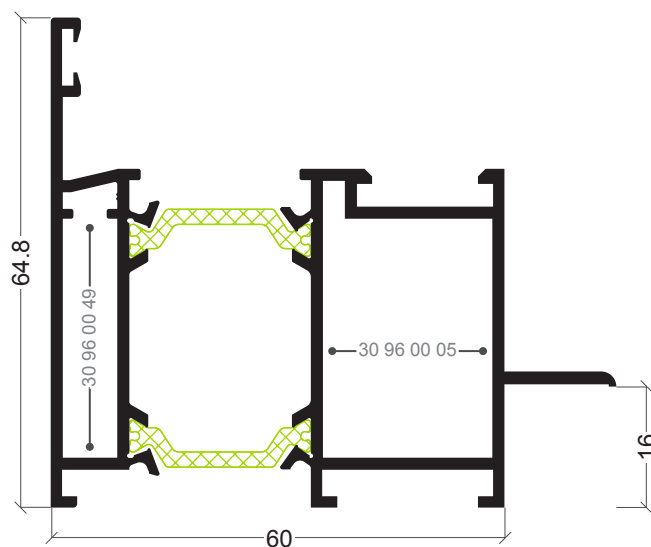

ARi-68
Aro fixo para apainelado

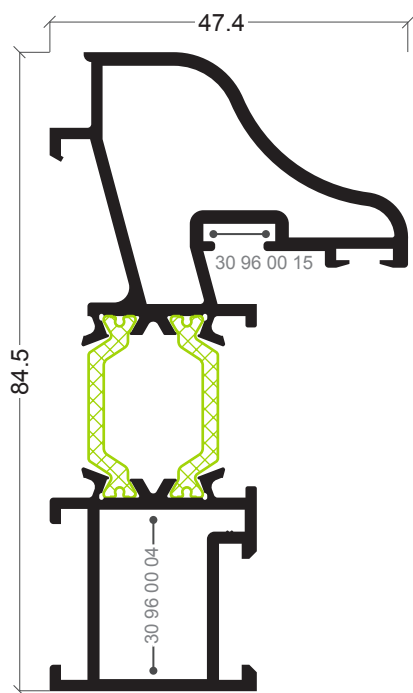

ARi-57
Aro fixo tradição

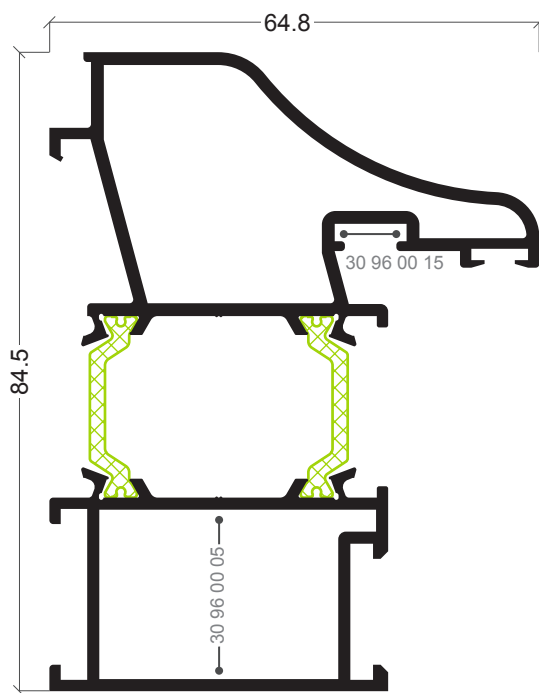

ARi-59
Aro fixo tradição

4

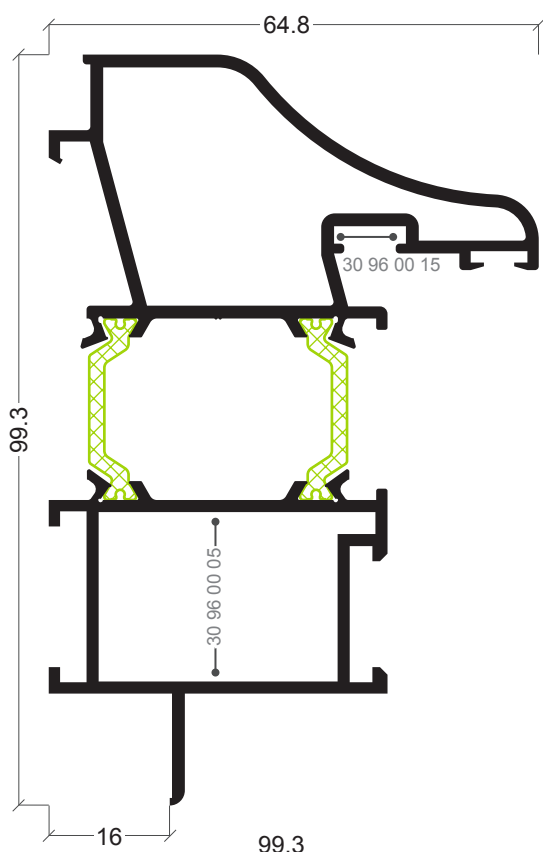

ARi-69
Aro fixo para apainelado

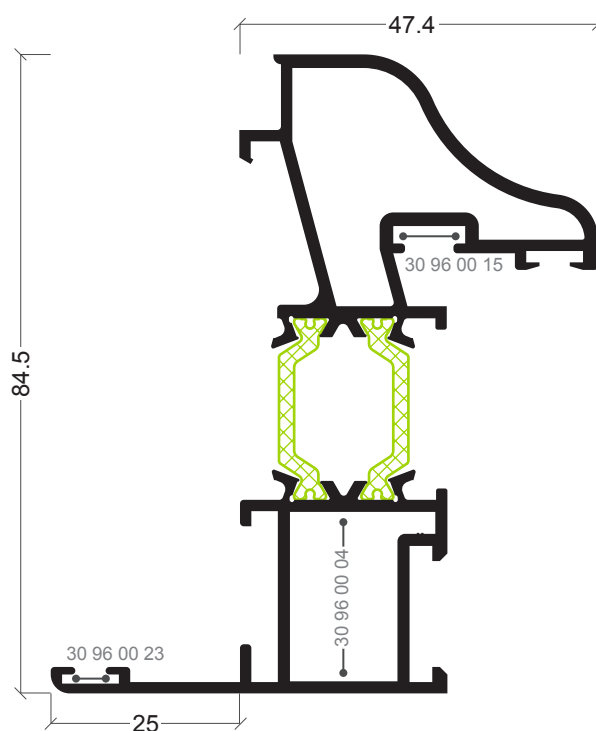

ARi-77
Aro fixo com remate

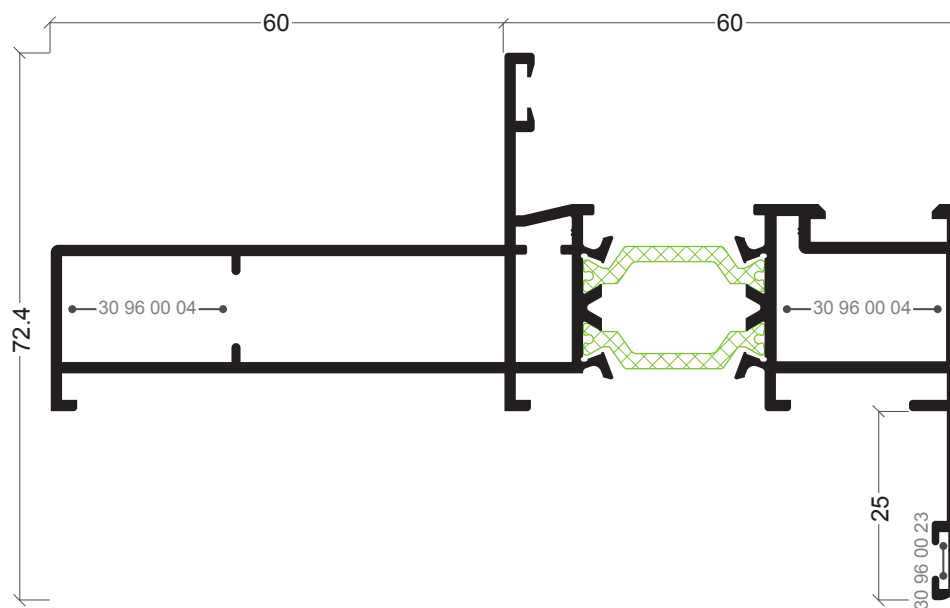

ARi-86
Aro fixo com remate

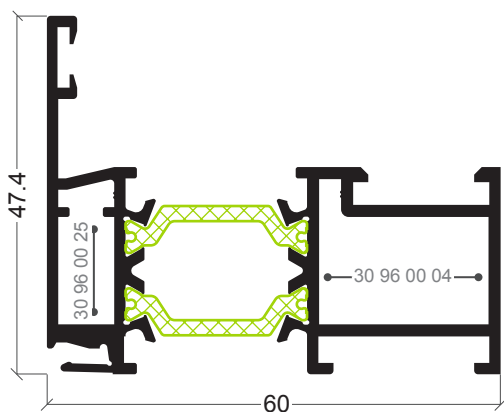

ARi-76
Aro fixo

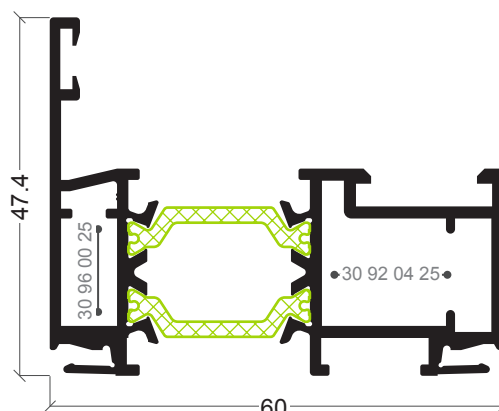

ARi-80
Aro fixo com clip interior/exterior

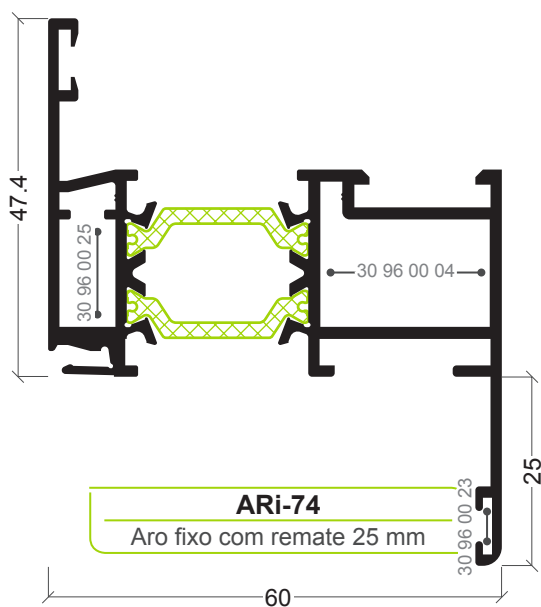

ARi-74
Aro fixo com remate 25 mm

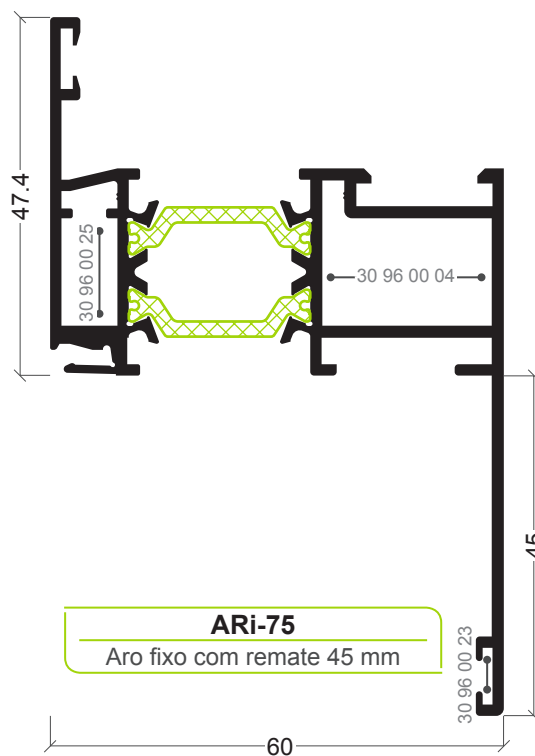

ARi-75
Aro fixo com remate 45 mm

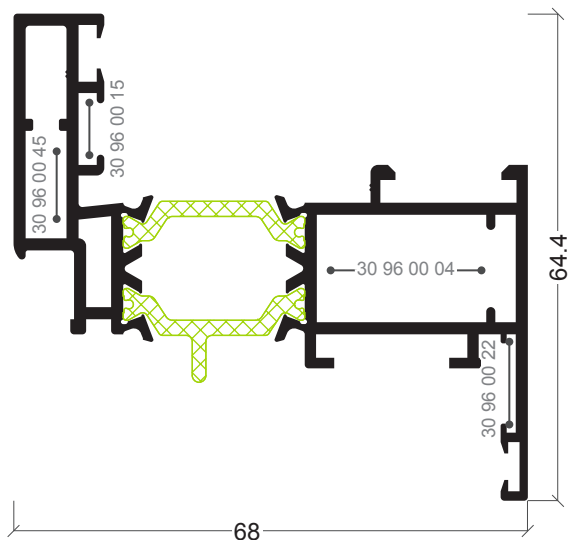

ARi-61
Aro móvel

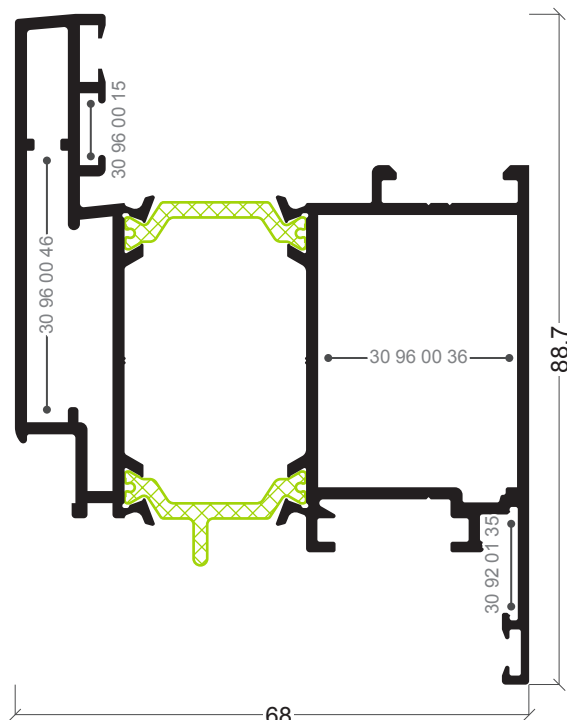

ARi-36
Aro móvel

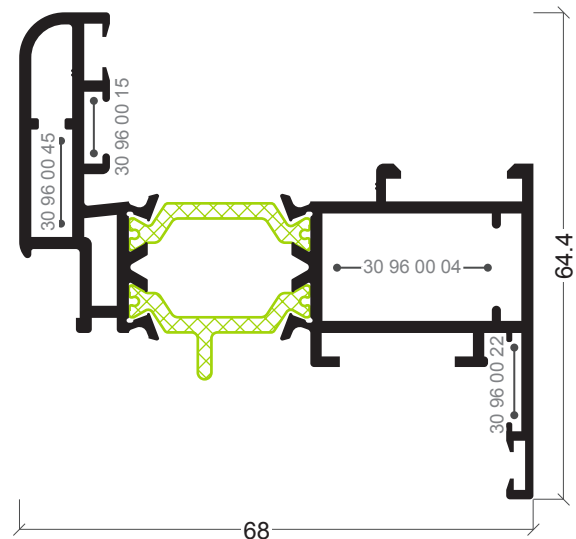

ARi-05
Aro móvel

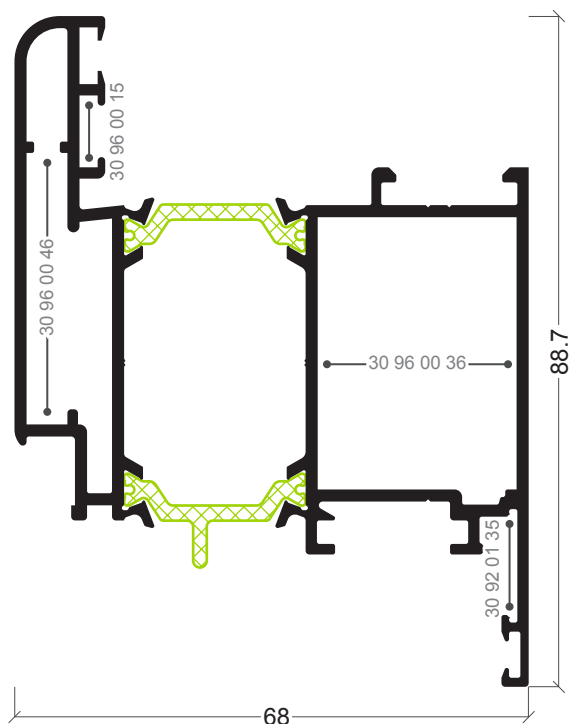

ARi-10
Aro móvel

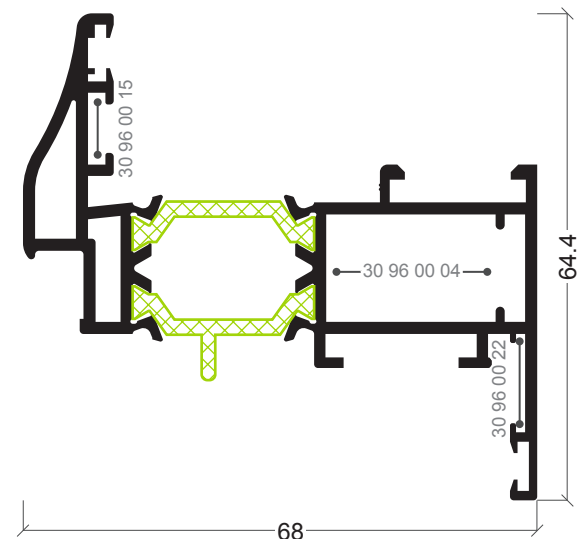

ARi-58
Aro móvel tradição

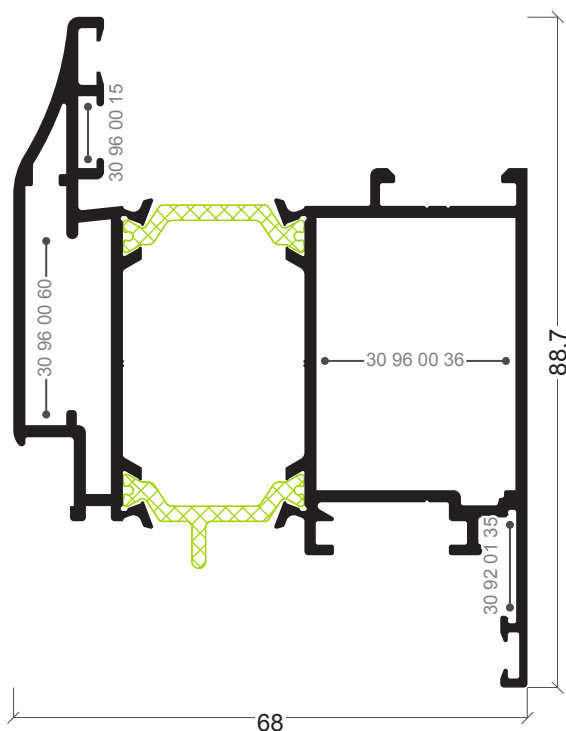

ARi-60
Aro móvel tradição

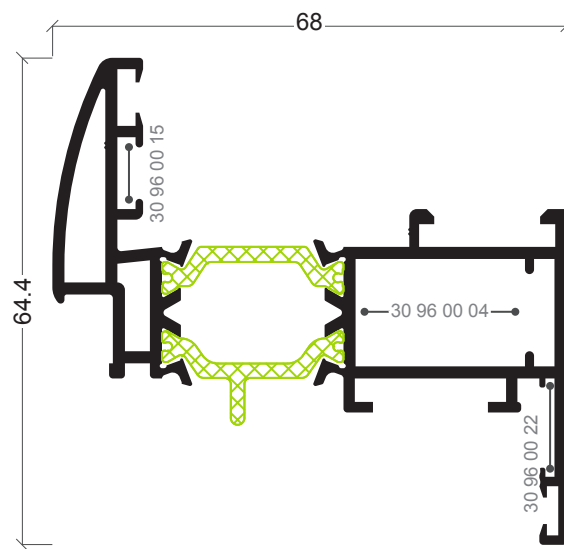

ARi-83
Aro móvel

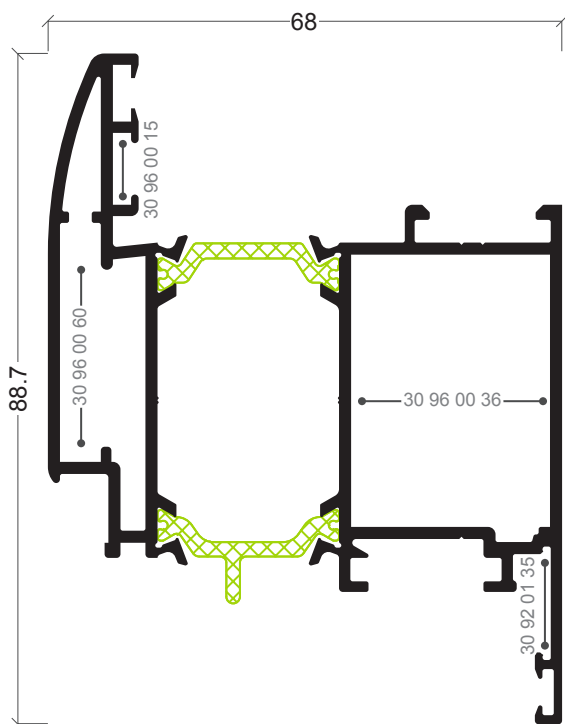

ARi-84
Aro móvel

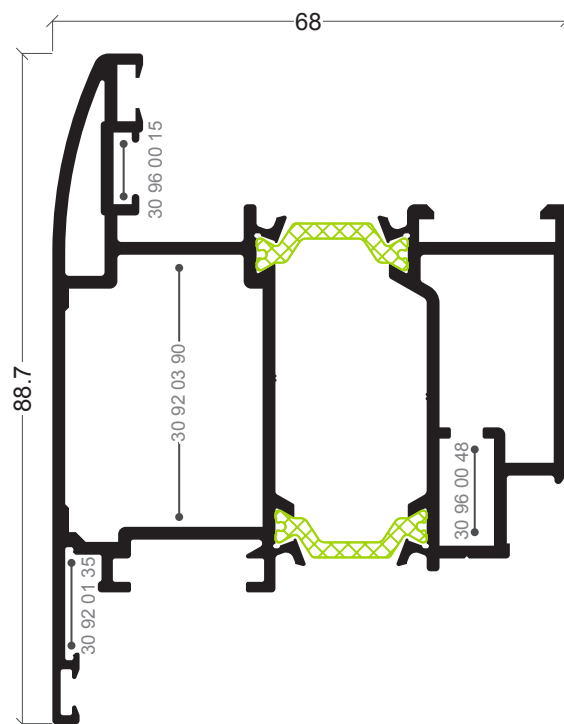

ARi-85
Aro móvel

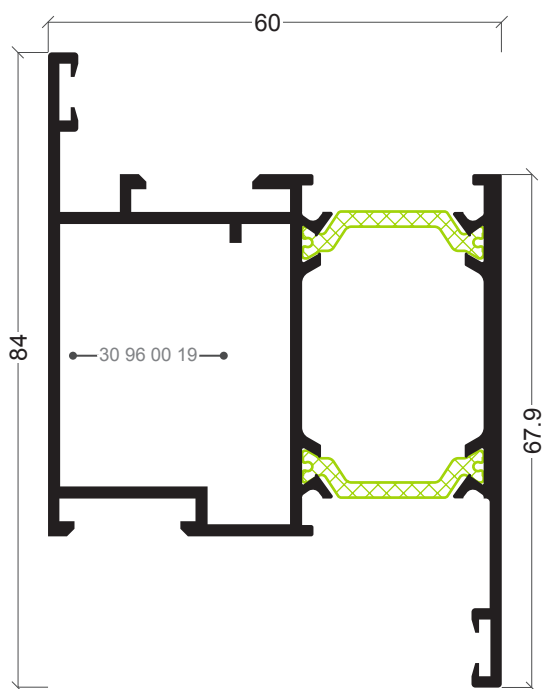

ARi-11
Aro fixo abertura exterior com fixo lateral

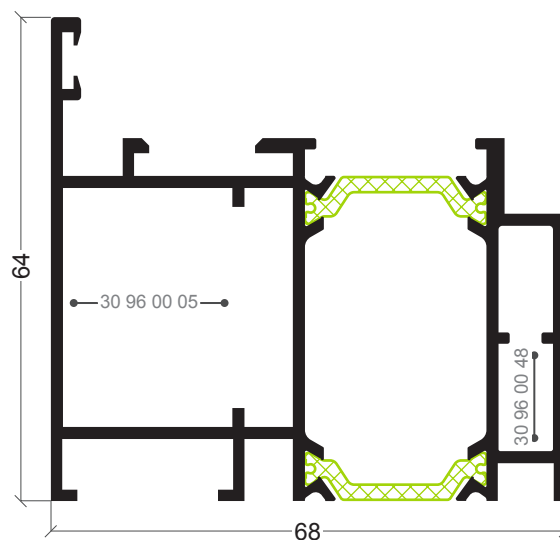

ARi-09
Aro fixo abertura exterior ARi-25

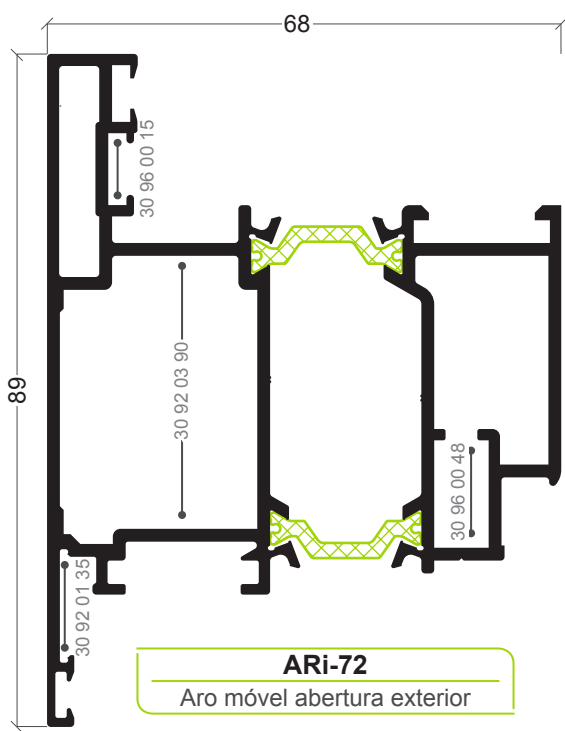

ARi-72
Aro móvel abertura exterior

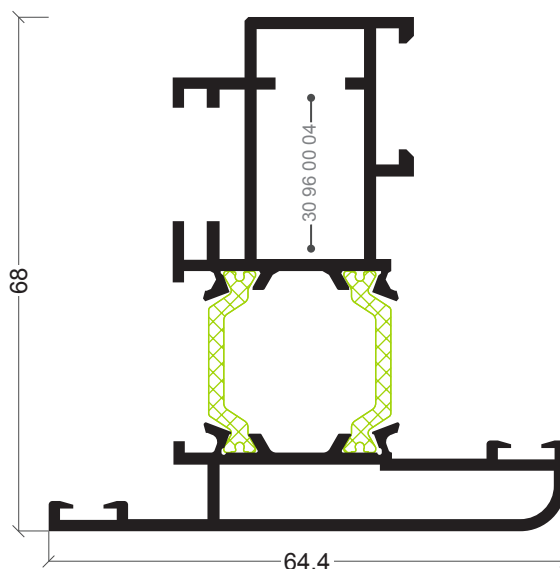

ARi-02
Aro móvel pivotante

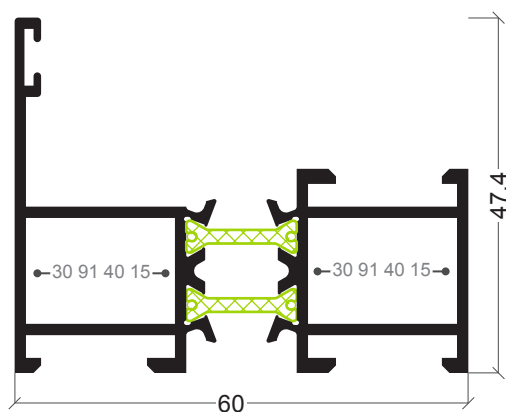

ARi-38
Aro fixo projectante

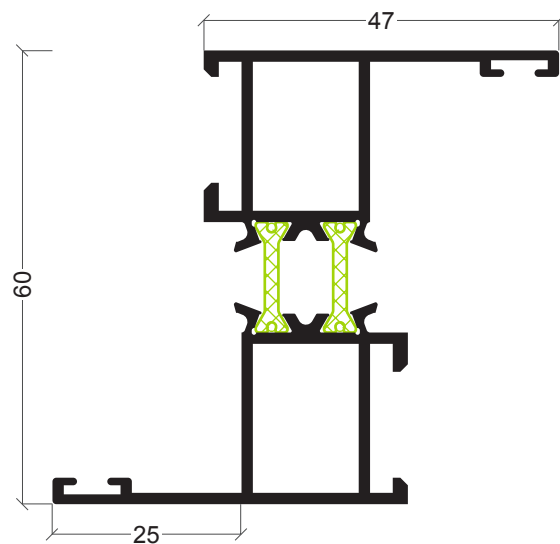

ARi-39
Aro fixo projectante com fixo

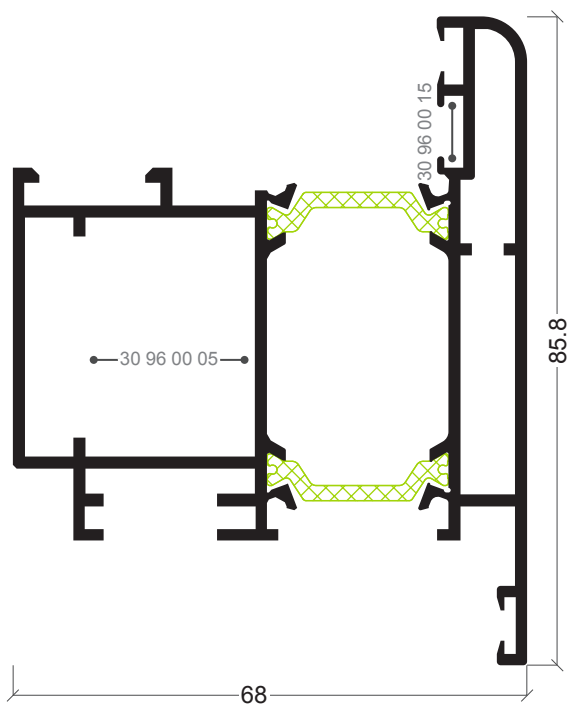

ARi-25
Aro móvel abertura exterior ou pivotante

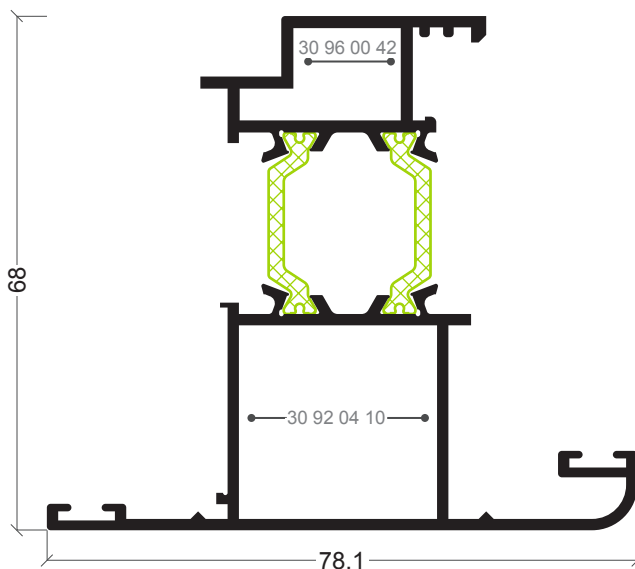

ARi-07
Aro móvel projectante

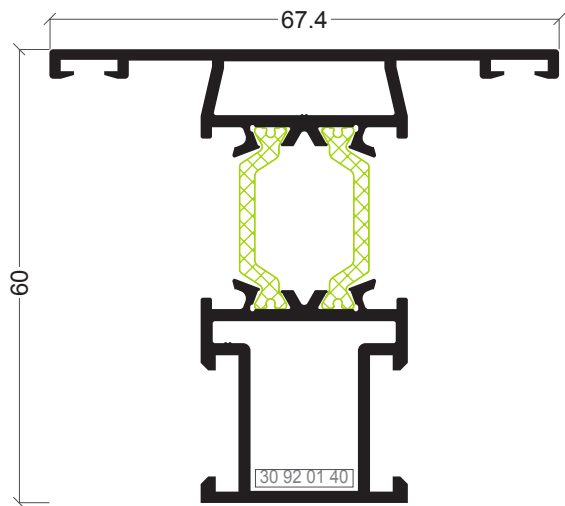

ARi-01
Travessa

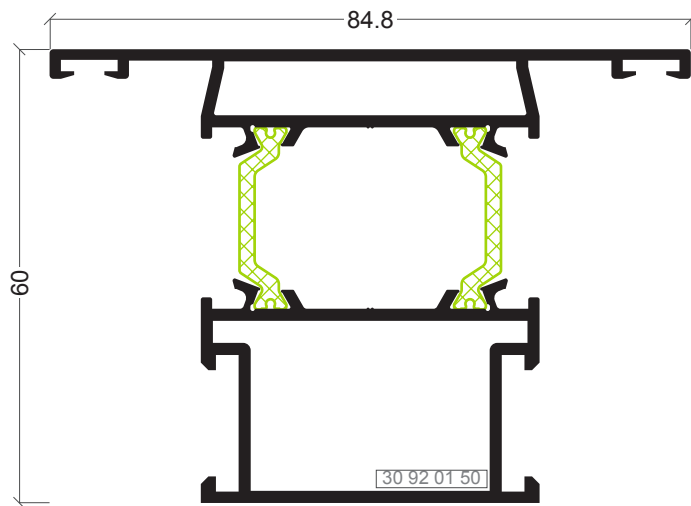

ARi-06
Travessa

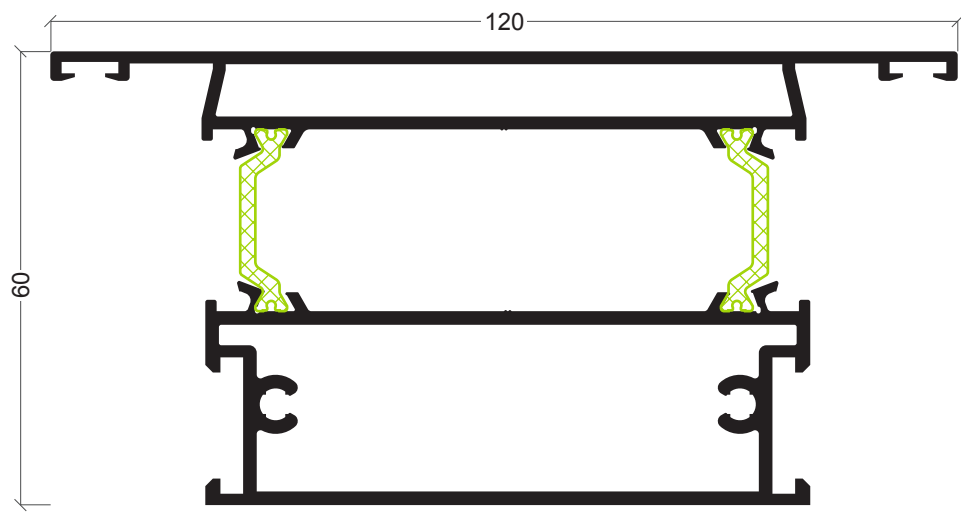

ARi-12
Travessa

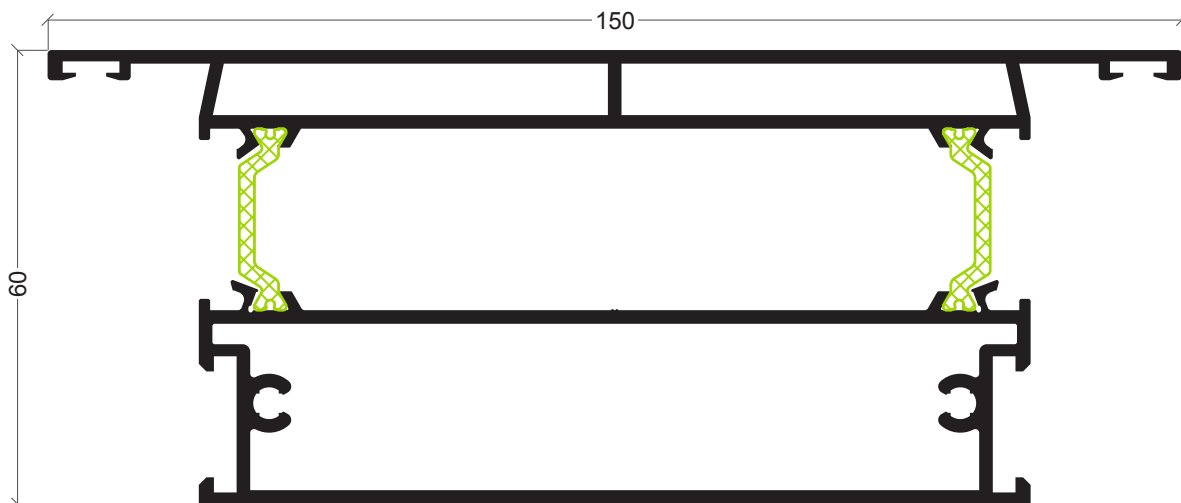

ARi-13
Travessa

10

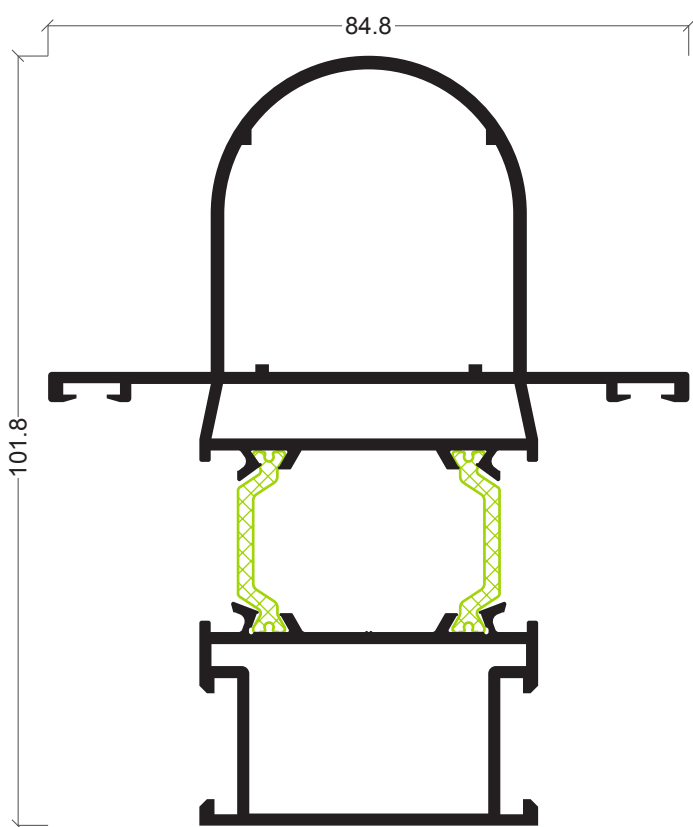

ARi-17
Montante curvo

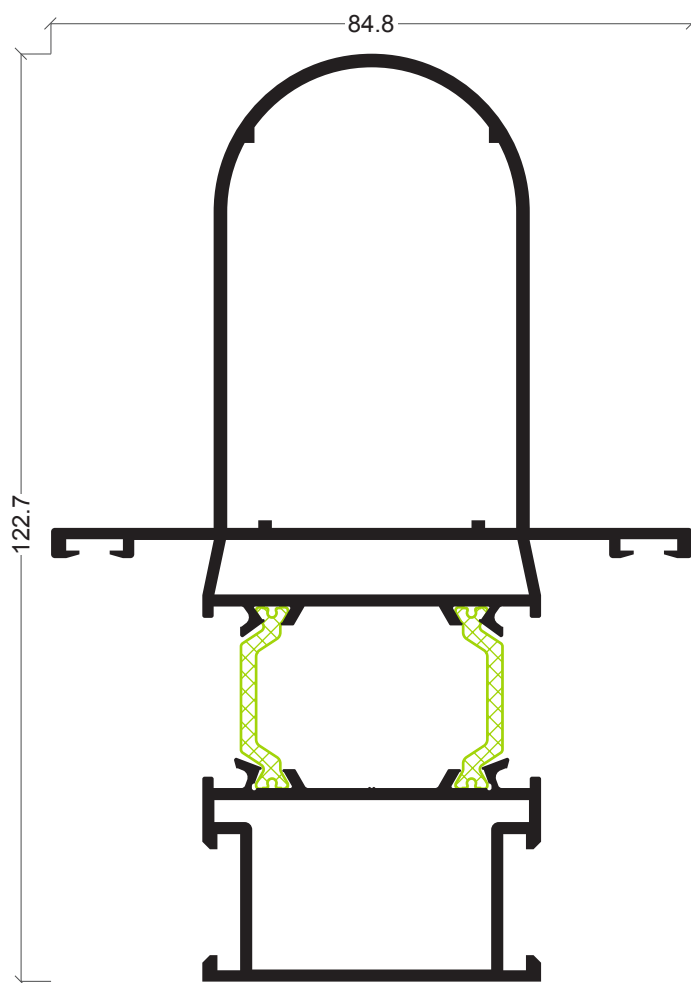

ARi-18
Montante curvo

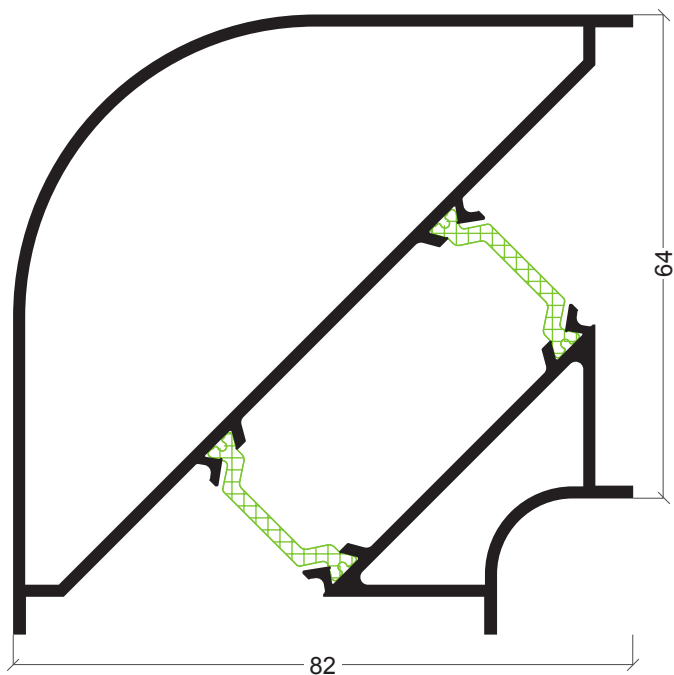

ARi-16
Esquina 90°

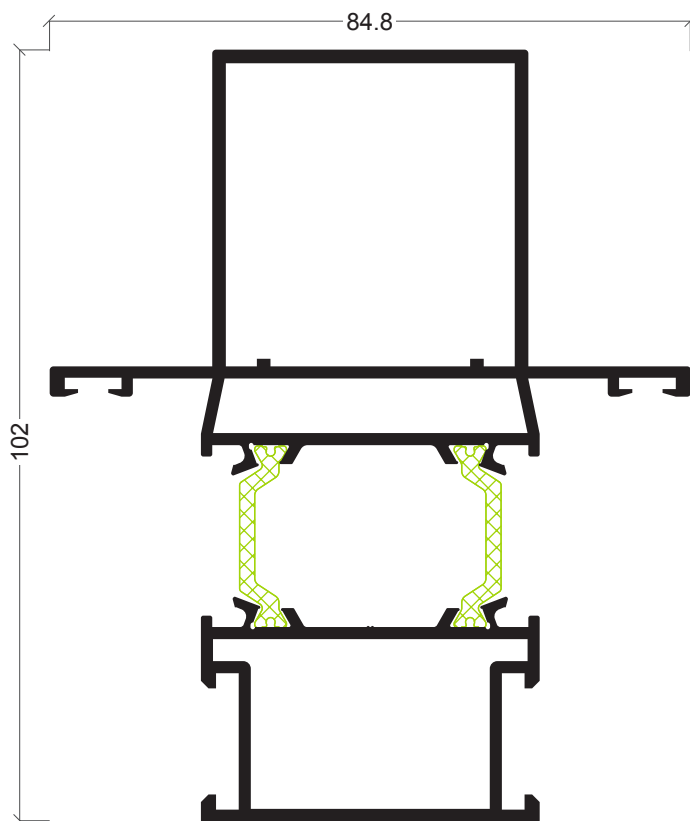

ARi-79
Montante recto

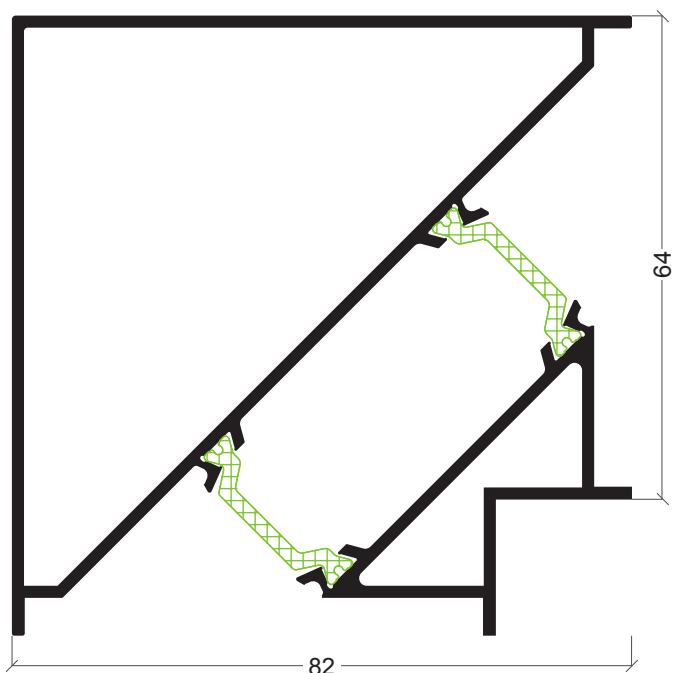

ARi-64
Esquina 90°

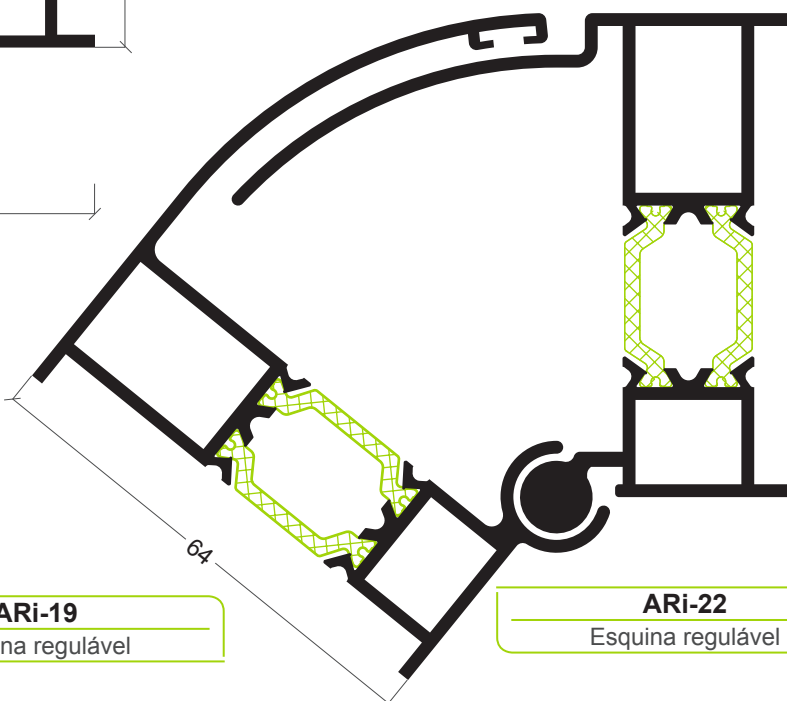

ARi-19
Esquina regulável

ARi-22
Esquina regulável

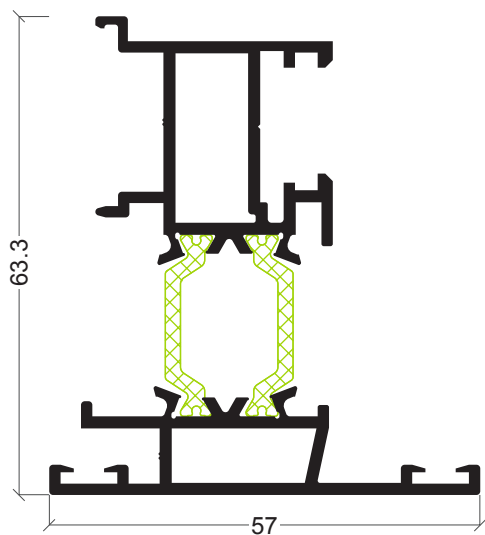

ARi-04
Inversor

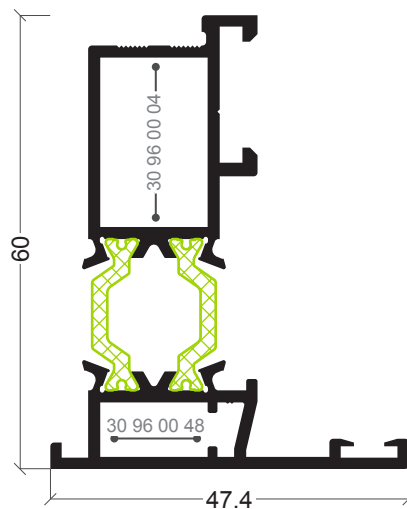

ARi-73
Inversor de sentido de abertura

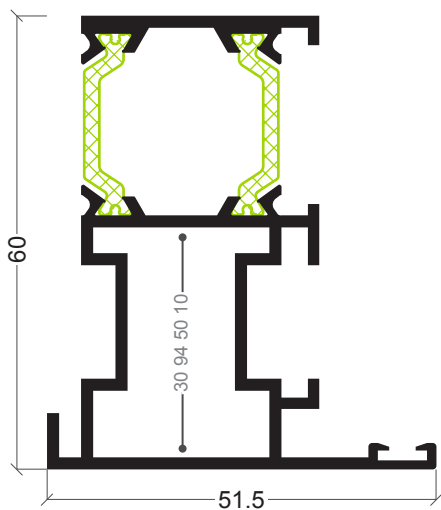

ARi-14
Inversor pivotante

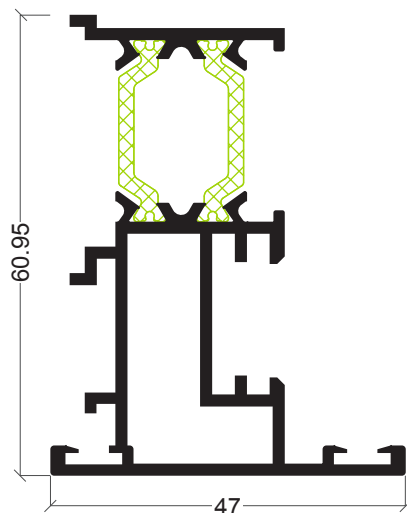

ARi-15
Inversor para ARi-25

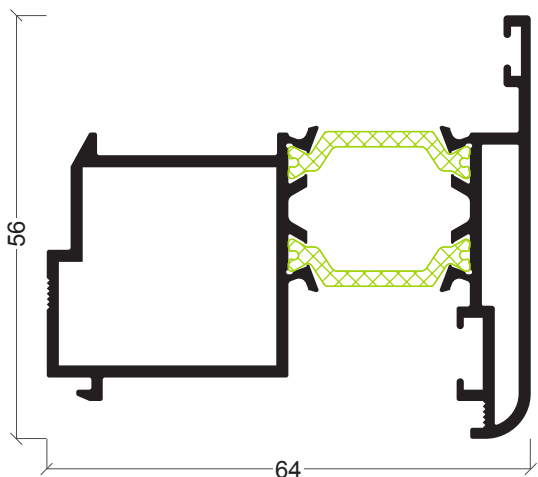

ARi-51
Inversor projectante

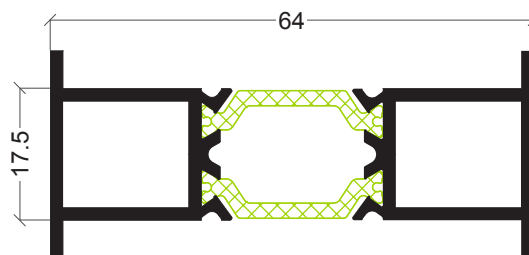

ARi-21
União de aros

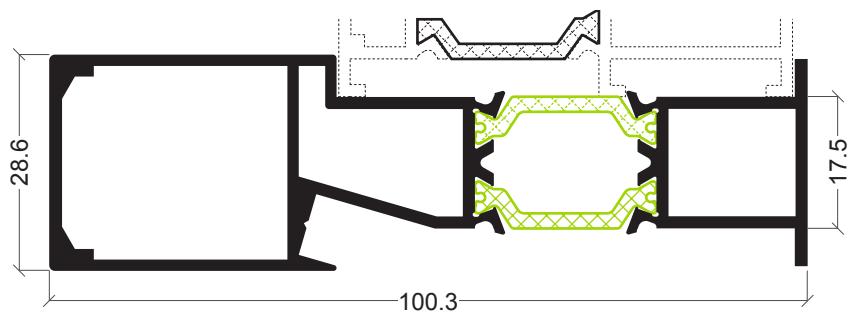

ARi-65
União de aros com reforço

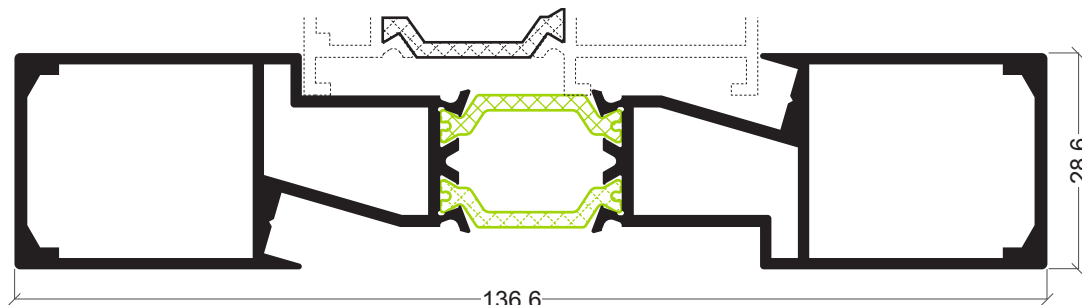

ARi-67
União de aros com reforço

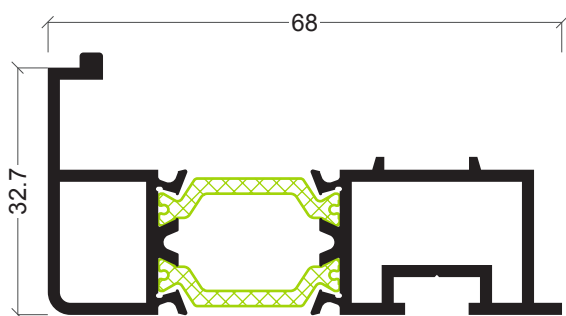

ARi-23
Remate almofada

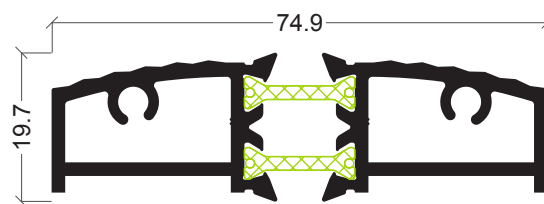

AXi-69
Remate inferior porta

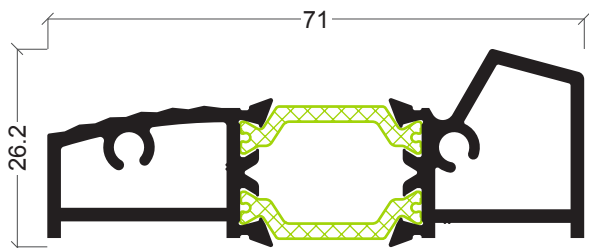

ARi-63
Remate inferior porta

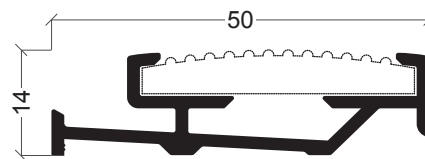

AZ-69
Remate inferior porta

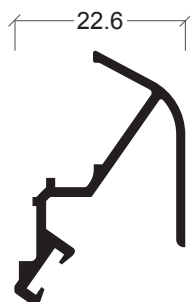

ARi-62
Pingadeira inferior porta

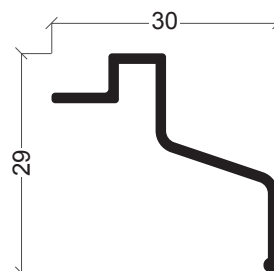

AXi-45
Pingadeira

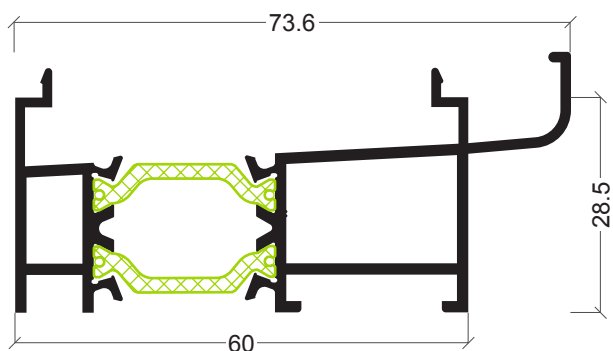

CT-11
Soleira condensação

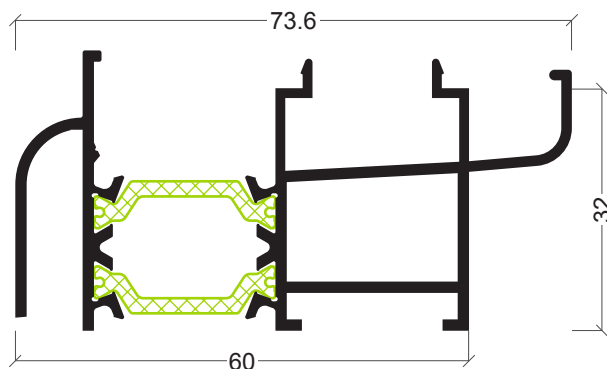

ARi-49
Soleira condensação

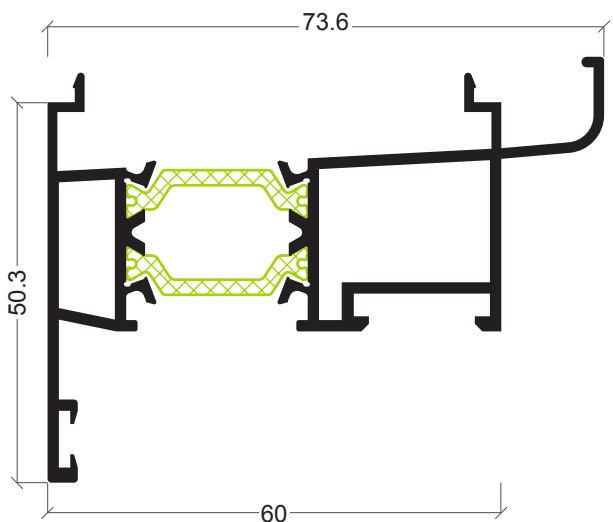

ARi-20
Soleira condensação com fixo inferior

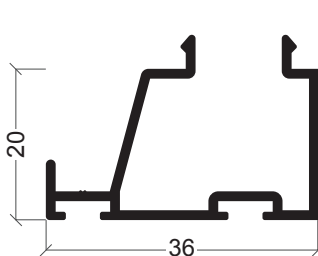

AX-15
Bite remate

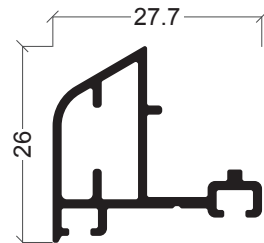

AZ-79
Pingadeira

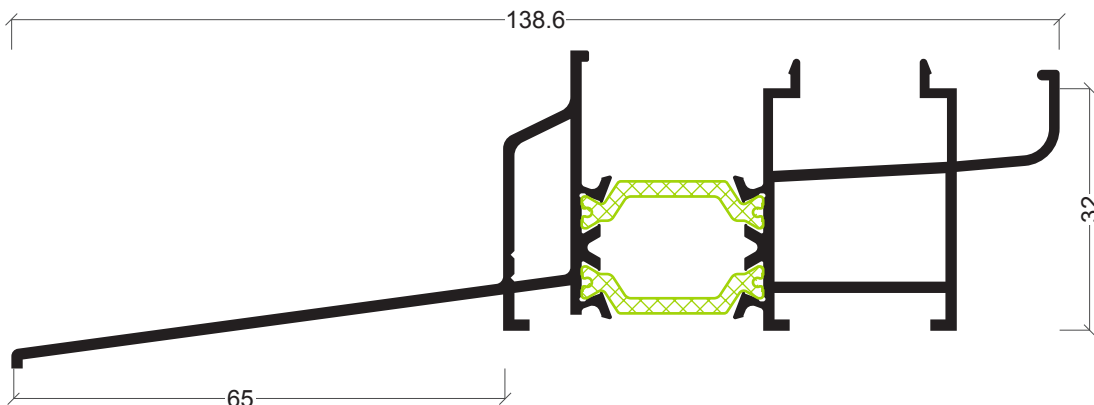

ARi-50
Soleira condensação com pingadeira

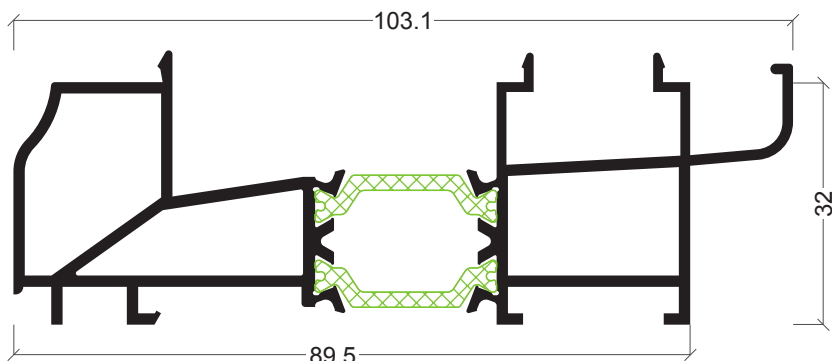

ARi-56
Soleira condensação tradição

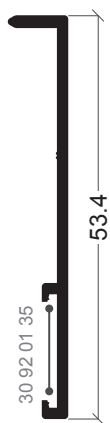

AXi-91
Complemento remate

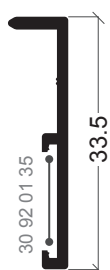

AXi-88
Complemento remate

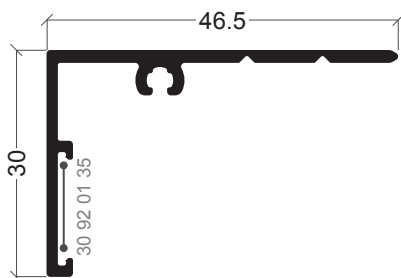

AXi-80
Remate

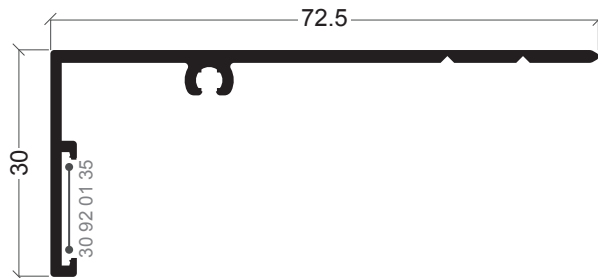

AXi-83
Remate

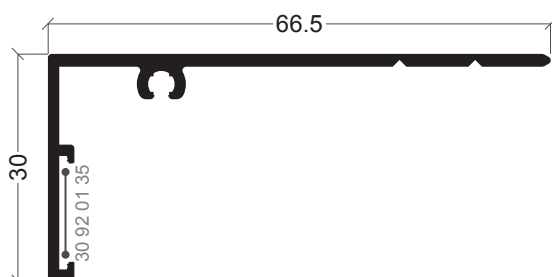

AXi-73
Remate

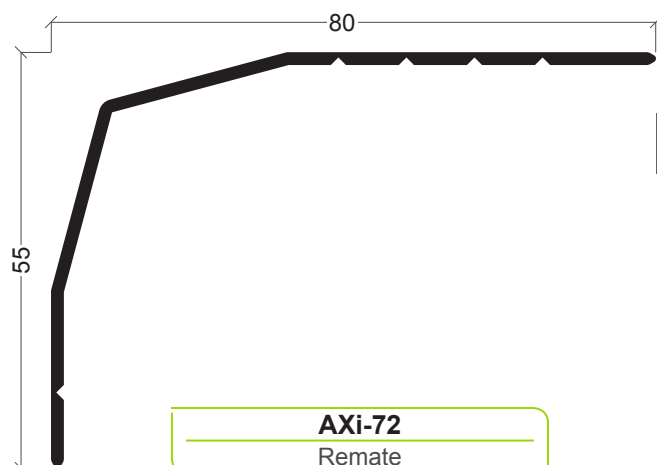

AXi-72
Remate

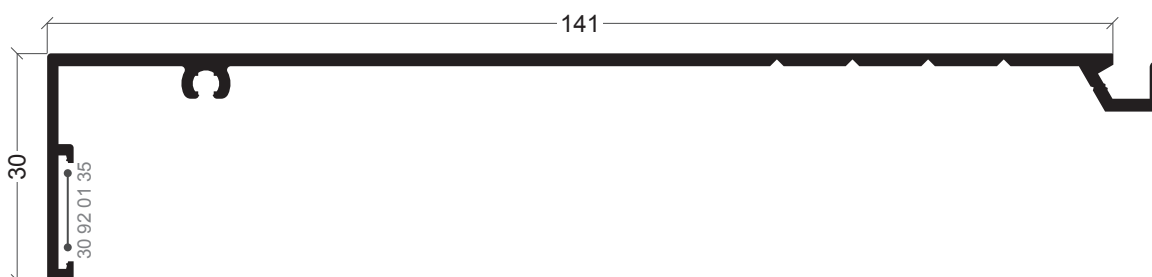

S-09
Remate

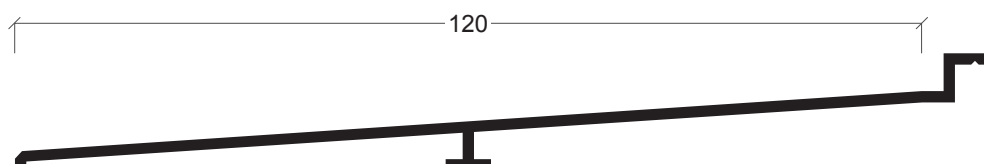

AZ-24
Pingadeira 120 mm

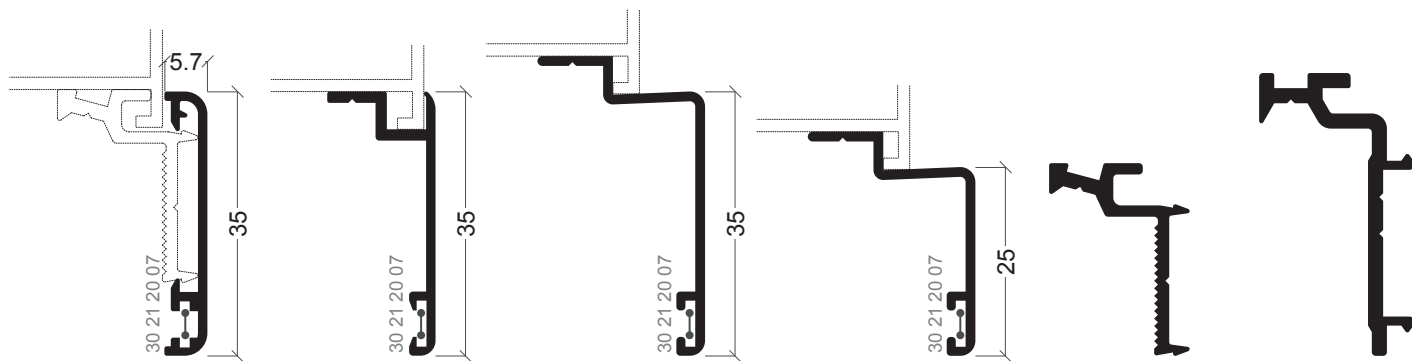

ARi-30
Tapa juntas

ARi-31
Tapa juntas

ARi-37
Tapa juntas

ARi-66
Tapa juntas

ARi-24
Mola tapa juntas

ARi-26
Mola tapa juntas

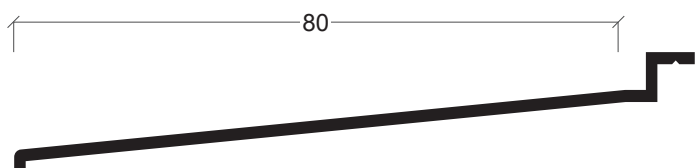

AZ-30
Pingadeira 80 mm

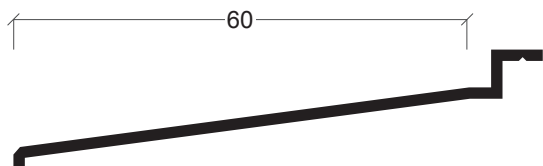

AZ-23
Pingadeira 60 mm

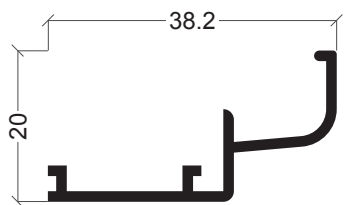

ARi-32
Complemento condensação



AXi-32
Complemento abertura projectante

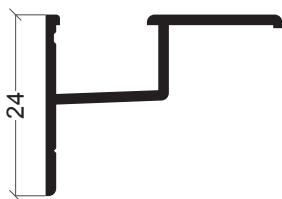

Y-20
Recolha de águas condensação

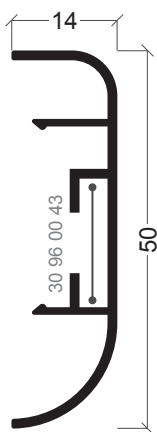

ARi-27
Tapa juntas

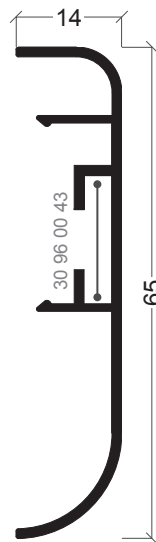

ARi-34
Tapa juntas



ARi-28
Tapa juntas



AX-19
Vareta



AX-33
Mola Bite

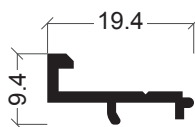

ARi-29
Apoio bite ARi-07

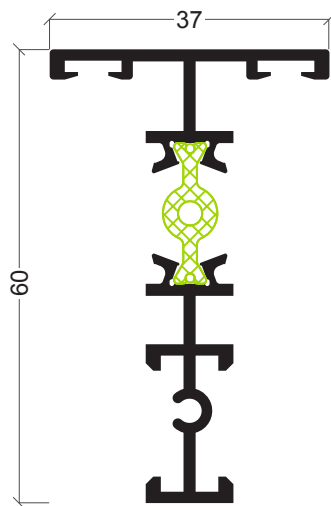

ARi-40
Divisor de vidro

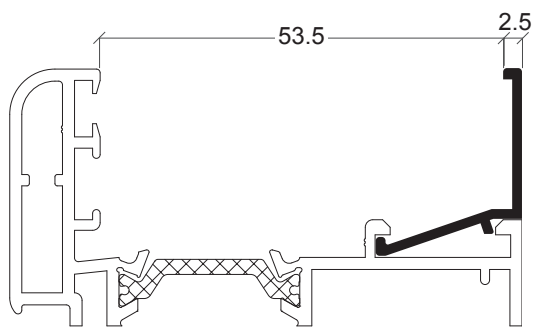

AX-69

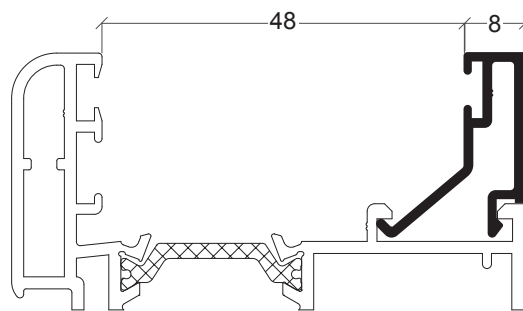

AX-74

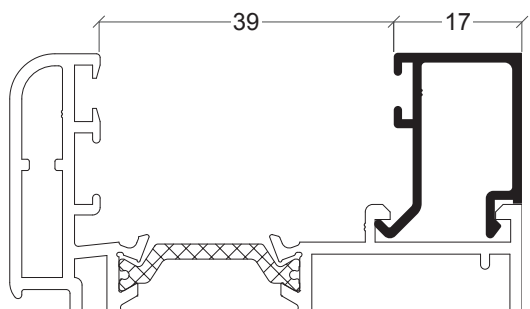

AX-46

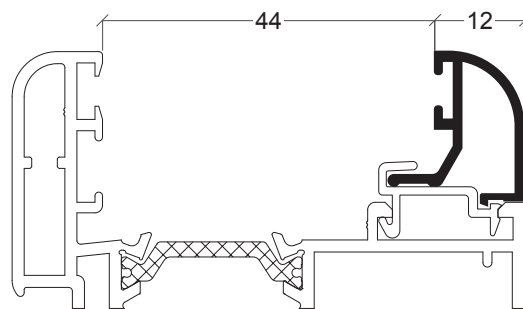

AX-37

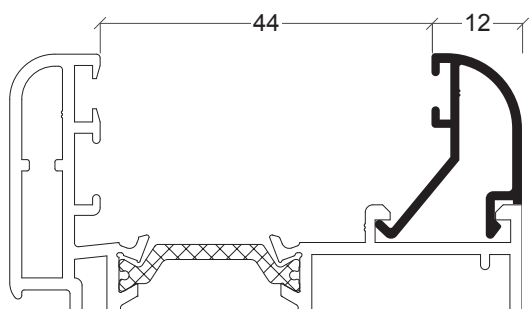

AZ-08

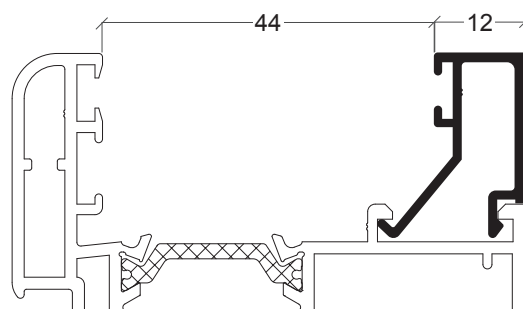

AX-36

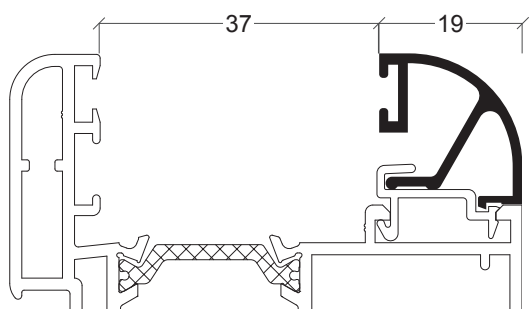

AX-30

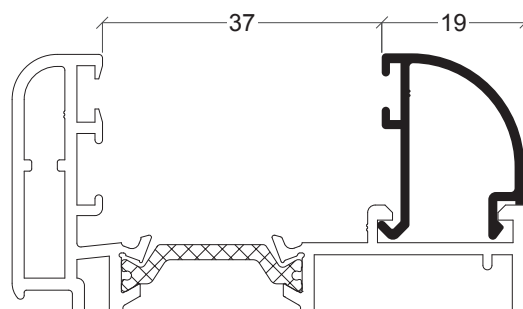

AZ-07

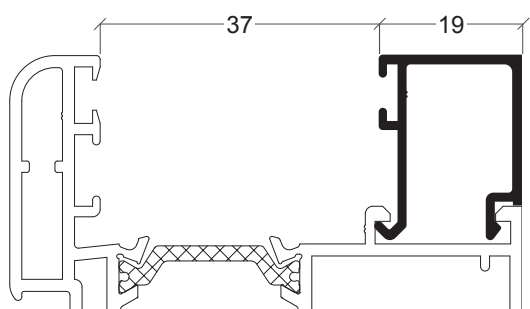

AX-35

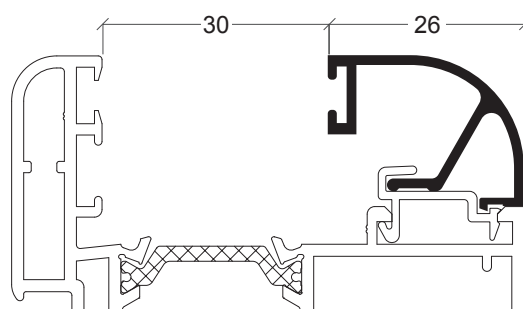

AX-29

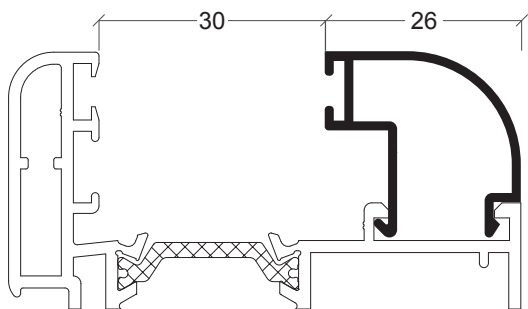

AZ-06

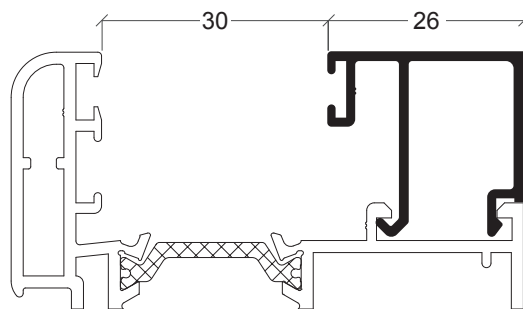

AX-31

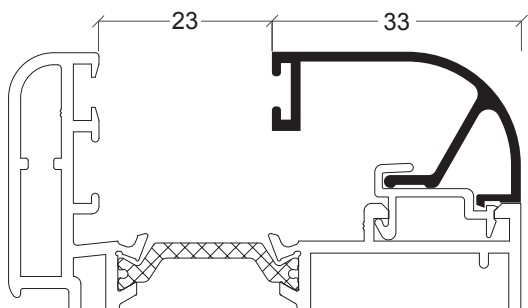

AX-39

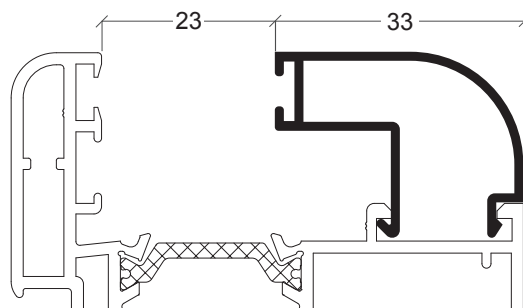

AZ-28

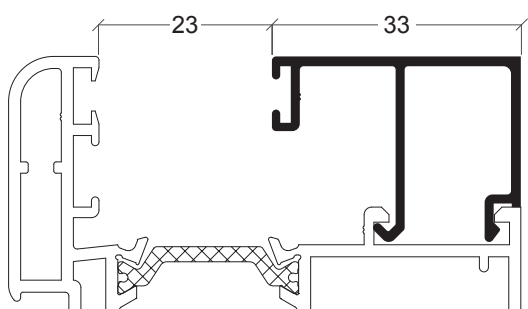

AX-34

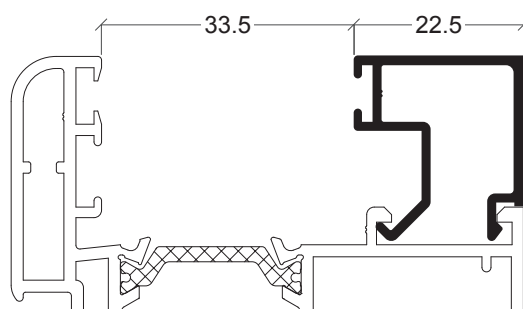

AX-78

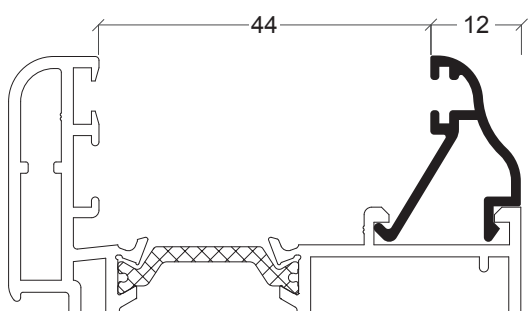

AX-73

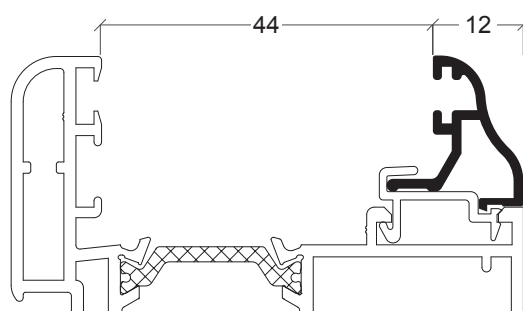

AX-72

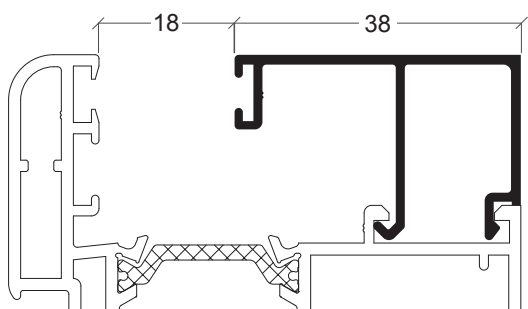

AX-32

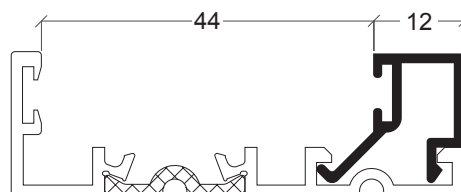

AX-70

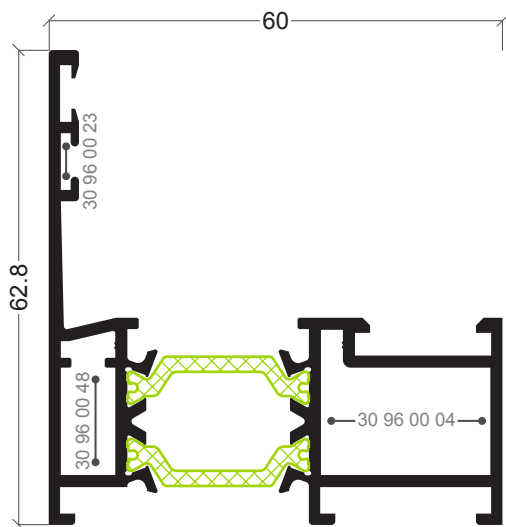

ARi-43
Aro fixo folha oculta

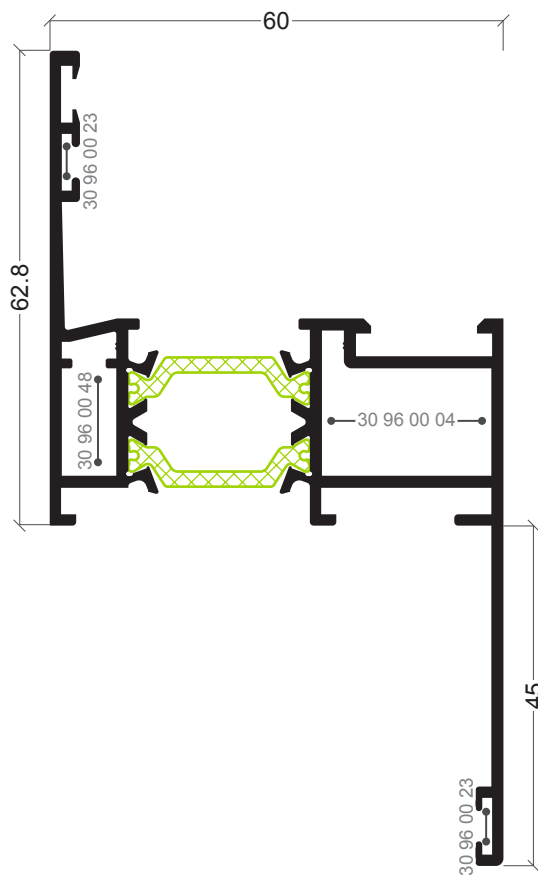

ARi-42
Aro fixo com remate folha oculta

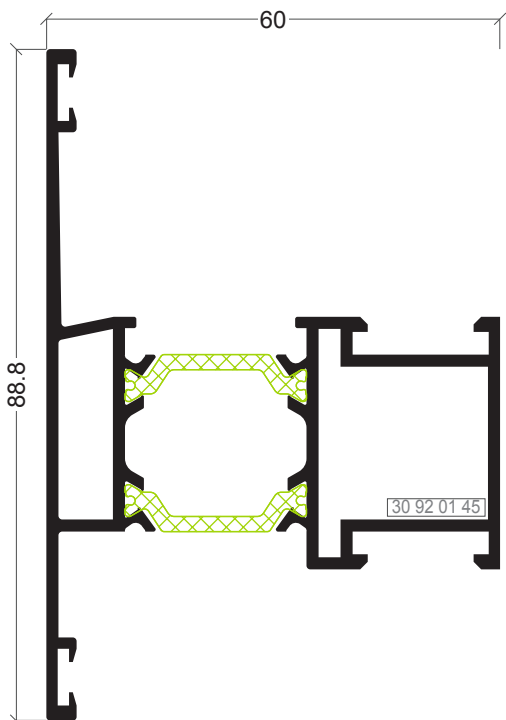

ARi-41
Travessa folha oculta

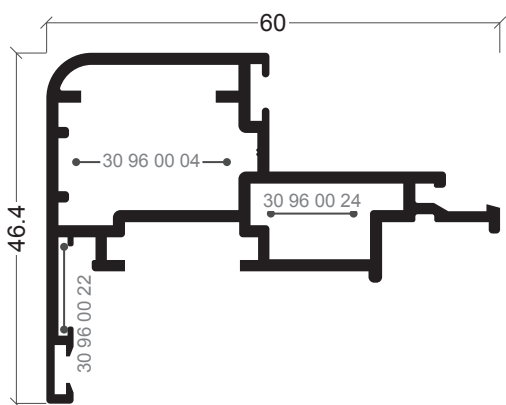

ARi-45
Aro móvel folha oculta

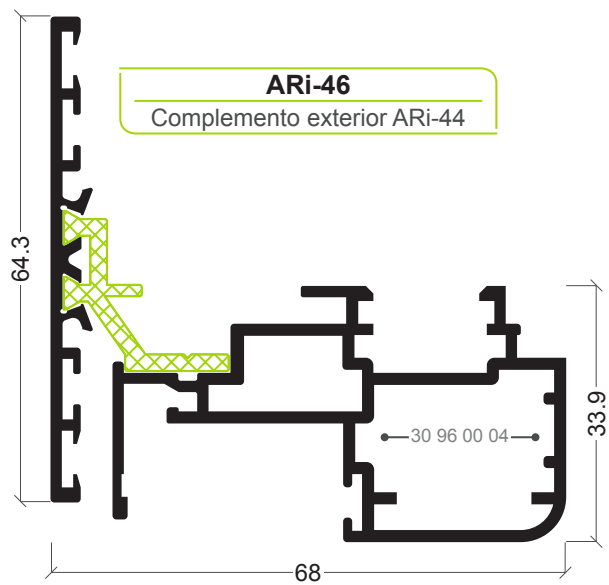

ARi-46
Complemento exterior ARI-44

ARi-44
Aro móvel inversor folha oculta

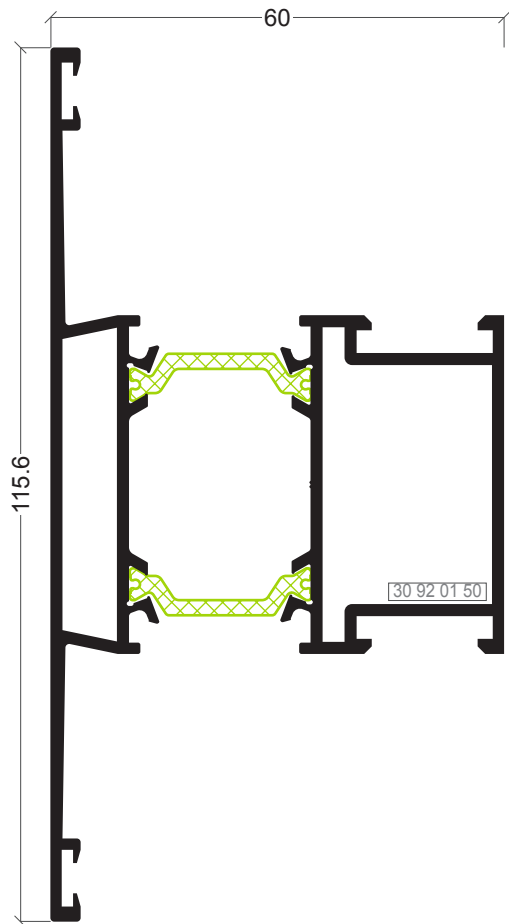

ARi-70
Travessa

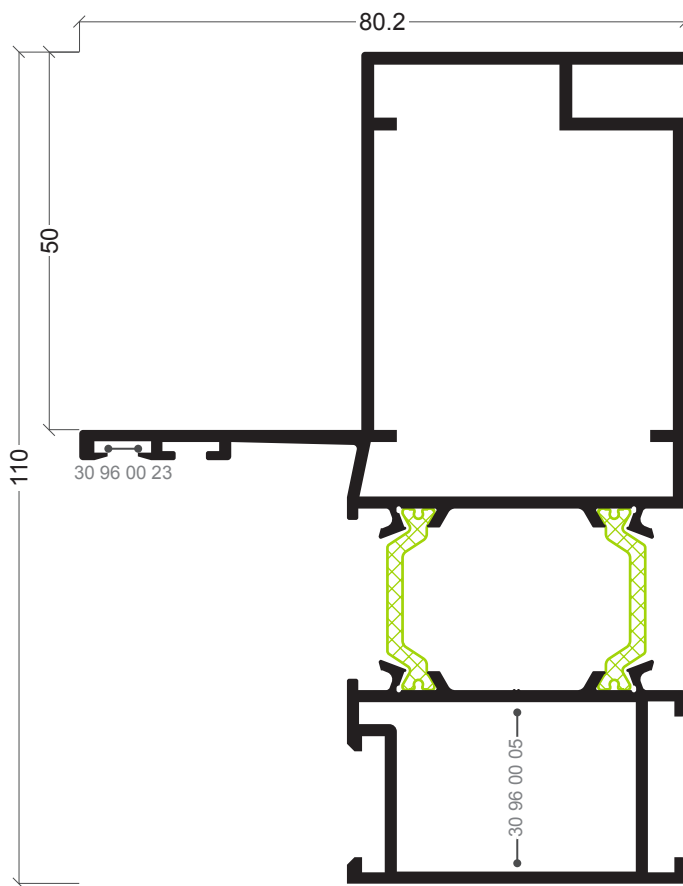

ARi-55
Aro fixo montante

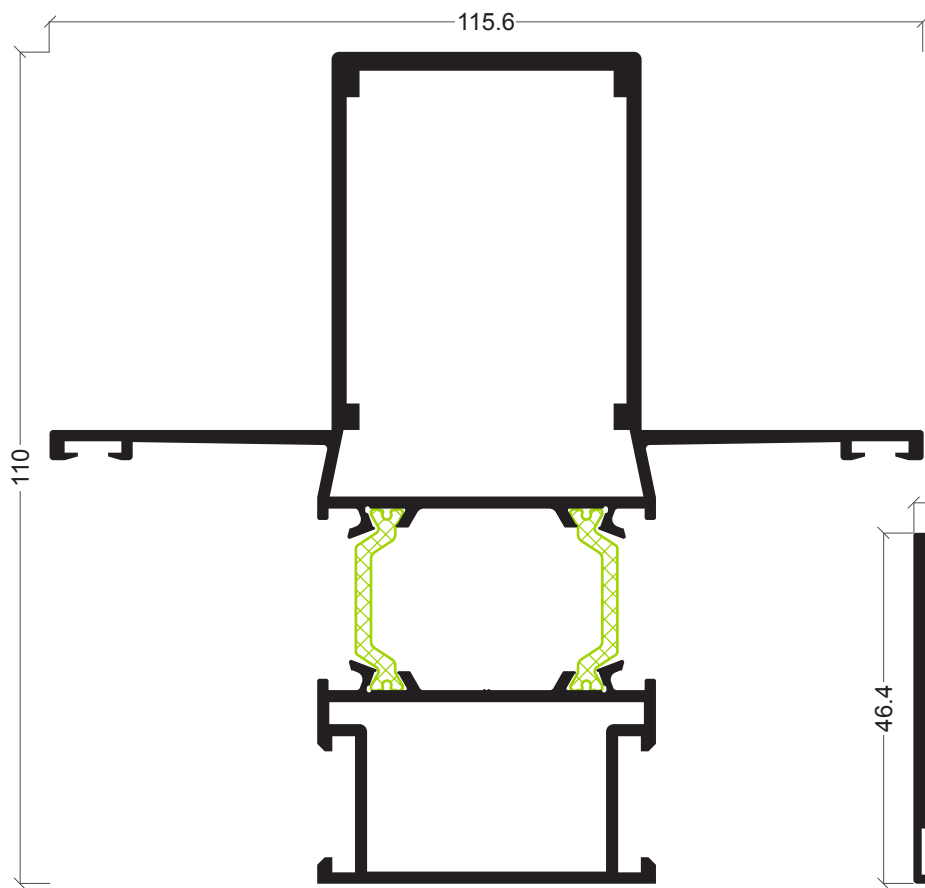

ARi-54
Montante

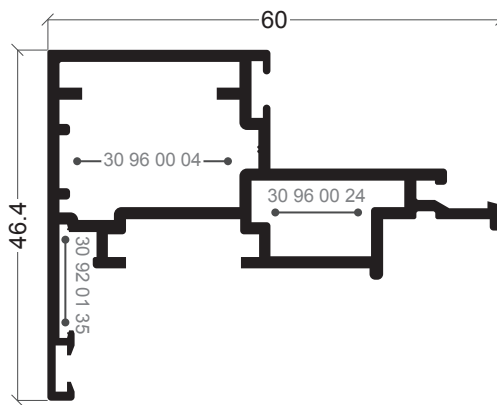

ARi-71
Móvel para vãos de 1 folha ou 1 folha + fixo

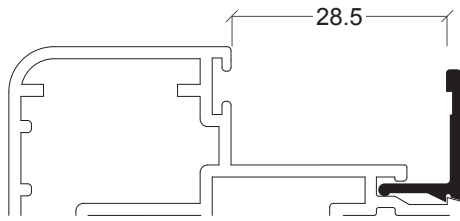

ARi-47

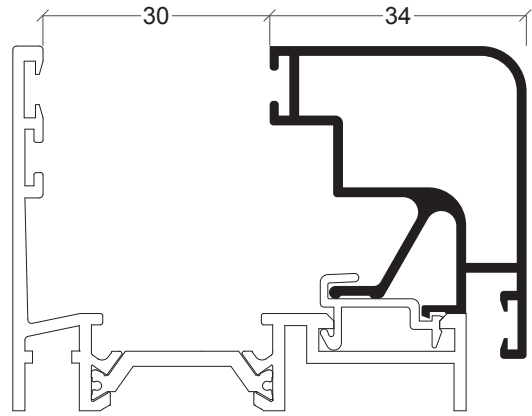

ARi-53

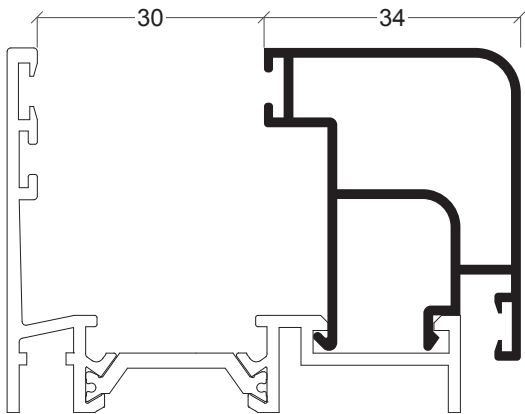

ARi-52

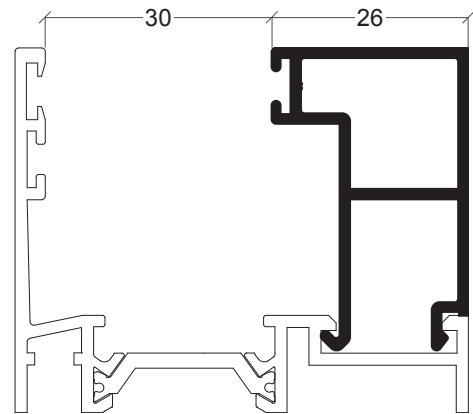

ARi-48

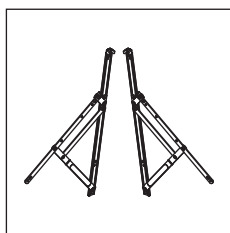

30 00 95 71

Compasso projectante
deslizante até 100 kg/folha

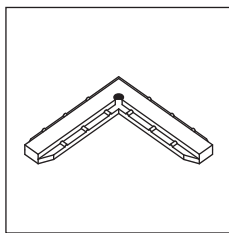

30 21 20 07

Esquadro de
alinhamento

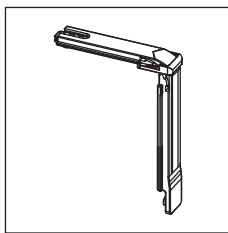

30 90 20 42

Ângulo de reenvio

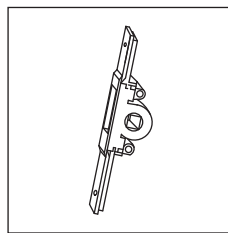

30 90 20 44

Transmissão para
abertura exterior

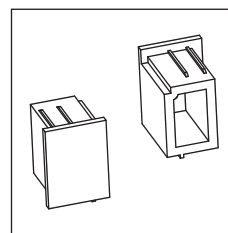

30 91 21 20

Jogo topos condensação
para Y-20

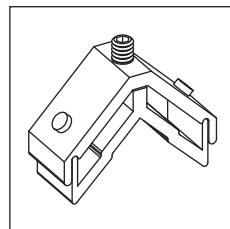

30 91 40 15

Esquadro aro fixo ARi-38

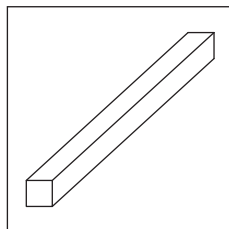

30 91 41 23

Perno 7x131 mm

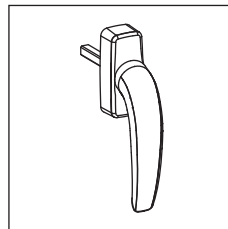

30 91 41 47/48

Cremona pivotante especial
branco/preto

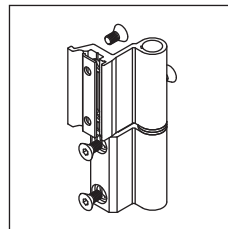

30 92 00 20/21

Dobradiça C.E. branco/
preto

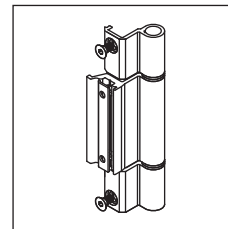

30 92 00 26/27/28

Dobradiça três nós
(bruto/branco/preto)

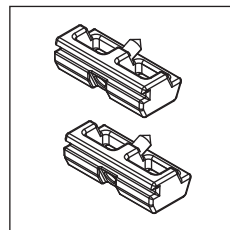

30 92 00 50

Contra-fecho

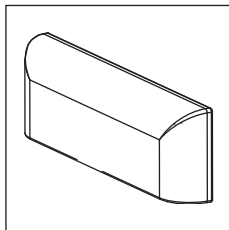

30 92 01 00/01

Goteiras preto/branco

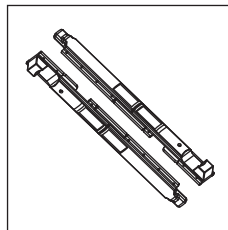

30 92 01 20

Jogo fecho C.E.

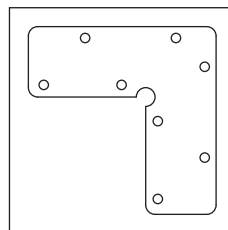

30 92 01 35

Esquadro alinhamento
móvel

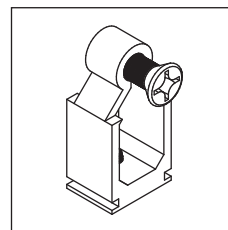

30 92 01 40

União topos janela

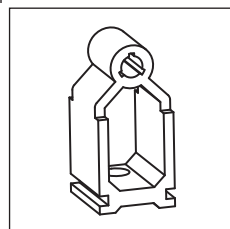

30 92 01 45

União topos janela folha
oculta

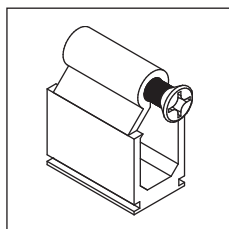

30 92 01 50

União topos porta

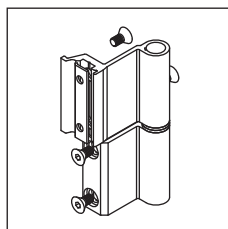

30 92 01 70/80

Dobradiça 3 folhas
branco/preto

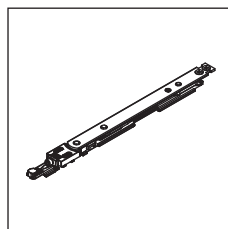

30 92 02 10/11/12

Compasso oscilo
300/400/500

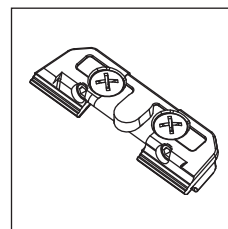

30 92 02 15

Fecho para micro-
ventilação

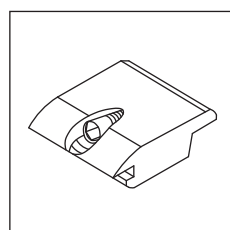

30 92 02 60

Apoio da folha

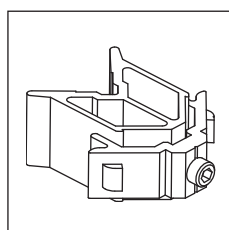

30 92 03 90

Esquadro porta

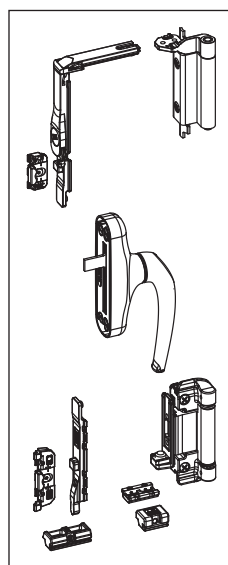

30 92 02 20/21

Kit oscilobatente branco/
preto

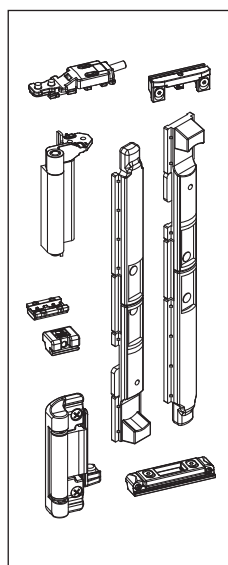

30 92 02 24/25

Kit 2ª folha OB branco/
preto

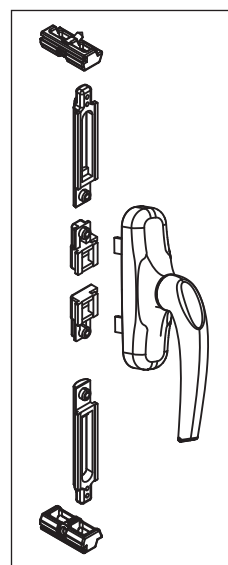

30 92 03 10/11

Kit cremone branco/preto

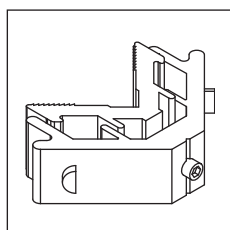

30 92 04 25

Esquadro ARi-80

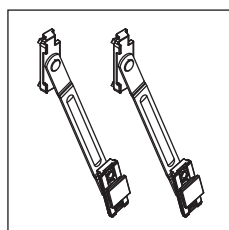

30 92 04 75

Jogo compasso
basculante

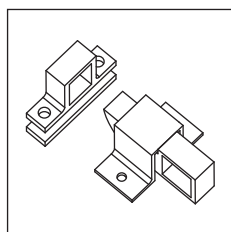

30 92 04 76/77

Fecho clack (branco/preto)

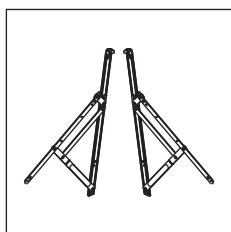

30 92 04 80

Compasso projectante deslizante até 50 kg/folha

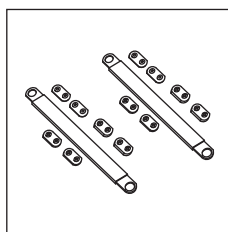

30 92 04 85

Jogo compasso

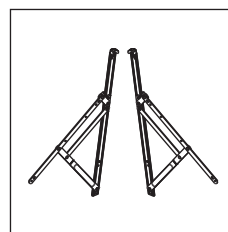

30 92 04 90

Compasso projectante deslizante até 70 kg/folha

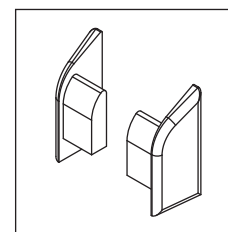

30 92 05 00

Jogo topos

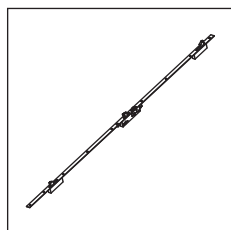

30 92 05 10

Fechadura 3 pontos (35 mm)

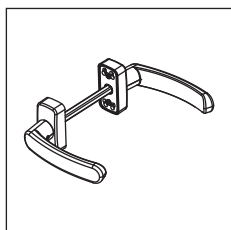

30 92 05 15

Fecho de alavanca com 5 pontos de fecho

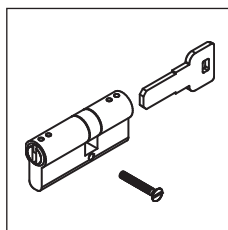

30 92 05 50

Canhão fechadura

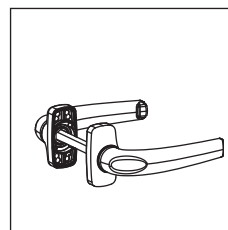

30 92 05 60/61

Puxador duplo branco/preto

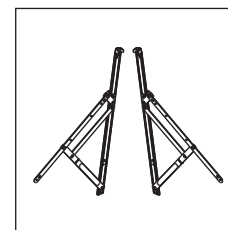

30 92 06 00

Compasso projectante deslizante até 20 kg/folha

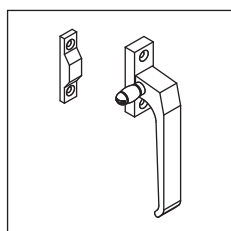

30 92 06 10/11

Cremona de lingueta branco/preto

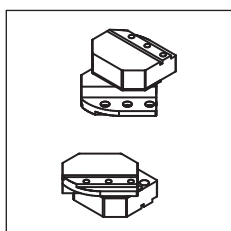

30 92 07 12

Jogo pivotante vertical especial ARi preto (130 kg)

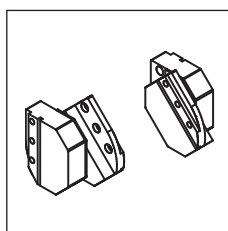

30 92 07 13

Jogo pivotante horizontal especial ARi preto (130 kg)

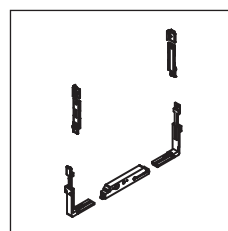

30 92 07 16

Fecho perimetral pivotante especial

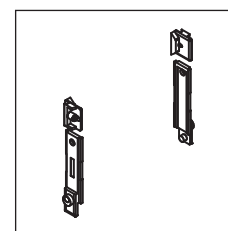

30 92 07 17

Fecho suplementar pivotante especial

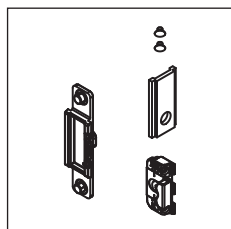

30 92 22 43

Ponto fecho suplementar

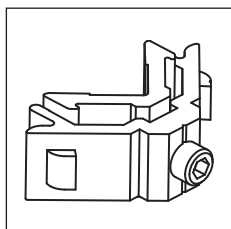

30 96 00 04

Esquadro janela

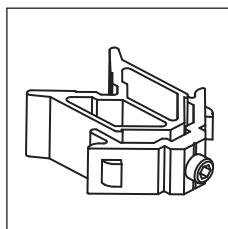

30 96 00 05

Esquadro aro fixo porta

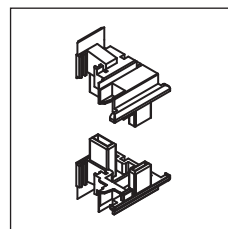

30 96 00 08

Jogo topos inversor ARi

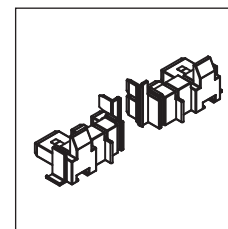

30 96 00 10

Jogo topos ARi-23

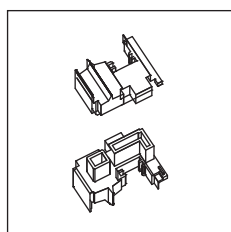

30 96 00 11

Jogo topos inversor abertura exterior ARi-15

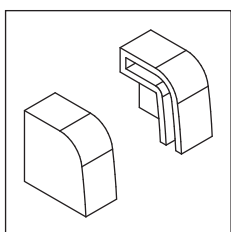

30 96 00 12

Jogo topos condensação

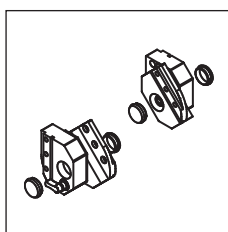

30 96 00 13

Jogo pivotante (60 kg)

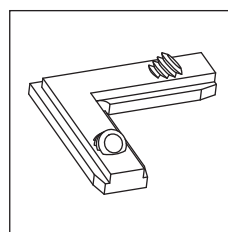

30 96 00 15

Esquadro alinhamento móvel

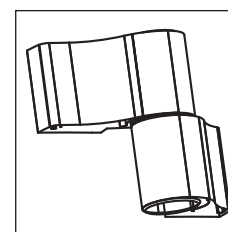

30 96 00 16/20

Dobradiça lisa (branco/preto)

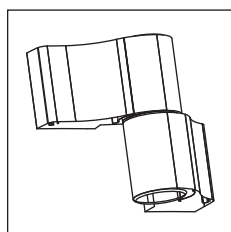

30 96 00 17/21

Dobradiça com ressalto (branco/preto)

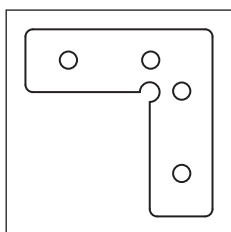

30 96 00 22

Esquadro alinhamento especial

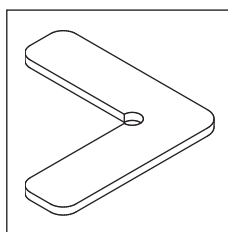

30 96 00 23

Esquadro alinhamento aro fixo

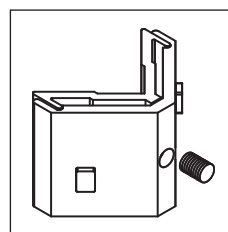

30 96 00 24

Esquadro exterior móvel folha oculta

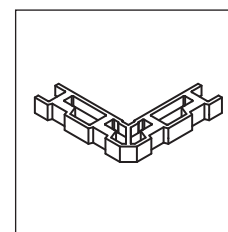

30 96 00 25

Esquadro exterior aro fixo

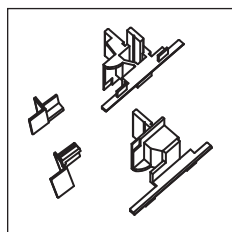

30 96 00 26
Jogo topos inversor folha oculta

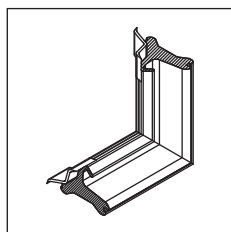

30 96 00 35
Canto vulcanizado

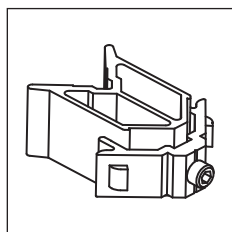

30 96 00 36
Esquadro aro móvel porta

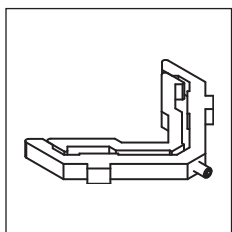

30 96 00 38
Esquadro alinhamento móvel janela

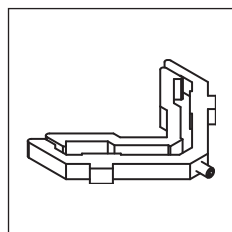

30 96 00 39
Esquadro para alinhamento fixo janela

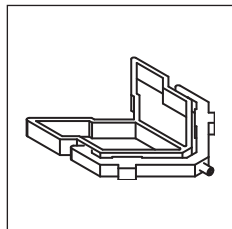

30 96 00 40
Esquadro alinhamento aro fixo porta

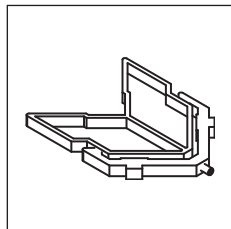

30 96 00 41
Esquadro alinhamento aro móvel porta

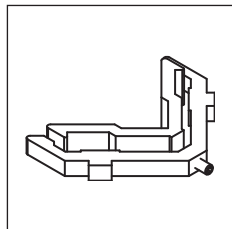

30 96 00 42
Esquadro perfil ARI-07

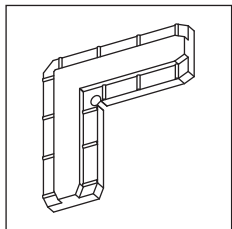

30 96 00 43
Esquadro alinhamento

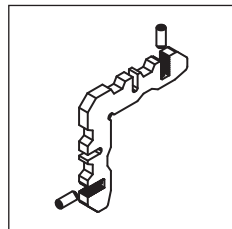

30 96 00 45
Esquadro de alinhamento 5.2x14 com parafusos

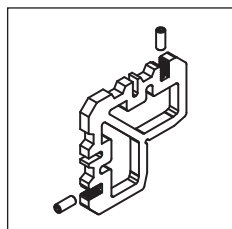

30 96 00 46
Esquadro de alinhamento 5.2x36 com parafusos

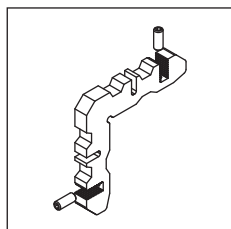

30 96 00 48
Esquadro de alinhamento 7x14 c/ parafusos

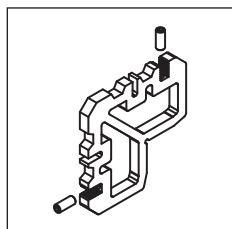

30 96 00 49
Esquadro de alinhamento aro fixo com parafusos

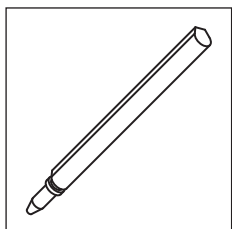

30 96 00 55
Perno alternativo para fixação de esquadro

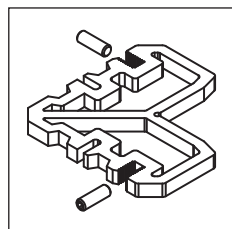

30 96 00 60
Esquadro de alinhamento 5.2x31.6 com parafusos

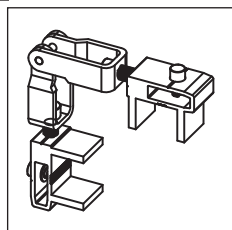

30 96 00 64
Esquadro Angular 31 ARI-08/59/68/69

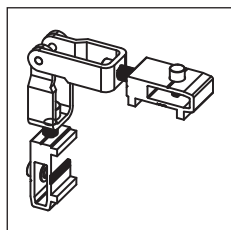

30 96 00 68
Esquadro Angular 14 ARI-03/05/33/35/57/58/61/74/76/77/81/83/97

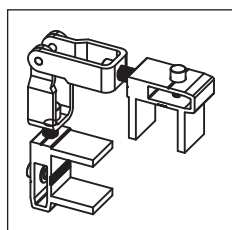

30 96 00 69
Esquadro Angular 36 ARI-10/36/60/54

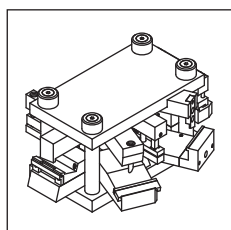

33 96 79 99
Cunho C.E.

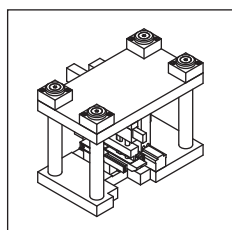





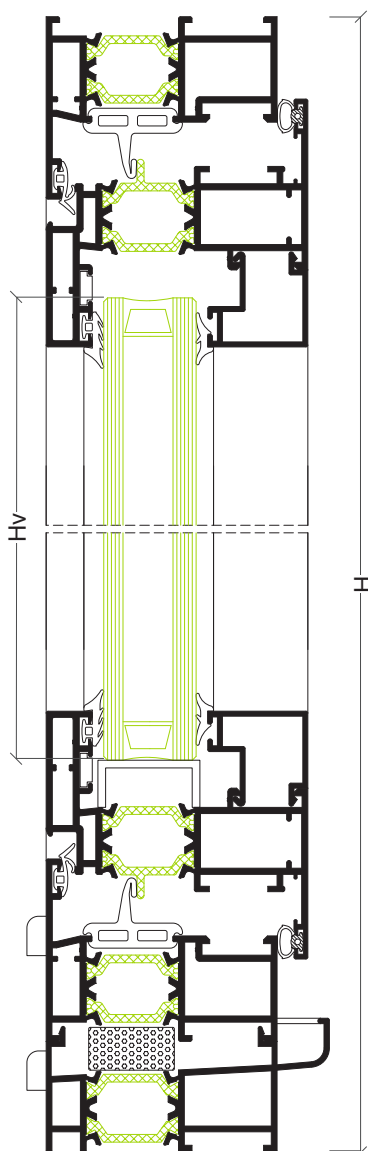
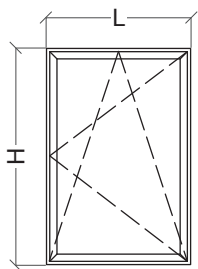

33 96 87 99
Cunho esquadro interior e exterior ARI/AKi

| Referência | Desenho | Descrição |
|-------------|---------|--|
| 30 00 95 15 | | Junta vedação interior curta |
| 30 20 30 03 | | Junta isolante |
| 30 20 70 03 | | Pelúcia remate porta 11x12 mm |
| 30 60 00 17 | | Junta exterior vidro plana 2 mm preto |
| 30 92 04 70 | | Espuma isolante |
| 30 93 00 60 | | Vedante exterior de vidro (opcional) |
| 30 93 00 61 | | Junta vedação exterior vidro 2 mm |
| 30 93 00 62 | | Junta plana para vidro |
| 30 93 00 65 | | Junta interior para vidro (5 mm) |
| 30 93 00 66 | | Junta interior para vidro (4 mm) |
| 30 93 00 67 | | Junta interior para vidro (2 mm) |
| 30 93 00 68 | | Junta interior para vidro (6/7 mm) |
| 30 93 00 69 | | Junta interior para vidro (8/9 mm) |
| 30 93 00 70 | | Vedante interior de vidro (opcional) |
| 30 93 00 80 | | Junta de vedação inferior ARI-42 |
| 30 93 00 82 | | Junta vedação inferior |
| 30 93 01 20 | | Junta interior |
| 30 93 01 30 | | Junta exterior (abertura exterior/projectante) |
| 30 95 00 10 | | Pelúcia 7x9 mm |
| 30 96 00 02 | | Junta exterior |
| 30 96 00 03 | | Junta central |
| 30 96 00 09 | | Junta central abertura exterior (ARI-25) ou tapa-canal |
| 30 96 00 18 | | Junta interior (abertura projectante/deslizante) |
| 30 96 00 27 | | Junta exterior folha oculta |

Janela 1 folha abrir e oscilo-batente



Perfis

| Desenho | Ref | Descrição | Corte | Quant | Medida |
|---|--------|---------------------|---|-------|------------|
|  | ARI-03 | Aro fixo |  | 2 | L |
| | | |  | 2 | H-28.5 mm |
|  | ARI-61 | Aro móvel |  | 2 | L-43 mm |
| | | |  | 2 | H-71.5 mm |
|  | --- | Bite |  | 2 | L-132 mm |
| | | |  | 2 | H-200.5 mm |
|  | CT-11 | Soleira condensação |  | 1 | L |
|  | AZ-23 | Pingadeira 60 mm |  | 1 | L |
|  | AX-19 | Vareta |  | 1+1 | Apro. H+L |

Acessórios e Juntas

| Referência | Descrição | Quantidade | |
|-------------|-------------------------------------|------------|----------------|
| | | Abrir | Oscilo-batente |
| 30 92 00 20 | Dobradiças C.E. | 2 | --- |
| 30 92 01 00 | Goteiras | 4 | 4 |
| 30 92 02 XX | Compasso O.B. | --- | 1 |
| 30 92 02 20 | Kit oscilo-batente | --- | 1 |
| 30 92 02 60 | Apoio da folha | 1 | --- |
| 30 92 03 10 | Kit cremone | 1 | --- |
| 30 96 00 04 | Esquadro janela | 8 | 8 |
| 30 96 00 48 | Esquadro alinhamento aro fixo | 4 | 4 |
| 30 96 00 12 | Jogo topos condensação | 1 | 1 |
| 30 96 00 15 | Esquadro alinhamento móvel | 4 | 4 |
| 30 96 00 22 | Esquadro alinhamento móvel | 4 | 4 |
| 30 96 00 45 | Esquadro alinhamento exterior móvel | 4 | 4 |
| 30 96 00 35 | Canto vulcanizado | 4 | 4 |
| 30 92 04 70 | Espuma isolante | L | |
| 30 96 00 02 | Junta exterior | 2L+2H | |
| 30 96 00 03 | Junta central | 2L+2H | |
| 30 93 01 20 | Junta interior | 2L+2H | |
| --- | Junta exterior vidro | 2L+2H | |
| --- | Junta interior vidro | 2L+2H | |

25

Vidro

| | |
|---------------|---------------|
| Hv = H-174 mm | Lv = L-146 mm |
|---------------|---------------|

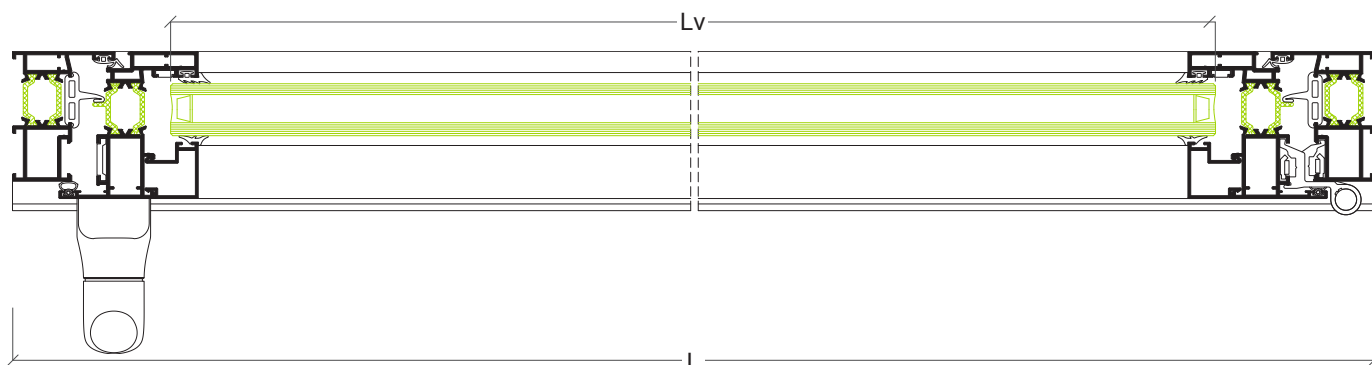

Janela 2 folhas abrir e oscilo-batente

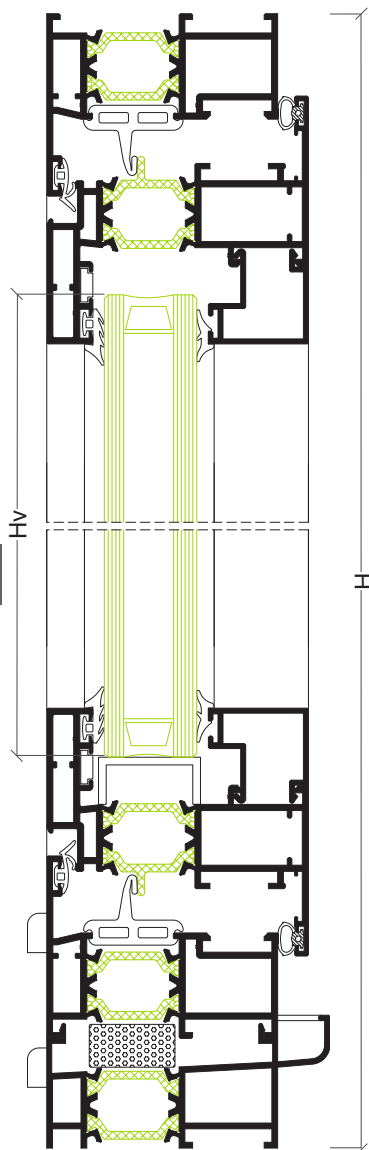
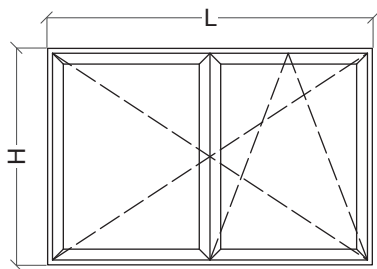

Perfis

| Desenho | Ref | Descrição | Corte | Quant | Medida |
|---------|--------|---------------------|-------|-------|------------|
| | ARi-03 | Aro fixo | | 2 | L |
| | | | | 2 | H-28.5 mm |
| | ARi-61 | Aro móvel | | 2 | L/2-24 mm |
| | | | | 2 | H-71.5 mm |
| | ARi-04 | Inversor | | 1 | H-139.5 mm |
| | --- | Bite | | 4 | L/2-113 mm |
| | | | | 4 | H-200.5 mm |
| | CT-11 | Soleira condensação | | 1 | L |
| | AX-19 | Vareta | | 1+1 | Apro. H+L |

Acessórios e Juntas

| Referência | Descrição | Quantidade | |
|-------------|-------------------------------------|------------|----------------|
| | | Abrir | Oscilo-batente |
| 30 92 00 20 | Dobradiças C.E. | 4 | --- |
| 30 92 01 00 | Goteiras | 4 | 4 |
| 30 92 01 20 | Jogo fecho C.E. | 1 | --- |
| 30 92 02 XX | Compasso O.B. | --- | 1 |
| 30 92 02 20 | Kit oscilo-batente | --- | 1 |
| 30 92 02 24 | Kit 2ª folha oscilo-batente | --- | 1 |
| 30 92 02 60 | Apoio da folha | 1 | --- |
| 30 92 03 10 | Kit cremone | 1 | --- |
| 30 96 00 04 | Esquadro janela | 12 | 12 |
| 30 96 00 48 | Esquadro alinhamento aro fixo | 8 | 8 |
| 30 96 00 08 | Jogo topos inversor | 1 | 1 |
| 30 96 00 12 | Jogo topos condensação | 1 | 1 |
| 30 96 00 15 | Esquadro alinhamento móvel | 8 | 8 |
| 30 96 00 22 | Esquadro alinhamento móvel | 8 | 8 |
| 30 96 00 45 | Esquadro alinhamento exterior móvel | 4 | 4 |
| 30 96 00 35 | Canto vulcanizado | 4 | 4 |
| 30 92 04 70 | Espuma isolante | L | |
| 30 96 00 02 | Junta exterior | 2L+4H | |
| 30 96 00 03 | Junta central | 2L+3H | |
| 30 93 01 20 | Junta interior | 2L+4H | |
| --- | Junta exterior vidro | 2L+2H | |
| --- | Junta interior vidro | 2L+2H | |

Vidro

| | |
|---------------|-----------------|
| Hv = H-174 mm | Lv = L/2-127 mm |
|---------------|-----------------|

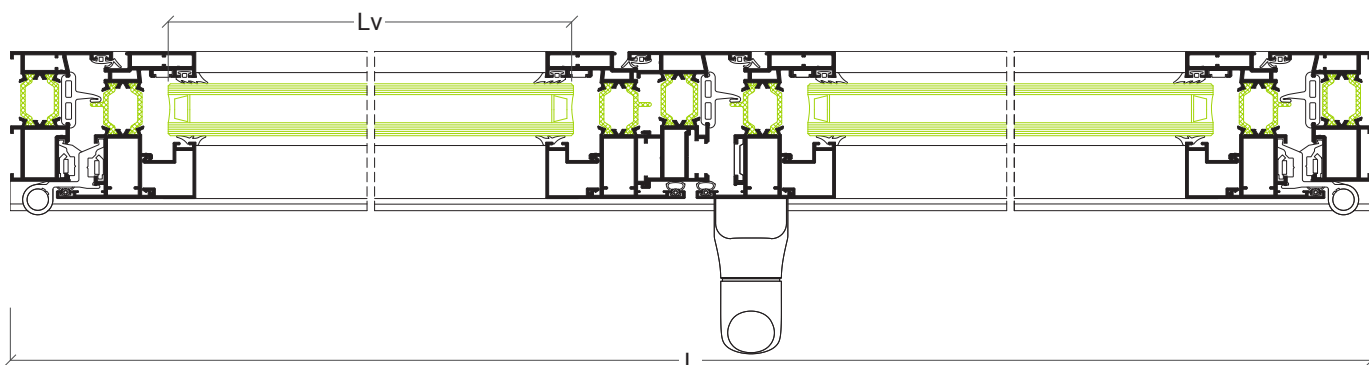

Janela projectante deslizante

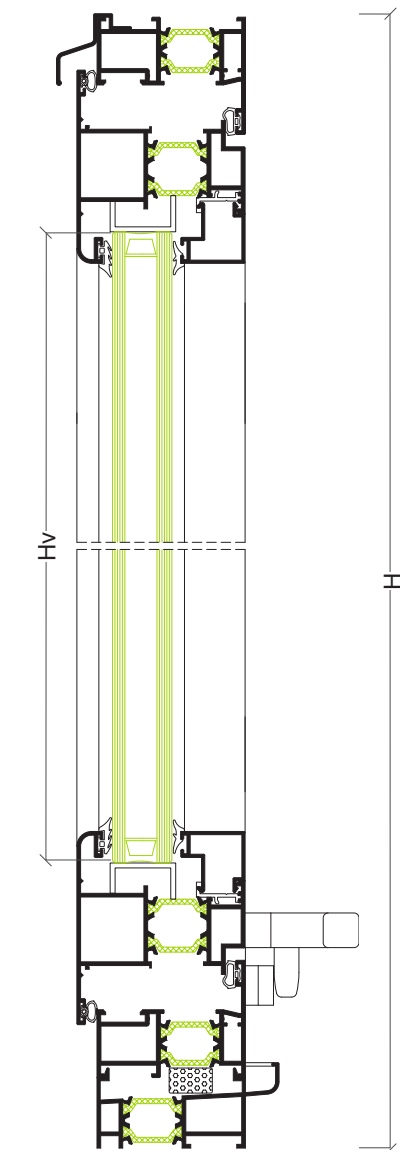
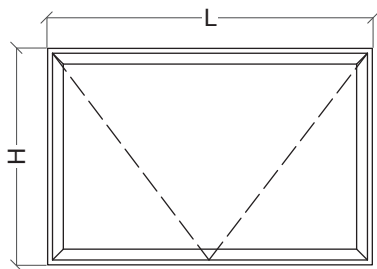

Perfis

| Desenho | Ref | Descrição | Corte | Quant | Medida |
|---------|--------|---|-------|-------|-------------------------|
| | ARi-03 | Aro fixo | | 2 | L |
| | | | | 2 | H-28.5 mm |
| | ARi-07 | Aro móvel abertura projectante deslizante | | 2 | L-43 mm |
| | | | | 2 | H-71.5 mm |
| | --- | Bite | | 4 | L-159 mm |
| | | | | 4 | H-227.5 mm |
| | AXi-45 | Pingadeira superior | | 1 | L |
| | AXi-32 | Complemento abertura projectante | | 2 | segundo medida compasso |
| | ARi-29 | Apoio bite | | 2 | L-140 mm |
| | | | | 2 | H-168.5 mm |
| | CT-11 | Soleira condensação | | 1 | L |

Acessórios e Juntas

| Referência | Descrição | Quantidade |
|-------------|--|------------|
| 30 92 01 00 | Goteiras | 2 |
| 30 92 04 10 | Esquadro janela | 4 |
| 30 92 04 90 | Jogo compasso projectante deslizante 550 | 1 |
| 30 92 06 10 | Cremona de lingueta | 2 |
| 30 92 04 10 | Esquadro janela abertura exterior | 4 |
| 30 96 00 12 | Jogo topos condensação | 1 |
| 30 96 00 48 | Esquadro alinhamento aro fixo | 4 |
| 30 96 00 42 | Esquadro alinhamento interno móvel | 4 |
| 30 92 04 70 | Espuma isolante | L |
| 30 93 01 20 | Junta exterior | 2L+2H |
| 30 96 00 18 | Junta interior projectante deslizante | 2L+2H |
| --- | Junta exterior vidro | 2L+2H |
| --- | Junta interior vidro | 2L+2H |

27

Vidro

| | |
|---------------|---------------|
| Hv = H-201 mm | Lv = L-173 mm |
|---------------|---------------|

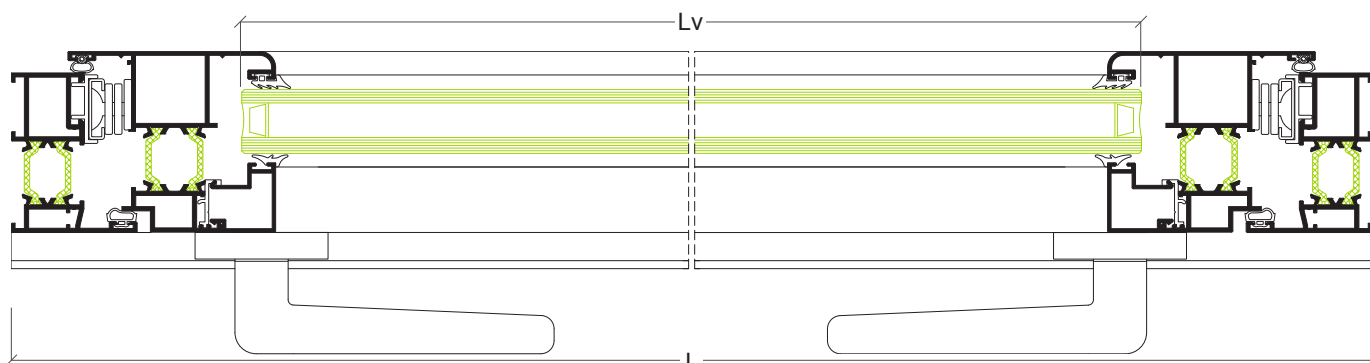

Janela pivotante horizontal

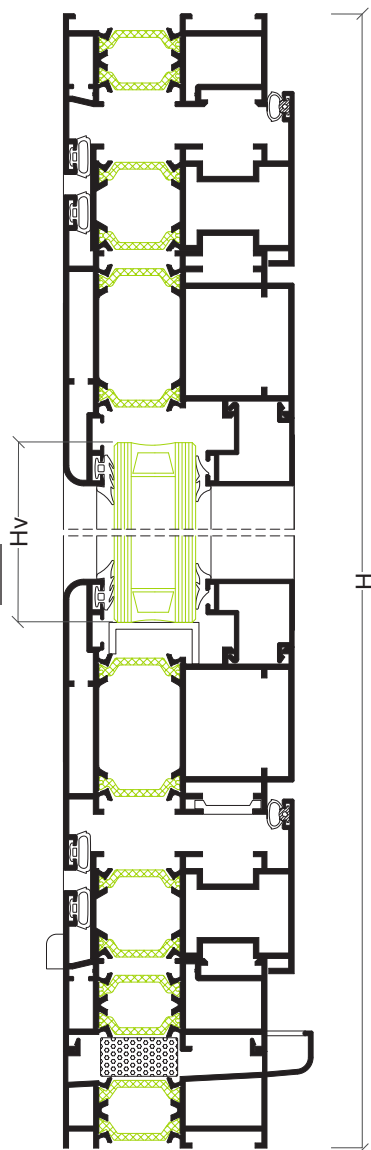
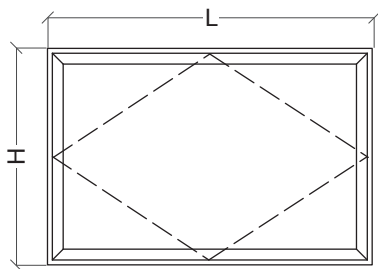

Perfis

| Desenho | Ref | Descrição | Corte | Quant | Medida |
|---------|--------|-----------------------------|-------|-------|-------------|
| | ARi-03 | Aro fixo | | 2 | L |
| | | | | 2 | H-28.5 mm |
| | ARi-25 | Aro móvel abertura exterior | | 2 | L-107 mm |
| | | | | 2 | H-135.5 mm |
| | ARi-14 | Inversor pivotante superior | | 1 | L-46 mm |
| | | | | 2 | H/2-23 mm |
| | ARi-14 | Inversor pivotante inferior | | 1 | L-46 mm |
| | | | | 2 | H/2-51.5 mm |
| | --- | Bite | | 2 | L-239 mm |
| | | | | 2 | H-307.5 mm |
| | CT-11 | Soleira condensação | | 1 | L |
| | AX-19 | Vareta | | 1+1 | L+H |
| | | | | 1+1 | L+H |

Acessórios e Juntas

| Referência | Descrição | Quantidade |
|-------------|--------------------------------------|------------|
| 30 92 01 00 | Goteiras | 4 |
| 30 94 50 10 | Esquadro inversor | 4 |
| 30 96 00 04 | Esquadro janela | 4 |
| 30 96 00 05 | Esquadro móvel | 4 |
| 30 96 00 48 | Esquadro alinhamento exterior janela | 4 |
| 30 96 00 12 | Jogo topos condensação | 1 |
| 30 92 07 13 | Jogo pivotante horizontal | 1 |
| 30 92 07 16 | Fecho perimetral pivotante | 1 |
| 30 96 00 15 | Esquadro alinhamento móvel | 4 |
| 30 96 00 49 | Esquadro alinhamento móvel | 4 |
| 30 91 41 48 | Cremones | 1 |
| 30 92 04 70 | Espuma isolante | L |
| 30 96 00 18 | Junta exterior | 4L+4H |
| 30 93 01 20 | Junta interior | 2L+2H |
| --- | Junta exterior vidro | 2L+2H |
| --- | Junta interior vidro | 2L+2H |

Vidro

| | |
|---------------|---------------|
| Hv = H-281 mm | Lv = L-253 mm |
|---------------|---------------|

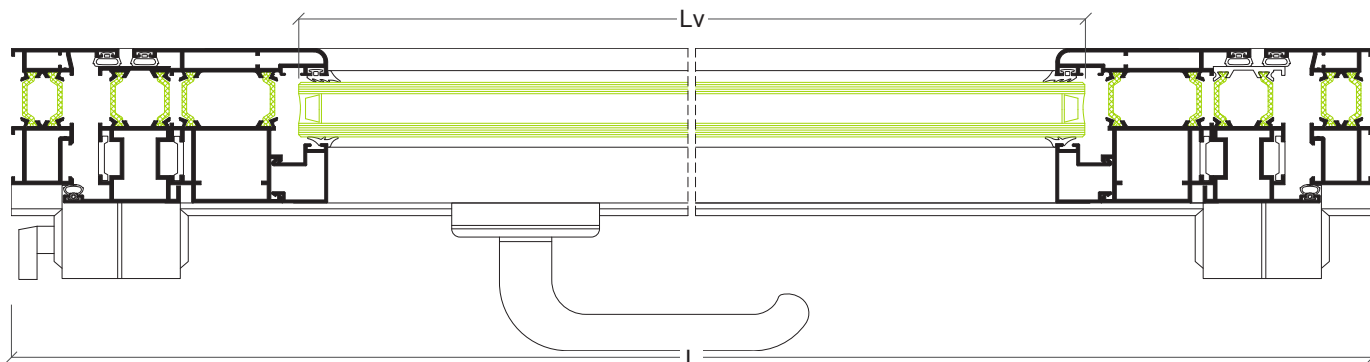

Porta 1 folha

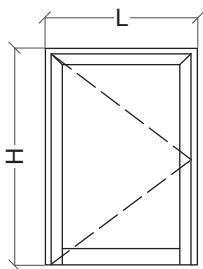

Perfis

| Desenho | Ref | Descrição | Corte | Quant | Medida |
|---------|--------|------------|-------|-------|----------|
| | ARi-08 | Aro fixo | | 1 | L |
| | | | | 2 | H |
| | ARi-36 | Aro móvel | | 2 | L-78 mm |
| | | | | 2 | H-46 mm |
| | ARi-23 | Almofada | | 1 | L-147 mm |
| | --- | Bite | | 4 | L-216 mm |
| | | | | 4 | H-226 mm |
| | AZ-60 | Pingadeira | | 1 | L-148 mm |

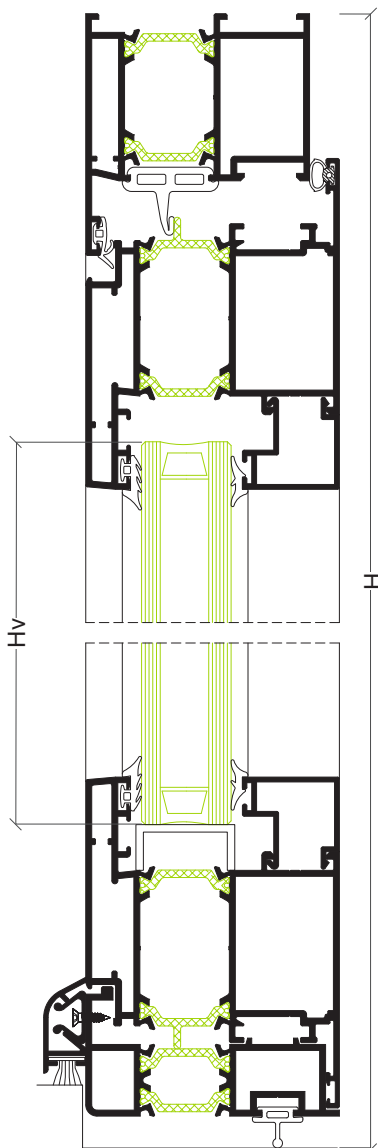

Acessórios e Juntas

| Referência | Descrição | Quantidade |
|-------------|--------------------------------------|---------------|
| 30 92 00 20 | Dobradiças C.E. | 3 |
| 30 92 01 35 | Esquadro alinhamento móvel | 4 |
| 30 92 05 10 | Fechadura 3 pontos | 1 |
| 30 92 05 50 | Canhão fechadura | 1 |
| 30 92 05 60 | Puxador duplo | 1 |
| 30 96 00 05 | Esquadro aro porta | 2 |
| 30 96 00 15 | Esquadro alinhamento móvel | 4 |
| 30 96 00 36 | Esquadro móvel porta | 4 |
| 30 96 00 46 | Esquadro alinhamento aro móvel porta | 4 |
| 30 96 00 49 | Esquadro alinhamento aro fixo | 2 |
| 30 96 00 10 | Jogo topos ARi-23 | 1 |
| 31 03 40 00 | Mola para pingadeira | A cada 200 mm |
| 30 96 00 35 | Canto vulcanizado | 2 |
| 30 92 05 00 | Jogo topos AZ-60 | 1 |
| 30 93 00 80 | Junta inferior | L |
| 30 96 00 02 | Junta exterior | L+2H |
| 30 96 00 03 | Junta central | L+2H |
| 30 93 01 20 | Junta interior | L+2H |
| --- | Junta exterior vidro | 2L+2H |
| --- | Junta interior vidro | 2L+2H |

29

Vidro

| | |
|---------------|---------------|
| Hv = H-200 mm | Lv = L-230 mm |
|---------------|---------------|

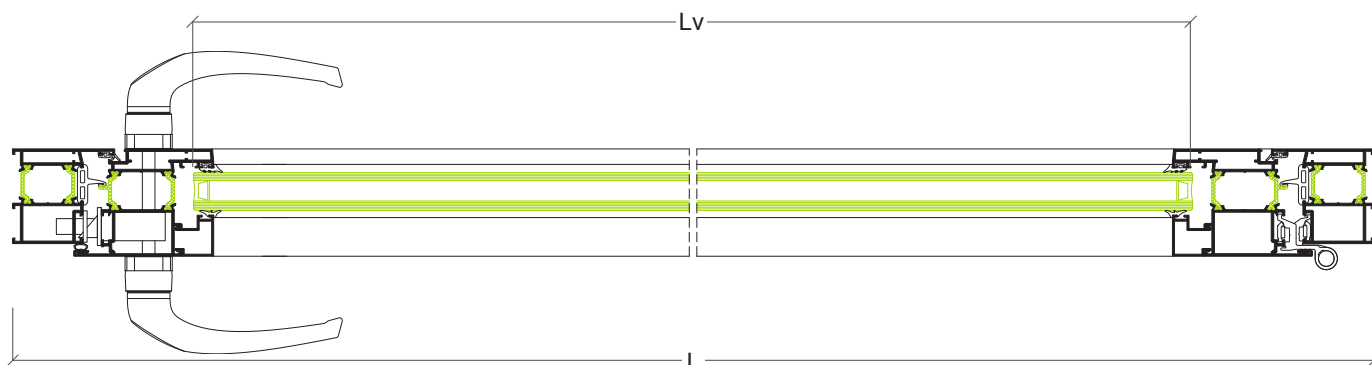

Porta 2 folhas abertura exterior

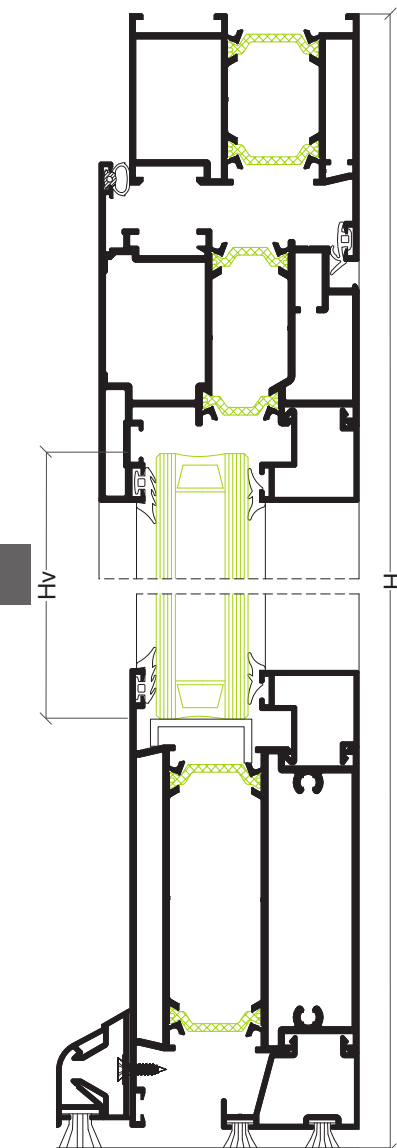
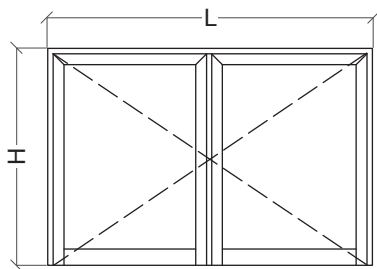

Perfis

| Desenho | Ref | Descrição | Corte | Quant | Medida |
|---------|--------|-----------------------------|-------|-------|--------------|
| | ARi-08 | Aro fixo | | 1 | L |
| | | | | 2 | H |
| | ARi-72 | Aro móvel abertura exterior | | 2 | L/2-41.5 mm |
| | | | | 4 | H-44 mm |
| | ARi-04 | Inversor | | 1 | H-78 mm |
| | ARi-12 | Travessa | | 1 | L/2-169.5 mm |
| | AX-15 | Bite remate | | 2 | L/2-160.5 mm |
| | --- | Bite | | 4 | L/2-179 mm |
| | | | | 4 | H-253 mm |
| | AZ-60 | Pingadeira | | 1 | L/2-112.5 mm |
| | | | | 1 | L/2-43 mm |
| | AZ-61 | Suplemento para pingadeira | | 2 | L/2-219.5 mm |

Acessórios e Juntas

| Referência | Descrição | Quantidade |
|-------------|-------------------------------------|------------|
| 30 92 01 20 | Jogo fecho C.E. | 1 |
| 30 92 05 10 | Fechadura 3 pontos | 1 |
| 30 92 05 50 | Canhão fechadura | 1 |
| 30 92 05 60 | Puxador duplo | 1 |
| 30 96 00 05 | Esquadro porta | 2 |
| 30 96 00 08 | Jogo topos inversor | 1 |
| 30 92 00 20 | Dobradiça C.E. | 6 |
| 30 95 00 10 | Pelúcia 7x9 mm | 2L |
| 30 95 05 00 | Jogo topos AZ-60 | 1 |
| 30 92 03 90 | Esquadro móvel exterior | 4 |
| 30 92 01 35 | Esquadro alinhamento móvel | 4 |
| 30 96 00 15 | Esquadro alinhamento móvel exterior | 4 |
| 30 96 00 45 | Esquadro móvel interior | 4 |
| 30 96 00 49 | Esquadro móvel exterior | 2 |
| 30 93 01 20 | Junta exterior | 2L |
| 30 96 00 02 | Junta interior | L+4H |
| --- | Junta exterior vidro | 2L+4H |
| --- | Junta interior vidro | 2L+4H |

Vidro

| | |
|---------------|-----------------|
| Hv = H-228 mm | Lv = L/2-194 mm |
|---------------|-----------------|

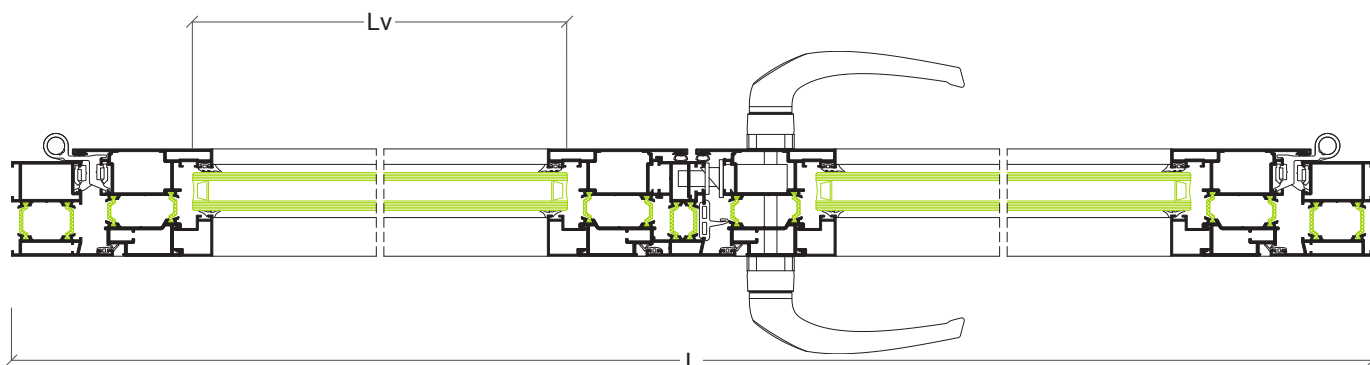

Porta oscilo-paralela com fixo lateral

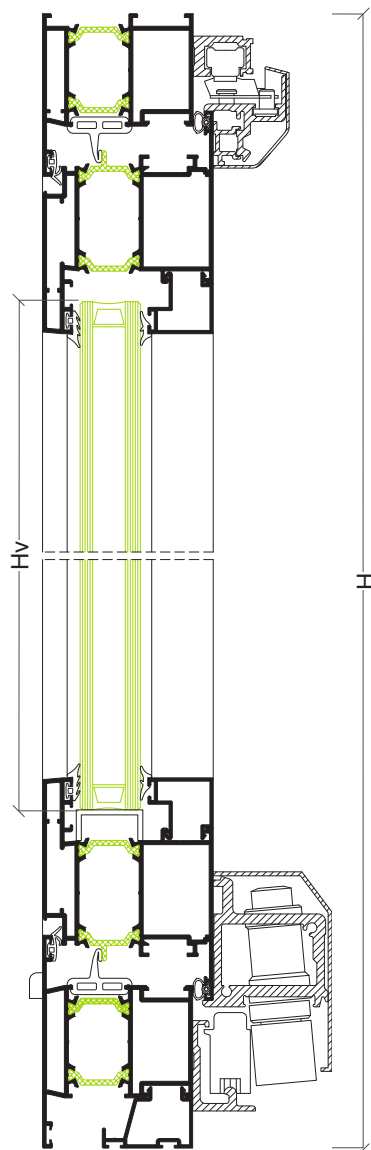
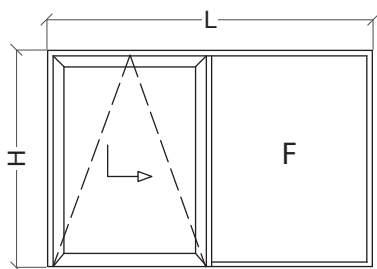

Perfis

| Desenho | Ref | Descrição | Corte | Quant | Medida |
|---|--------|--------------|---|-------|------------|
|  | ARi-08 | Aro fixo |  | 1 | L |
| | | |  | 2 | H |
|  | ARi-06 | Travessa |  | 1 | L-80.5 mm |
| | | |  | 1 | H-100.5 mm |
|  | ARi-36 | Aro móvel |  | 2 | L1-55.5 mm |
| | | |  | 4 | H-98 mm |
|  | --- | Bite (folha) |  | 2 | L1-193 mm |
| | | |  | 2 | H-275.5 mm |
|  | --- | Bite (fixo) |  | 2 | L2-67.5 mm |
| | | |  | 2 | H-150 mm |
|  | AX-15 | Bite remate |  | 1 | L-90 mm |
|  | AX-19 | Vareta |  | 1+1 | Aprox. L+H |

Acessórios e Juntas

| Referência | Descrição | Quantidade |
|-------------|---|------------|
| 30 92 01 00 | Goteiras | 4 |
| 30 92 01 35 | Esquadro alinhamento móvel | 4 |
| 30 92 01 50 | União topos porta | 4 |
| 30 96 00 05 | Esquadro aro fixo | 2 |
| 30 96 00 15 | Esquadro alinhamento móvel | 4 |
| 30 96 00 36 | Esquadro aro móvel | 4 |
| 30 96 00 46 | Esquadro alinhamento exterior aro móvel | 4 |
| 30 96 00 49 | Esquadro alinhamento aro fixo | 2 |
| --- | Kit oscilo-paralela | 1 |
| 30 96 00 35 | Canto vulcanizado | 4 |
| 30 96 00 02 | Junta exterior | 2L1+2H |
| 30 96 00 03 | Junta central | 2L1+2H |
| 30 93 01 20 | Junta interior | 2L1+2H |
| --- | Junta exterior vidro | 2L+2H |
| --- | Junta interior vidro | 2L+2H |

Vidro

| | | |
|------------------------------|----------------------|---------|
| Hv folha = H-249 mm | Lv folha = L1-206 mm | |
| Hv fixo = H-124 mm | Lv fixo = L2-81 mm | |
| | Mínimo | Máximo |
| Largura da folha | 700 mm | 1650 mm |
| Altura da folha | 850 mm | 2400 mm |
| Peso máximo por folha 150 kg | | |

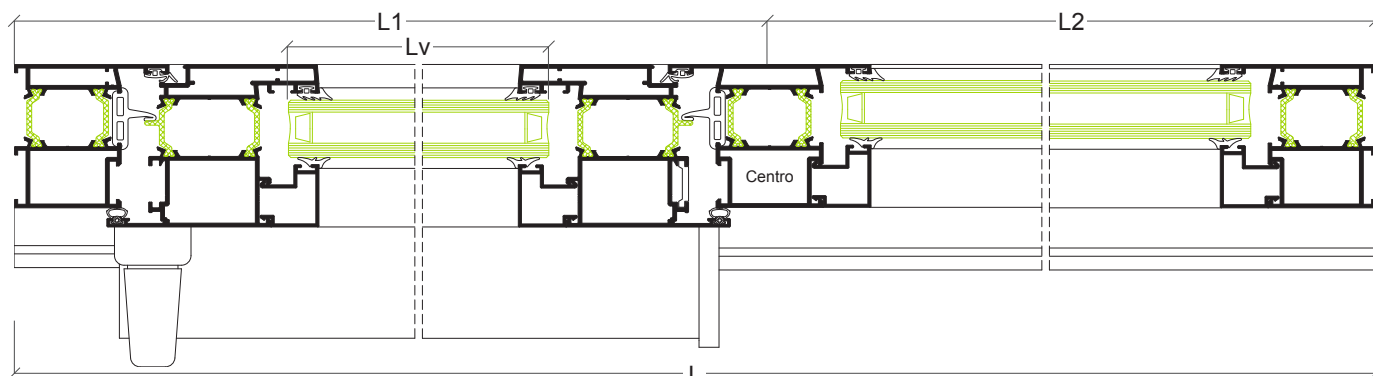

Porta 3 folhas harmónio

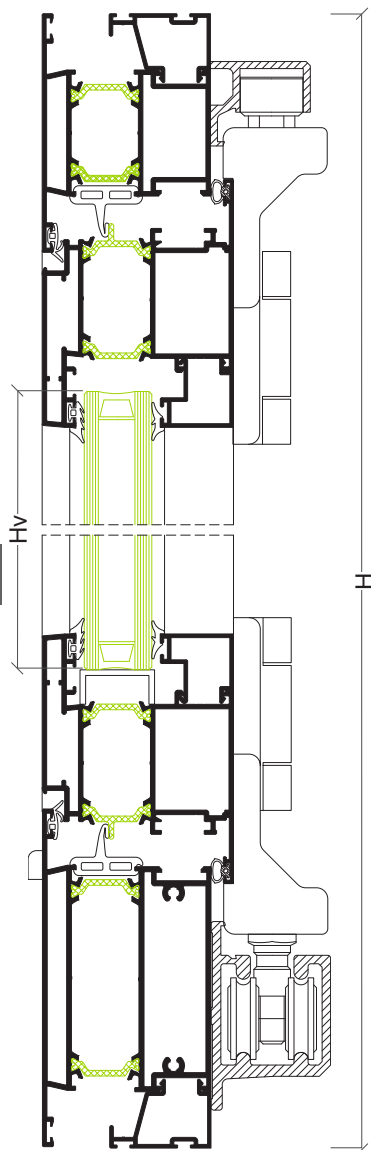
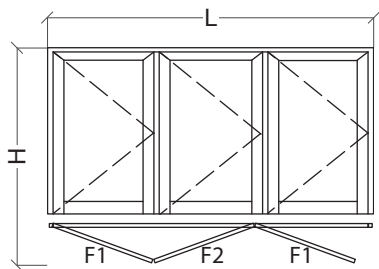

Perfis

| Desenho | Ref | Descrição | Corte | Quant | Medida |
|---------|--------|--------------|-------|-------|-----------|
| | ARi-08 | Aro fixo | | 2 | H |
| | ARi-06 | Travessa | | 1 | L-80.5 mm |
| | ARi-12 | Travessa | | 1 | L-80.5 mm |
| | ARi-36 | Aro móvel | | 6 | consultar |
| | | | | 6 | consultar |
| | ARi-04 | Inversor | | 2 | consultar |
| | --- | Bite (folha) | | 6 | consultar |
| | | | | 6 | consultar |
| | AX-15 | Bite remate | | 2 | L-90 mm |
| | AX-19 | Vareta | | 2 | 2H |

Acessórios e Juntas

| Referência | Descrição | Quantidade |
|-------------|---|------------|
| 30 92 01 00 | Goteiras | 6 |
| 30 92 01 35 | Esquadro alinhamento aro móvel | 12 |
| 30 96 00 08 | Jogo topos inversor | 2 |
| 30 96 00 15 | Esquadro alinhamento aro móvel | 12 |
| 30 96 00 36 | Esquadro aro móvel porta | 12 |
| 30 96 00 46 | Esquadro alinhamento exterior aro porta | 12 |
| --- | Kit harmónio (3+0) | 1 |
| 30 92 01 50 | União topo porta | 2 |
| 30 92 01 20 | Jogo fecho C.E. | 1 |
| 30 96 00 35 | Canto vulcanizado | 4 |
| 30 96 00 02 | Junta exterior | 2L+6H |
| 30 96 00 03 | Junta central | 2L+4H |
| 30 93 01 20 | Junta interior | 2L+6H |
| --- | Junta exterior vidro | 2L+2H |
| --- | Junta interior vidro | 2L+2H |

Vidro

| | | |
|-----------------------------|------------------------|---------|
| Hv = consultar | Lv Folha 1 = consultar | |
| | Lv Folha 2 = consultar | |
| | Mínimo | Máximo |
| Largura da folha | 600 mm | 900 mm |
| Altura da folha | 850 mm | 2400 mm |
| Peso máximo por folha 80 kg | | |

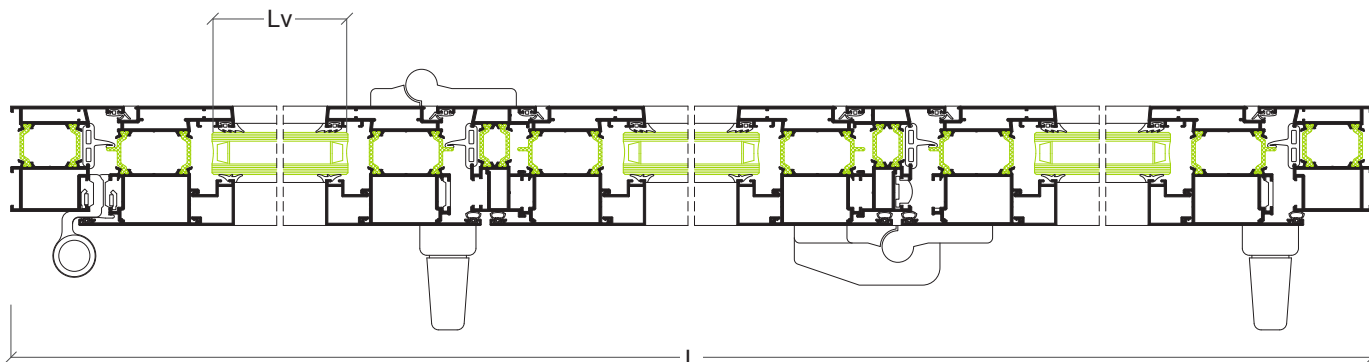

Janela 1 folha abrir e oscilo-batente

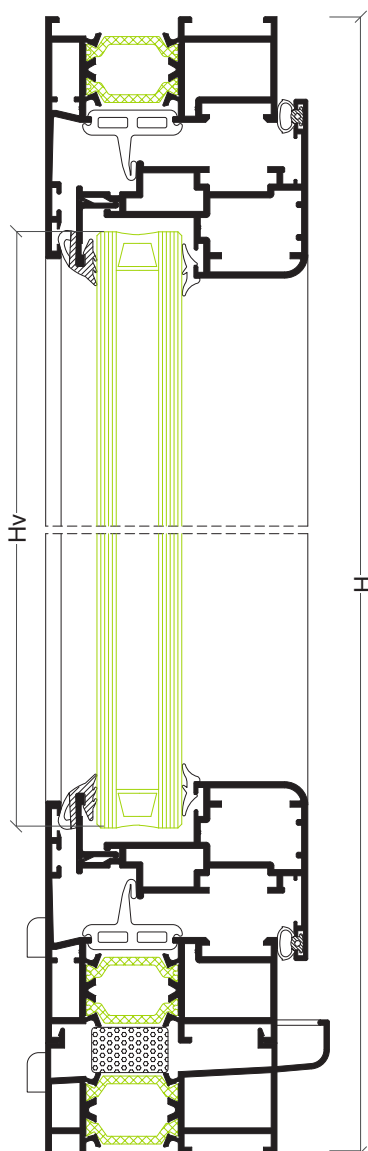
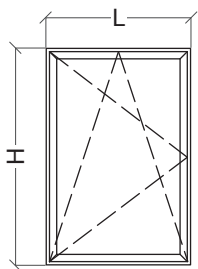

Perfis

| Desenho | Ref | Descrição | Corte | Quant | Medida |
|---------|--------|------------------------|-------|-------|------------|
| | ARi-43 | Aro fixo folha oculta | | 2 | L |
| | | | | 2 | H-28.5 mm |
| | ARi-45 | Aro móvel folha oculta | | 2 | L-43 mm |
| | | | | 2 | H-71.5 mm |
| | ARi-47 | Bite folha oculta | | 2 | L-94 mm |
| | | | | 2 | H-122.5 mm |
| | CT-11 | Soleira condensação | | 1 | L |
| | AX-19 | Vareta | | 1+1 | L+H |

Acessórios e Juntas

| Referência | Descrição | Quantidade | |
|-------------|-------------------------------------|------------|----------------|
| | | Abrir | Oscilo-batente |
| 30 92 00 20 | Dobradiças C.E. | 2 | --- |
| 30 92 01 00 | Goteiras | 4 | 4 |
| 30 92 02 XX | Compasso O.B. | --- | 1 |
| 30 92 02 20 | Kit oscilo-batente | --- | 1 |
| 30 92 02 60 | Apoio da folha | 1 | --- |
| 30 92 03 10 | Kit cremone | 1 | --- |
| 30 96 00 04 | Esquadro janela | 8 | 8 |
| 30 96 00 48 | Esquadro alinhamento aro fixo | 4 | 4 |
| 30 96 00 12 | Jogo topos condensação | 1 | 1 |
| 30 96 00 23 | Esquadro alinhamento aro fixo | 4 | 4 |
| 30 96 00 24 | Esquadro alinhamento aro móvel | 4 | 4 |
| 30 96 00 22 | Esquadro alinhamento interior móvel | 4 | 4 |
| 30 96 00 35 | Canto vulcanizado | 4 | 4 |
| 30 92 04 70 | Espuma isolante | L | |
| 30 96 00 27 | Junta exterior folha oculta | 2L+2H | |
| 30 96 00 03 | Junta central | 2L+2H | |
| 30 93 01 20 | Junta interior | 2L+2H | |
| --- | Junta interior vidro | 2L+2H | |

33

Vidro

| | |
|---------------|---------------|
| Hv = H-139 mm | Lv = L-110 mm |
|---------------|---------------|

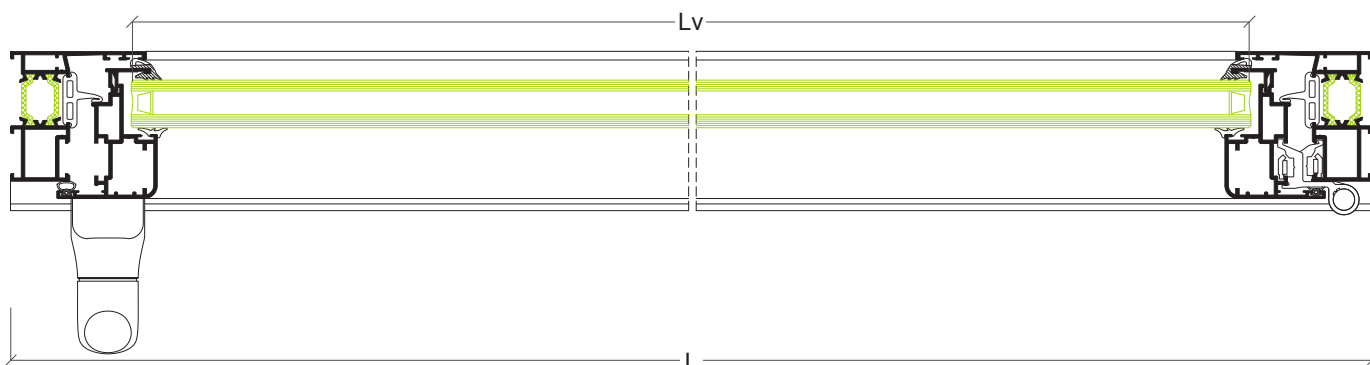

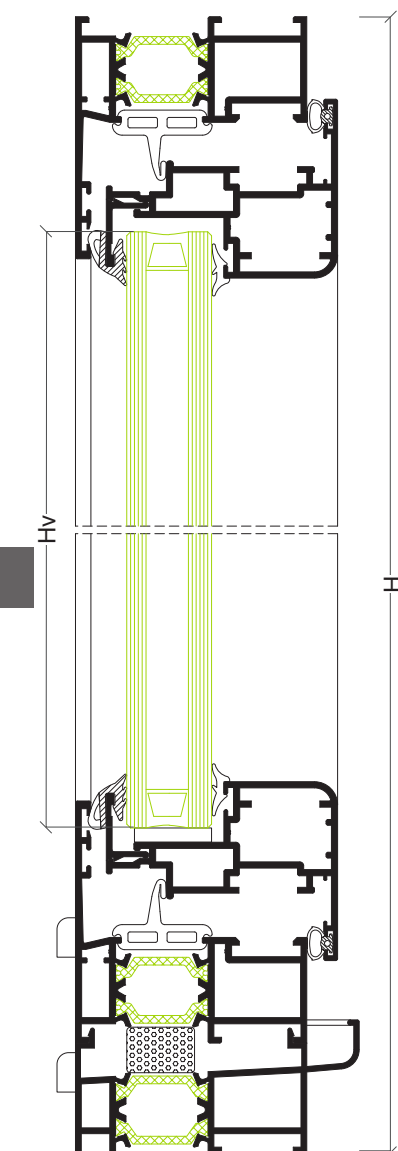
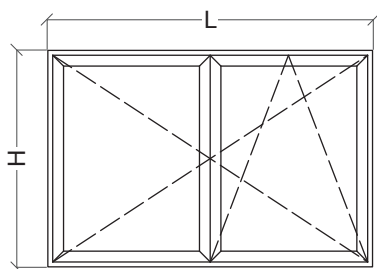
Janela 2 folhas abrir e oscilo-batente

Perfis

| Desenho | Ref | Descrição | Corte | Quant | Medida |
|---------|--------|--------------------------------|-------|-------|-------------|
| | ARi-43 | Aro fixo folha oculta | | 2 | L |
| | | | | 2 | H-28.5 mm |
| | ARi-45 | Aro móvel folha oculta | | 4 | L/2-12 mm |
| | | | | 3 | H-71.5 mm |
| | ARi-46 | Complemento aro móvel inversor | | 1 | H-159.5 mm |
| | ARi-44 | Aro móvel | | 1 | H-95.5 mm |
| | ARi-47 | Bite folha oculta | | 4 | L/2-63.5 mm |
| | | | | 3 | H-122.5 mm |
| | CT-11 | Soleira condensação | | 1 | L |
| | AX-19 | Vareta | | 1+1 | L+H |

Acessórios e Juntas

| Referência | Descrição | Quantidade | |
|-------------|-------------------------------------|------------|----------------|
| | | Abrir | Oscilo-batente |
| 30 92 00 20 | Dobradiças C.E. | 4 | --- |
| 30 92 01 00 | Goteiras | 4 | 4 |
| 30 92 01 20 | Jogo fecho C.E. | 1 | --- |
| 30 92 02 XX | Compasso O.B. | --- | 1 |
| 30 92 02 20 | Kit oscilo-batente | --- | 1 |
| 30 92 02 24 | Kit 2ª folha oscilo-batente | --- | 1 |
| 30 92 02 60 | Apoio da folha | 1 | --- |
| 30 92 03 10 | Kit cremone | 1 | --- |
| 30 96 00 04 | Esquadro janela | 12 | 12 |
| 30 96 00 48 | Esquadro alinhamento aro fixo | 4 | 4 |
| 30 96 00 12 | Jogo topos condensação | 1 | 1 |
| 30 96 00 23 | Esquadro alinhamento aro fixo | 4 | 4 |
| 30 96 00 24 | Esquadro alinhamento aro móvel | 8 | 8 |
| 30 96 00 22 | Esquadro alinhamento interior móvel | 4 | 4 |
| 30 96 00 26 | Jogo topos inversor | 1 | 1 |
| 30 96 00 35 | Canto vulcanizado | 4 | 4 |
| 30 92 04 70 | Espuma isolante | L | |
| 30 96 00 27 | Junta exterior folha oculta | 2L+4H | |
| 30 96 00 03 | Junta central | 2L+3H | |
| 30 93 01 20 | Junta interior | 2L+3H | |
| --- | Junta interior vidro | 2L+4H | |

Vidro

| | |
|---------------|----------------|
| Hv = H-139 mm | Lv = L/2-79 mm |
|---------------|----------------|

