

[www.anicolor.pt](http://www.anicolor.pt)

## SISTEMA DE BATENTE DE CANAL EUROPEU COM RPT - 85 mm

SISTEMA PRACTICABLE DE  
CANAL EUROPEO CON RPT - 85 mm

# APi

 **anicolor**  
Sistemas de Alumínio

## SISTEMA API

### Sistema de batente de canal europeu com RPT - 85 mm

#### CARACTERÍSTICAS DO SISTEMA

Sistema de batente com rotura térmica e de elevado rendimento térmico e acústico. O sistema API possibilita a execução de 3 versões de caixilharia:

1. linha recta;
2. linha curva;
3. linha oval.

O sistema API permite a aplicação de vidros duplos ou triplos de alto rendimento por forma a responder aos requisitos de isolamento térmico e acústico.

Com um ótimo isolamento térmico aliado à aplicação de um inovador produto designado por ThermoProfile, o Sistema API proporciona elevadas prestações de conforto e de economia energética.

#### PERFIS DE ALUMÍNIO

Perfis com rotura térmica obtida por inserção de varetas isolantes de poliamida tipo ómega de 39 mm reforçadas com 25% de fibra de vidro. Espessura média dos perfis de alumínio de 1.7 mm.

#### AROS FIXOS

Profundidade dos aros fixos de 85 mm com tripla câmara;  
 Perfis com rotura térmica obtida através de varetas de poliamida tipo ómega de 39 mm;  
 Aros fixos com duplo esquadro de aperto rápido e esquadros de alinhamento para montagem a meia esquadria;  
 Travessas com dupla união para um aperto mais eficaz;  
 Aros fixos tradicionais para o mercado interno;  
 Aros fixos com clip exterior e aba de remate direta de 25 mm ou 45 mm ;  
 Aros fixos com clip exterior e interior para aplicação de remate de 30, 50, 65 ou 80 mm.

#### AROS MÓVEIS

Profundidade dos aros móveis de 93 mm com tripla câmara;  
 Aros móveis com rotura térmica obtida através de varetas de poliamida tipo ómega de 39mm;  
 Folhas com duplo esquadro de aperto rápido e esquadros de alinhamento para montagem a meia esquadria;  
 Perfil inversor com olhais para uma melhor aplicação do topo inversor.

#### DIMENSIONAMENTO E MANIOBRABILIDADE

Dimensões mínimas - máximas de folha: 457 mm - 1700 mm (L); 457mm - 3000 mm (H);  
 Peso máximo para janelas ou portas com oscilobatente até 170 Kg;  
 Peso máximo para portas de entrada até 160 Kg/folha;  
 Possibilidades de abertura: fixo, abertura interior 1 ou 2 folhas com ou sem oscilobatente, abertura exterior, basculante, projectante, harmónio e oscilo-paralela;  
 Solução de perfil para portas de entrada de abertura interior ou exterior de acordo com a norma PMR (pessoas com mobilidade reduzida);  
 Enchimento para vidro duplo ou triplo desde 24mm até 70mm;  
 Estanteidade assegurada através de juntas em EPDM (interior e central).  
 Permite abertura com microventilação.

#### PERFORMANCES

Sistema certificado por laboratório credenciado, notificado para Ensaio Tipo Inicial (ITT) de acordo com a norma de produto EN 14351-1 para efeitos de Marcação CE.

Categorias alcançadas nos ensaios do sistema API:

1. Permeabilidade ao ar: Classe 4 (norma de ensaio EN 10207 e EN 1026)
2. Estanteidade à água: Classe E1500 (norma de ensaio EN 12208 e EN 1027)
3. Resistência ao vento: Classe C5 (norma de ensaio EN 12208 e EN 12211)

Categorias alcançadas nos ensaios do sistema API para portas 2 folhas:

1. Permeabilidade ao ar: Classe 4 (norma de ensaio EN 10207 e EN 1026)
2. Estanteidade à água: Classe 9A (norma de ensaio EN 12208 e EN 1027)
3. Resistência ao vento: Classe C4 (norma de ensaio EN 12208 e EN 12211)

Categorias alcançadas nos ensaios do sistema API para porta de entrada:

1. Permeabilidade ao ar: Classe 4 (norma de ensaio EN 10207 e EN 1026)
2. Estanteidade à água: Classe E1050 (norma de ensaio EN 12208 e EN 1027)
3. Resistência ao vento: Classe C4 (norma de ensaio EN 12208 e EN 12211)

Coefficiente de Transmissão térmica de vão de 2 folhas com 1.20 m x 1.50 m com vidro Ug = 0.5 W/m<sup>2</sup>K, com intercalar efeito "Warm Edge": Uw = 1.09 W/m<sup>2</sup>K

Coefficiente de atenuação acústica de vão de 2 folhas: Rw (C; Ctr) = 41 dB (-2; -5)

Zonas de aplicação RCCTE (em função do valor Ug): I1, I2, I3, V1, V2, V3.

## SISTEMA API

### Sistema practicable de canal europeu con RPT - 85 mm

#### CARACTERÍSTICAS DEL SISTEMA

Sistema practicable con rotura térmica y de elevado rendimiento térmico y acústico. El sistema API possibilita la ejecución de 3 versiones de carpintería:

1. línea recta;
2. línea curva;
3. línea oval.

El sistema API permite la aplicación de vidrios dobles u triplos de alto rendimiento por forma a responder a los requisitos de aislamiento térmico y acústico.

Con un ótimo aislamiento térmico aliado a la aplicación de un innovador producto llamado ThermoProfile, el Sistema API proporciona elevadas prestaciones de confort y de economía energética.

#### PERFILES DE ALUMINIO

Perfiles con rotura térmica obtenida por inserción de varillas aislantes de poliamida tipo ómega de 39mm reforzadas con 25% de fibra de vidrio. Espesor medio de los perfiles de aluminio de 1.7 mm.

#### MARCOS

Profundidad de los marcos de 85 mm con triple cámara;  
 Perfiles con rotura térmica con varillas de poliamida tipo ómega de 39 mm;  
 Marcos con doble escuadra de rápido apriete y escuadras de alineamiento para montaje a englete;  
 Travesaños con doble unión para un apriete más eficaz;  
 Marcos rústicos;  
 Marcos con enganche exterior y solape de 25 mm u 45 mm;  
 Marcos con enganche exterior e interior para aplicación de solape de 30, 50, 65 ó 80 mm.

#### HOJAS

Profundidad de las hojas de 93 mm con triple cámara;  
 Hojas con rotura térmica con varillas de poliamida tipo omega de 39mm;  
 Hojas con doble escuadra de rapido apriete y escuadras de alineamiento para montaje a englete;  
 Perfil inversor con agujero para una mejor aplicación del tope inversor.

#### DIMENSIONAMIENTO Y MANIOBRABILIDAD

Dimensiones mínimas - máximas de hoja: 457 mm - 1700 mm (L); 457 mm - 3000 mm (H);  
 Peso máximo para ventanas u puertas de paso con oscilobatiente hasta 170 Kg;  
 Peso máximo para puertas de entrada hasta 160 Kg/hoja;  
 Posibilidades de apertura: fijo, practicable interior 1 u 2 hojas con ó sin oscilobatiente, practicable exterior, abatible, proyectante, plegable y oscilo-paralela;  
 Solución de perfil para puertas peatonales u de paso de apertura interior u exterior según norma PMR (personas con movilidad reducida);  
 Acristalamiento para vidrio doble u triple desde 24 mm hasta 70 mm;  
 Estanteidad asegurada mientras doble juntas en EPDM (interior y central), con junta central termo aislante de bimaterial.  
 Permite apertura con micro-ventilación.

#### ENSAYOS

Sistema certificado por laboratório credenciado, notificado para Ensayos Tipo Inicial (ITT) de acuerdo con la norma de producto EN 14351-1 para efectos de Marcado CE.

Categorias alcanzadas en los ensayos del sistema API:

1. Permeabilidad al aire: Clase 4 (norma de ensayo EN 10207 y EN 1026)
2. Estanteidad al agua: Clase E1500 (norma de ensayo EN 12208 y EN 1027)
3. Resistencia al viento: Clase C5 (norma de ensayo EN 12208 y EN 12211)

Categorias alcanzadas en los ensayos del sistema API para puertas 2 hojas:

1. Permeabilidad al aire: Clase 4 (norma de ensayo EN 10207 y EN 1026)
2. Estanteidad al agua: Clase A9 (norma de ensayo EN 12208 y EN 1027)
3. Resistencia al viento: Clase C4 (norma de ensayo EN 12208 y EN 12211)

Categorias alcanzadas en los ensayos del sistema API para puerta de entrada:

1. Permeabilidad al aire: Clase 4 (norma de ensayo EN 10207 y EN 1026)
2. Estanteidad al agua: Clase E1050 (norma de ensayo EN 12208 y EN 1027)
3. Resistencia al viento: Clase C4 (norma de ensayo EN 12208 y EN 12211)

Coefficiente de transmisión térmica de hueco de 2 hojas con 1.20 m x 1.50 m con vidrio Ug = 0.5 W/m<sup>2</sup>K, con intercalar efecto "Warm Edge": Uw = 1.09 W/m<sup>2</sup>K

Coefficiente de atenuación acústica de hueco de 2 hojas: Rw (C; Ctr) = 41 dB (-2; -5)

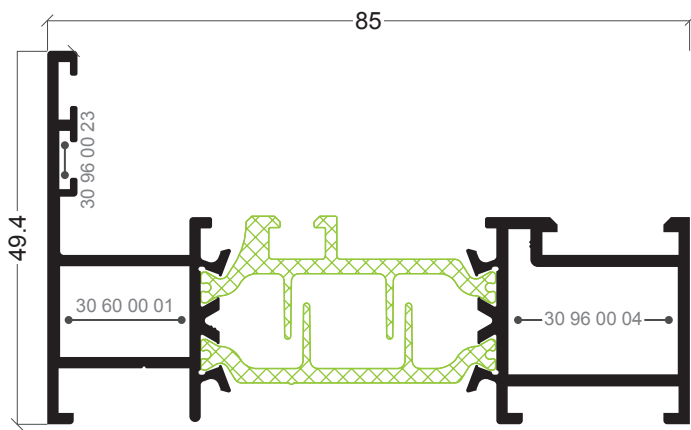

**APi-03**

Aro fixo  
Marco ventana

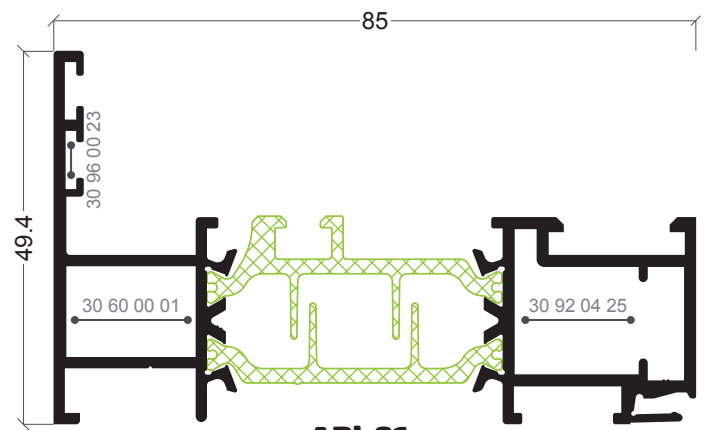

**APi-91**

Aro fixo  
Marco ventana c/ enganche int.

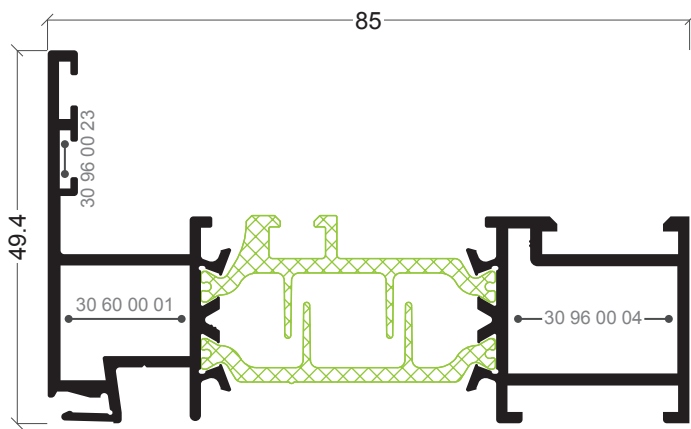

**APi-76**

Aro fixo com clip exterior  
Marco ventana c/ enganche ext.

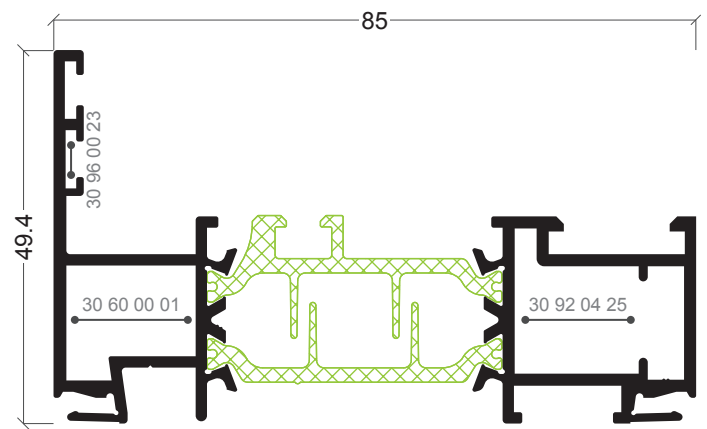

**APi-80**

Aro fixo com duplo clip  
Marco ventana c/ enganche int/ext.

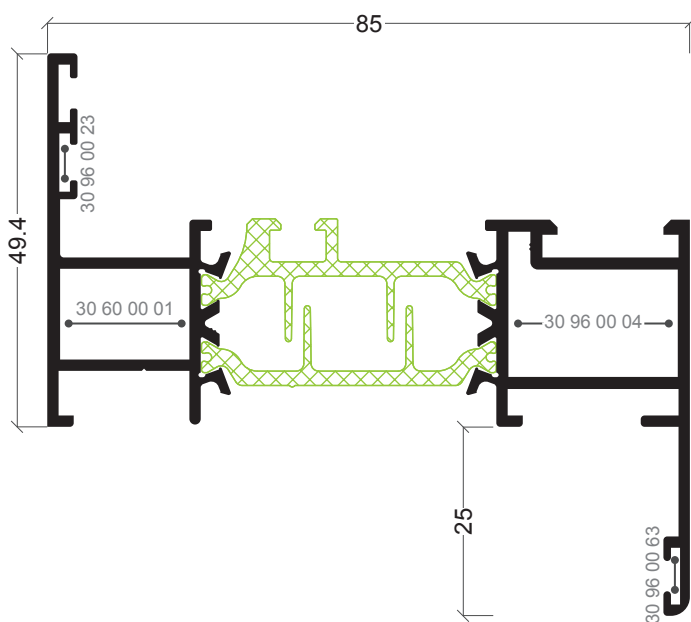

**APi-35**

Aro fixo com remate 25mm  
Marco ventana con solape 25 mm

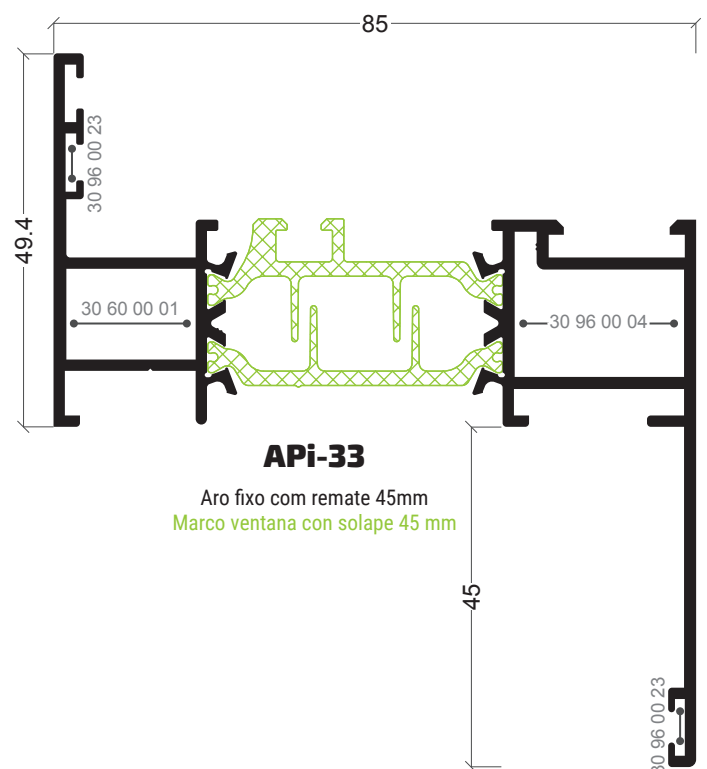

**APi-33**

Aro fixo com remate 45mm  
Marco ventana con solape 45 mm

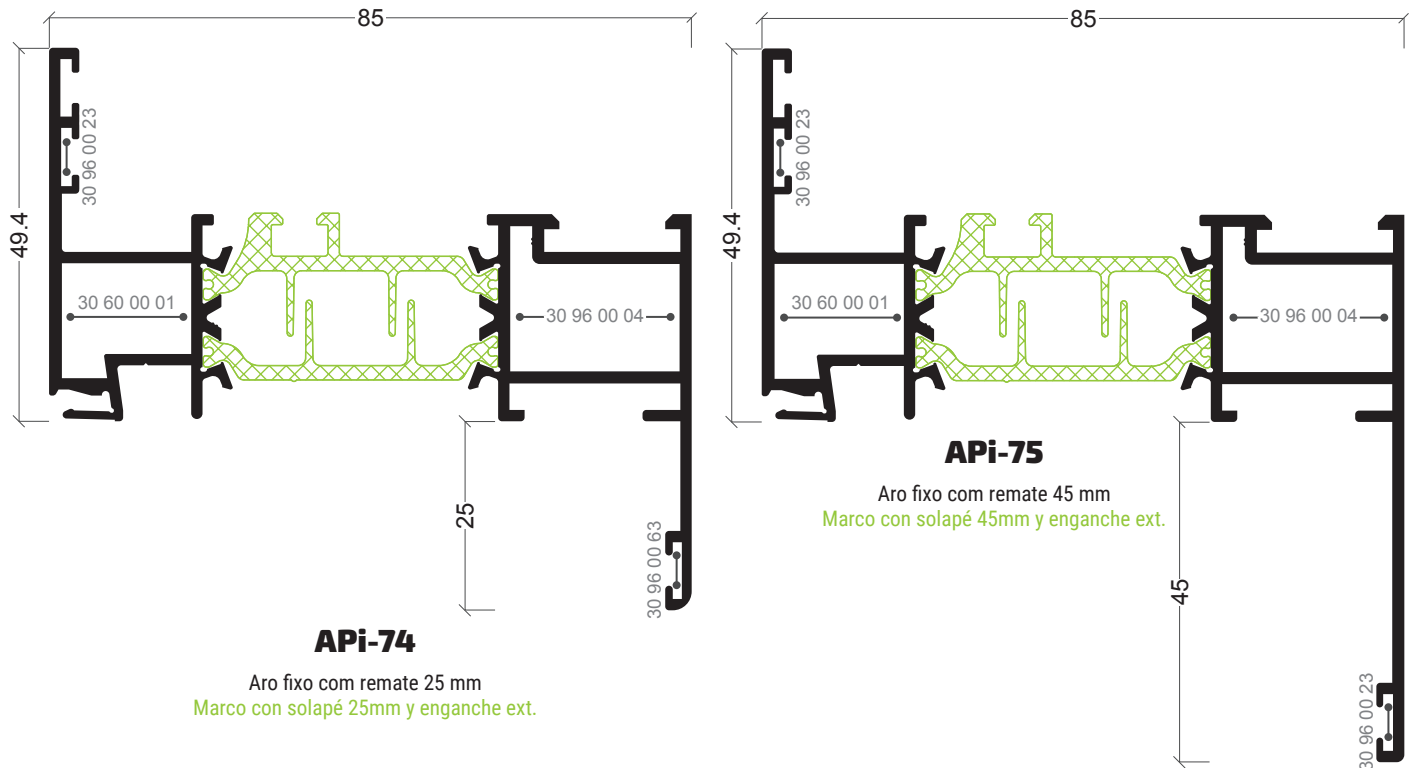

214

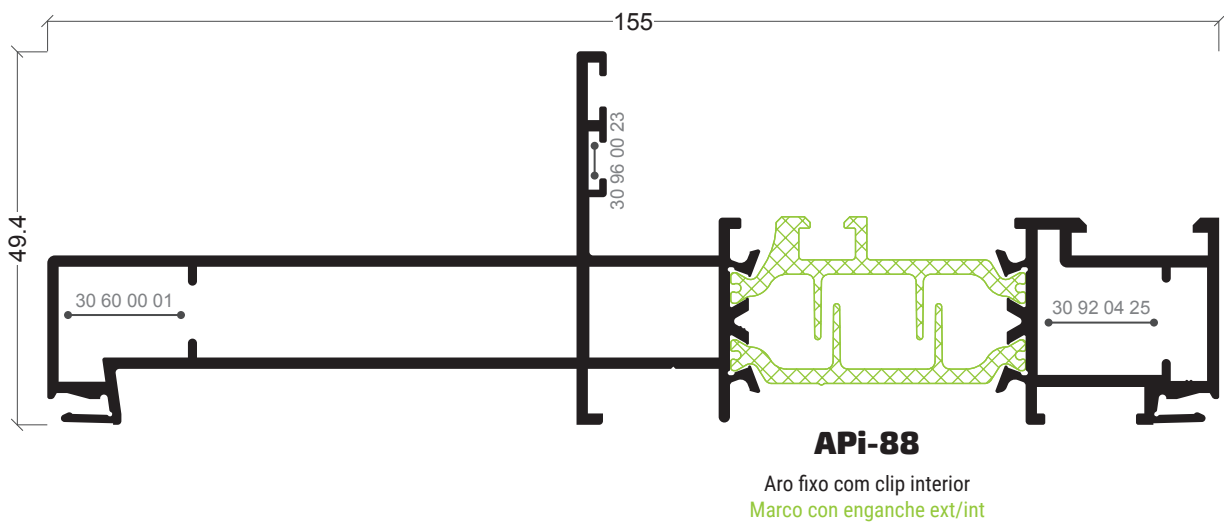
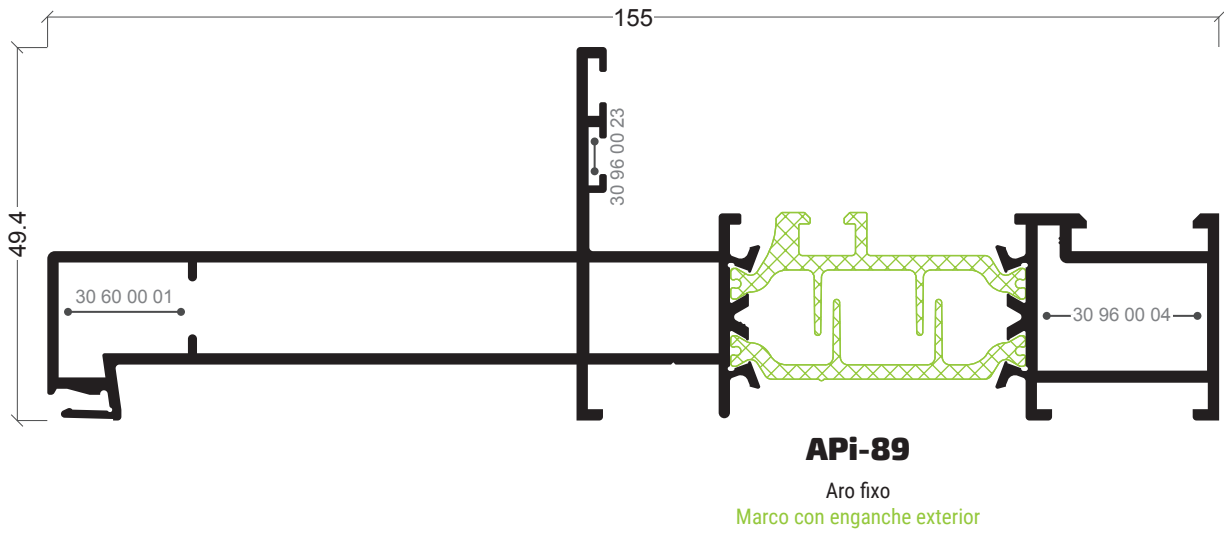



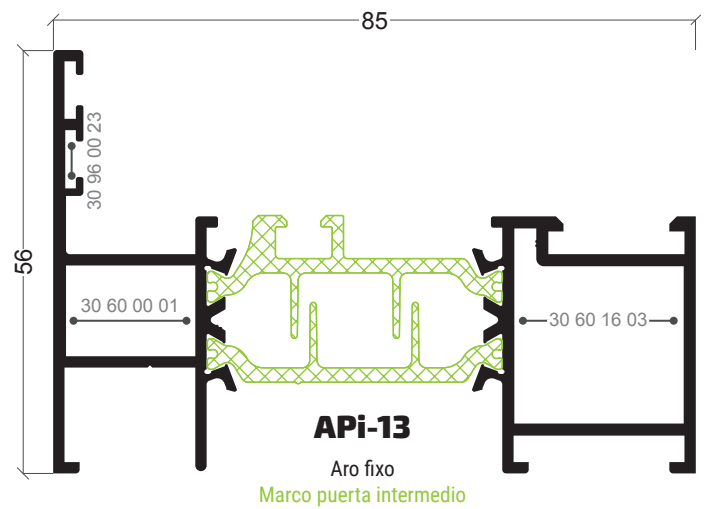
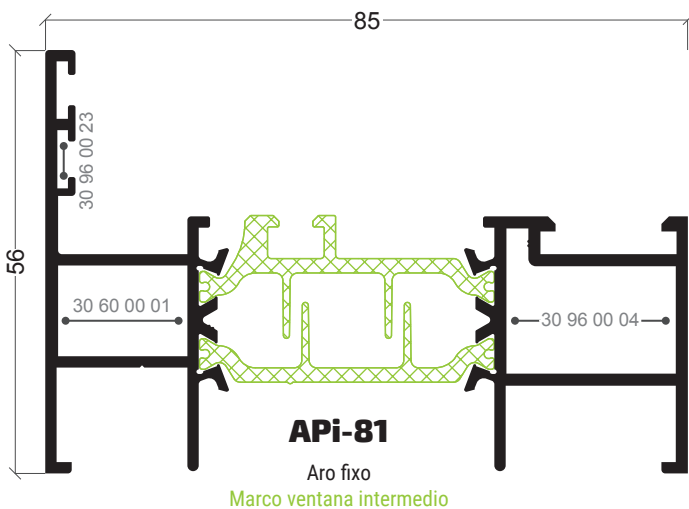
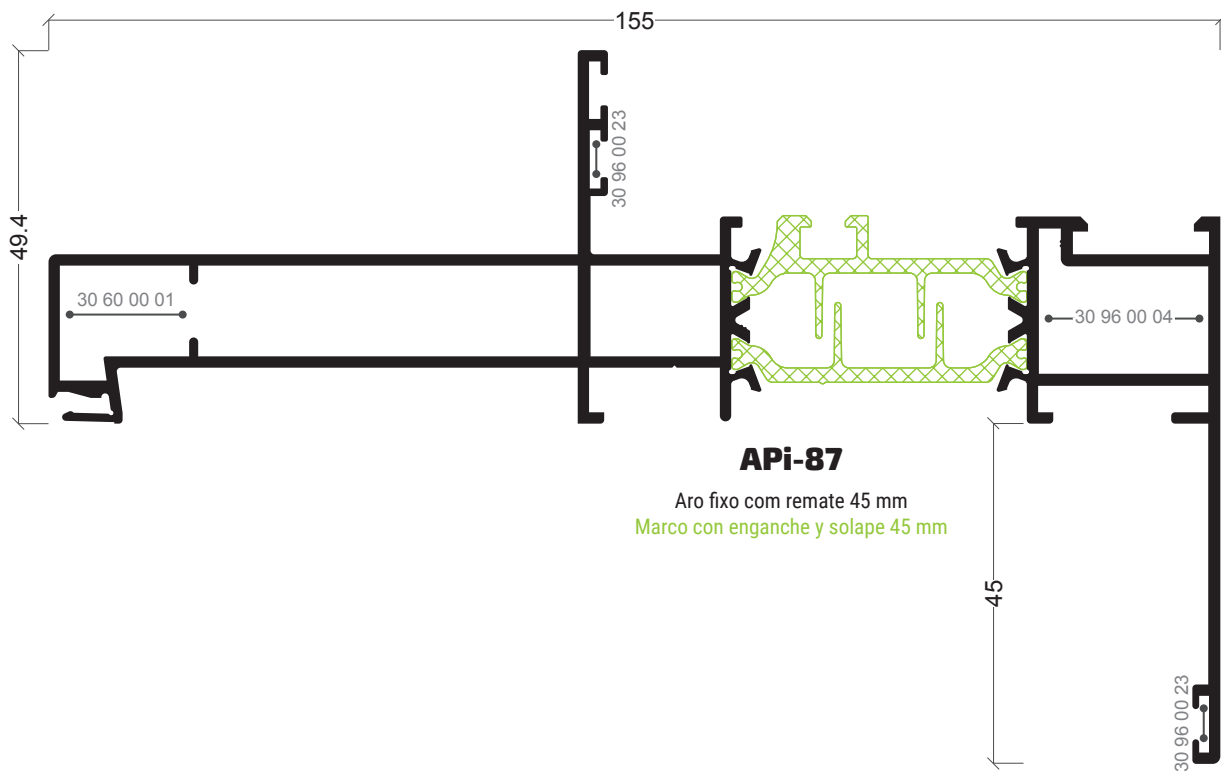
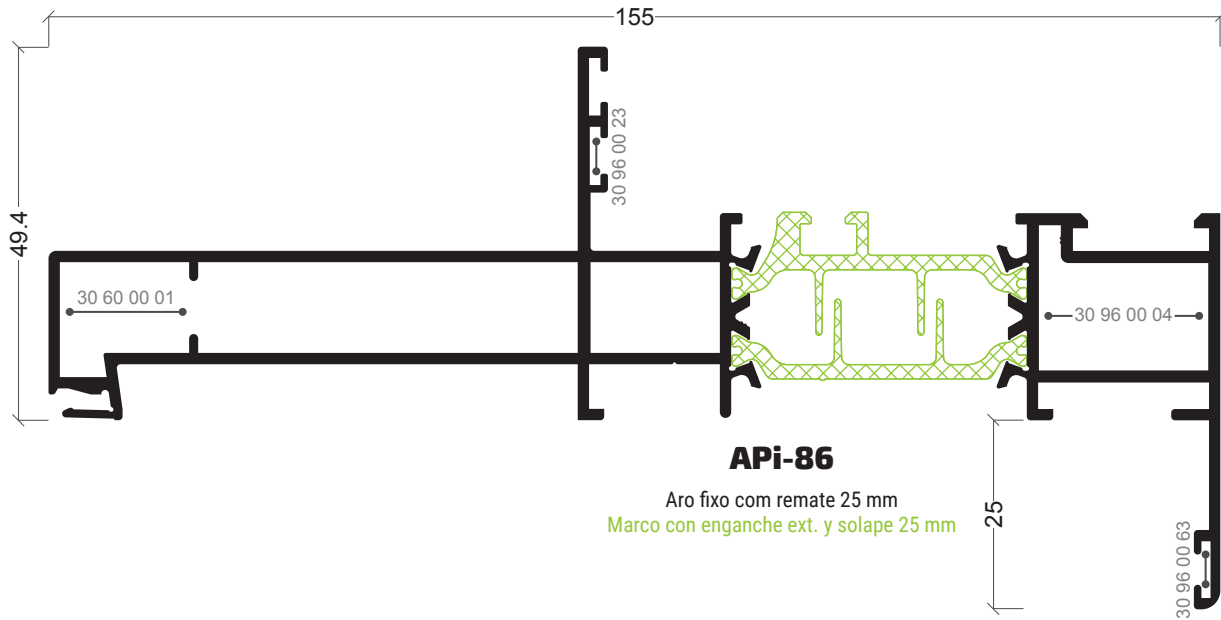

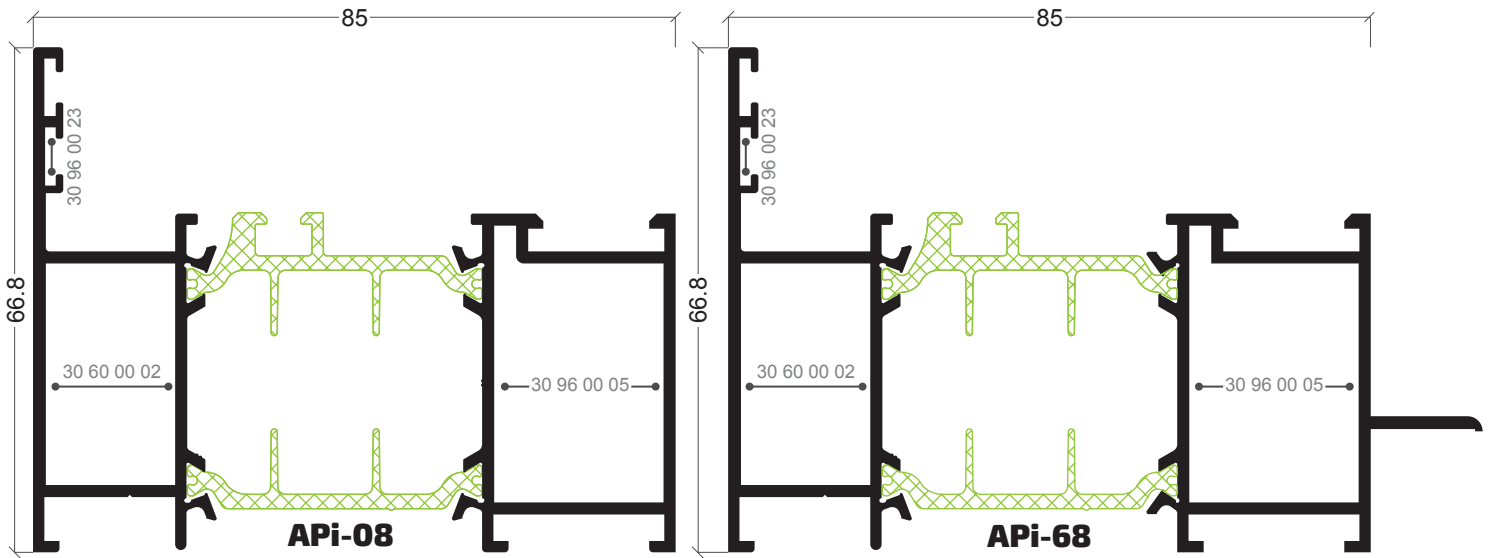

**API-08**

Aro fixo  
Marco puerta

**API-68**

Aro fixo  
Marco puerta con precerco

216

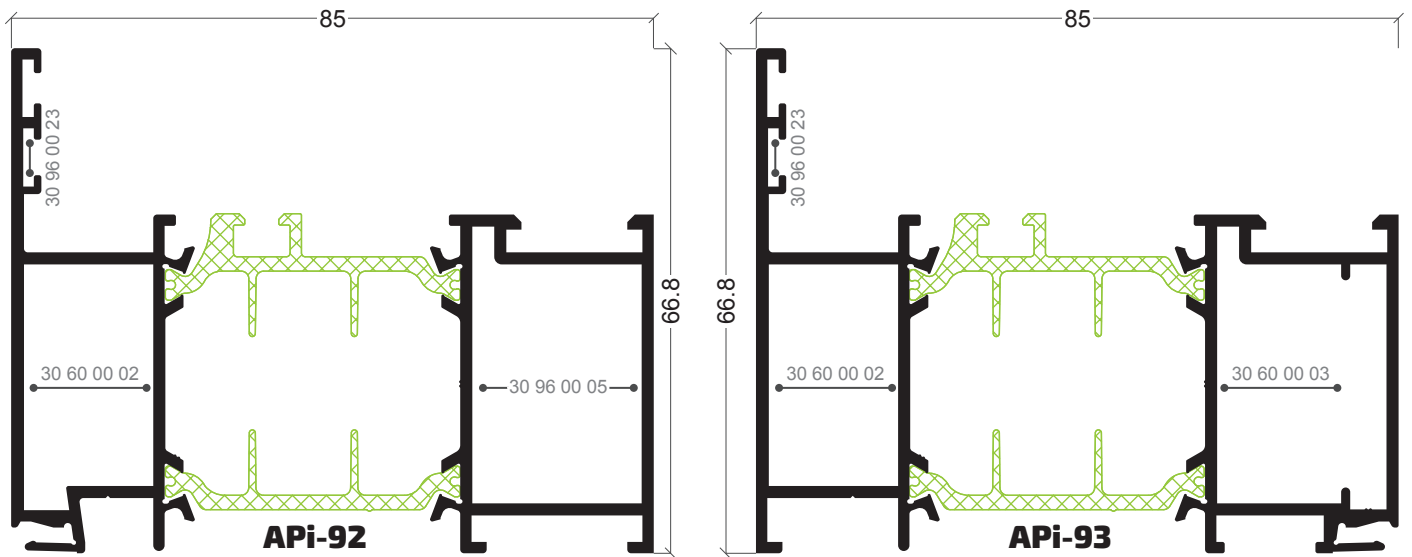

**API-92**

Aro fixo com clip exterior  
Marco puerta con enganche ext.

**API-93**

Aro fixo com clip interior  
Marco puerta con enganche int.

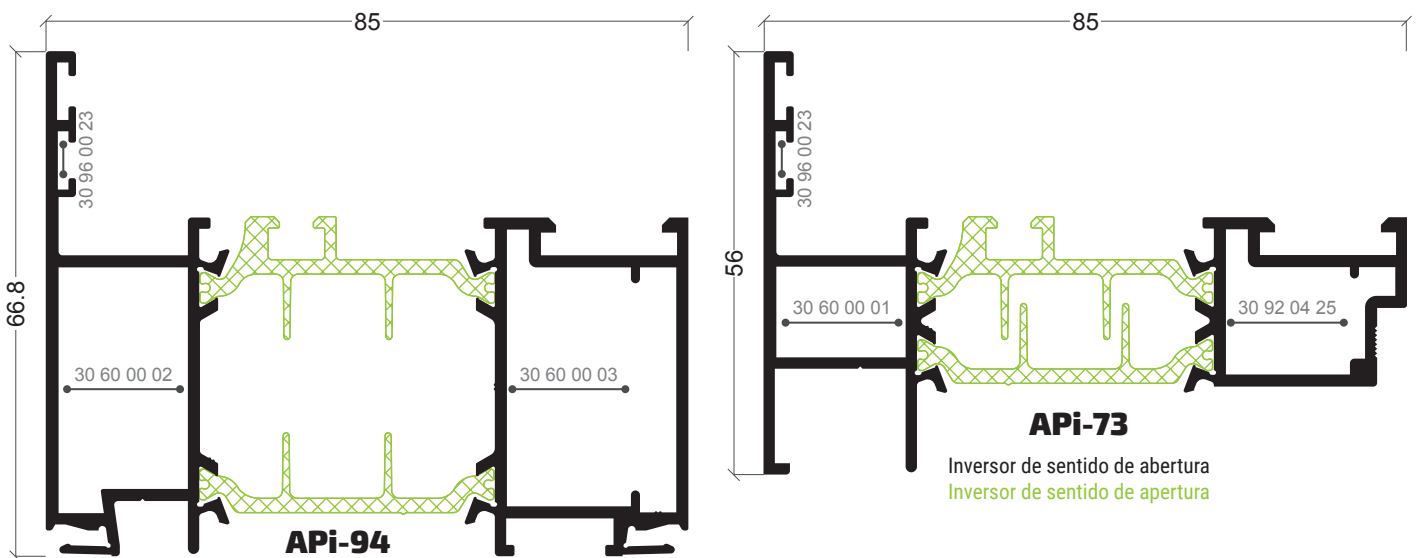

**API-94**

Aro fixo com duplo clip  
Marco puerta con enganches ext/int

**API-73**

Inversor de sentido de abertura  
Inversor de sentido de abertura

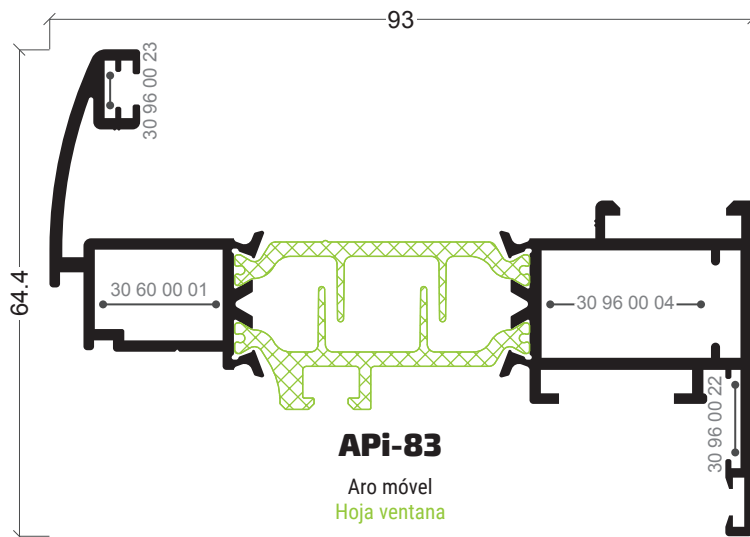
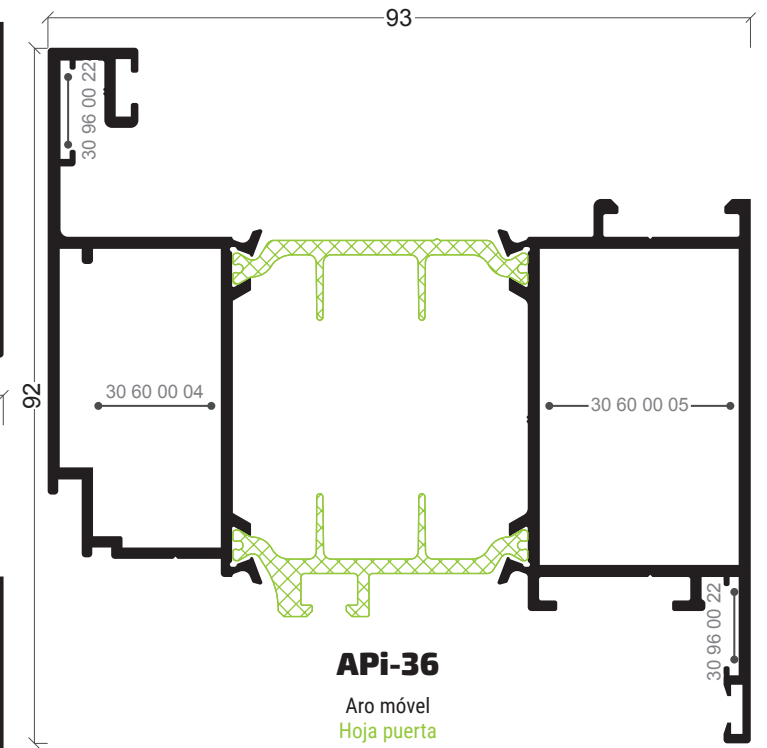
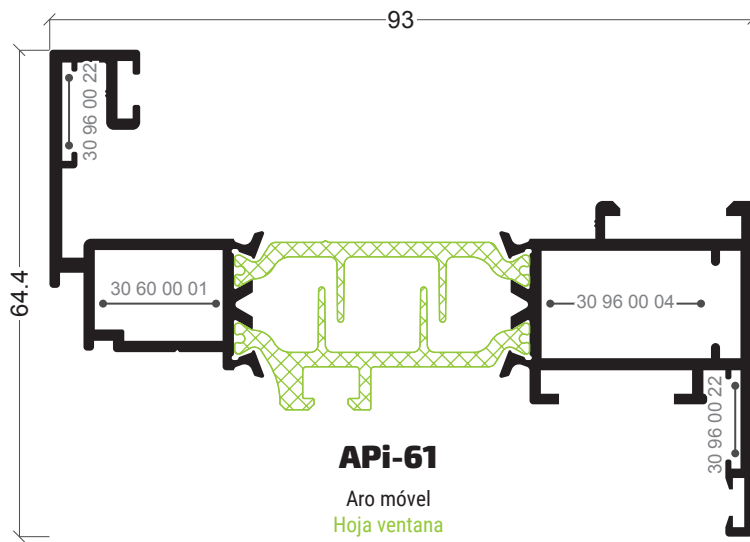
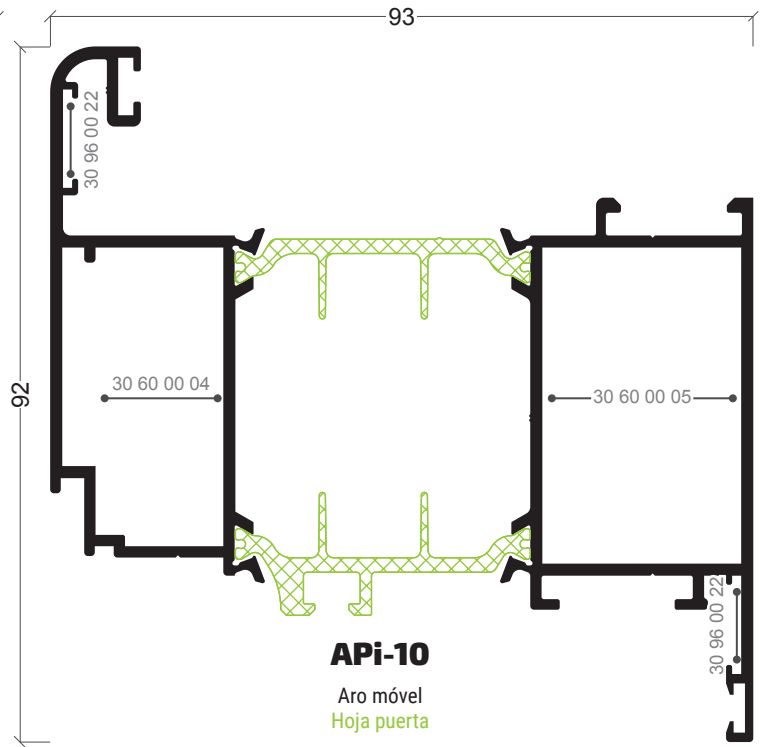
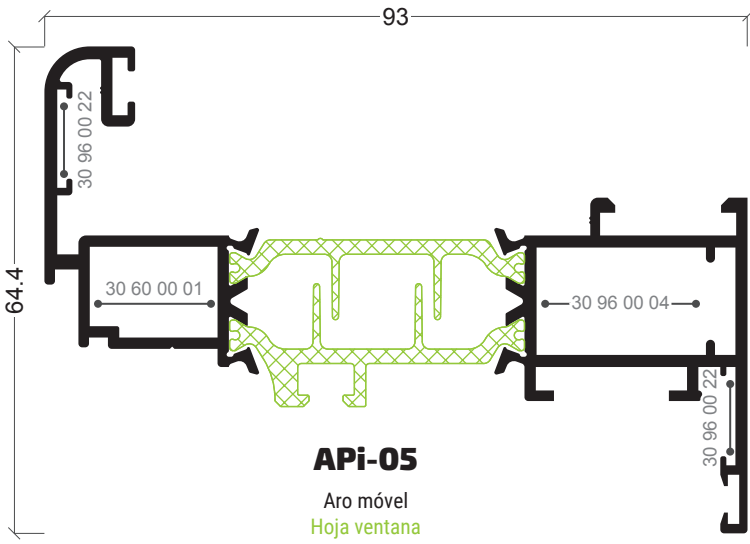

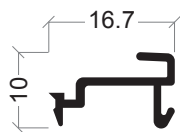
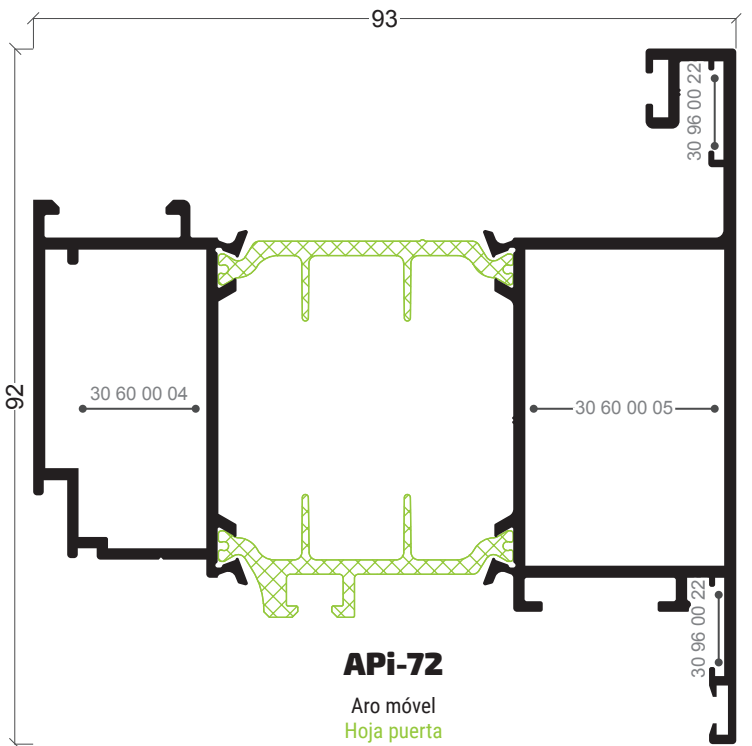
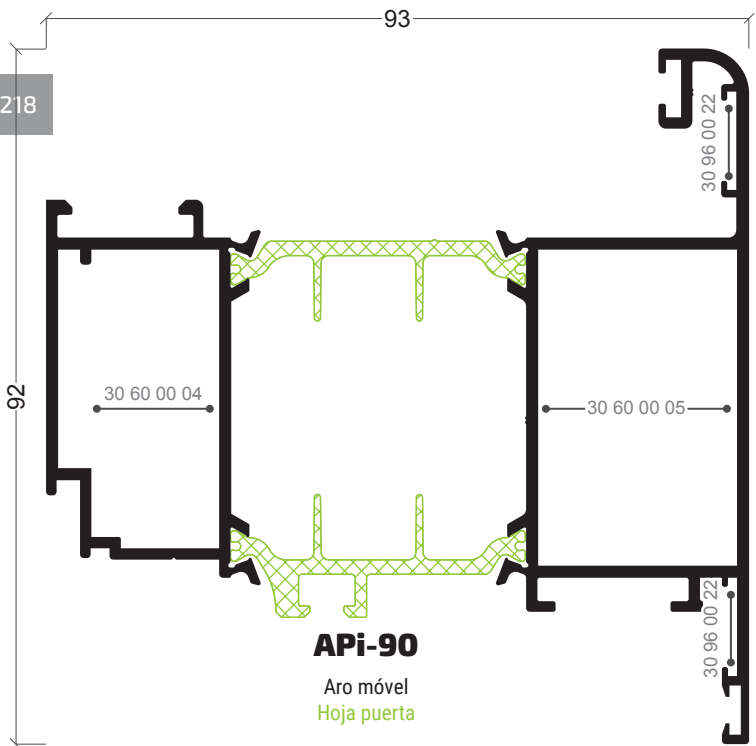
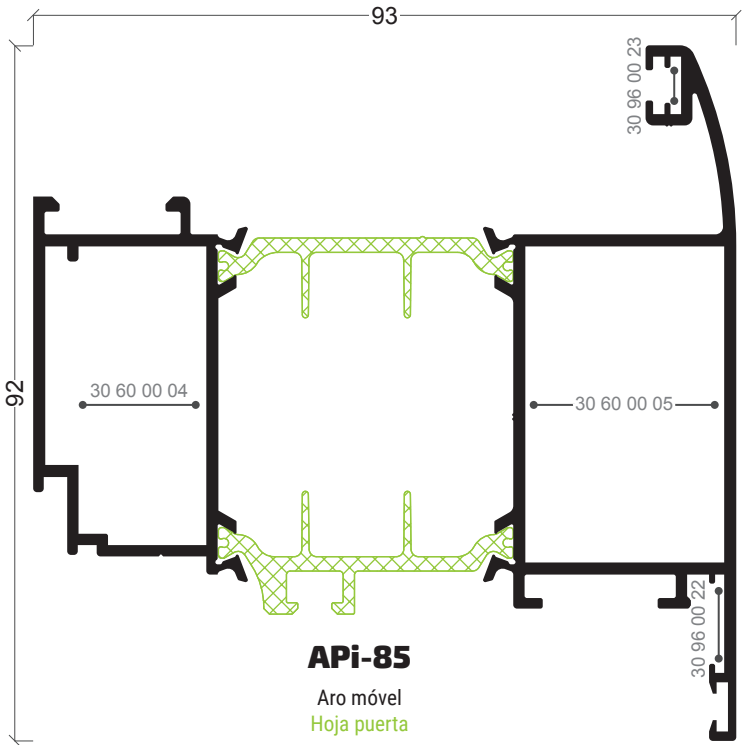
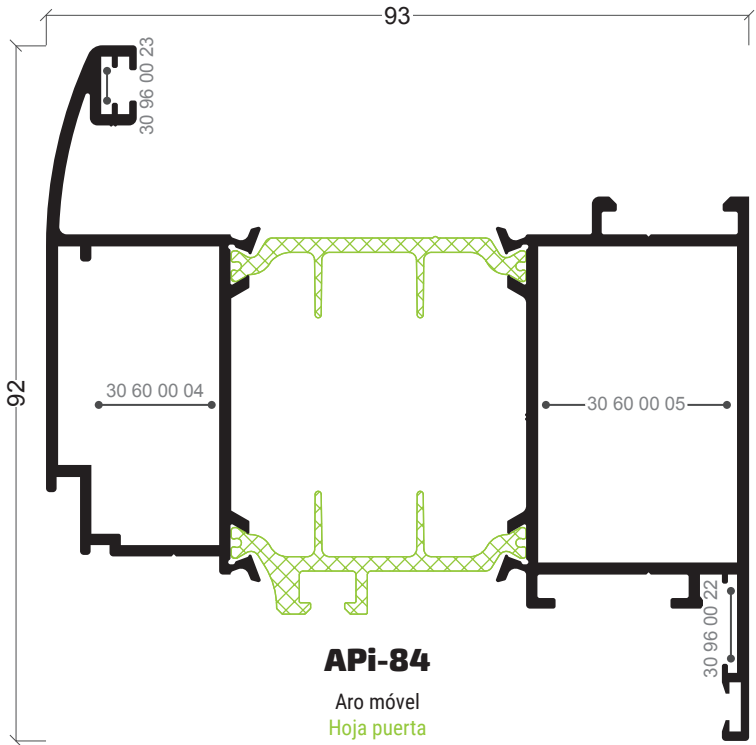

**AX-33**  
Mola bite  
Grapa junquillo

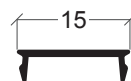

**KL-04**  
Tampa  
Tapón

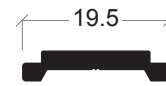
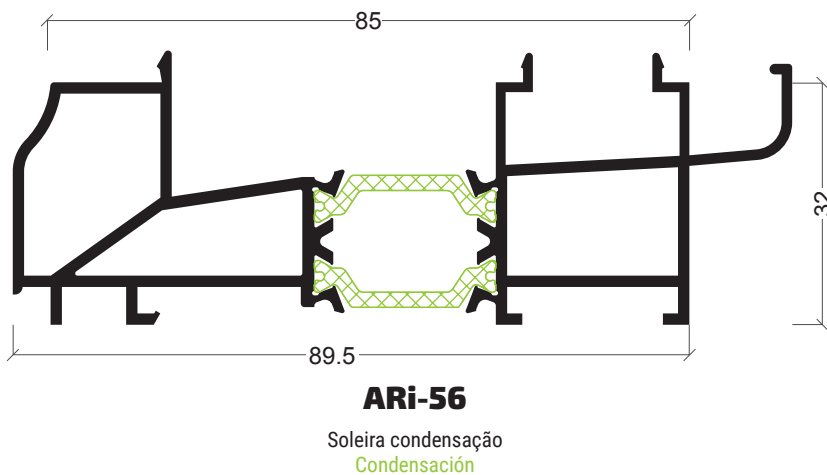
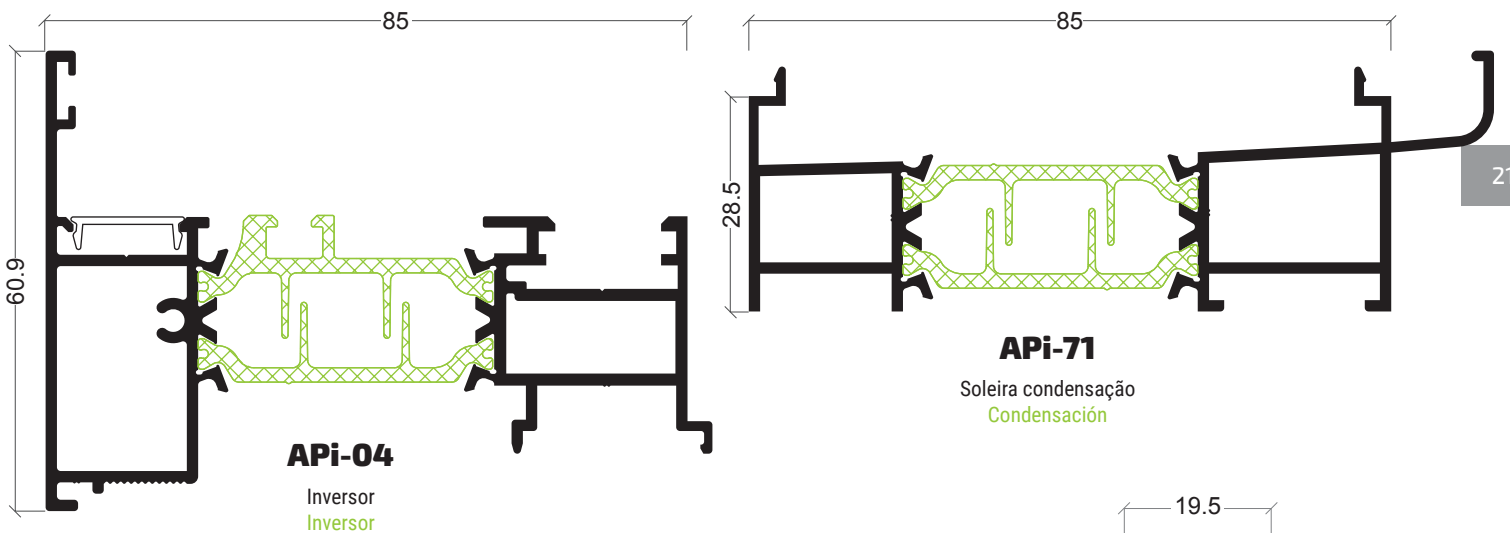
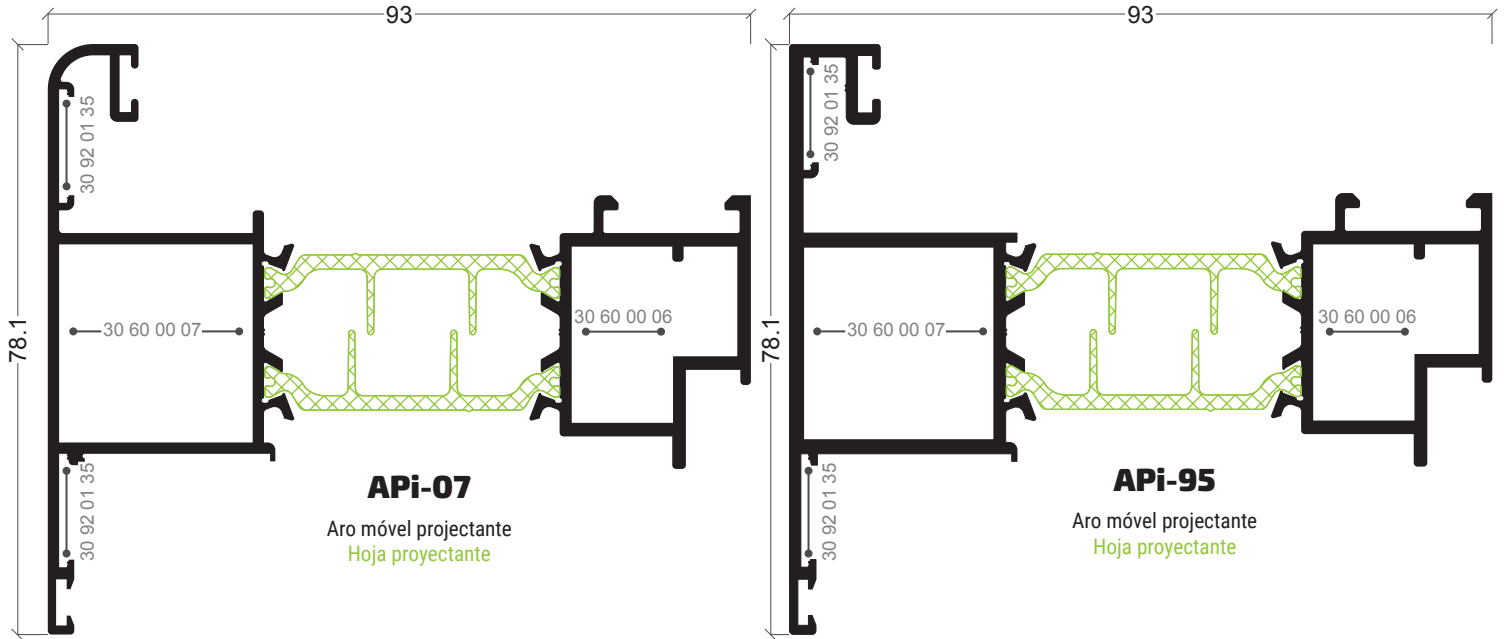

**AX-19**

Vareta  
Pletina falleba



**AXi-31**

Guia projectante  
Guia projectante

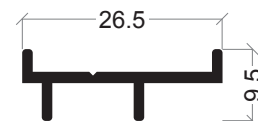

**AXi-32**

Complemento projectante  
Complemento projectante

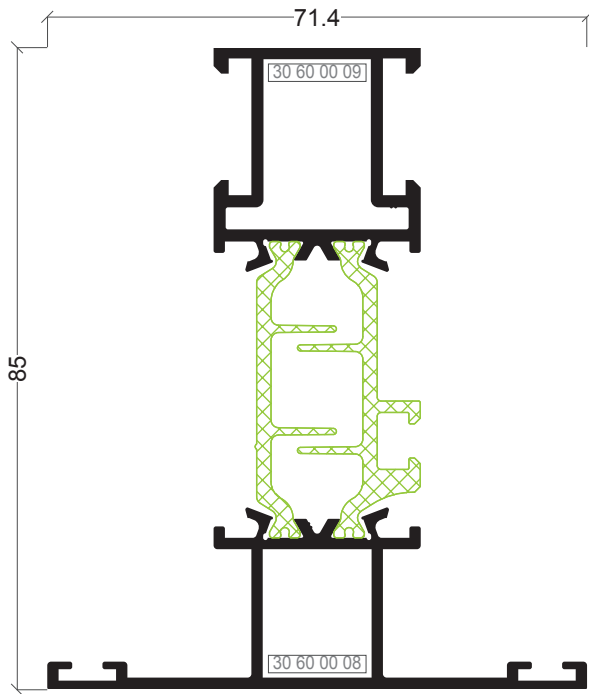

**APi-01**

Travessa  
Travesaño

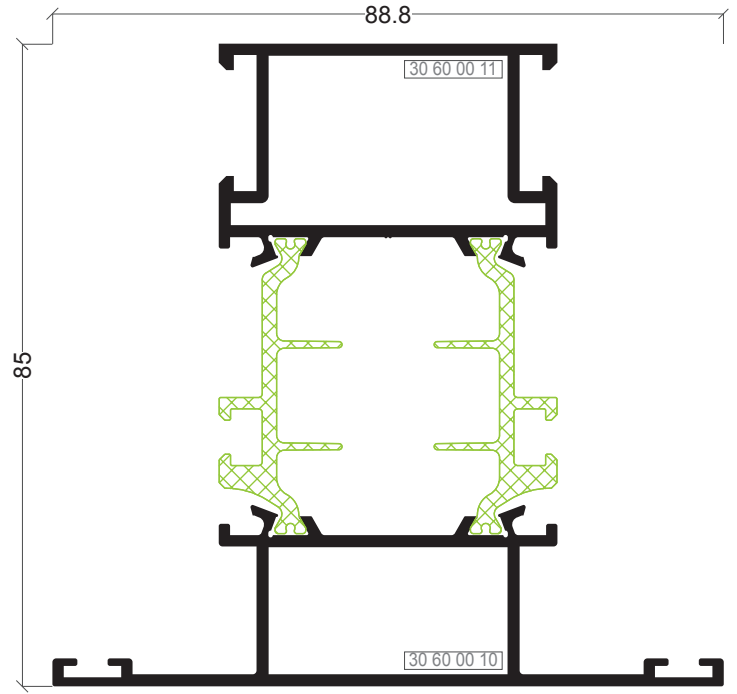

**APi-06**

Travessa  
Travesaño puerta

220

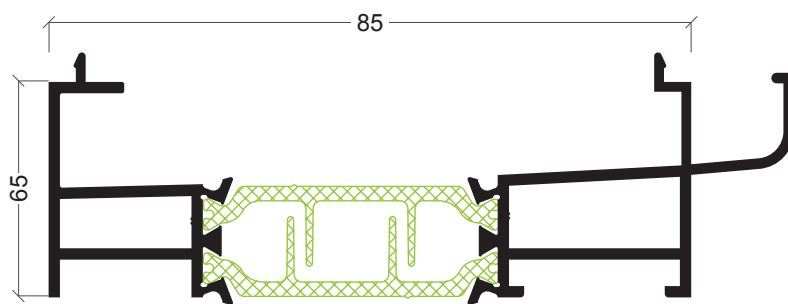

**APi-34**

Soleira condensação  
Condensación

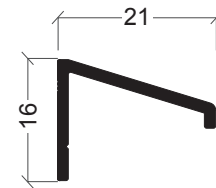

**A1-46**

Pingadeira janela  
Vierteaguas ventana

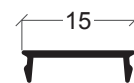

**KL-04**

Tampa  
Tope

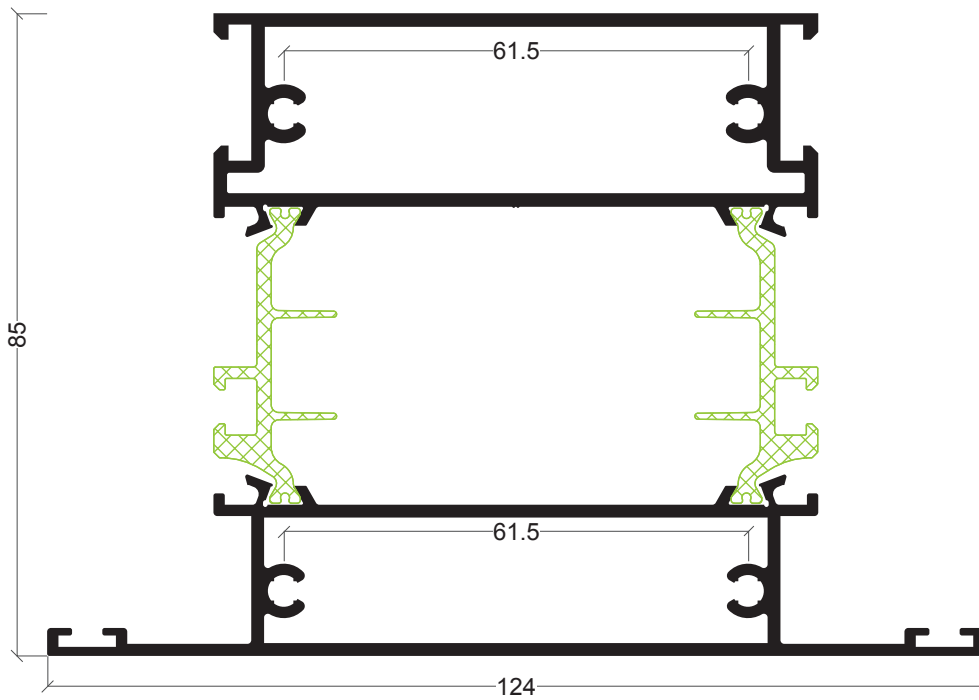

**APi-12**

Travessa  
Zócalo 124x85mm

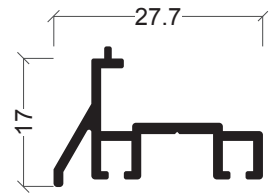

**AJi-62**

Pingadeira inferior porta sacada  
Vierendeau inferior porta

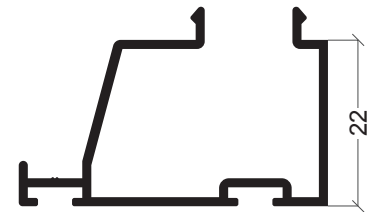

**AJi-82**

Bite remate  
Junquillo acople porta

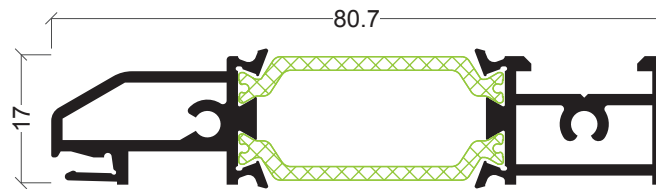

**APi-63**

Soleira  
Solape inferior porta con enganche

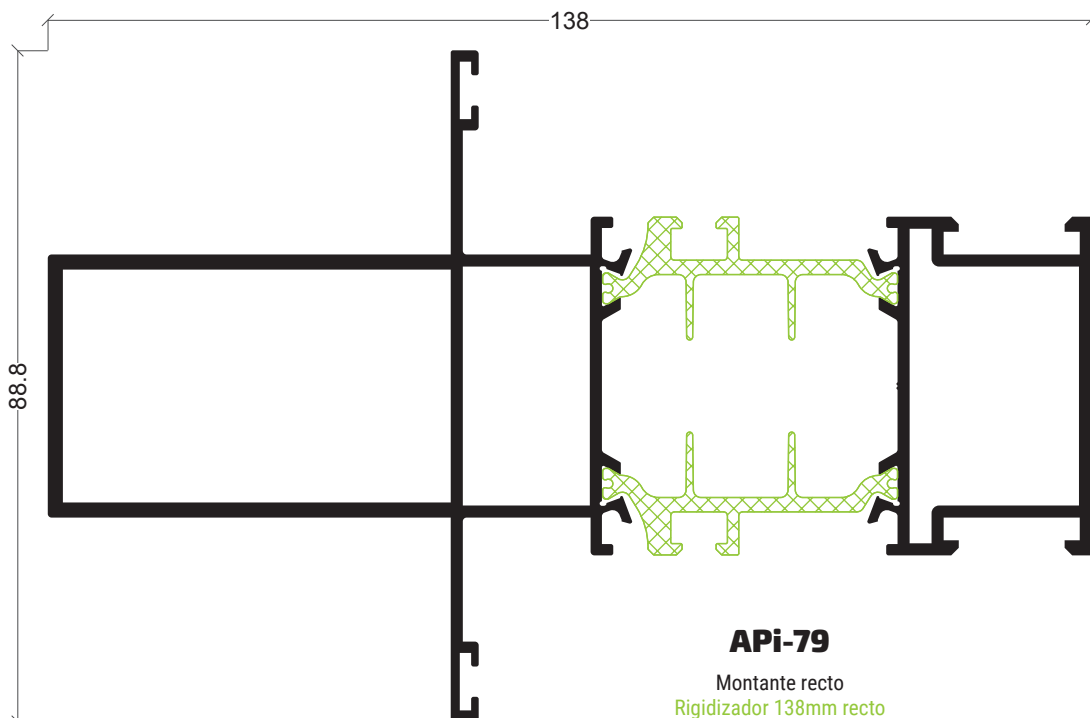

**APi-79**

Montante recto  
Rigidizador 138mm recto

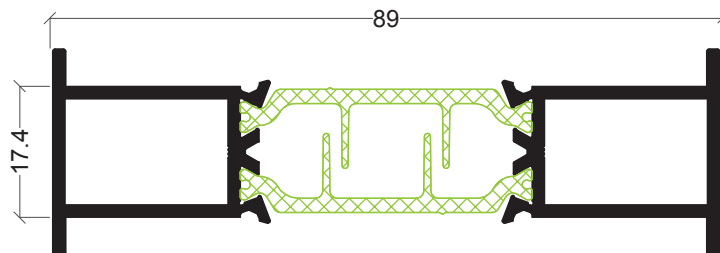

**APi-21**

União de aros  
Unión de marcos

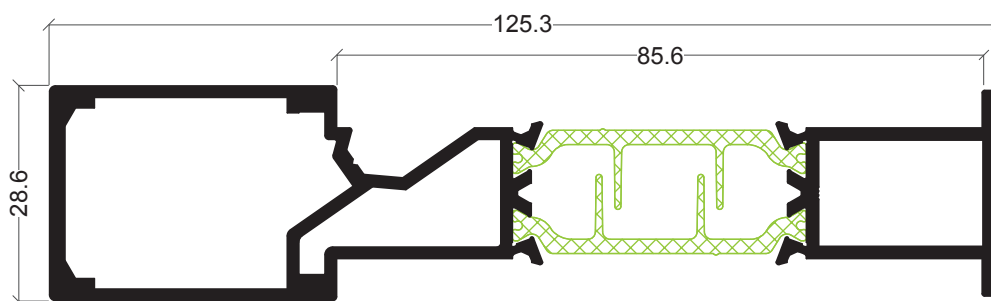

**APi-65**

União de aros  
Unión de marcos con refuerzo

222

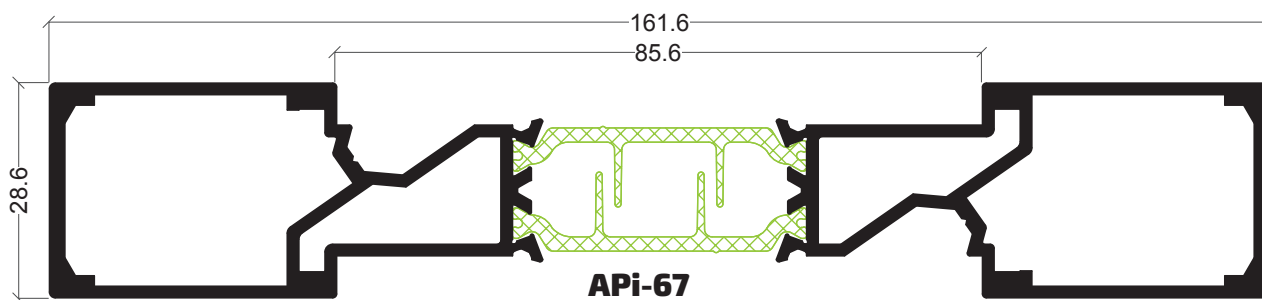

**APi-67**

União de aros  
Unión de marcos con doble refuerzo



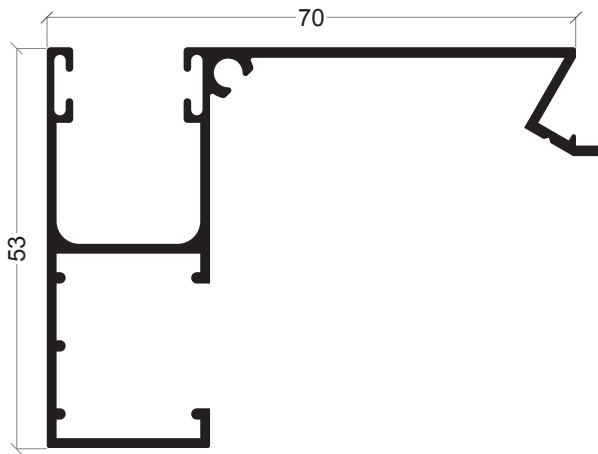

**S-26**

Guia de persiana  
Guia de persiana

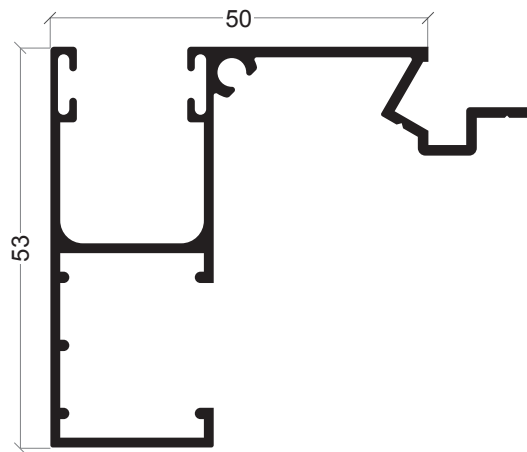

**S-25**

Guia de persiana  
Guia de persiana

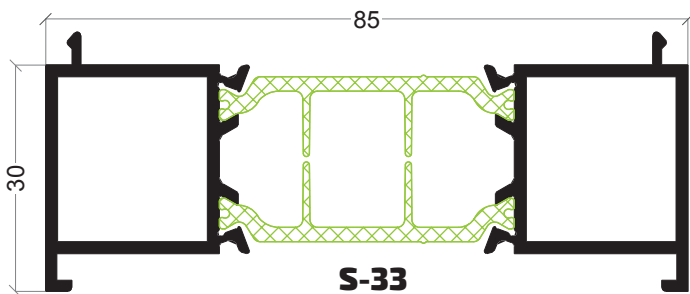

**S-33**

Perfil de ligação  
Perfil de conexión



**S-32**

Remate interior 45 mm  
Solape interior 45 mm

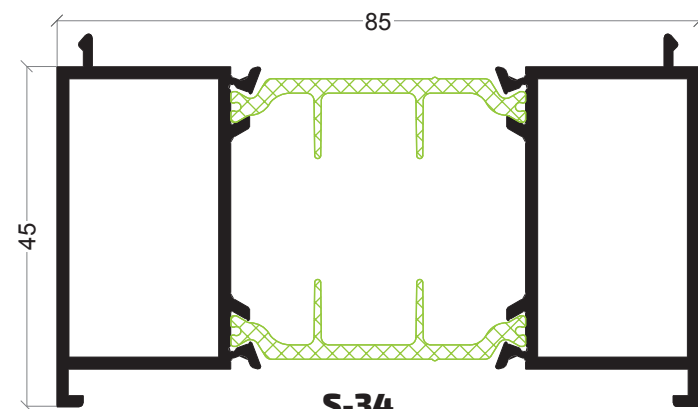

**S-34**

Perfil de ligação  
Perfil de conexión



**CT-94**

Perfil de união  
Perfil de unión

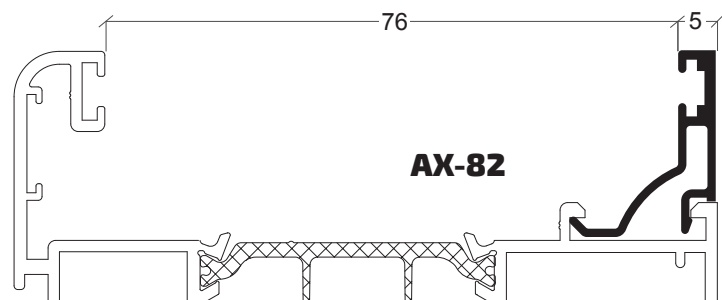

**AX-82**

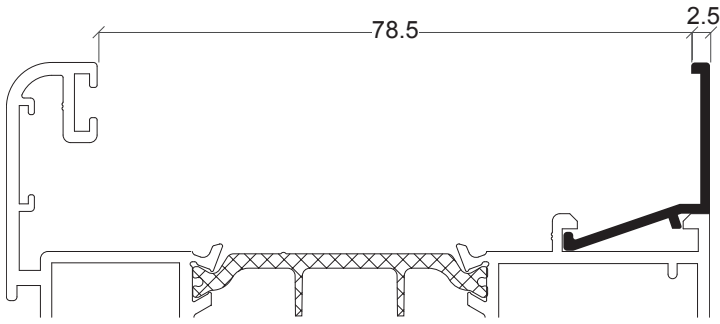

**AX-69**

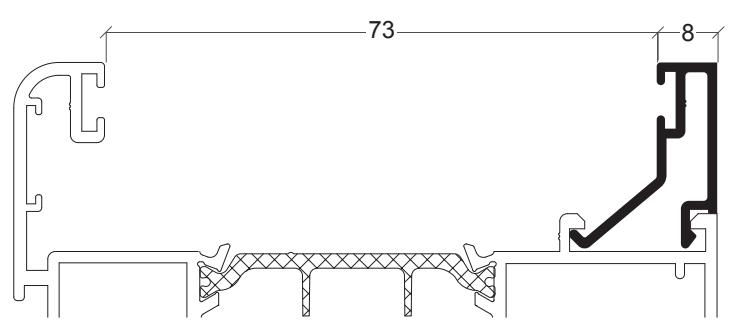

**AX-74**

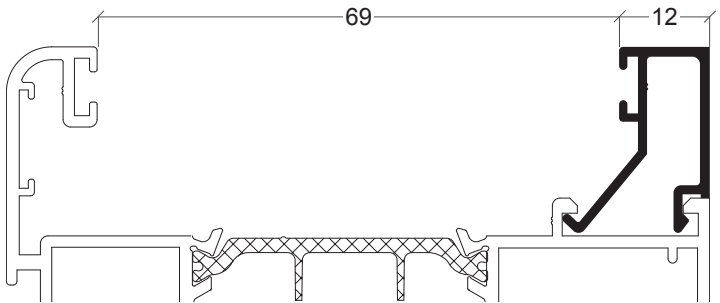

**AX-36**

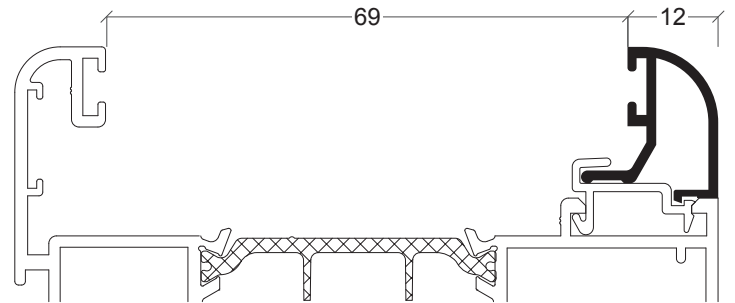

**AX-37**

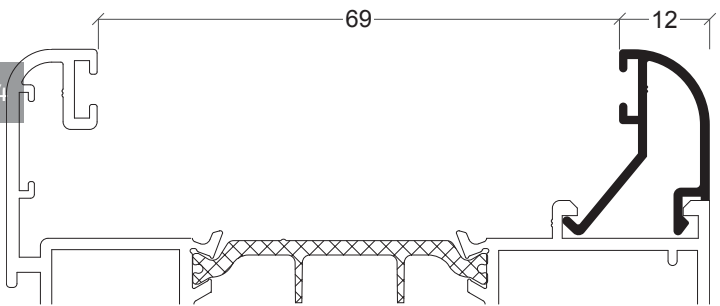

**AX-08**

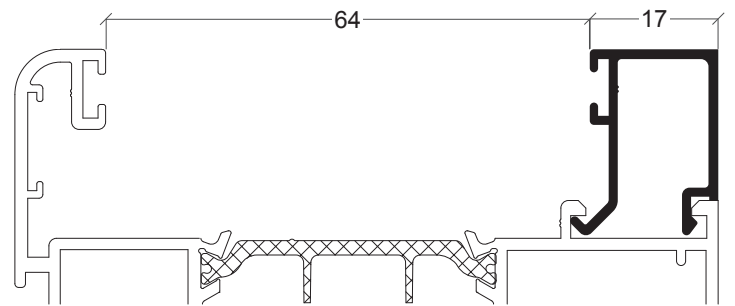

**AX-46**

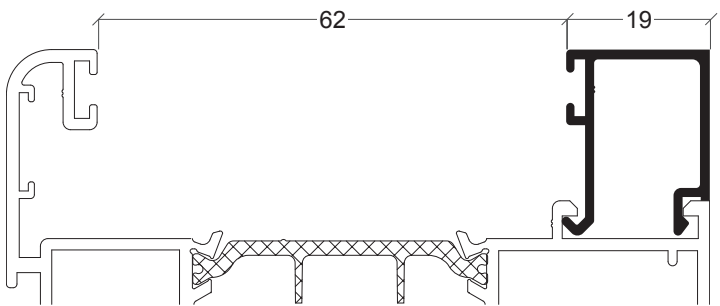

**AX-35**

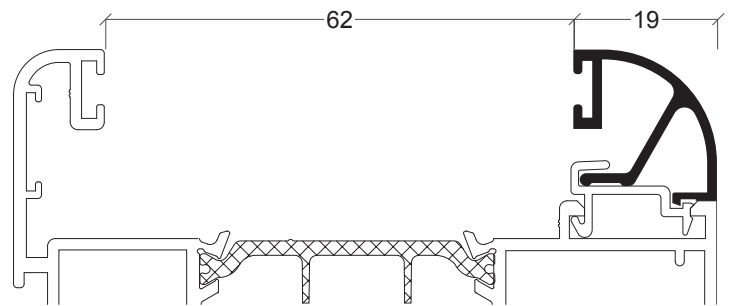

**AX-30**

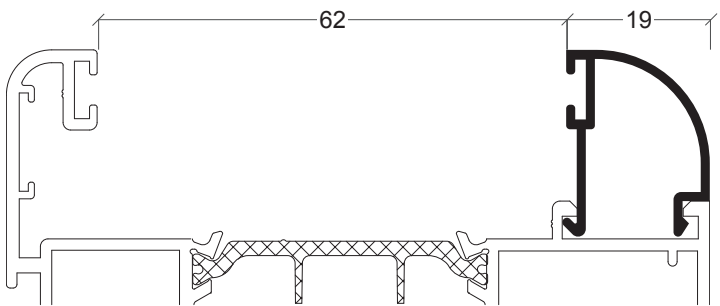

**AZ-07**

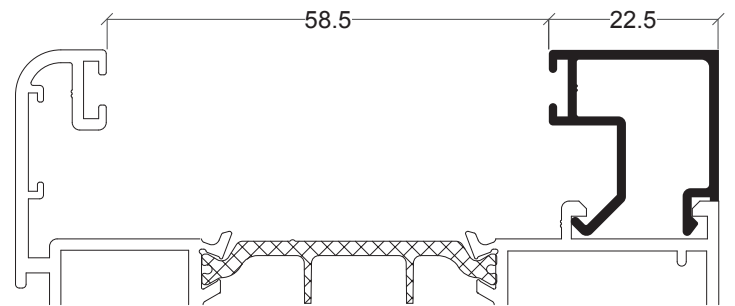

**AX-78**

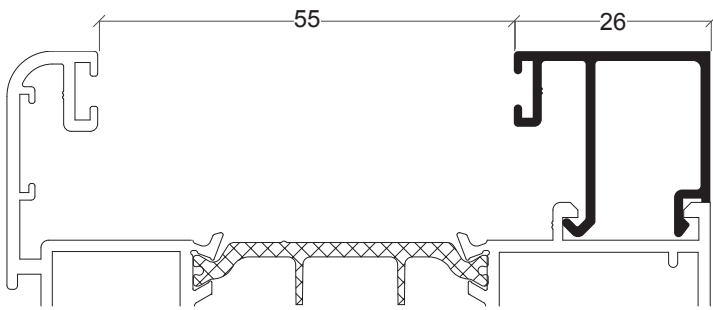

**AX-31**

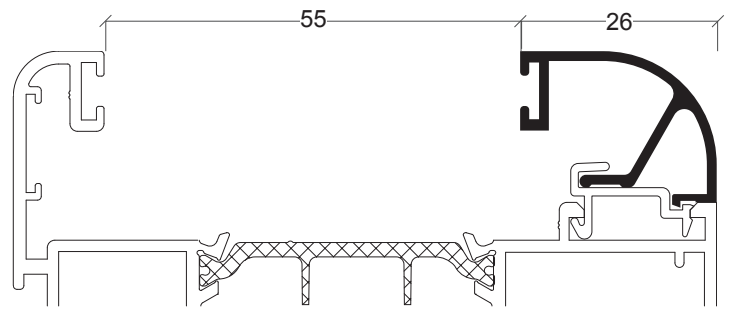

**AX-29**

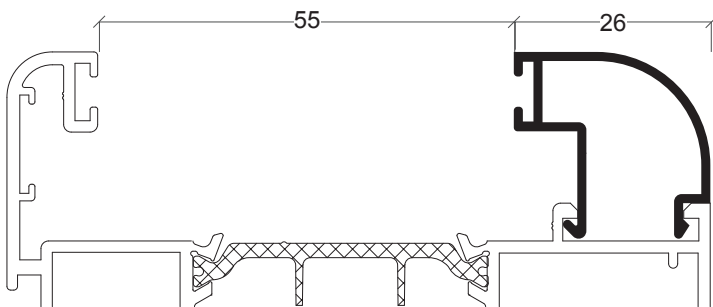

**AZ-06**

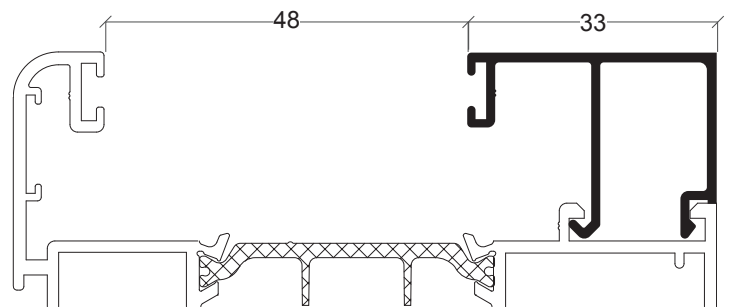

**AX-34**

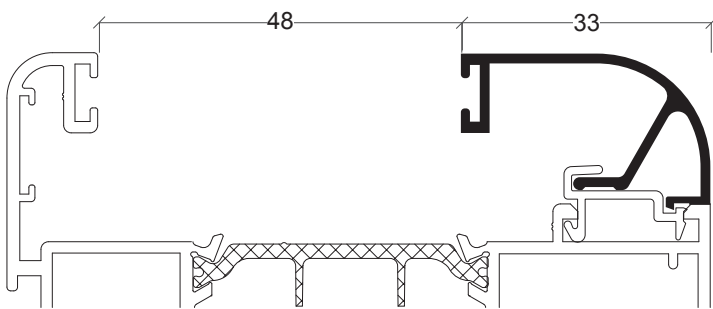

**AX-39**

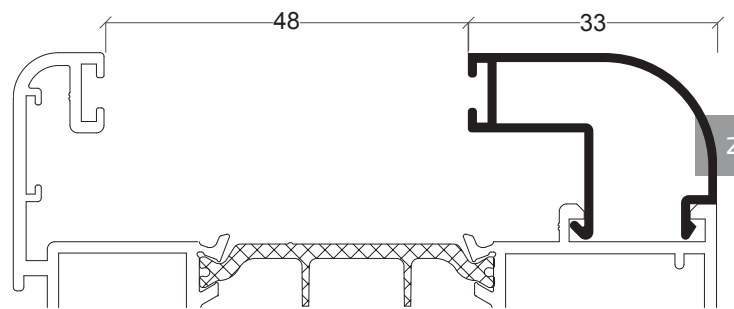

**AZ-28**

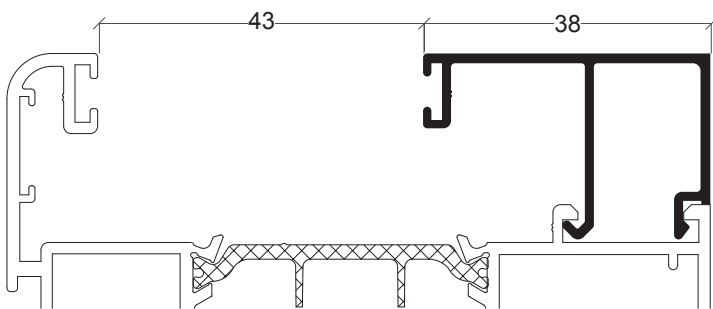

**AX-32**

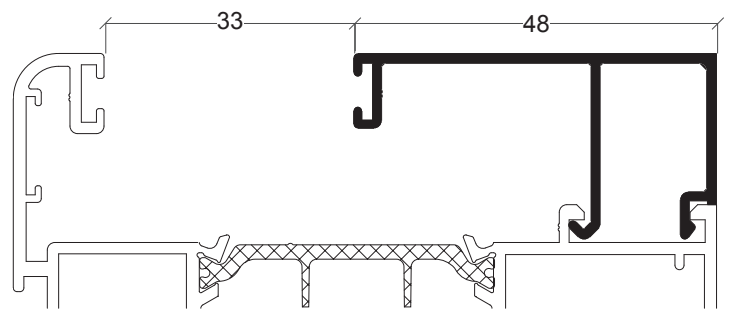

**AX-80**

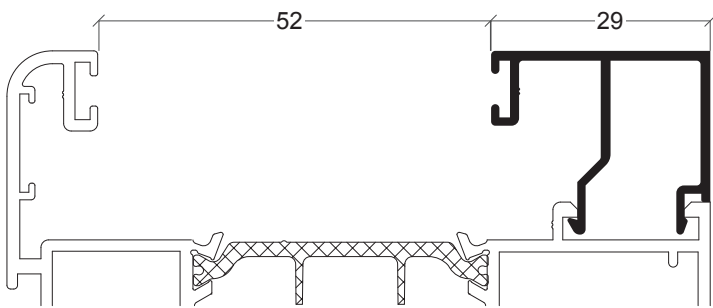

**AX-81**

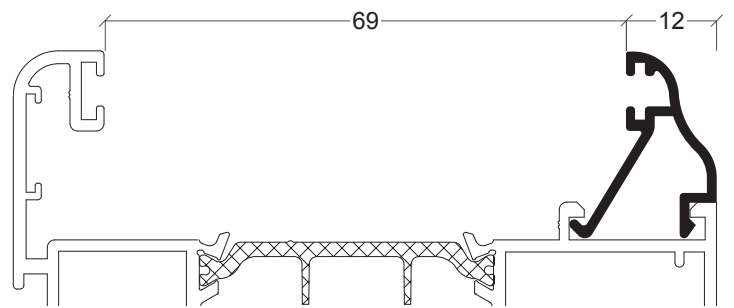

**AX-73**

225

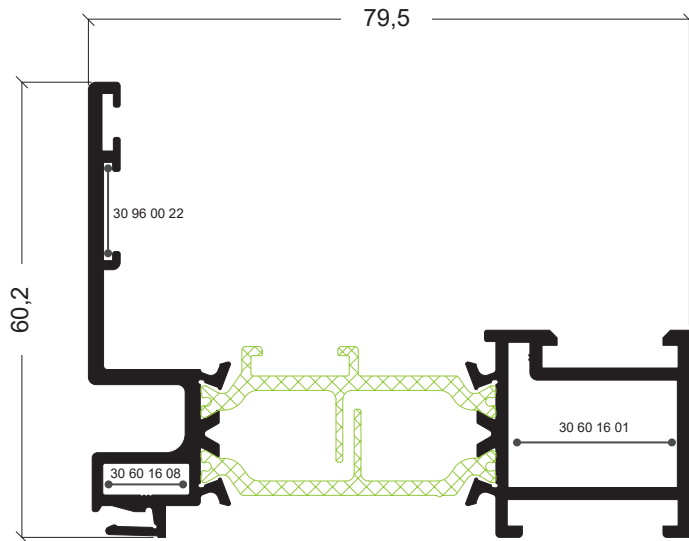

**API-145**

Aro fixo  
Marco

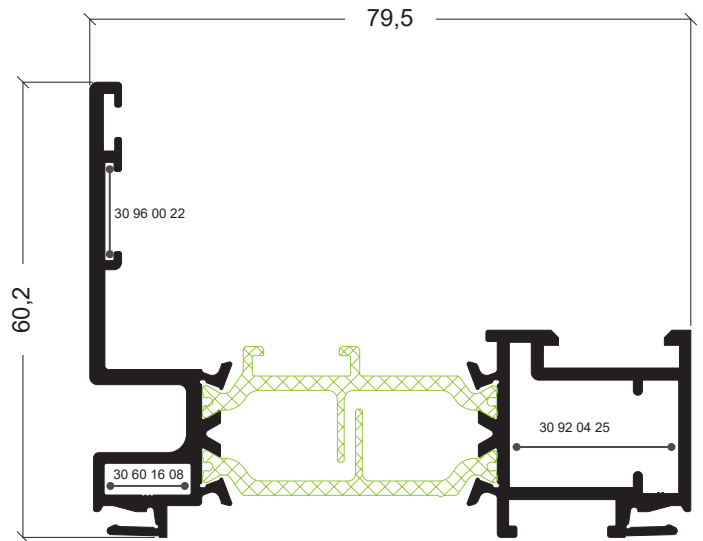

**API-158**

Aro fixo  
Marco

226

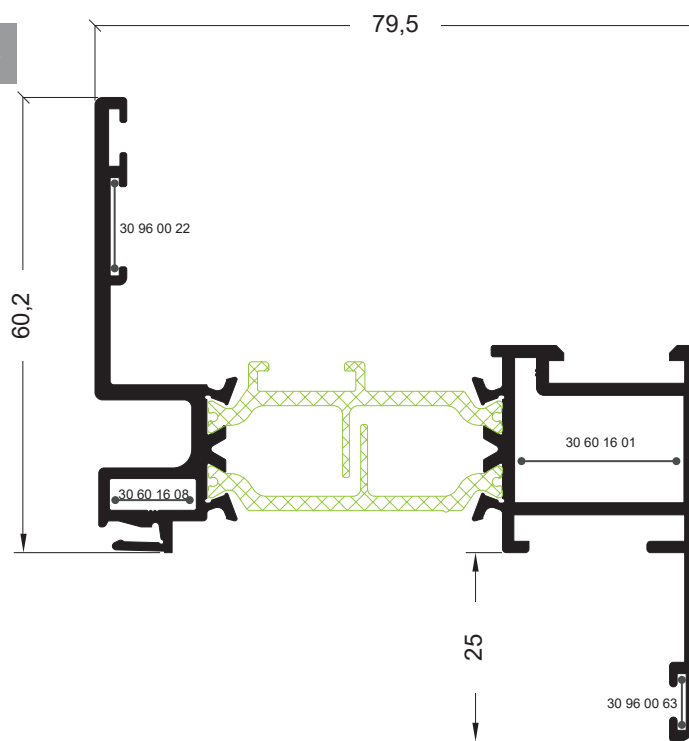

**API-146**

Aro fixo com remate  
Marco con solape

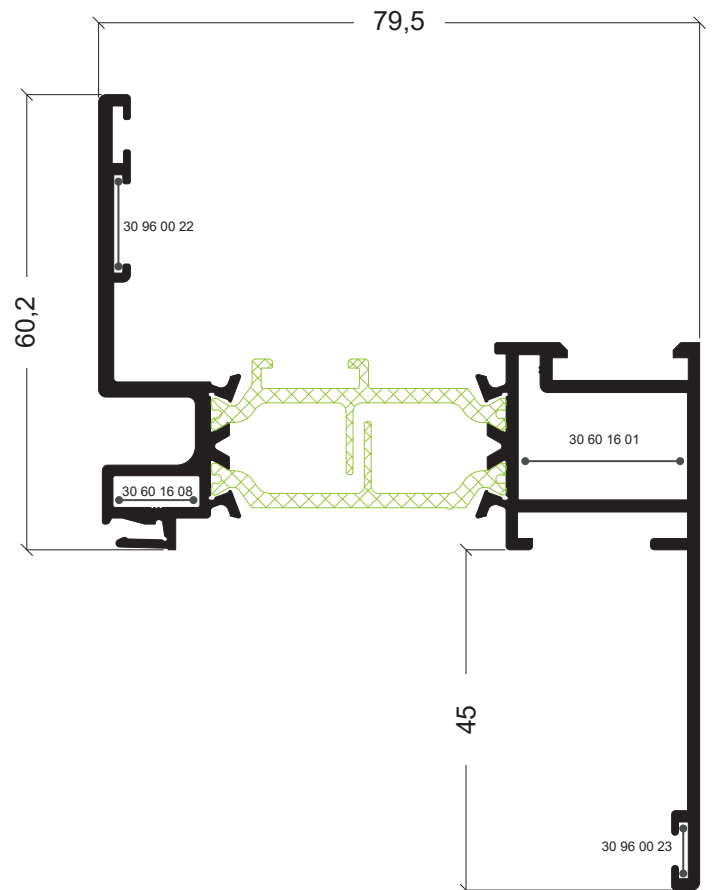

**API-153**

Aro fixo com remate  
Marco con solape

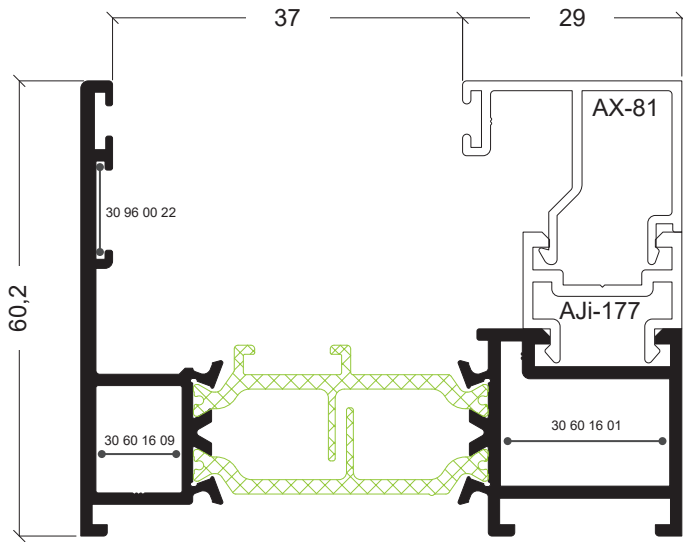

**APi-103**

Aro fixo  
Marco

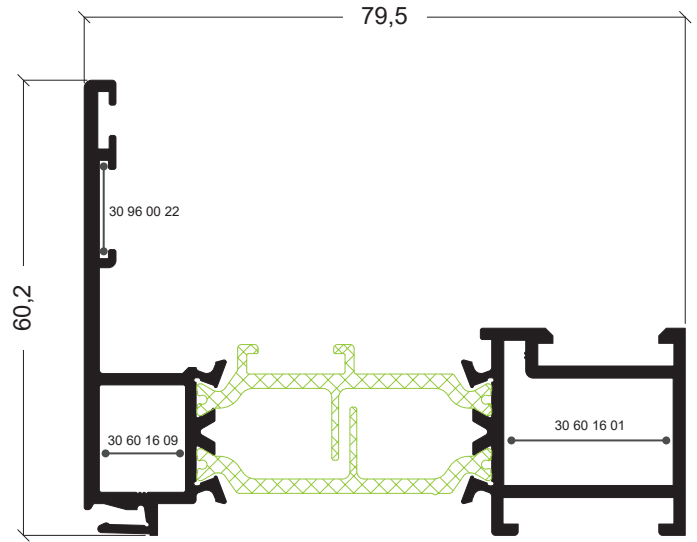

**APi-176**

Aro fixo  
Marco

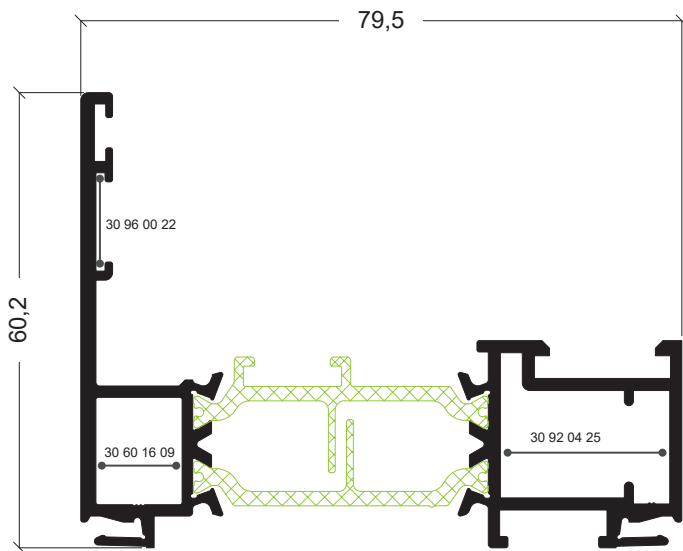

**APi-180**

Aro fixo  
Marco

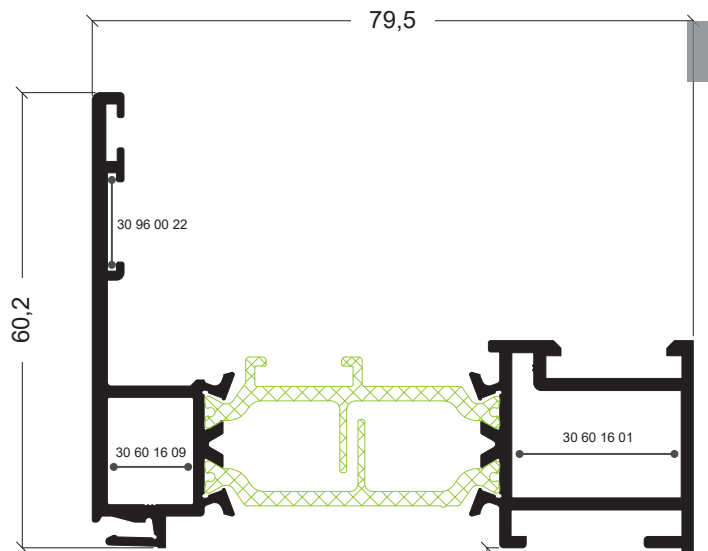

**APi-174**

Aro fixo com remate  
Marco con solape

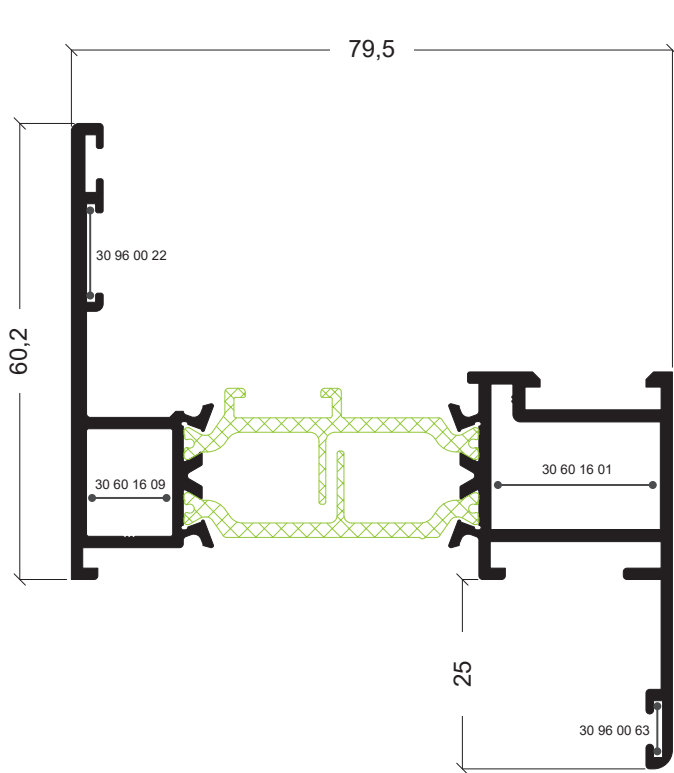

**APi-135**

Aro fixo com remate  
Marco con solape

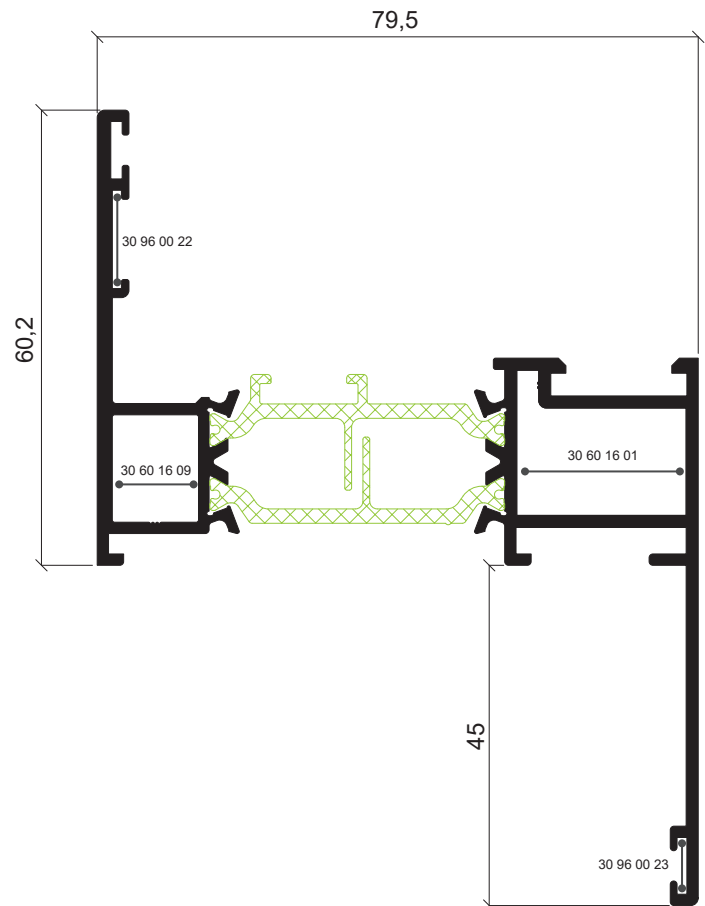

**APi-133**

Aro fixo com remate  
Marco con solape

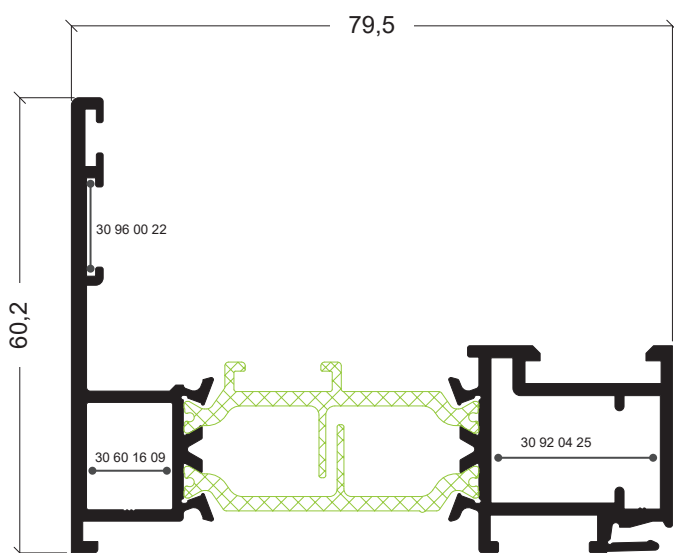

**APi-191**

Aro Fixo  
Marco

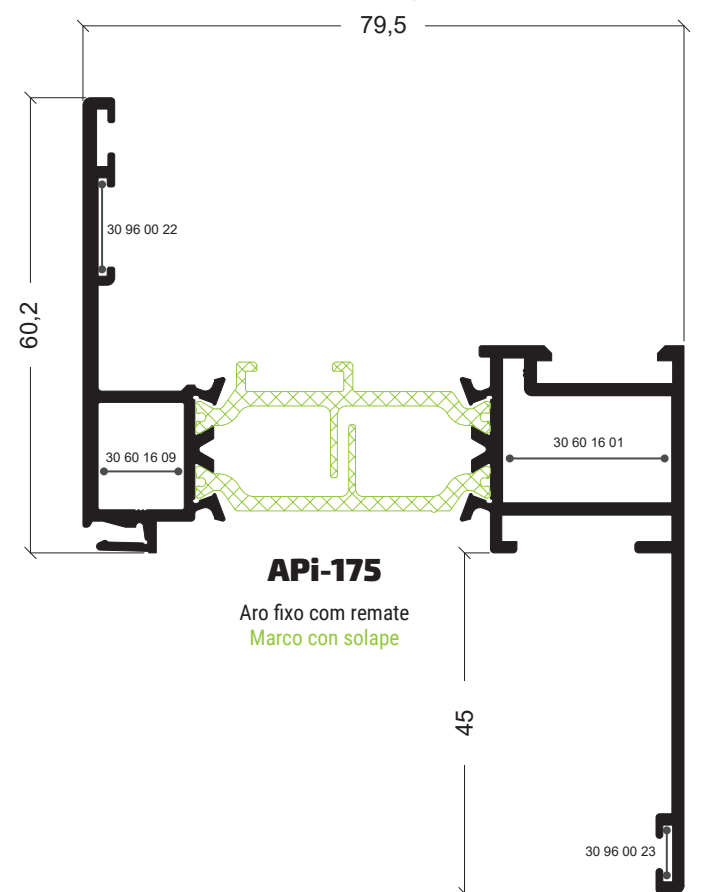

**APi-175**

Aro fixo com remate  
Marco con solape

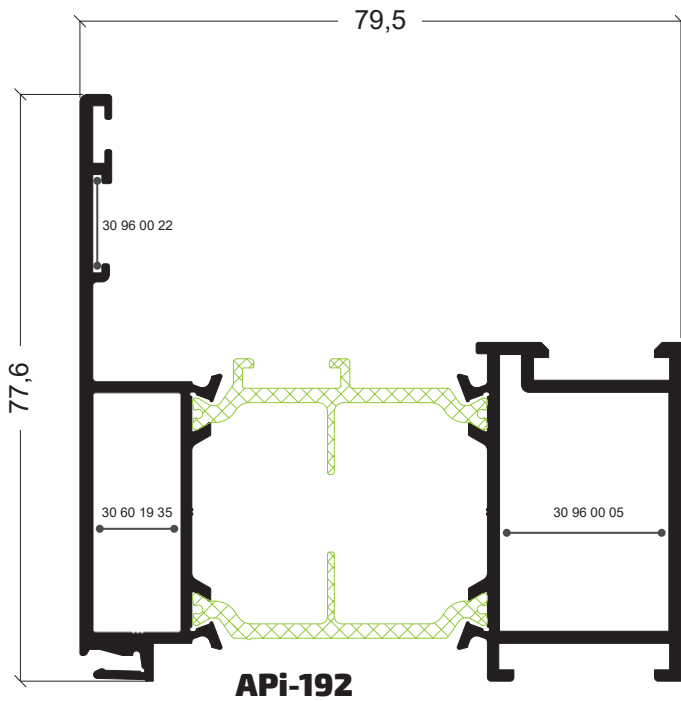

Aro Fixo  
Marco

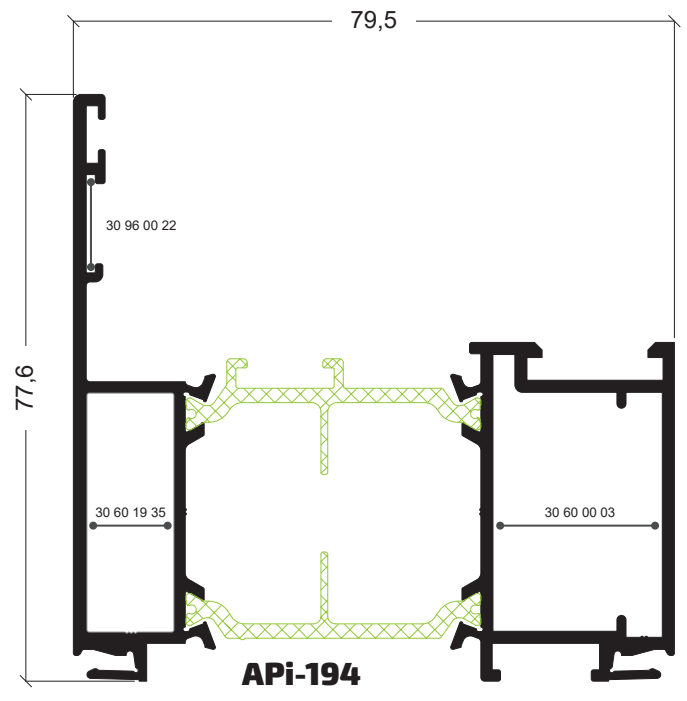

Aro Fixo  
Marco

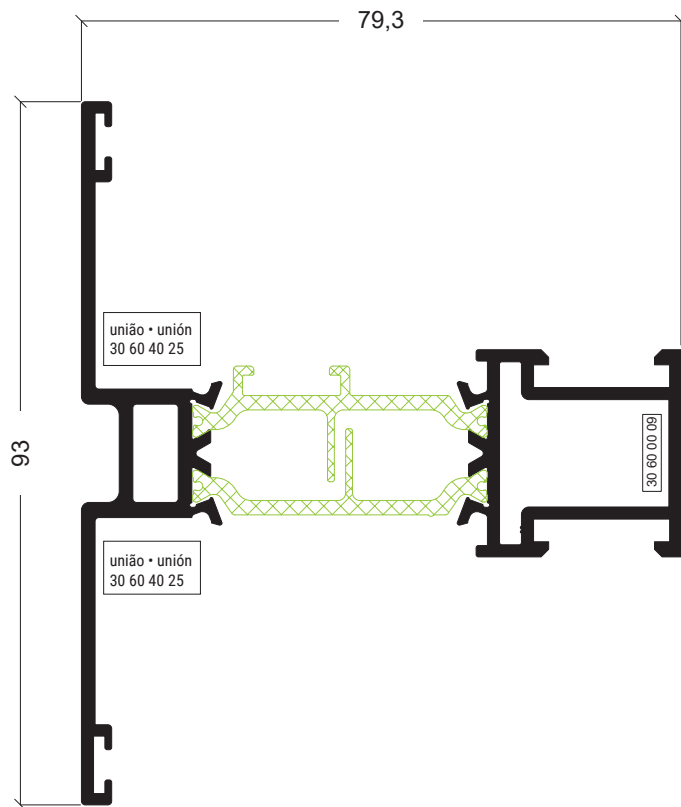

Travessa  
Travessaão

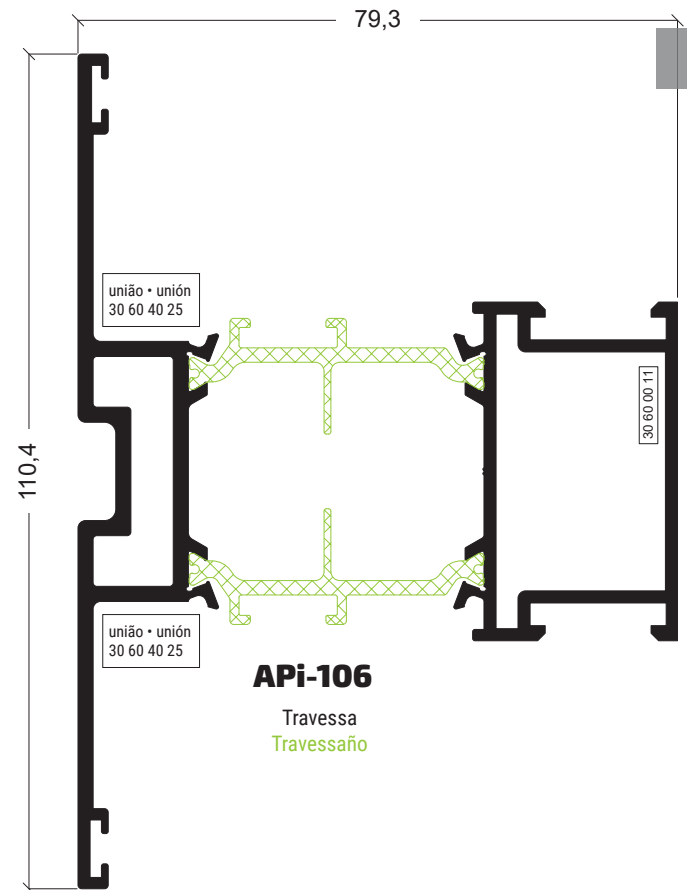

Travessa  
Travessaão

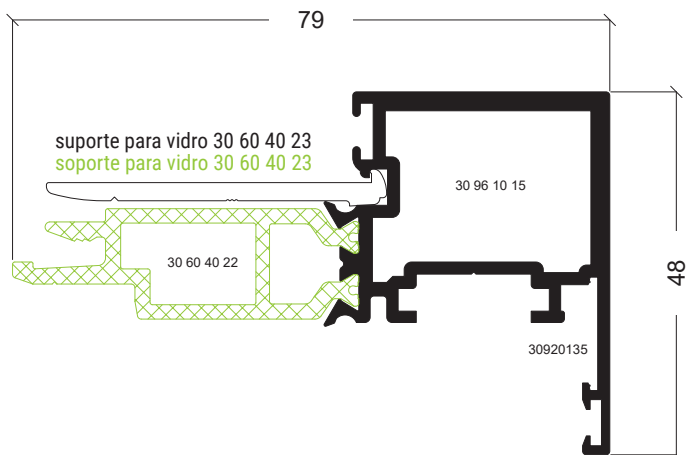

**APi-78**

Aro móvel  
Hoja

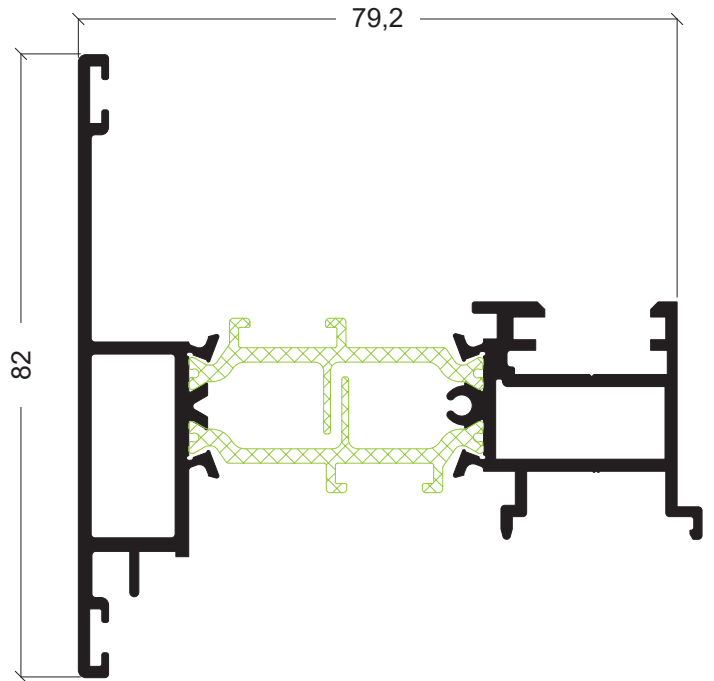

**APi-44**

Inversor  
Inversor

230

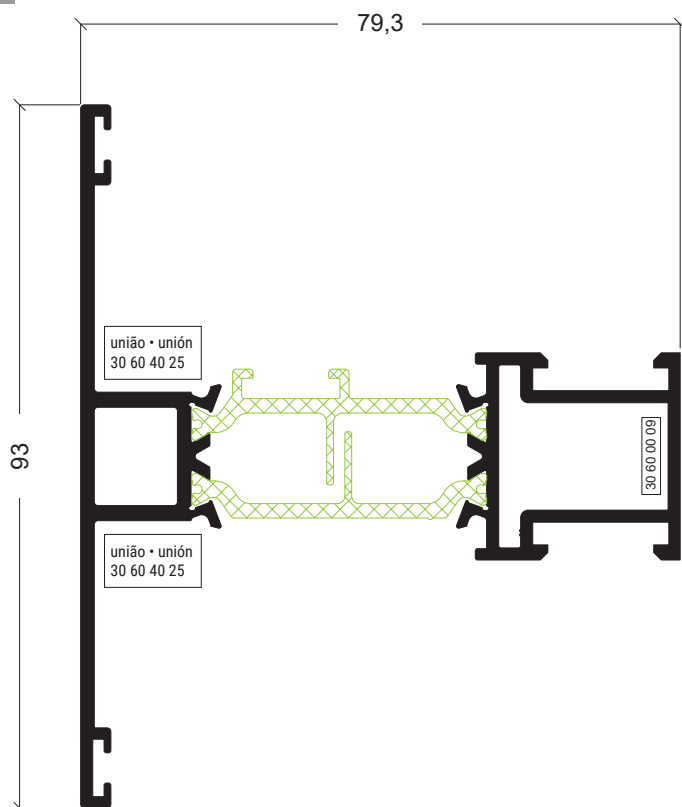

**APi-102**

Travessa  
Travessaño

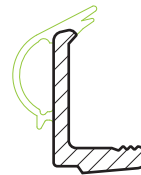

**AJi-148**

Bite  
Junquillo



**APi-48**

Bite  
Junquillo

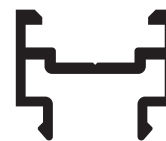

**AJi-177**

Bite  
Junquillo



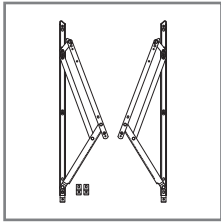

**30 00 95 21**

Jogo Compasso (180 kg)  
Juego Compás (180 kg)

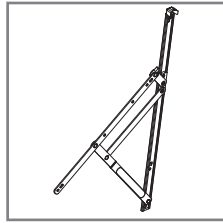

**30 00 95 71**

Jogo Compasso (75 kg)  
Juego Compás (75 kg)

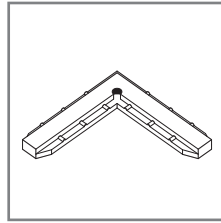

**30 21 20 07**

Esquadro de alinhamento  
Escuadra de alineamiento

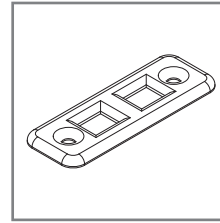

**30 24 30 75**

Contra-fecho Duplo inox  
Contracierre doble inox

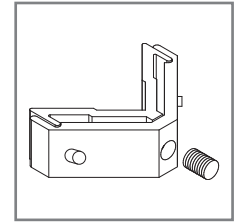

**30 60 00 01**

Esquadro exterior janela  
Escuadra exterior ventana

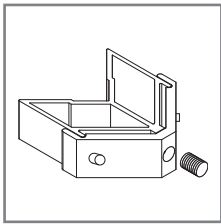

**30 60 00 02/04**

Esquadro exterior porta fixo/móvel  
Escuadra exterior puerta fijo/ hoja

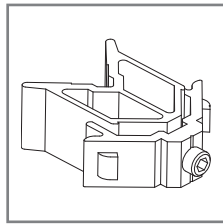

**30 60 00 03**

Esquadro interior porta com clip  
Escuadra interior puerta con clip

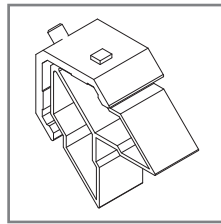

**30 60 00 05**

Esquadro interior porta  
Escuadra interior puerta

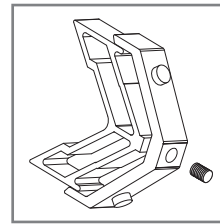

**30 60 00 06**

Esquadro interior projectante  
Escuadra interior projectante

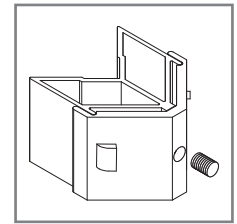

**30 60 00 07**

Esquadro exterior projectante  
Escuadra exterior projectante

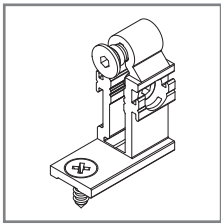

**30 60 00 08**

União travessa exterior pequena fixo  
Unión travesaño exterior pequeña fijo

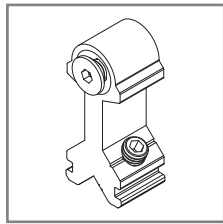

**30 60 00 09**

União travessa inferior pequena  
Unión travesaño interior pequeña

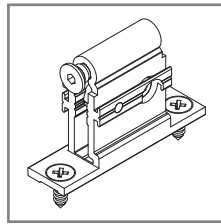

**30 60 00 10**

União travessa exterior grande fixo/móvel  
Unión n travessa exterior grande fijo/hoja

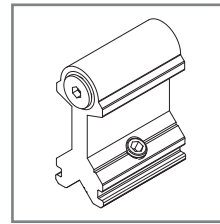

**30 60 00 11**

União travessa interior grande  
Unión travessa interior grande

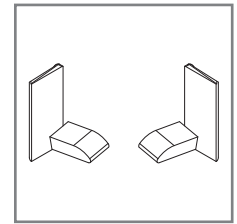

**30 60 00 13**

Conjunto topos AJI-62  
Conjunto topos AJI-62

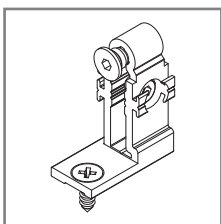

**30 60 00 16**

União travessa exterior pequena móvel  
Unión travesaño exterior pequeña móvil

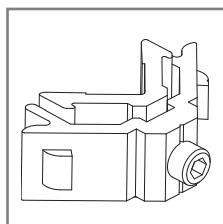

**30 60 16 01**

Esquadro interior janela  
Escuadra interior ventana

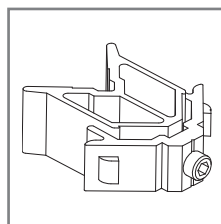

**30 60 16 02**

Esquadro interior porta  
Escuadra interior puerta

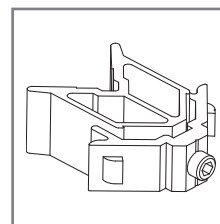

**30 60 16 03**

Esquadro interior aro fixo (API-113)  
Escuadra interior Marco (API-113)

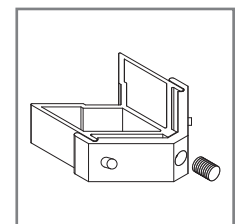

**30 60 16 04**

Esquadro exterior aro móvel entrada  
Escuadra exterior hoja puerta entrada

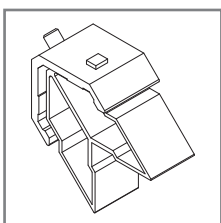

**30 60 16 05**

Esquadro interior porta entrada  
Escuadra interior hoja puerta entrada

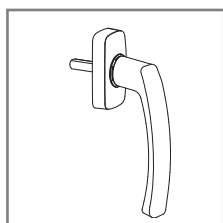

**30 60 16 40/41**

Puxador de alumínio branco/preto  
Manilla de alumínio blanco/negro

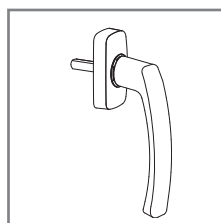

**30 60 16 42/43**

Puxador de alumínio 2 ac/champ ac  
Manilla de alumínio 2 ac/champ ac

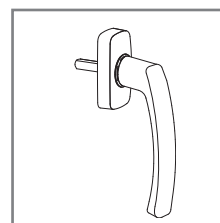

**30 60 16 44**

Puxador de alumínio inox ac  
Manilla de alumínio inox ac

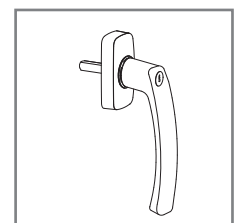

**30 60 16 45/46**

Puxador com chave de alumínio branco/preto  
Manilla con llave de alumínio blanco/negro

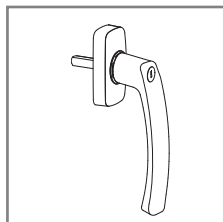

**30 60 16 47/48**

Puxador com chave de alumínio 2 ac/champ ac  
Manilla con llave de aluminio 2 ac/champ ac

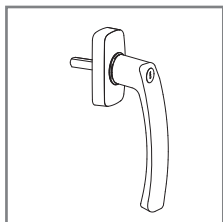

**30 60 16 49**

Puxador com chave de alumínio inox ac  
Manilla con llave de aluminio inox ac

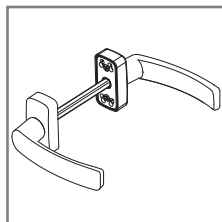

**30 60 16 50/51**

Puxador duplo de alumínio branco/preto  
Manilla doble de aluminio blanco/negro

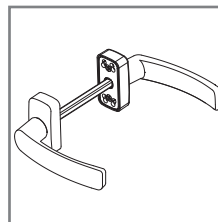

**30 60 16 52/53**

Puxador duplo de alumínio 2 ac/champ ac  
Manilla doble de aluminio 2 ac/champ ac

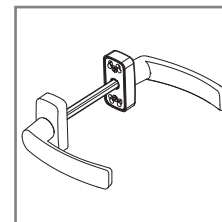

**30 60 16 54**

Puxador duplo de alumínio inox ac  
Manilla doble de aluminio inox ac

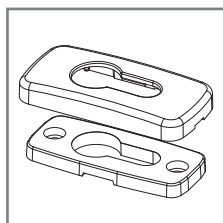

**30 60 16 55/56/57**

Escudo em Alumínio branco/preto/2AC  
Escudo en aluminio blanco/negro/2AC

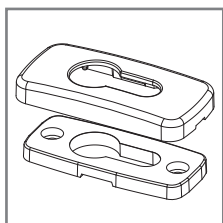

**30 60 16 58/59**

Escudo em Alumínio champ AC/inox AC  
Escudo en aluminio champ AC/inox AC

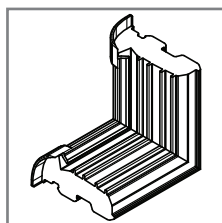

**30 60 40 01**

Canto vulcanizado API-F0 PassiveHouse preto  
Angulo vulcanizado API-F0 PassiveHouse negro

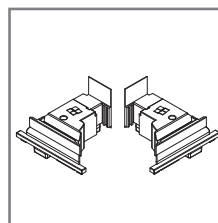

**30 60 40 05**

Conjunto topos inversor API-Folha Oculta  
Conjunto topos inversor API-Hoja Oculta

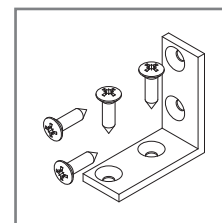

**30 60 40 25**

União travessa exterior (API-101/102/106)  
Unión travessa exterior (API-101/102/106)

232

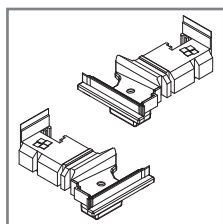

**30 70 00 12**

Conjunto topos inversor API  
Conjunto topos inversor API

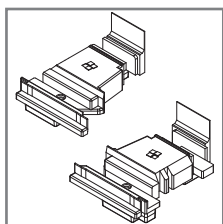

**30 70 16 12**

Conjunto topos inversor API canal 16  
Conjunto topos inversor API canal 16

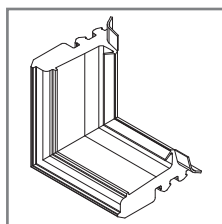

**30 70 16 31**

Canto vulcanizado C16  
Angulo vulcanizado C16

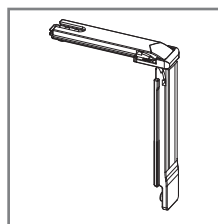

**30 90 20 42**

Ângulo de reenvio  
Angulo de reenvio

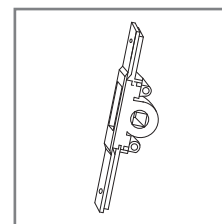

**30 90 20 44**

Transmissão para abertura exterior  
Trasmisión para abertura exterior

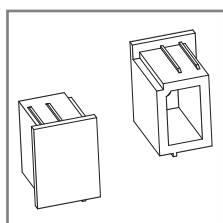

**30 91 21 20**

Jogo topos condensação Y-20  
Juego topos condensación Y-20

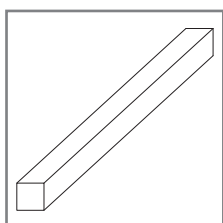

**30 91 41 23**

Perno 7 x 131 mm  
Perno 7 x 131 mm

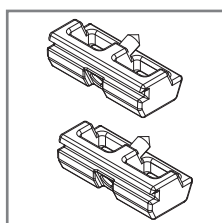

**30 92 00 50**

Complemento fecho  
Complemento cierre

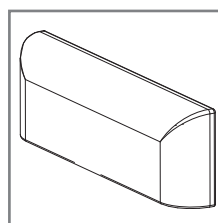

**30 92 01 00/01**

Goteira preto/branco  
Tapa salida de aguas negro/blanco

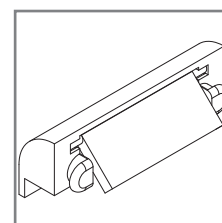

**30 92 01 02/03**

Goteira com válvula preto/branco  
Vierteaguas con válvula negro/blanco

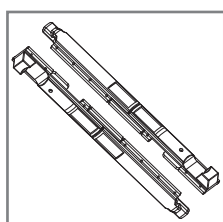

**30 92 01 20**

Jogo Fechos C.E.  
Juego cierre C.E.

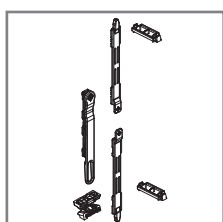

**30 92 01 23**

Jogo de passadores bidireccional C.E.  
Juego de pasadores bidireccional C.E.

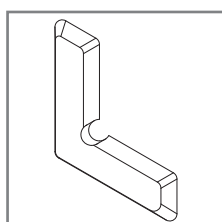

**30 92 01 35**

Esquadro de alinhamento interior  
Escuadra de alineamiento interior

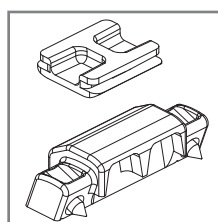

**30 92 02 60**

Apoio da folha  
Apoyo hoja

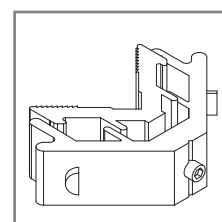

**30 92 04 25**

Esquadro para AZ-22  
Escuadra para AZ-22

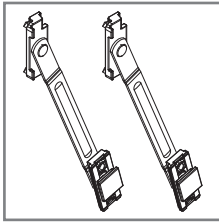

**30 92 04 75**

Jogo compassos basculante  
Juego compás abatible

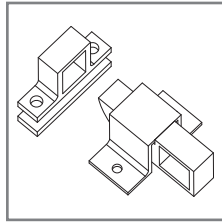

**30 92 04 76/77**

Fecho clack branco/preto  
Cierre golpete blanco/negro

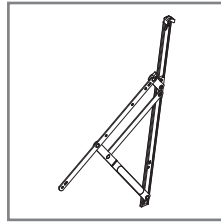

**30 92 04 80**

Compasso projectante deslizante até 50 kg /móvel  
Compás proyectante deslizante hasta 50 kg /hoja

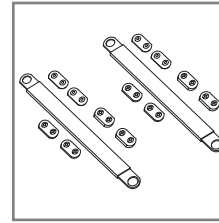

**30 92 04 85**

Jogo compassos  
Juego compás

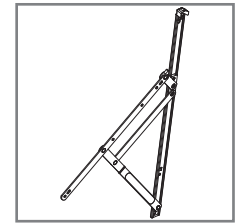

**30 92 04 90**

Compasso projectante deslizante até 65 kg /móvel  
Compás proyectante deslizante hasta 65 kg /hoja

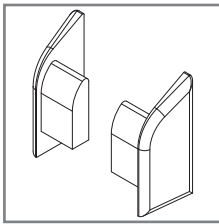

**30 92 05 00**

Jogo topos  
Juego topes

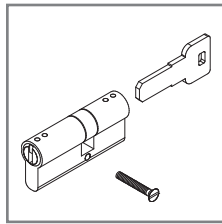

**30 92 13 03**

Canhão de segurança 30 x 80 Níquel  
Bombillo cierre 30 x 80 Níquel

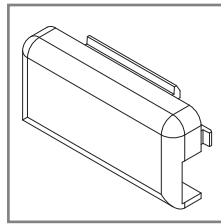

**30 92 13 04**

Goteira preta  
Vierteaguas negra

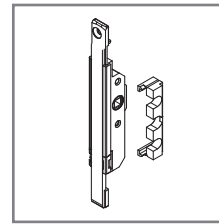

**30 92 13 05**

Transmissão bi-direccional  
Trasmisión bi-direccional

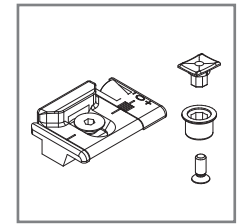

**30 92 13 06**

Ponto de fecho regulável  
Punto de cierre regulable

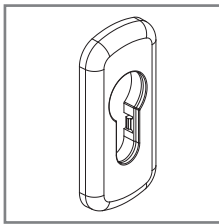

**30 92 22 85/86**

Escudo para canhão branco/preto  
Contracierre bombillo blanco/negro

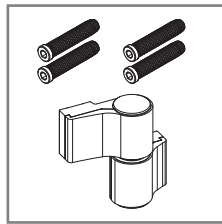

**30 92 22 88/89**

Dobradiça 2 abas porta  
c/ ressalto directa branco/preto  
Bisagra 2 cuerpos puerta  
c/ ressalto directa blanco/negro

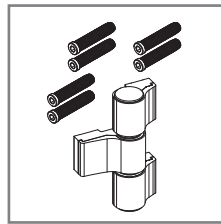

**30 92 22 90/91**

Dobradiça 3 abas porta  
c/ ressalto fixação branco/preto  
Bisagra 3 cuerpos puerta  
c/ ressalto fijación blanco/negro

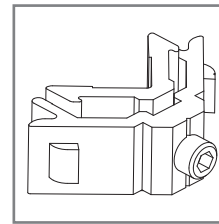

**30 96 00 04**

Esquadro interior janela  
Escuadra interior ventana

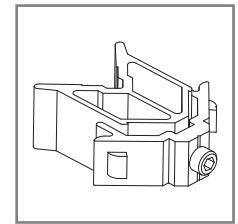

**30 96 00 05**

Esquadro interior aro fixo porta  
Escuadra interior marco porta

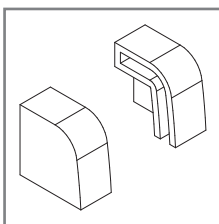

**30 96 00 12**

Jogo tampas condensação  
Juego topes condensación

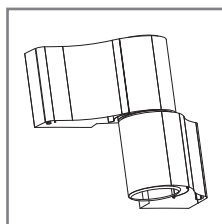

**30 96 00 17/21**

Dobradiça com ressalto branco/preto  
Bisagra con ressalto blanco/negro

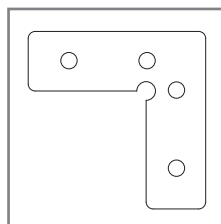

**30 96 00 22**

Esquadro alinhamento  
Escuadra alineamiento

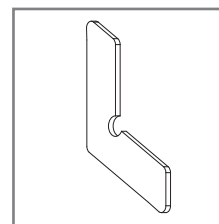

**30 96 00 23**

Esquadro alinhamento aro fixo  
Escuadra alineamiento marco

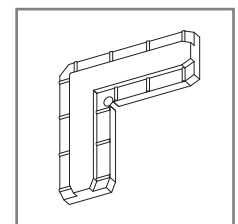

**30 96 00 43**

Esquadro alinhamento  
Escuadra alineamiento

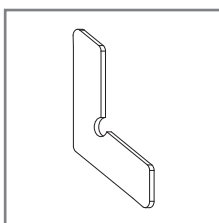

**30 96 00 63**

Esquadro alinhamento  
Escuadra alineamiento

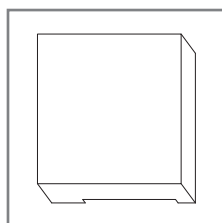

**30 96 10 01**

Calço para vidro aro móvel  
Calzo para vidrio hoja

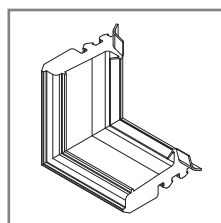

**30 96 10 07**

Canto vulcanizado Termo-Isolante  
Angulo vulcanizado Termo Aislante

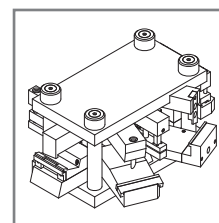





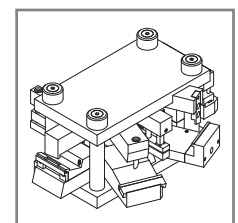







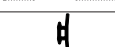









**33 98 22 99**













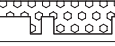
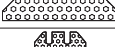

Cunho API  
Troquel API



**33 98 25 99**

Cunho API - Folha Oculta PassiveHouse  
Troquel API - Hoja Oculta PassiveHouse

REFERÊNCIA • REFERENCIA	DESENHO • DISEÑO	DESCRIÇÃO • DESCRIPCIÓN
30 00 95 15		Junta de vedação curta AZ-79 • Junta de estanqueidad AZ-79
30 60 00 14		Perfil pelúcia metálica 18 mm preto • Perfil burlete metálico 18 mm negro
30 60 00 17		Junta exterior vidro plana 2 mm preto • Junta exterior vidrio plana 2 mm negro
30 60 00 18		Junta isolante • Junta Aislante
30 60 00 21		Junta acústica • Junta acústica
30 60 40 00		Junta central Termo-Acustica Api Passive House • Junta central Termo-Acustica Api Passive House
30 60 40 03		Junta para Inversor Api Passive House • Junta para Inversor Api Passive House
30 70 16 30		Junta central termo isolante C16 • Junta Central termo aislante C16
30 92 04 70		Espuma isolante • Espuma aislante
30 93 00 60		Junta exterior de vidro (4 mm) preto • Junta exterior de vidrio (4 mm) negro
30 93 00 61		Junta de vedação exterior (2 mm) preto • Junta de estanqueidad exterior (2 mm) negro
30 93 00 62		Junta exterior plana para vidro (4 mm ) preto • Junta exterior plana para vidrio (4 mm) negro
30 93 00 65		Junta interior para vidro (5 mm) preto • Junta interior para vidrio (5 mm) negro
30 93 00 66		Junta interior para vidro (4 mm) preto • Junta interior para vidrio (4 mm) negro
30 93 00 67		Junta interior para vidro (2 mm) preto • Junta interior para vidrio (2 mm) negro
30 93 00 68		Junta interior para vidro (6/7 mm) preto • Junta interior para vidrio (6/7 mm) negro
30 93 00 69		Junta interior para vidro (8/9 mm) preto • Junta interior para vidrio (8/9 mm) negro
30 93 00 75		Junta exterior F.O. AJi / API preto • Junta exterior F.O. AJi / API negro
30 93 00 82		Junta vedação inferior AZ-79 • Junta estanqueidad inferior AZ-79
30 93 01 20		Junta interior • Junta interior
30 94 01 46		Junta para AZ-22 • Junta para AZ-22
30 95 00 10		Pelúcia 7x9 mm • Burlete 7x9 mm
30 96 00 18		Junta interior (abertura projectante/deslizante) • Junta interior (apertura proyectante/deslizante)
30 96 10 06		Junta central termo isolante AKi/API • Junta central termo aislante AKi/API

REFERÊNCIA • REFERENCIA	THERMOPROFILE (Baguetes de 70cm) THERMOPROFILE (Baguetes de 70cm)	DESCRIÇÃO • DESCRIPCIÓN
30 99 00 01		APi-01; APi-03; APi-04; APi-05; APi-07; APi-21; APi-33; APi-35; APi-61; APi-65; APi-67; APi-71; APi-73; APi-74; APi-75; APi-76; APi-80; APi-81; APi-83; APi-86; APi-87; APi-88; APi-89; APi-91; APi-95
30 99 00 02		APi-01; APi-03; APi-04; APi-05; APi-07; APi-21; APi-33; APi-35; APi-61; APi-65; APi-67; APi-71; APi-73; APi-74; APi-75; APi-76; APi-80; APi-81; APi-83; APi-86; APi-87; APi-88; APi-89; APi-91; APi-95
30 99 00 06		APi-01; APi-03; APi-06; APi-08; APi-12; APi-20; APi-33; APi-35; APi-68; APi-73; APi-74; APi-75; APi-76; APi-79; APi-80; APi-81; APi-86; APi-87; APi-88; APi-89; APi-91; APi-92; APi-93; APi-94
30 99 00 07		APi-05; APi-07; APi-10; APi-36; APi-61; APi-72; APi-83; APi-84; APi-85; APi-90; APi-95
30 99 00 10		APi-06; APi-08; APi-68; APi-79; APi-92; APi-93; APi-94
30 99 00 13		APi-10; APi-36; APi-72; APi-84; APi-85; APi-90
30 99 00 22		APi-105; APi-117; APi-161; APi-183
30 99 00 23		APi-105; APi-117; APi-161; APi-183
30 99 00 24		APi-105; APi-117; APi-161; APi-183; S-33
30 99 00 25		APi-110; APi-184; APi-136; S-34
30 99 00 26		APi-115; APi-122; APi-129; APi-185; APi-190; APi-172
30 99 00 29		APi-103; APi-176; APi-180; APi-174; APi-135; APi-133; APi-191; APi-175; APi-192; APi-194
30 99 00 30		APi-103; APi-176; APi-180; APi-174; APi-135; APi-133; APi-191; APi-175; APi-101; APi-44; APi-102
30 99 00 31		APi-106; APi-192; APi-194;
30 99 00 32		APi-78;
30 99 00 33		APi-78

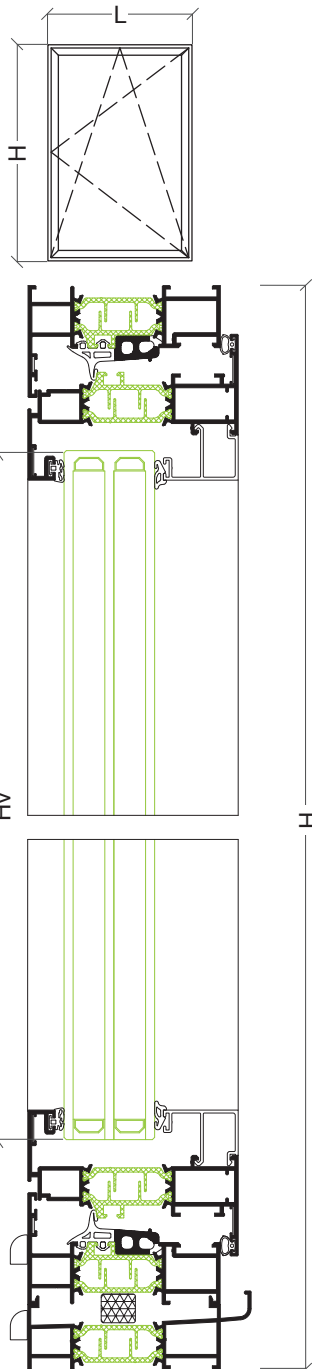
**Janela 1 folha abrir e oscilo-batente • Ventana 1 hoja practicable y oscilobatiente**

**PERFIS • PERFIS**

DESENHO • DESEÑO	REF.	DESCRIÇÃO • DESCRIPCIÓN	CORTE CORTE	QUANTIDADE CANTIDAD	MEDIDAS • MEDIDA
	API-03	Aro fixo Marco ventana		2	L
			2	H-28.5 mm	
	API-61	Aro móvel Hoja ventana		2	L-43 mm
			2	H-71.5 mm	
	-	Bite Junquillo		2	L-132 mm
			2	H-200.5 mm	
	AX-19	Vareta Pletina falleba		varias	-
	API-71	Soleira Condensación		1	L

**ACESSÓRIOS E JUNTAS • ACCESORIOS Y JUNTAS**

REF.	DESCRIÇÃO • DESCRIPTION	QUANTIDADE • CANTIDAD	
		ABRIR PRATICABLE	OSCILO-BATENTE OSCILOBATIENTE
30 96 00 04	Esquadro interior • Escuadra interior		8
30 60 00 01	Esquadro exterior • Escuadra exterior		8
30 96 00 23	Esquadro alinhamento fixo • Escuadra alineamiento fijo		4
30 96 00 22	Esquadro alinhamento móvel • Escuadra alineamiento móvil		8
30 96 10 01	Calço para vidro • Calzo para vidrio	4	6
30 92 12 64/65	Cremona OB • Manilla OB	-	1
30 92 12 88/89	Cremona batente branco/preto • Manilla abisagrada blanco/negro	1	-
-	Ferragem oscilo-batente • Herraje oscilobatiente	-	1
30 92 12 92	Kit batente • Kit abisagrada	1	-
30 92 12 94/95	Dobradiça branco/preto • Bisagra blanco/negro	2 ou mais	-
30 92 13 06	Ponto de fecho regulável (H > 1100 mm) • Punto de cierre regulable (H > 1100 mm)	1	-
30 92 02 60	Apoio da folha • Apoyo hoja	1	-
30 92 01 02	Goteira com válvula preto • Vierendeaguas con válvula negro	4 ou mais	4 u más
30 96 00 12	Jogo topos condensação • Juego topos condensación		1
30 92 04 70	Espuma isolante • Espuma aislante		L
30 93 01 20	Junta interior • Junta interior		2L+2H
30 96 10 06	Junta central termo isolante • Junta central termo aislante		2L+2H
30 96 10 07	Canto vulcanizado • Angulo vulcanizado		4
-	Junta para vidro (exterior) • Junta para vidrio (exterior)		2L+2H
-	Junta para vidro (interior) • Junta para vidrio (interior)		2L+2H

**VIDRO • VIDRIO**

Hv = H-174 mm	Lv = L-146 mm
---------------	---------------

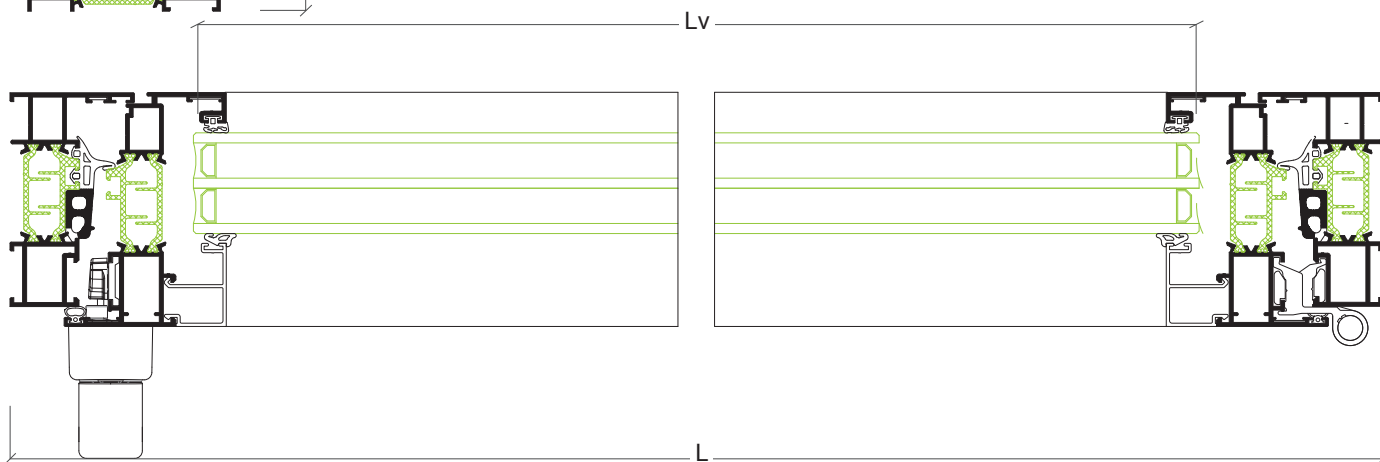

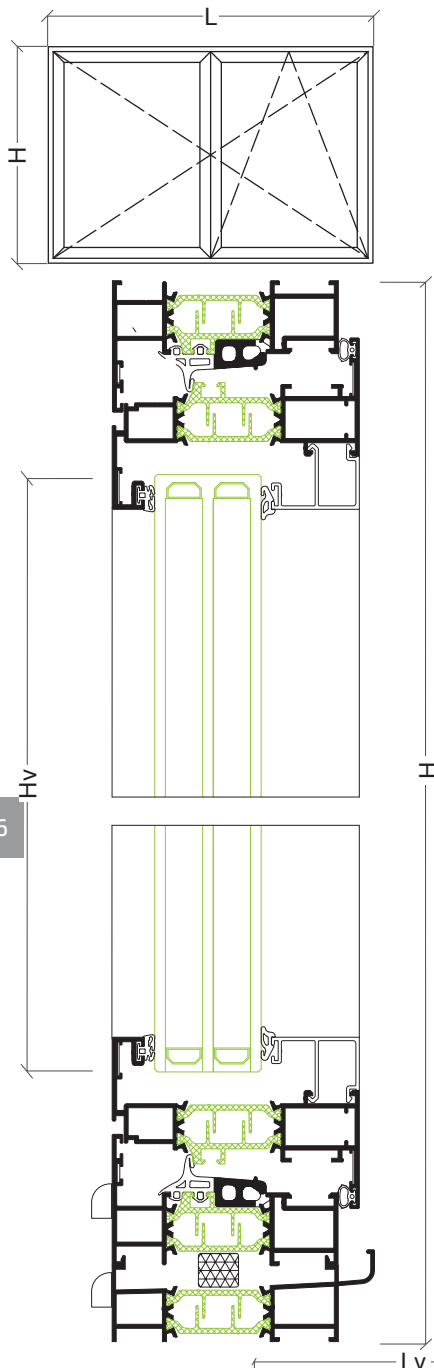
**Janela 2 folhas abrir e oscilo-batente • Ventana 2 hojas practicable y oscilobatiente**

**PERFIS • PERFIS**

DESENHO • DESEÑO	REF.	DESCRIÇÃO • DESCRIPCIÓN	CORTE CORTE	QUANTIDADE CANTIDAD	MEDIDAS • MEDIDA
	API-03	Aro fixo Marco ventana		2	L
			2	H-28.5 mm	
	API-61	Aro móvel Hoja ventana		2	L/2-24 mm
			2	H-71.5 mm	
	-	Bite Junquillo		4	L/2-113 mm
	-	Bite Junquillo		4	H-200.5 mm
	AX-19	Vareta Pletina falleba		varias	-
	API-04	Inversor Inversor		1	H-139.5 mm
	KL-04	Perfil tampa Tapón		1	H-139.5 mm
	API-71	Soleira Condensación		1	L

**ACESSÓRIOS E JUNTAS • ACCESORIOS Y JUNTAS**

REF.	DESCRIÇÃO • DESCRIPTION	QUANTIDADE • CANTIDAD	
		ABRIR PRATICABLE	OSCILO-BATENTE OSCILOBATIENTE
30 96 00 04	Esquadro interior • Escuadra interior	12	
30 60 00 01	Esquadro exterior • Escuadra exterior	12	
30 96 00 23	Esquadro alinhamento fixo • Escuadra alineamiento marco	4	
30 96 00 22	Esquadro alinhamento móvel • Escuadra alineamiento hoja	16	
30 96 10 01	Calço para vidro • Calzo para vidrio	8	12
30 92 12 64/65	Cremona OB • Manilla OB	---	1
---	Ferragem oscilo-batente • Herraje oscilobatiente (ver páginas 27/28)	---	1
30 92 12 92	Kit batente • Kit abisagrada	1	---
30 92 01 20	Jogo fecho • Juego cierre C.E.	1	---
30 92 12 94/95	Dobradiça branco/preto • Bisagra blanco/negro	4 ou mais	---
30 92 13 06	Ponto de fecho regulável • Punto de cierre regulable (H > 1100 mm)	1	---
30 92 02 60	Apoio folha • Apoyo hoja	1	---
30 70 00 12	Conjunto tampas inversor • Conjunto topes inversor	1	
30 96 10 06	Junto central termo isolante • Junta central termo aislante	2L+3H	
30 96 10 07	Canto vulcanizado • Angulo vulcanizado	4	
30 92 01 02	Goteira com válvula preto • Vierendeaguas con válvula negro	4 ou mais	
30 96 00 12	Jogo topos condensação • Juego topes condensación	1	
30 92 04 70	Espuma isolante • Espuma aislante	L	
30 93 01 20	Junta interior • Junta interior	2L+4H	
---	Junta para vidro (exterior) • Junta para vidrio (exterior)	2L+4H	
---	Junta para vidro (interior) • Junta para vidrio (interior)	2L+4H	

**VIDRO • VIDRIO**

Hv = H-174 mm	Lv = L/2-127 mm
---------------	-----------------

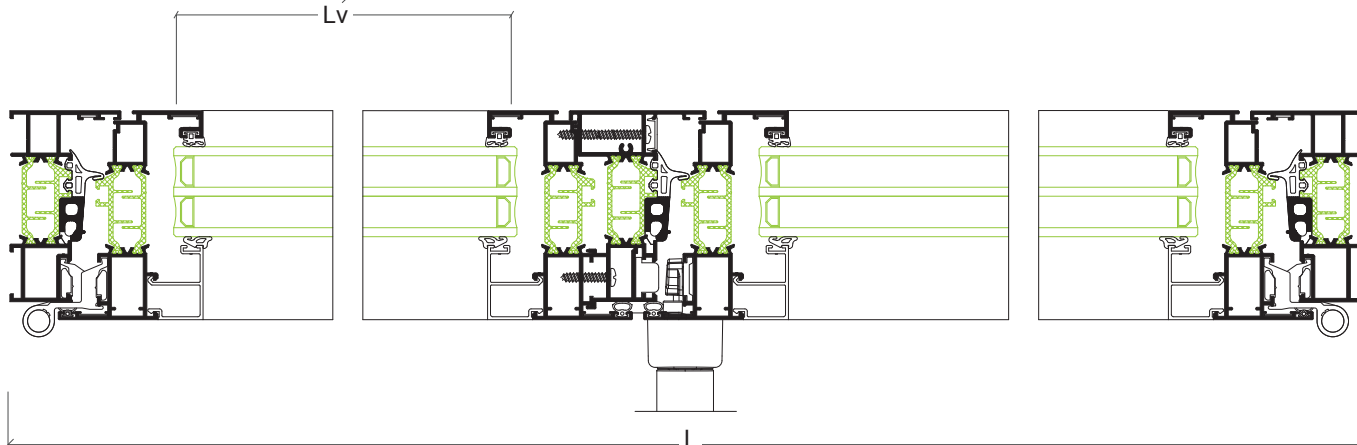

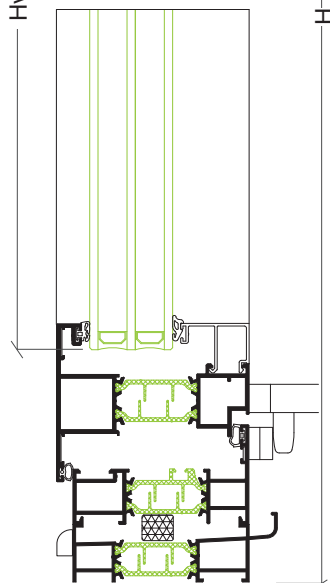
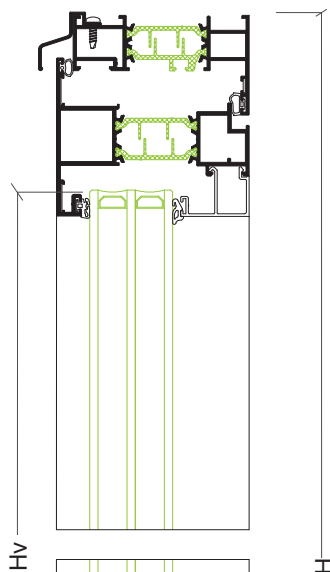
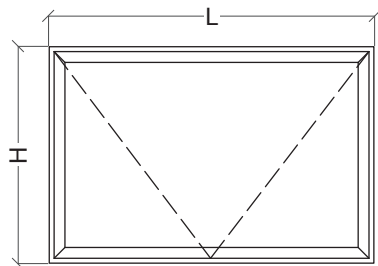
**Janela projectante • Ventana proyectante**

**PERFIS • PERFIS**

DESENHO • DESEÑO	REF.	DESCRIÇÃO • DESCRIPCIÓN	CORTE CORTE	QUANTIDADE CANTIDAD	MEDIDAS • MEDIDA
	API-03	Aro fixo Marco ventana		2	L
			2	H-28.5 mm	
	API-95	Aro móvel Hoja ventana		2	L-43 mm
			2	H-71.5 mm	
	---	Bite Junquillo		2	L-159.5 mm
	2		H-228 mm		
	API-71	Soleira condensação Condensación		1	L
	AXI-45	Pingadeira projectante Vieriteguas proyectante		1	L
	AXI-32	Complemento projectante Complemento proyectante		1	según medida del Compasso según medida del Compás

**ACESSÓRIOS E JUNTAS • ACCESORIOS Y JUNTAS**

REF.	DESCRIÇÃO • DESCRIPTION	QUANTIDADE CANTIDAD
30 96 00 04	Esquadro interior • Escuadra interior	4
30 60 00 01	Esquadro exterior • Escuadra exterior	4
30 96 00 23	Esquadro alinhamento fixo • Escuadra alineamiento fijo	4
30 92 01 35	Esquadro alinhamento móvel • Escuadra alineamiento móvil	8
30 96 00 06	Esquadro interior • Escuadra interior	4
30 96 00 07	Esquadro exterior • Escuadra exterior	4
30 96 10 01	Calço para vidro • Calzo para vidrio	4
30 96 06 10 ou 11	Puxador de lingueta • Manilla de lingueta	2
---	Jogo compasso projetante • Juego compás proyectante	1
30 92 01 02	Goteira com valvula preta • Vieriteguas con válvula negro	2 u más
30 96 00 12	Jogo topos condensação • Juego topos condensación	1
30 92 04 70	Espuma isolante • Espuma aislante	L
30 93 01 20	Junta exterior • Junta exterior	2L+2H
30 96 00 18	Junta interior projectante deslizante • Junta interior proyectante deslizante	2L+2H
---	Junta para vidro (exterior) • Junta para vidrio (exterior)	2L+2H
---	Junta para vidro (interior) • Junta para vidrio (interior)	2L+2H

**VIDRO • VIDRIO**

Hv = H-202 mm	Lv = L-173 mm
---------------	---------------

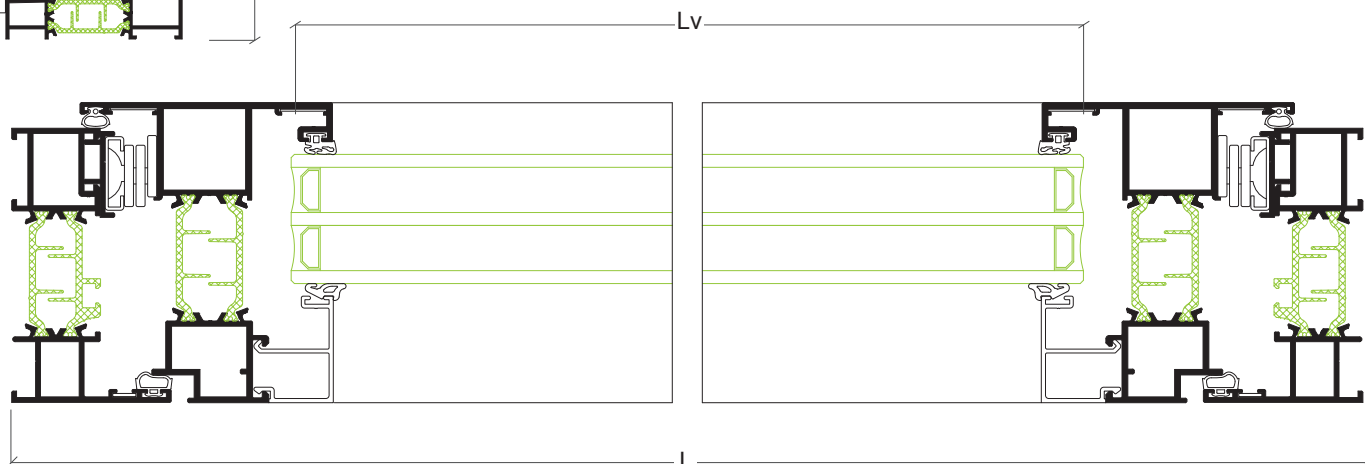

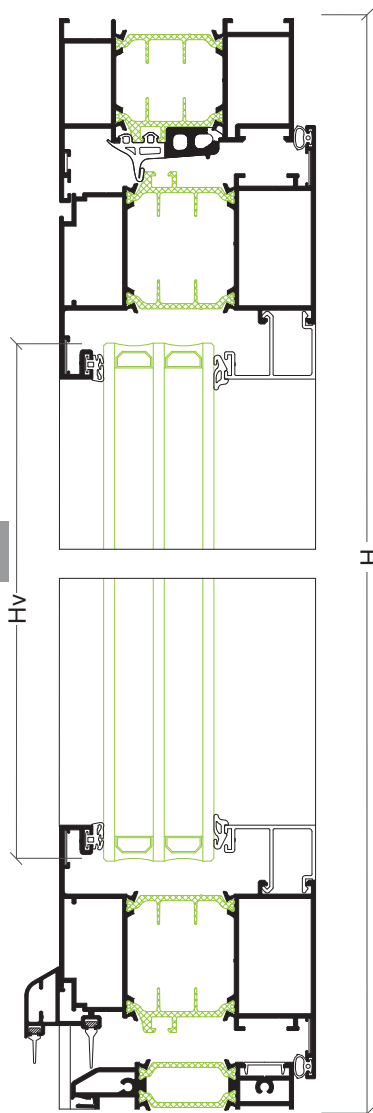
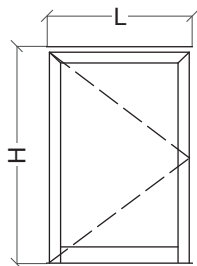
**Porta 1 folha • Puerta 1 hoja**

**PERFIS • PERFIS**

DESENHO • DISEÑO	REF.	DESCRIÇÃO • DESCRIPCIÓN	CORTE CORTE	QUANTIDADE CANTIDAD	MEDIDAS • MEDIDA
	API-08	Aro fixo Marco puerta		1	L
				2	H
	API-36	Aro móvel Hoja puerta		2	L-78 mm
				2	H-50 mm
	---	Bite Junquillo		2	L-222 mm
				2	H-234 mm
	API-63	Soleira Solape inferior puerta		1	L-80.5 mm
	AZ-79	Pingadeira Vieriteaguas puerta		1	L-135 mm
	KL-04	Perfil tampa Tapón		1	L-90 mm

**ACESSÓRIOS E JUNTAS • ACCESORIOS Y JUNTAS**

REF.	DESCRIÇÃO • DESCRIPTION	QUANTIDADE CANTIDAD
30 96 00 05	Esquadro interior • Escuadra interior	2
30 60 00 02	Esquadro exterior • Escuadra exterior	2
30 60 00 05	Esquadro interior móvel • Escuadra interior hoja	4
30 60 00 04	Esquadro exterior móvel • Escuadra exterior hoja	4
30 96 00 23	Esquadro alinhamento fixo • Escuadra alineamiento marco	2
30 96 00 22	Esquadro alinhamento móvel • Escuadra alineamiento hoja	8
30 96 10 01	Calço para vidro • Calzo para vidrio	4
30 92 22 88 ou 89	Dobradiça 2 abas porta • Bisagra 2 cuerpos puerta	2
30 92 05 10	Fechadura 3 pontos • Cierre 3 puntos	1
30 92 13 00 ou 01	Puxador duplo • Manilla doble	1
30 92 13 02	Perno • Perno	1
30 92 22 85 ou 86	Escudo para canhão • Contracierre para bombillo	1
30 92 13 03	Canhão • Bombillo cierre	1
30 93 01 20	Junta interior • Junta interior	2L+2H
30 96 10 06	Junta central • Junta central	L+2H
30 96 10 07	Canto vulcanizado • Angulo vulcanizado	2
30 92 05 00	Conjunto topos pingadeira • Conjunto topos vieriteaguas	1
30 00 95 15	Junta inferior curta • Junta inferior curta	L
30 93 00 82	Junta inferior • Junta inferior	L
---	Junta para vidro (exterior) • Junta para vidrio (exterior)	2L+2H
---	Junta para vidro (interior) • Junta para vidrio (interior)	2L+2H

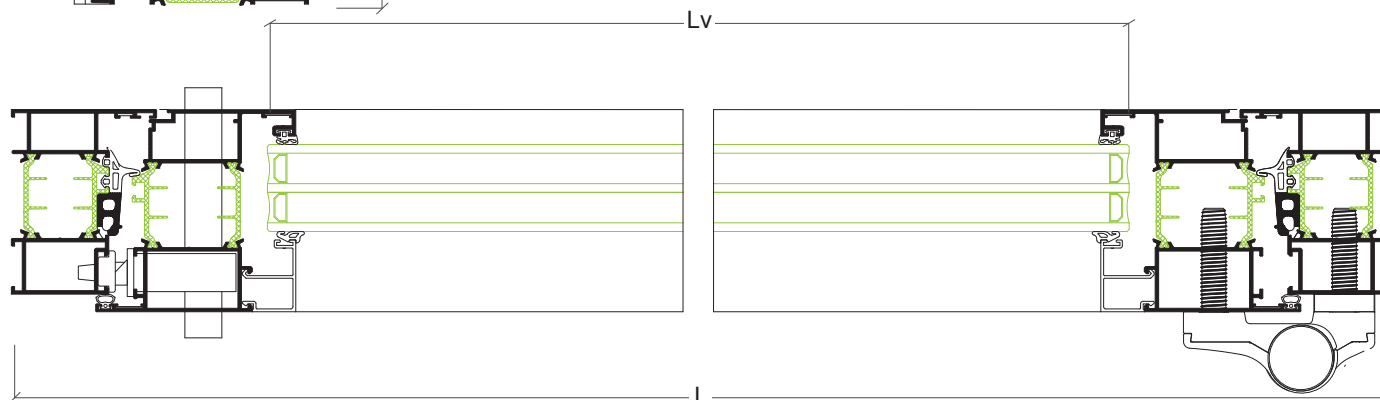

**VIDRO • VIDRIO**

Hv = H-208 mm	Lv = L-236 mm
---------------	---------------



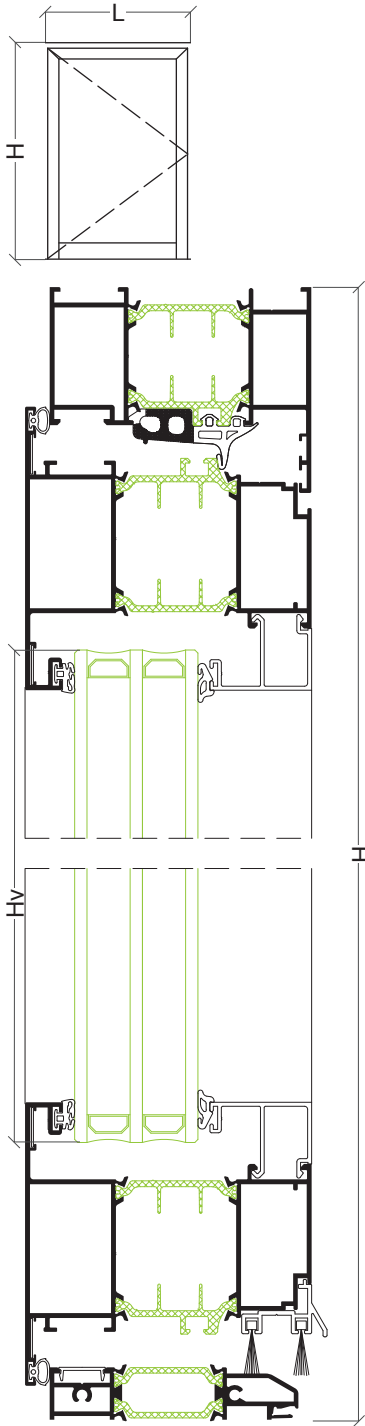

**Porta 1 folha abertura exterior • Puerta 1 hoja apertura exterior**

**PERFIS • PERFIS**

DESENHO • DESEÑO	REF.	DESCRIÇÃO • DESCRIPCIÓN	CORTE CORTE	QUANTIDADE CANTIDAD	MEDIDAS • MEDIDA
	API-08	Aro fixo Marco puerta		1	L
				2	H
	API-72	Aro móvel Hoja puerta		2	L-78 mm
				2	H-50 mm
	---	Bite Junquillo		2	L-222 mm
				2	H-234 mm
	API-63	Soleira Solape inferior puerta		1	L-80.5 mm
	AJi-62	Pingadeira Vieriteaguas puerta		1	---
	KL-04	Perfíl tampa Tapón		1	L-90 mm

**ACESSÓRIOS E JUNTAS • ACCESORIOS Y JUNTAS**

REF.	DESCRIÇÃO • DESCRIPTION	QUANTIDADE CANTIDAD
30 96 00 05	Esquadro interior • Escuadra interior	2
30 60 00 02	Esquadro exterior • Escuadra exterior	2
30 60 00 05	Esquadro interior móvel • Escuadra interior hoja	4
30 60 00 04	Esquadro exterior móvel • Escuadra exterior hoja	4
30 96 00 23	Esquadro alinhamento fixo • Escuadra alineamiento marco	2
30 96 00 22	Esquadro alinhamento móvel • Escuadra alineamiento hoja	8
30 96 10 01	Calço para vidro • Calzo para vidrio	4
30 92 22 88 ou 89	Dobradiça 2 abas porta • Bisagra 2 cuerpos puerta	2
30 92 05 10	Fechadura 3 pontos • Cierre 3 puntos	1
30 92 13 00 ou 01	Puxador duplo • Manilla doble	1
30 92 13 02	Perno • Perno	1
30 92 22 85 ou 86	Escudo para canhão • Contracierre para bombillo	1
30 92 13 03	Canhão • Bombillo cierre	1
30 93 01 20	Junta interior • Junta interior	2L+2H
30 96 10 06	Junta central • Junta central	L+2H
30 96 10 07	Canto vulcanizado • Angulo vulcanizado	2
30 60 00 13	Conjunto topos AJi-62 • Conjunto topes AJi-62	1
30 60 00 14	Pelúcia preta 18 mm • Burlete negra 18 mm	2L
---	Junta para vidro (exterior) • Junta para vidrio (exterior)	2L+2H
---	Junta para vidro (interior) • Junta para vidrio (interior)	2L+2H

**VIDRO • VIDRIO**

Hv = H-208 mm	Lv = L-236 mm
---------------	---------------

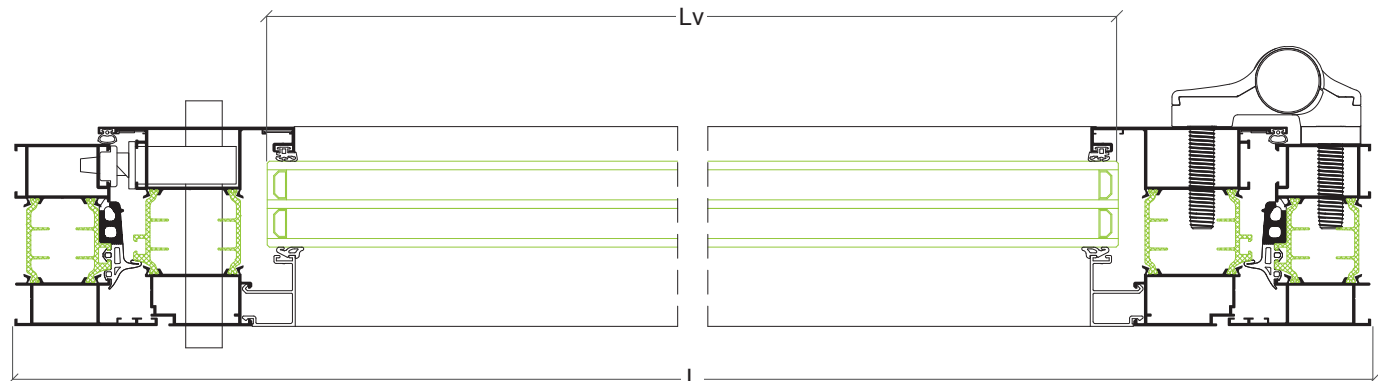

## Porta 2 folhas • Puerta 2 hojas

### PERFIS • PERFIS

DESENHO • DISEÑO	REF.	DESCRIÇÃO • DESCRIPCIÓN	CORTE CORTE	QUANTIDADE CANTIDAD	MEDIDAS • MEDIDA
	APi-08	Aro fixo Marco puerta		1	L
			2	H	
	APi-36	Aro móvel Hoja puerta		2	L/2-41.5 mm
			4	H-44 mm	
	---	Bite Junquillo		4	L/2-185.5 mm
				4	H-258 mm
	APi-04	Inversor Inversor		1	H-78 mm
	KL-04	Perfil tampa Tapón		1	H-78 mm
	APi-12	Travessa Zócalo 124x85mm		2	L/2-176.5 mm
	AJi-82	Bite remate Junquillo solape		2	L/2-185.5 mm
	AZ-60	Pingadeira Vierteaguas		1	L/2-103 mm
			1	L/2-39 mm	
	AZ-61	Suplemento pingadeira Suplemento vierteaguas		2	L/2-226 mm

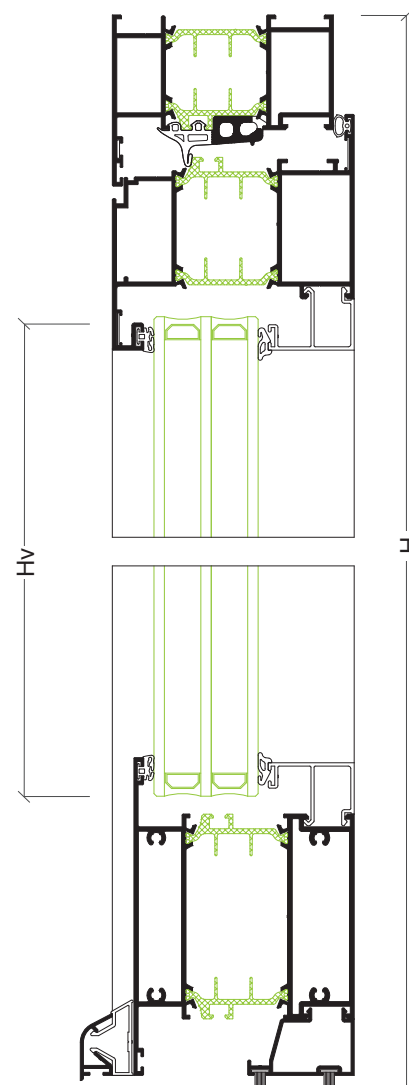
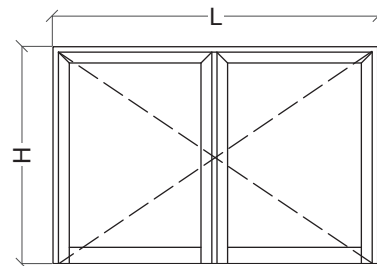

### ACESSÓRIOS E JUNTAS • ACCESORIOS Y JUNTAS

REF.	DESCRIÇÃO • DESCRIPTION	QUANTIDADE CANTIDAD
30 96 00 05	Esquadro interior • Escuadra interior	2
30 60 00 02	Esquadro exterior • Escuadra exterior	2
30 60 00 05	Esquadro interior móvel • Escuadra interior móvil	4
30 60 00 04	Esquadro exterior móvel • Escuadra exterior móvil	4
30 96 00 23	Esquadro alinhamento fixo • Escuadra alineamiento fijo	2
30 96 00 22	Esquadro alinhamento móvel • Escuadra alineamiento móvil	8
30 70 00 12	Conjunto topos inversor • Conjunto topos inversor	1
30 92 22 88 ou 89	Dobradiça 2 abas porta • Bisagra 2 cuerpos puerta	4
30 92 05 10	Fechadura 3 pontos • Cierre 3 puntos	1
30 92 13 00 ou 01	Puxador duplo • Manilla doble	1
30 92 13 02	Perno • Perno	1
30 92 22 85 ou 86	Escudo para canhão • Contracierre para bombillo	E
30 92 13 03	Canhão • Bombillo cierre	1
30 92 00 50	Contra-fecho • Contracierre	1
30 24 30 75	Contra-fecho interior • Contracierre inferior	1
30 92 01 20	Jogo fecho C.E. • Juego cierre C.E.	1
30 93 01 20	Junta interior • Junta interior	L+4H
30 96 10 06	Junta central • Junta central	L+3H
30 96 10 07	Canto vulcanizado • Angulo vulcanizado	2
30 92 05 00	Conjunto topos pingadeira • Conjunto topos vierteaguas	1
30 95 00 10	Pelúcia • Burlete	2L
---	Junta para vidro (exterior) • Junta para vidrio (exterior)	2L+4H
---	Junta para vidro (interior) • Junta para vidrio (interior)	2L+4H

### VIDRO • VIDRIO

Hv = H-232 mm

Lv = L/2-200 mm

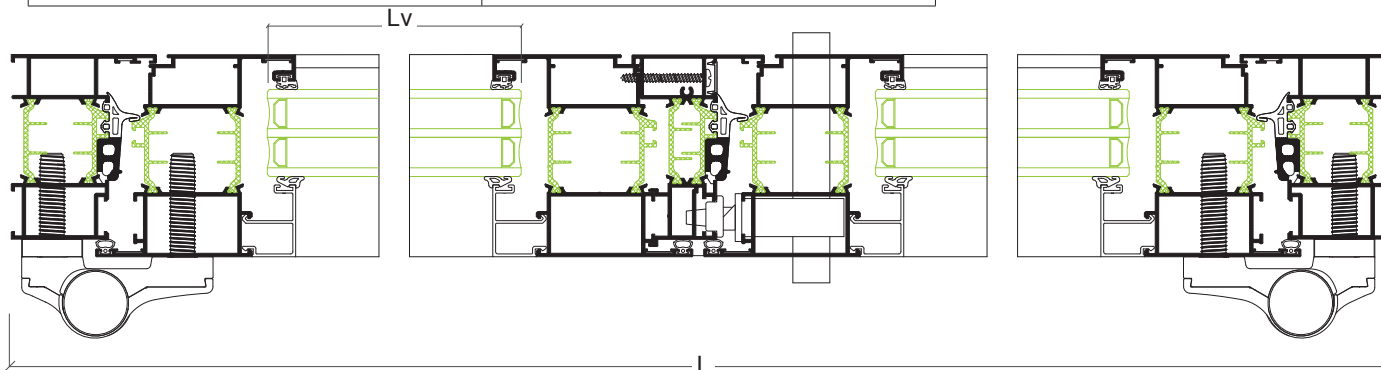

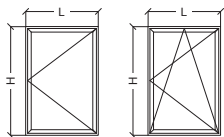
**Janela 1 folha abrir e oscilo-batente oculto • Ventana 1 hoja abrir e oscilo-batente oculto**

**PERFIS • PERFIS**

DESENHO • DISEÑO	REF.	DESCRIÇÃO • DESCRIPCIÓN	CORTE • CORTE	QUANTIDADE CANTIDAD	MEDIDAS • MEDIDA
	API-103	Aro fixo • Marco		2	L
				2	H
	API-78	Aro móvel • Hoja		2	L-43 mm
				2	H-43 mm
	AJi-148	Bite * • Junquillo *		2	*
				2	*

\* cortar juntamente com o aro móvel API-78 • cortar juntamente con hoja API-78

**ACESSÓRIOS E JUNTAS • ACCESORIOS Y JUNTAS**









REF.	DESCRIÇÃO • DESCRIPTION	QUANTIDADE • CANTIDAD	
		ABRIR PRATICABLE	OSCILO-BATENTE OSCILOBATIENTE
30 60 16 01	Esquadro interior fixo • Escuadro interior fijo	4	
30 60 16 09	Esquadro exterior fixo • Escuadro exterior fijo	4	
30 96 00 22	Esquadro alinhamento fixo • Escuadro alineación fijo	4	
30 96 01 15	Esquadro interior móvel • Escuadro interior móvil	4	
30 92 01 35	Esquadro alinhamento móvel • Escuadro alineación móvil	4	
30 60 40 22	Esquadro exterior móvel • Escuadro exterior móvil	4	
-	Cremona • Cremona		1
-	Ferragens Oscilo-batente ocultas • Herrajes Oscilo-batente ocultas	-	1
-	Kit batente 1 folha sem cremone • Kit batente 1 hoja sem cremone	1	-
-	Ponto de fecho suplementar (H>1100mm) • Punto de cierre suplementar (H<1100mm)	1	-
-	Conjunto dobradiças ocultas • Conjunto de dobradiças ocultas	1	-
-	Apoio da folha • Apoyo da hoja	1	-
30 60 40 23	Suporte para vidro • Soporte para vidrio		2
30 94 60 62	Calço inferior para vidro • Calço inferior para vidrio		2
30 92 01 02	Goteira com valvula • Goteira con valvula		2 ou mais
30 60 40 01	Canto vulcanizado • Canto vulcanizado		4
30 93 01 20	Junta interior • Junta interior		2L+2H
30 60 40 00	Junta central • Junta central		2L+2H
-	Junta para vidro (interior) • Junta para vidrio (interior)		2L+2H

**VIDRO COM INTERCALAR TIPO "WARM EDGE" • VIDRIO CON INTERCALAR TIPO "WARM EDGE"**

Hv = H-117 mm	Lv = L-116 mm
---------------	---------------



**Janela 2 folhas abrir e oscilo-batente • Ventana 2 hojas abrir e oscilo-batiente**
**PERFIS • PERFIS**

DESENHO • DESEÑO	REF.	DESCRIÇÃO • DESCRIPCIÓN	CORTE • CORTE	QUANTIDADE • CANTIDAD	MEDIDAS • MEDIDA
	API-103	Aro fixo • <b>Marco</b>		2 2	L H
	API-78	Aro móvel • <b>Hoja</b>		2 4	(L/2)-24mm H-43 mm
	API-44	Inversor • <b>Inversor</b>		1	H - 130mm
	AJi-148	Bite * • <b>Junquillo *</b>		4 4	* *

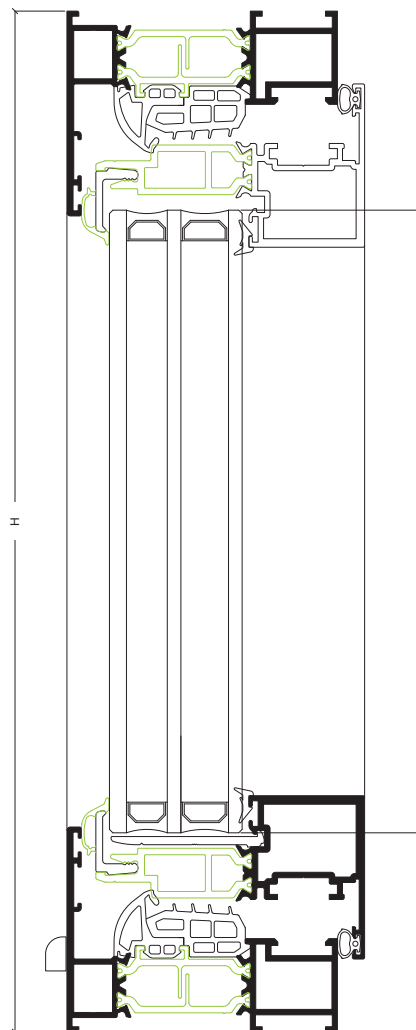
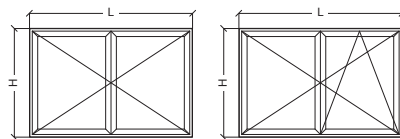

\* cortar juntamente com o aro móvel API-78 • cortar juntamente con marco API-78

**ACESSÓRIOS E JUNTAS • ACCESORIOS Y JUNTAS**

REF.	DESCRIÇÃO • DESCRIPTION	QUANTIDADE • CANTIDAD	
		ABRIR PRATICABLE	OSCILO-BATENTE OSCILOBATIENTE
30 60 16 01	Esquadro interior fixo • <b>Escuadro interior fijo</b>	4	
30 60 16 09	Esquadro exterior fixo • <b>Escuadro exterior fijo</b>	4	
30 96 00 22	Esquadro alinhamento fixo • <b>Escuadro alineación fijo</b>	4	
30 96 10 15	Esquadro interior móvel • <b>Escuadro interior móvil</b>	8	
30 92 01 35	Esquadro alinhamento móvel • <b>Escuadro alineación móvil</b>	8	
30 60 40 22	Esquadro exterior móvel • <b>Escuadro exterior móvil</b>	8	
-	Cremona • <b>Cremona</b>	1	
-	Ferragens Oscilo-batente ocultas • <b>Herrages Oscilo-batiente ocultas</b>	-	1
-	Fechos para a 2ª folha • <b>Cierres para a 2ª Hoja</b>	1	
-	Kit batente 2 folhas sem cremona • <b>Kit batiente 2 hojas s/ cremona</b>	1	-
-	Ponto fecho suplementar (H>1100mm) • <b>Punto de cierre suplementar(H&gt;1100mm)</b>	2	-
-	Conjunto dobradiças ocultas • <b>Conjunto dobradiças ocultas</b>	2	-
-	Apoio da folha • <b>Apoio da hoja</b>	2	1
30 60 40 23	Suporte para vidro • <b>Soporte para vidrio</b>	4	
30 94 60 62	Calço inferior para vidro • <b>Calço inferior para vidrio</b>	4	
30 60 40 05	Conjunto topos inversor • <b>Conjunto topos inversor</b>	1	
30 92 01 02	Goteira com valvula • <b>Goteo con valvula</b>	2 ou mais	
30 60 40 01	Canto vulcanizado • <b>Canto vulcanizado</b>	4	
30 60 40 03	Junta para inversor • <b>Junta para inversor</b>	H	
30 93 01 20	Junta interior • <b>Junta interior</b>	2L+4H	
30 60 40 00	Junta central • <b>Junta central</b>	2L+3H	
-	Junta para vidro (interior) • <b>Junta para vidrio (interior)</b>	2L+4H	

**VIDRO COM INTERCALAR TIPO "WARM EDGE" • VIDRIO CON INTERCALAR TIPO "WARM EDGE"**

Hv = H-117mm	Lv = (L/2) -97mm
--------------	------------------

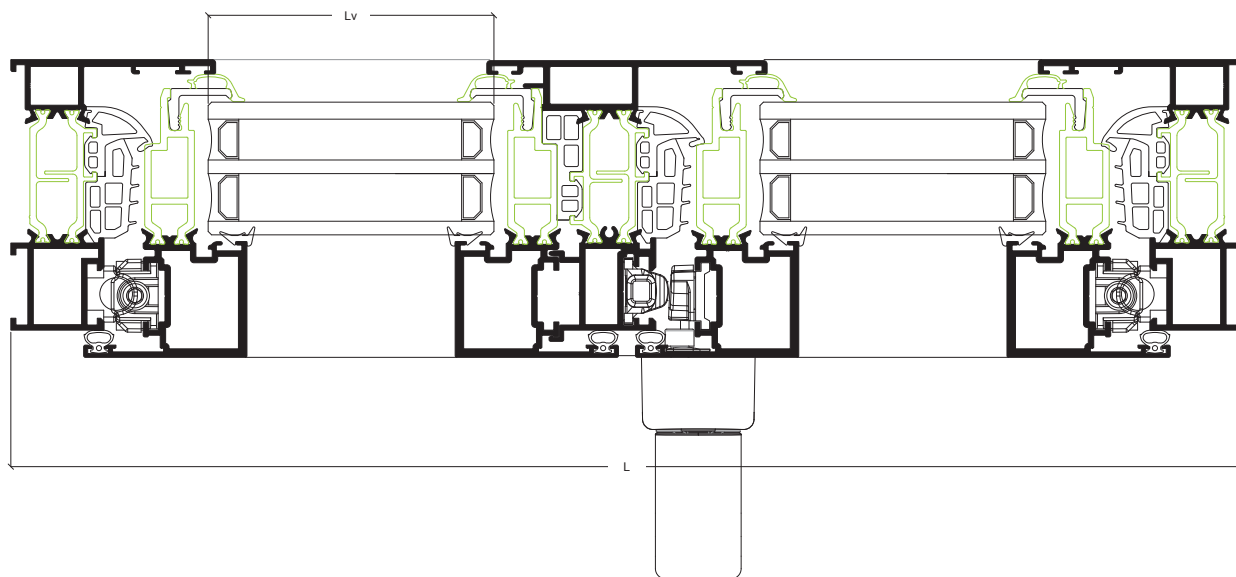

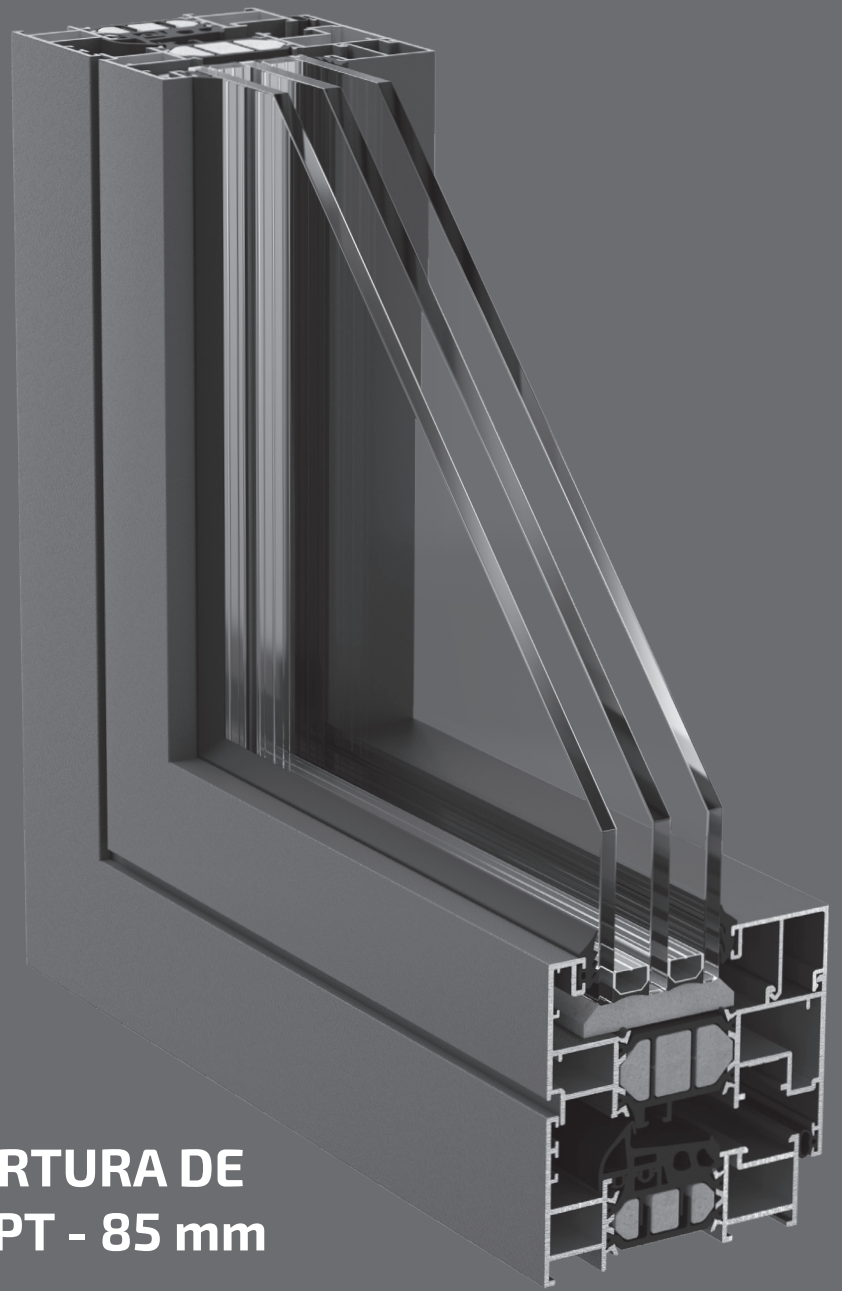

**SISTEMA DE ABERTURA DE  
CANAL 16 COM RPT - 85 mm**

**SISTEMA PRACTICABLE DE  
CANAL 16 CON RPT - 85 mm**

---

**API C.16**

 **anicolor**  
Sistemas de Aluminio

## SISTEMA APi Canal 16

Sistema de batente de canal 16 mm com RPT - 85 mm

### CARACTERÍSTICAS DO SISTEMA

O sistema APi Canal 16 está desenhado com câmara de 16 mm para permitir a aplicação de ferragens especiais com afinação tridimensional para uma maior eficiência em termos de rendimento, desempenho e segurança.

O sistema APi Canal 16 possibilita a execução de 3 versões de caixilharia:

1. linha reta;
2. linha curva;
3. linha oval;

O sistema APi Canal 16 permite a aplicação de vidros duplos ou tripos de alto rendimento de modo a responder aos requisitos de isolamento térmico e acústico, de acordo com a directiva nº 2010/31/EU.

Com um ótimo isolamento térmico aliado à aplicação de um inovador produto designado por ThermoProfile, o Sistema APi proporciona elevadas prestações de conforto e de economia energética.

### PERFIS DE ALUMÍNIO

Perfis com rotura térmica obtida por inserção de varetas isolantes de poliamida tipo ómega de 39 mm reforçadas com 25% de fibra de vidro.

Espessura média dos Perfis de alumínio de 1.7 mm.

### AROS FIXOS

Profundidade dos aros fixos de 85 mm com tripla câmara;

Perfis com rotura térmica obtida através de varetas de poliamida tipo ómega de 39 mm;

Aros fixos com duplo esquadro de aperto rápido e esquadros de alinhamento para montagem a meia esquadria;

Travessas com dupla união para um aperto mais eficaz;

Aros fixos tradicionais para o mercado interno

Aros fixos com clip exterior e aba de remate directa de 25 mm ou 45 mm;

Aros fixos com clip exterior e interior para aplicação de remate de 30, 50 ou 80 mm.

### AROS MÓVEIS

Profundidade dos aros móveis de 93 mm com tripla câmara;

Aros móveis com rotura térmica, obtida através de varetas de poliamida tipo ómega de 39 mm;

Aros móveis com duplo esquadro de aperto rápido e esquadros de alinhamento para montagem a meia esquadria;

Perfil inversor com olhais para uma melhor aplicação do topo inversor.

### DIMENSIONAMENTO E MANOBRABILIDADE

Dimensões mínimas - máximas de folha: 491 mm - 1640 mm (L); 520 mm - 2840 mm (H);

Peso máximo para janelas ou portas de sacada com oscilo-batente até 130 Kg;

Peso máximo para portas de entrada até 160 Kg/folha;

Possibilidades de abertura: fixo, abertura interior 1 ou 2 folhas com ou sem oscilo-batente, basculante, harmónio e oscilo-paralela;

Enchimento para vidro duplo ou triplo de 24 mm a 70 mm para o sistema APi Canal 16;

Três tipos de ferragens especiais para canal 16 com uma afinação tridimensional rápida e cómoda e com um tratamento superficial de alta qualidade:

• Ferragens UniJet C, UniJet D e UniJet CC Oculta.

Estanqueidade assegurada através de juntas em EPDM (exterior e interior com opção de central) para o sistema APi Canal 16, com junta central termo-isolante de bi-material.

Permite abertura com micro-ventilação.

### PERFORMANCES

Sistema certificado por laboratório credenciado, notificado para Ensaio Tipo Inicial (ITT) de acordo com a norma de produto EN 14351-1 para efeitos de Marcação CE.

Categorias alcançadas nos ensaios do sistema APi canal 16:

1. Permeabilidade ao ar: Classe 4 (norma de ensaio EN 1027 e EN 1206)
2. Estanqueidade à água: Classe E1950 (norma de ensaio EN 12208 e EN 1027)
3. Resistência ao vento: Classe C5 (norma de ensaio EN 12210 e EN 12211)

Coefficiente de Transmissão térmica de vão de 2 folhas com 1.20 m x 1.50 m com vidro Ug = 0.5 W/m<sup>2</sup>K, com intercalar efeito "Warm Edge": Uw = 1.10 W/m<sup>2</sup>K

Coefficiente de atenuação acústica de vão de 2 folhas: Rw (C; Ctr) = 42 dB (-1; -3)

Zonas de aplicação RCCTE (em função do valor Ug): I1, I2, I3, V1, V2, V3.

## SISTEMA APi Canal 16

Sistema practicable de canal 16mm con RPT - 85 mm

### CARACTERÍSTICAS DEL SISTEMA

El sistema APi Canal 16 está diseñado con cámara de 16 mm para permitir la aplicación de herrajes especiales con afinación tridimensional para una mayor eficiencia en términos de rendimiento, desempeño y seguridad.

El sistema APi Canal 16 posibilita la ejecución de 3 versiones de carpintería:

1. línea reta;
2. línea curva;
3. línea oval;

El sistema APi Canal 16 permite la aplicación de vidrios dobles u triples de alto rendimiento por forma a responder a los requisitos de aislamiento térmico y acústico, de acuerdo con la directiva nº 2010/31/EU.

Con un óptimo aislamiento térmico aliado a la aplicación de un innovador producto llamado ThermoProfile, el Sistema APi canal 16 proporciona elevadas prestaciones de confort y de economía energética.

### PERFILES DE ALUMINIO

Los perfiles de aluminio son extruidos en aleación de aluminio 6060 para arquitectura de acuerdo con la norma NP EN 12020-02.

Perfiles con rotura térmica obtenida por inserción de varillas aislantes de poliamida tipo ómega de 39 mm reforzadas con 25% de fibra de vidrio.

Espesor medio de los perfiles de aluminio de 1,7 mm.

### MARCOS

Profundidad de los marcos de 85 mm con triple cámara;

Perfiles con rotura térmica mientras varillas de poliamida tipo ómega de 39 mm;

Marcos con doble escuadra de rápido apriete y escuadras de alineamiento para montaje a englete;

Travesaños con doble unión para un apriete más eficaz;

Marcos rústicos;

Marcos con clip exterior y solape directa de 25 mm ou 45 mm;

Marcos con clip exterior e interior para aplicación de solape de 30, 50 u 80 mm.

### HOJAS

Profundidad de las hojas de 93 mm con triple cámara;

Hojas con rotura térmica, obtenida mientras varillas de poliamida tipo ómega de 39 mm;

Hojas con doble escuadra de rápido apriete y escuadras de alineamiento para montaje a englete;

Perfil inversor con agujero para una mejor aplicación del tope inversor.

### DIMENSIONAMIENTO Y MANIOBRABILIDAD

Dimensiones mínimas - máximas da hoja: 491 mm - 1640 mm (L); 520 mm - 2840 mm (H);

Peso máximo para ventanas u puertas de balconera con oscilobatiente hasta 130 Kg;

Peso máximo para puertas de entrada hasta 160 Kg/hoja;

Possibilidades de abertura: fijo, practicable interior 1 u 2 hojas con u sin oscilobatiente, abatible, plegable y oscilo-paralela;

Acristalamiento para doble u triple vidrio de 24 mm a 70 mm;

Tres tipos de herrajes especiales para canal 16 con una afinación tridimensional rápida y cómoda y con un tratamiento superficial de alta calidad:

• Herrajes UniJet C, UniJet D y UniJet CC Oculta.

Estanqueidad asegurada mientras juntas en EPDM (exterior e interior con la opción de central), con junta central termo-aislante de bi-material.

Permite apertura con micro-ventilación.

### ENSAYOS

Sistema certificado por laboratório credenciado, notificado para Ensayos Tipo Inicial (ITT) de acuerdo con la norma de producto EN 14351-1:2006+A1:2011 para efectos de Marcado CE.

Categorias alcanzadas en los ensayos del sistema APi Canal 16:

1. Permeabilidad al aire: Clase 4 (normas de ensayo EN 10207 y EN 1206)
2. Estanqueidad al agua: Clase E1950 (normas de ensayo EN 12208 y EN 1027)
3. Resistencia al viento: Clase C5 (normas de ensayo EN 12210 y EN 12211)

Coefficiente de transmisión térmica de hueco de 2 hojas, Sistema APi Canal 16, con 1.20m x 1.50m con vidrio triple Ug = 0.5 W/m<sup>2</sup>K, con intercalar efecto "Warm Edge": Uw = 1.10 W/m<sup>2</sup>K

Coefficiente de atenuación acústica de hueco de 2 hojas: Rw (C; Ctr) = 42 dB (-1; -3)

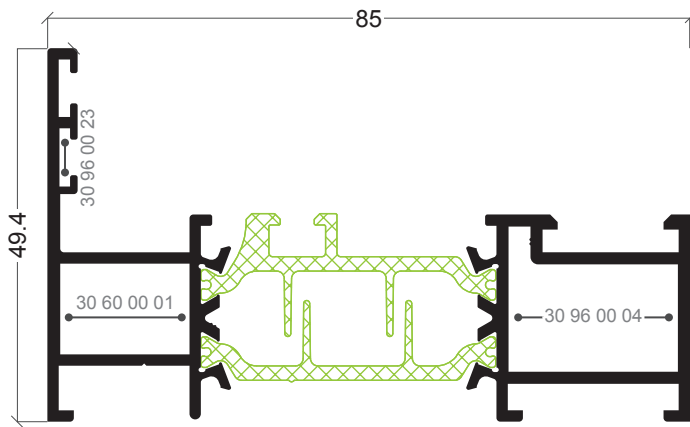

**APi-03**

Aro fixo  
Marco ventana

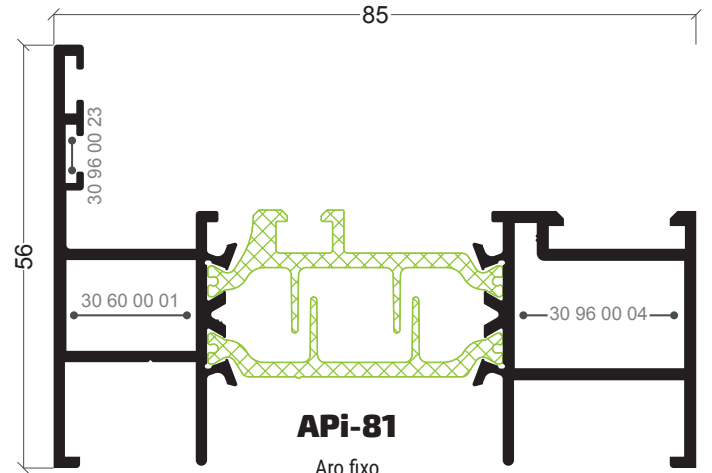

**APi-81**

Aro fixo  
Marco ventana intermedio

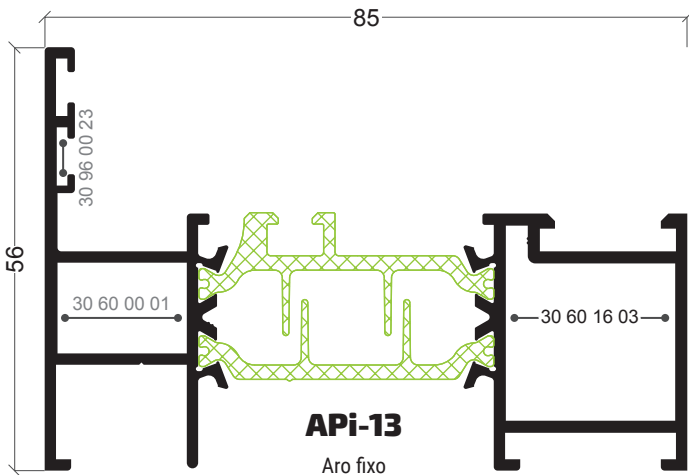

**APi-13**

Aro fixo  
Marco puerta intermedio

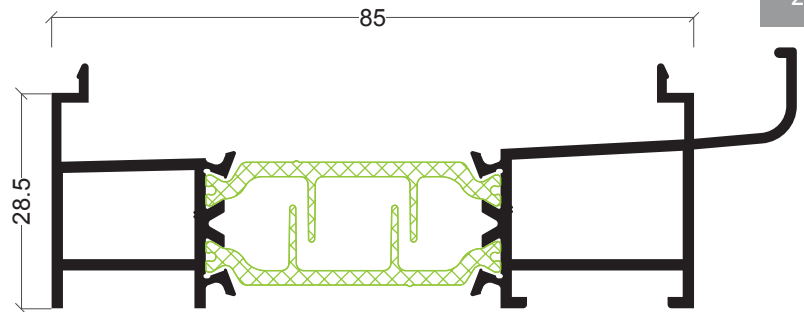

**APi-71**

Soleira condensação  
Condensación

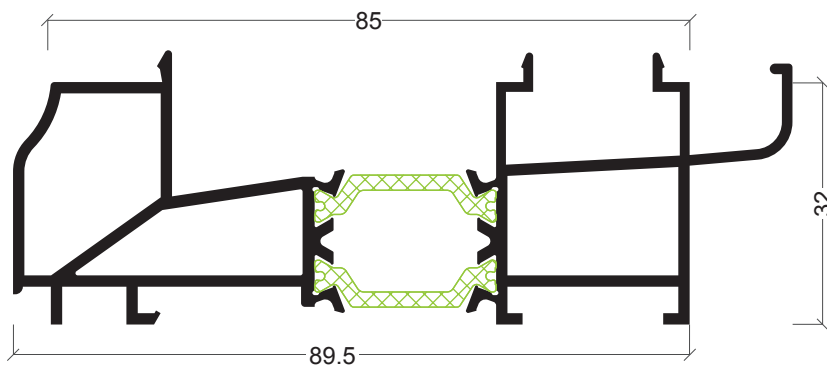

**ARi-56**

Soleira condensação  
Condensación

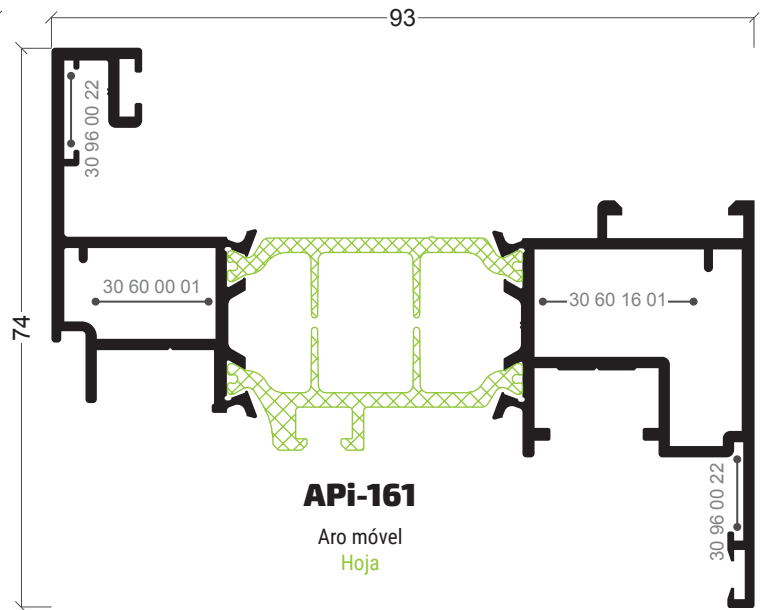
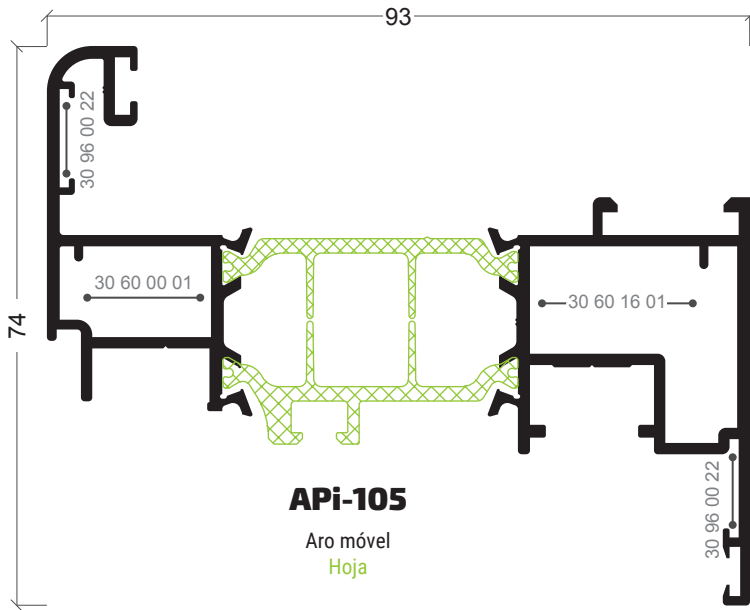

246

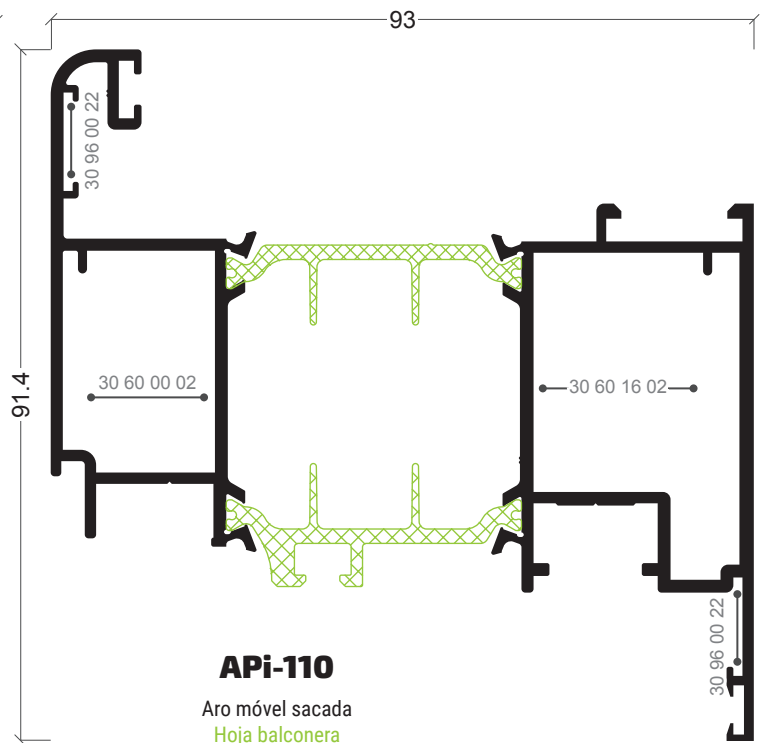
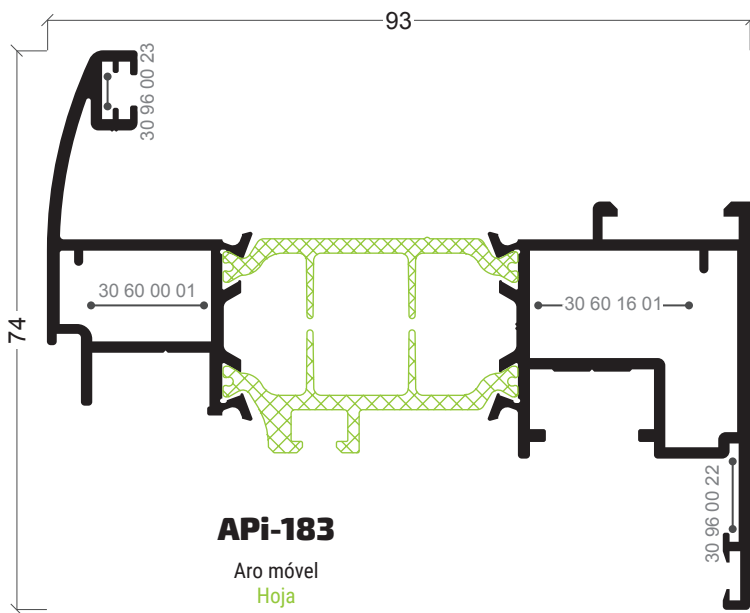



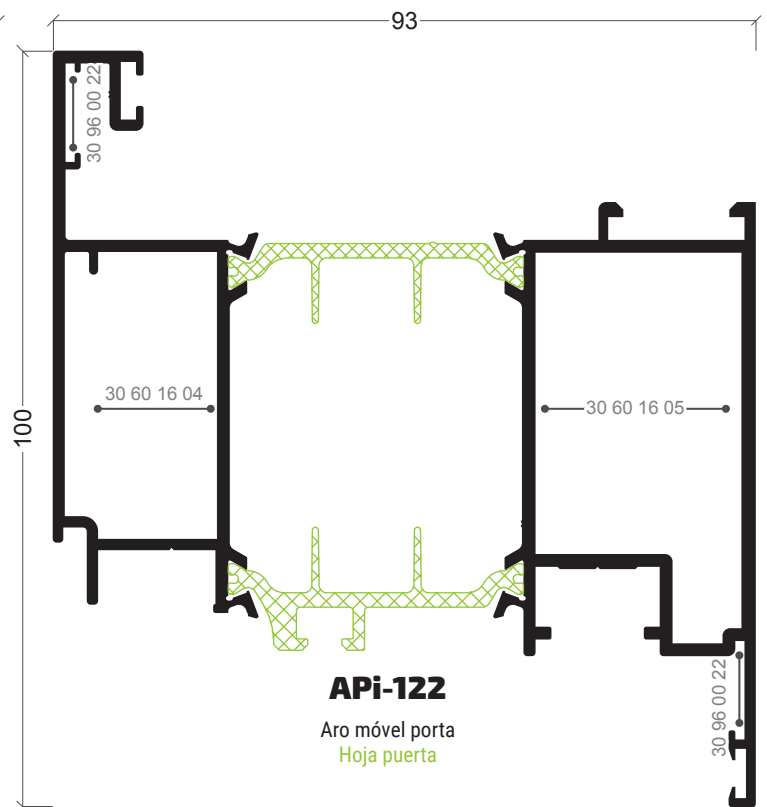
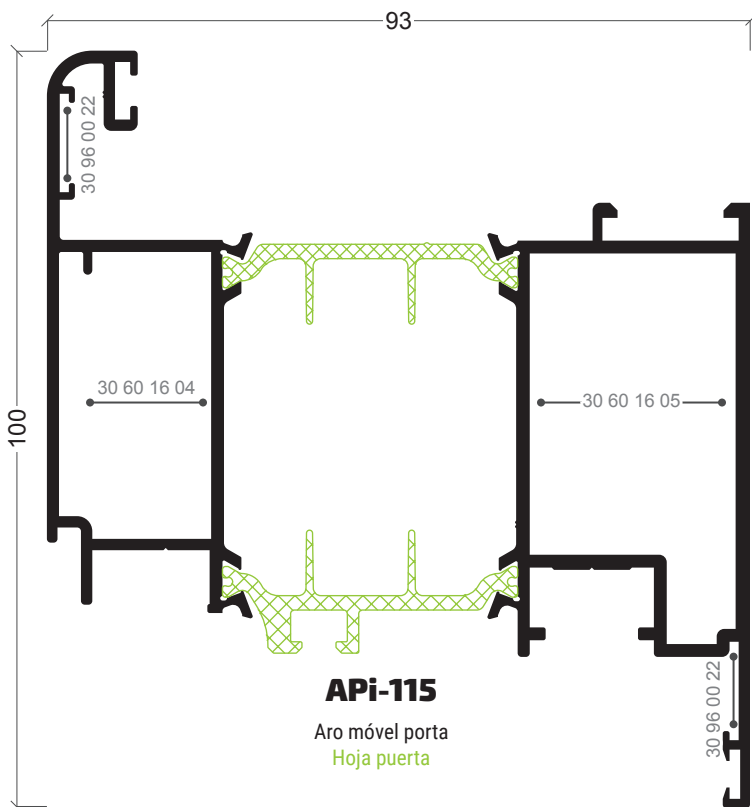
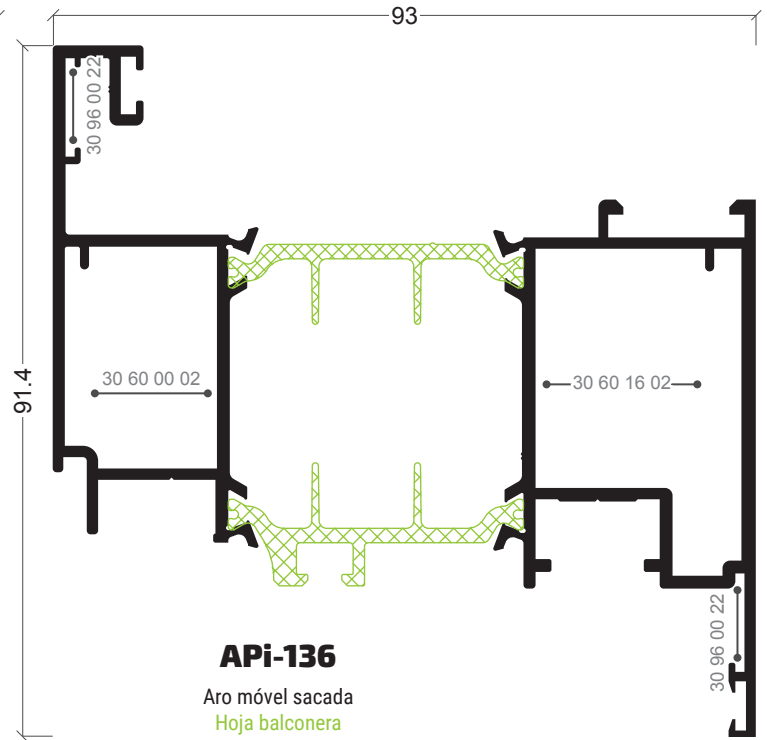
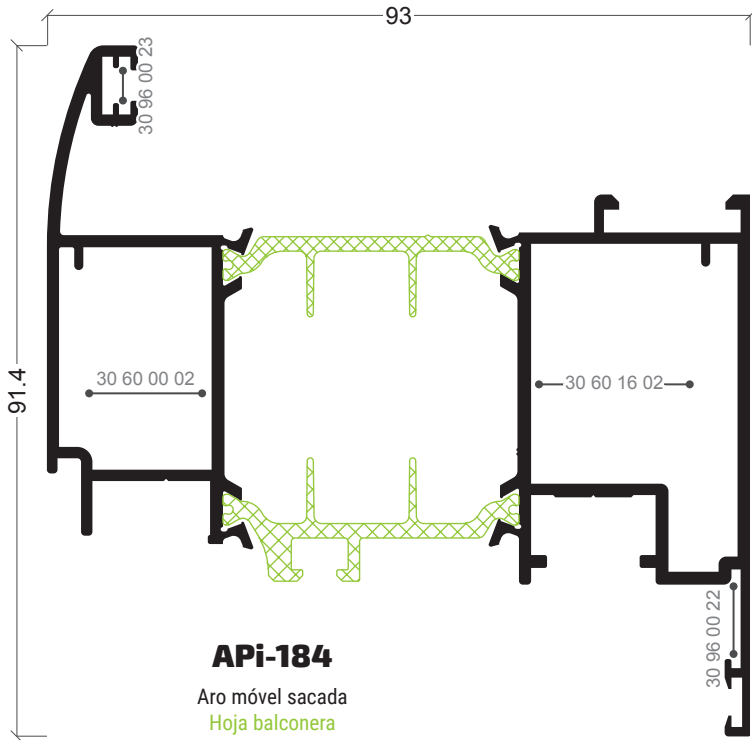

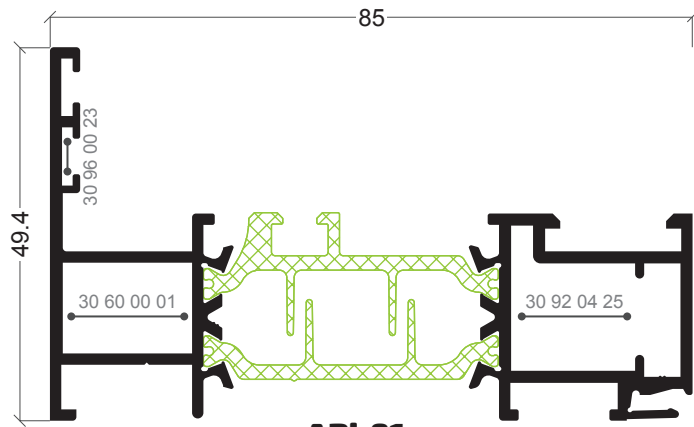

**APi-91**

Aro fijo  
Marco ventana c/ enganche int.

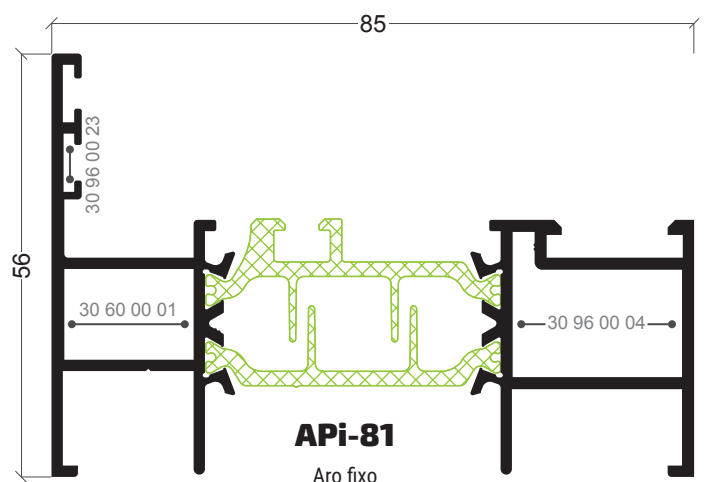

**APi-81**

Aro fijo  
Marco ventana intermedio

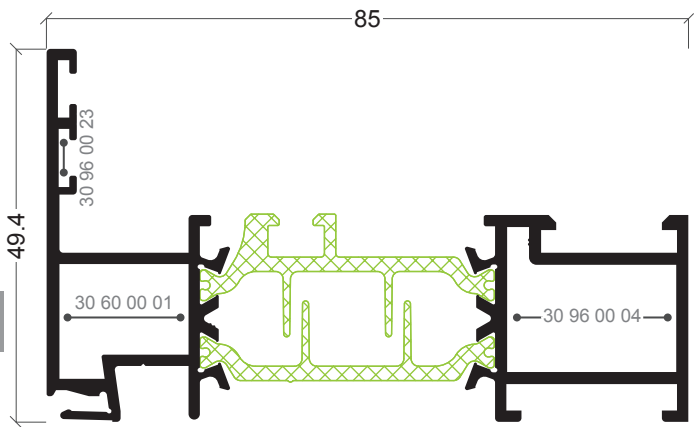

**APi-76**

Aro fijo  
Marco ventana c/ enganche ext.

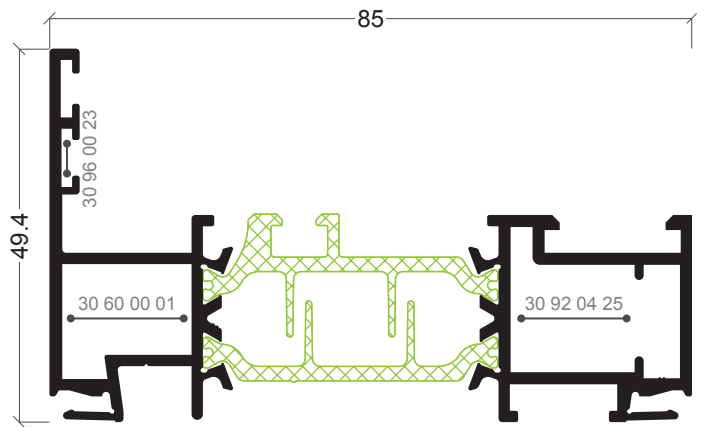

**APi-80**

Aro fijo  
Marco ventana c/ enganche int/ext.

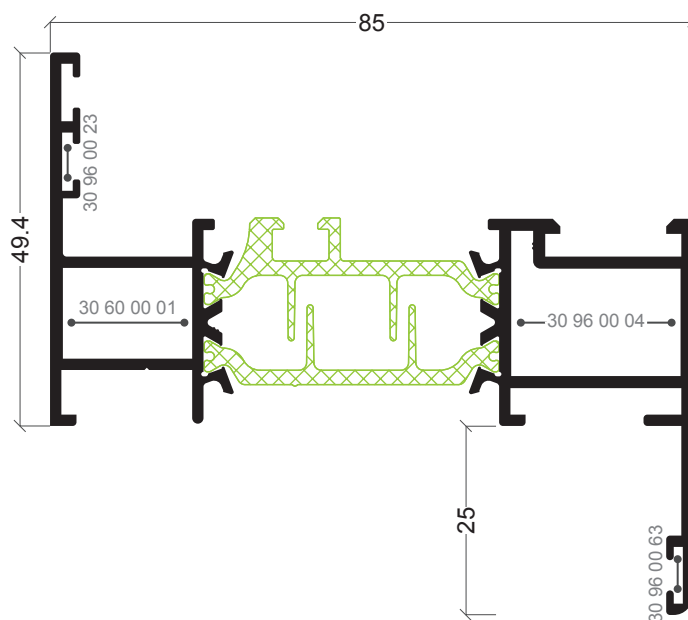

**APi-35**

Aro fijo  
Marco ventana con solape 25 mm

248

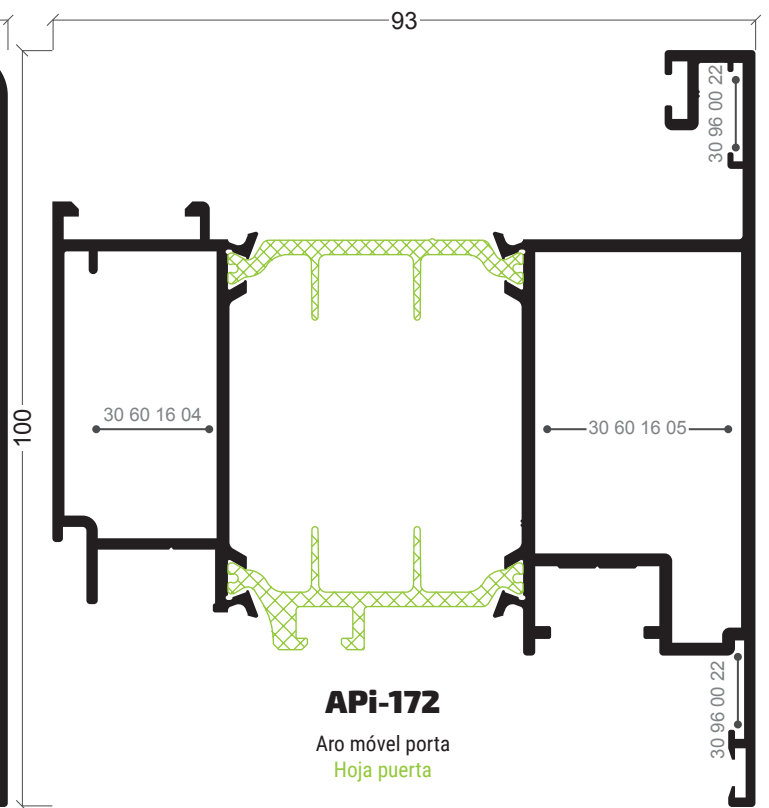
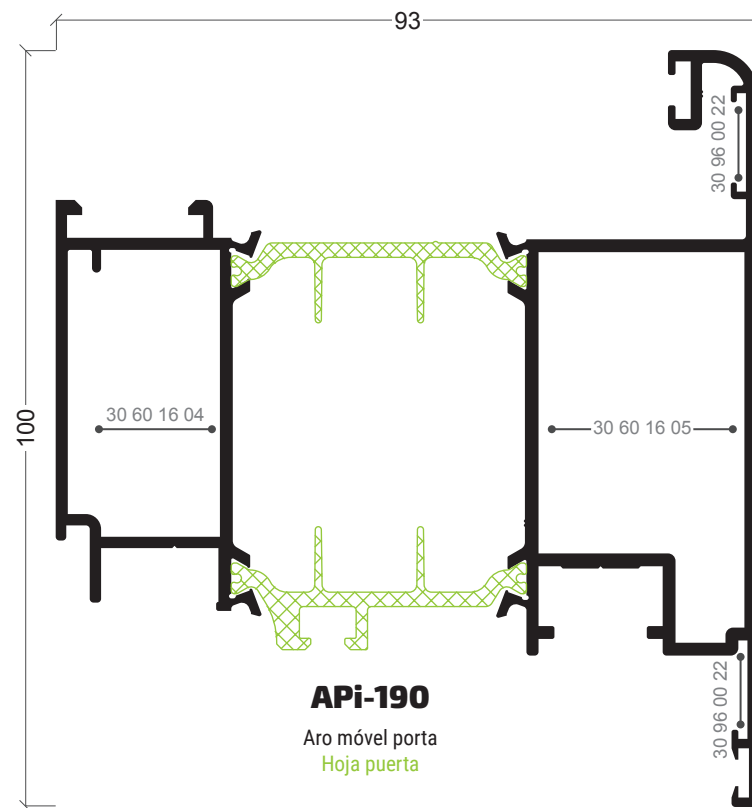
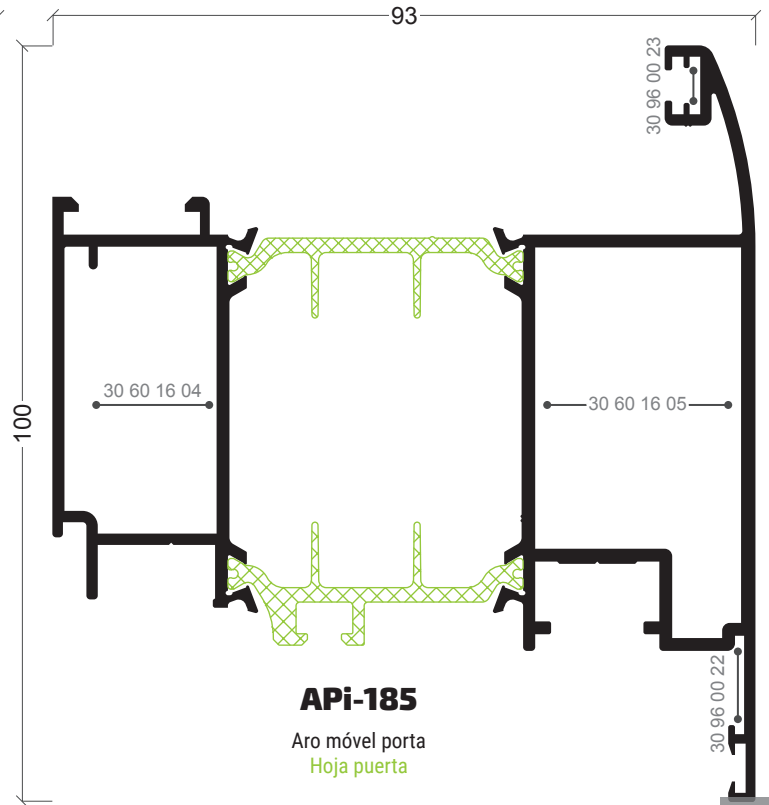
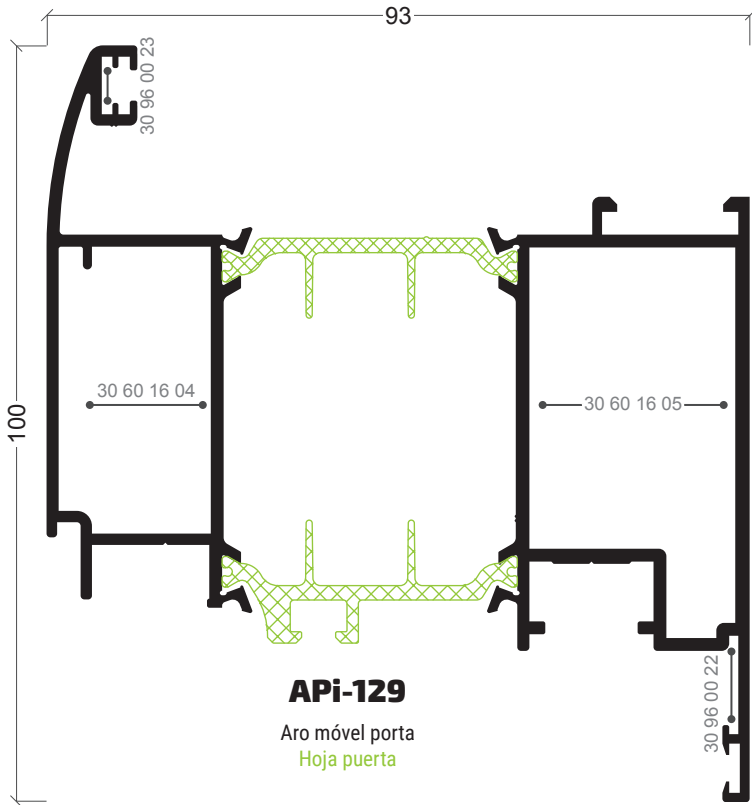

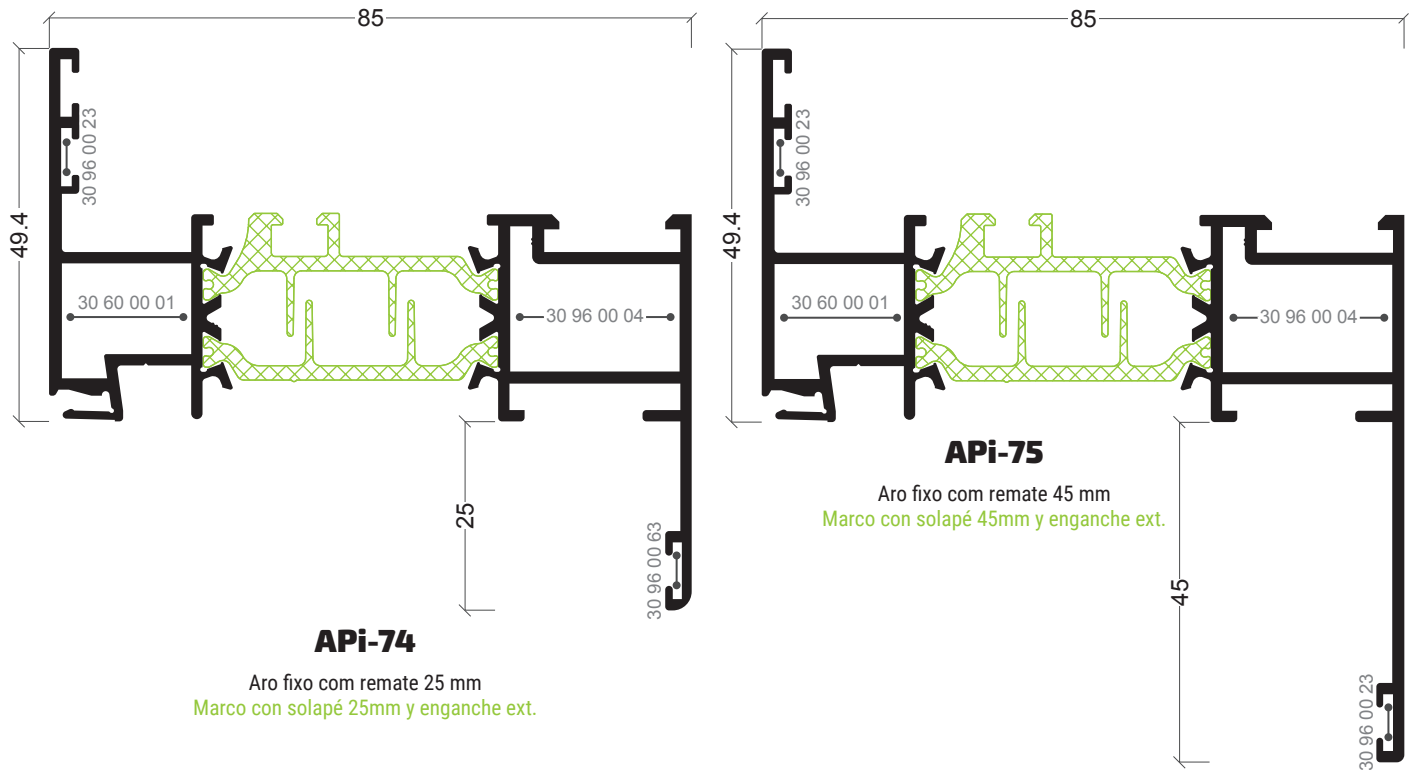

250

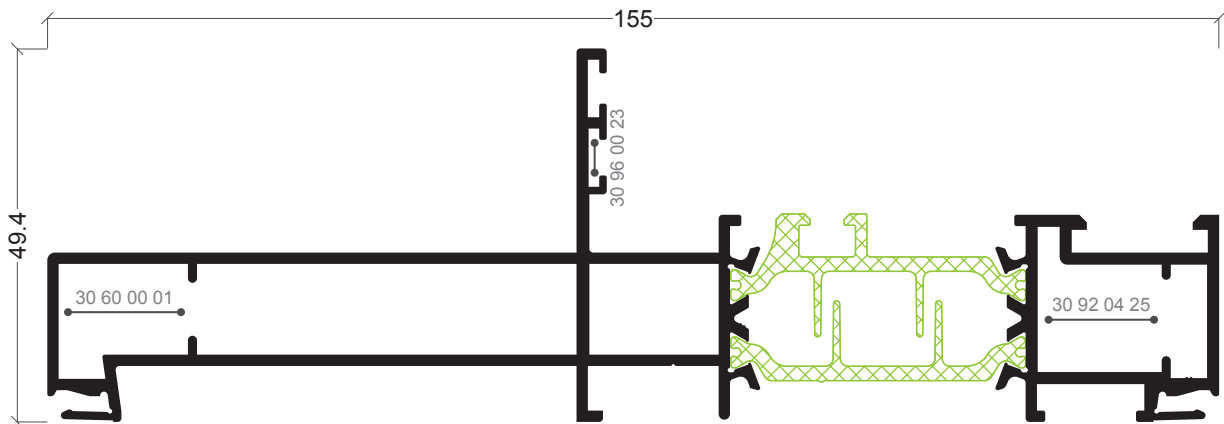
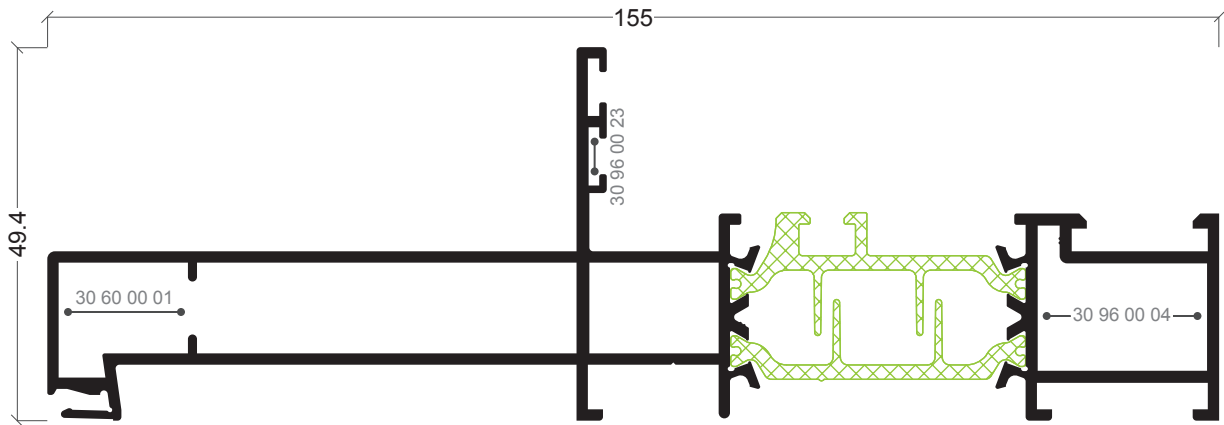

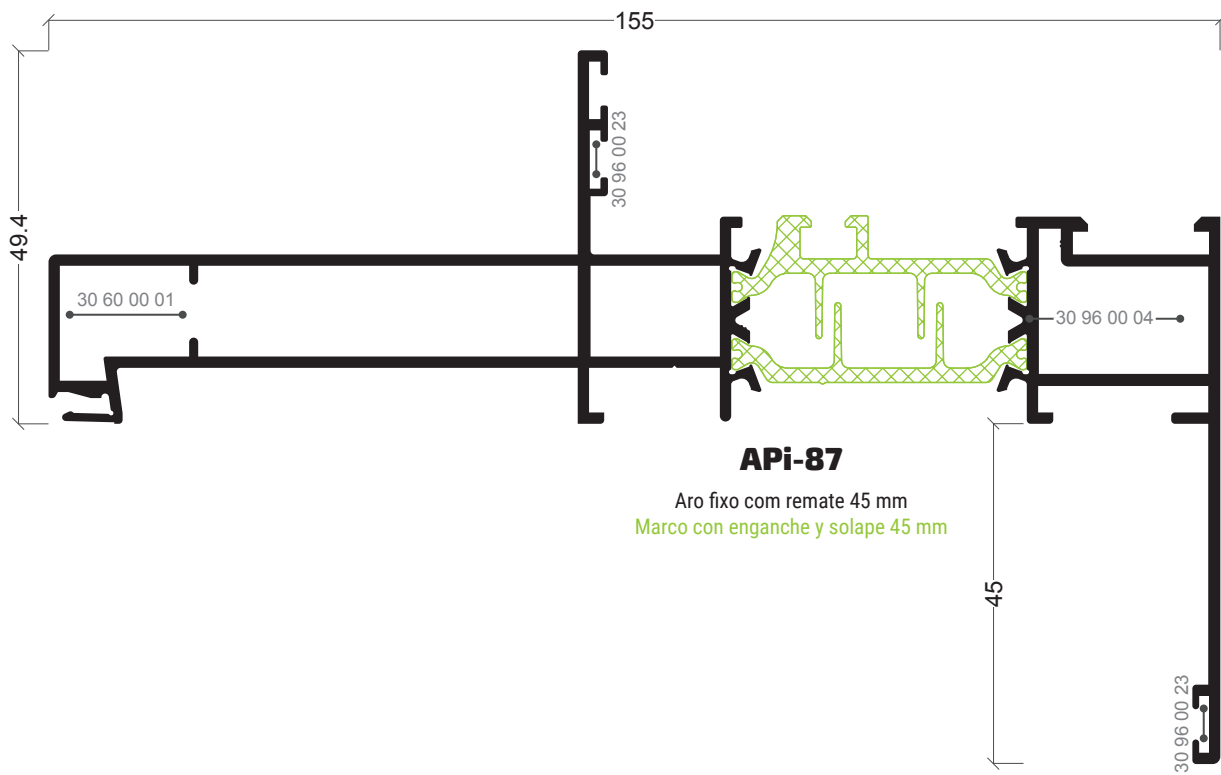
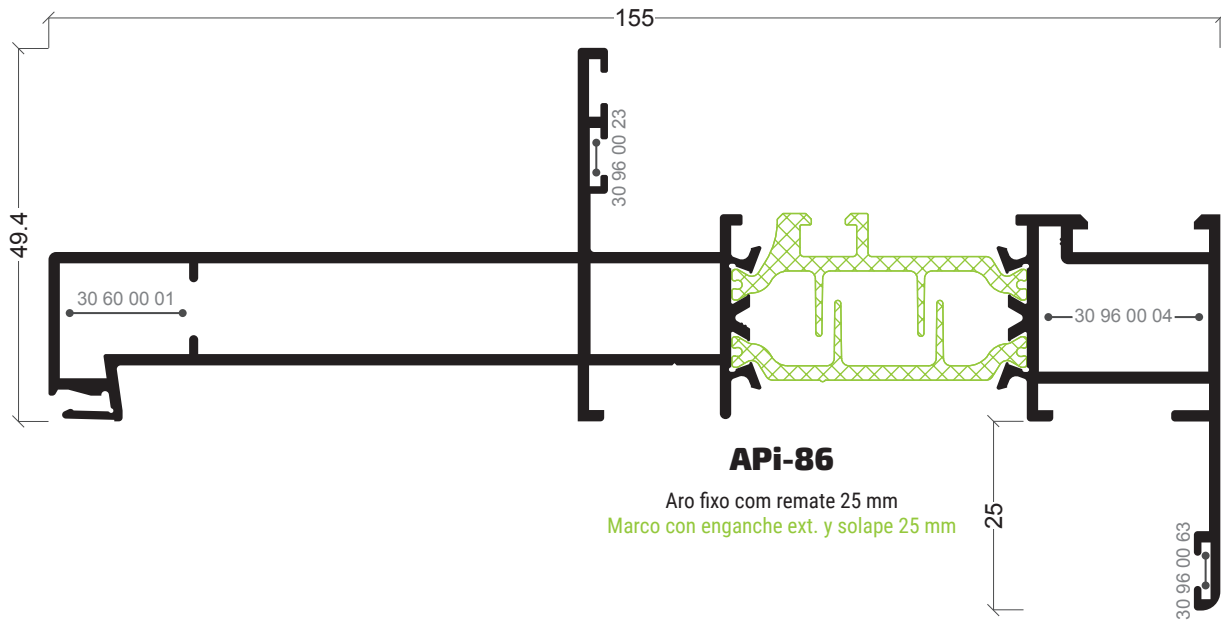

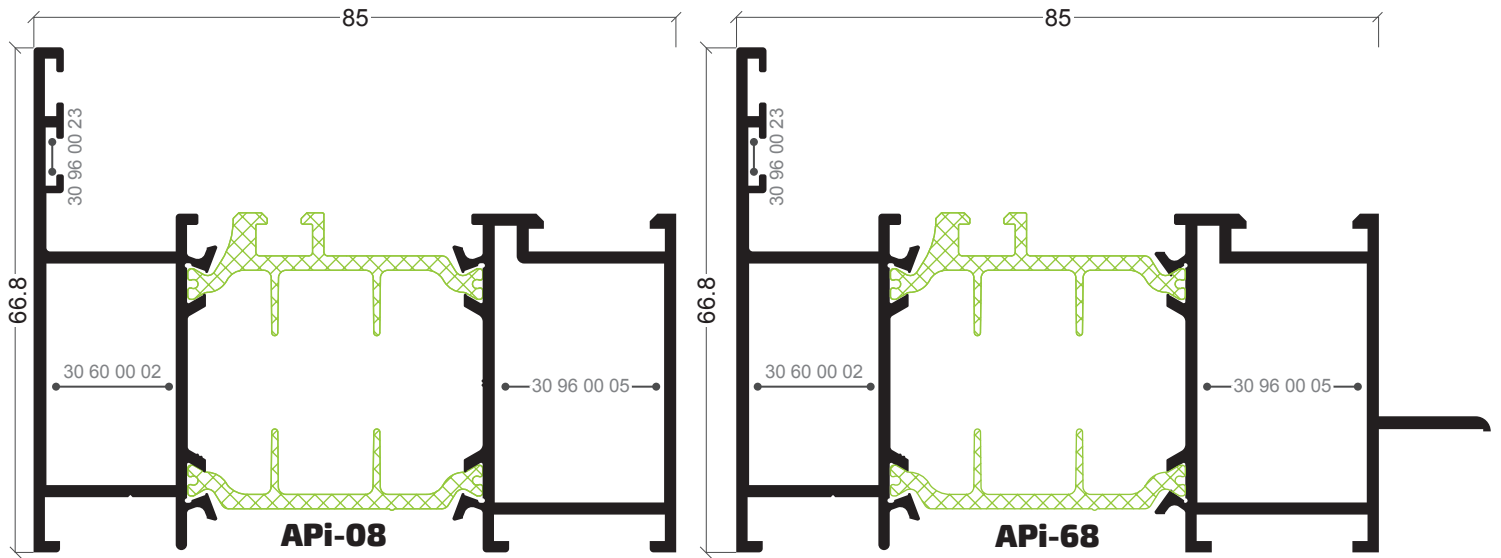

**APi-08**

Aro fixo  
Marco puerta

**APi-68**

Aro fixo  
Marco puerta con prearco

252

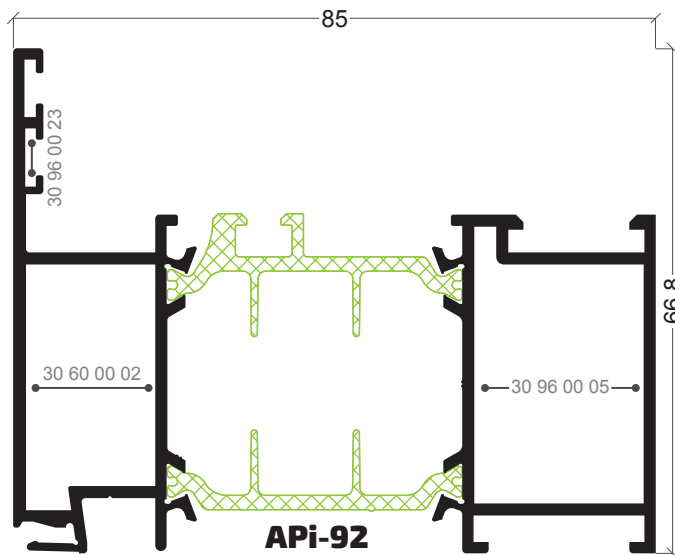

**APi-92**

Aro fixo  
Marco puerta con enganche ext.

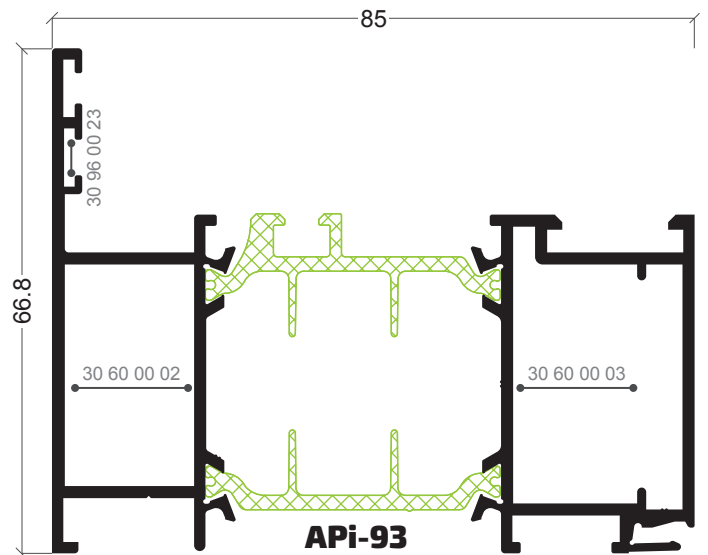

**APi-93**

Aro fixo  
Marco puerta con enganche int.

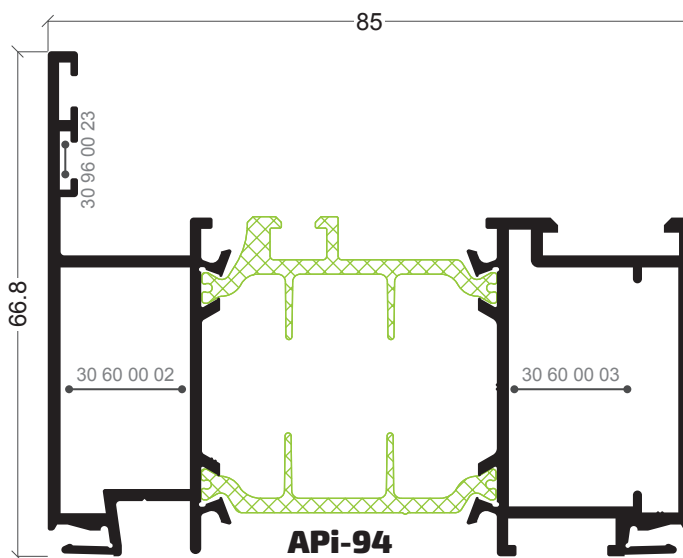

**APi-94**

Aro fixo  
Marco puerta con enganches ext/int

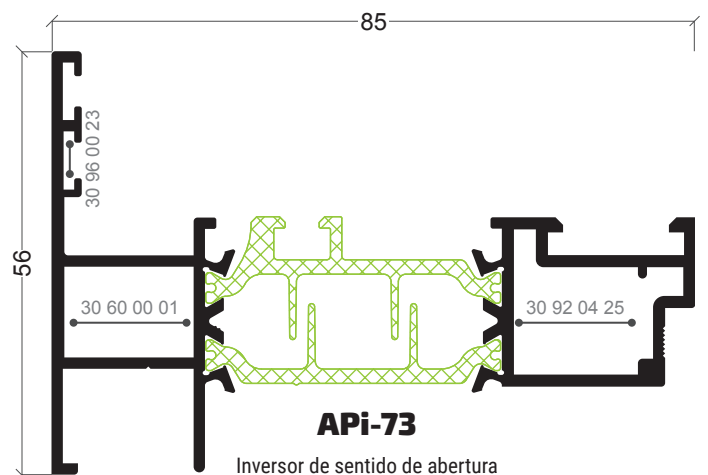

**APi-73**

Inversor de sentido de abertura  
Inversor de sentido de abertura

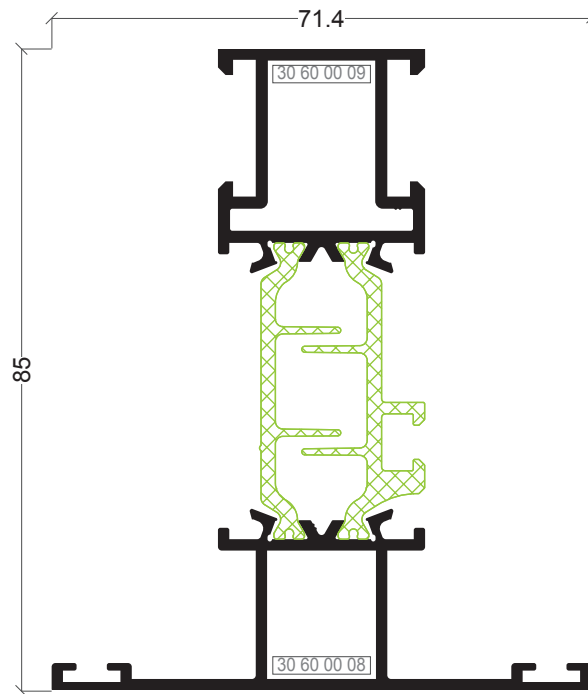

**APi-01**

Travessa  
Travesaño

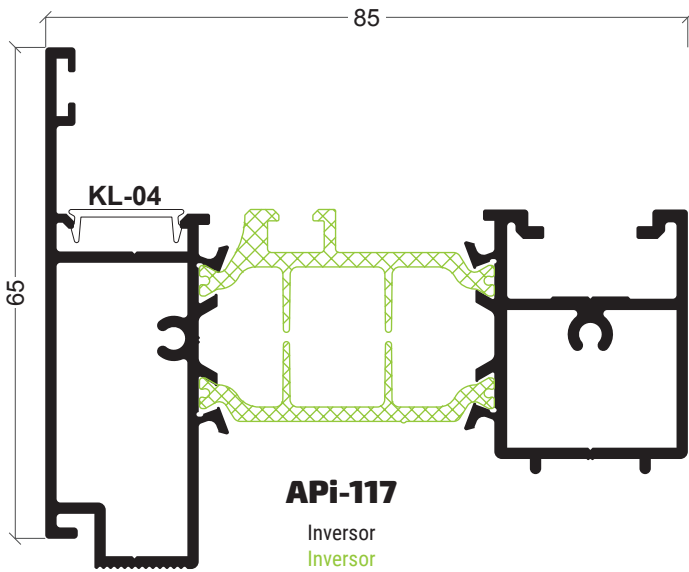

**APi-117**

Inversor  
Inversor

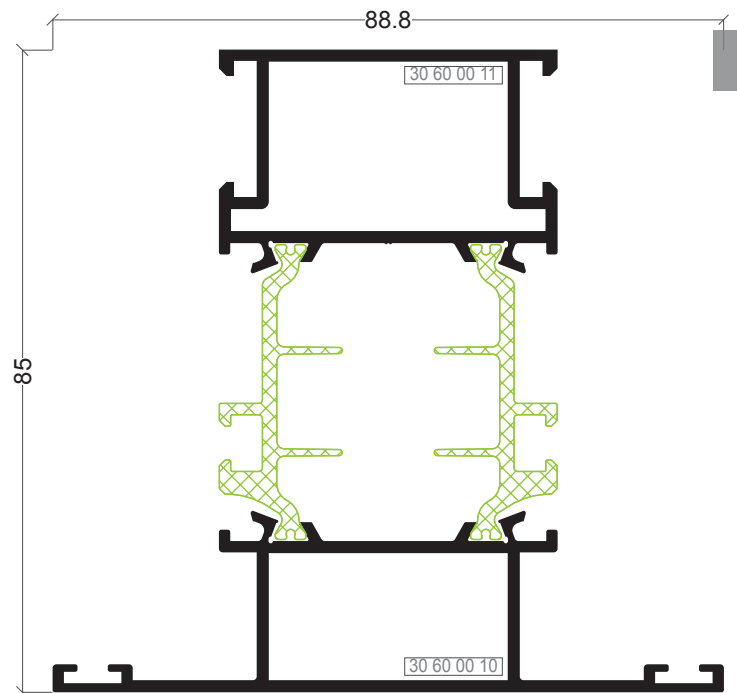

**APi-06**

Travessa  
Travesaño puerta

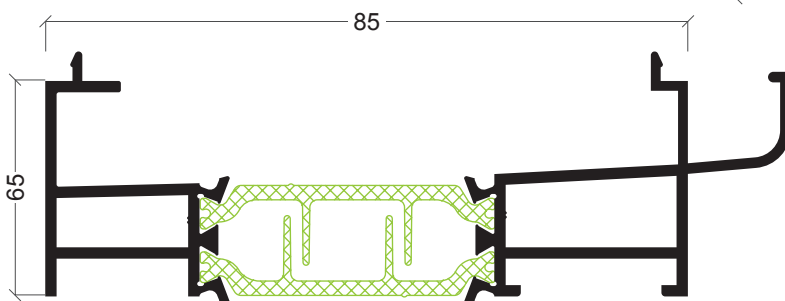

**APi-34**

Soleira condensação  
Condensación

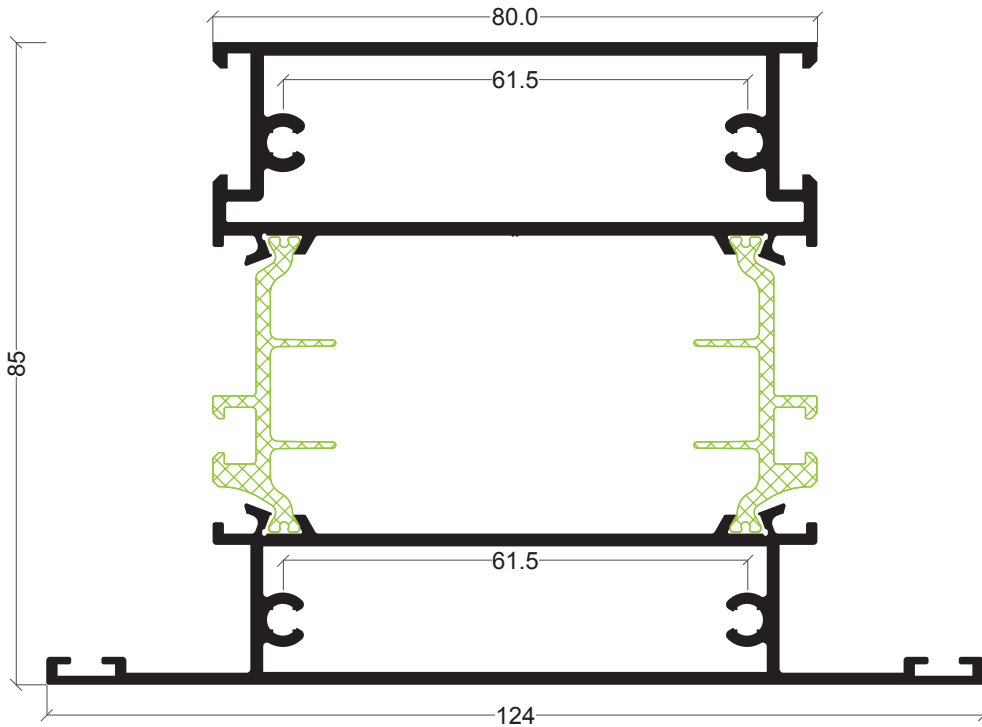

**APi-12**

Travessa  
Zócalo 124x85mm

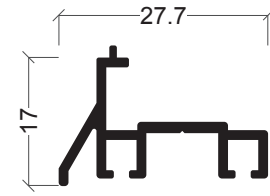

**AJi-62**

Pingadeira inferior porta sacada  
Vierendeau inferior puerta

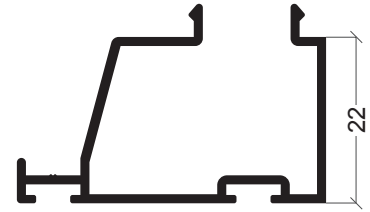

**AJi-82**

Bite remate  
Junquillo acople puerta

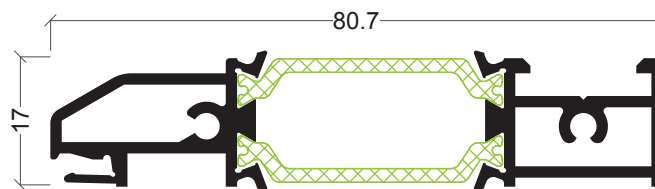

**APi-63**

Soleira  
Solape inferior puerta con enganche

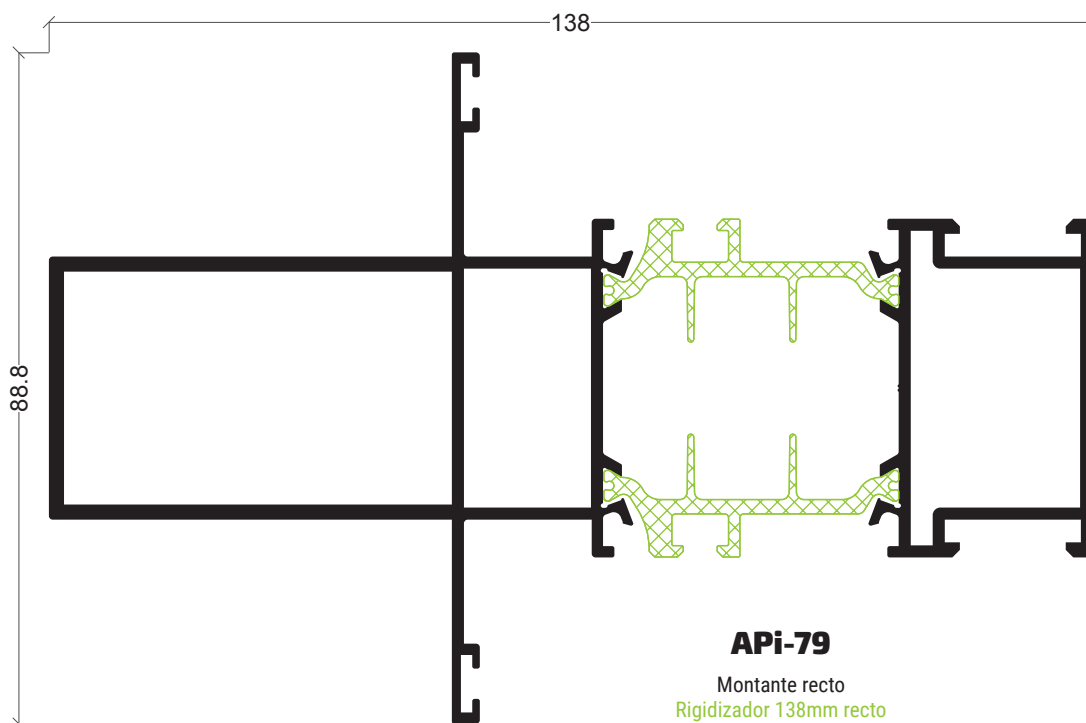

**APi-79**

Montante recto  
Rigidizador 138mm recto



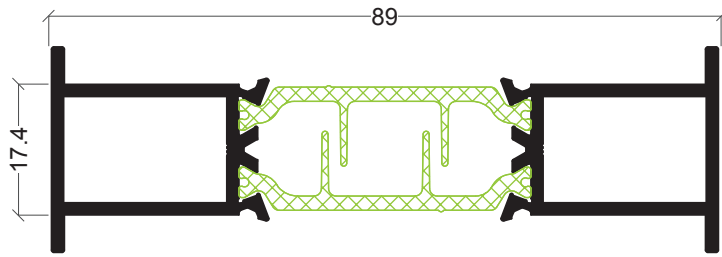

**APi-21**  
União de aros  
Unión de marcos

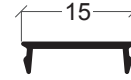

**KL-04**  
Tampa  
Tope

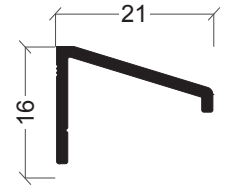

**A1-46**  
Pingadeira janela  
Vierteaguas ventana

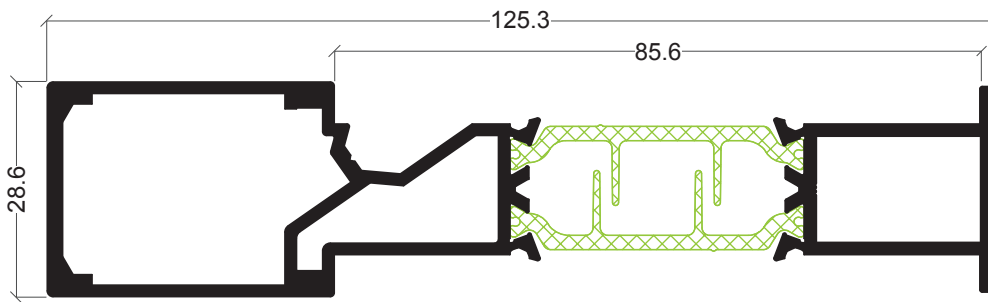

**APi-65**  
União de aros  
Unión de marcos con refuerzo

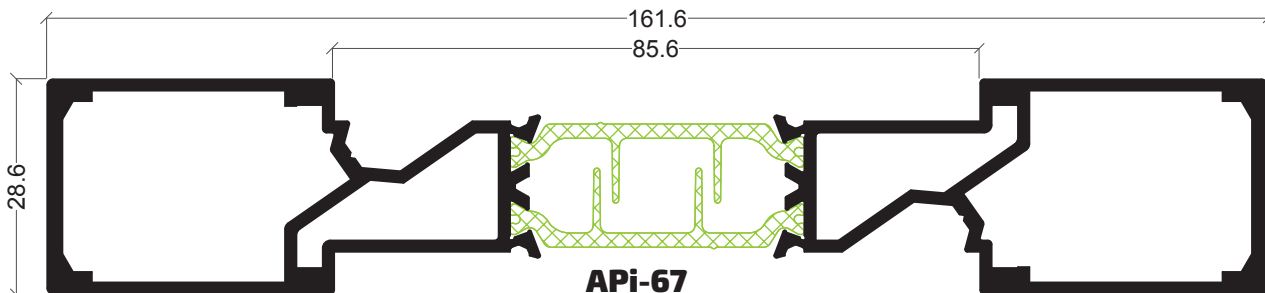

**APi-67**  
União de aros  
Unión de marcos con doble refuerzo

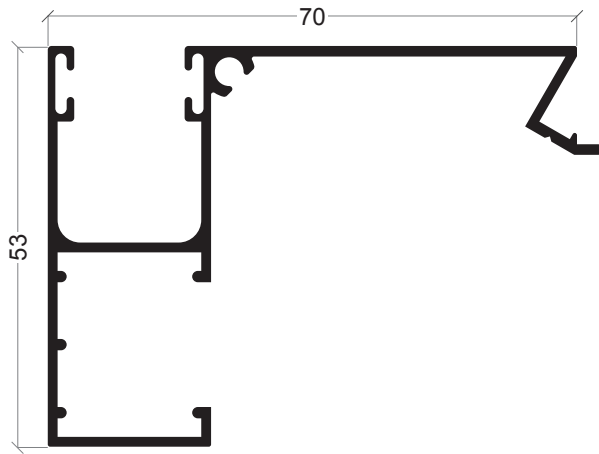

**S-26**

Guia de persiana  
Guia de persiana

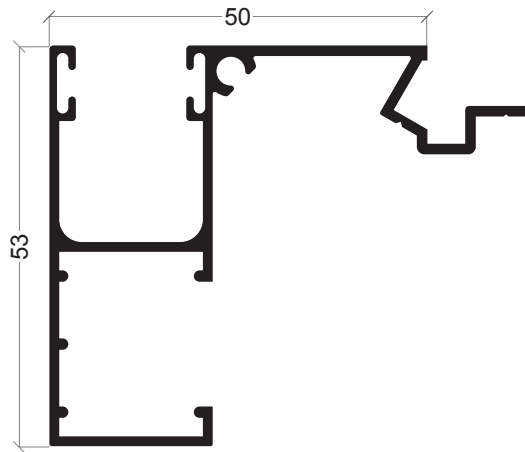

**S-25**

Guia de persiana  
Guia de persiana

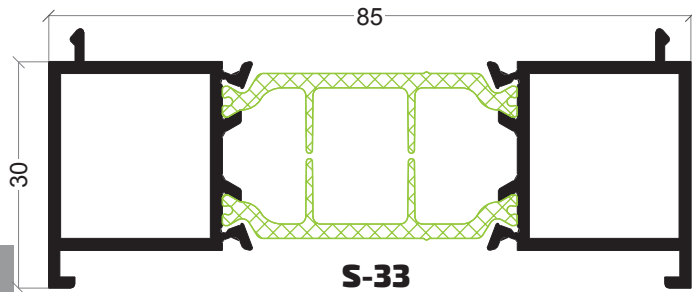

**S-33**

Perfil de ligação  
Perfil de conexión



**S-32**

Remate interior 45 mm  
Solape interior 45 mm

256

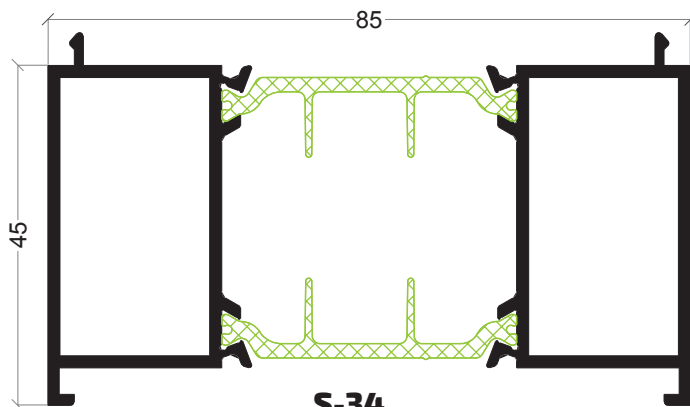

**S-34**

Perfil de ligação  
Perfil de conexión



**CT-94**

Perfil de união  
Perfil de unión

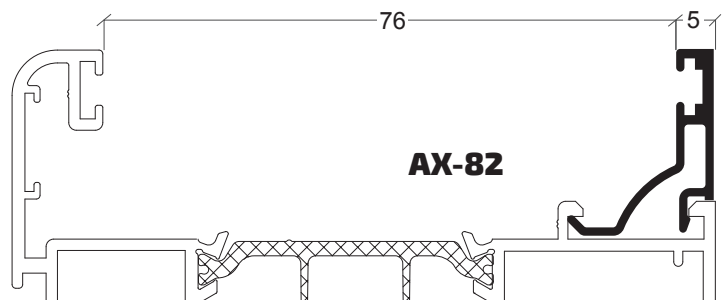

**AX-82**

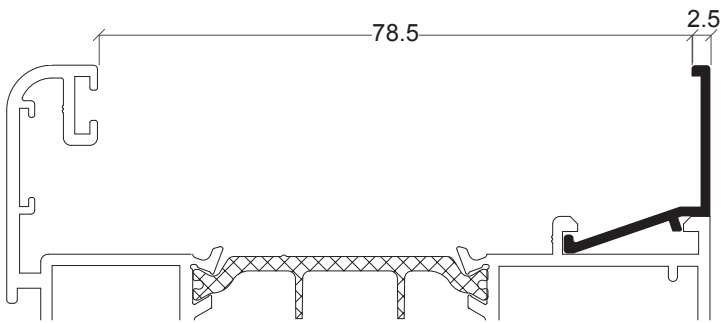

**AX-69**

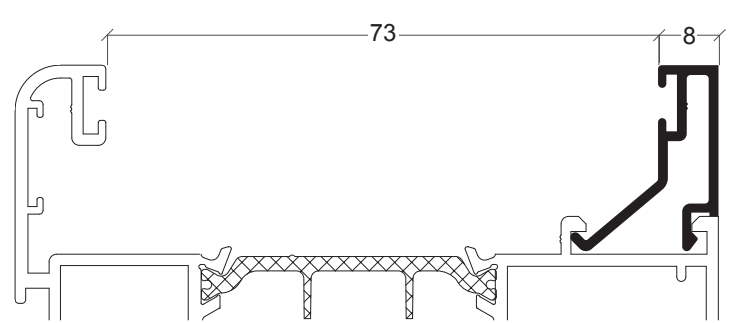

**AX-74**

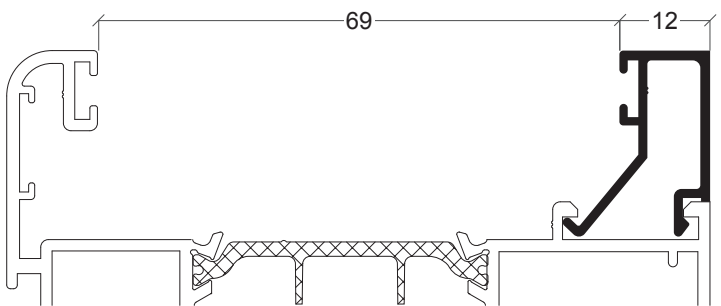

**AX-36**

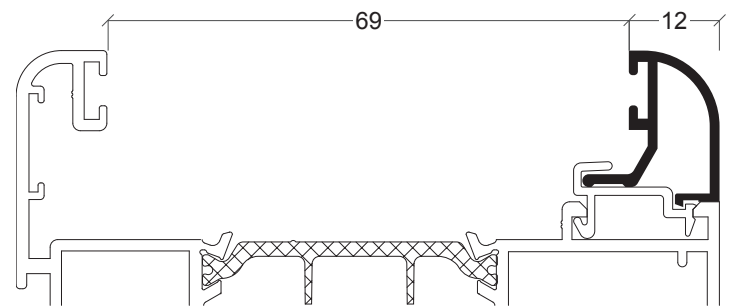

**AX-37**

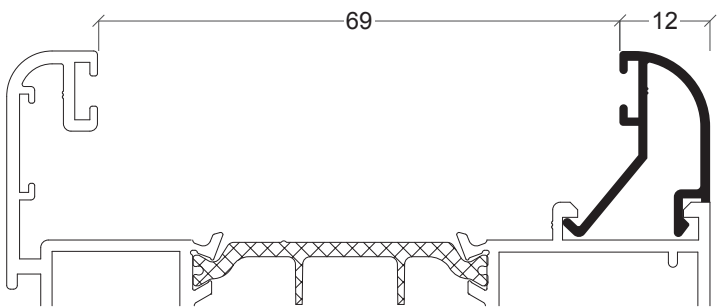

**AX-08**

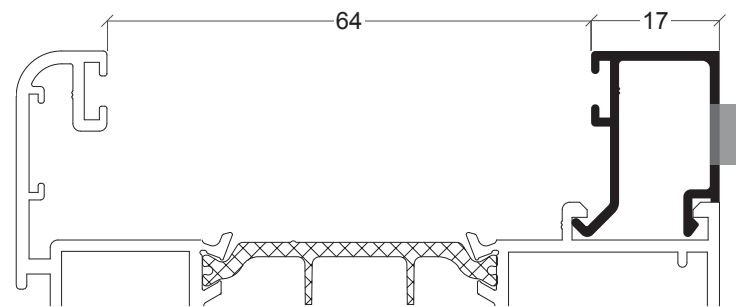

**AX-46**

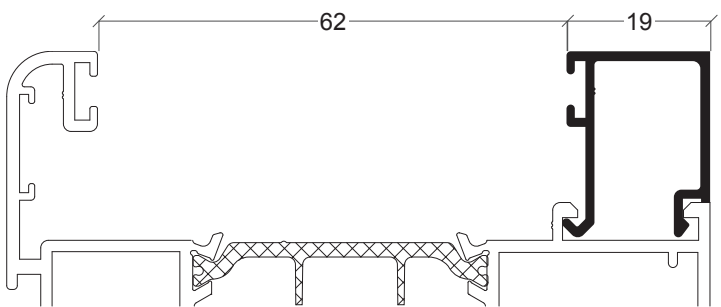

**AX-35**

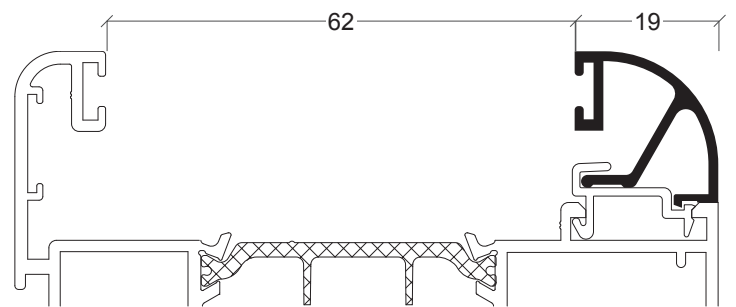

**AX-30**

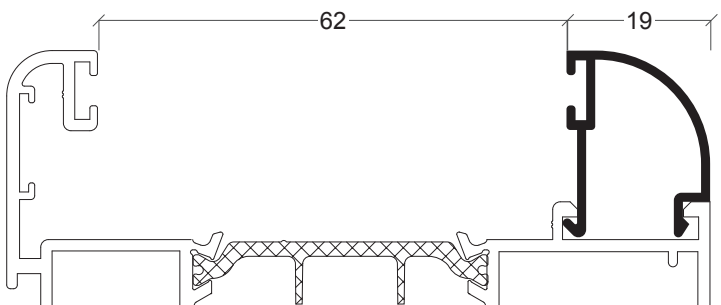

**AZ-07**

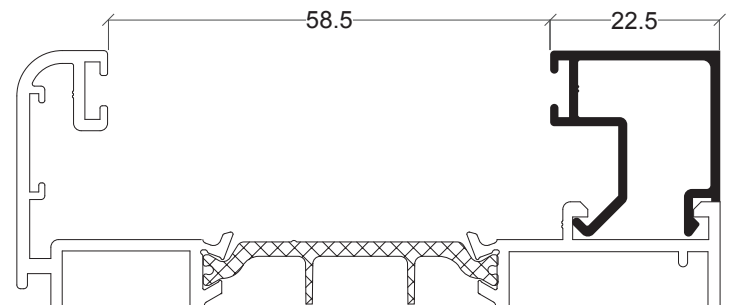

**AX-78**

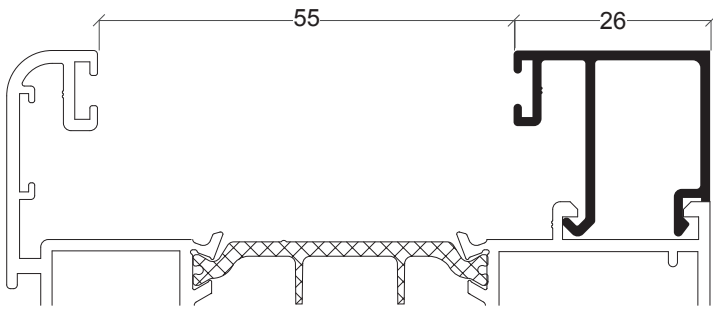

**AX-31**

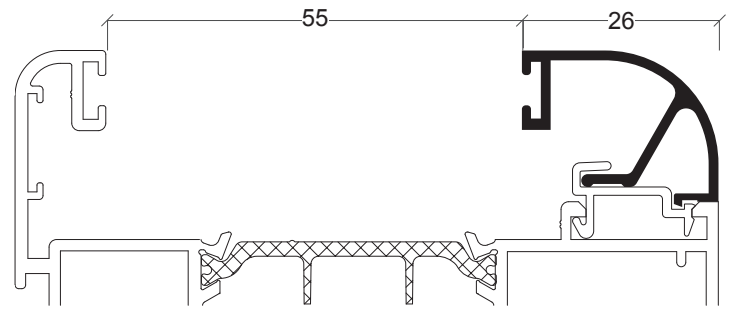

**AX-29**

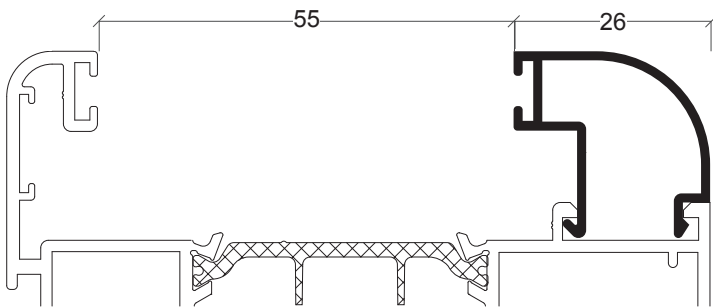

**AZ-06**

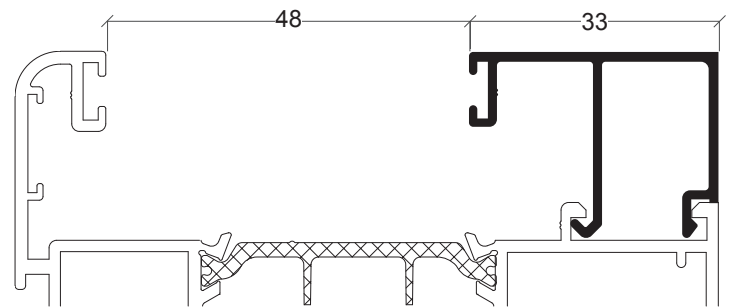

**AX-34**

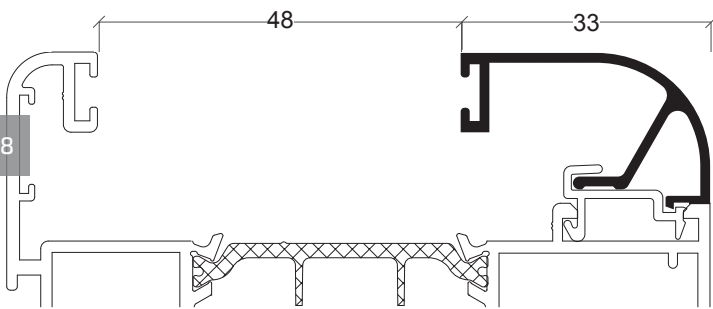

**AX-39**

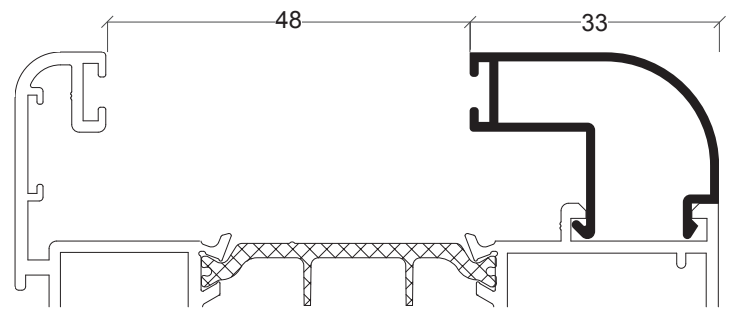

**AZ-28**

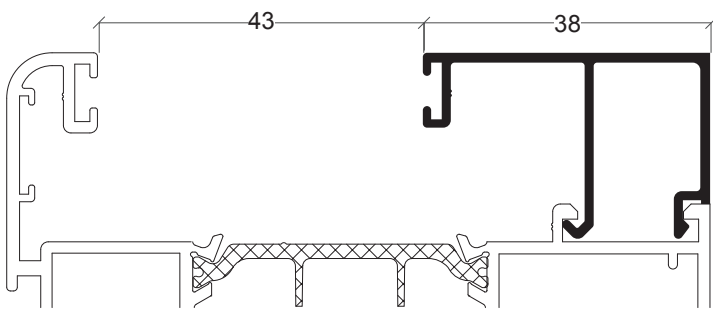

**AX-32**

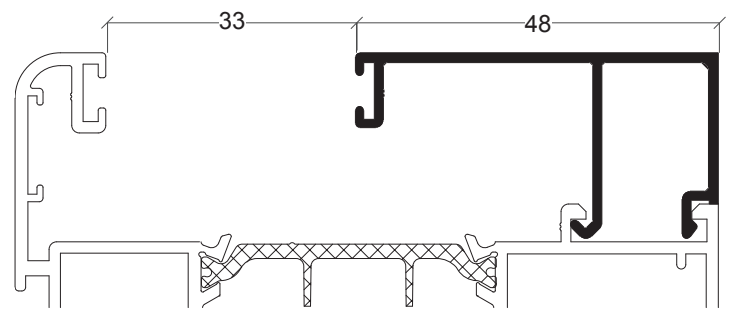

**AX-80**

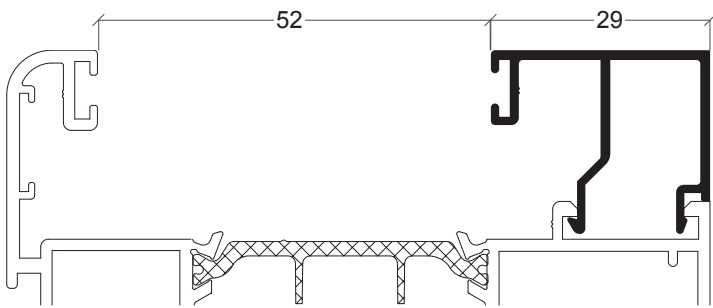

**AX-81**

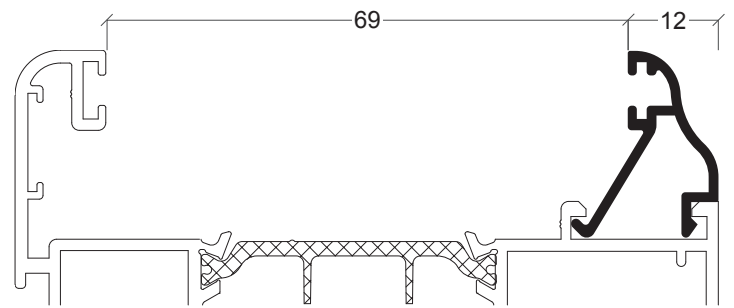

**AX-73**

258

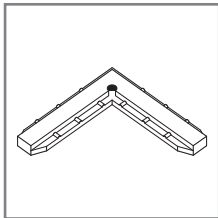

**30 21 20 07**

Esquadro de alinhamento  
Escuadra de alineamiento

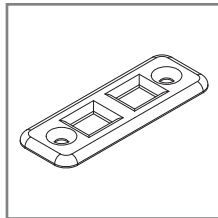

**30 24 30 75**

Contra-fecho inox  
Contracierre inox

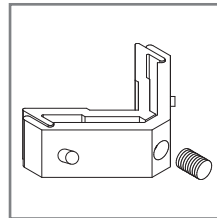

**30 60 00 01**

Esquadro exterior janela  
Escuadra exterior ventana

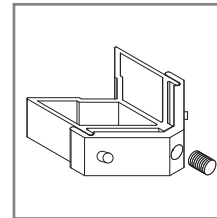

**30 60 00 02**

Esquadro exterior porta  
Escuadra exterior puerta

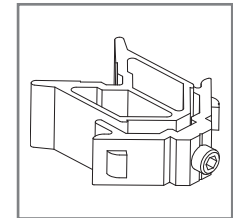

**30 60 00 03**

Esquadro interior porta com clip  
Escuadra interior puerta con clip

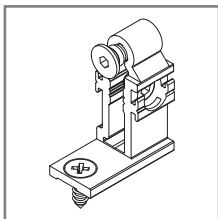

**30 60 00 08**

Esquadro exterior projectante  
Unión travesaño exterior pequeña fijo

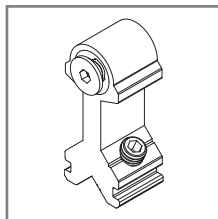

**30 60 00 09**

União travessa interior pequena  
Unión travesaño interior pequeña

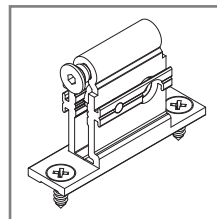

**30 60 00 10**

União travessa exterior grande fixo/móvel  
Unión travesaño exterior grande fijo/hoja

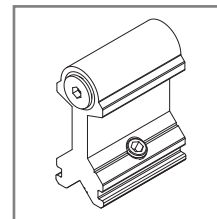

**30 60 00 11**

União travessa interior grande  
Unión travesaño interior grande

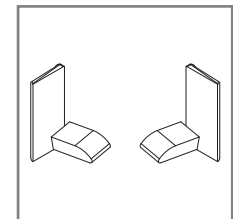

**30 60 00 13**

Conjunto topos AJI-62  
Conjunto topos AJI-62

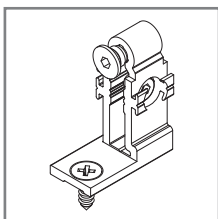

**30 60 00 16**

União travessa exterior pequena móvel  
Unión travesaño exterior pequeña móvil

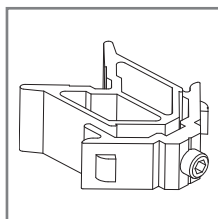

**30 60 16 02**

Esquadro interior porta C16  
Escuadra interior puerta C16

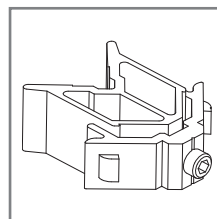

**30 60 16 03**

Esquadro interior aro fixo (API-113)  
Escuadra interior Marco (API-113)

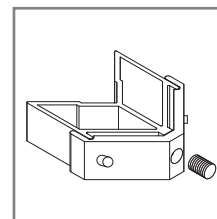

**30 60 16 04**

Esquadro exterior aro móvel entrada  
Escuadra exterior hoja puerta entrada

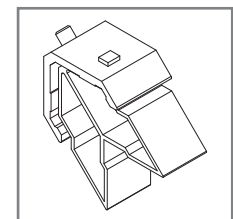

**30 60 16 05**

Esquadro interior aro móvel entrada  
Escuadra interior hoja puerta entrada

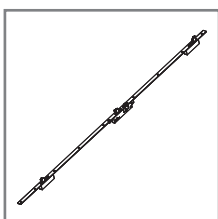

**30 60 16 20**

Fechadura 3 pontos C16 (35 mm)  
Cierre 3 puntos C16 (35 mm)

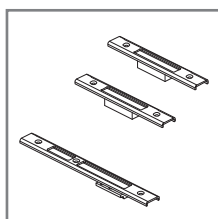

**30 60 16 21**

Conjunto chapa-testas direitas para aro fixo C16  
Conjunto cierre bombillo derechas para marco C16

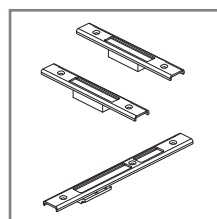

**30 60 16 22**

Conjunto chapa-testas esquerdas para aro fixo C16  
Conjunto cierre bombillo izquierdas para marco C16

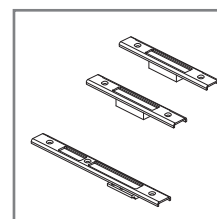

**30 60 16 23**

Conjunto fechadura chapa-testas direitas para inversor C16  
Conjunto cierre bombillo derechas para inversor C16

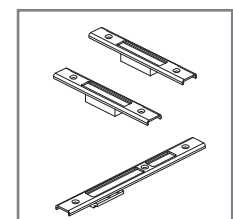

**30 60 16 24**

Conjunto fechadura chapa-testas esquerdas para inversor C16  
Conjunto cierre bombillo izquierdas para inversor C16

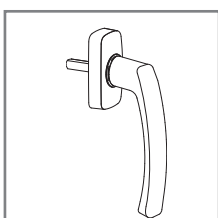

**30 60 16 40/41**

Puxador de alumínio branco/preto  
Manilla de alumínio blanco/negro

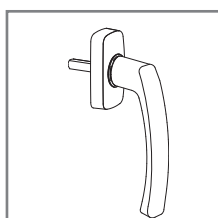

**30 60 16 42/43**

Puxador de alumínio 2 ac/champ ac  
Manilla de alumínio 2 ac/champ ac

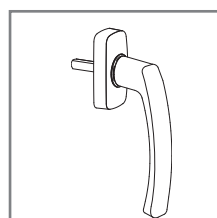

**30 60 16 44**

Puxador de alumínio inox ac ac  
Manilla de alumínio inox ac

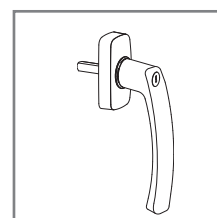

**30 60 16 45/46**

Puxador com chave de alumínio branco/preto  
Manilla con llave de alumínio blanco/negro

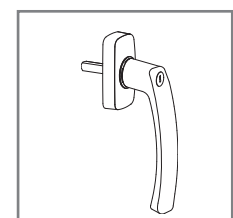

**30 60 16 47/48**

Puxador com chave de alumínio 2 ac/champ ac  
Manilla con llave de alumínio 2 ac/champ ac

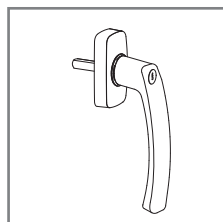

**30 60 16 49**

Puxador com chave de alumínio inox ac  
Manilla con llave de aluminio inox ac

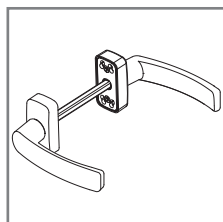

**30 60 16 50/51**

Puxador duplo de alumínio branco/preto  
Manilla doble de aluminio blanco/negro

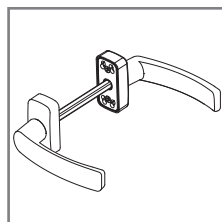

**30 60 16 52/53**

Puxador duplo de alumínio 2 ac/champ ac  
Manilla doble de aluminio 2 ac/champ ac

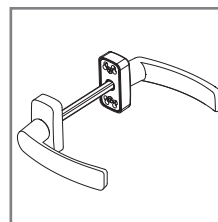

**30 60 16 54**

Puxador duplo de alumínio inox ac  
Manilla doble de aluminio inox ac

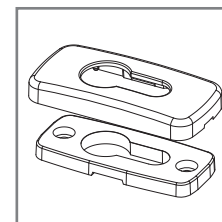

**30 60 16 55/56**

Escudo em alumínio branco/preto  
Cierre de aluminio blanco/negro

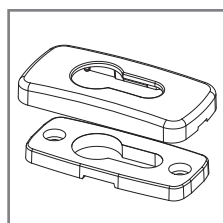

**30 60 16 57/58**

Escudo em alumínio 2 ac/champ ac  
Cierre de aluminio 2 ac/champ ac

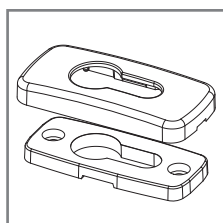

**30 60 16 59**

Escudo em alumínio inox ac  
Cierre de aluminio inox ac

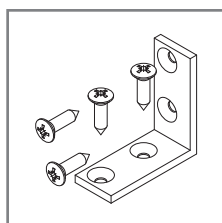

**30 60 40 25**

União travessa exterior (API-101/102/106)  
Unión travessañ exterior (API-101/102/106)

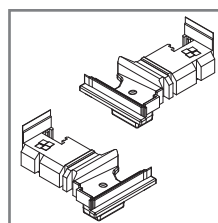

**30 70 00 12**

Conjunto topos inversor API  
Conjunto topes inversor API

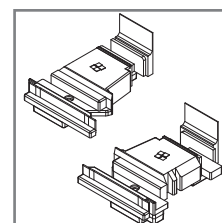

**30 70 16 12**

Conjunto topos inversor API canal 16  
Conjunto topes inversor API canal 16

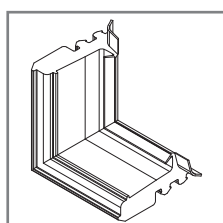

**30 70 16 31**

Canto vulcanizado C16  
Angulo vulcanizado C16

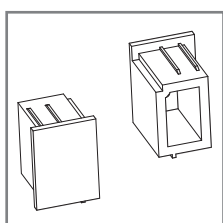

**30 91 21 20**

Jogo tampas condensação Y-20  
Juego topes condensación Y-20

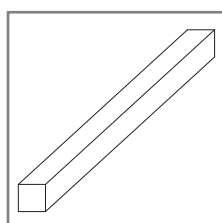

**30 91 41 23**

Perno 7 x 131 mm  
Perno 7 x 131 mm

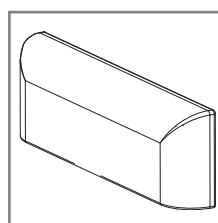

**30 92 01 00/01**

Goteira preto/branco  
Tapa salida de aguas negro/blanco

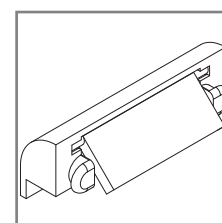

**30 92 01 02/03**

Goteira com válvula preto/branco  
Vierteaguas con válvula negro/blanco

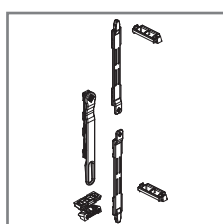

**30 92 01 23**

Jogo de passadores bidirecional C.E.  
Juego de pasadores bidireccional C.E.

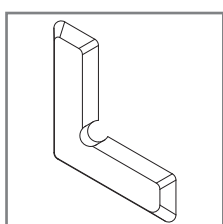

**30 92 01 35**

Esquadro de alinhamento  
Escuadra de alineamiento

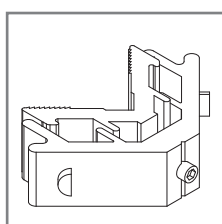

**30 92 04 25**

Esquadro para AZ-22  
Escuadra interior ventana fijo con clip

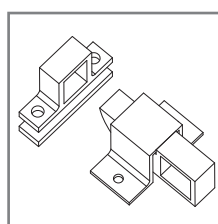

**30 92 04 76/77**

Fecho clack branco/preto  
Cierre golpete blanco/negro

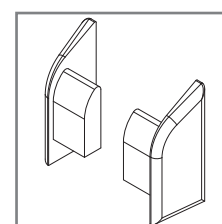

**30 92 05 00**

Jogo topos  
Juego topes

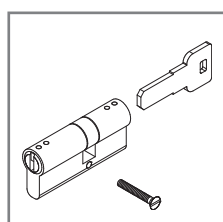

**30 92 13 03**

Canhão fechadura 30 x 80 Níquel  
Bombillo cierre 30 x 80 Níquel

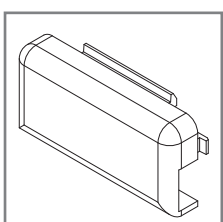

**30 92 13 04**

Goteira preta  
Vierteaguas negra

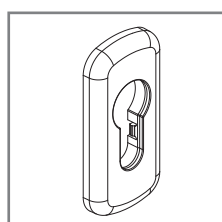

**30 92 22 85/86**

Escudo para canhão branco/preto  
Contracriete bombillo blanco/negro

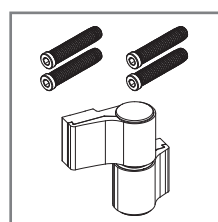

**30 92 22 88/89**

Dobradiça 2 abas porta  
c/ ressalto directa branco/preto  
Bisagra 2 cuerpos puerta  
c/ resalto directa blanco/negro

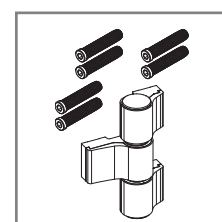

**30 92 22 90/91**

Dobradiça 3 abas porta  
c/ ressalto fixação branco/preto  
Bisagra 3 cuerpos puerta  
c/ resalto fijación blanco/negro

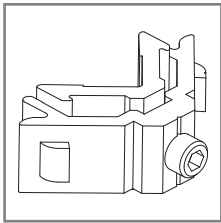

**30 96 00 04**

Esquadro interior janela  
Escuadra interior ventana

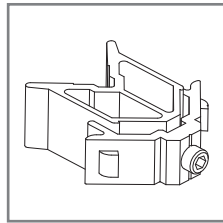

**30 96 00 05**

Esquadro interior aro fixo porta  
Escuadra interior marco porta

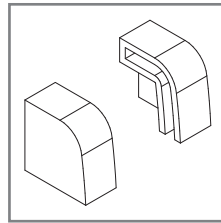

**30 96 00 12**

Jogo topos condensação  
Juego topos condensación

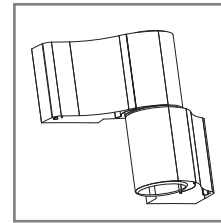

**30 96 00 17/21**

Dobradiça com ressalto branco/preto  
Bisagra con ressalto blanco/negro

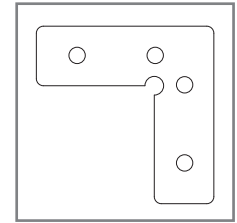

**30 96 00 22**

Esquadro alinhamento  
Escuadra alineamiento

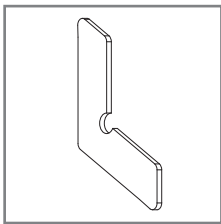

**30 96 00 23**

Esquadro alinhamento aro fixo  
Escuadra alineamiento marco

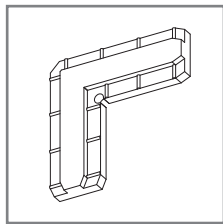

**30 96 00 43**

Esquadro alinhamento  
Escuadra alineamiento

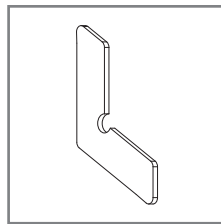

**30 96 00 63**

Esquadro alinhamento  
Escuadra alineamiento

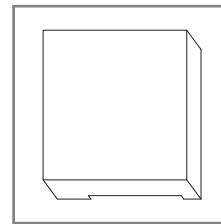

**30 96 10 01**

Calço para vidro aro móvel  
Calzo para vidrio hoja

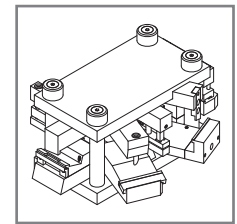











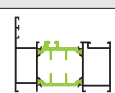

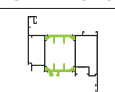
**33 98 24 99**

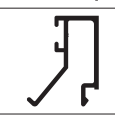
Cunho API canal 16  
Troquel API canal 16

REFERÊNCIA • REFERENCIA	DESENHO • DISEÑO	DESCRIÇÃO • DESCRIPCIÓN
30 60 00 21		Junta acústica • Junta acústica
30 70 16 30		Junta central termo isolante C16 • Junta Central termo aislante C16

REFERÊNCIA • REFERENCIA	THERMOPROFILE (Baguetes de 70cm) THERMOPROFILE (Baguetes de 70cm)	DESCRIÇÃO • DESCRIPCIÓN
30 99 00 22		API-105; API-117; API-161; API-183
30 99 00 23		API-105; API-117; API-161; API-183
30 99 00 24		API-105; API-117; API-161; API-183
30 99 00 25		API-110; API-136; API-184
30 99 00 26		API-115; API-122; API-129; API-172; API-185; API-190

**Porta 1 folha • Puerta 1 hoja**
**PERFIS • PERFIS**

DESENHO • DISEÑO	REF.	DESCRIÇÃO • DESCRIPCIÓN	CORTE CORTE	QUANTIDADE CANTIDAD	MEDIDAS • MEDIDA
	APi-08	Aro fixo Marco		1	L
			2	H	
	APi-122	Aro móvel Hoja		2	L-73.5 mm
			2	H-46 mm	
	---	Bite Junquillo		2	L-233.5 mm
				2	H-246 mm
	AJi-62	Pingadeira Alargadera		1	L-143 mm
	APi-63	Soleira Solape inferior puerta		1	L-80.5 mm
	KL-04	Terfil tampa Perfil de tapa		1	L-90 mm

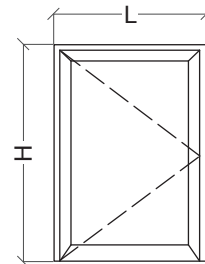
**ACESSÓRIOS E JUNTAS • ACCESORIOS Y JUNTAS**

REF.	DESCRIÇÃO • DESCRIPTION	QUANTIDADE CANTIDAD
30 96 00 05	Esquadro interior fixo • Escuadra interior fijo	2
30 60 00 02	Esquadro exterior • Escuadra exterior	2
30 60 16 04	Esquadro exterior móvel • Escuadra exterior hoja	4
30 60 16 05	Esquadro interior móvel • Escuadra interior hoja	4
30 96 00 23	Esquadro alinhamento fixo • Escuadra alineamiento fijo	2
30 96 00 22	Esquadro alinhamento móvel • Escuadra alineamiento hoja	8
30 96 10 01	Calço para vidro • Calzo para vidrio	4
30 92 22 88 ou 89	Dobradiça 2 abas porta • Bisagra 2 abas puerta	2
30 60 16 20	Fechadura 3 pontos • Cierre 3 puntos	1
30 92 22 82 ou 83	Puxador duplo • Manilla doble	1
30 92 22 85 ou 86	Escudo para canhão • Contracierre para bombillo	2
30 92 13 03	Canhão • Bombillo Cierre	1
30 93 01 20	Junta interior • Junta interior	2L+2H
30 70 16 30	Junta central • Junta central	L+2H
30 70 16 31	Canto vulcanizado • Angulo vulcanizado	2
30 60 00 13	Conjunto topos AJi-62 • Conjunto topos AJi-62	1
30 60 00 14	Pelúcia preta 18 mm • Burlite negra 18 mm	2L
---	Junta para vidro (exterior) • Junta para vidrio (exterior)	2L+2H
---	JJunta para vidro (interior) • Junta para vidrio (interior)	2L+2H
30 60 16 21 ou 22	Conjunto chapa-testas para aro fixo • Conjunto cierre bombillo para Marco	1





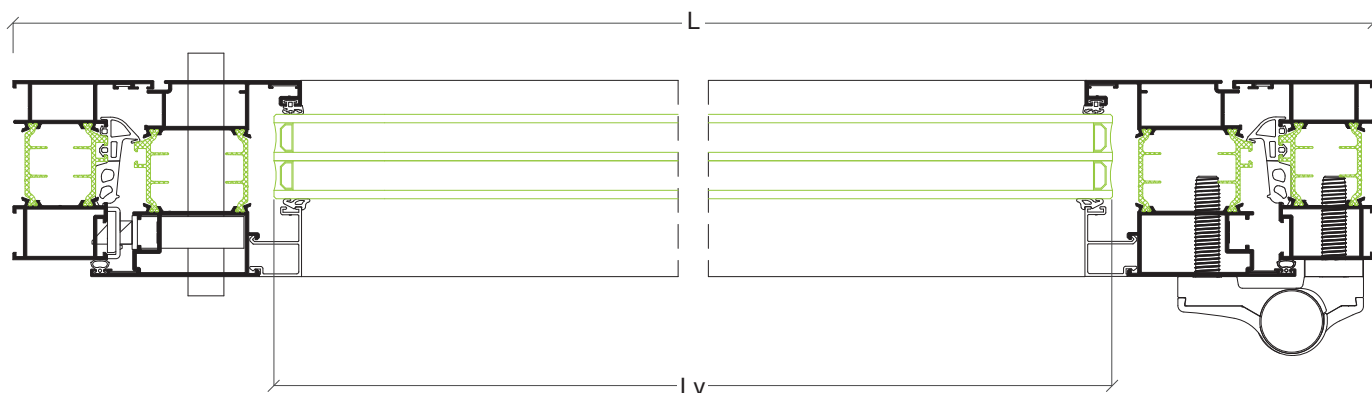
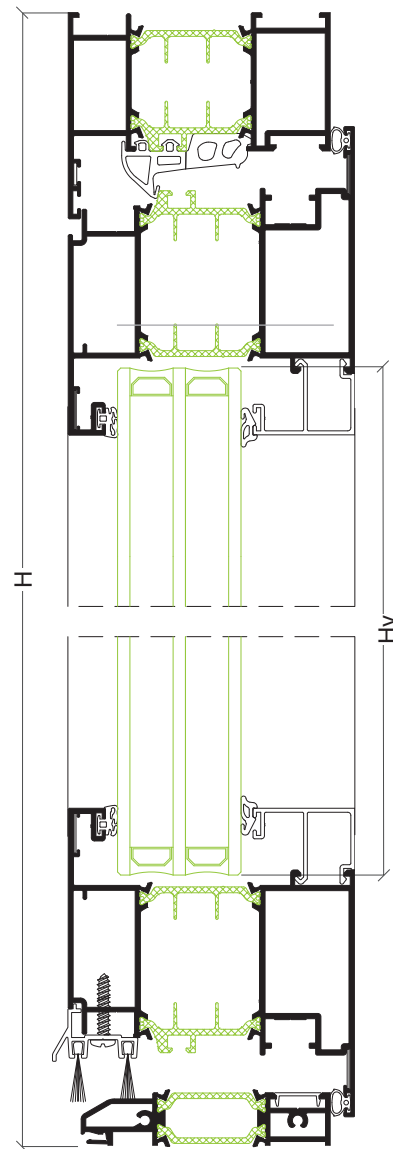



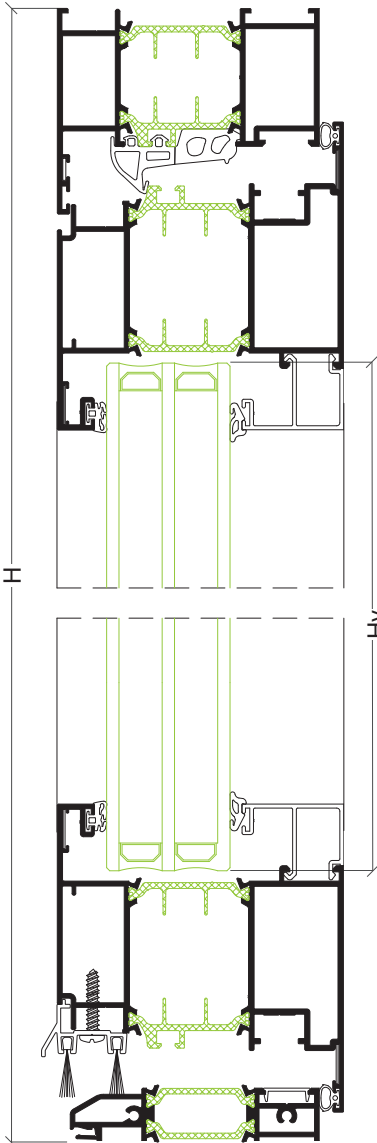
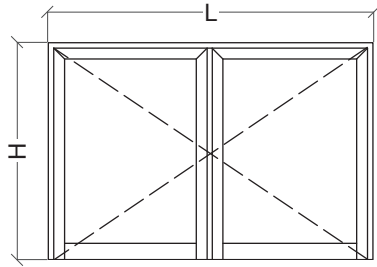

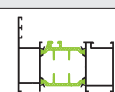

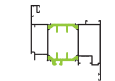



**VIDRO • VIDRIO**

Hv = H-220 mm	Lv = L-247 mm
---------------	---------------

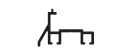



**Porta 2 folhas • Puerta 2 hojas**

**PERFIS • PERFIS**

DESENHO • DESEÑO	REF.	DESCRIÇÃO • DESCRIPCIÓN	CORTE CORTE	QUANTIDADE CANTIDAD	MEDIDAS • MEDIDA
	API-08	Aro fixo Marco		1	L
				2	H
	API-122	Aro móvel Hoja		4	L/2-39.5 mm
				4	H-46 mm
	API-117	Inversor Inversor		1	H-122 mm
	---	Bite Junquillo		4	L/2-199.5 mm
				4	H-246 mm
	AJi-62	Pingadeira Alargadera		2	L/2-106 mm L/2-38 mm
	APi-63	Soleira Solape inferior puerta		1	L-80.5 mm
	KL-04	Perfil tampa Perfil de tapa		1	L-90 mm

**ACESSÓRIOS E JUNTAS • ACCESORIOS Y JUNTAS**







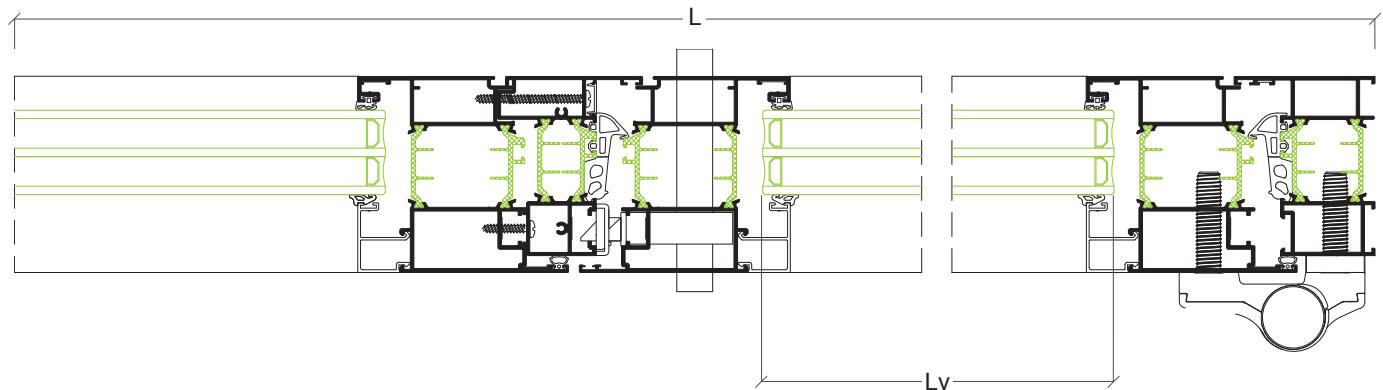



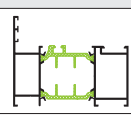

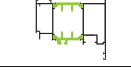

REF.	DESCRIÇÃO • DESCRIPTION	QUANTIDADE CANTIDAD
30 60 16 02	Esquadro interior • Escuadra interior	2
30 60 00 02	Esquadro exterior • Escuadra exterior	2
30 60 16 04	Esquadro exterior móvel • Escuadra exterior hoja	8
30 60 16 05	Esquadro interior móvel • Escuadra interior hoja	8
30 96 00 23	Esquadro alinhamento fixo • Escuadra alineamiento fijo	2
30 96 00 22	Esquadro alinhamento móvel • Escuadra alineamiento hoja	16
30 96 10 01	calço para vidro • Calzo para vidrio	8
30 92 22 88 ou 89	Dobradiça 2 abas porta • Bisagra 2 abas puerta	4
30 60 16 20	Fechadura 3 pontos • Cierre 3 puntos	1
30 92 16 23 ou 24	Conjunto chapa-testas para inversor • Conjunto cierre bombillo para inversor	1
30 92 22 82 ou 83	Puxador duplo • Manilla doble	1
30 92 22 85 ou 86	Escudo para canhão • Contracierre para bombillo	2
30 92 13 03	Canhão • Bombillo Cierre	1
30 70 16 12	Jogo topos inversor • Juego topes inversor	1
30 93 01 20	Junta interior • Junta interior	2L+4H
30 70 16 30	Junta central • Junta central	L+3H
30 70 16 31	Canto vulcanizado • Angulo vulcanizado	2
30 60 00 13	Conjunto topos AJi-62 • Conjunto topes AJi-62	1
30 60 00 14	Pelúcia preta 18 mm • Burieta negra 18 mm	2L
---	Junta para vidro (exterior) • Junta para vidrio (exterior)	2L+4H
---	Junta para vidro (interior) • Junta para vidrio (interior)	2L+4H

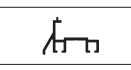
**VIDRO • VIDRIO**

Hv = H-220 mm	Lv = L/2-213 mm
---------------	-----------------



**Porta 2 folhas abertura exterior • Puerta 2 hojas abertura exterior**
**PERFIS • PERFIS**

DESENHO • DESEÑO	REF.	DESCRIÇÃO • DESCRIPCIÓN	CORTE CORTE	QUANTIDADE CANTIDAD	MEDIDAS • MEDIDA
	API-08	Aro fixo Marco		1	L
			2	H	
	API-172	Aro móvel Hoja		4	L/2-39.5 mm
			4	H-46 mm	
	API-117	Inversor Inversor		1	H-122 mm
	---	Bite Junquillo		2	L/2-199.5 mm
				2	H-246 mm
	AJi-62	Pingadeira Alargadera		2	L/2-106 mm L/2-38 mm
	API-63	Soleira Solape inferior puerta		1	L-80.5 mm
	KL-04	Perfil tampa Perfil de tapa		1	L-90 mm

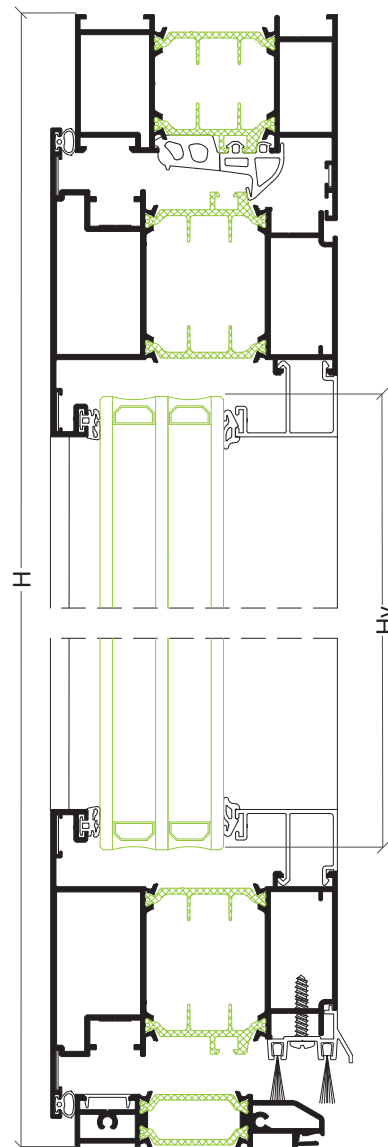
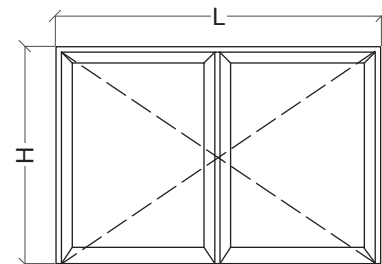

**ACESSÓRIOS E JUNTAS • ACCESORIOS Y JUNTAS**

REF.	DESCRIÇÃO • DESCRIPTION	QUANTIDADE CANTIDAD
30 96 00 05	Esquadro interior fixo • Escuadra interior fijo	2
30 60 00 02	Esquadro exterior • Escuadra exterior	2
30 60 16 04	Esquadro exterior móvel • Escuadra exterior hoja	8
30 60 16 05	Esquadro interior móvel • Escuadra interior hoja	8
30 96 00 23	Esquadro alinhamento fixo • Escuadra alineamiento fijo	2
30 96 00 22	Esquadro alinhamento móvel • Escuadra alineamiento hoja	16
30 96 10 01	Calço para vidro • Calzo para vidrio	8
30 92 22 88 ou 89	Dobradiça 2 abas porta • Bisagra 2 abas puerta	4
30 60 16 20	Fechadura 3 pontos • Cierre 3 puntos	1
30 92 22 82 ou 83	Puxador duplo • Manilla doble	1
30 92 22 85 ou 86	Escudo para canhão • Contracierre para bombillo	2
30 70 16 12	Jogo topos inversor • Juego topes inversor	1
30 92 13 03	Canhão • Bombillo Cierre	1
30 93 01 20	Junta interior • Junta interior	2L+4H
30 70 16 30	Junta central • Junta central	L+3H
30 70 16 31	Canto vulcanizado • Angulo vulcanizado	2
30 60 00 13	Conjunto topos AJi-62 • Conjunto topes AJi-62	1
30 60 00 14	Pelúcia preta 18 mm • Burlete negro 18 mm	2L
---	Junta para vidro (exterior) • Junta para vidrio (exterior)	2L+4H
---	Junta para vidro (interior) • Junta para vidrio (interior)	2L+4H
30 60 16 23 ou 24	Conjunto chapa-testas para inversor • Conjunto cierre bombillo para inversor	1

**VIDRO • VIDRIO**

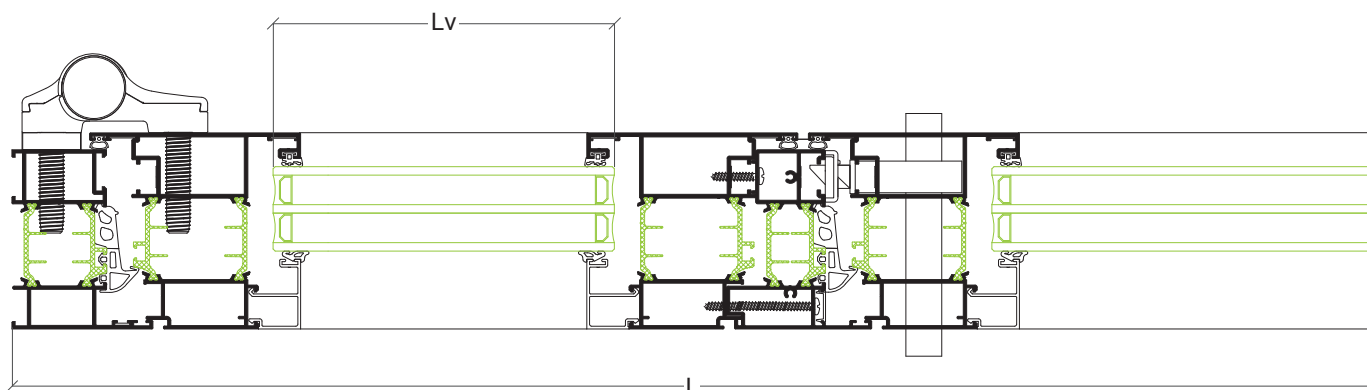
Hv = H-220 mm	Lv = L/2-213 mm
---------------	-----------------

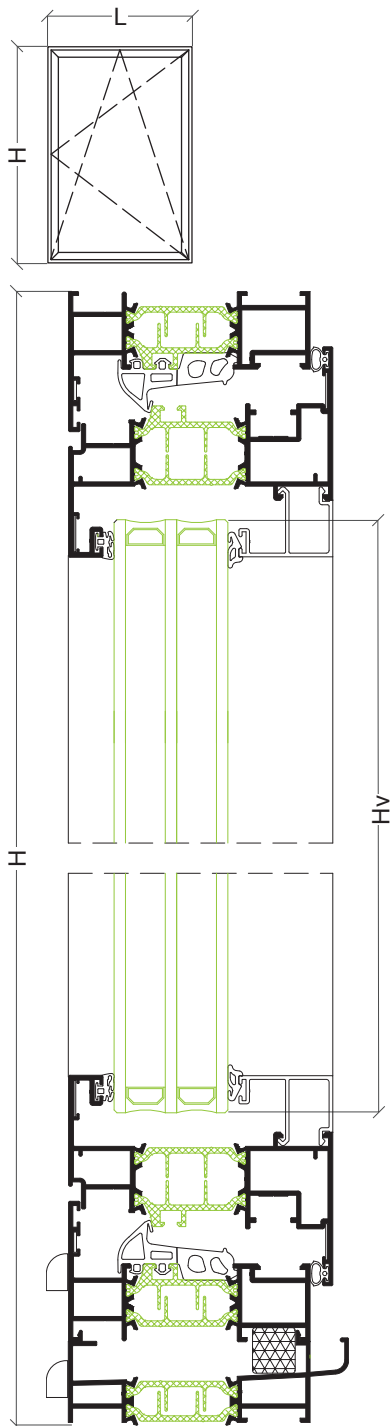

**Janela 1 folha abrir e oscilo-batente • Ventana 1 hoja abisagrada y oscilobatiente**

**PERFIS • PERFIS**

DESENHO • DISEÑO	REF.	DESCRIÇÃO • DESCRIPCIÓN	CORTE CORTE	QUANTIDADE CANTIDAD	MEDIDAS • MEDIDA
	API-03	Aro fixo Marco		2	L
				2	H-28.5 mm
	API-161	Aro móvel Hoja		2	L-39 mm
				2	H-67.5 mm
	---	Bite Junquillo		2	L-147 mm
				2	H-215.5 mm
	API-34	Soleira Condensación		1	L

**ACESSÓRIOS E JUNTAS • ACCESORIOS Y JUNTAS**

REF.	DESCRIÇÃO • DESCRIPTION	QUANTIDADE CANTIDAD
30 60 16 01	Esquadro interior móvel • Escuadra interior hoja	4
30 60 00 01	Esquadro exterior • Escuadra exterior	8
30 96 00 23	Esquadro alinhamento fixo • Escuadra alineamiento fijo	4
30 96 00 22	Esquadro alinhamento móvel • Escuadra alineamiento hoja	8
30 96 10 01	CCalço para vidro • Calzo para vidrio	6
---	Puxador • Manilla	1
---	Ferragem canal 16 • Herraje canal 16	1
30 92 01 02	Goteira com válvula preto • Vierteaguas com válvula negro	4 ó más
30 96 00 12	Jogo topes condensação • Juego topes condensación	1
30 92 04 70	Espuma isolante • Espuma aislante	L
30 93 01 20	Junta interior • Junta interior	2L+2H
30 70 16 30	Junta central • Junta central	2L+2H
30 70 16 31	Canto vulcanizado • Angulo vulcanizado	4
---	Junta para vidro (exterior) • Junta para vidrio (exterior)	2L+2H
---	Junta para vidro (interior) • Junta para vidrio (interior)	2L+2H
30 96 00 04	Esquadro inferior fixo • Escuadra inferior fijo	4

**VIDRO • VIDRIO**

Hv = H-189 mm	Lv = L-161 mm
---------------	---------------

