

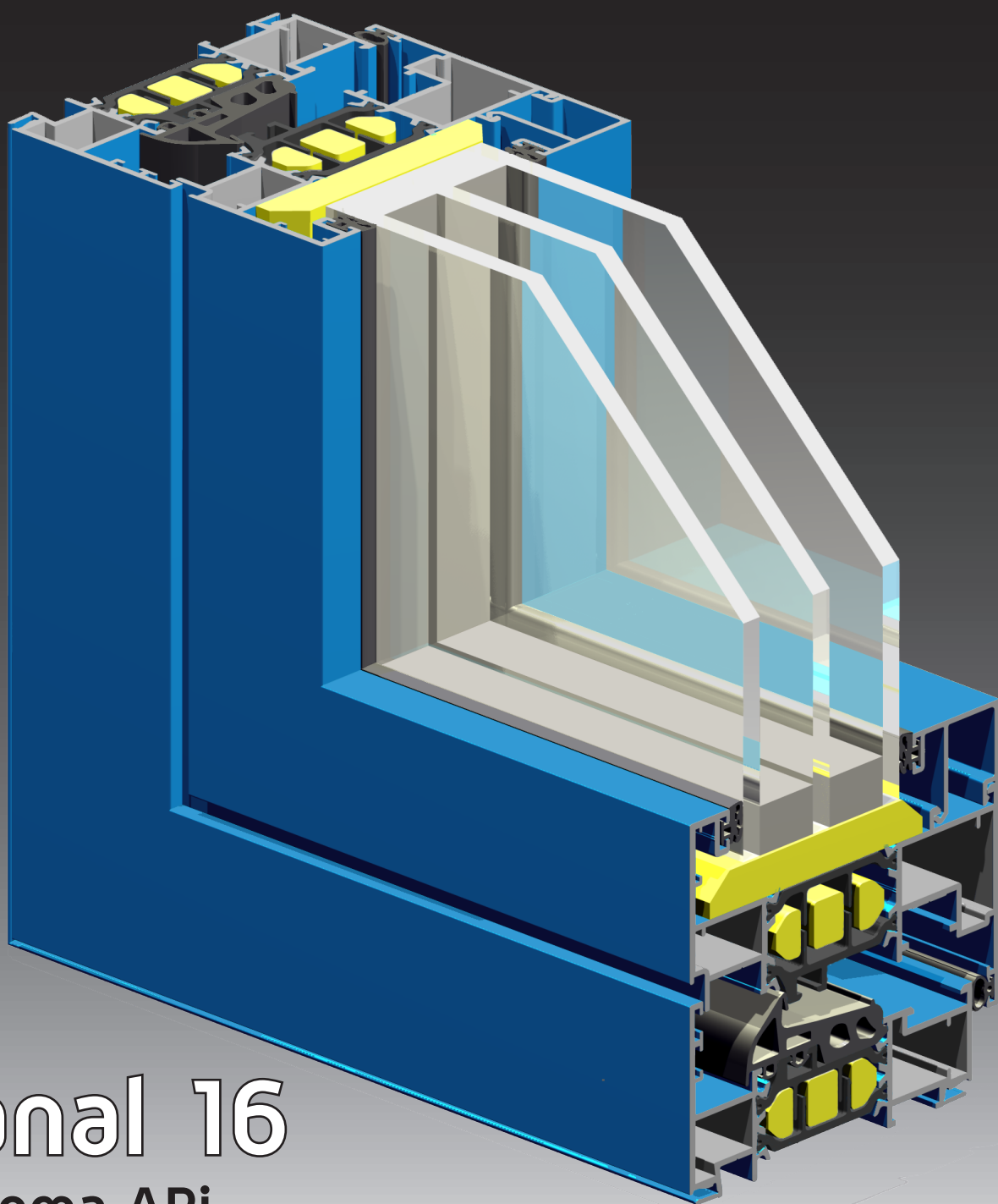

anicolor

Sistemas de Aluminio



Canal 16

Sistema APi

Rotura térmica 85 mm

Sistema APi Canal 16

Sistema de batente com RPT - 85 mm

Características do sistema

Sistema de batente com rotura térmica de elevadas prestações térmicas e acústicas.

O sistema APi Canal 16 foi concebido com câmara de 16 mm para permitir a aplicação de ferragens especiais com afinação tridimensional para uma maior eficácia em termos de performance, desempenho e segurança.

O sistema APi Canal 16 possibilita a execução de 3 versões de caixilharia:

1. Linha reta;
2. Linha curva;
3. Linha oval.

O sistema APi Canal 16 permite a aplicação de vidros duplos ou triplos de alto rendimento de modo a responder às exigências de isolamento térmico e acústico, de acordo com a diretiva nº 2010/31/EU.

Com um óptimo isolamento térmico aliado à aplicação de um inovador produto designado por bagueete ThermoProfile, o Sistema APi Canal 16 proporciona elevadas prestações de conforto e de economia energética, satisfazendo os requisitos do Decreto-Lei nº 194/2015 e da Portaria 379-A/2015.

Perfis de alumínio

Os perfis de alumínio são extrudidos na liga de alumínio 6060 para arquitetura de acordo com norma NP EN 12020-02.

Perfis com rotura térmica obtida por inserção de varetas isolantes de poliamida tipo ómega de 39 mm, reforçadas com 25% de fibra de vidro.

Espessura média dos perfis de alumínio de 1,7 mm.

Aros fixos

Secção dos aros fixos de 85 mm com tripla câmara;

Perfis com rotura térmica com varetas de poliamida tipo ómega de 39 mm;

Aros fixos com duplo esquadro de aperto rápido e esquadros de alinhamento para montagem a meia esquadria;

Travessas com dupla união para um aperto mais eficaz;

Aros fixos tradicionais para o mercado interno;

Aros fixos com clip exterior e aba de remate direta de 25 mm ou 45 mm para o mercado francês;

Aro fixo com clip exterior e interior para aplicação de remate de 30, 50 ou 80 mm para o mercado francês;

Aros móveis

Secção dos aros móveis de 93 mm com tripla câmara;

Aros móveis com rotura térmica, obtida através de varetas de poliamidas tipo ómega de 39 mm;

Aros móveis com duplo esquadro de aperto rápido e esquadros de alinhamento para montagem a meia esquadria;

Perfil inversor com olhal para uma melhor aplicação do topo inversor.

Dimensionamento e manobralidade

Dimensões mínimas - máximas de folha: 491 mm - 1640 mm (L); 520 mm - 2840 mm (H);

Peso máximo para janelas ou portas de sacada com oscilo-batente até 130 Kg;

Peso máximo para portas de entrada até 160 Kg/folha;

Possibilidades de abertura: fixo, batente interior 1 ou 2 folhas com ou sem oscilo-batente, batente exterior, basculante, harmónio e oscilo-paralela;

Solução de perfil para portas pedonais ou de sacada de abertura interior ou exterior segundo norma PMR (pessoas com mobilidade reduzida);

Enchimento para vidro duplo ou triplo de 24 mm a 70 mm para o sistema APi Canal 16;

Três tipos de ferragens especiais para canal 16 com uma afinação tridimensional rápida e cómoda e com um tratamento superficial de alta qualidade:

- Ferragens UniJet C, UniJet D e UniJet CC Oculta.

A harmonia da ferragem UniJet C proporciona uma aplicação rápida, segura e eficiente no Sistema APi Canal 16;

A ergonomia da ferragem UniJet D, uma elegância suprema aliada às linhas contemporâneas dos perfis de alumínio;

A invisibilidade da ferragem Oculta UniJet CC concede à janela onde é aplicada uma superior distinção;

Estanquidade assegurada através de juntas em EPDM (exterior e interior com a opção de central) para o sistema APi Canal 16, com junta central termo-isolante de bi-material.

Performances

Sistema certificado por laboratório notificado para Ensaio Tipo Inicial (TT) de acordo com a norma de produto EN 14351-1:2006+A1:2011 para efeitos de Marcação CE.

Categorias alcançadas na avaliação do sistema APi Canal 16:

1. Permeabilidade ao ar: Classe 4 (normas de ensaio EN 10207 e EN 1206)
2. Estanquidade à água: Classe E1950 (normas de ensaio EN 12208 e EN 1027)
3. Resistência ao vento: Classe C5 (normas de ensaio EN 12210 e EN 12211)

Coefficiente de transmissão térmica de vão de 2 folhas, Sistema APi Canal 16, com 1.20m x 1.50m com vidro triplo Ug = 0.5 W/m2K com intercalar efeito "Warm Edge":

- Uw = 1.09 W/m2K

Coefficiente de atenuação acústica de vão de 2 folhas:

- Rw (C; Ctr) = 41 dB (-2; -5)

Zonas de aplicação segundo os regulamentos REH e RECS (em função do valor Ug): I1, I2, I3, V1, V2, V3.

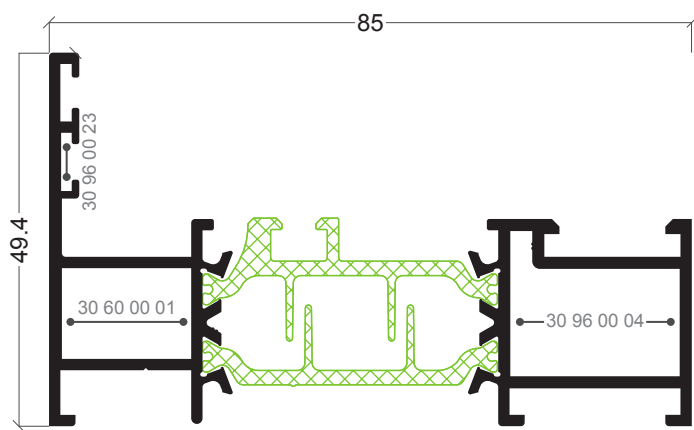

API-03
Aro fixo

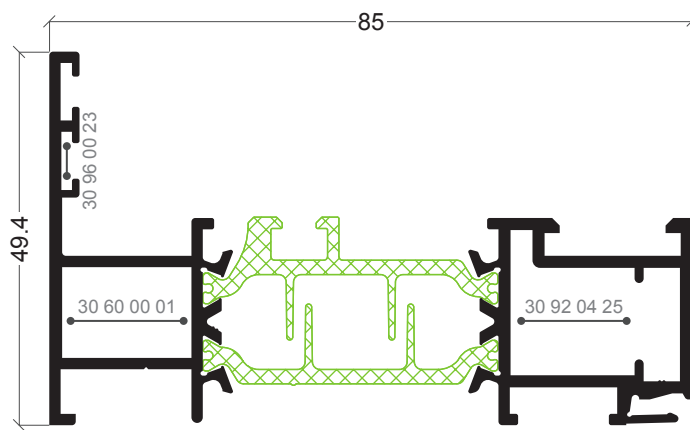

API-91
Aro fixo

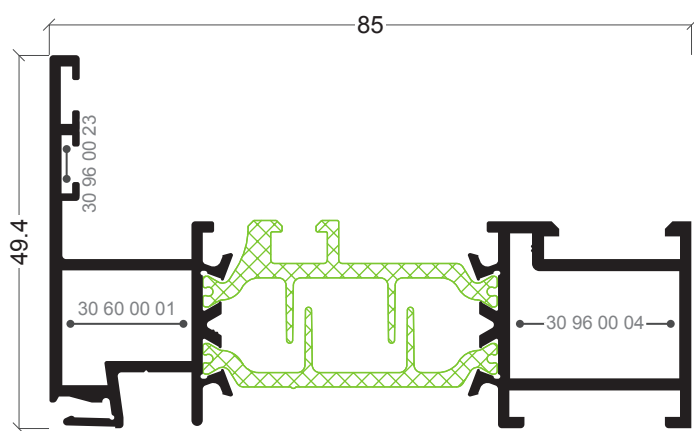

API-76
Aro fixo

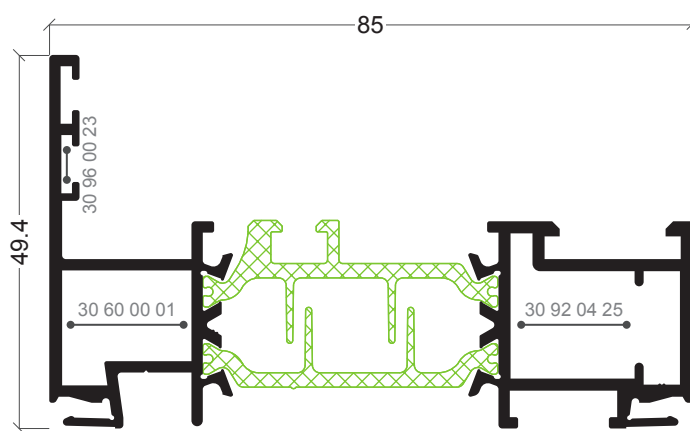

API-80
Aro fixo

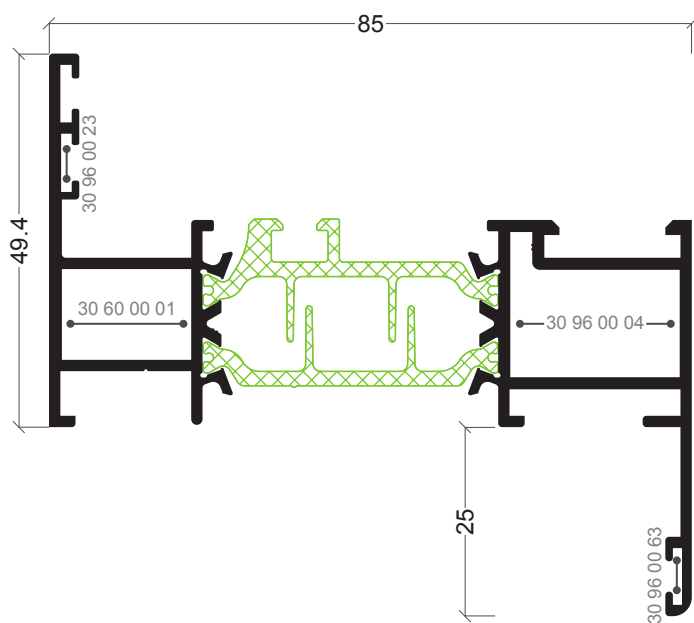

API-35
Aro fixo com remate 25 mm

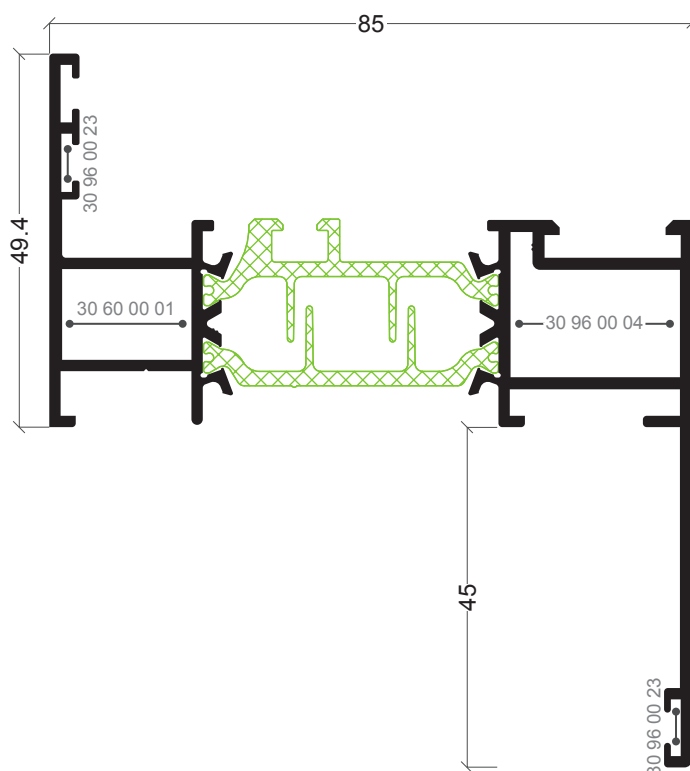

API-33
Aro fixo com remate 45 mm

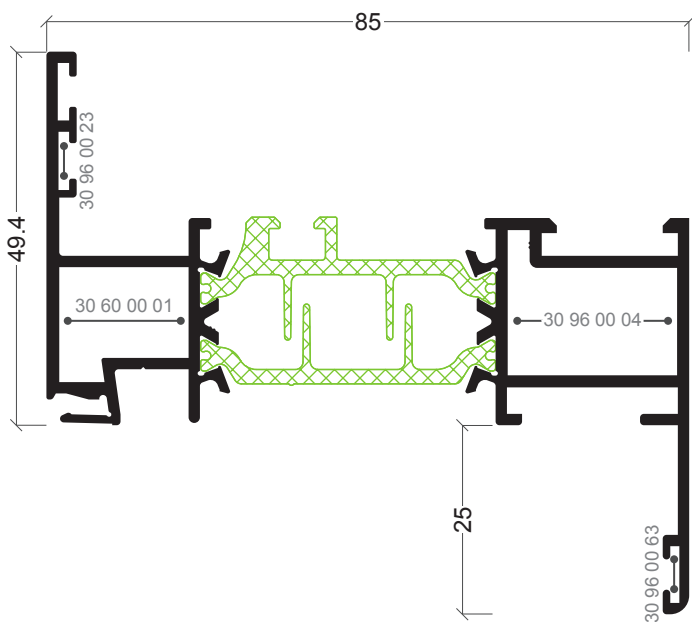

APi-74
Aro fixo com remate 25 mm

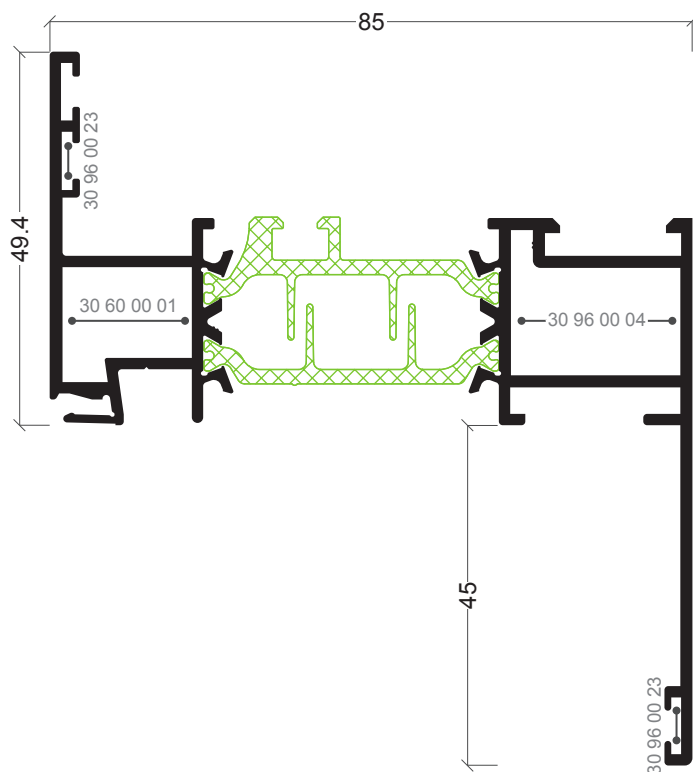

APi-75
Aro fixo com remate 45 mm

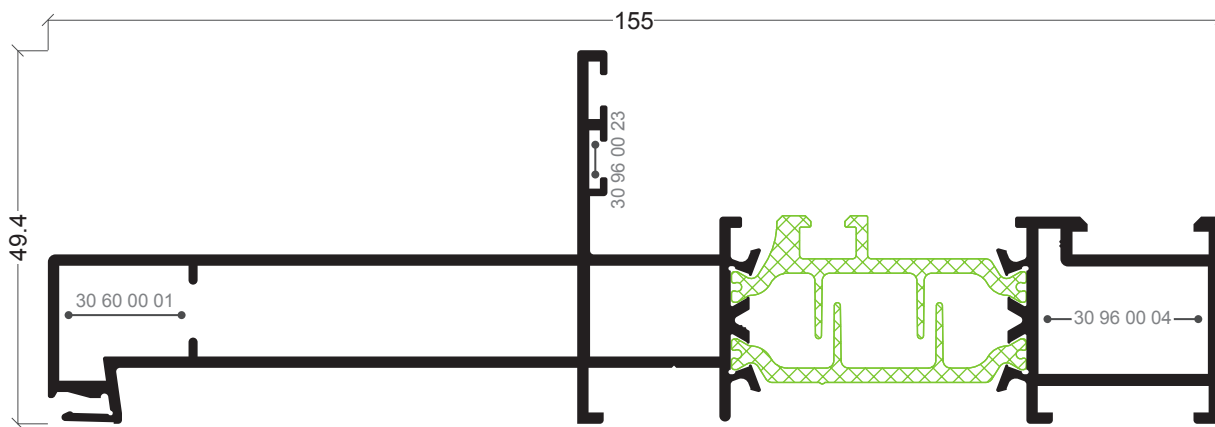

APi-89
Aro fixo

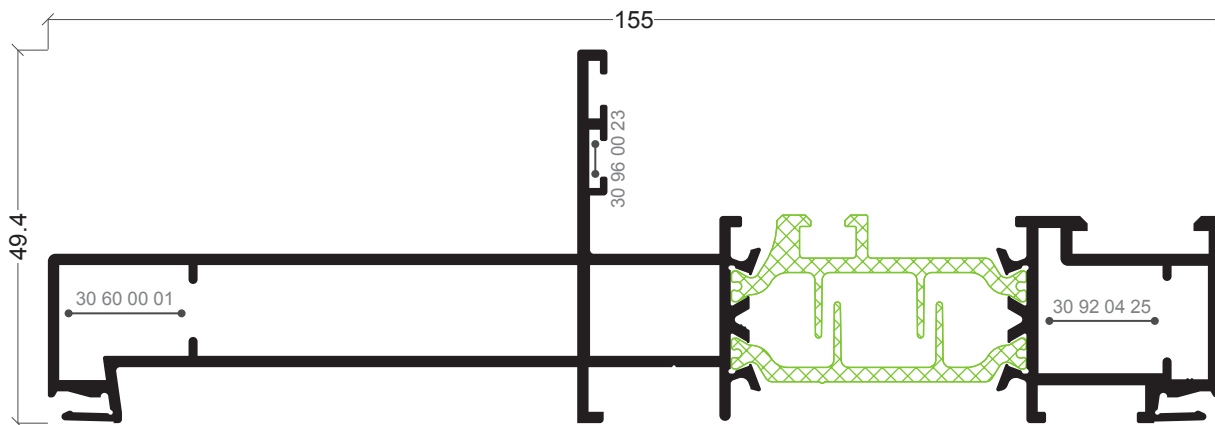

APi-88
Aro fixo

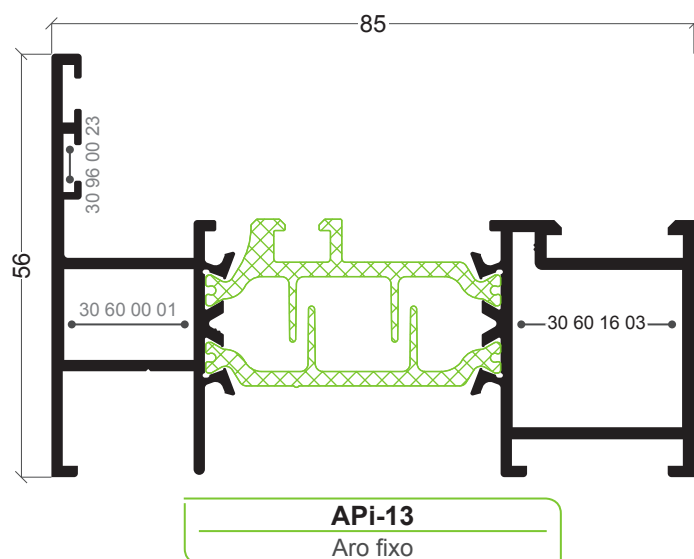
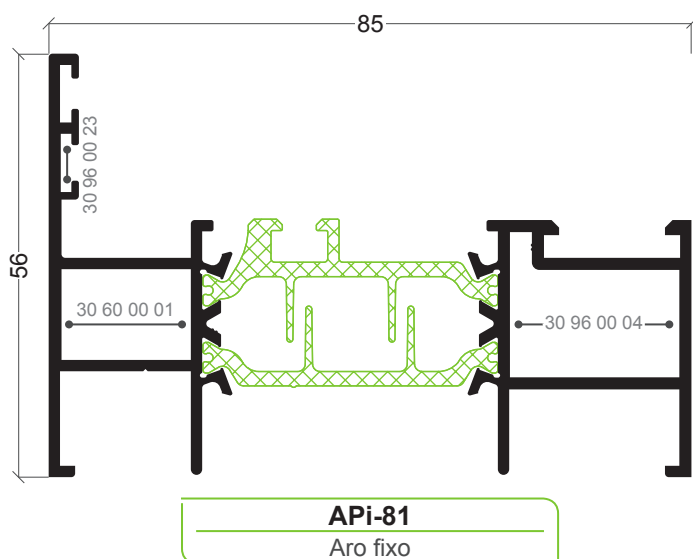
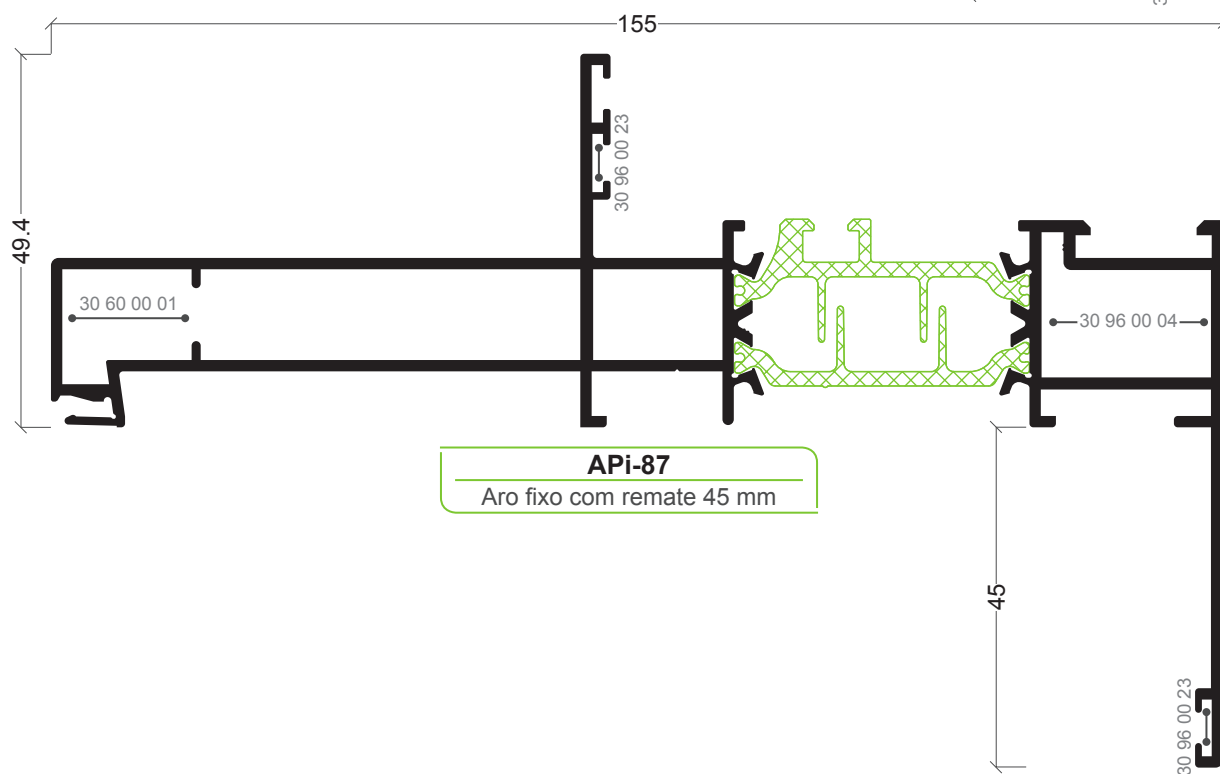
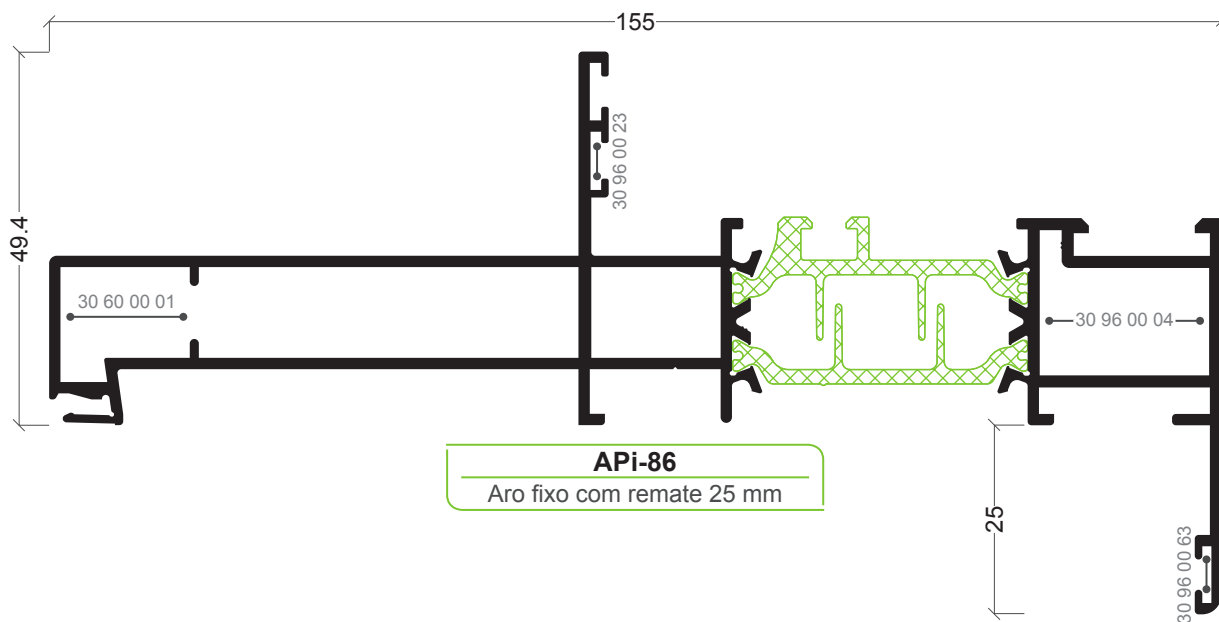

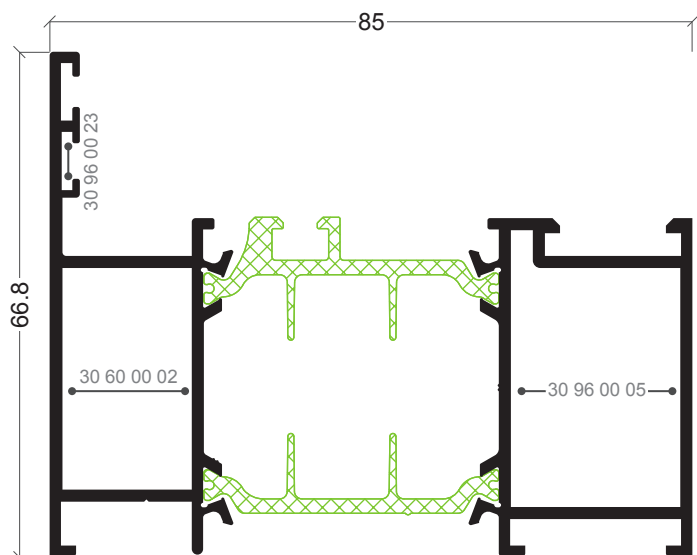

API-08
Aro fixo

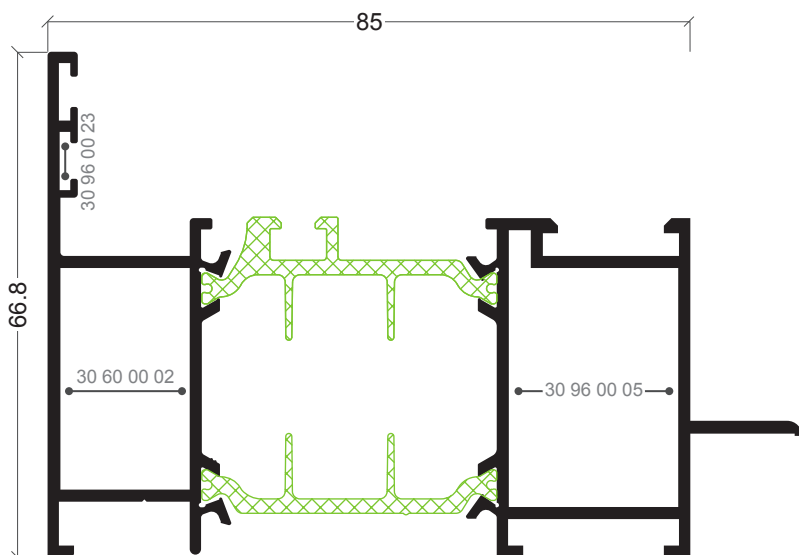

API-68
Aro fixo

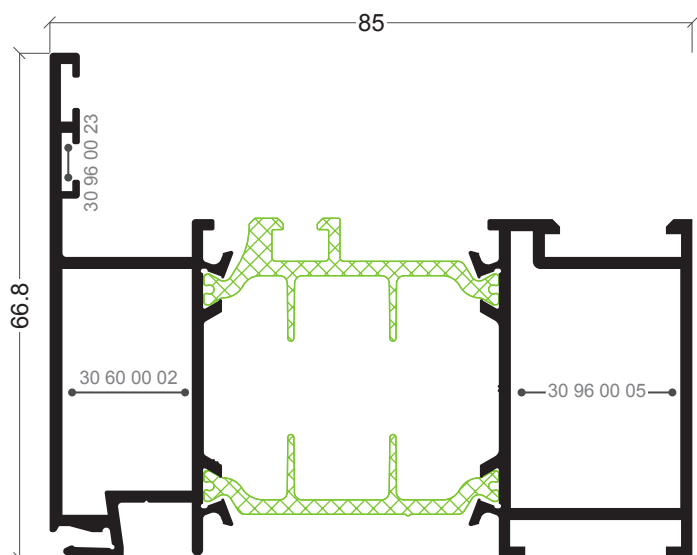

API-92
Aro fixo

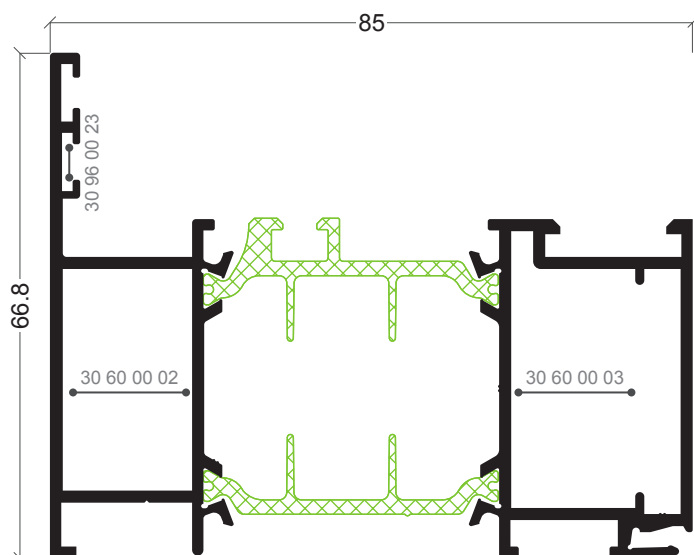

API-93
Aro fixo

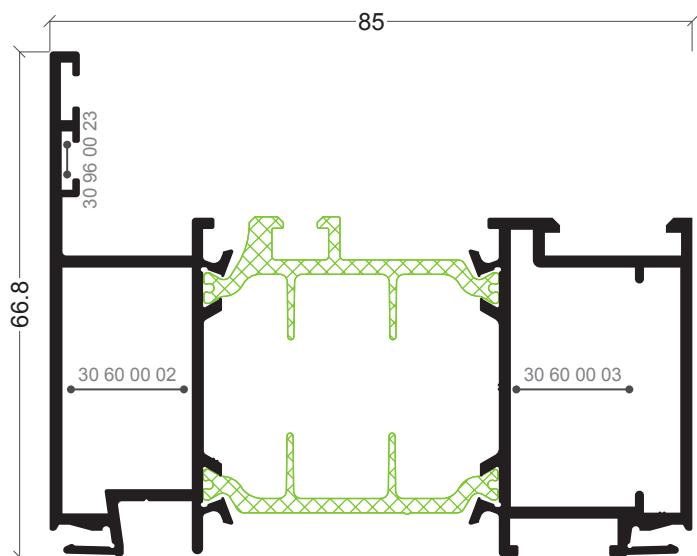

API-94
Aro fixo

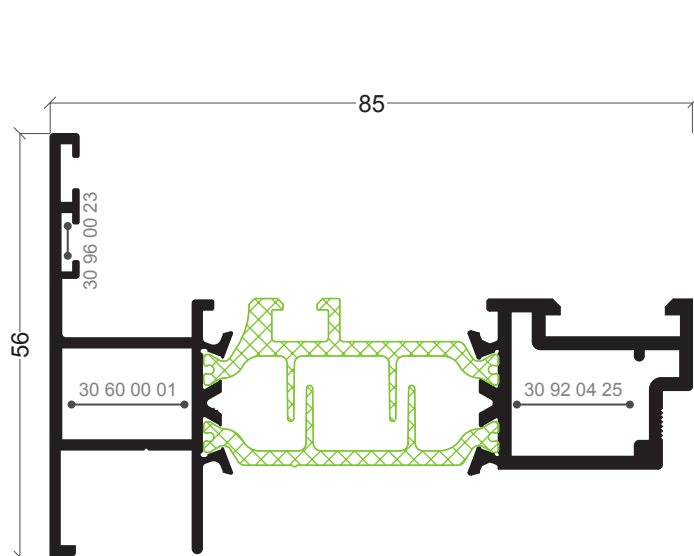

API-73
Inversor de sentido de abertura

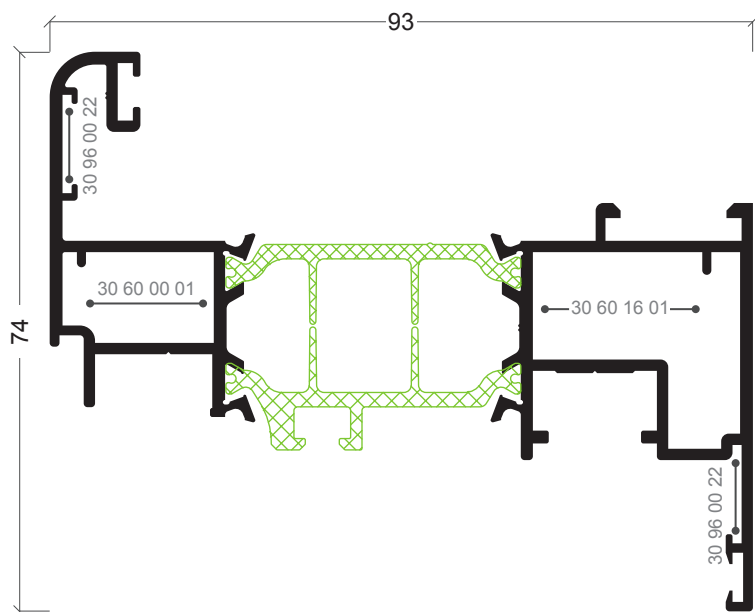

APi-105
Aro móvel

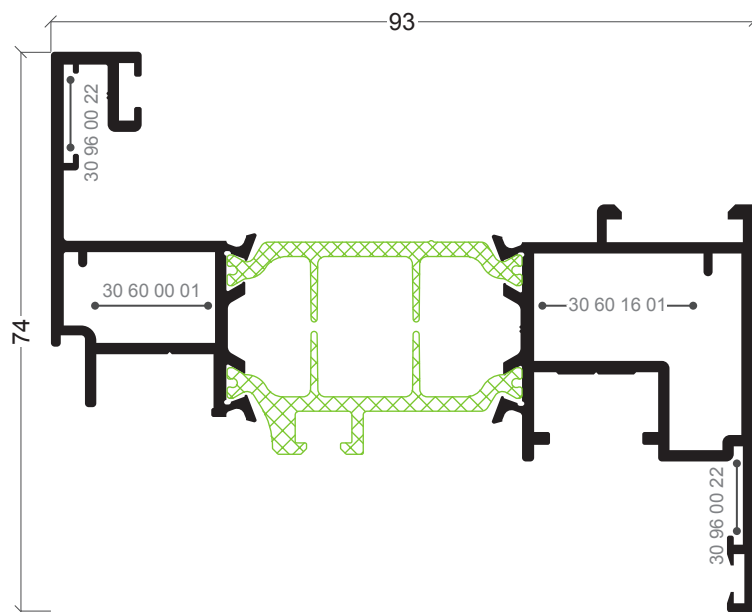

APi-161
Aro móvel

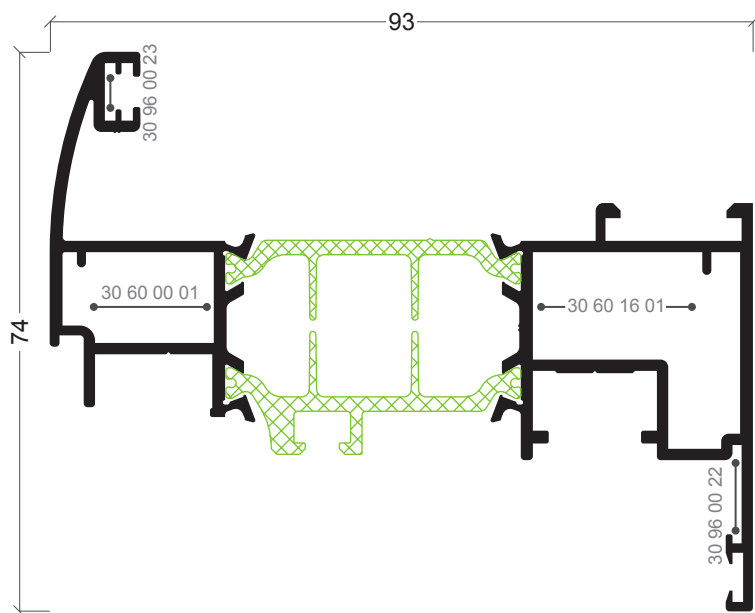

APi-183
Aro móvel

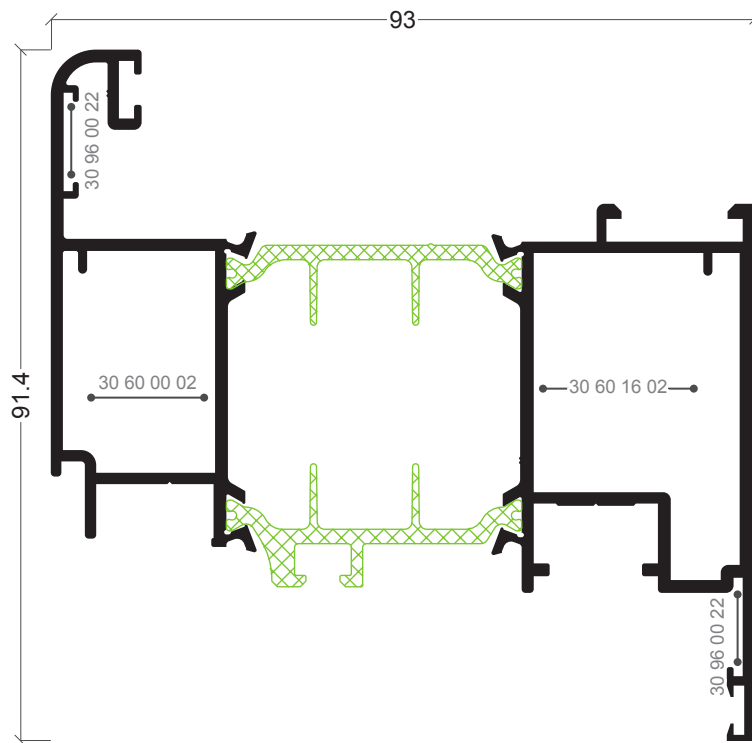

APi-110
Aro móvel sacada

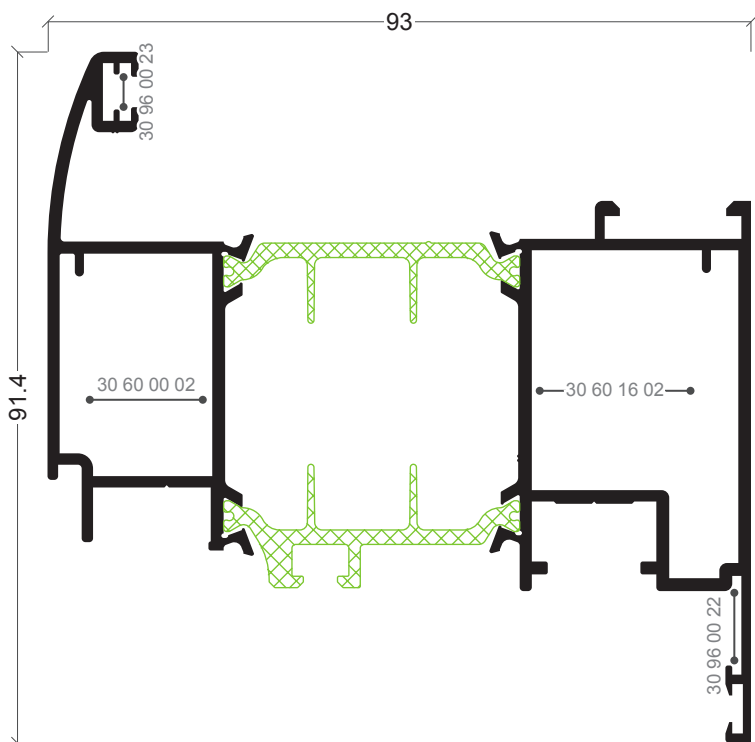

API-184
Aro móvel sacada

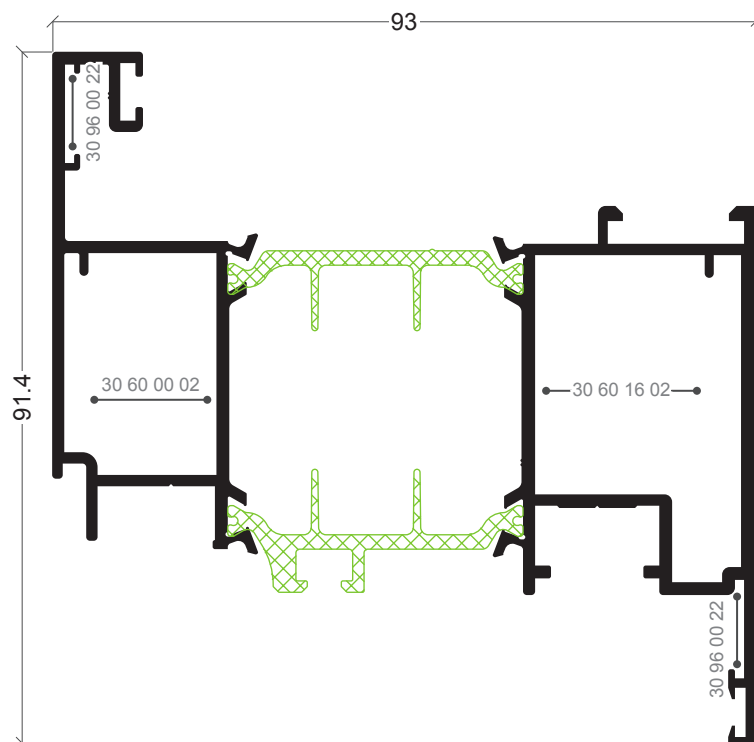

API-136
Aro móvel sacada

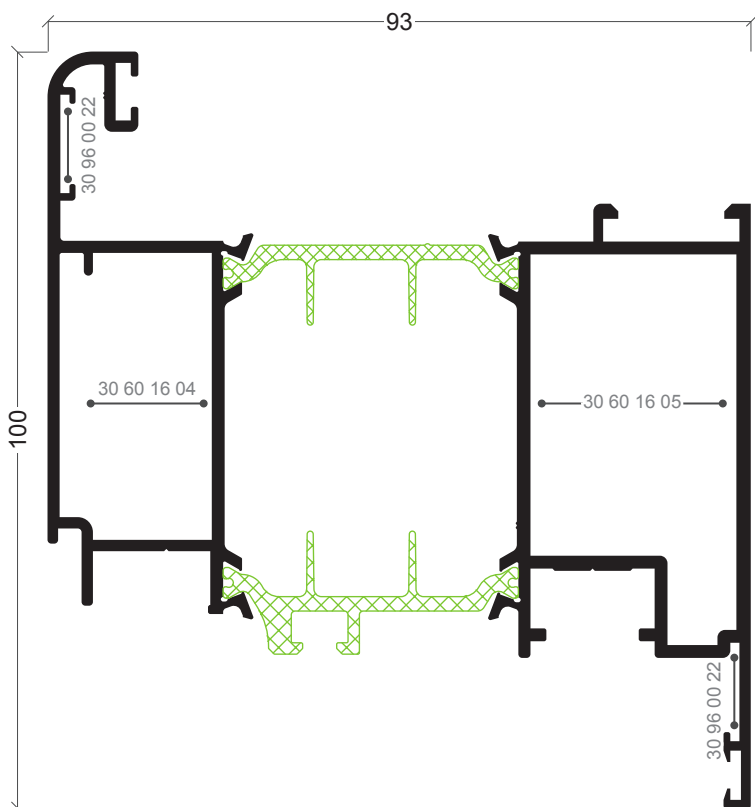

API-115
Aro móvel porta

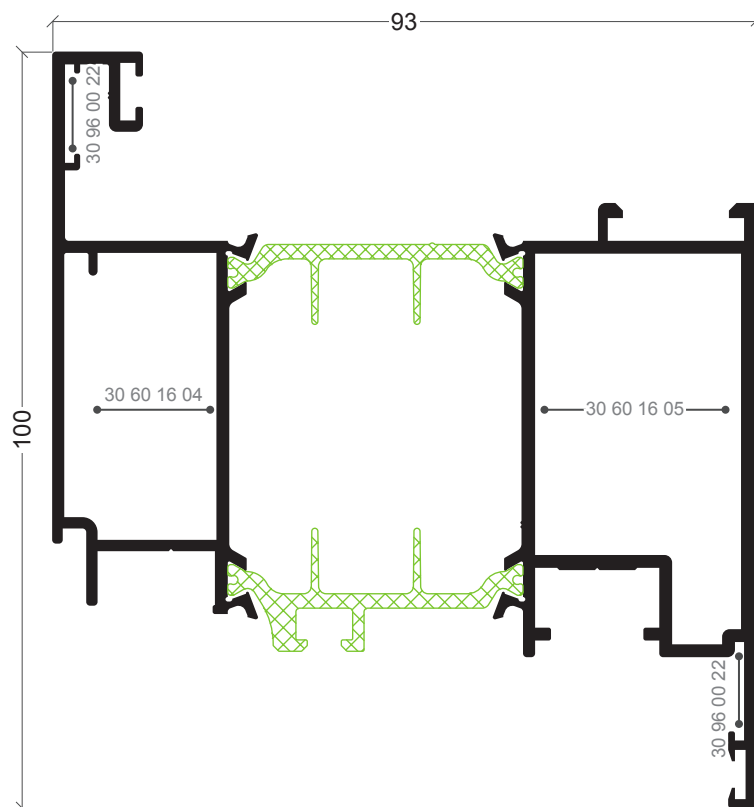

API-122
Aro móvel porta

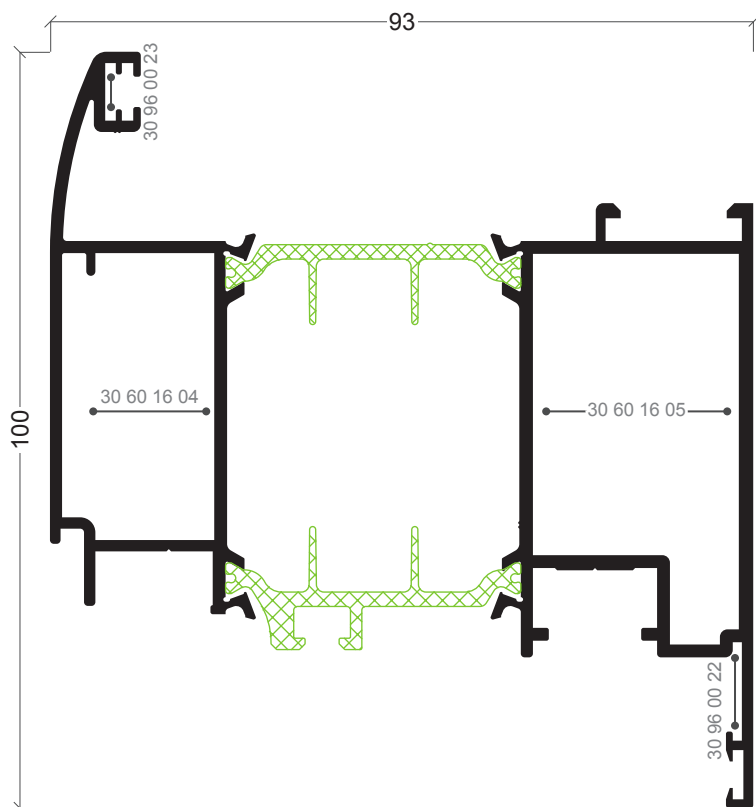

API-129
Aro móvel porta

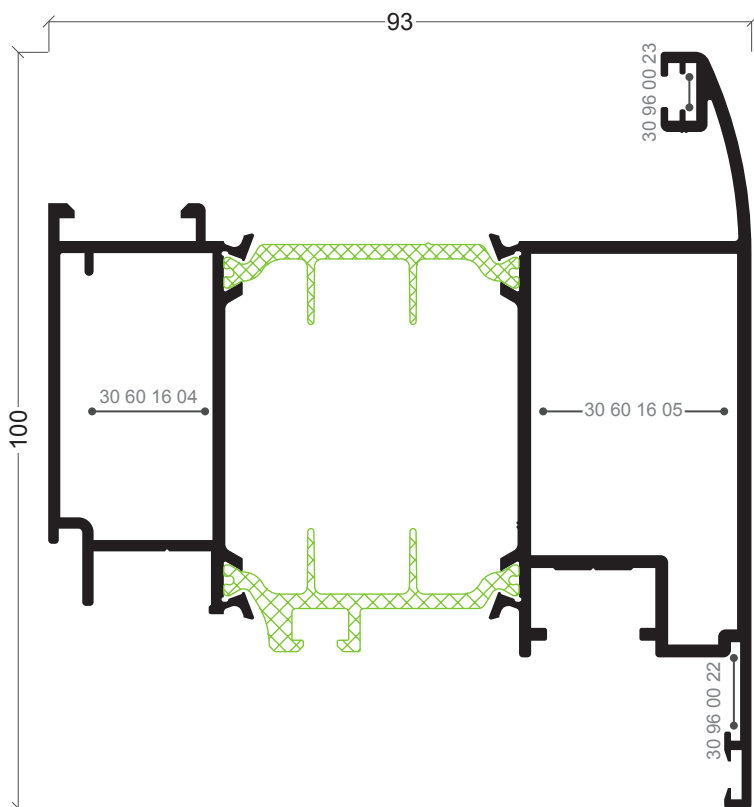

API-185
Aro móvel porta

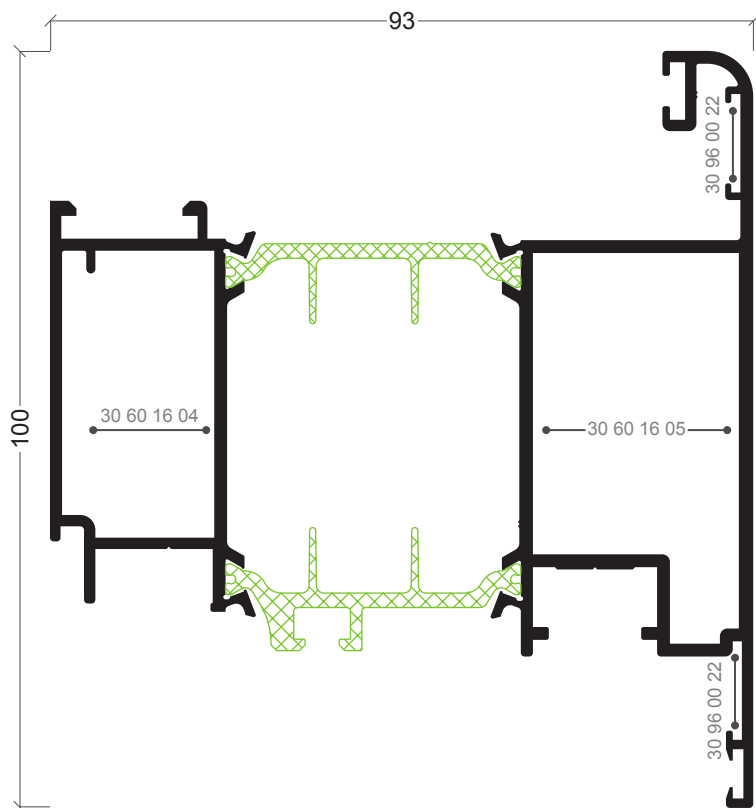

API-190
Aro móvel porta

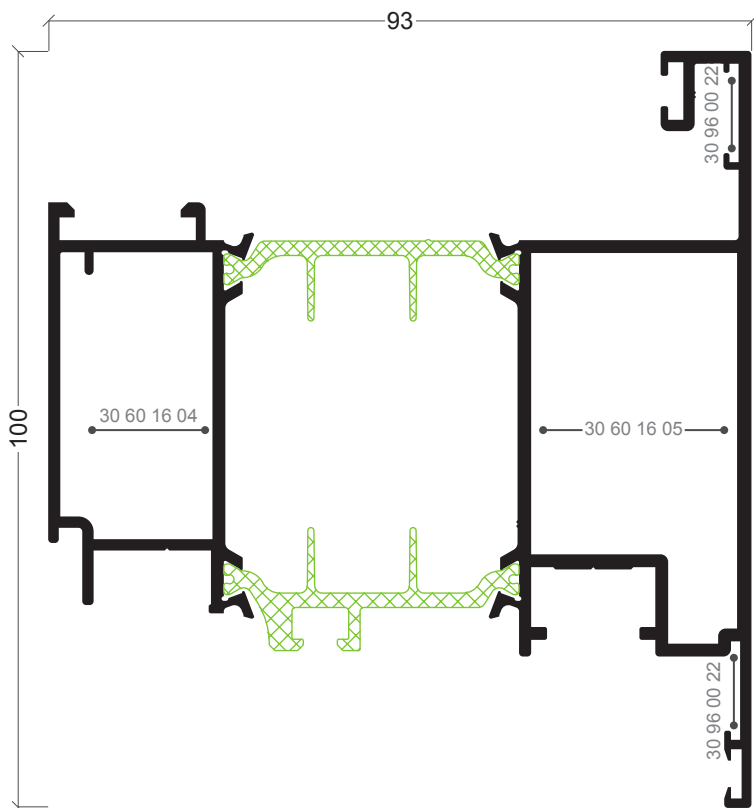

API-172
Aro móvel porta

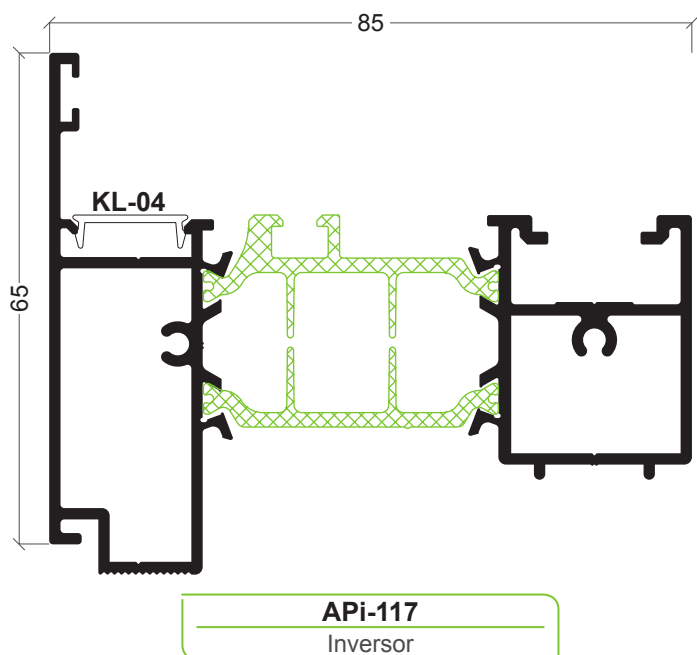

KL-04
Tampa

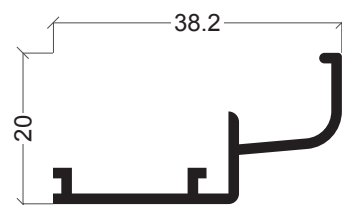

ARi-32
Perfil condensação

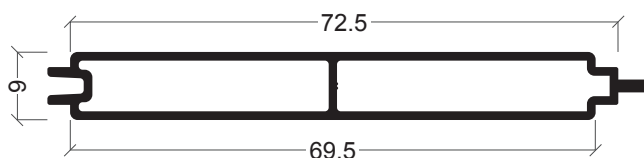

W-23
Régua tapa-luz

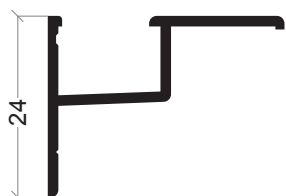

Y-20
Recolha de águas condensação

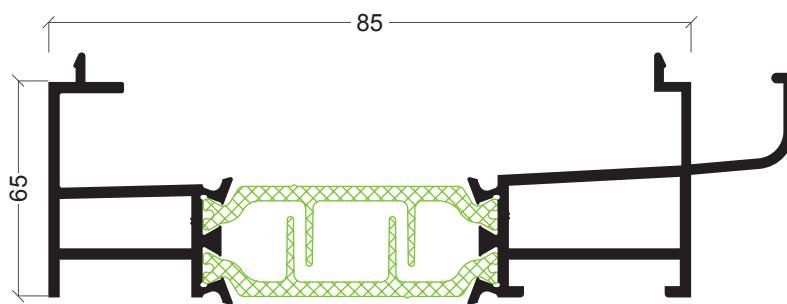

API-34
Soleira condensação

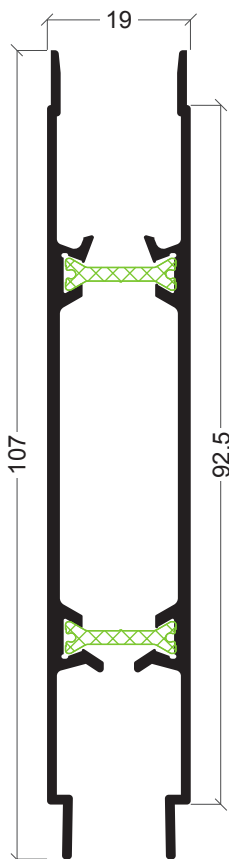

W-15

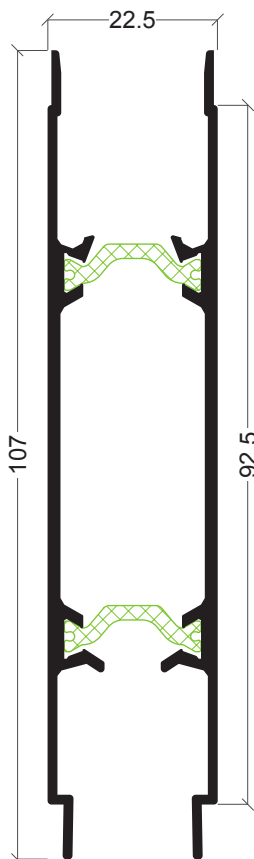

W-18

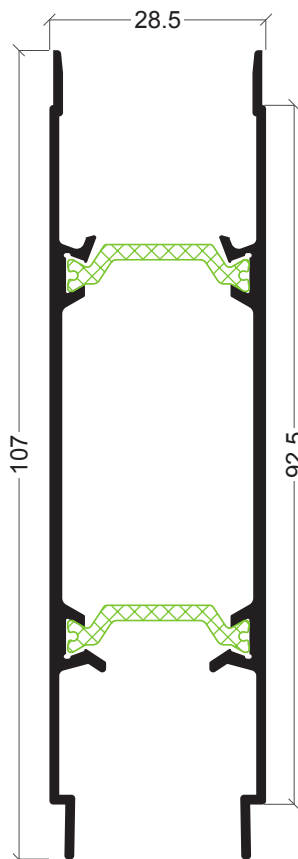

W-20

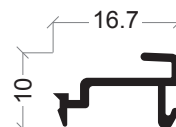

AX-33
Mola Bite

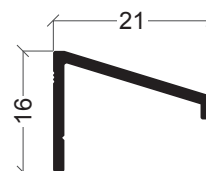

A1-46
Pingadeira janela

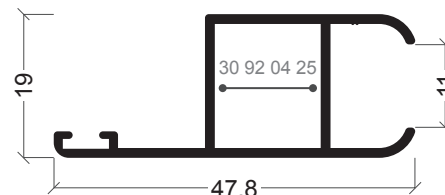

AZ-22
Tapa-luz

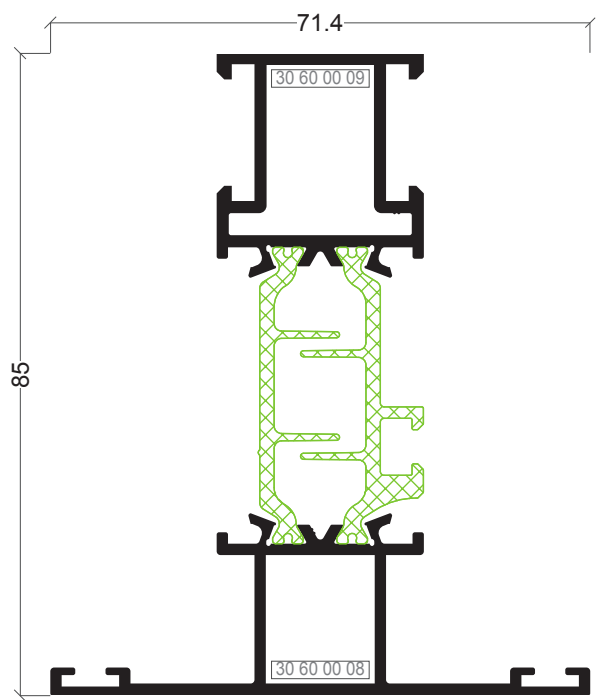

API-01
Travessa

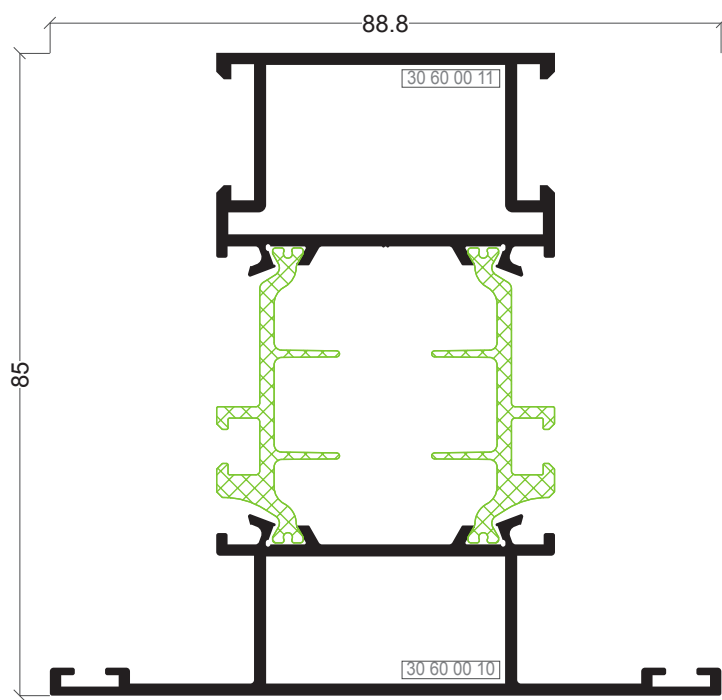

API-06
Travessa

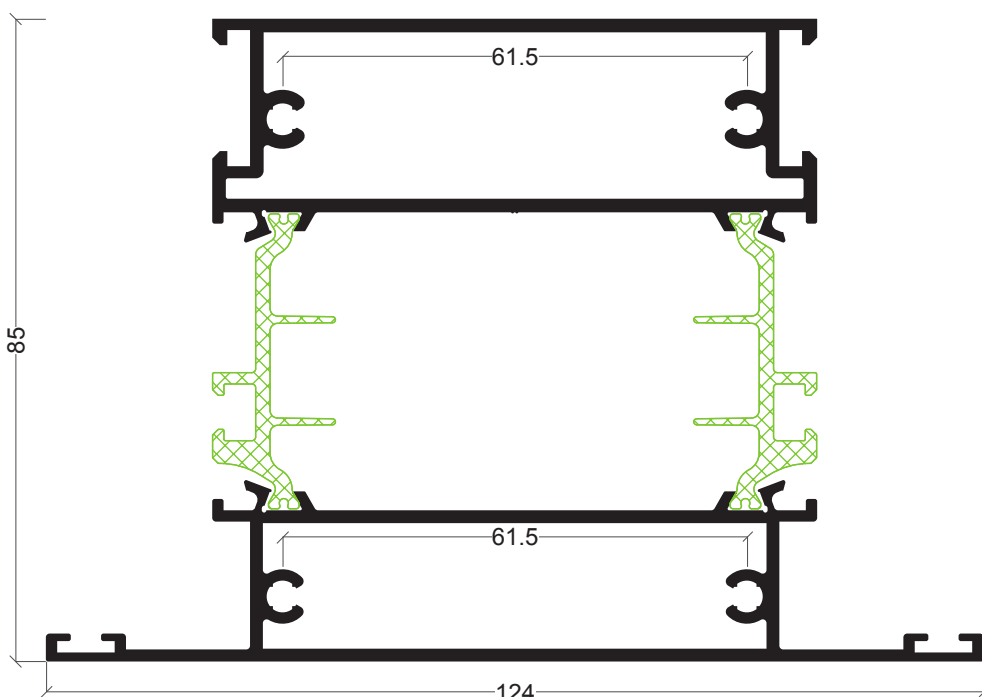

API-12
Travessa



AJi-82
Bite remate

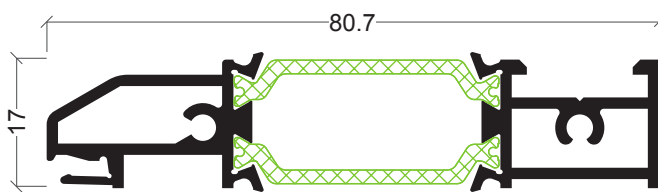

API-63
Remate inferior porta

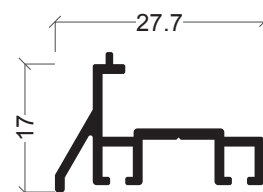

AJi-62
Pingadeira inferior porta sacada

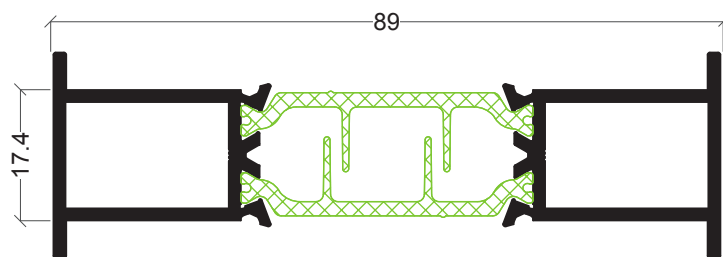

API-21

União de aros

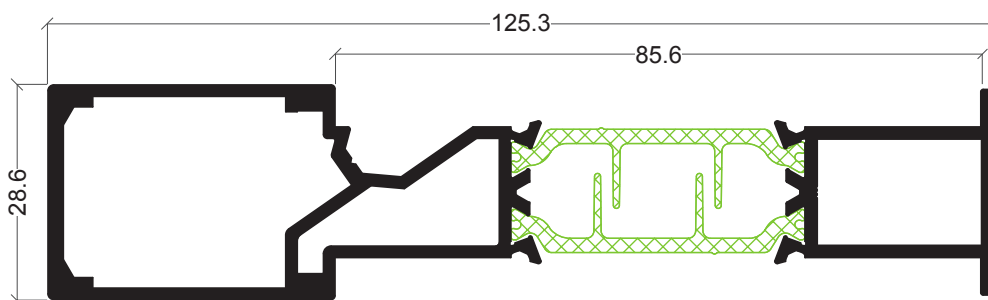

API-65

União de aros

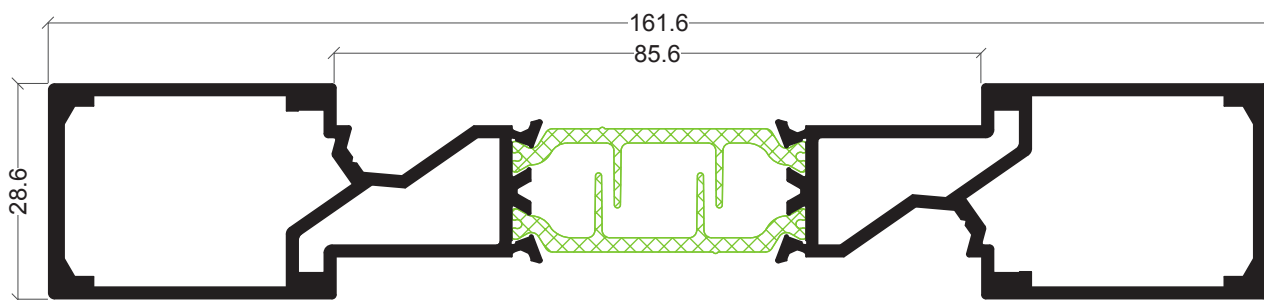

API-67

União de aros

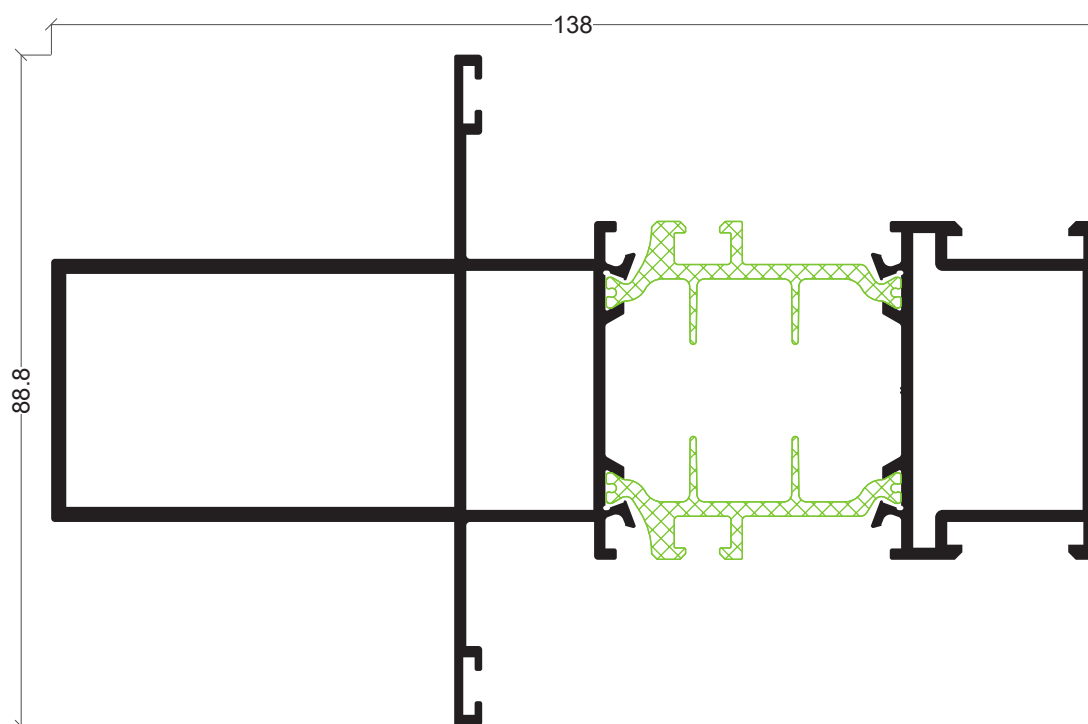

API-79

Montante reto

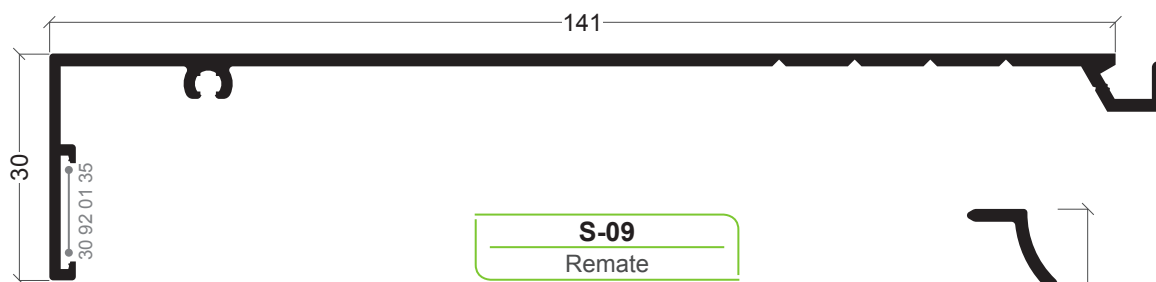

S-09
Remate

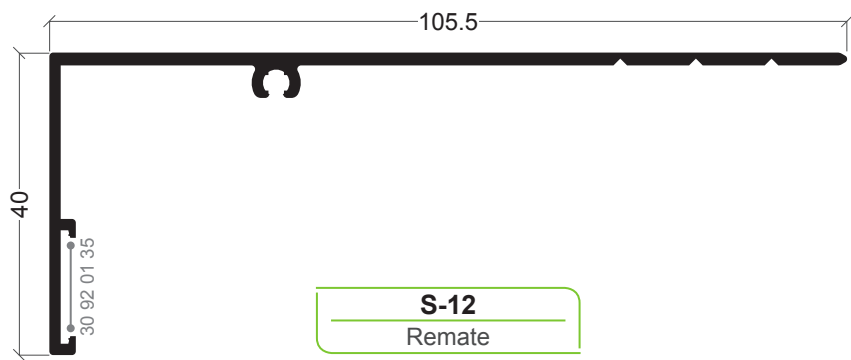

S-12
Remate

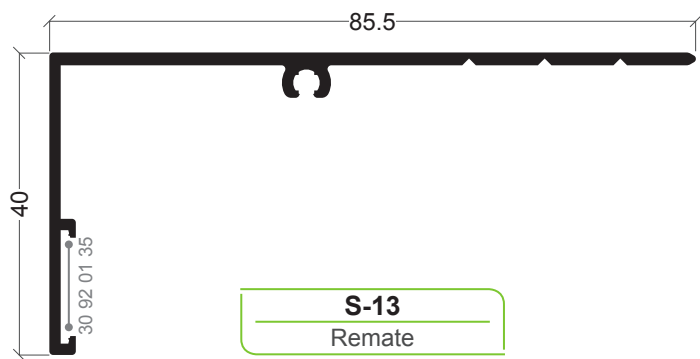

S-13
Remate

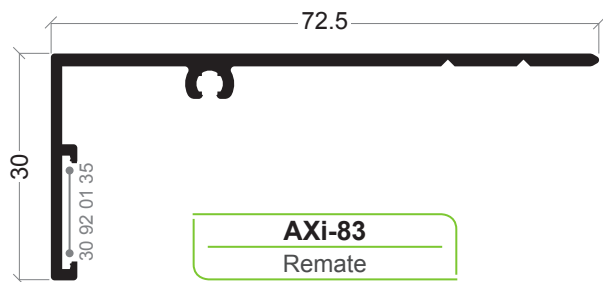

AXi-83
Remate

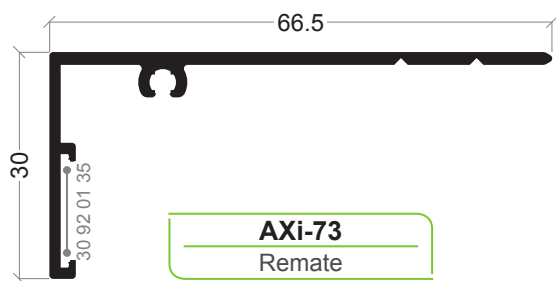

AXi-73
Remate

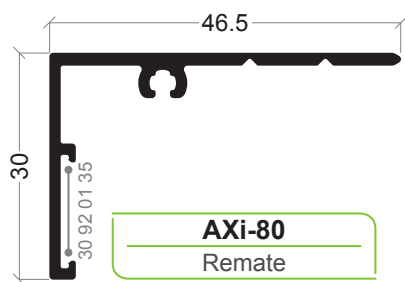

AXi-80
Remate



S-18
Remate



S-14
Remate



AXi-88
Complemento remate



AXi-91
Complemento remate

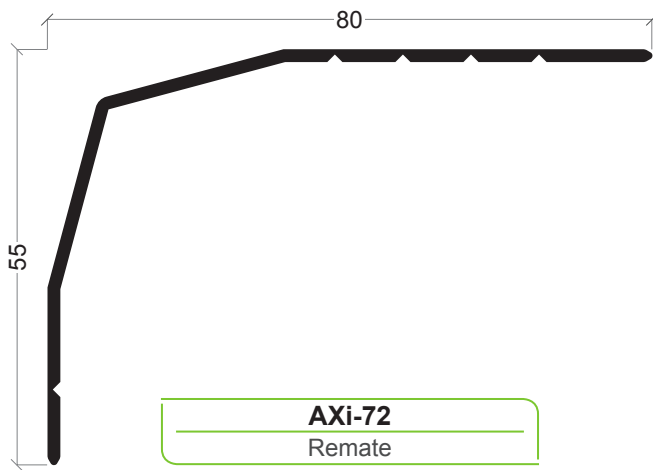

AXi-72
Remate

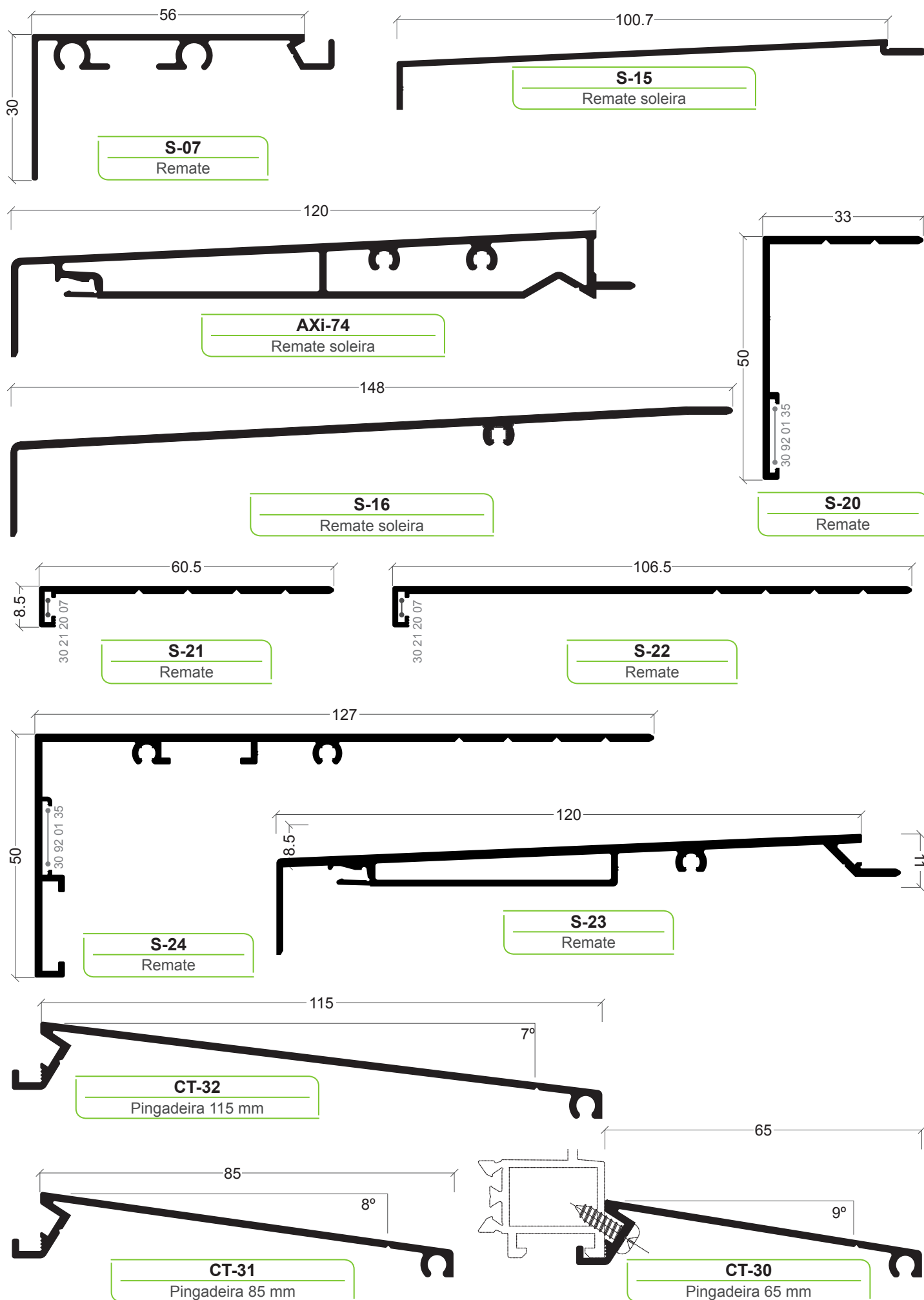

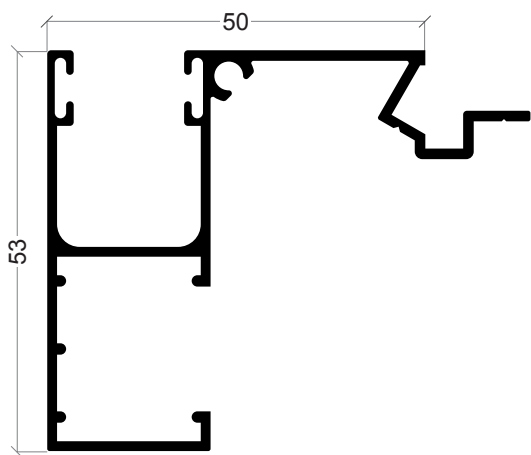

S-25
Calha para estore

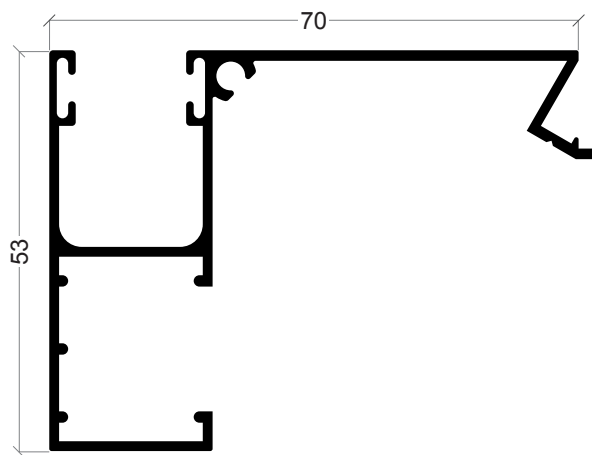

S-26
Calha para estore



S-32
Remate interior 45 mm

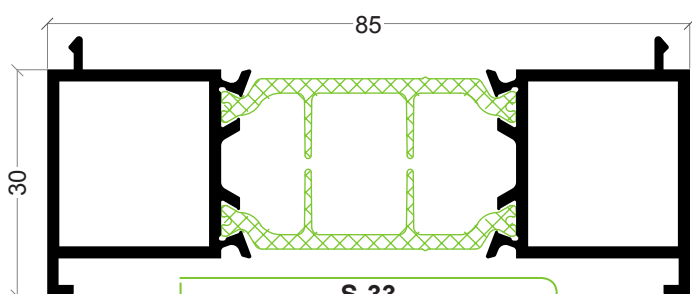

S-33
Perfil de ligação

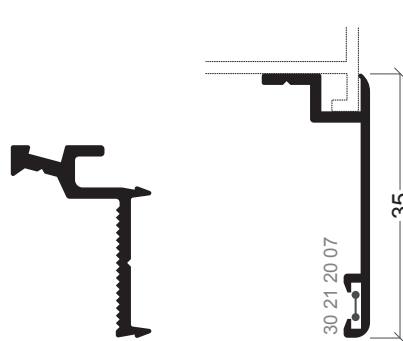

ARi-24
Mola tapa juntas

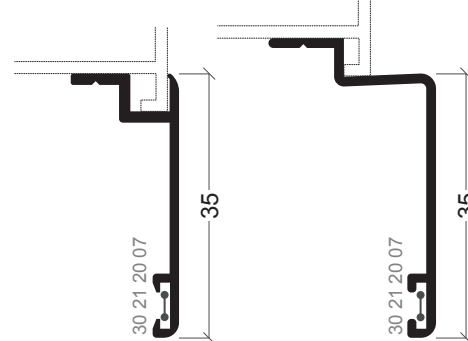

ARi-31
Tapa juntas

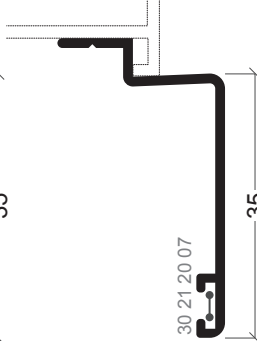

ARi-37
Tapa juntas

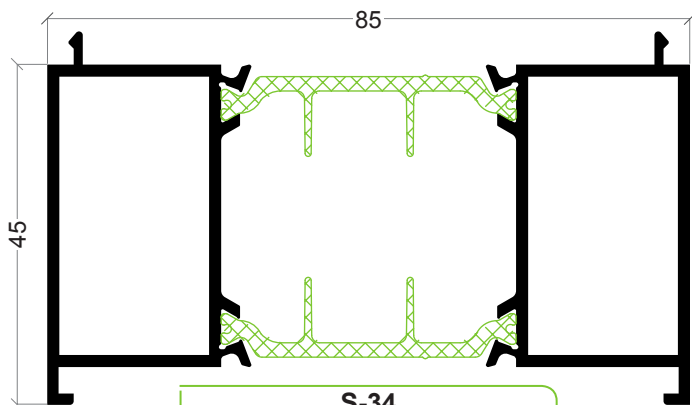

S-34
Perfil de ligação



ARi-26
Mola tapa juntas

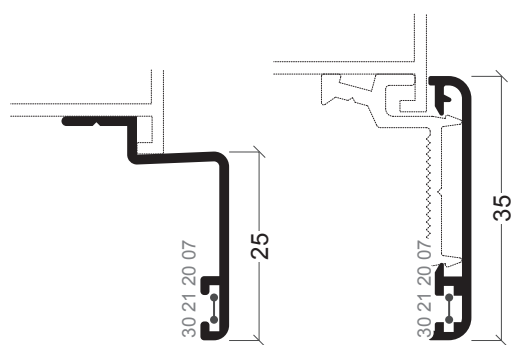

ARi-66
Tapa juntas

ARi-30
Tapa juntas

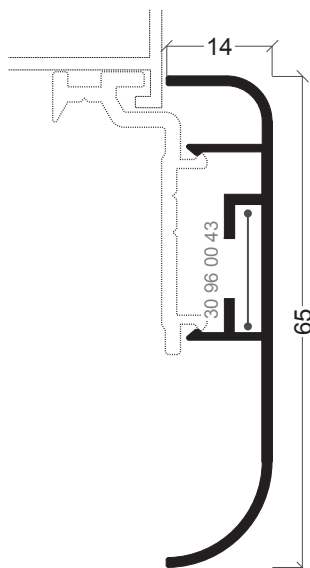

ARi-34
Tapa juntas

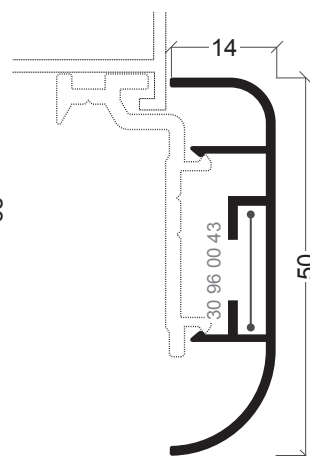

ARi-27
Tapa juntas

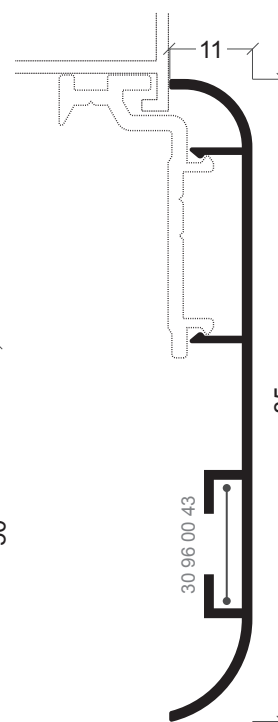

ARi-28
Tapa juntas

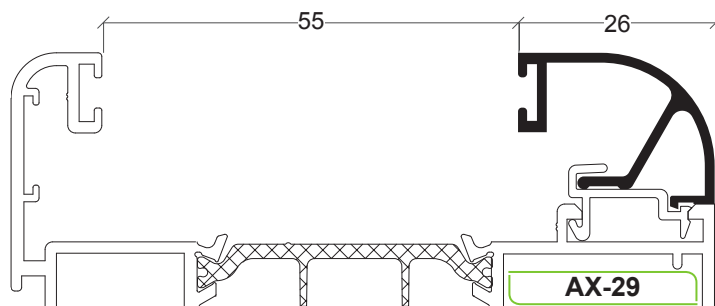
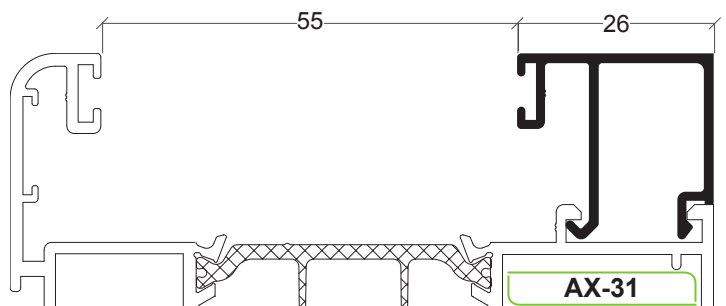
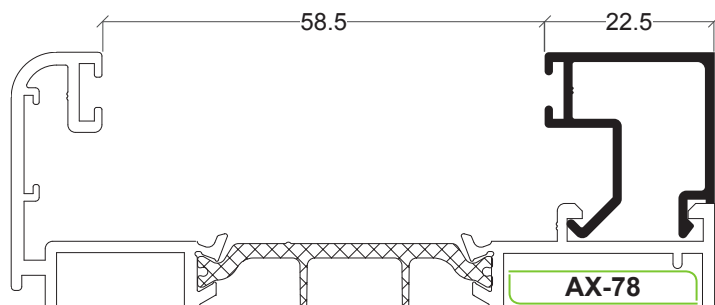
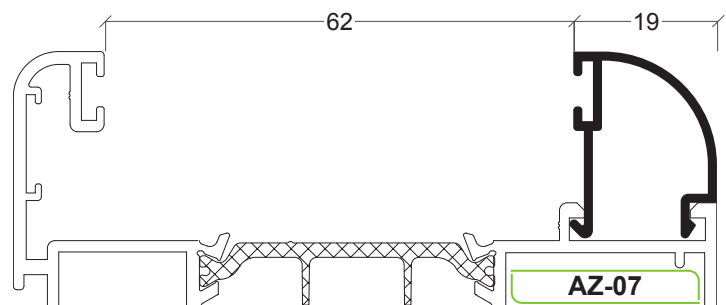
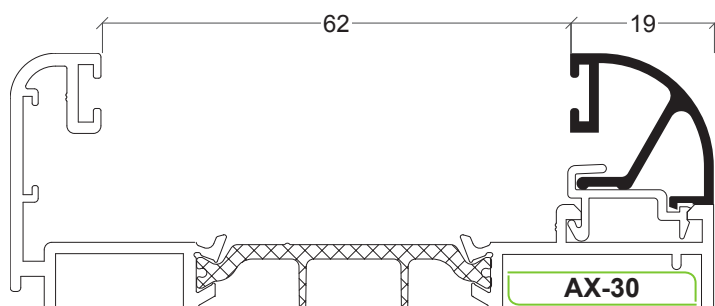
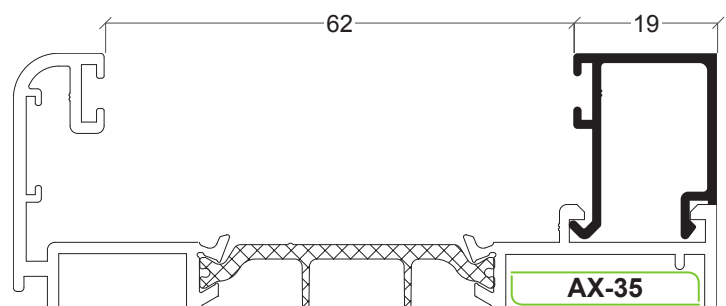
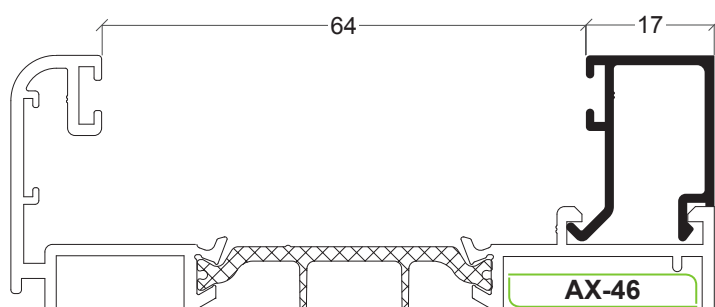
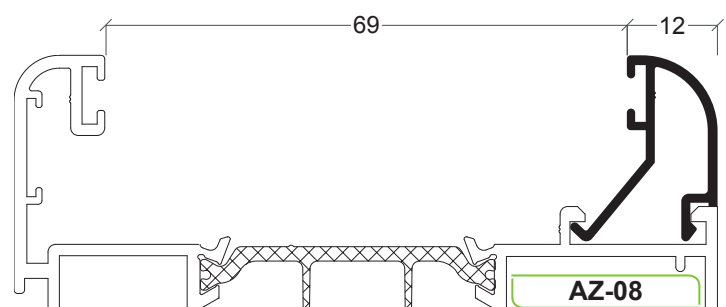
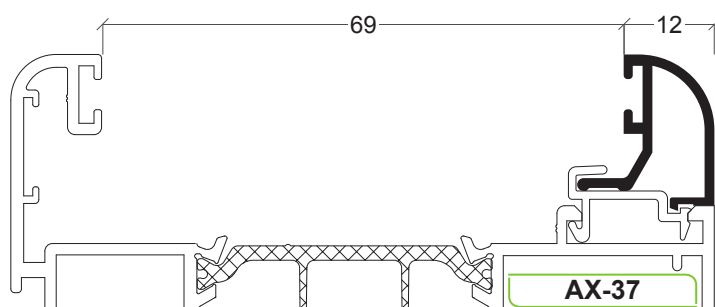
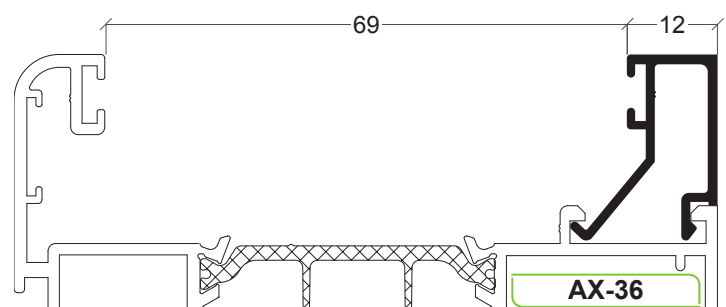
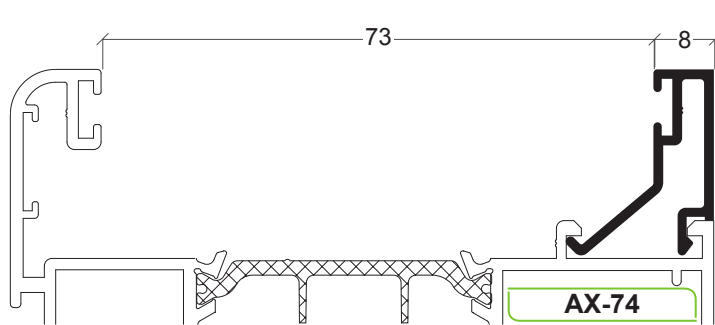
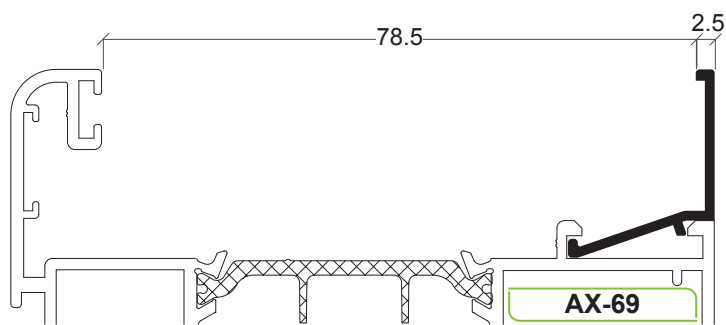

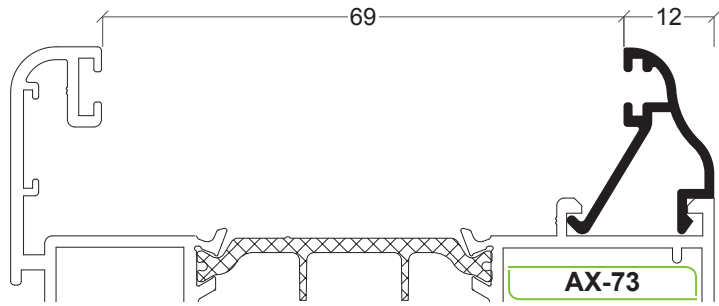
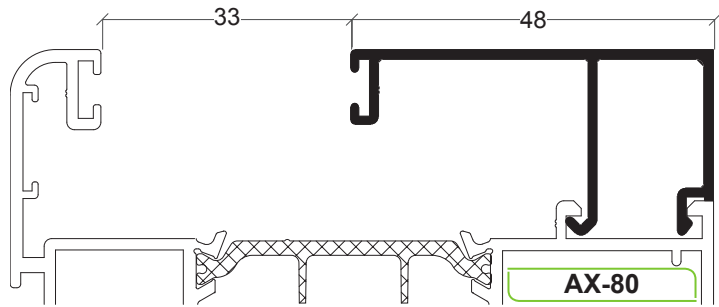
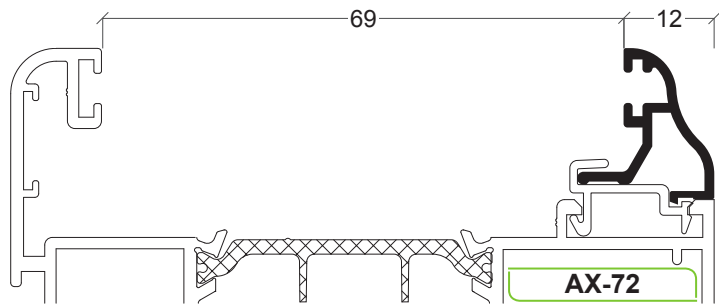
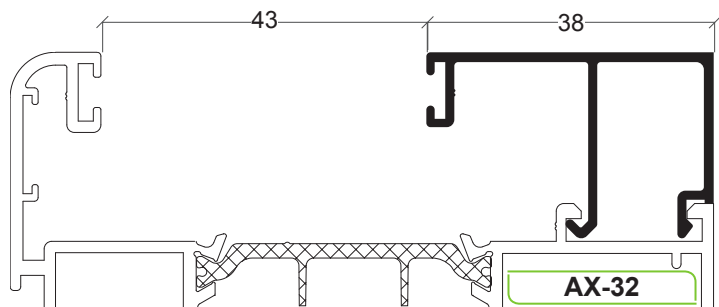
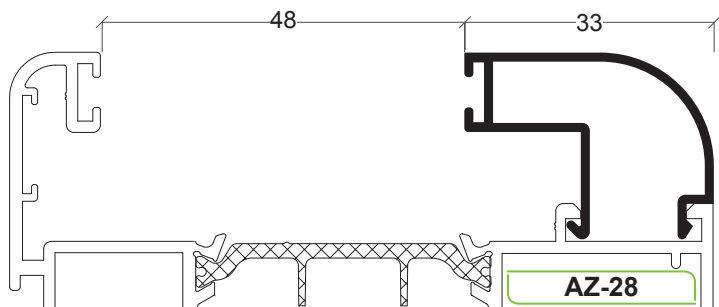
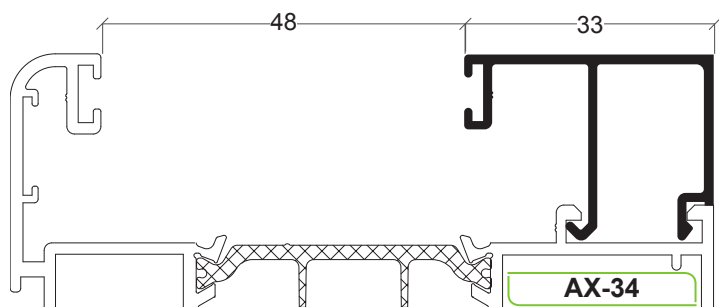
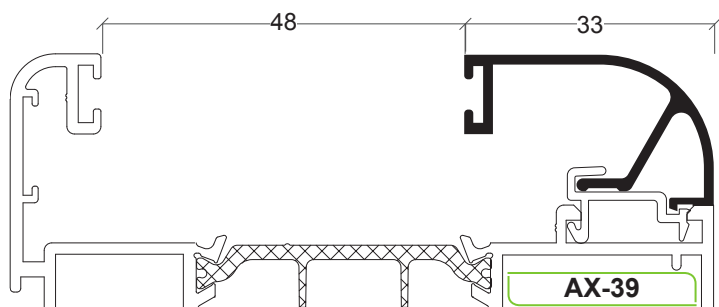
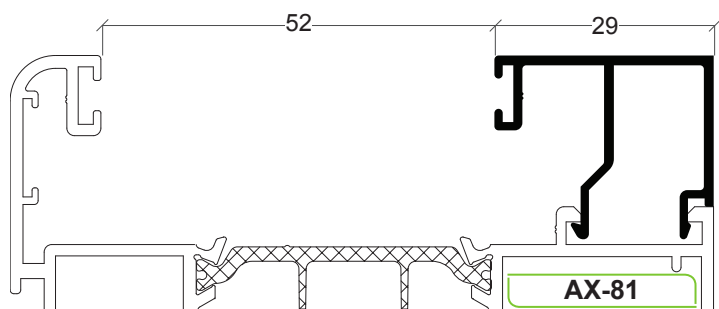
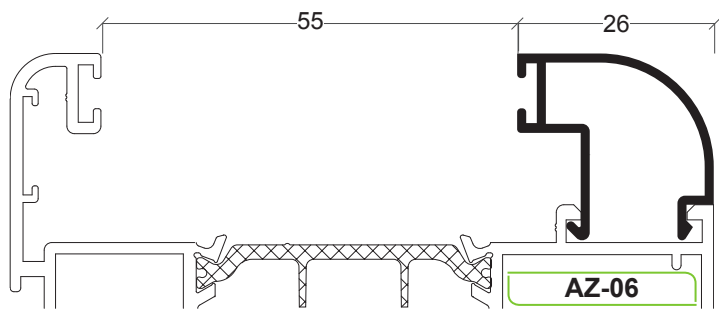

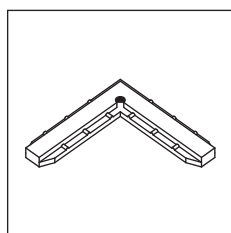

30 21 20 07

Esquadro de alinhamento

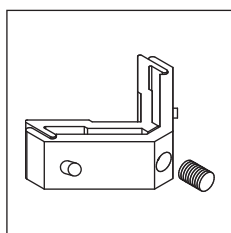

30 60 00 01

Esquadro exterior janela

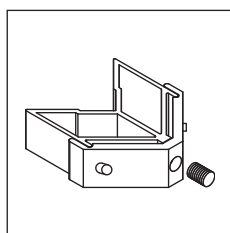

30 60 00 02

Esquadro exterior porta

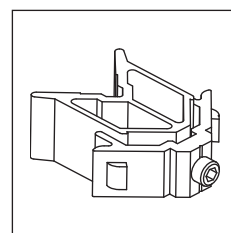

30 60 00 03

Esquadro interior porta fixo com clip

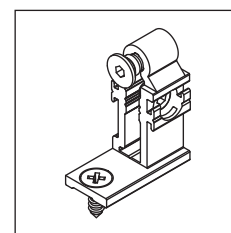

30 60 00 08

União travessa exterior pequena fixo

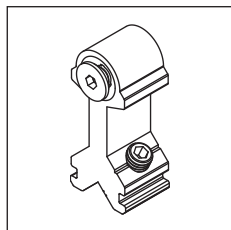

30 60 00 09

União travessa interior pequena

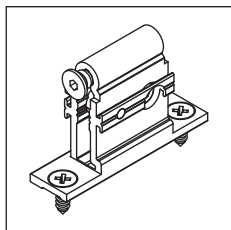

30 60 00 10

União travessa exterior grande fixo/móvel

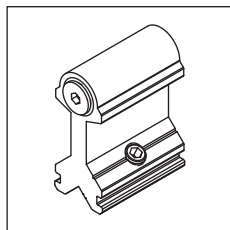

30 60 00 11

União travessa interior grande

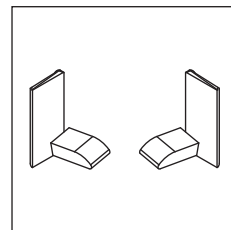

30 60 00 13

Conjunto topos Aji-62 preto

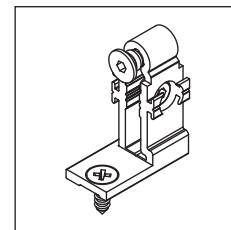

30 60 00 16

União travessa exterior pequena móvel

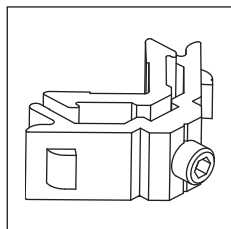

30 60 16 01

Esquadro interior janela

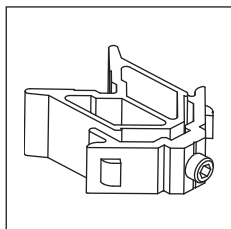

30 60 16 02

Esquadro interior porta

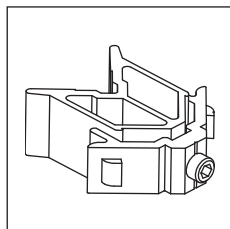

30 60 16 03

Esquadro interior aro fixo (API-113)

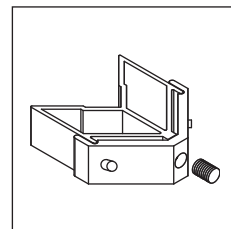

30 60 16 04

Esquadro exterior móvel porta entrada

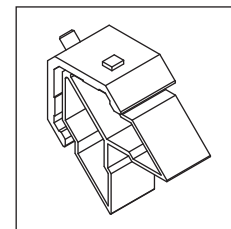

30 60 16 05

Esquadro interior móvel porta entrada

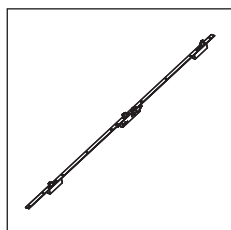

30 60 16 20

Fechadura 3 pontos (35 mm)

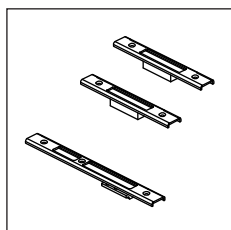

30 60 16 21

Conjunto chapa-testas direitas para aro fixo

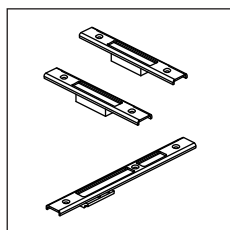

30 60 16 22

Conjunto chapa-testas esquerdas para aro fixo

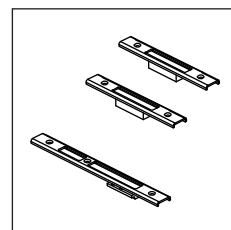

30 60 16 23

Conjunto chapa-testas direitas para inversor

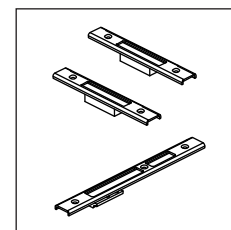

30 60 16 24

Conjunto chapa-testas esquerdas para inversor

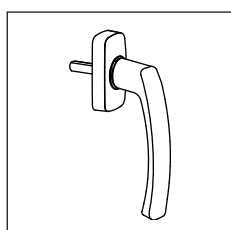

30 60 16 40/41

Puxador de alumínio branco/preto

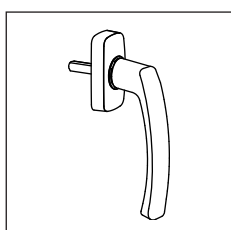

30 60 16 42/43

Puxador de alumínio 2 ac/champ ac

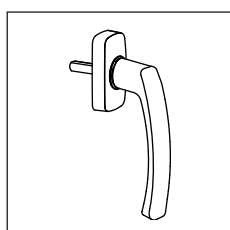

30 60 16 44

Puxador de alumínio inox ac

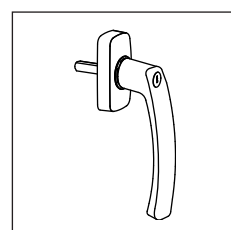

30 60 16 45/46

Puxador com chave de alumínio branco/preto

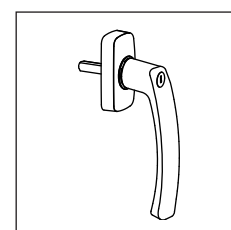

30 60 16 47/48

Puxador com chave de alumínio 2 ac/champ ac

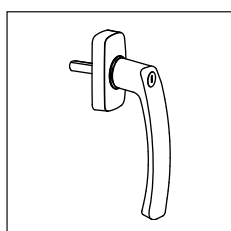

30 60 16 49

Puxador com chave de alumínio inox ac

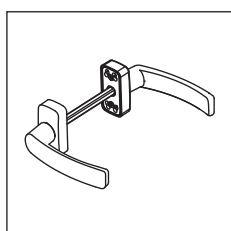

30 60 16 50/51

Puxador duplo de alumínio branco/preto

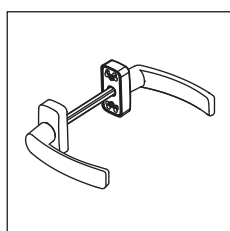

30 60 16 52/53

Puxador duplo de alumínio 2 ac/champ ac

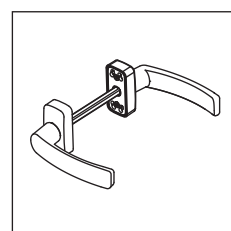

30 60 16 54

Puxador duplo de alumínio inox ac

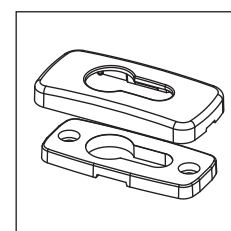

30 60 16 55/56

Escudo de alumínio branco/preto

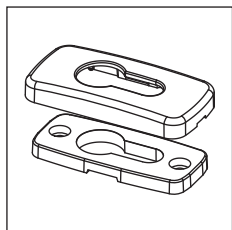

30 60 16 57/58
Escudo de alumínio 2 ac/
champ ac

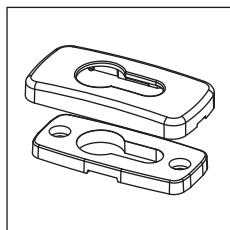

30 60 16 59
Escudo de alumínio
inox ac

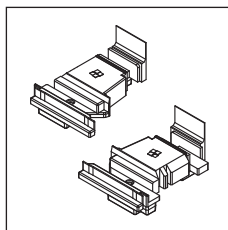

30 70 16 12
Conjunto topos inversor
APi canal 16

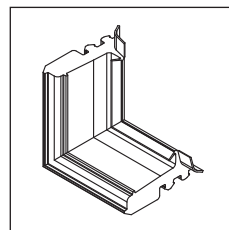

30 70 16 31
Canto vulcanizado

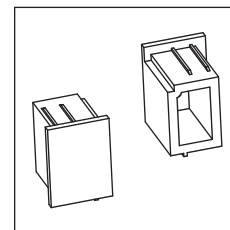

30 91 21 20
Jogo topos condensação
Y-20

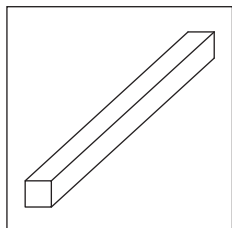

30 91 41 23
Perno 7 x 131 mm

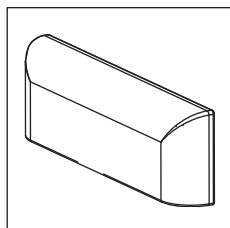

30 92 01 00/01
Goteira preto/branco

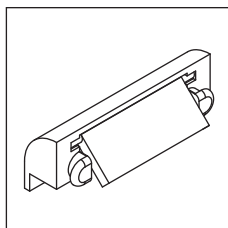

30 92 01 02/03
Goteira com válvula
preto /branco

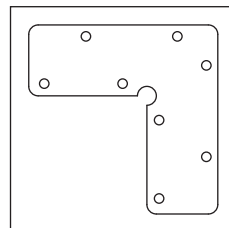

30 92 01 35
Esquadro de
alinhamento

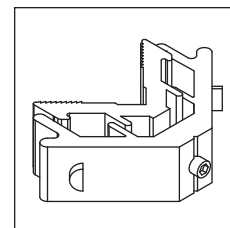

30 92 04 25
Esquadro interior janela
fixo com clip

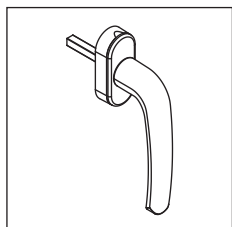

30 92 12 68/69
Puxador aniprima
branco/preto

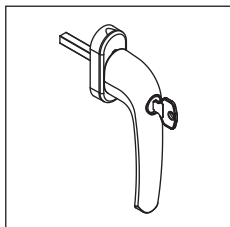

30 92 12 70/71
Puxador aniprima com
chave branco/preto

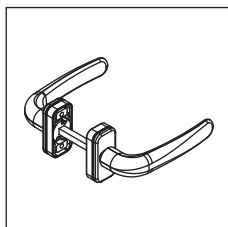

30 92 13 00/01
Puxador duplo aniprima
branco/preto

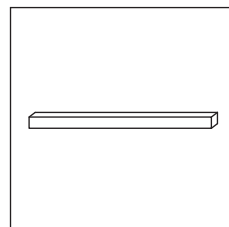

30 92 13 02
Perno 8 x 150

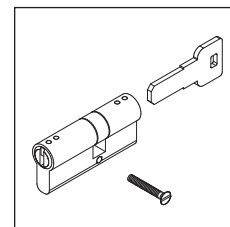

30 92 13 03
Canhão segurança
30 x 80 níquel

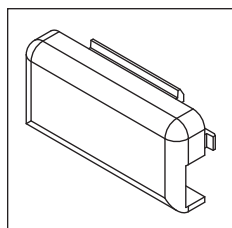

30 92 13 04
Goteira preta

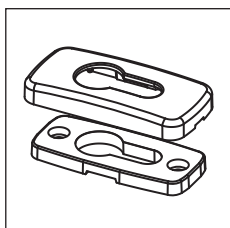

30 92 22 85/86
Escudo para canhão
branco/preto

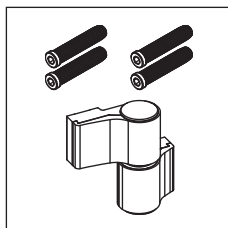

30 92 22 88/89
Dobradiça 2 abas porta c/
ressalto fixação direta
branco/preto

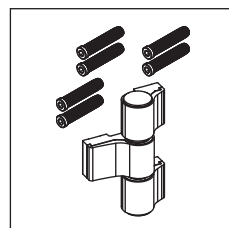

30 92 22 90/91
Dobradiça 3 abas porta c/
ressalto fixação direta
branco/preto

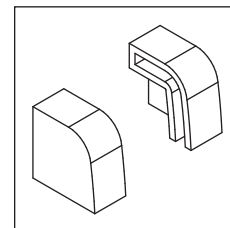

30 96 00 12
Jogo topos condensação

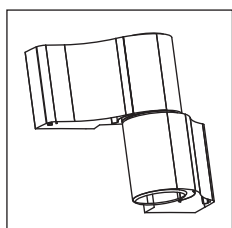

30 96 00 17/21
Dobradiça com ressalto
branco/preto

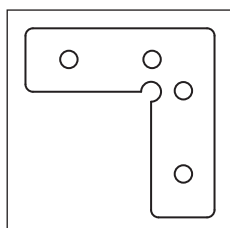

30 96 00 22
Esquadro alinhamento

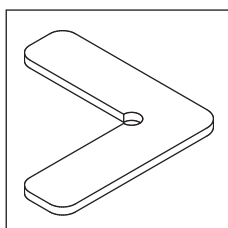

30 96 00 23
Esquadro alinhamento
aro fixo

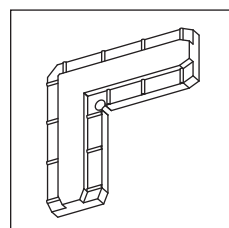

30 96 00 43
Esquadro alinhamento

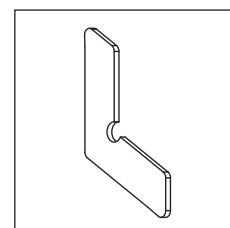

30 96 00 63
Esquadro alinhamento

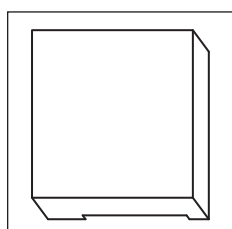

30 96 10 01
Calço para vidro aro
móvel

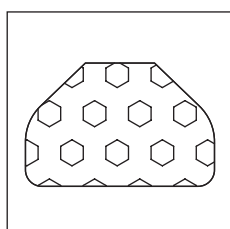

30 99 00 01
ThermoProfile ISO-01

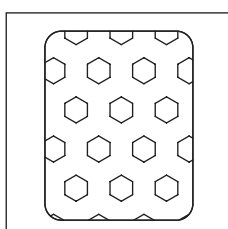

30 99 00 02
ThermoProfile ISO-02

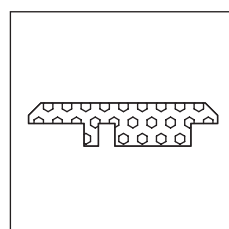

30 99 00 06
ThermoProfile ISO-06

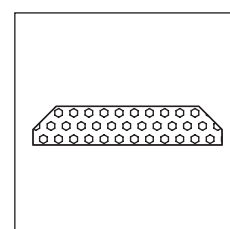

30 99 00 07
ThermoProfile ISO-07

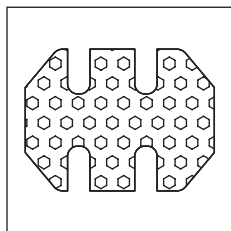

30 99 00 10
ThermoProfile ISO-10

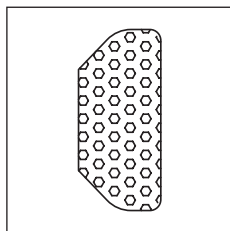

30 99 00 22
ThermoProfile ISO-22

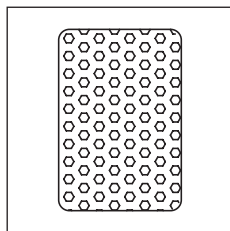

30 99 00 23
ThermoProfile ISO-23

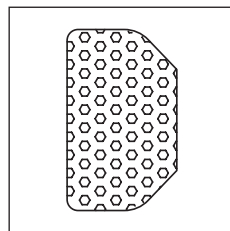

30 99 00 24
ThermoProfile ISO-24

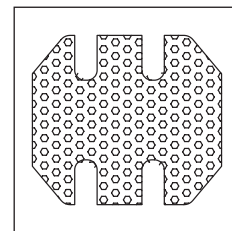



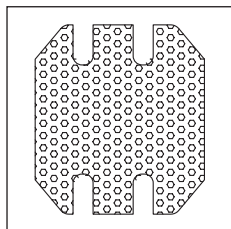



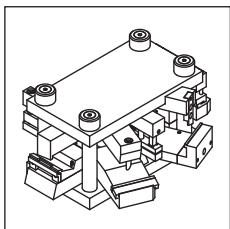









30 99 00 25
ThermoProfile ISO-25









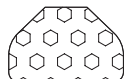

30 99 00 26
ThermoProfile ISO-26

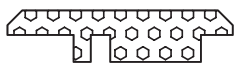
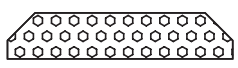
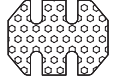

33 98 24 99
Cunho APi canal 16

Referência	Desenho	Descrição
30 60 00 14		Perfil pelúcia metálica 18 mm preto
30 60 00 17		Junta exterior vidro plana (2 mm) preto
30 60 00 18		Junta isolante
30 70 16 30		Junta central
30 92 04 70		Espuma isolante
30 93 00 60		Junta exterior do vidro (4 mm) preto
30 93 00 61		Junta de vedação exterior (2 mm) preto
30 93 00 62		Junta exterior plana para vidro (4 mm) preto
30 93 00 65		Junta interior para vidro (5 mm) preto
30 93 00 66		Junta interior para vidro (4 mm) preto
30 93 00 67		Junta interior para vidro (2 mm) preto
30 93 00 68		Junta interior para vidro (6/7 mm) preto
30 93 00 69		Junta interior para vidro (8/9 mm) preto
30 93 01 20		Junta interior
30 94 01 46		Junta para veda-luz AZ-22
30 95 00 10		Pelúcia 7x9 mm

Referência	ThermoProfile (Baguetes de 70 cm)	Aplicação
30 99 00 01		APi-01; APi-03; APi-13; APi-21; APi-33; APi-35; APi-65; APi-67; APi-71; APi-73; APi-74; APi-75; APi-76; APi-80; APi-81; APi-86; APi-87; APi-88; APi-89; APi-91
30 99 00 02		APi-01; APi-03; APi-13; APi-21; APi-33; APi-35; APi-65; APi-67; APi-71; APi-73; APi-74; APi-75; APi-76; APi-80; APi-81; APi-86; APi-87; APi-88; APi-89; APi-91
30 99 00 06		APi-01; APi-03; APi-06; APi-08; APi-12; APi-13; APi-20; APi-33; APi-35; APi-68; APi-73; APi-74; APi-75; APi-76; APi-79; APi-80; APi-81; APi-86; APi-87; APi-88; APi-89; APi-91; APi-92; APi-93; APi-94
30 99 00 07		APi-105; APi-110; APi-115; APi-122; APi-129; APi-136; APi-161; APi-172; APi-183; APi-184; APi-185; APi-190
30 99 00 10		APi-08; APi-68; APi-79; APi-92; APi-93; APi-94
30 99 00 22		APi-105; APi-117; APi-161; APi-183
30 99 00 23		APi-105; APi-117; APi-161; APi-183
30 99 00 24		APi-105; APi-117; APi-161; APi-183
30 99 00 25		APi-110; APi-136; APi-184
30 99 00 26		APi-115; APi-122; APi-129; APi-172; APi-185; APi-190

Ferragens para oscilo-batente 1 ou 2 folhas

Peso máximo da folha = 130 Kg (alumínio + vidro)

LFR = Largura da folha - 40 mm

HFR = Altura da folha - 40 mm

Ferragens Unijet C



Ferragens para folha ativa

Designação	Código	Quantidade
Kit Base Oscilo-batente (100 Kg)	Branco	30 60 17 30
	Preto	30 60 17 31
	Natural	30 60 17 32
Suplemento 101-130 Kg	30 60 17 90	1
Puxador Unijet	Branco	30 60 16 70
	Preto	30 60 16 71
	Natural	30 60 16 72
Falsa manobra esquerda	30 60 17 80	1

Ferragens para 2ª folha passiva

Designação	Código	Quantidade
Kit Base 2ª folha (100 Kg)	Branco	30 60 17 40
	Preto	30 60 17 41
	Natural	30 60 17 42
Suplemento 101-130 Kg	30 60 17 90	1

Largura LFR	Altura HFR	451-500	501-750	751-950	951-1200	1201-1450	1451-1600
480-590	480-590	Kit OB horizontal 30 60 18 91 1 + Kit OB vertical 30 60 17 00 1					
591-750	591-750	Kit OB horizontal 30 60 18 91 1 + Kit OB vertical 30 60 17 01 1	Kit OB horizontal 30 60 18 92 1 + Kit OB vertical 30 60 17 01 1				
751-950	751-950	Kit OB horizontal 30 60 18 91 1 + Kit OB vertical 30 60 17 02 1	Kit OB horizontal 30 60 18 92 1 + Kit OB vertical 30 60 17 02 1				
951-1450	951-1450	Kit OB horizontal 30 60 18 91 1 + Kit OB vertical 30 60 17 03 1	Kit OB horizontal 30 60 18 92 1 + Kit OB vertical 30 60 17 03 1	Kit OB horizontal 30 60 18 93 1 + Kit OB vertical 30 60 17 03 1			
1451-1950	1451-1950	Kit OB horizontal 30 60 18 91 1 + Kit OB vertical 30 60 17 04 1	Kit OB horizontal 30 60 18 92 1 + Kit OB vertical 30 60 17 04 1	Kit OB horizontal 30 60 18 93 1 + Kit OB vertical 30 60 17 04 1	Kit OB horizontal 30 60 18 94 1 + Kit OB vertical 30 60 17 04 1		
1951-2450	1951-2450	Kit OB horizontal 30 60 18 91 1 + Kit OB vertical 30 60 17 05 1	Kit OB horizontal 30 60 18 92 1 + Kit OB vertical 30 60 17 05 1	Kit OB horizontal 30 60 18 93 1 + Kit OB vertical 30 60 17 05 1	Kit OB horizontal 30 60 18 94 1 + Kit OB vertical 30 60 17 05 1	Kit OB horizontal 30 60 18 95 1 + Kit OB vertical 30 60 17 05 1	Kit OB horizontal 30 60 18 96 1 + Kit OB vertical 30 60 17 05 1
2451-2800	2451-2800	Kit OB horizontal 30 60 18 91 1 + Kit OB vertical 30 60 17 06 1	Kit OB horizontal 30 60 18 92 1 + Kit OB vertical 30 60 17 06 1	Kit OB horizontal 30 60 18 93 1 + Kit OB vertical 30 60 17 06 1	Kit OB horizontal 30 60 18 94 1 + Kit OB vertical 30 60 17 06 1	Kit OB horizontal 30 60 18 95 1 + Kit OB vertical 30 60 17 06 1	Kit OB horizontal 30 60 18 96 1 + Kit OB vertical 30 60 17 06 1

Ferragens para a 2ª folha passiva

Largura LFR	Altura HFR	451-500	501-750	751-950	951-1200	1201-1600
480-750	480-750	Kit fechos 2ª folha 30 60 17 10 1				
751-950	751-950	Kit 2ª folha horizontal 30 60 17 12 1 + Kit 2ª folha vertical 30 60 17 20 1	Kit 2ª folha horizontal 30 60 17 13 1 + Kit 2ª folha vertical 30 60 17 20 1			
951-1450	951-1450	Kit 2ª folha horizontal 30 60 17 12 1 + Kit 2ª folha vertical 30 60 17 21 1	Kit 2ª folha horizontal 30 60 17 13 1 + Kit 2ª folha vertical 30 60 17 21 1			
1451-1950	1451-1950	Kit 2ª folha horizontal 30 60 17 12 1 + Kit 2ª folha vertical 30 60 17 22 1	Kit 2ª folha horizontal 30 60 17 13 1 + Kit 2ª folha vertical 30 60 17 22 1	Kit 2ª folha horizontal 30 60 17 14 1 + Kit 2ª folha vertical 30 60 17 22 1	Kit 2ª folha horizontal 30 60 17 15 1 + Kit 2ª folha vertical 30 60 17 22 1	
1951-2450	1951-2450	Kit 2ª folha horizontal 30 60 17 12 1 + Kit 2ª folha vertical 30 60 17 23 1	Kit 2ª folha horizontal 30 60 17 13 1 + Kit 2ª folha vertical 30 60 17 23 1	Kit 2ª folha horizontal 30 60 17 14 1 + Kit 2ª folha vertical 30 60 17 23 1	Kit 2ª folha horizontal 30 60 17 15 1 + Kit 2ª folha vertical 30 60 17 23 1	Kit 2ª folha horizontal 30 60 17 16 1 + Kit 2ª folha vertical 30 60 17 23 1
2451-2800	2451-2800	Kit 2ª folha horizontal 30 60 17 12 1 + Kit 2ª folha vertical 30 60 17 24 1	Kit 2ª folha horizontal 30 60 17 13 1 + Kit 2ª folha vertical 30 60 17 24 1	Kit 2ª folha horizontal 30 60 17 14 1 + Kit 2ª folha vertical 30 60 17 24 1	Kit 2ª folha horizontal 30 60 17 15 1 + Kit 2ª folha vertical 30 60 17 24 1	Kit 2ª folha horizontal 30 60 17 16 1 + Kit 2ª folha vertical 30 60 17 24 1

Ferragens Unijet C

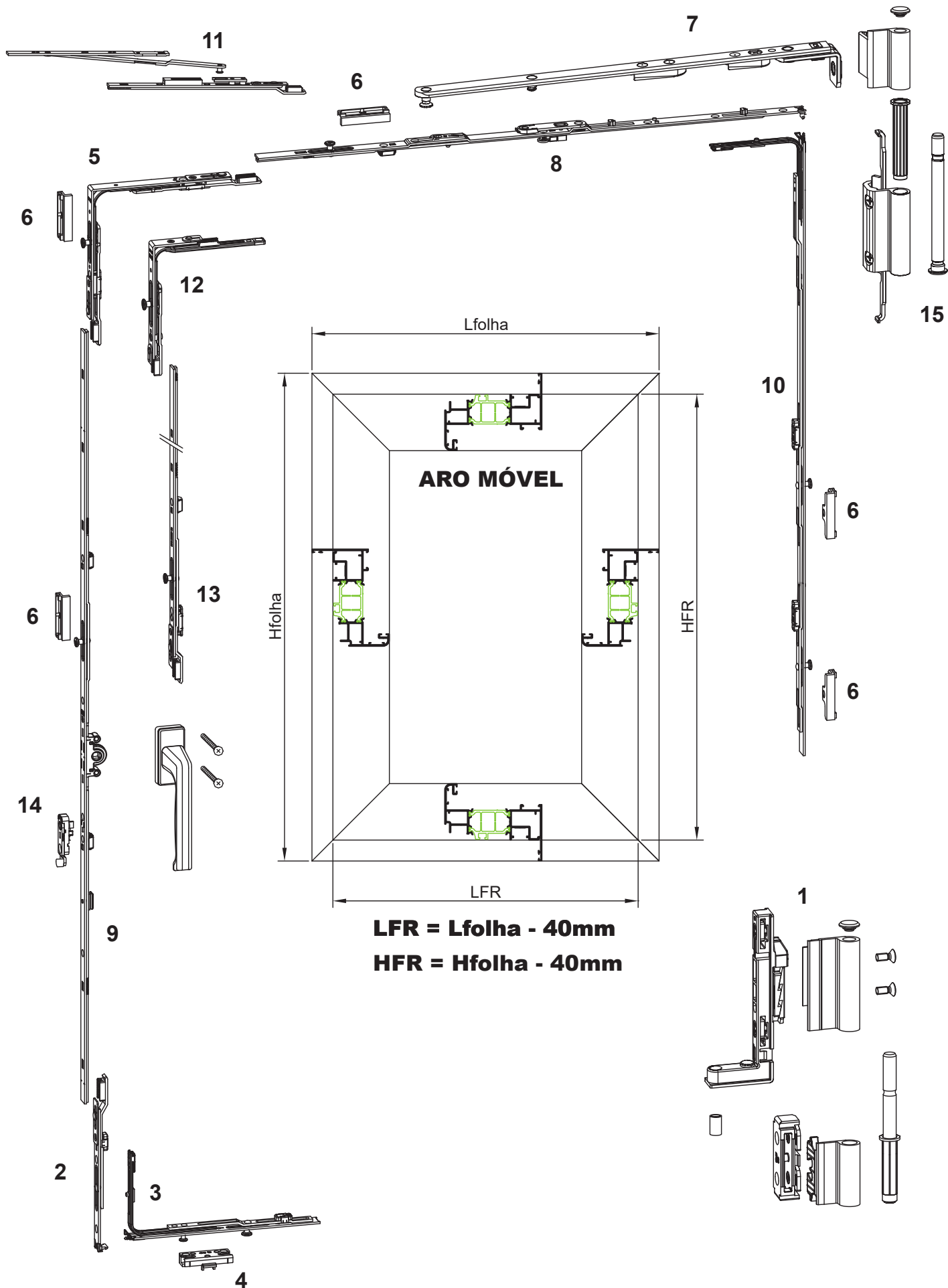

Ferragens para oscilo-batente 1 ou 2 folhas

Peso máximo da folha = 130 Kg (alumínio + vidro)

LFR = Largura da folha - 40 mm

HFR = Altura da folha - 40 mm

Ferragens Unijet D



Ferragens para folha ativa

Designação	Código		Quantidade
Kit Base Oscilo-batente direita (130 Kg)	Branco	30 60 16 60	1
	Preto	30 60 16 61	
	Natural	30 60 16 62	
Kit Base Oscilo-batente esquerda (130 Kg)	Branco	30 60 16 65	1
	Preto	30 60 16 66	
	Natural	30 60 16 67	
Puxador Unijet	Branco	30 60 16 70	1
	Preto	30 60 16 71	
	Natural	30 60 16 72	

Ferragens para 2ª folha passiva

Designação	Código		Quantidade
Kit Base 2ª folha direita (130 Kg)	Branco	30 60 16 80	1
	Preto	30 60 16 81	
	Natural	30 60 16 82	
Kit Base 2ª folha esquerda (130 Kg)	Branco	30 60 16 85	1
	Preto	30 60 16 86	
	Natural	30 60 16 87	

Largura LFR		Código		Quantidade		Quantidade	
Altura HFR		Código		Quantidade		Quantidade	
480-590		Kit OB horizontal 30 60 16 91 (D) ou 30 60 17 51 (E)	1	Kit OB vertical 30 60 17 00	1		
591-750		Kit OB horizontal 30 60 16 91 (D) ou 30 60 17 51 (E)	1	Kit OB vertical 30 60 17 01	1		
751-950		Kit OB horizontal 30 60 16 91 (D) ou 30 60 17 51 (E)	1	Kit OB vertical 30 60 17 02	1		
951-1450		Kit OB horizontal 30 60 16 91 (D) ou 30 60 17 51 (E)	1	Kit OB vertical 30 60 17 03	1		
1451-1950		Kit OB horizontal 30 60 16 91 (D) ou 30 60 17 51 (E)	1	Kit OB vertical 30 60 17 04	1		
1951-2450		Kit OB horizontal 30 60 16 91 (D) ou 30 60 17 51 (E)	1	Kit OB vertical 30 60 17 05	1		
2451-2800		Kit OB horizontal 30 60 16 91 (D) ou 30 60 17 51 (E)	1	Kit OB vertical 30 60 17 06	1		

Ferragens para a 2ª folha passiva

Largura LFR		Código		Quantidade		Quantidade	
Altura HFR		Código		Quantidade		Quantidade	
480-750		Kit fechos 2ª folha 30 60 17 10	1				
751-950		Kit 2ª folha horizontal 30 60 17 12	1	Kit 2ª folha vertical 30 60 17 20	1		
951-1450		Kit 2ª folha horizontal 30 60 17 12	1	Kit 2ª folha vertical 30 60 17 21	1		
1451-1950		Kit 2ª folha horizontal 30 60 17 12	1	Kit 2ª folha vertical 30 60 17 22	1		
1951-2450		Kit 2ª folha horizontal 30 60 17 12	1	Kit 2ª folha vertical 30 60 17 23	1		
2451-2800		Kit 2ª folha horizontal 30 60 17 12	1	Kit 2ª folha vertical 30 60 17 24	1		

Ferragens Unijet D

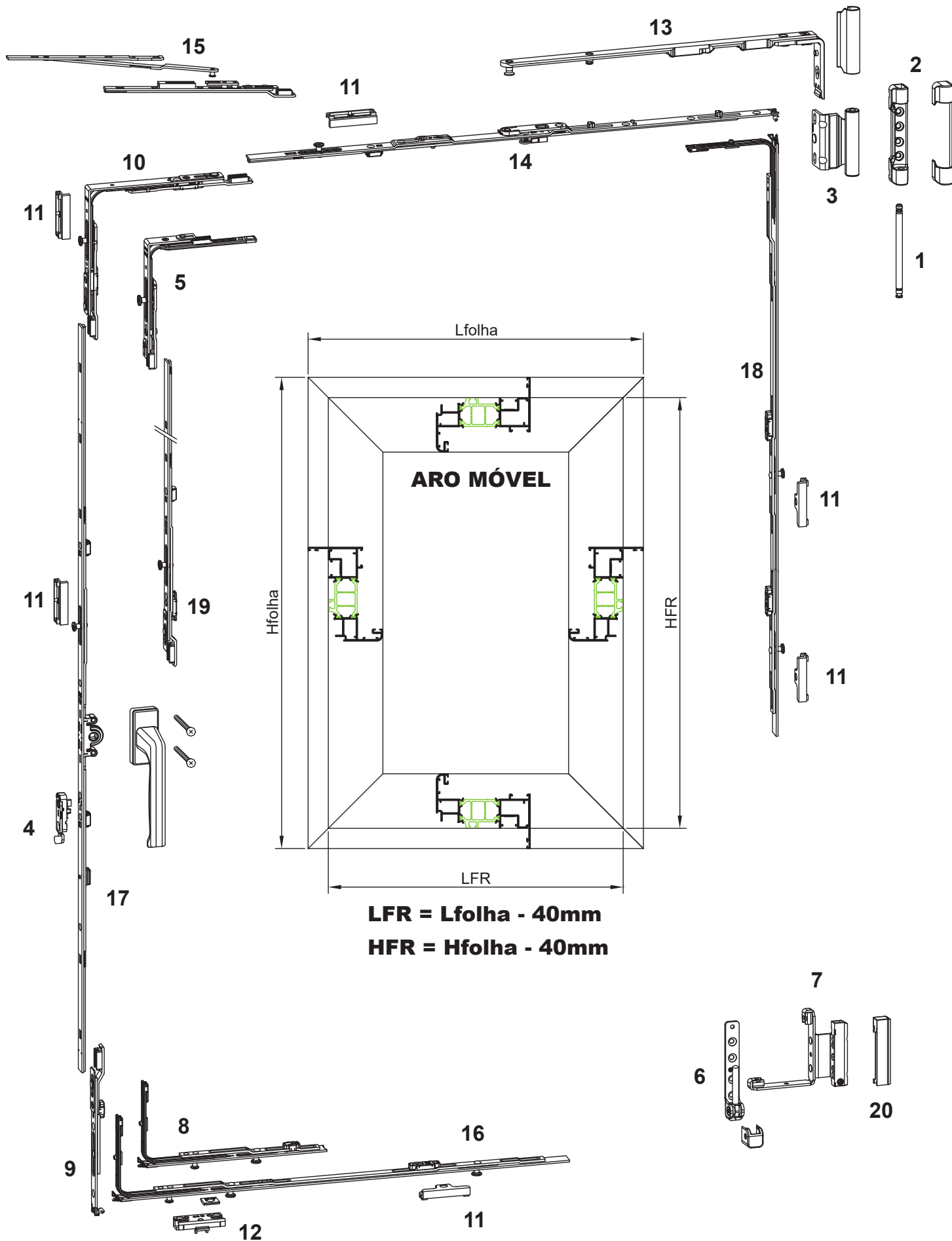

Ferragens Unijet Oculta

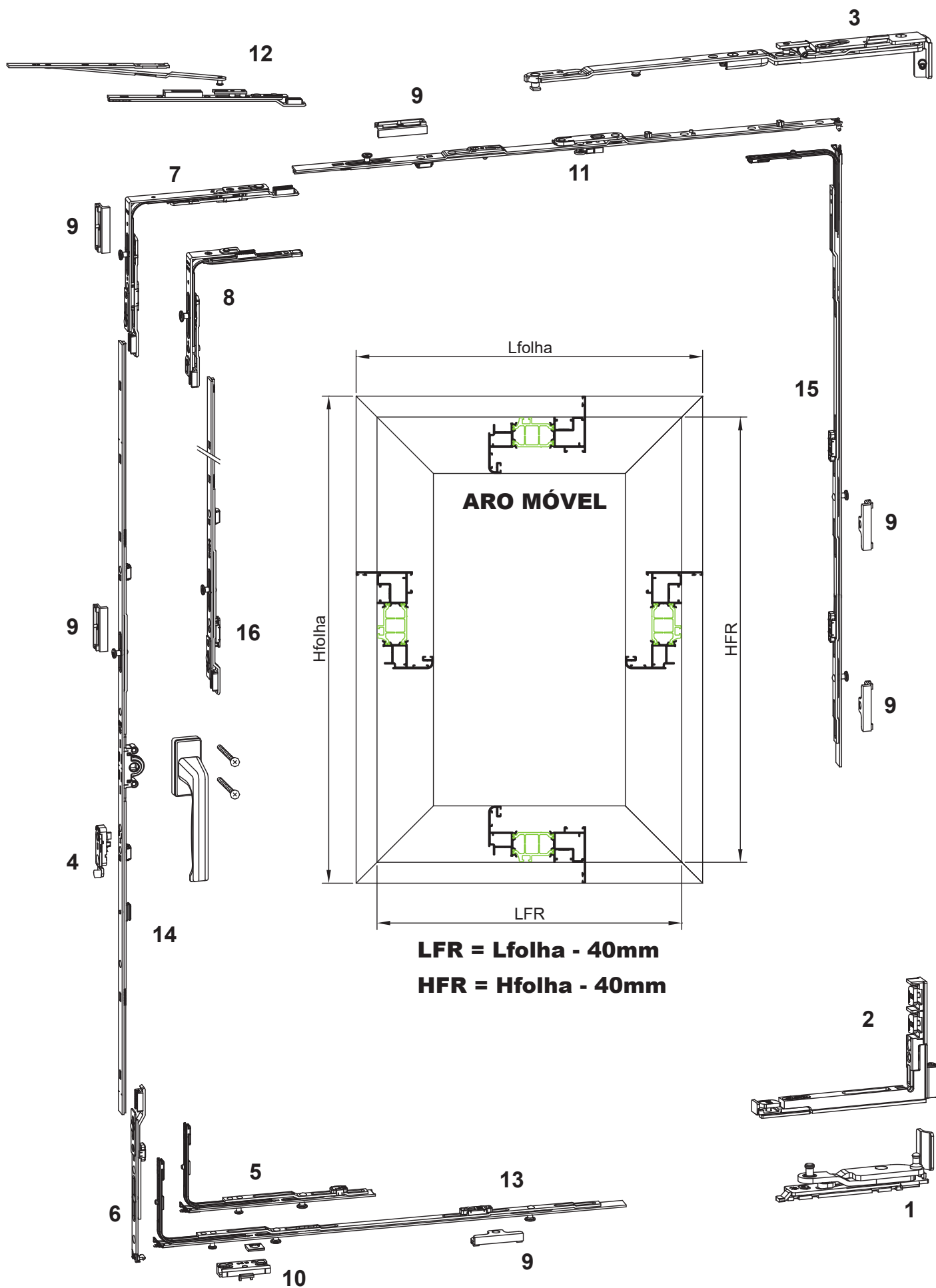

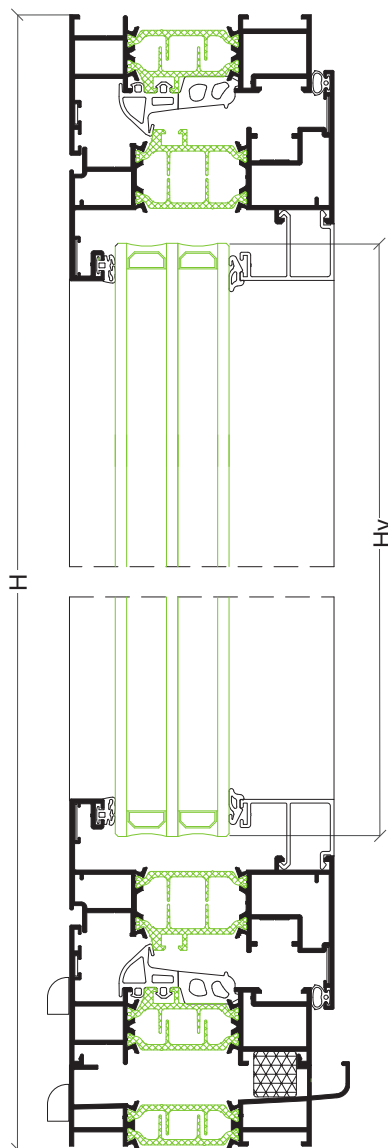
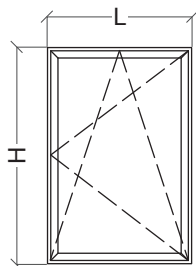
Janela 1 folha abrir e oscilo-batente

Perfis

Desenho	Ref	Descrição	Corte	Quant	Medida
	API-03	Aro fixo		2	L
				2	H-28.5 mm
	API-161	Aro móvel		2	L-39 mm
				2	H-67.5 mm
	---	Bite		2	L-147 mm
				2	H-215.5 mm
	API-34	Soleira		1	L

Acessórios e Juntas

Referência	Descrição	Quantidade	
		Abriu	Oscilo-batente
30 60 16 01	Esquadro interior móvel	4	
30 60 00 01	Esquadro exterior	8	
30 96 00 23	Esquadro alinhamento fixo	4	
30 96 00 22	Esquadro alinhamento móvel	8	
30 96 10 01	Calço para vidro	4	6
---	Puxador	1	
---	Ferragem canal 16 (ver páginas ferragens)	1	
30 92 01 02	Goteira com válvula preto	4 ou mais	
30 96 00 12	Jogo topos condensação	1	
30 92 04 70	Espuma isolante	L	
30 93 01 20	Junta interior	2L+2H	
30 70 16 30	Junta central	2L+2H	
30 70 16 31	Canto vulcanizado	4	
---	Junta para vidro (exterior)	2L+2H	
---	Junta para vidro (interior)	2L+2H	
30 96 00 04	Esquadro interior fixo	4	

Vidro

Hv = H-189 mm	Lv = L-161 mm
---------------	---------------

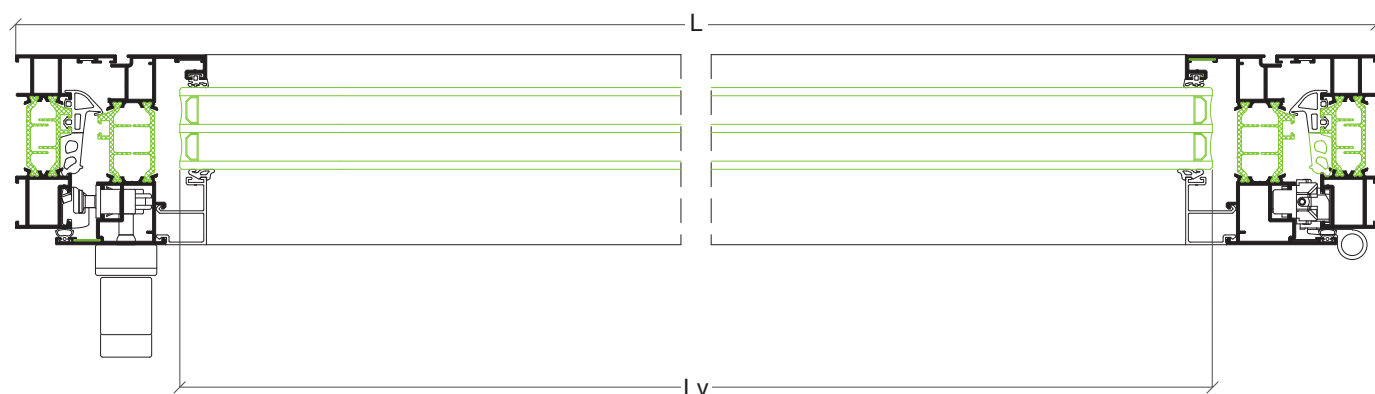

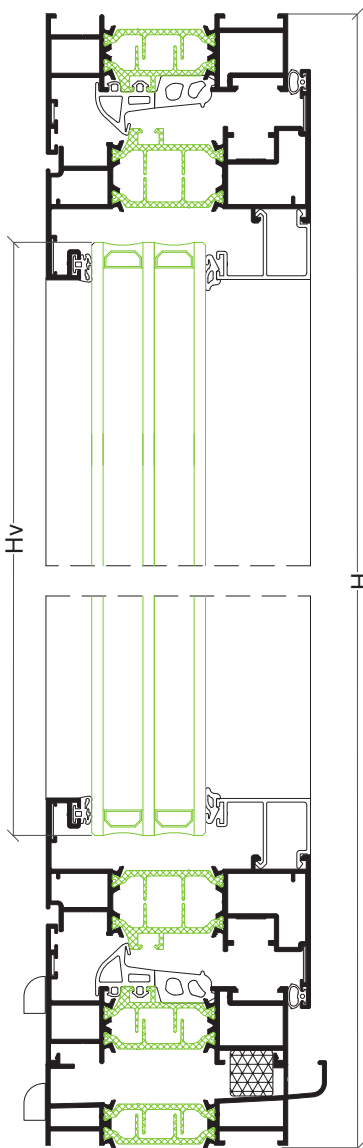
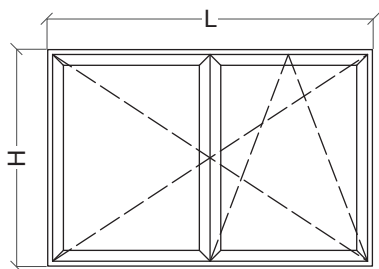
Janela 2 folhas abrir e oscilo-batente

Perfis

Desenho	Ref	Descrição	Corte	Quant	Medida
	APi-03	Aro fixo		2	L
				2	H-28.5 mm
	APi-161	Aro móvel		4	L/2-22 mm
				4	H-67.5 mm
	---	Bite		4	L/2-130 mm
				4	H-215.5 mm
	APi-117	Inversor		1	H-143.5 mm
	KL-04	Perfil tampa		1	H-143.5 mm
	APi-34	Soleira		1	L

Acessórios e Juntas

Referência	Descrição	Quantidade	
		Abrir	Oscilo-batente
30 60 16 01	Esquadro interior móvel	8	
30 60 00 01	Esquadro exterior	12	
30 96 00 23	Esquadro alinhamento fixo	4	
30 96 00 22	Esquadro alinhamento móvel	16	
30 96 10 01	Calço para vidro	8	10
---	Puxador	1	
---	Ferragem canal 16 (ver páginas ferragens)	1	
30 92 01 02	Goteira com válvula preto	4 ou mais	
30 70 16 12	Jogo topos inversor	1	
30 96 00 12	Jogo topos condensação	1	
30 92 04 70	Espuma isolante	L	
30 93 01 20	Junta interior	2L+4H	
30 70 16 30	Junta central	2L+3H	
30 70 16 31	Canto vulcanizado	4	
---	Junta para vidro (exterior)	2L+4H	
---	Junta para vidro (interior)	2L+4H	
30 96 00 04	Esquadro interior fixo	4	

Vidro



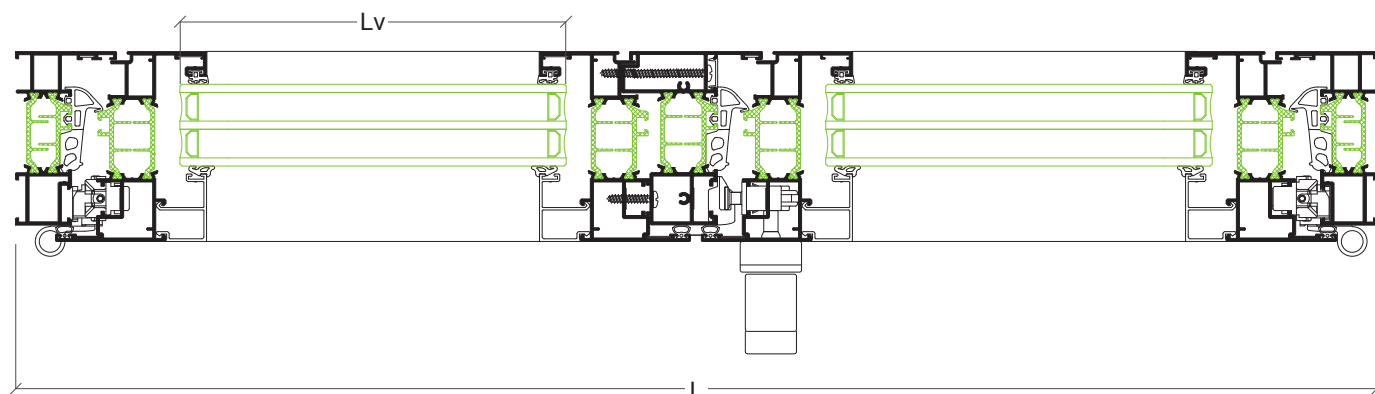



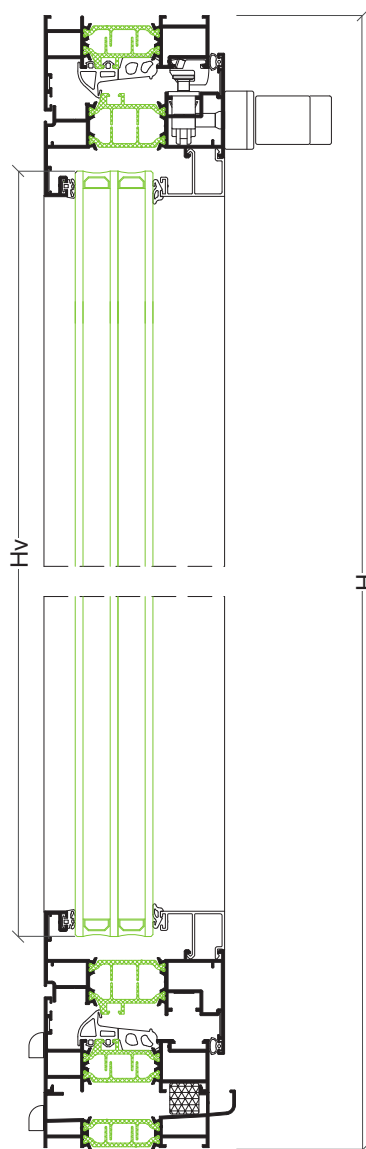
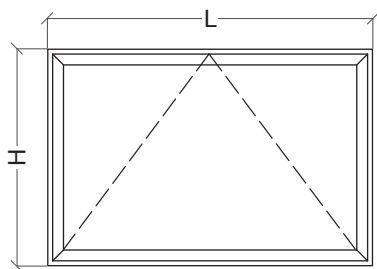

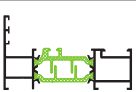

Hv = H-189 mm	Lv = L/2-144 mm
---------------	-----------------

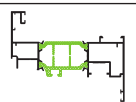

Janela basculante



Perfis

Desenho	Ref	Descrição	Corte	Quant	Medida
	APi-03	Aro fixo		2	L
				2	H-28.5 mm
	APi-161	Aro móvel		2	L-39 mm
				2	H-67.5 mm
	---	Bite		2	L-147 mm
				2	H-215.5 mm
	APi-34	Soleira		1	L

Acessórios e Juntas







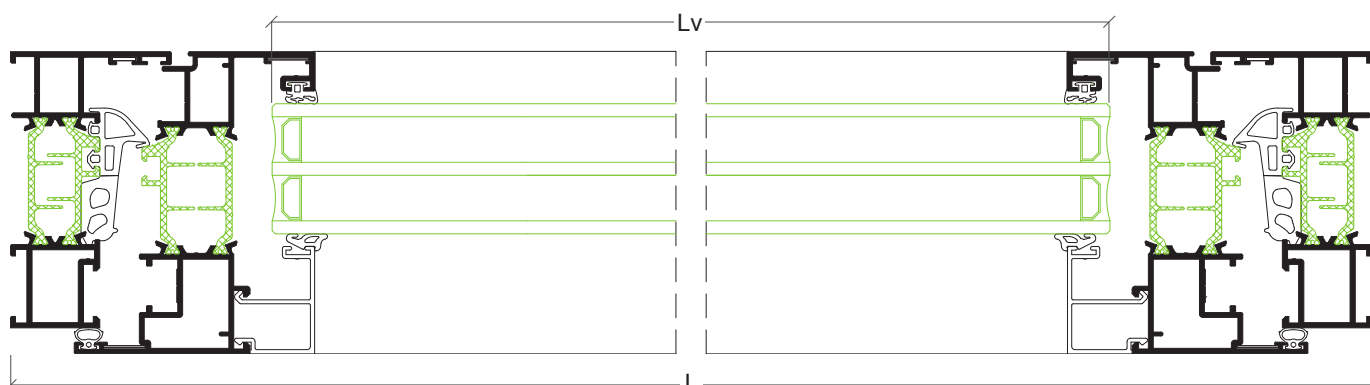

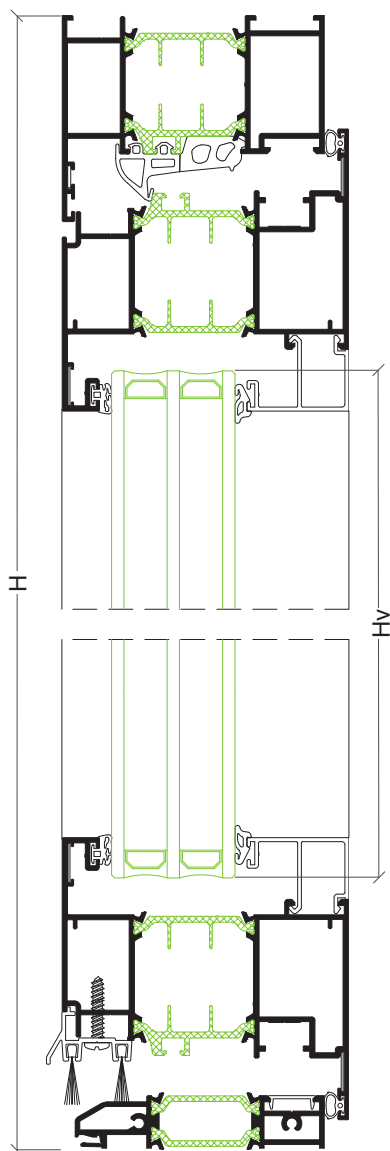
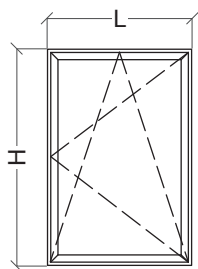

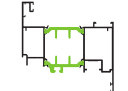
Referência	Descrição	Quantidade
30 60 16 01	Esquadro interior móvel	4
30 60 00 01	Esquadro exterior	8
30 96 00 23	Esquadro alinhamento fixo	4
30 96 00 22	Esquadro alinhamento móvel	8
30 96 10 01	Calço para vidro	4
---	Puxador	1
---	Ferragem canal 16 para basculante	1
30 92 01 02	Goteira com válvula preto	2 ou mais
30 96 00 12	Jogo topos condensação	1
30 92 04 70	Espuma isolante	L
30 93 01 20	Junta interior	2L+2H
30 70 16 30	Junta central	2L+2H
30 70 16 31	Canto vulcanizado	4
---	Junta para vidro (exterior)	2L+2H
---	Junta para vidro (interior)	2L+2H
30 96 00 04	Esquadro interior fixo	4

Vidro

Hv = H-189 mm	Lv = L-161 mm
---------------	---------------

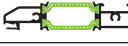

Porta 1 folha com oscilo-batente

Perfis

Desenho	Ref	Descrição	Corte	Quant	Medida
	API-08	Aro fixo		1	L
				2	H
	API-136	Aro móvel		2	L-73.5 mm
				2	H-46 mm
	---	Bite		2	L-216.5 mm
				2	H-229 mm
	AJi-62	Pingadeira		1	L-143 mm
	API-63	Soleira		1	L-80.5 mm
	KL-04	Perfil tampa		1	---

Acessórios e Juntas

Referência	Descrição	Quantidade
30 60 16 02	Esquadro interior móvel	4
30 60 00 02	Esquadro exterior	6
30 96 00 23	Esquadro alinhamento fixo	2
30 96 00 22	Esquadro alinhamento móvel	8
30 96 10 01	Calço para vidro	4
---	Puxador	1
---	Ferragem canal 16 (ver páginas ferragens)	1
30 93 01 20	Junta interior	2L+2H
30 70 16 30	Junta central	L+2H
30 70 16 31	Canto vulcanizado	2
30 60 00 13	Conjunto topos AJi-62	1
30 60 00 14	Pelúcia preta 18 mm	2L
---	Junta para vidro (exterior)	2L+2H
---	Junta para vidro (interior)	2L+2H
30 96 00 05	Esquadro interior fixo	2

Vidro

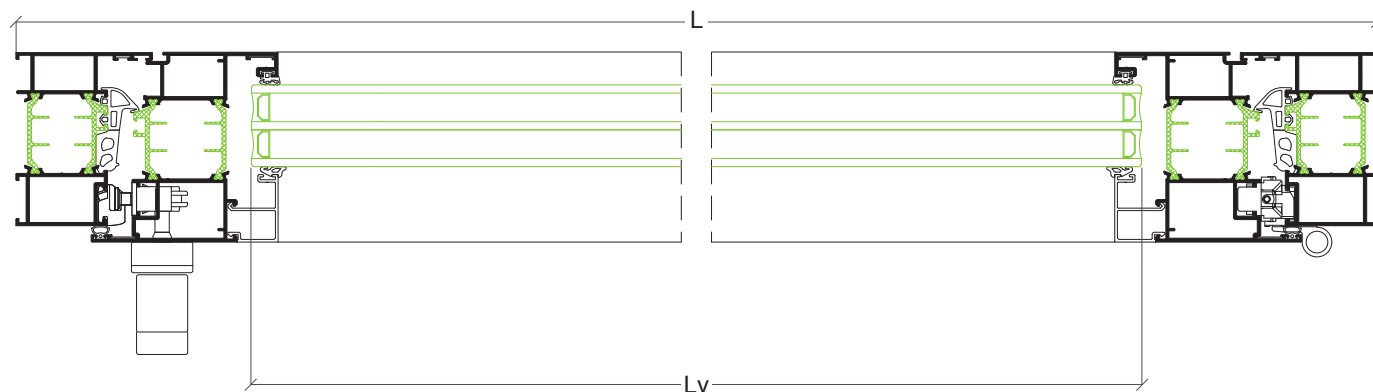

Hv = H-203 mm	Lv = L-230 mm
---------------	---------------

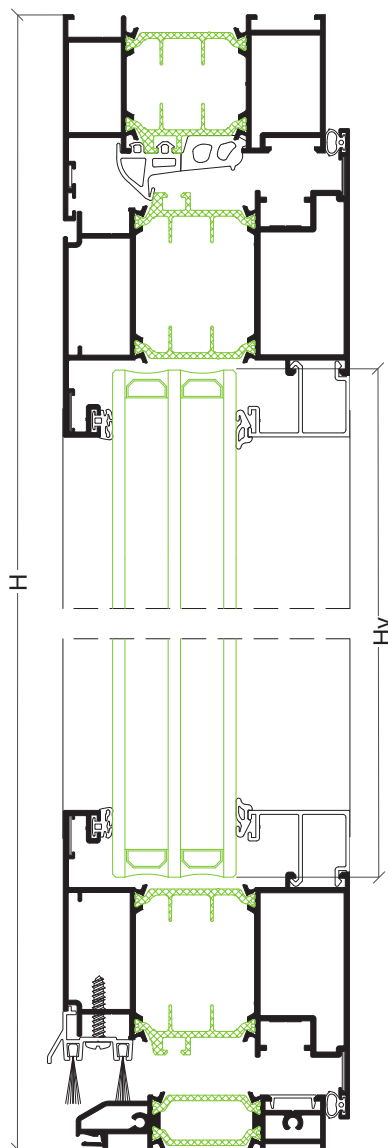
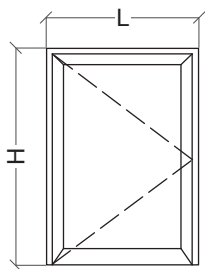

Porta 1 folha



Perfis

Desenho	Ref	Descrição	Corte	Quant	Medida
	API-08	Aro fixo		1	L
				2	H
	API-122	Aro móvel		2	L-73.5 mm
				2	H-46 mm
	---	Bite		2	L-233.5 mm
				2	H-246 mm
	AJi-62	Pingadeira		1	L-143 mm
	API-63	Soleira		1	L-80.5 mm
	KL-04	Perfil tampa		1	L-90 mm

Acessórios e Juntas

Referência	Descrição	Quantidade
30 96 00 05	Esquadro interior fixo	2
30 60 00 02	Esquadro exterior	2
30 60 16 04	Esquadro exterior móvel	4
30 60 16 05	Esquadro interior móvel	4
30 96 00 23	Esquadro alinhamento fixo	2
30 96 00 22	Esquadro alinhamento móvel	8
30 96 10 01	Calço para vidro	4
30 92 22 88 ou 89	Dobradiça 2 abas porta	2
30 60 16 20	Fechadura 3 pontos	1
30 92 22 82 ou 83	Puxador duplo	1
30 92 22 85 ou 86	Escudo para canhão	2
30 92 13 03	Canhão	1
30 93 01 20	Junta interior	2L+2H
30 70 16 30	Junta central	L+2H
30 70 16 31	Canto vulcanizado	2
30 60 00 13	Conjunto topos AJi-62	1
30 60 00 14	Pelúcia preta 18 mm	2L
---	Junta para vidro (exterior)	2L+2H
---	Junta para vidro (interior)	2L+2H
30 60 16 21 ou 22	Conjunto chapa-testas para aro fixo	1

Vidro



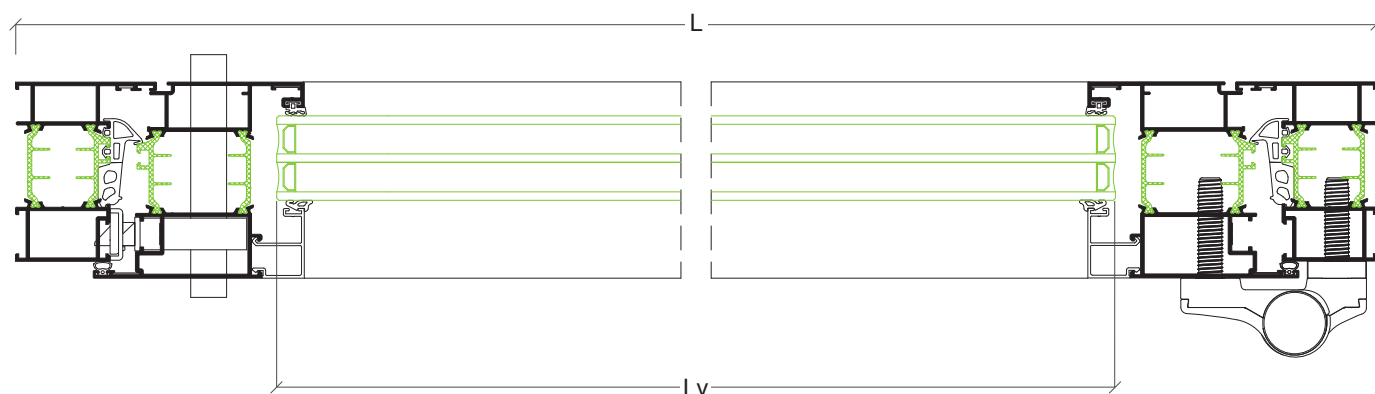



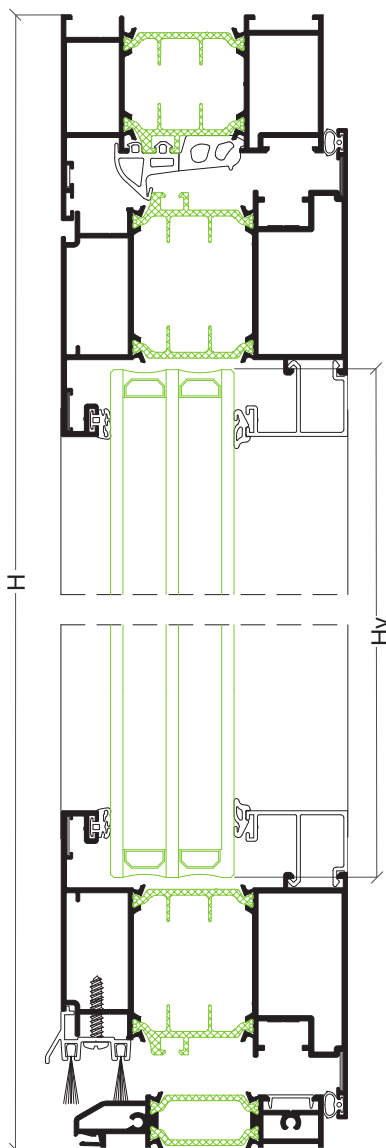
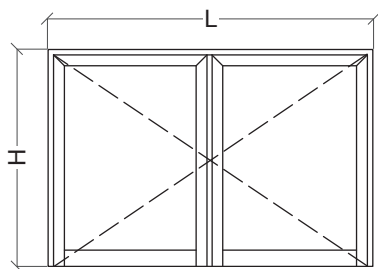



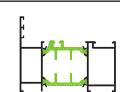

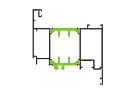



Hv = H-220 mm	Lv = L-247 mm
---------------	---------------

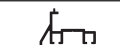

Porta 2 folhas



Perfis

Desenho	Ref	Descrição	Corte	Quant	Medida
	API-08	Aro fixo		1	L
				2	H
	API-122	Aro móvel		4	L/2-39.5 mm
				4	H-46 mm
	API-117	Inversor		1	H-122 mm
	---	Bite		4	L/2-199.5 mm
				4	H-246 mm
	AJi-62	Pingadeira		2	L/2-106 mm L/2-38 mm
	API-63	Soleira		1	L-80.5 mm
	KL-04	Perfil tampa		1	L-90 mm

Acessórios e Juntas







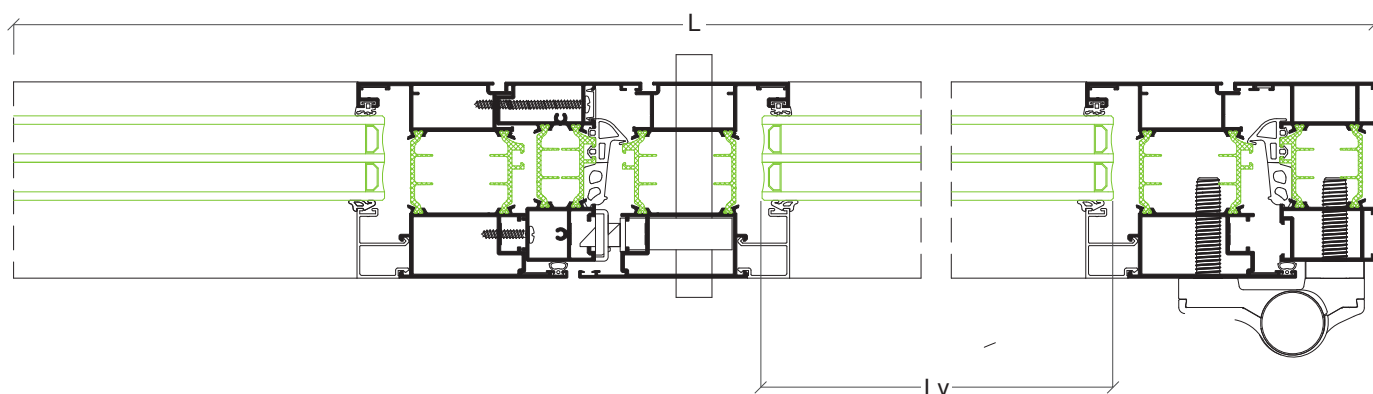

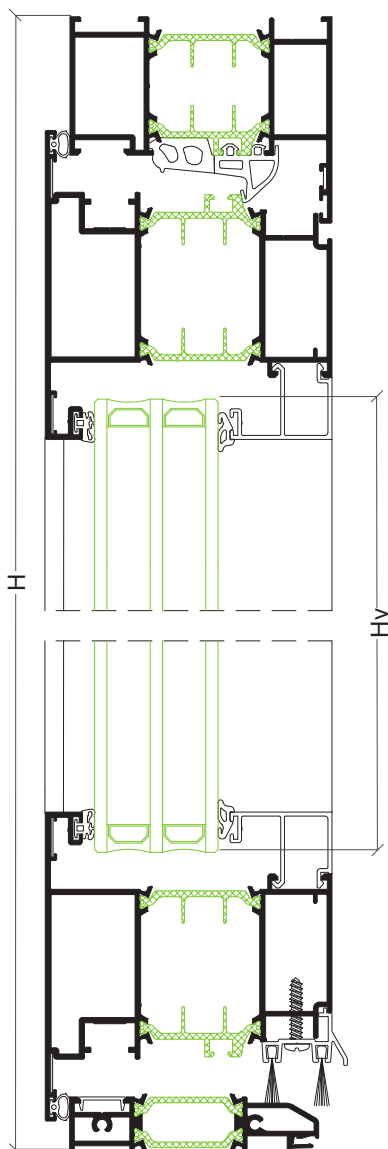
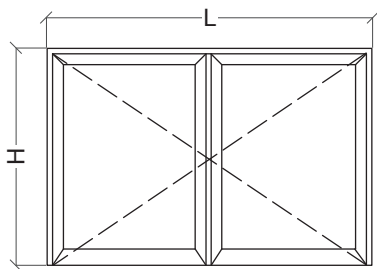

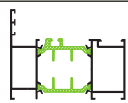

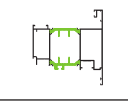



Referência	Descrição	Quantidade
30 60 16 02	Esquadro interior	2
30 60 00 02	Esquadro exterior	2
30 60 16 04	Esquadro exterior móvel	8
30 60 16 05	Esquadro interior móvel	8
30 96 00 23	Esquadro alinhamento fixo	2
30 96 00 22	Esquadro alinhamento móvel	16
30 96 10 01	Calço para vidro	8
30 92 22 88 ou 89	Dobradiça 2 abas porta	4
30 60 16 20	Fechadura 3 pontos	1
30 92 16 23 ou 24	Conjunto chapa-testas para inversor	1
30 92 22 82 ou 83	Puxador duplo	1
30 92 22 85 ou 86	Escudo para canhão	2
30 92 13 03	Canhão	1
30 70 16 12	Jogo topos inversor	1
30 93 01 20	Junta interior	2L+4H
30 70 16 30	Junta central	L+3H
30 70 16 31	Canto vulcanizado	2
30 60 00 13	Conjunto topos AJi-62	1
30 60 00 14	Pelúcia preta 18 mm	2L
---	Junta para vidro (exterior)	2L+4H
---	Junta para vidro (interior)	2L+4H

Vidro

Hv = H-220 mm	Lv = L/2-213 mm
---------------	-----------------

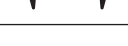

Porta 2 folhas abertura exterior

Perfis

Desenho	Ref	Descrição	Corte	Quant	Medida
	API-08	Aro fixo		1	L
				2	H
	API-172	Aro móvel		4	L/2-39.5 mm
				4	H-46 mm
	API-117	Inversor		1	H-122 mm
	---	Bite		2	L/2-199.5 mm
				2	H-246 mm
	AJi-62	Pingadeira		2	L/2-106 mm L/2-38 mm
	APi-63	Soleira		1	L-80.5 mm
	KL-04	Perfil tampa		1	L-90 mm

Acessórios e Juntas

Referência	Descrição	Quantidade
30 96 00 05	Esquadro interior fixo	2
30 60 00 02	Esquadro exterior	2
30 60 16 04	Esquadro exterior móvel	8
30 60 16 05	Esquadro interior móvel	8
30 96 00 23	Esquadro alinhamento fixo	2
30 96 00 22	Esquadro alinhamento móvel	16
30 96 10 01	Calço para vidro	8
30 92 22 88 ou 89	Dobradiça 2 abas porta	4
30 60 16 20	Fechadura 3 pontos	1
30 92 22 82 ou 83	Puxador duplo	1
30 92 22 85 ou 86	Escudo para canhão	2
30 70 16 12	Jogo topos inversor	1
30 92 13 03	Canhão	1
30 93 01 20	Junta interior	2L+4H
30 70 16 30	Junta central	L+3H
30 70 16 31	Canto vulcanizado	2
30 60 00 13	Conjunto topos AJi-62	1
30 60 00 14	Pelúcia preta 18 mm	2L
---	Junta para vidro (exterior)	2L+4H
---	Junta para vidro (interior)	2L+4H
30 60 16 23 ou 24	Conjunto chapa-testas para inversor	1

Vidro

Hv = H-220 mm	Lv = L/2-213 mm
---------------	-----------------

