

www.anicolor.pt

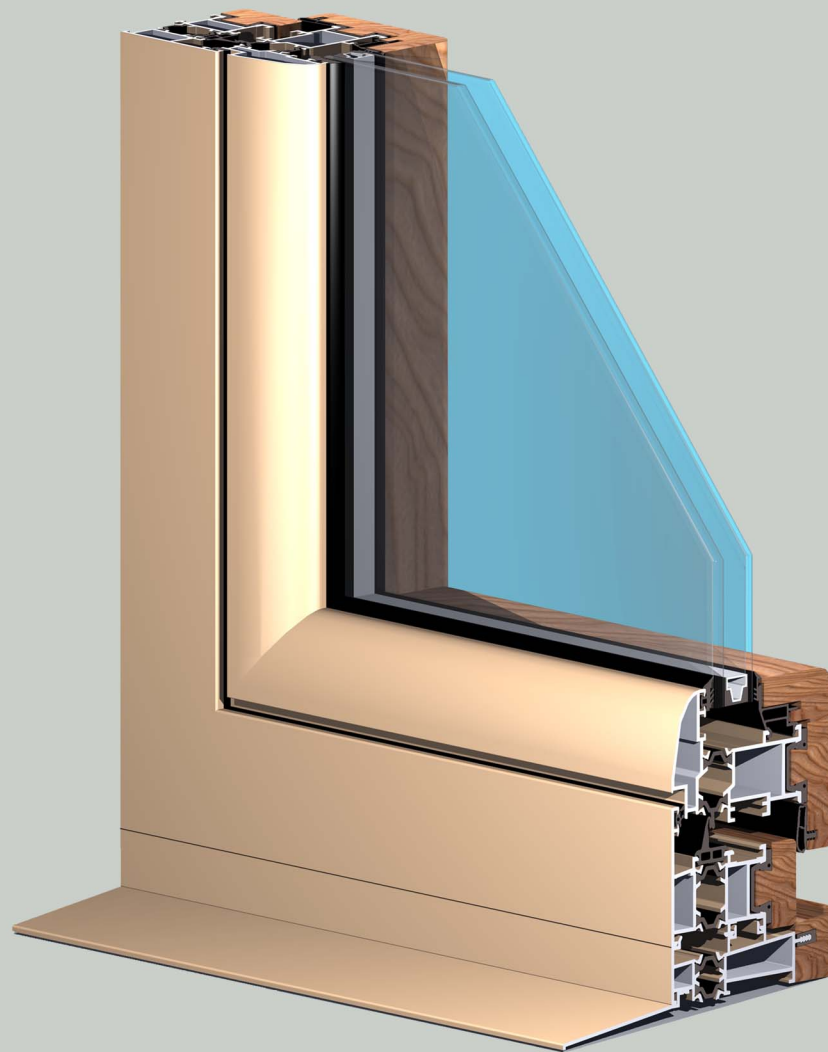

AM

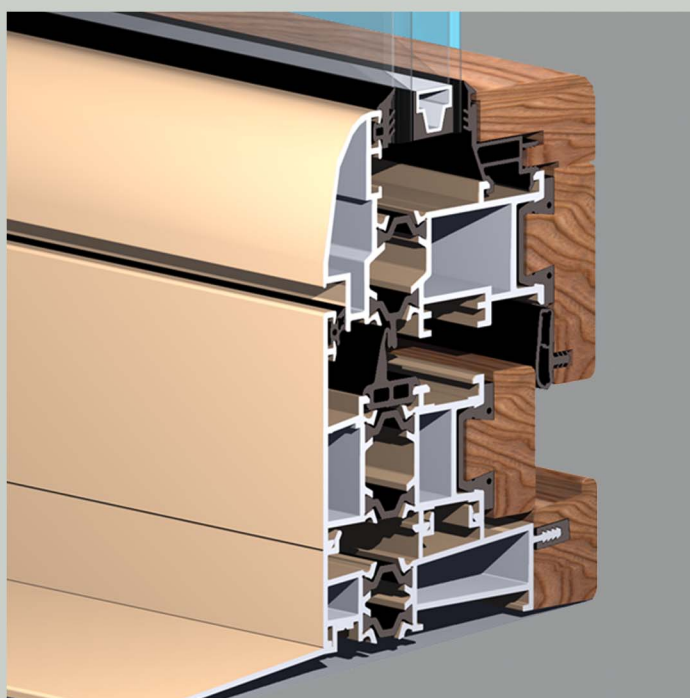

Série
AM

SISTEMA AM

Inovador sistema de batente com Rotura Térmica que combina na perfeição as prestações do alumínio no exterior, com a nobreza e qualidade da madeira no interior.

As secções interior-exterior do aro e móvel são respectivamente de 68,9mm e 88,4mm com uma espessura média dos perfis de alumínio de 1,6mm em janela e 1,8mm em porta.

ACABAMENTOS

Lacado, Lacado Decorativo (Madeira) e Anodizado.

Interior em Madeira: madeiras nobres (Carvalho Americano, Mogno, Pinho).

No acabamento destas molduras utiliza-se um verniz ecológico, sem solventes, transparente e acetinado.

Esta combinação de acabamentos permite uma óptima integração com a decoração interior.

POSSIBILIDADES DE ABERTURA

Abertura interior: Batente, Oscilo-batente, harmónio, oscilo-paralela

Abertura exterior: Batente, projectante-deslizante.

CATEGORIAS ALCANÇADAS EM BANCO DE ENSAIOS (EN14351-1)

Permeabilidade ao ar (EN 1026): Classe 4

Estanquidade à água (EN 1027): Classe 9A

Resistência ao vento (EN 12211): Classe C5

Coeficiente de transmissão térmica de vão de 2 folhas: $U_w = 2.23 \text{ W/m}^2\text{K}$*

Coeficiente de atenuação acústica de vão de 2 folhas: $R_w = 35 \text{ dB}$ (C=-1; Ctr=-4)*

Zonas de aplicação segundo RCCTE (Em função de U_g): I1, I2, I3, V1, V2, V3

**Janela de 2 folhas 1,20m x 1,50m com vidro 4 /16 /6*

($U_g = 1,4 \text{ W/m}^2\text{K}$; $g=0,57$)

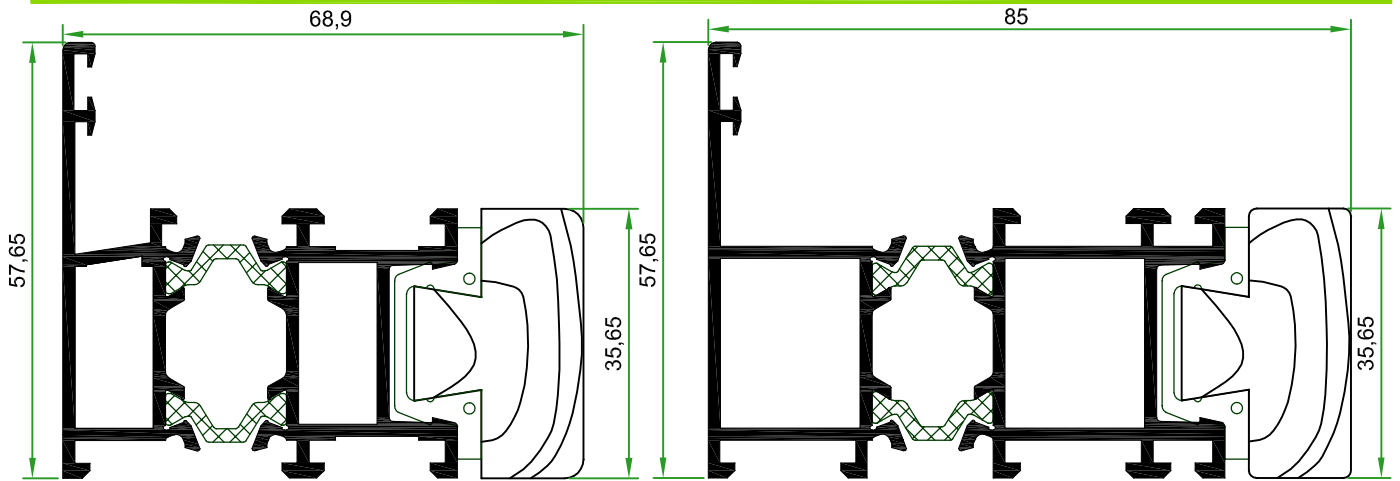

AM-3

Aro fixo

AM-23

Aro para fixos abertura exterior

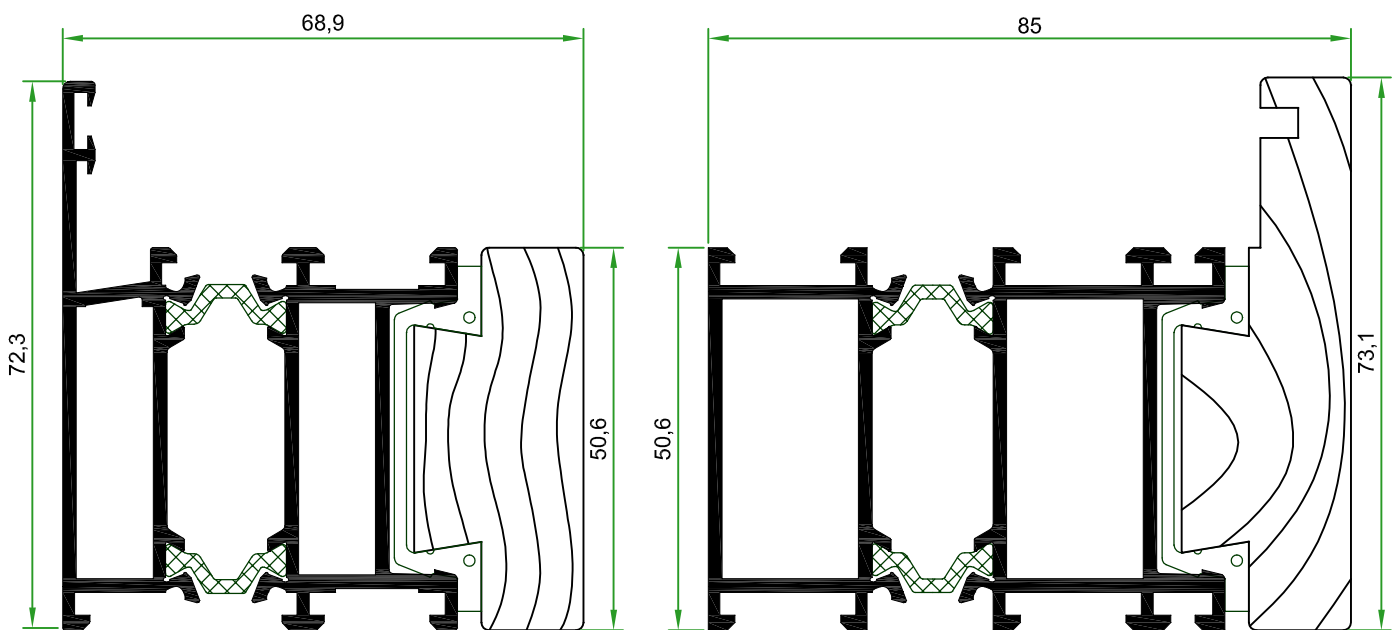

AM-8

Aro fixo

AM-29

Aro fixo abertura exterior

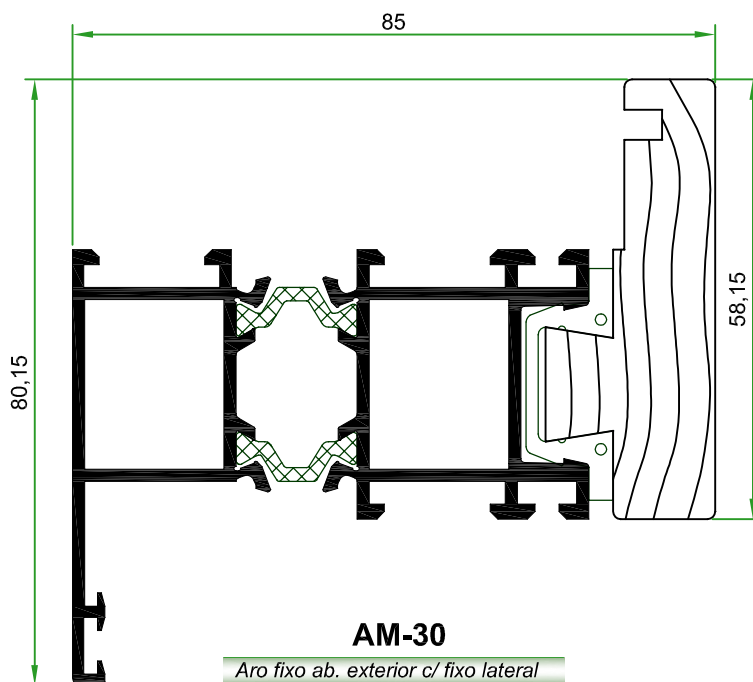

AM-30

Aro fixo ab. exterior c/ fixo lateral

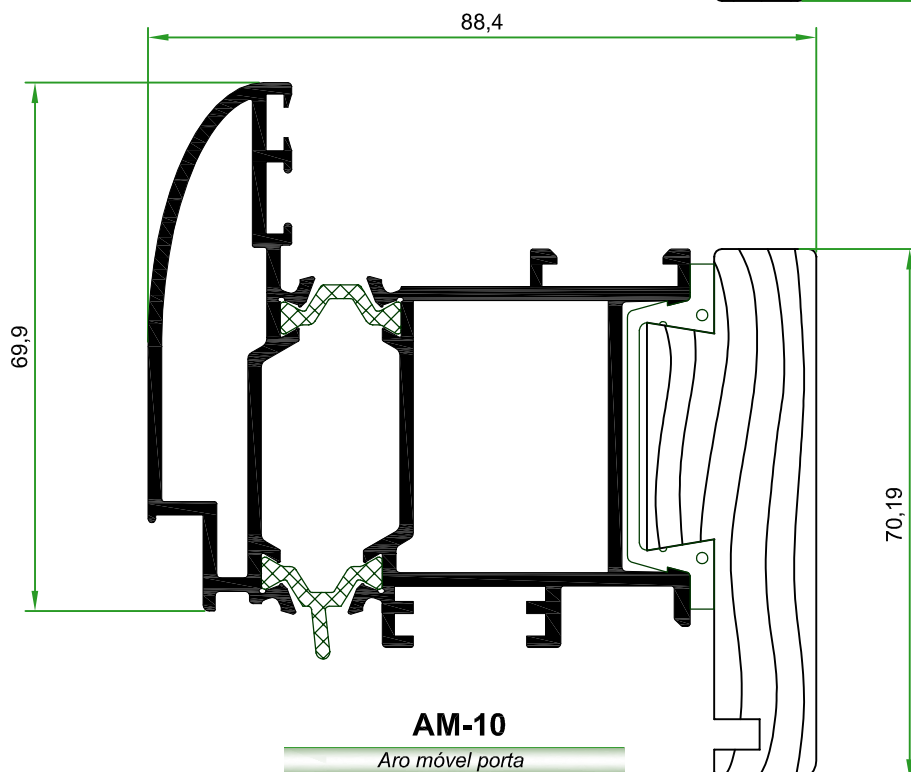
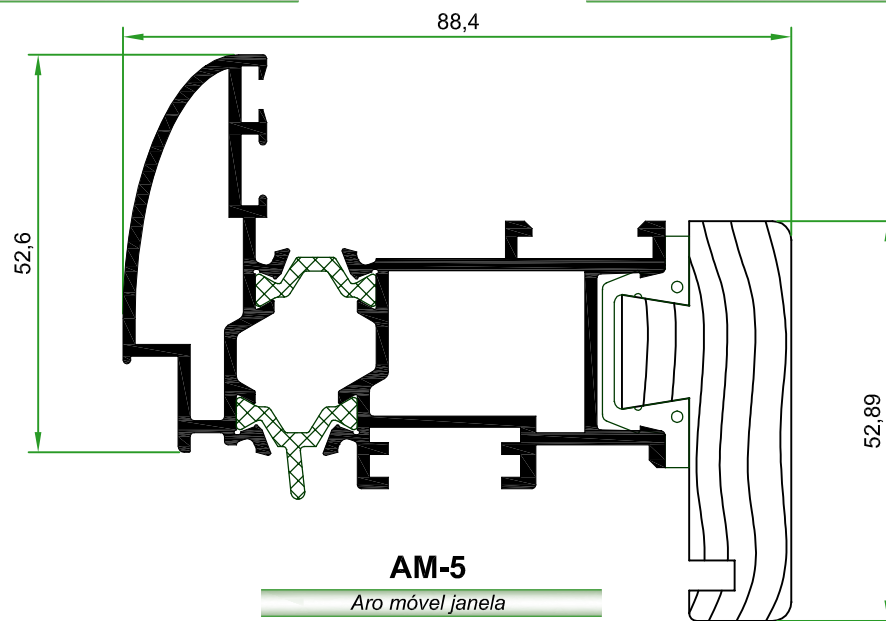
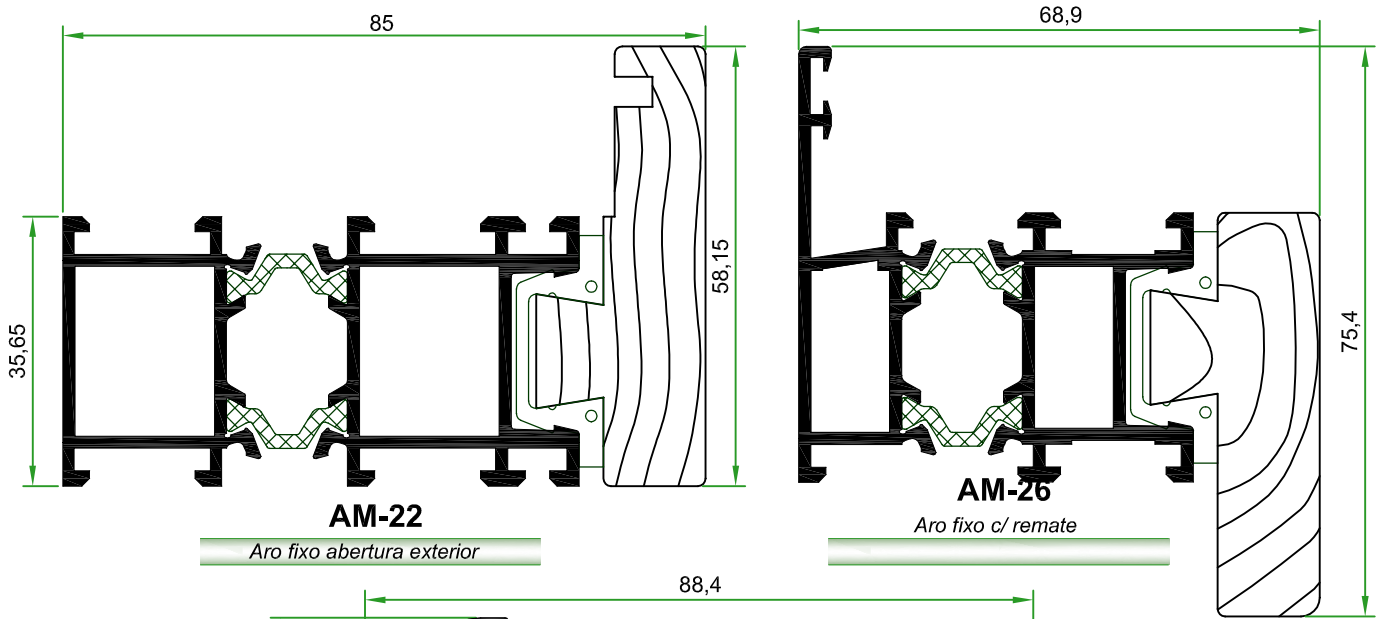

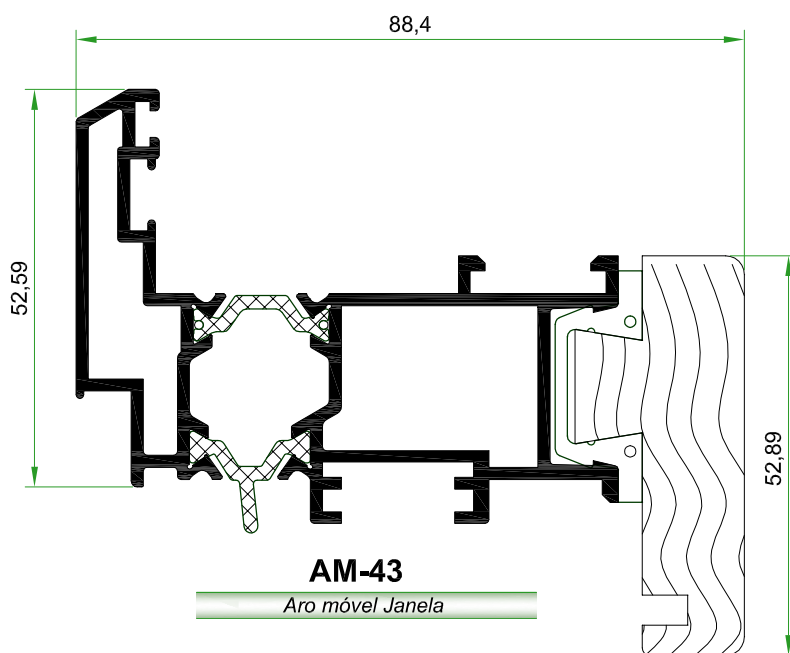
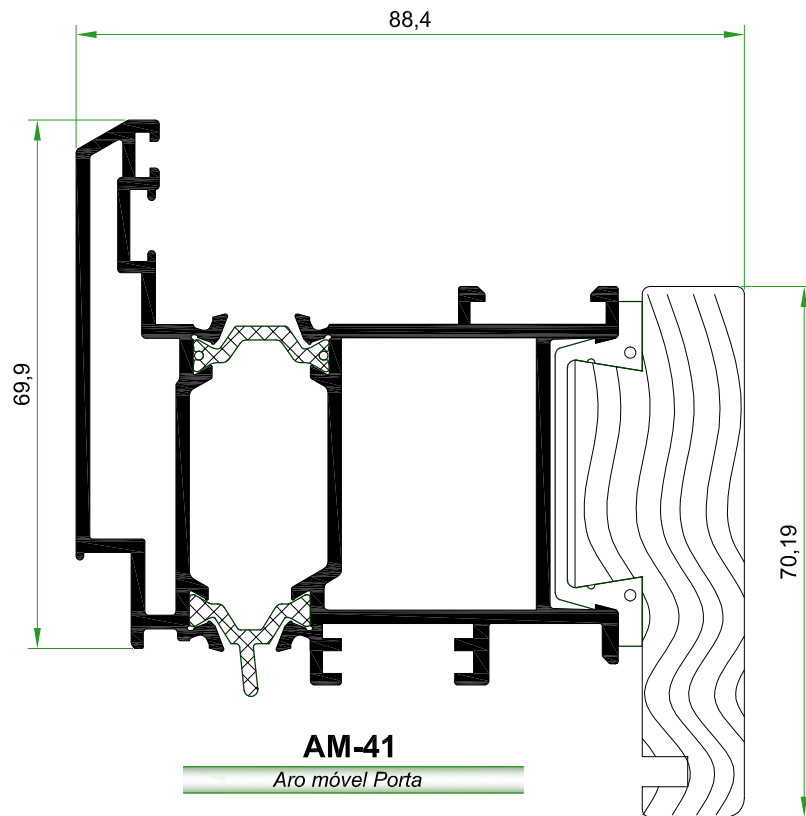

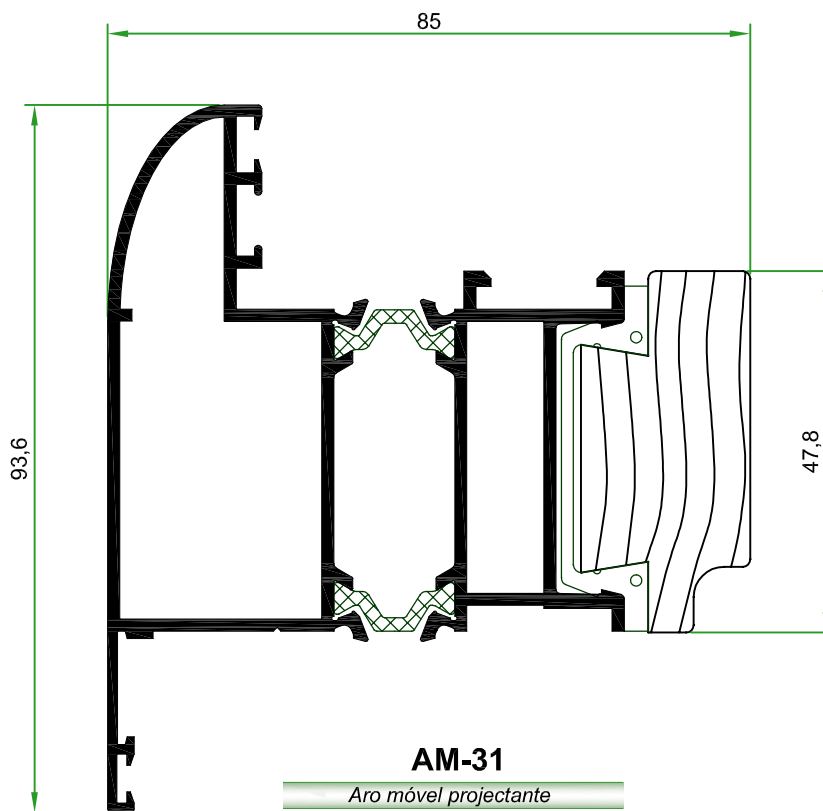
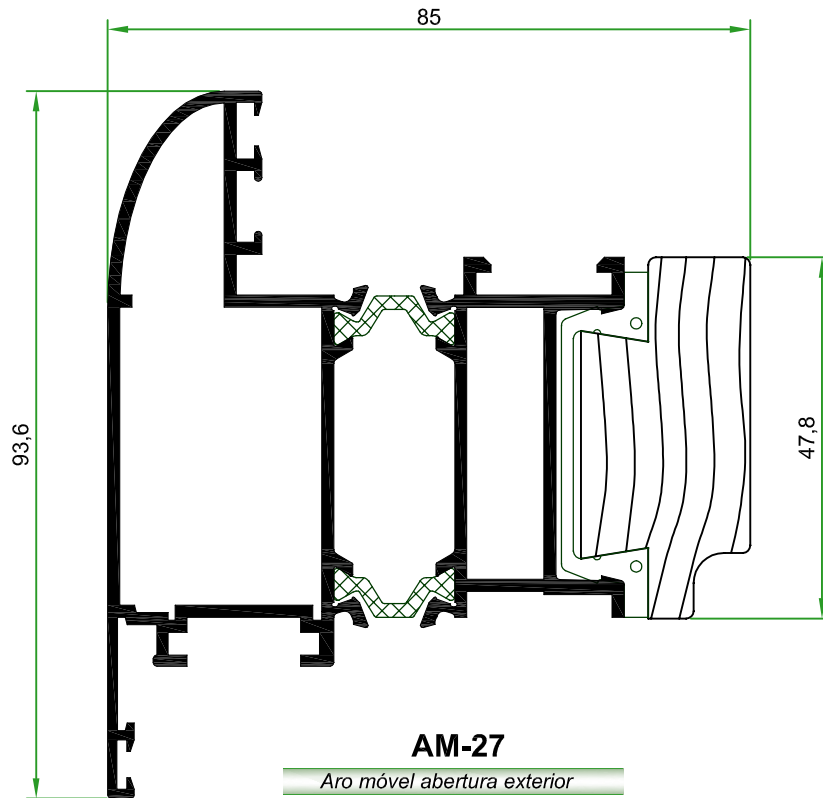

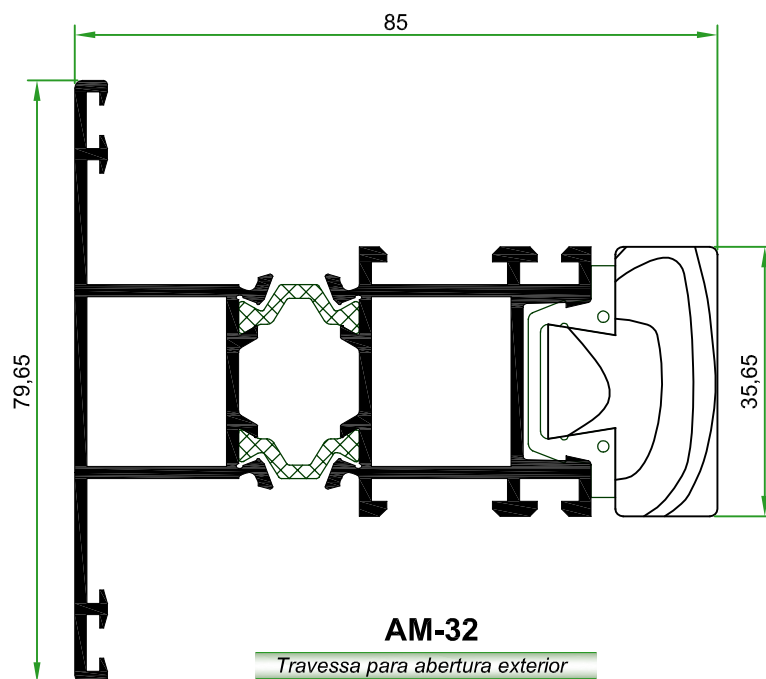
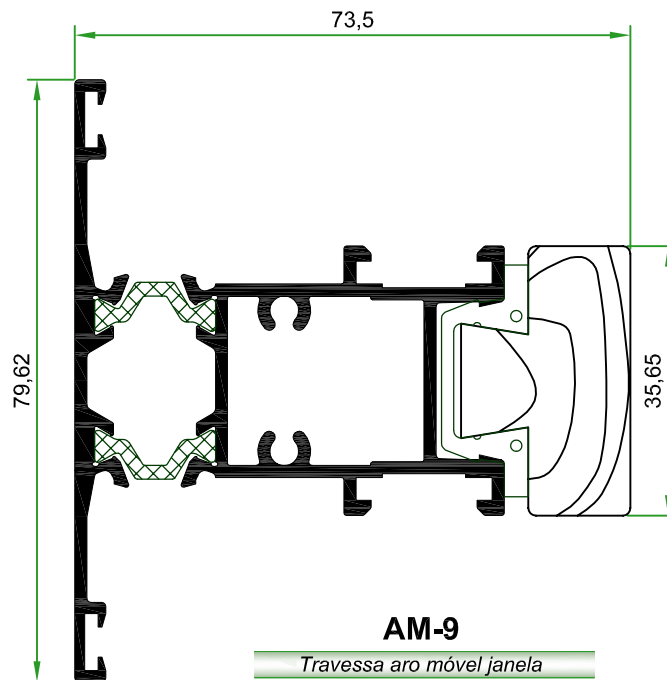
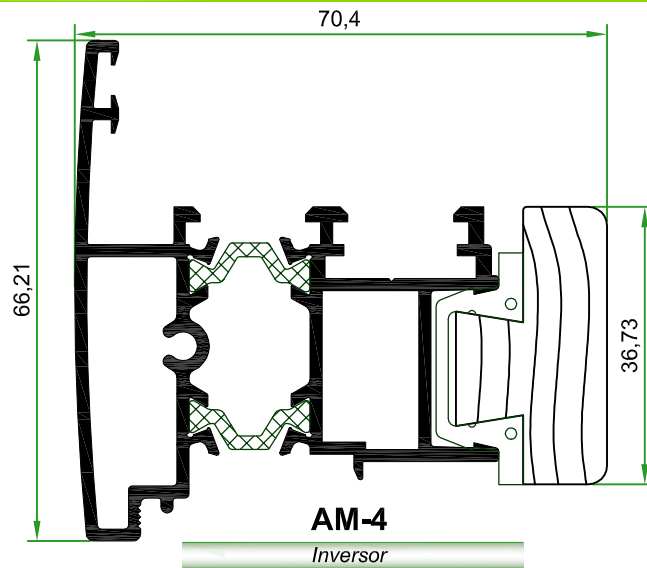

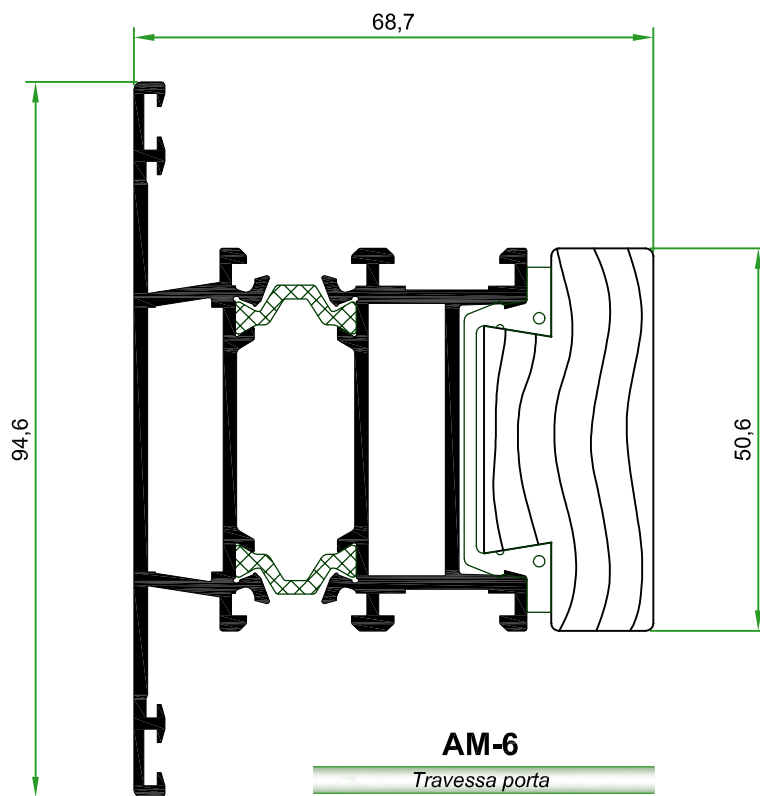
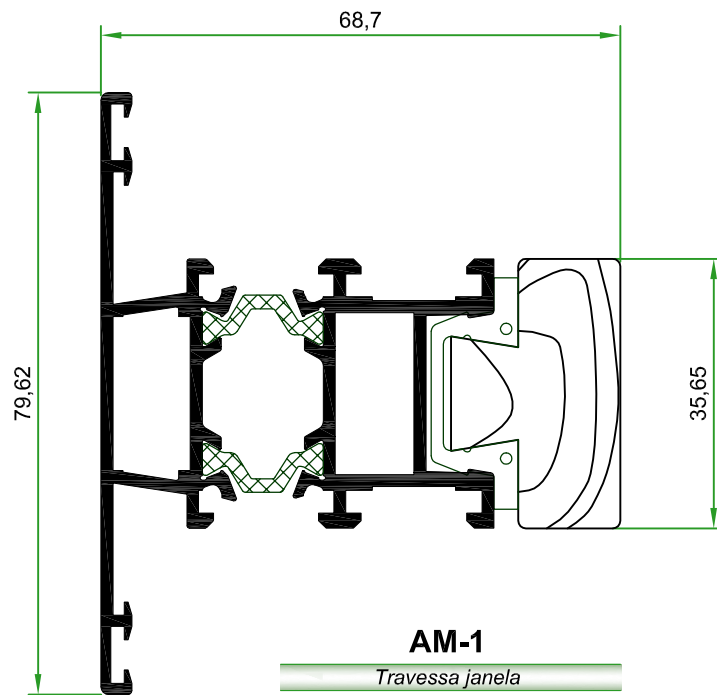

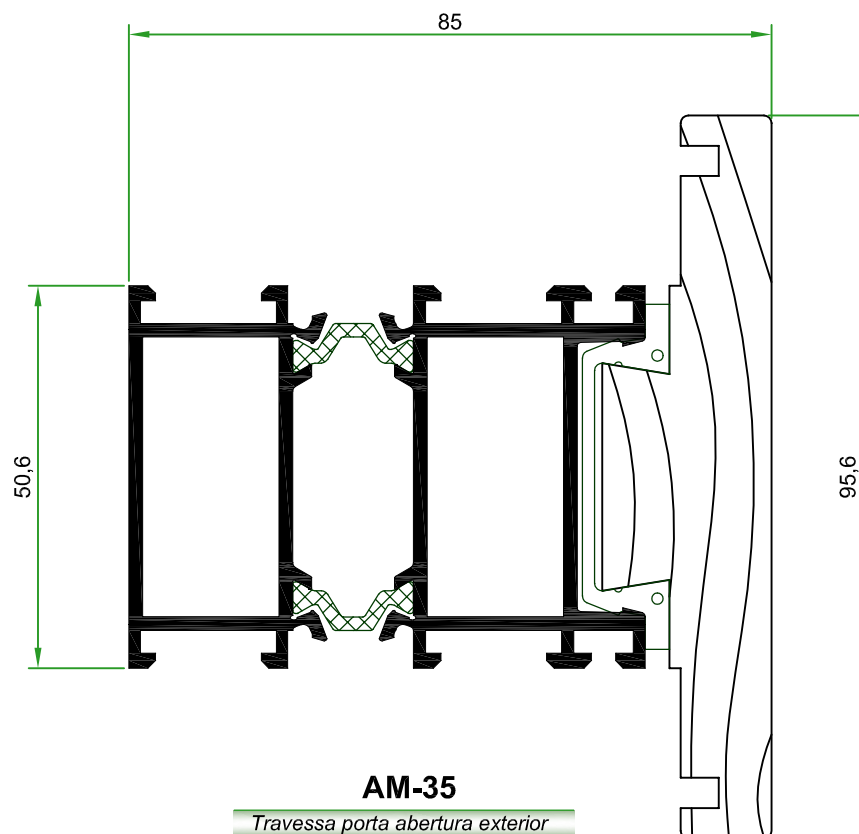
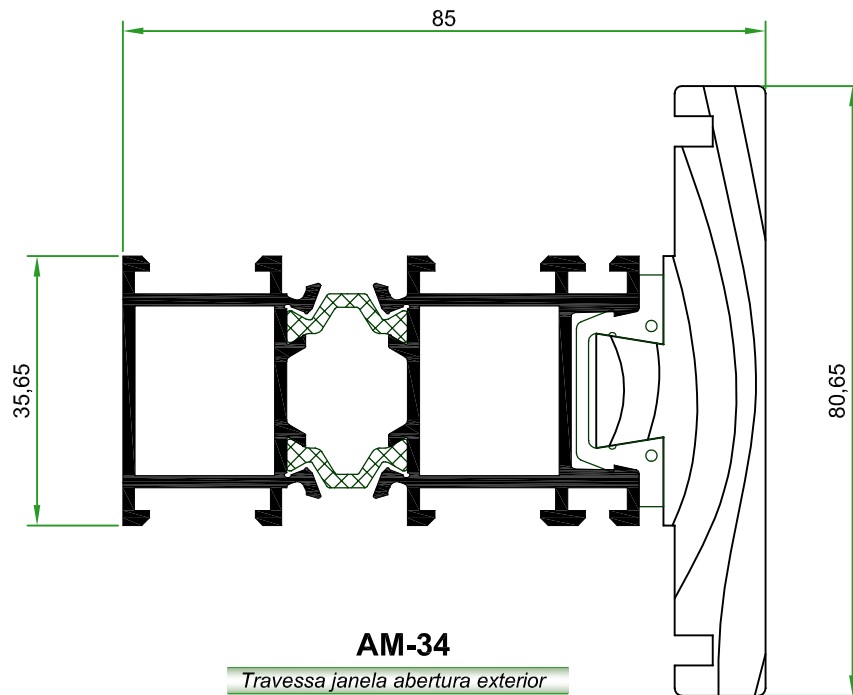

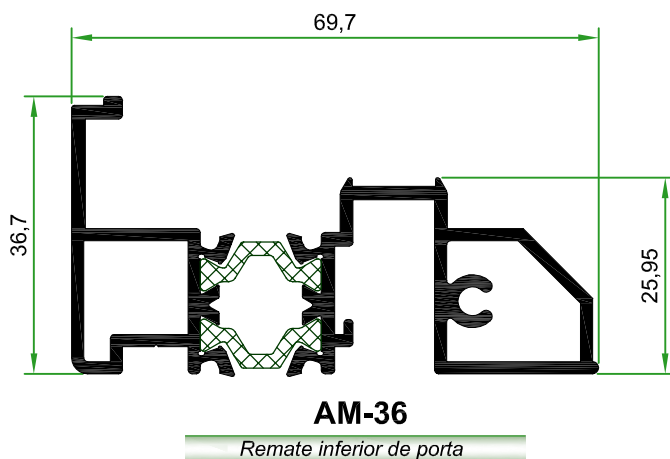
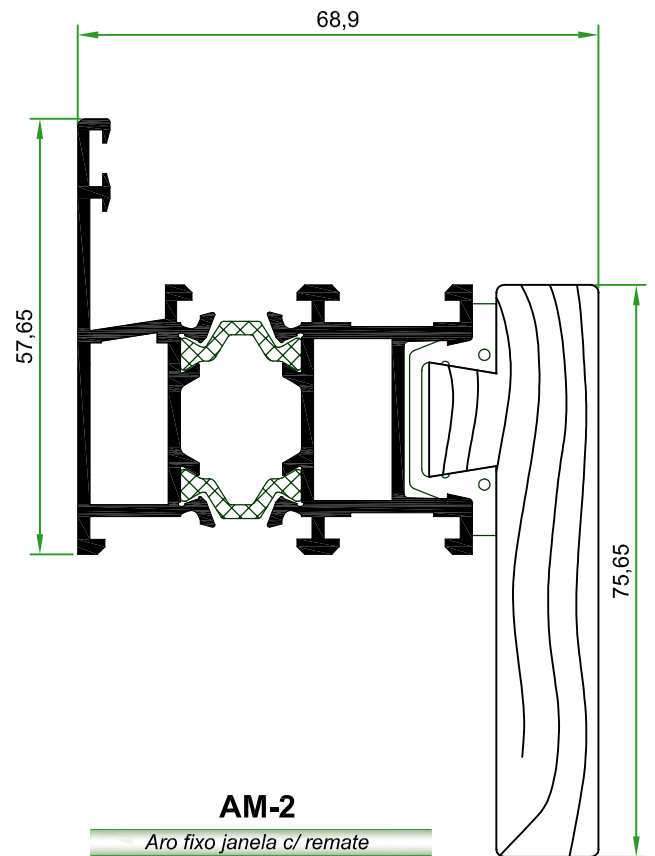
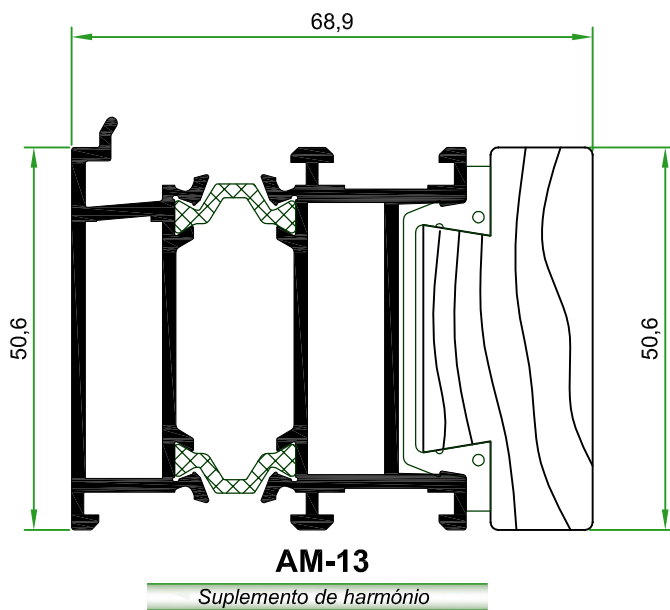
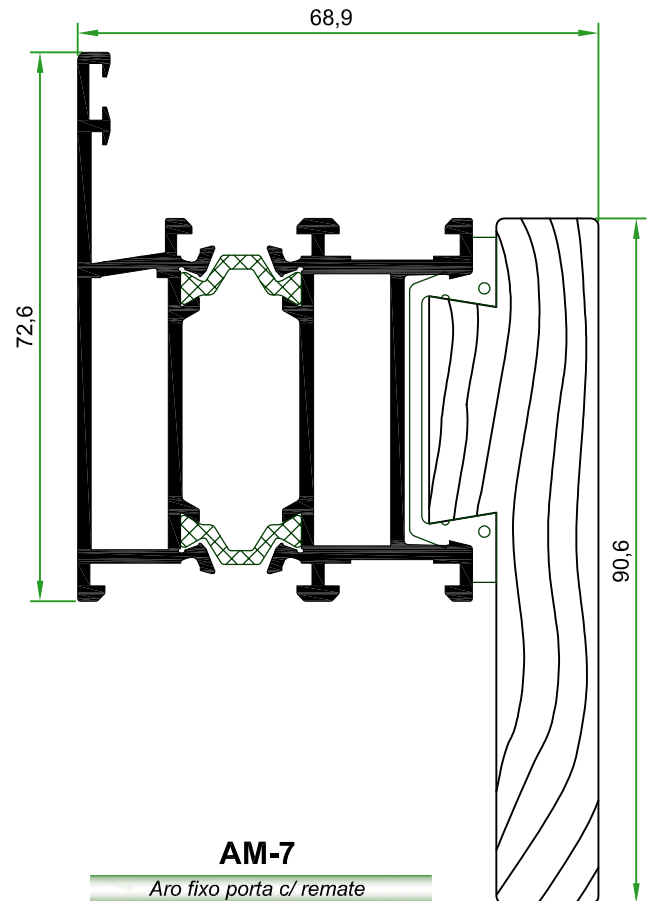
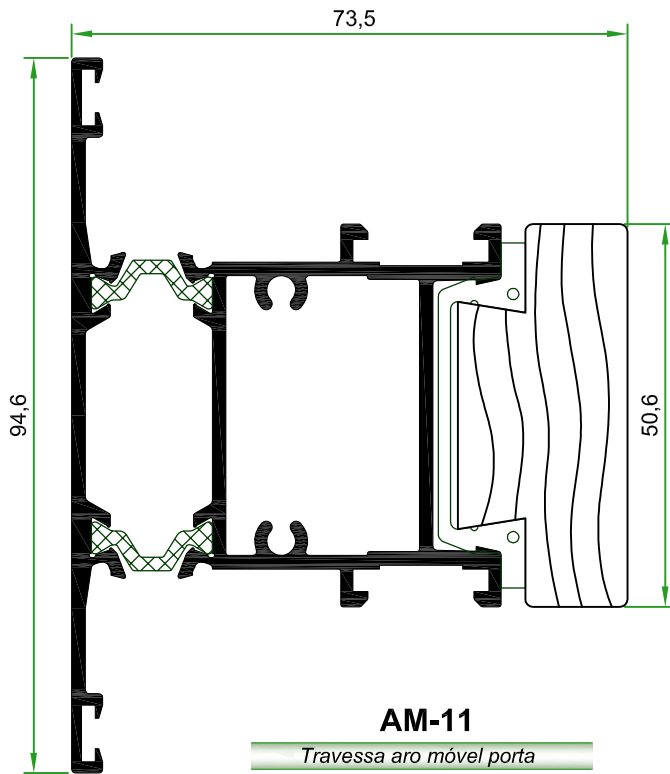

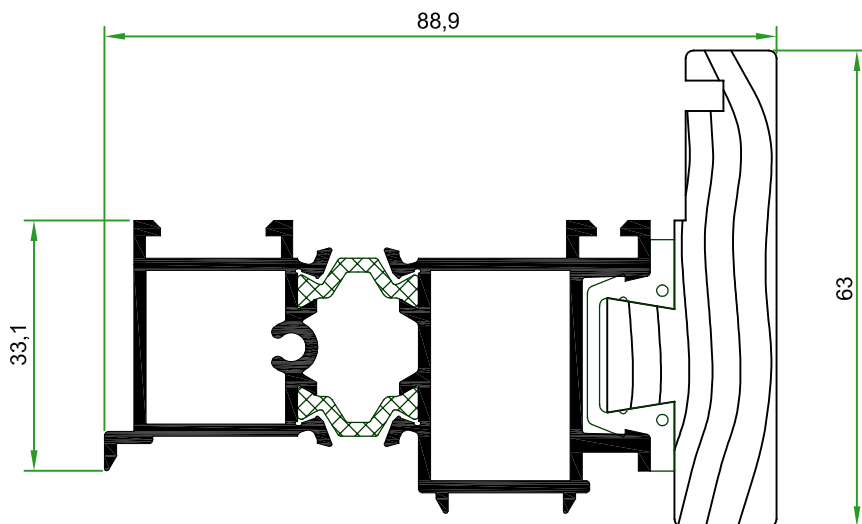

AM-25

Inversor abertura exterior

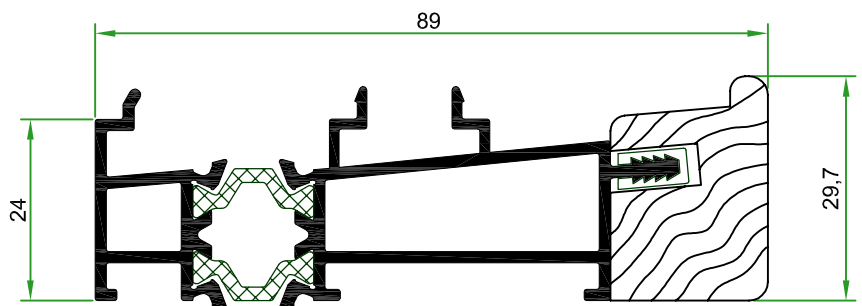

AM-14

Soleira condensação

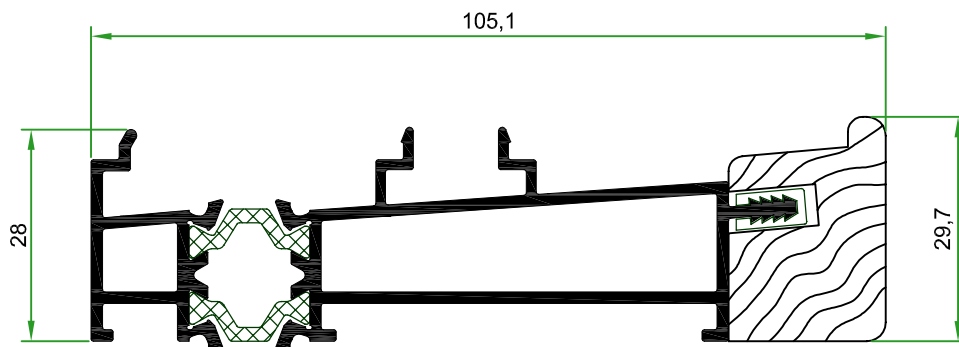

AM-33

Soleira condensação ab. exterior

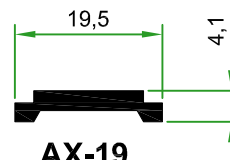

AX-19

Barra cremone

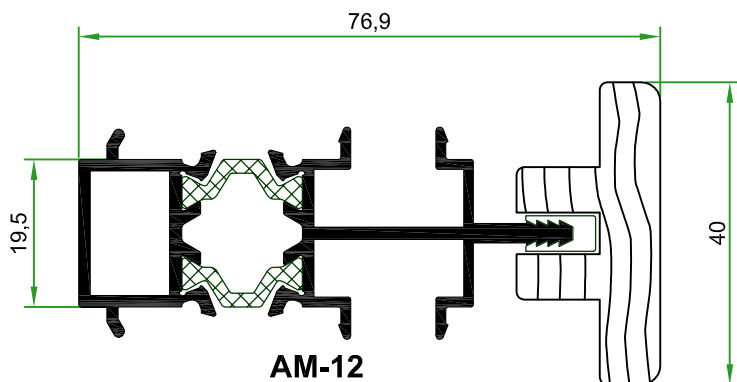

AM-12

União de aros

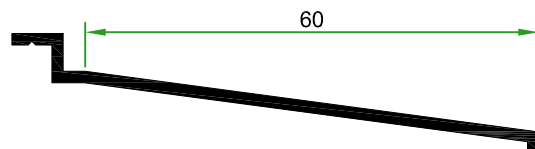

AZ-23

Pingadeira 60 mm

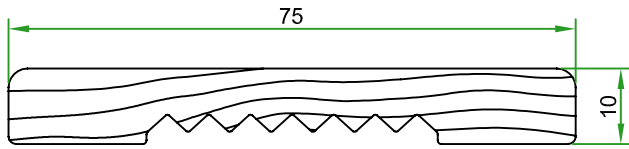

AM-40

Remate 75 mm

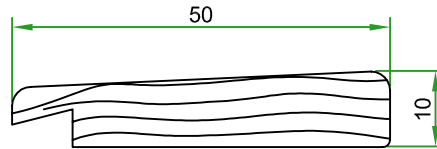

AM-15

Remate 50 mm

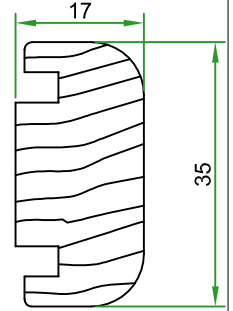

AM-39

Divisor de vidro

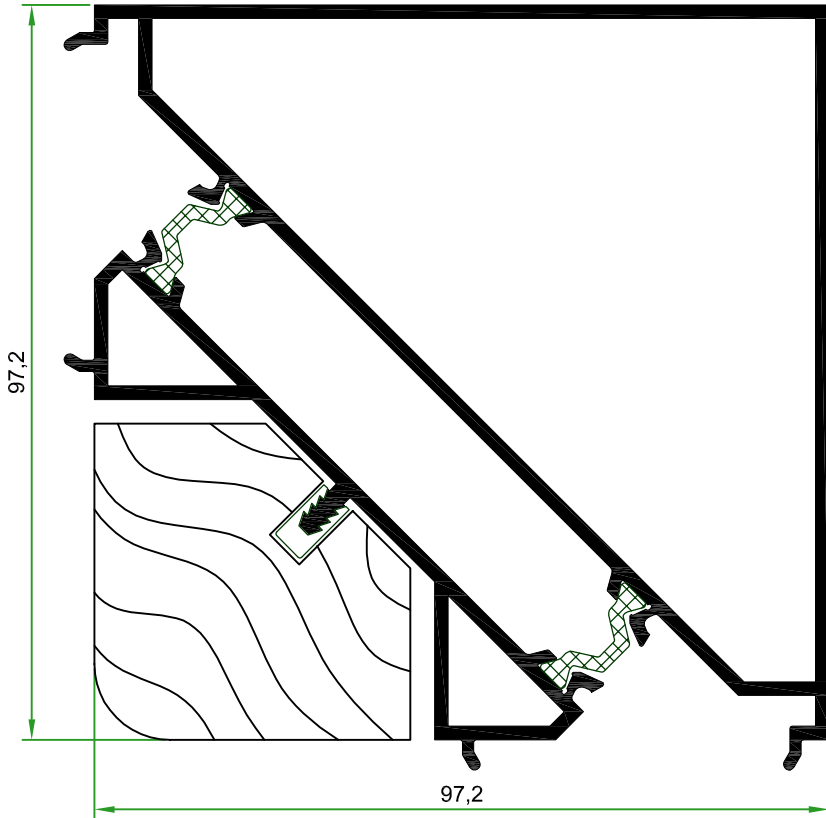

AM-28

Canto 90°

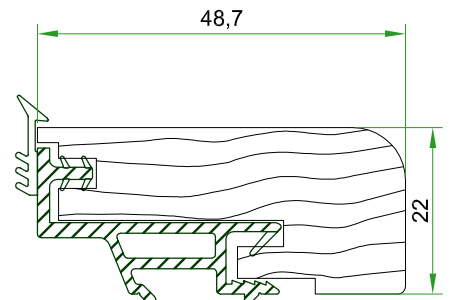

AM-42

Remate 50 mm

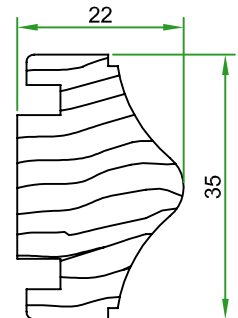

AM-38

Divisor de vidro tradição

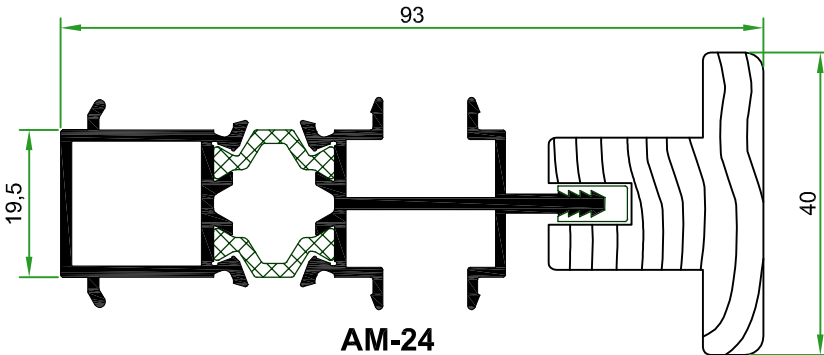

AM-24

União de aros abertura exterior

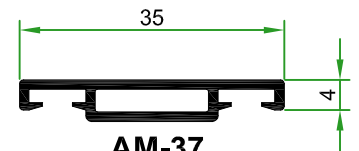

AM-37

Divisor de vidro

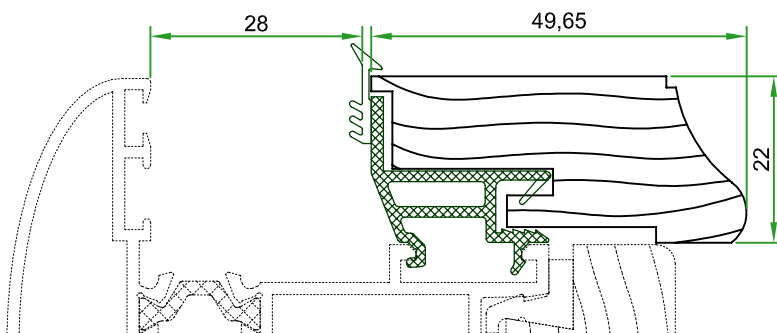

AM-21

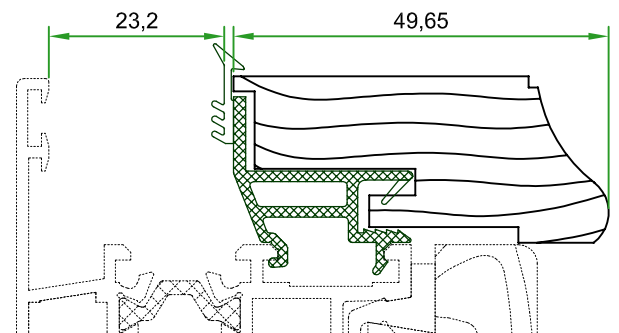

AM-21

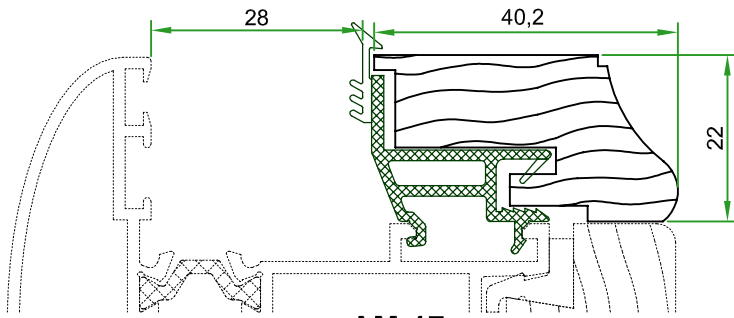

AM-17

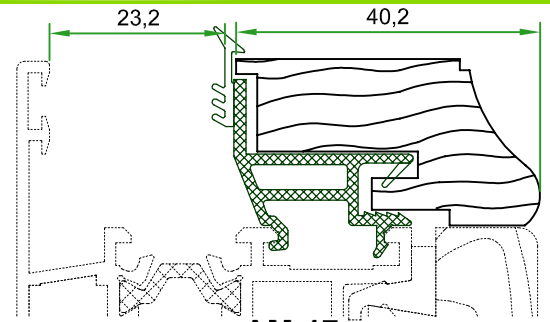

AM-17

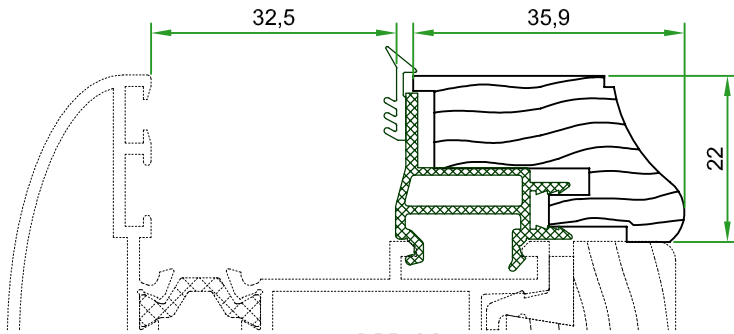

AM-18

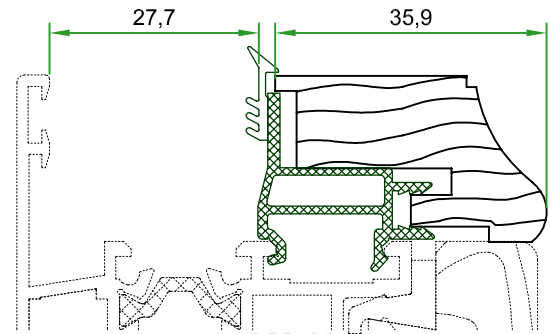

AM-18

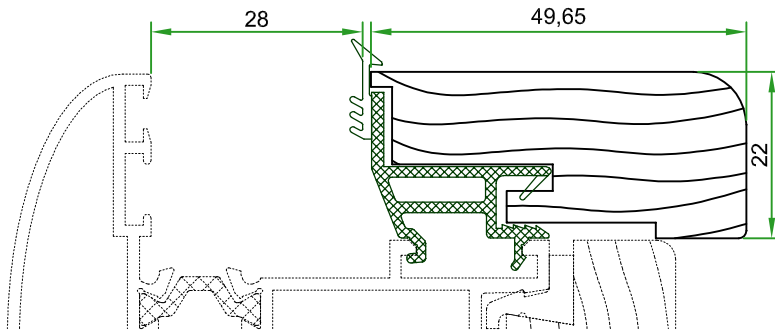

AM-20

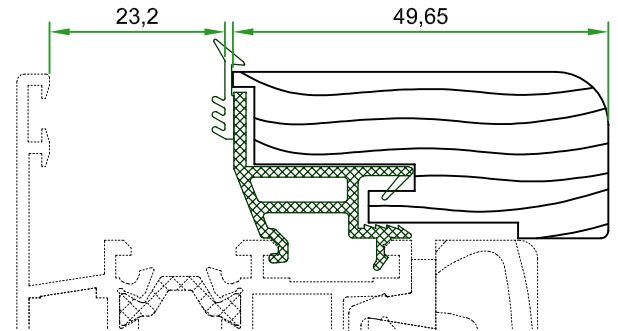

AM-20

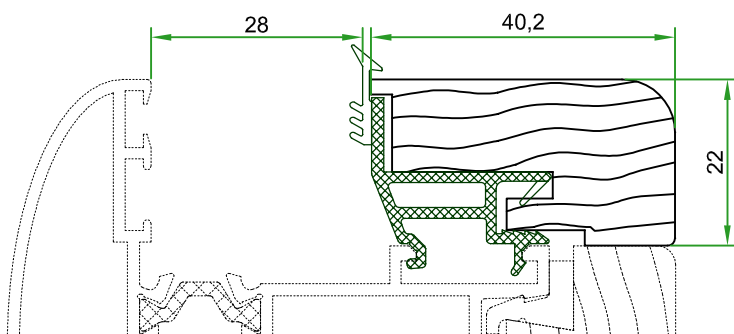

AM-16

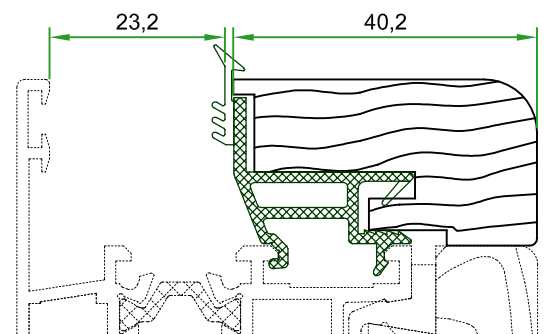

AM-16

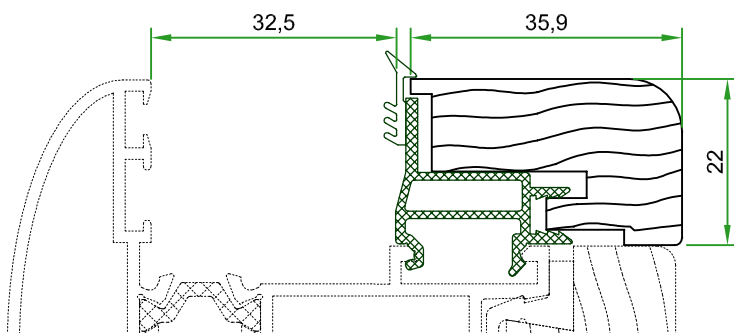

AM-19

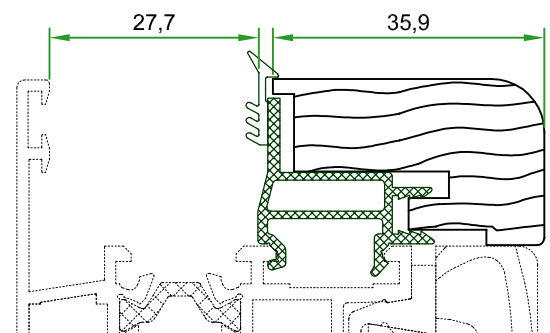

AM-19

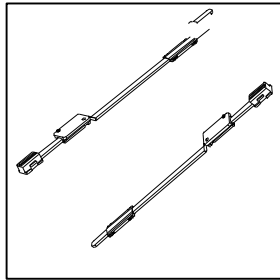
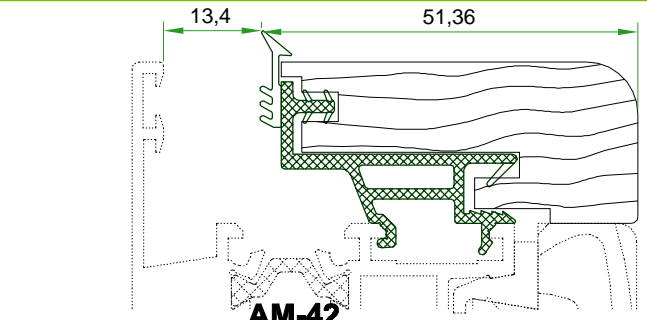
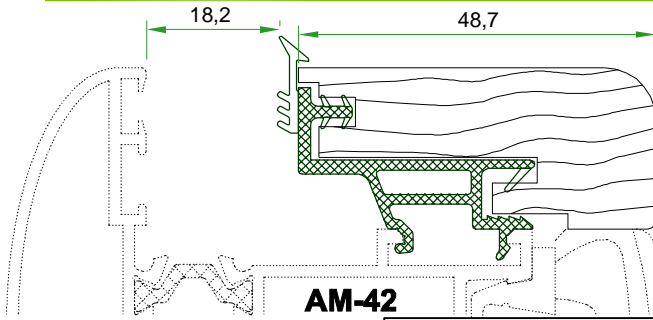

30 21 87 04

Jogo de fechos

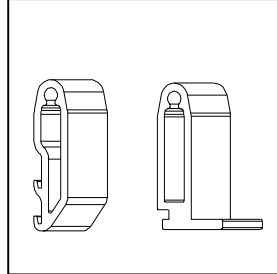

30 21 87 05

União topos janela int.

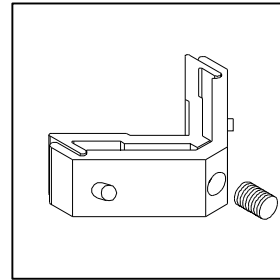

30 21 87 07

Esquadro aro fixo janela

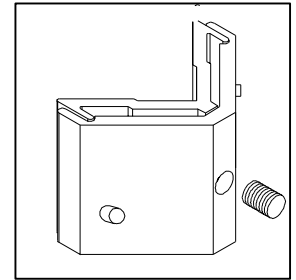

30 21 87 08

Esquadro aro móvel janela

30 21 87 06

União topos janela ext.

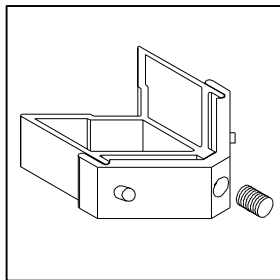

30 21 87 09

Esquadro aro fixo porta

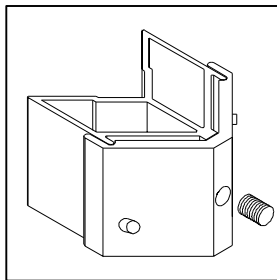

30 21 87 10

Esquadro aro móvel porta

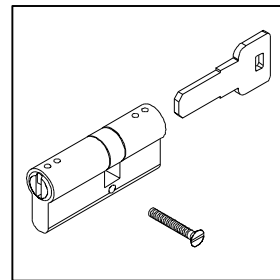

30 21 87 11

Canhão fechadura

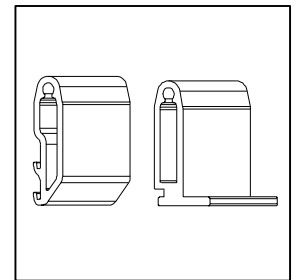

30 21 87 12

União topos porta int.

30 21 87 13

União topos porta ext.

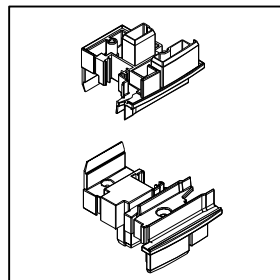

30 21 87 15

Jogo topos inversor

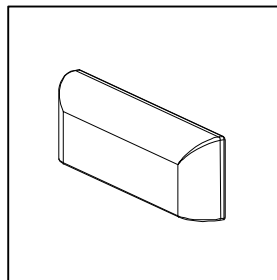

30 92 01 00 / 30 92 01 01

Goteiras Branco / Preto

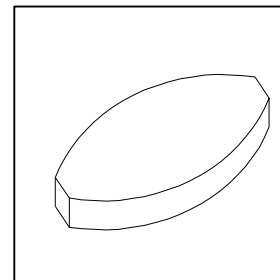

30 95 50 40

Pastilha alinhamento madeira

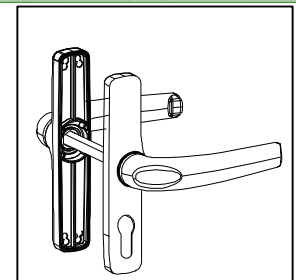

30 95 50 90

Jogo puxadores porta (preto)

30 95 50 91

Jogo puxadores porta (ouro)

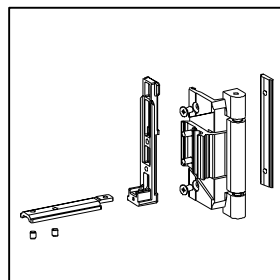

30 95 52 10

Dobradiça inf. 3 abas (ouro)

30 95 52 11

Dobradiça inf. 3 abas (preto)

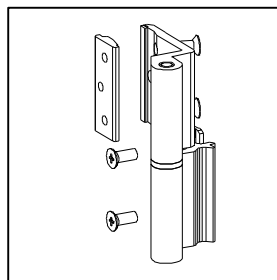

30 95 52 12

Dobradiça (ouro)

30 95 52 13

Dobradiça (preto)

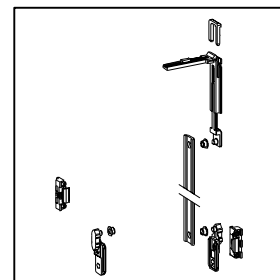

30 95 52 14

Kit fecho 6 pontos

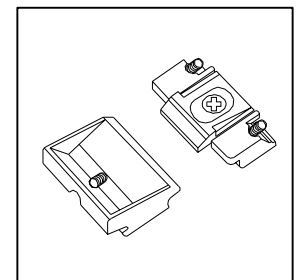

30 95 52 15

Fecho suplem. lado dobradiças

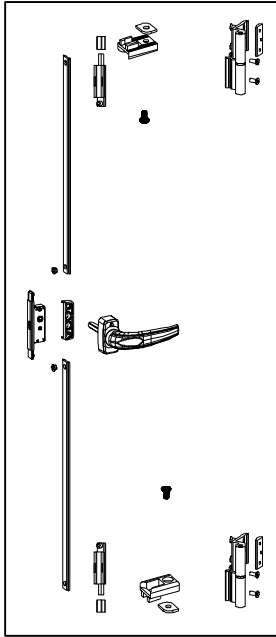

30 95 52 16

Kit 1 folha (ouro)

30 95 52 17

Kit 1 folha (preto)

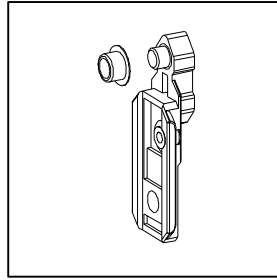

30 95 52 22

Fecho

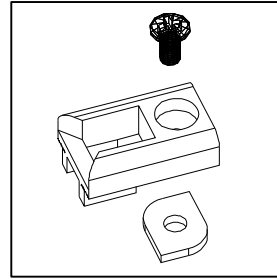

30 95 52 23

Sistema de fecho simples

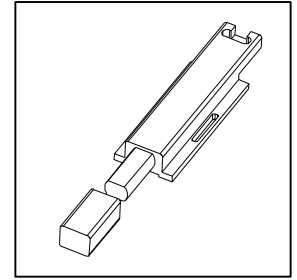

30 95 52 26

Terminal barra nylon

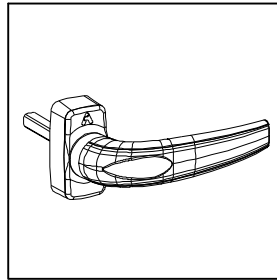

30 95 52 20

Puxador simples (ouro)

30 95 52 21

Puxador simples (preto)

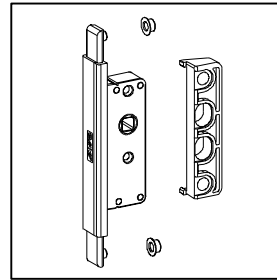

30 95 52 24

Transmissão simples

30 95 52 25

Transmissão dupla

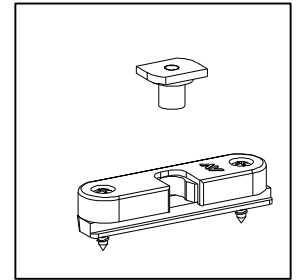

30 95 52 27

Clip com parafusos inox

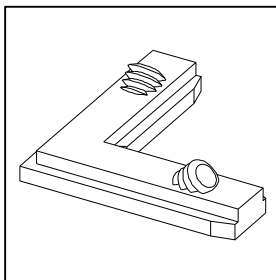

30 96 00 15

Esquadro alinhamento

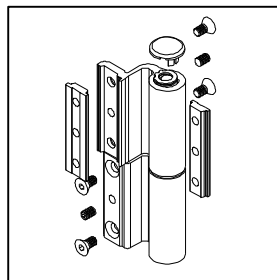

30 23 20 13

Dobradiça porta ab. ext. direita

30 23 20 33

Dobradiça porta ab. ext. esquerda

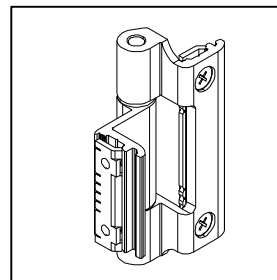

30 23 30 13

Dobradiça janela ab. ext. direita

30 23 30 33

Dobradiça janela ab. ext. esquerda

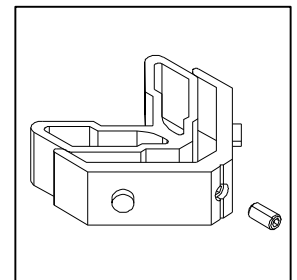

30 24 87 28

Esquadro aro fixo janela ab. ext.

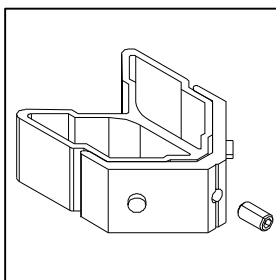

30 24 87 37

Esquadro ext. aro móvel ab. ext.

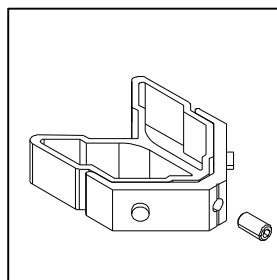

30 24 87 48

Esquadro aro fixo porta ab. ext.

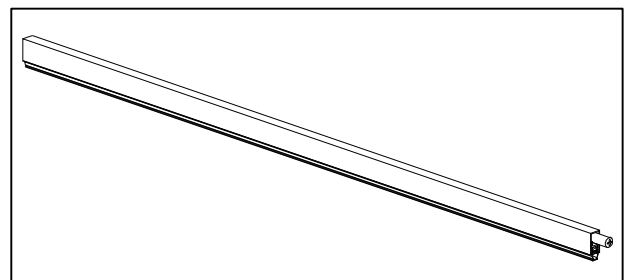

30 24 87 05

Cortaventos 500 mm

30 24 87 07

Cortaventos 700 mm

30 24 87 09

Cortaventos 900 mm

30 24 87 11

Cortaventos 1100 mm

30 24 87 06

Cortaventos 600 mm

30 24 87 08

Cortaventos 800 mm

30 24 87 10

Cortaventos 1000 mm

30 24 87 12

Cortaventos 1200 mm

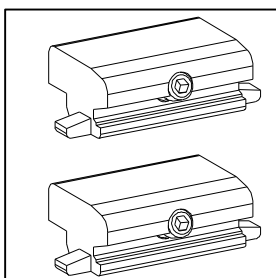

30 25 87 42

Jogo topos activação cortaventos

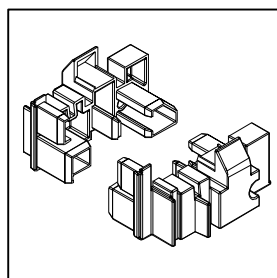

30 25 87 70

Jogo topos remate inferior

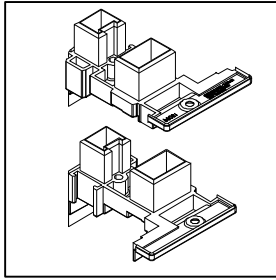

30 24 87 15

Jogo topos inv. ab. ext. carvalho/pinho

30 24 87 25

Jogo topos inv. ab. ext. mogno

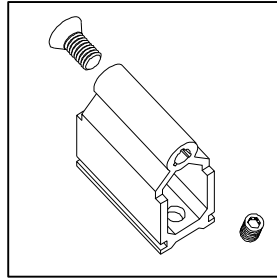

30 24 87 50

Topo travessa porta ab. ext.

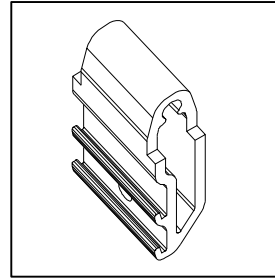

30 24 87 46

Topo travessa ab. ext.

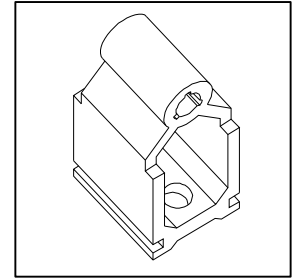

30 24 87 40

Topo travessa janela ab. ext.

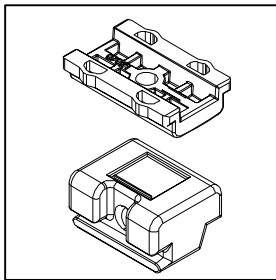

30 24 30 76

Apoio de folha ab. ext.

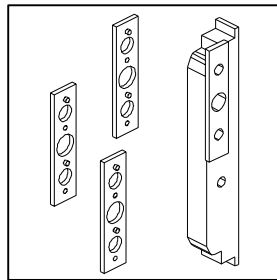

30 90 20 41

Transmissão ab. ext.

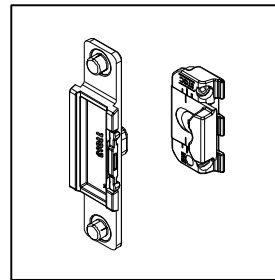

30 25 30 66

Ponto fecho intermédio ab. ext.

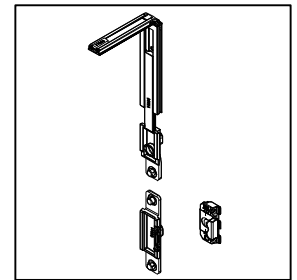

30 25 30 63

Ponto fecho suplementar ab. ext.

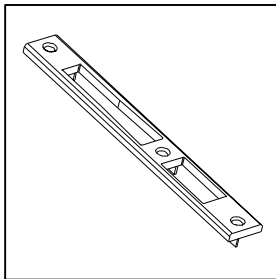

30 92 05 20

Chapa-testa central

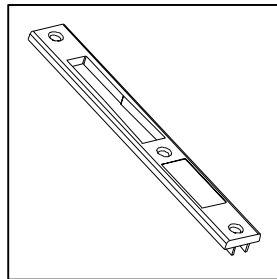

30 92 05 30

Chapa-testa extremos

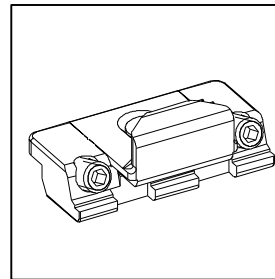

30 24 87 10

Complemento fecho

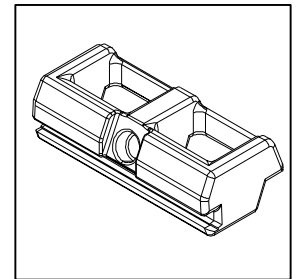

30 24 30 84

Complemento fecho 1 folha ab. ext.

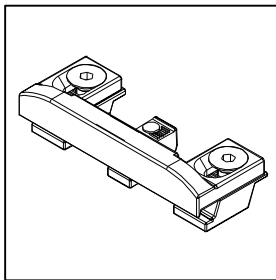

30 24 30 74

Complemento fecho 2 folhas ab. ext.

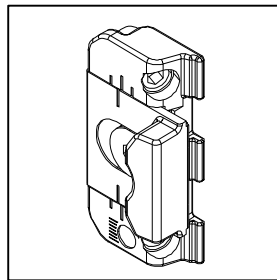

30 25 30 64

Complemento fecho suplementar

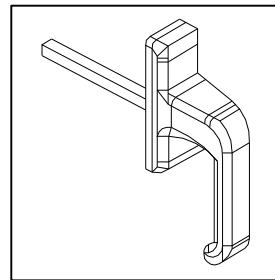

30 95 50 00

Cremone ab. ext.

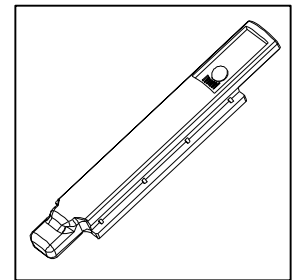

30 24 30 73

Terminal de fecho ab. ext.

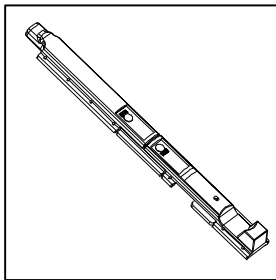

30 24 30 77

Fecho 2ª folha ab. ext.

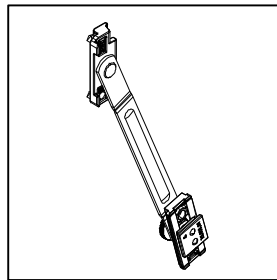

30 92 04 75

Jogo compasso basculante

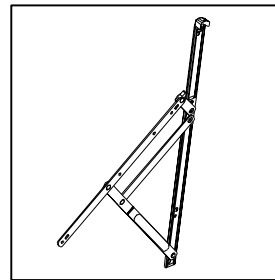

30 92 04 90

Compasso projectante-deslizante

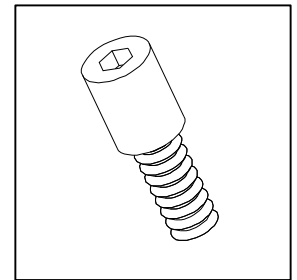

30 25 10 22

Parafuso transmissão ab. ext. 22 mm

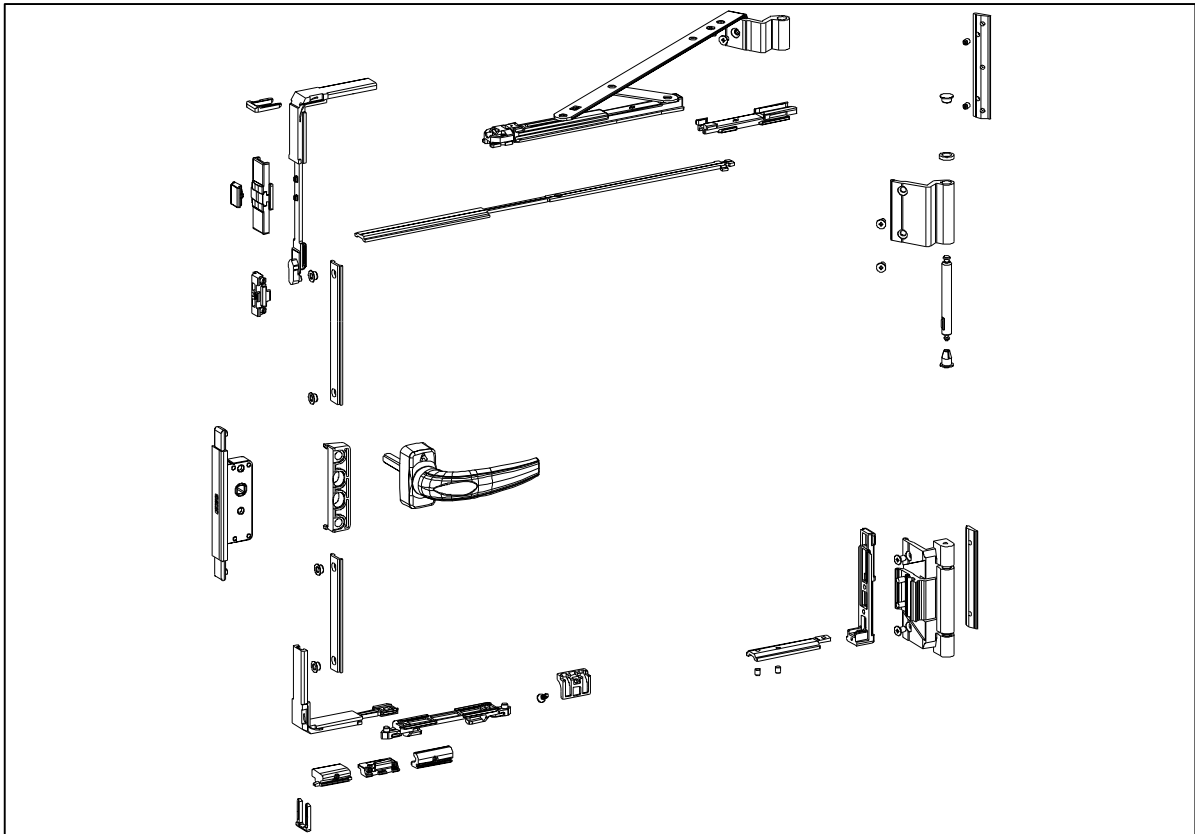

30 95 52 00

Kit oscilo-batente standard 1 folha (ouro)

30 95 52 01

Kit oscilo-batente standard 1 folha (preto)

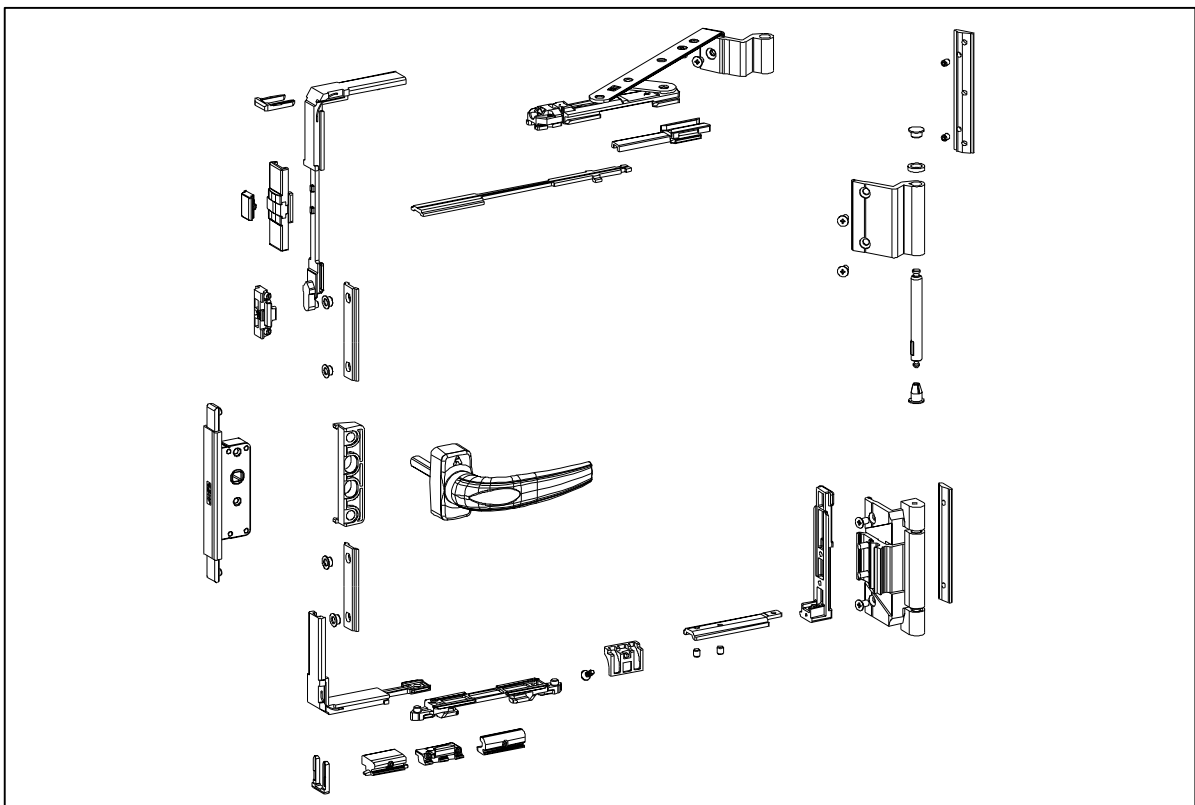

30 95 52 02

Kit oscilo-batente compasso pequeno 1 folha (ouro)

30 95 52 03

Kit oscilo-batente compasso pequeno 1 folha (preto)

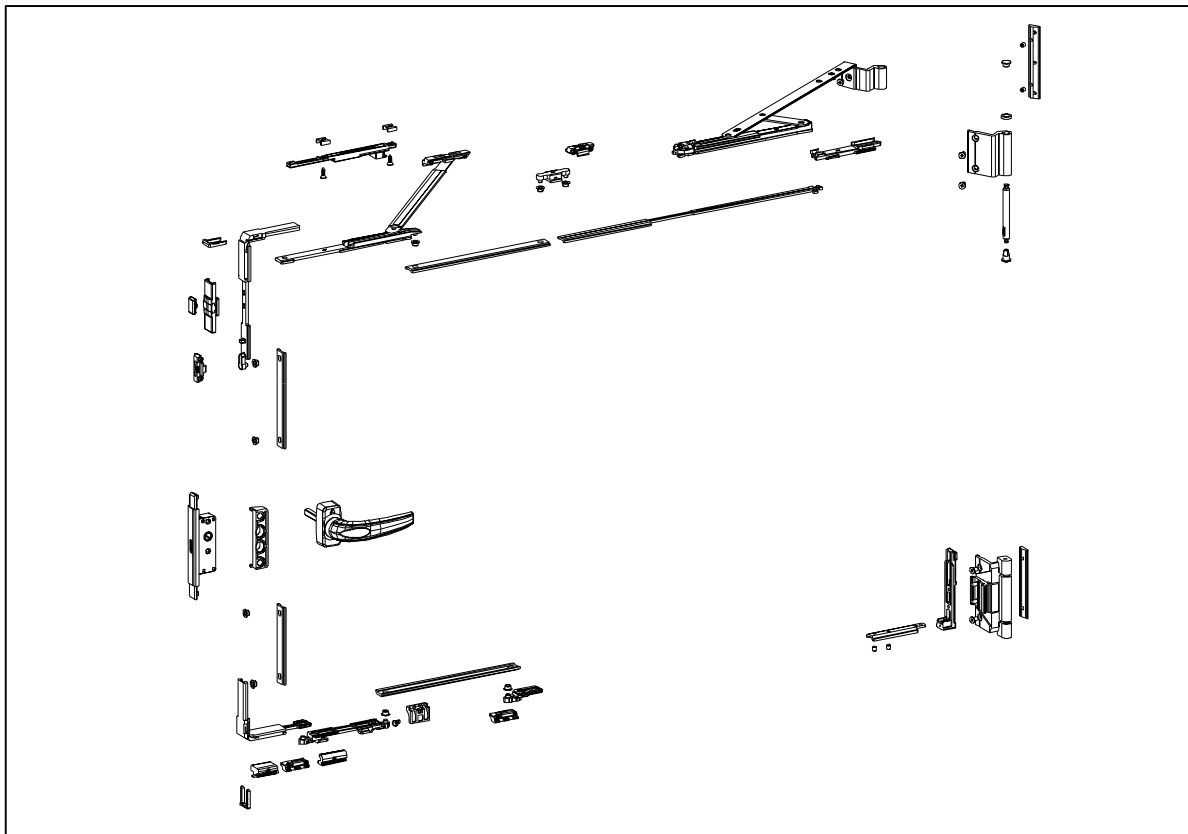

30 95 52 04

Kit oscilo-batente standard + suplemento 1 folha (ouro)

30 95 52 05

Kit oscilo-batente standard + suplemento 1 folha (preto)

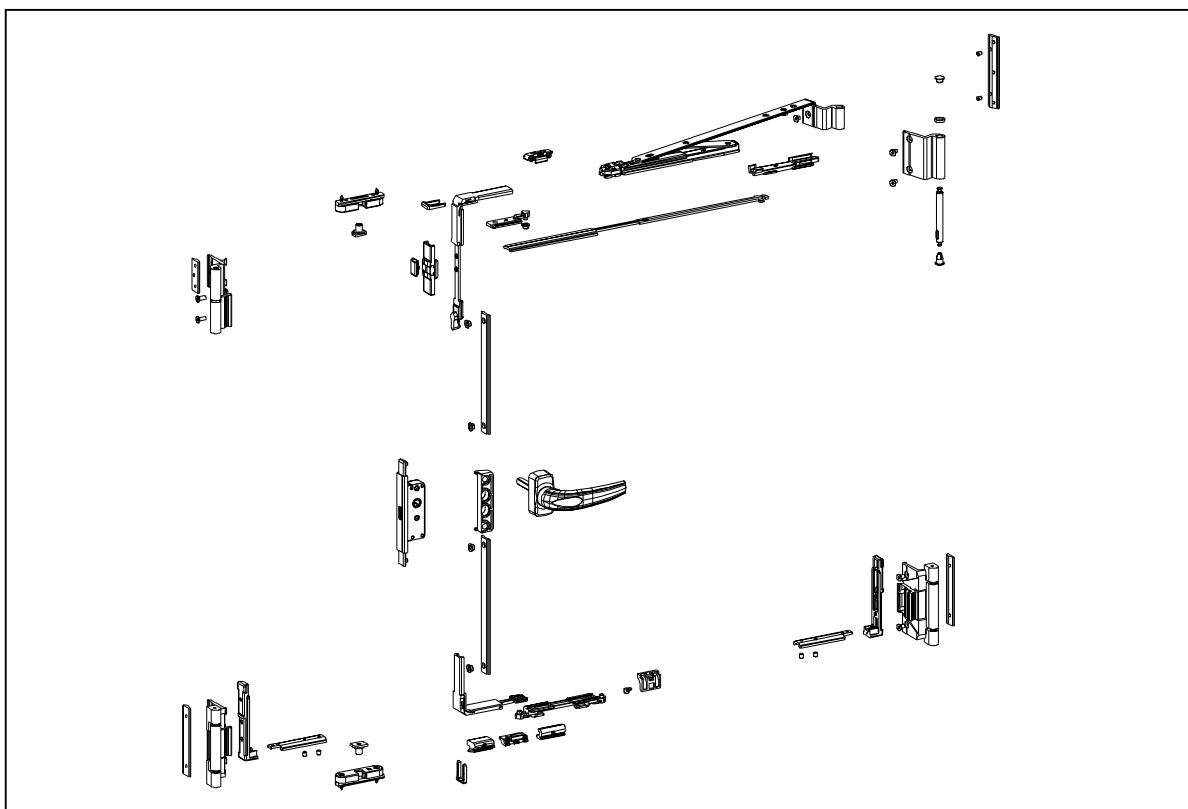

30 95 52 06

Kit oscilo-batente 2 folhas compasso standard (ouro)

30 95 52 07

Kit oscilo-batente 2 folhas compasso standard (preto)

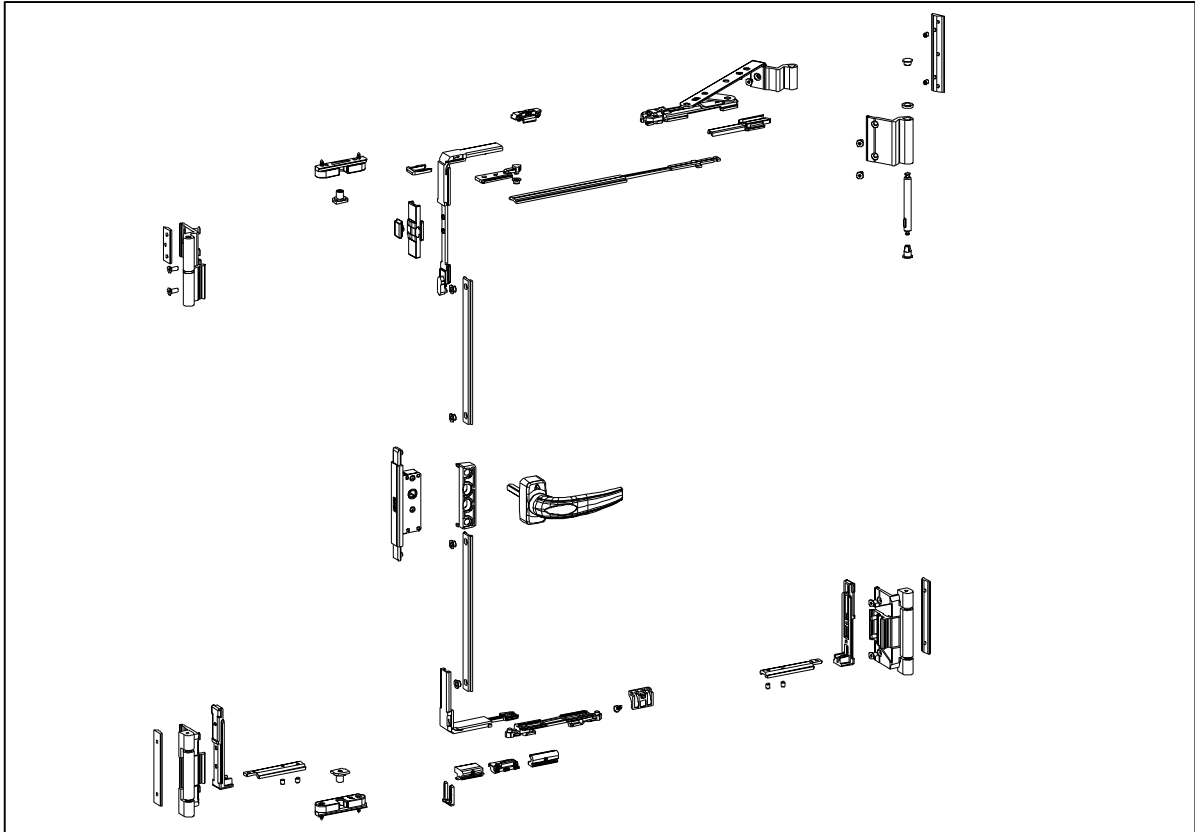

30 95 52 08

Kit oscilo-batente compasso pequeno 2 folhas (ouro)

30 95 52 09

Kit oscilo-batente compasso pequeno 2 folhas (preto)

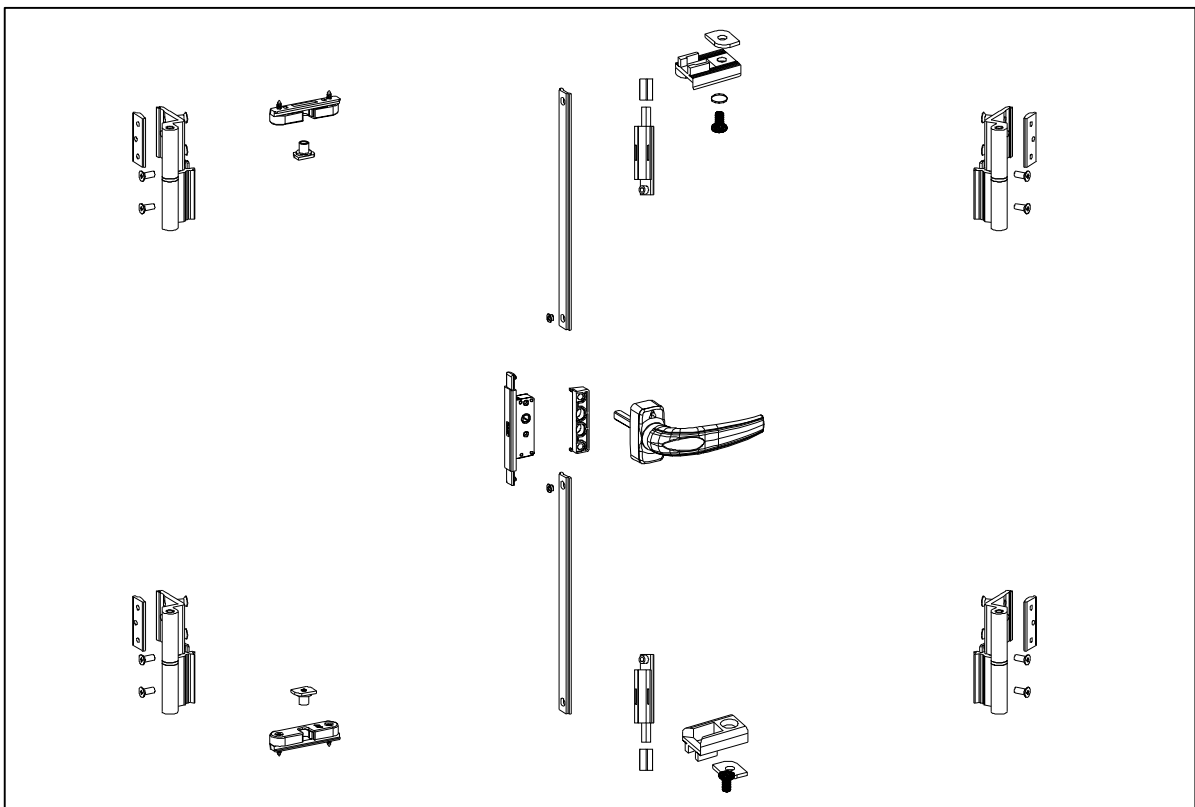









30 95 52 18









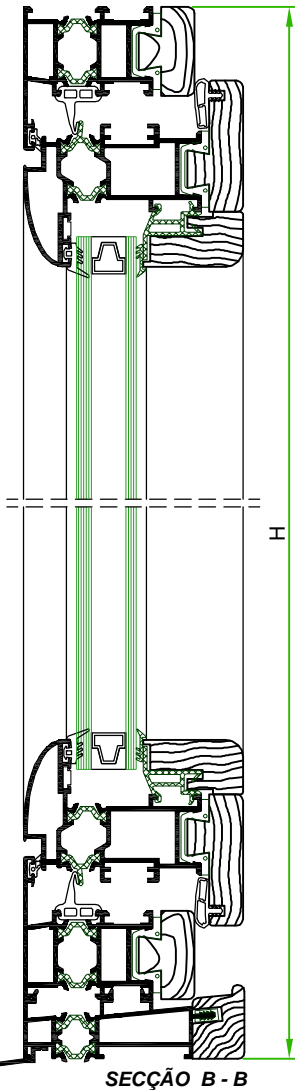
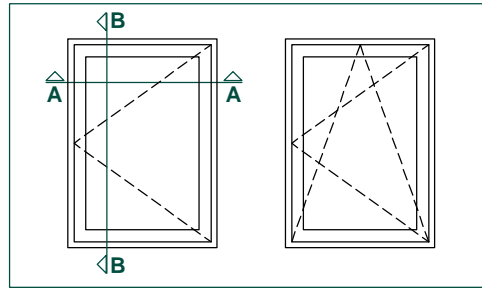



Kit abrir 2 folhas (ouro)

30 95 52 19

Kit abrir 2 folhas (preto)

REFERÊNCIA	DESENHO	DESCRIÇÃO
30 21 87 01		Junta interior
30 93 00 90		Junta exterior
30 21 87 03		Junta central
30 23 87 01		Junta divisor de vidro postigo
30 24 87 01		Junta interior para ab. exterior
30 24 87 02		Junta exterior com fio anti-encolhimento
30 93 00 60		Junta vidro exterior (Opcional)
30 93 01 30		Junta exterior para ab. exterior



JANELA 1 FOLHA DE ABRIR E OSCILO-BATENTE

PERFIS

Des.	Ref.	Descrição	Corte	Quant.	Medida
	AM-3	Aro fixo		2	L H-24
	AM-5	Aro móvel		2	L-61 H-85
	AM-16	Bite		2	L-167 H-191
	AX-19	Barra cremone		2	Aprox. H/2
	AM-14	Condensação		1	L
	AZ-23	Pingadeira		1	L

ACESSÓRIOS

Ref.	Descrição	Quant.	
		Abrir	Osc.Bat.
30 21 87 07	Esquadro aro janela	8	8
30 21 87 08	Esquadro móvel janela	4	4
30 92 01 00	Goteiras	2	2
30 95 50 40	Pastilha de alinhamento madeira	8	8
30 95 52 00	Kit. OB 1F Ouro	---	1
30 95 52 16	Kit abrir 1F Ouro	1	---
30 96 00 15	Esquadro alinhamento	4	4

VEDANTES







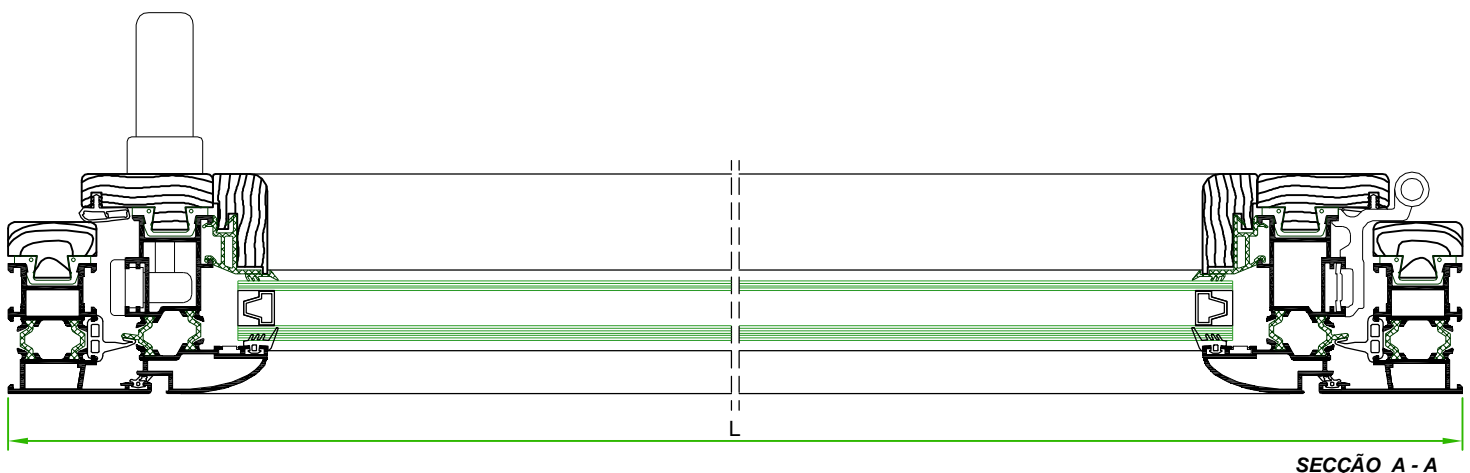

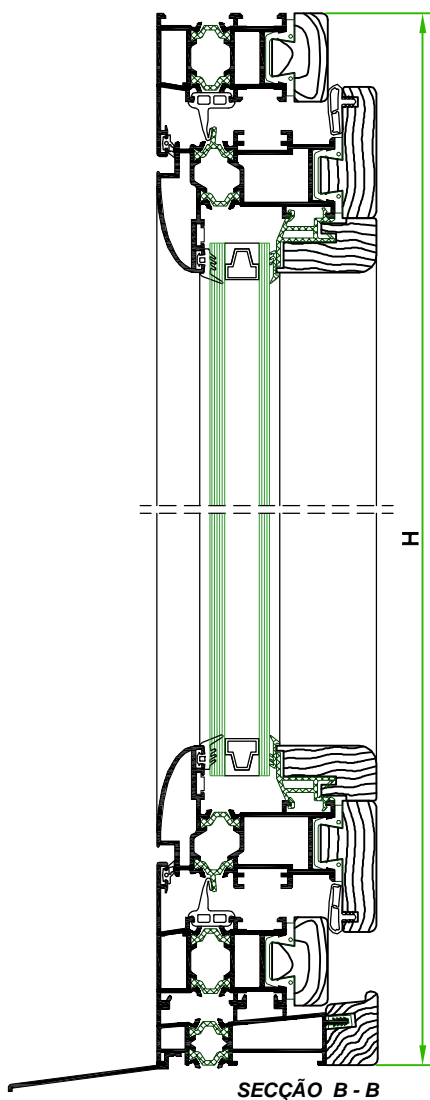
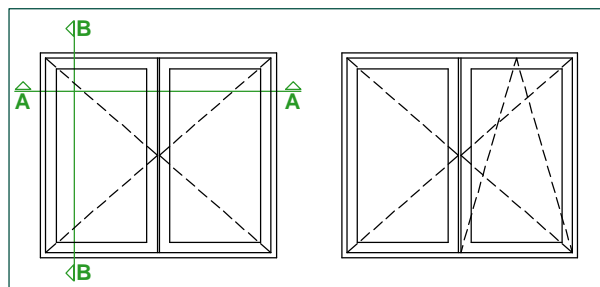





Des.	Ref.	Descrição	Quant.	Medida
	30 21 87 01	Junta interior	2	L H
	30 21 87 02	Junta exterior	2	L H
	30 21 87 03	Junta central	2	L H

VIDRO

L-187	H-211
-------	-------





JANELA 2 FOLHAS DE ABRIR E OSCILO-BATENTE

PERFIS

Des.	Ref.	Descrição	Corte	Quant.	Medida
	AM-3	Aro fixo		2	L H-24
	AM-5	Aro móvel		4	L/2-35 H-85
	AM-4	Inversor		1	H-157
	AM-16	Bite		4	L/2-143 H-191
	AX-19	Barra cremone		2	Aprox. H/2
	AM-14	Condensação		1	L
	AZ-23	Pingadeira		1	L

ACESSÓRIOS

Ref.	Descrição	Quant.	
		Abrir	Osc.Bat.
30 21 87 07	Esquadro aro janela	8	8
30 21 87 08	Esquadro móvel janela	8	8
30 21 87 15	Jogo topos inversor	1	1
30 92 01 00	Goteiras	2	2
30 95 50 40	Pastilha de alinhamento madeira	12	12
30 95 52 06	Kit. OB 2F Ouro	---	1
30 95 52 18	Kit abrir 2F Ouro	1	---
30 96 00 15	Esquadro alinhamento	8	8

VEDANTES

Des.	Ref.	Descrição	Quant.	Medida
	30 21 87 01	Junta interior	4	L/2 H
	30 21 87 02	Junta exterior	2	L H
	30 21 87 03	Junta central	2	L H

VIDRO

L/2-163	H-211
---------	-------

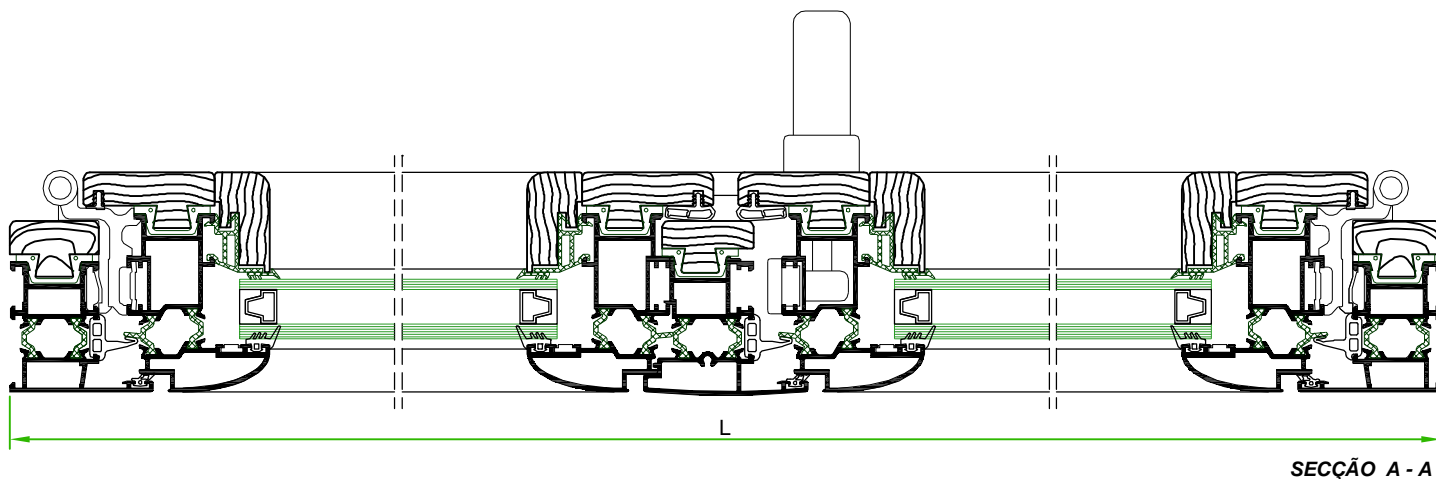
SECÇÃO A - A

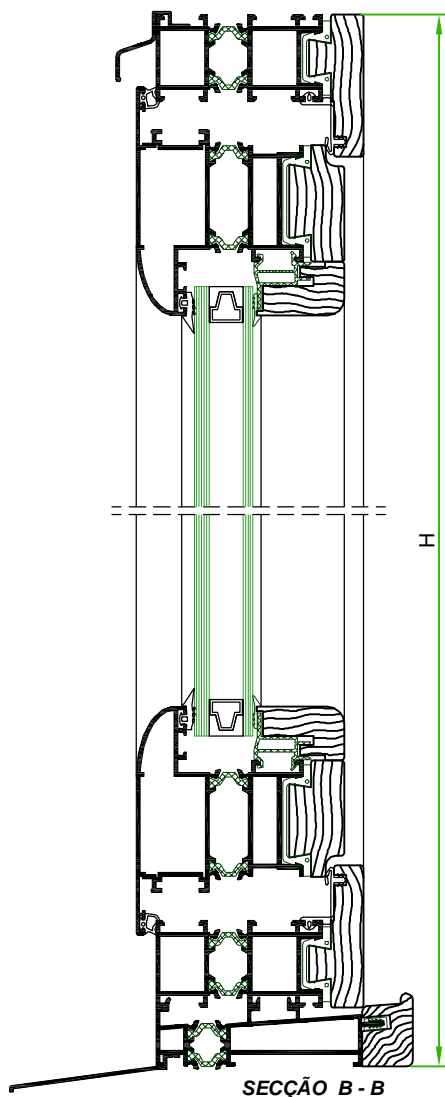
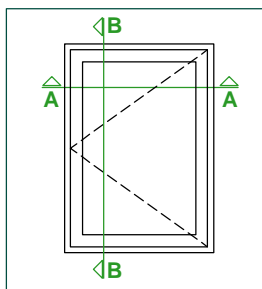
JANELA 1 FOLHA DE ABERTURA EXTERIOR

PERFIS

Des.	Ref.	Descrição	Corte	Quant.	Medida
	AM-22	Aro fixo ab. ext.		2	L H-24
	AM-27	Aro móvel ab. ext.		2	L-59 H-83
	AM-16	Bite		2	L-202 H-226
	AXI-45	Pingadeira sup.		1	L
	AX-19	Barra cremone		2	Aprox. H/2
	AM-33	Condensação ab. ext.		1	L
	AZ-23	Pingadeira		1	L

ACESSÓRIOS

Ref.	Descrição	Quant.
30 21 87 09	Esquadro móvel	4
30 23 23 05	Parafuso transmissão ab. ext.	2
30 23 30 13	Dobradiças dir. ab. ext. janelas	2
30 24 30 73	Terminal de fecho ab. ext.	2
30 24 30 76	Apoio de folha ab. ext.	1
30 24 30 84	Complemento fecho 1F ab. ext.	2
30 24 87 28	Esquadro fixo ab. ext.	8
30 24 87 37	Esquadro ext. móvel ab. ext.	4
30 95 50 00	Cremone ab. ext.	1
30 90 20 41	Transmissão ab. ext.	1
30 95 50 40	Pastilha de alinhamento madeira	8
30 96 00 15	Esquadro alinhamento	4

VEDANTES







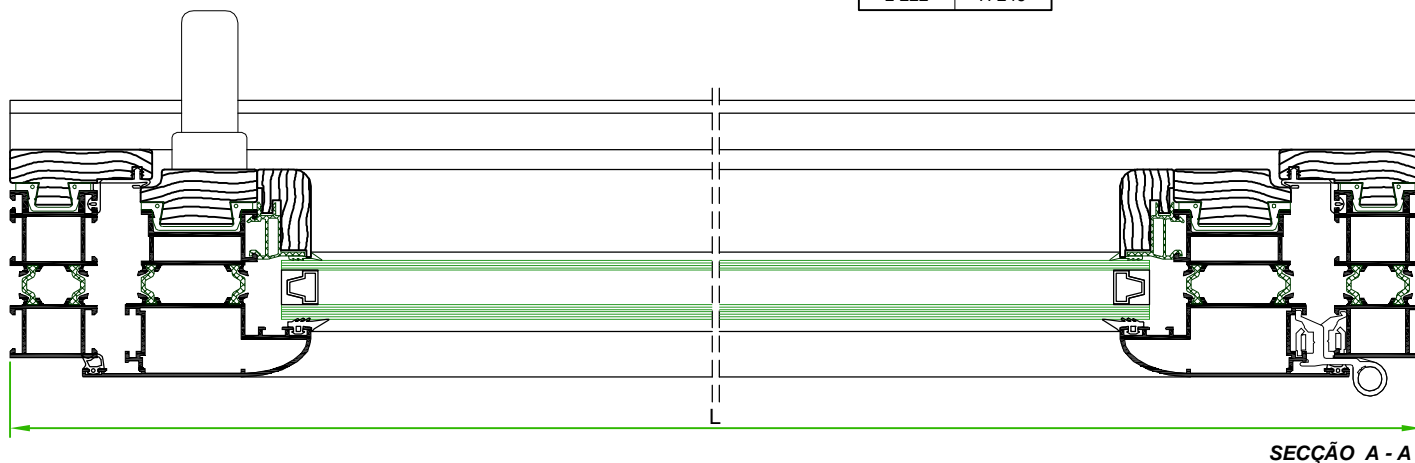

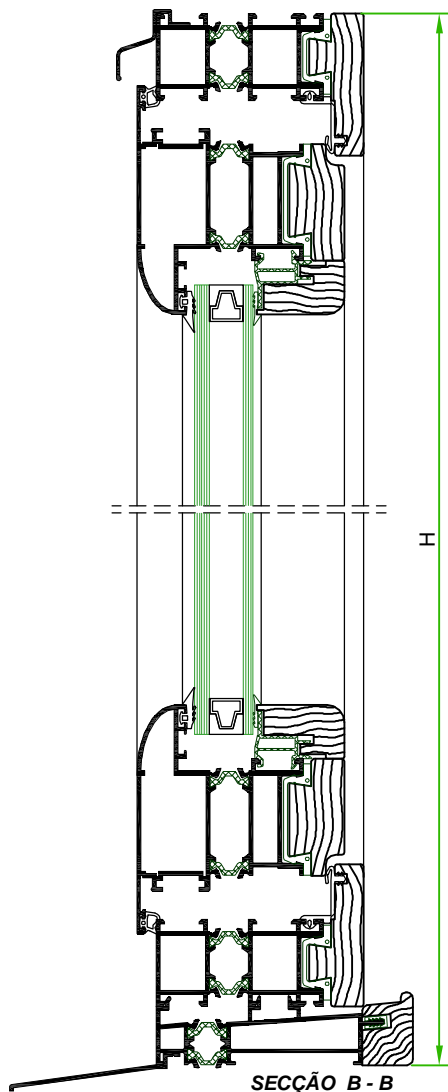
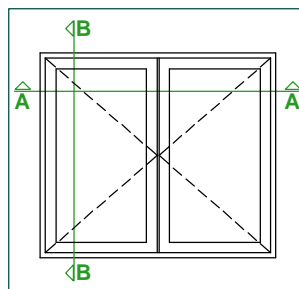







Des.	Ref.	Descrição	Quant.	Medida
	30 24 87 01	Junta interior ab. ext.	2	L H
	30 93 01 30	Junta exterior ab. ext.	2	L H

VIDRO

L-222	H-246
-------	-------





JANELA 2 FOLHAS DE ABERTURA EXTERIOR

PERFIS

Des.	Ref.	Descrição	Corte	Quant.	Medida
	AM-22	Aro fixo ab. ext.		2 2	L H-24
	AM-25	Inversor		1	H-154
	AM-27	Aro móvel ab. ext.		4 4	L/2-33 H-83
	AM-16	Bite		4 4	L/2-176 H-226
	AXI-45	Pingadeira sup.		1	L
	AX-19	Barra cremone		2	Aprox. H/2
	AM-33	Condensação ab. ext.		1	L
	AZ-23	Pingadeira		1	L

ACESSÓRIOS

Ref.	Descrição	Quant.
30 21 87 09	Esquadro móvel	8
30 23 23 05	Parafuso transmissão ab. ext.	2
30 23 30 13	Dobradiças dir. ab. ext. janelas	2
30 23 30 33	Dobradiças esq. ab. ext. janelas	2
30 24 30 73	Terminal de fecho ab. ext.	2
30 24 30 74	Complemento fecho 2F ab. ext.	2
30 24 30 76	Apoio de folha ab. ext.	2
30 24 30 77	Fecho 2ª folha ab. ext.	2
30 24 87 15	Jogo topos inversor ab. ext.	1
30 24 87 28	Esquadro fixo ab. ext.	8
30 24 87 37	Esquadro ext. móvel ab. ext.	8
30 95 50 00	Cremone ab. ext.	1
30 90 20 41	Transmissão ab. ext.	1
30 95 50 40	Pastilha de alinhamento madeira	12
30 96 00 15	Esquadro alinhamento	8

VEDANTES







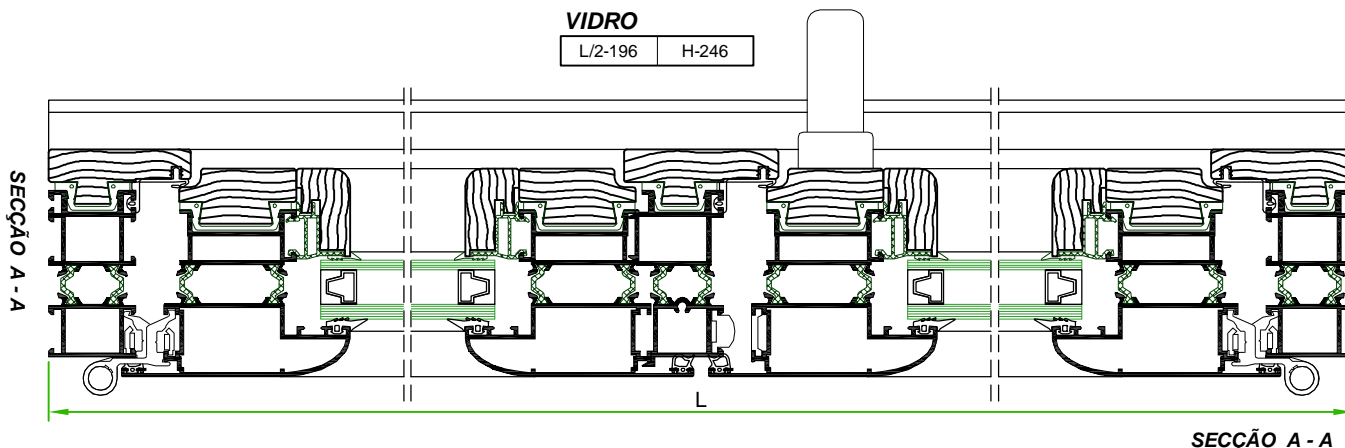

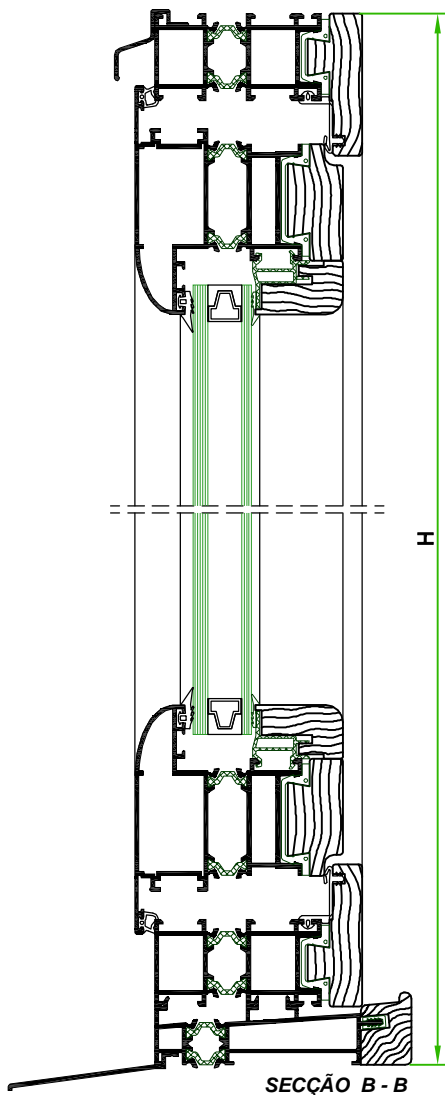
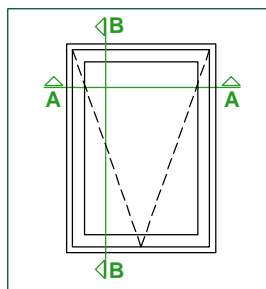









Des.	Ref.	Descrição	Quant.	Medida
	30 24 87 01	Junta interior ab. ext.	2 3	L H
	30 93 01 30	Junta exterior ab. ext.	4 4	L/2 H

VIDRO

L/2-196	H-246
---------	-------

SECÇÃO A - A



JANELA 1 FOLHA PROJECTANTE

PERFIS

Des.	Ref.	Descrição	Corte	Quant.	Medida
	AM-22	Aro fixo ab. ext.		2 2	L H-24
	AM-31	Aro móvel ab. ext. projectante		2 2	L-59 H-83
	AM-16	Bite		2 2	L-203 H-227
	AXI-45	Pingadeira sup.		1	L
	AX-19	Barra cremone		2	Aprox. H/2
	AM-33	Condensação ab. ext.		1	L
	AZ-23	Pingadeira		1	L
	AXI-31	Guia de abertura projectante		1	L-107
	AXI-32	Complemento ab. projectante		2	565

ACESSÓRIOS

Ref.	Descrição	Quant.
30 21 87 09	Esquadro móvel	4
30 23 23 05	Parafuso transmissão ab. ext.	2
30 24 30 73	Terminal de fecho ab. ext.	2
30 24 30 84	Complemento fecho 1F ab. ext.	2
30 24 87 28	Esquadro fixo ab. ext.	8
30 24 87 37	Esquadro ext. móvel ab. ext.	4
30 95 50 00	Cremone ab. ext.	1
30 90 20 41	Transmissão ab. ext.	1
30 90 04 90	Jogo compassos proj.	1
30 95 50 40	Pastilha de alinhamento madeira	8
30 96 00 15	Esquadro alinhamento	4

VEDANTES







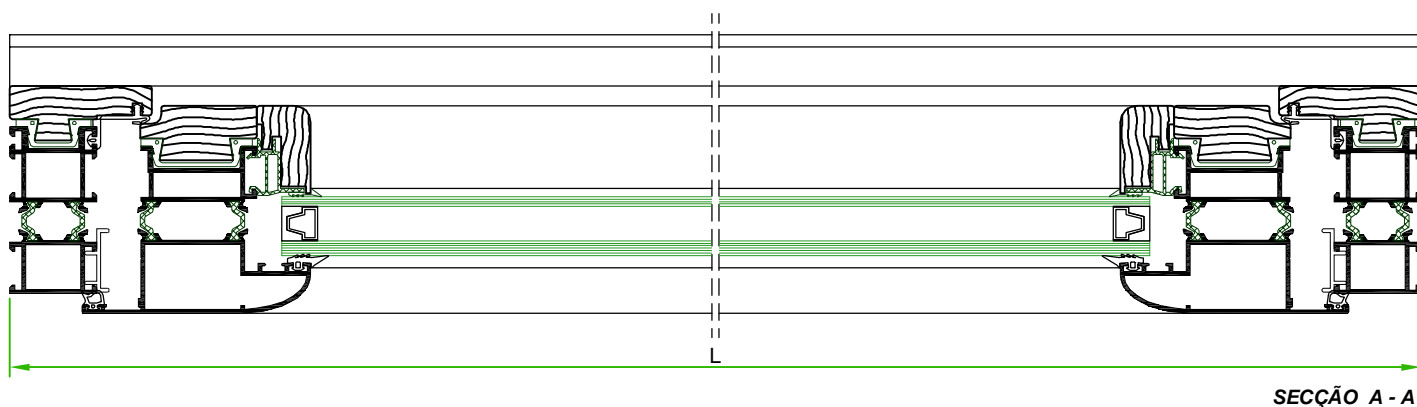

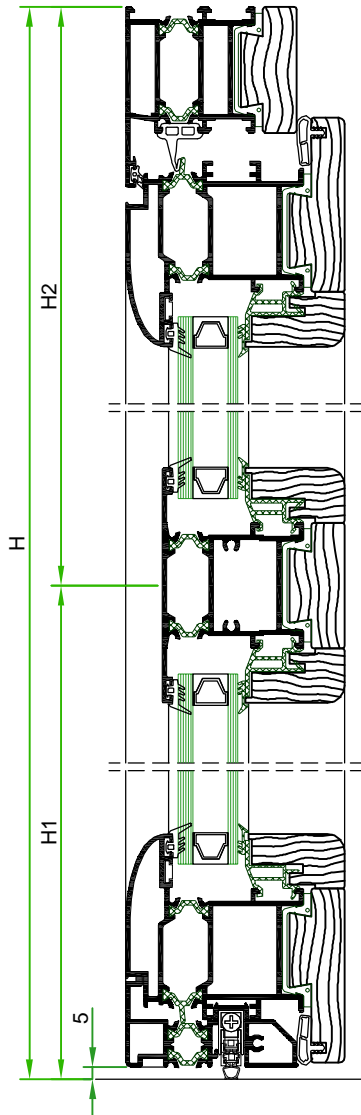
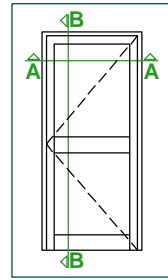

Des.	Ref.	Descrição	Quant.	Medida
	30 24 87 01	Junta interior ab. ext.	2 2	L H
	30 93 01 30	Junta exterior ab. ext.	2 2	L H

VIDRO

L-56	H-62
------	------

SECÇÃO A - A

PORTA 1 FOLHA DE ABERTURA INTERIOR

PERFIS



Des.	Ref.	Descrição	Corte	Quant.	Medida
	AM-8	Aro fixo		1	L
	AM-10	Aro móvel		2	L-91
	AM-11	Travessa		1	L-222
	AM-16	Bite		4 2 2	L-230 H2-141 H1-103
	AM-36	Remate inf.		1	L

ACESSÓRIOS

Ref.	Descrição	Quant.
30 21 87 09	Esquadro aro fixo porta	4
30 21 87 10	Esquadro móvel porta	4
30 21 87 11	Canhão fechadura	1
*	Corta ventos inf.	1
30 25 87 70	Jogo topos remate inf.	1
30 92 05 10	Fechadura 3 pontos	1
30 95 50 40	Pastilha de alinhamento madeira	4
30 95 50 91	Jogo puxadores ouro	1
30 95 52 12	Dobradiças ouro	4
30 96 00 15	Esquadro alinhamento	4

* Segundo a dimensão da folha

VEDANTES







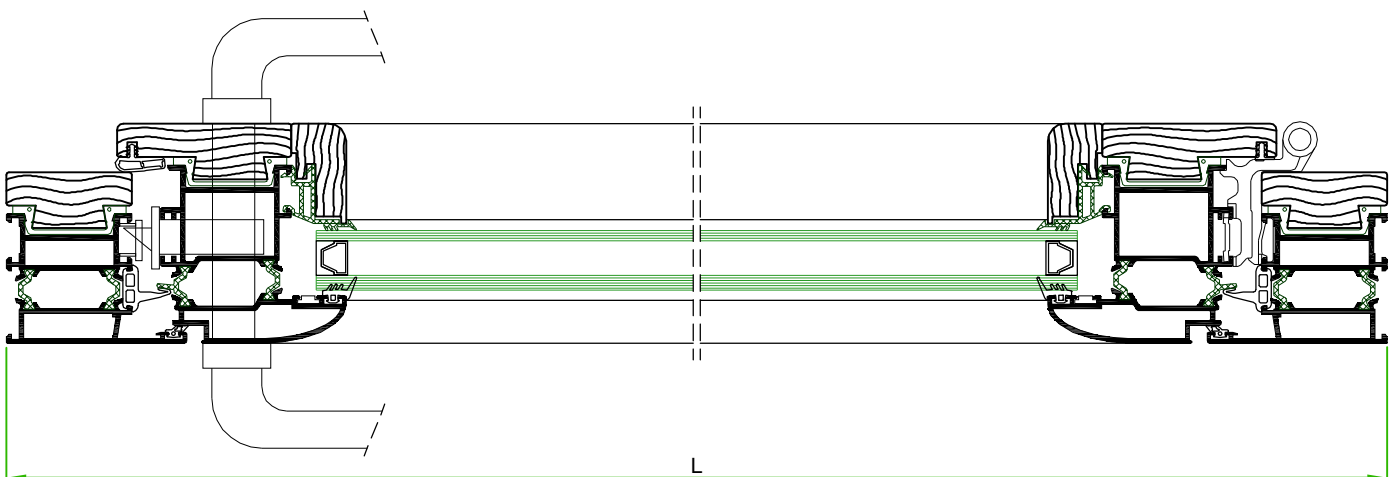

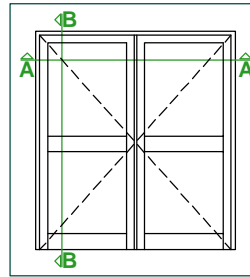
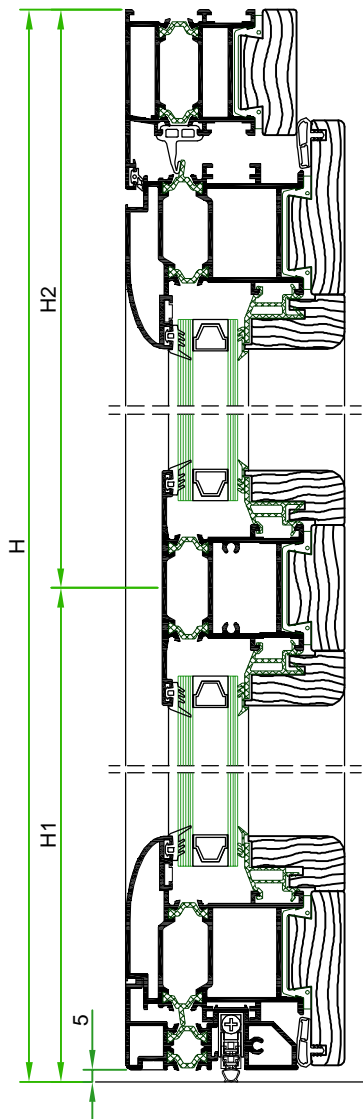











Des.	Ref.	Descrição	Quant.	Medida
	30 21 87 01	Junta interior	1 2	L H
	30 21 87 02	Junta exterior	1 2	L H
	30 21 87 03	Junta central	1 2	L H

VIDRO

L-252	H2-161
L-252	H1-123



PORTA 2 FOLHAS DE ABERTURA INTERIOR

PERFIS







Des.	Ref.	Descrição	Corte	Quant.	Medida
	AM-8	Aro fixo		1	L
	AM-10	Aro móvel		2	H
	AM-10	Aro móvel		4	L/2-52
	AM-10	Aro móvel		4	H-51
	AM-11	Travessa		2	L/2-182
	AM-4	Inversor		1	H-87
	AM-16	Bite		8	L/2-190
	AM-16	Bite		4	H2-141
	AM-16	Bite		4	H1-103
	AM-36	Remate inf.		2	L/2

ACESSÓRIOS

Ref.	Descrição	Quant.
30 21 87 04	Jogo de fechos 2ª folha	1
30 21 87 09	Esquadro aro fixo porta	4
30 21 87 10	Esquadro móvel porta	8
30 21 87 11	Canhão fechadura	1
30 21 87 15	Jogo de topos inversor	1
*	Corta ventos inf.	2
30 25 87 70	Jogo topos remate inf.	2
30 92 05 10	Fechadura 3 pontos	1
30 95 50 40	Pastilha de alinhamento madeira	10
30 95 50 91	Jogo puxadores ouro	1
30 95 52 12	Dobradiças ouro	8
30 96 00 15	Esquadro alinhamento	8

* Segundo a dimensão da folha

VEDANTES







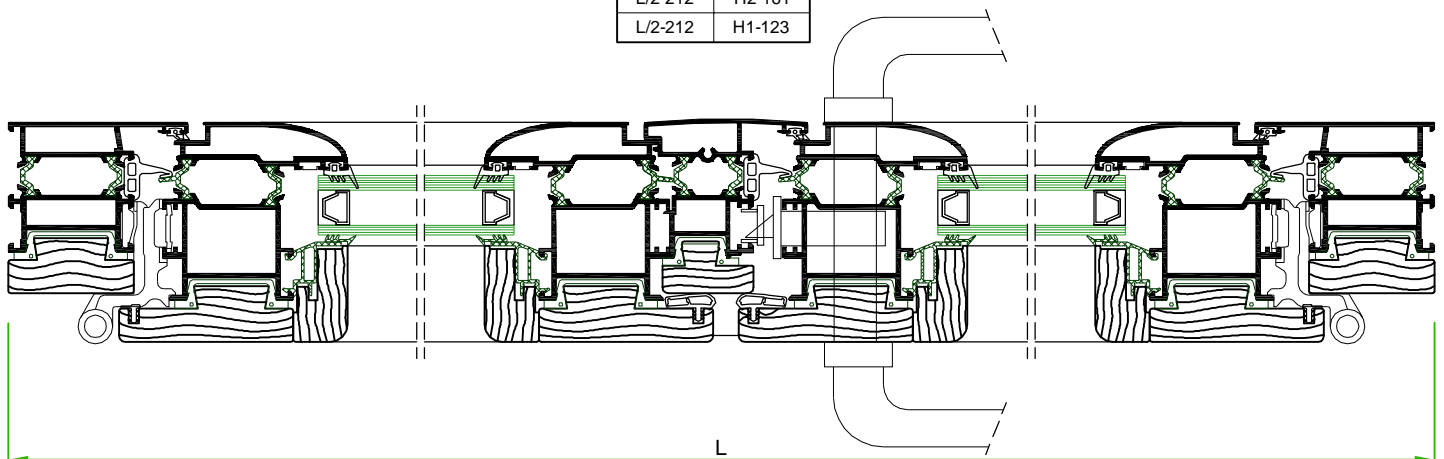

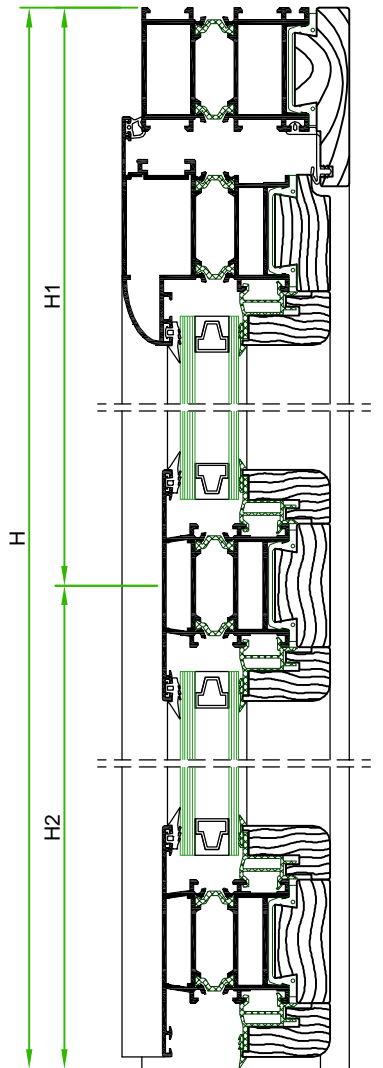
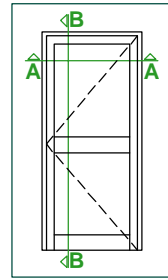
Des.	Ref.	Descrição	Quant.	Medida
	30 21 87 01	Junta interior	1	L
	30 21 87 01	Junta interior	4	H
	30 21 87 02	Junta exterior	1	L
	30 21 87 02	Junta exterior	3	H
	30 21 87 03	Junta central	1	L
	30 21 87 03	Junta central	3	H

VIDRO

L/2-212	H2-161
L/2-212	H1-123





PORTA 1 FOLHA DE ABERTURA EXTERIOR

PERFIS

Des.	Ref.	Descrição	Corte	Quant.	Medida
	AM-29	Aro fixo ab. ext.		1 2	L H
	AM-27	Aro móvel ab. ext.		1 2	L-89 H-50
	AM-16	Bite		4 2 2 1	L-232 H1-103 H2-141 L-232
	AM-6	Travessa		2	L-222

ACESSÓRIOS

Ref.	Descrição	Quant.
30 21 87 09	Esquadro aro fixo	2
30 21 87 11	Canhão fechadura	1
30 21 87 12	União topos porta int.	4
30 21 87 13	União topos porta ext.	4
30 23 20 13	Dobradiças dir. ab. ext. porta	3
30 24 87 37	Esquadro ext. móvel ab. ext.	2
30 24 87 48	Esquadro fixo porta ab. ext.	4
30 92 05 10	Fechadura 3 pontos	1
30 95 50 40	Pastilha de alinhamento madeira	4
30 95 50 91	Jogo puxadores ouro	1
30 96 00 15	Esquadro alinhamento	2

VEDANTES







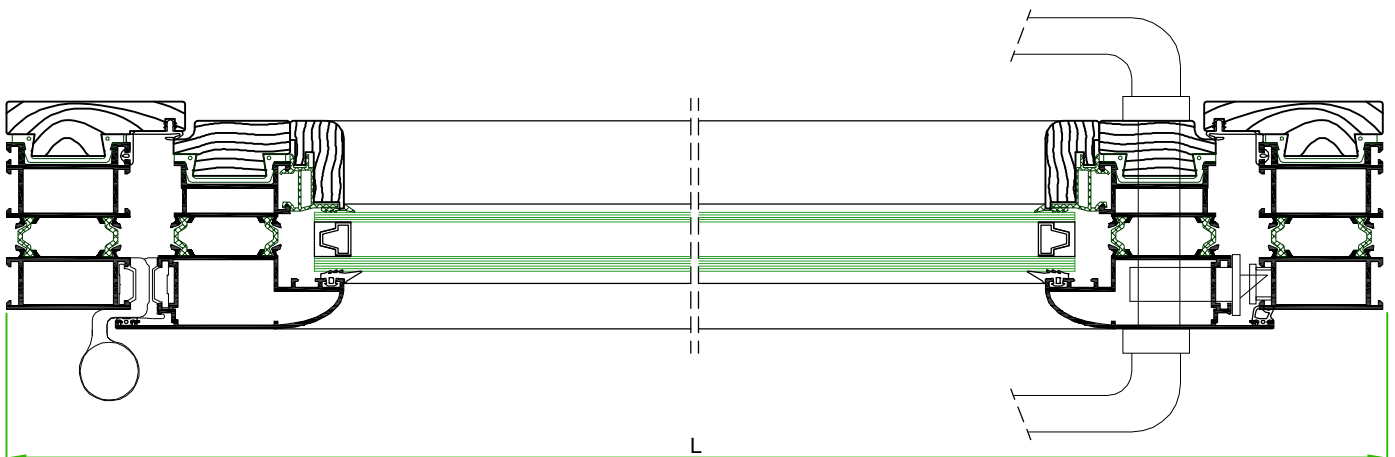

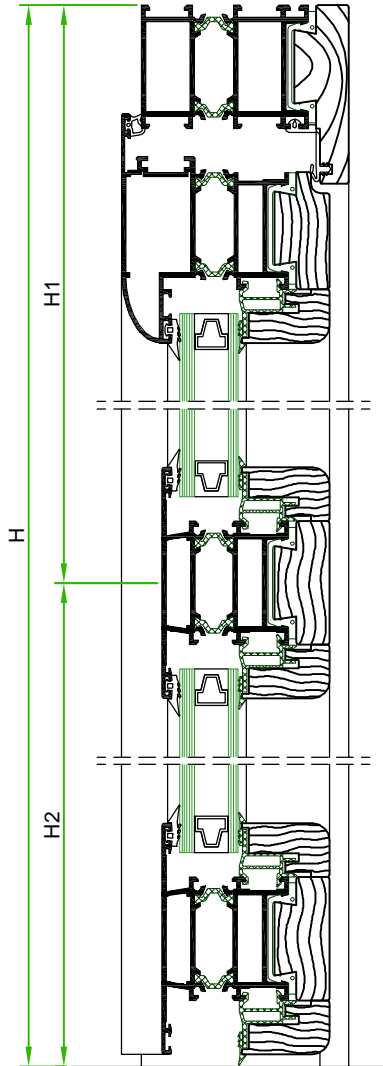
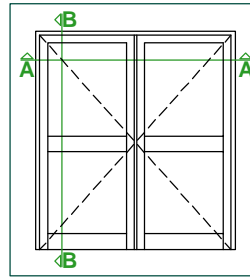



Des.	Ref.	Descrição	Quant.	Medida
	30 24 87 01	Junta interior ab. ext.	1 2	L H
	30 93 01 30	Junta exterior ab. ext.	1 2	L H

VIDRO

L-126	H1-81
L-126	H2-62





PORTA 2 FOLHAS DE ABERTURA EXTERIOR

PERFIS

Des.	Ref.	Descrição	Corte	Quant.	Medida
	AM-29	Aro fixo ab. ext.		1	L
	AM-27	Aro móvel ab. ext.		2	L/2-48
	AM-25	Inversor ab. ext.		4	H-50
	AM-25	Inversor ab. ext.		1	H-80
	AM-16	Bite		8	L/2-191
				4	H1-103
				4	H2-141
				2	L/2-191
	AM-6	Travessa		4	L/2-181

ACESSÓRIOS

Ref.	Descrição	Quant.
30 21 87 09	Esquadro aro fixo	2
30 21 87 11	Canhão fechadura	1
30 21 87 12	União topos porta int.	4
30 21 87 13	União topos porta ext.	4
30 23 20 13	Dobradiças dir. ab. ext. porta	3
30 23 20 33	Dobradiças esq. ab. ext. porta	3
30 24 87 15	Jogo topos inversor ab. ext.	1
30 24 87 37	Esquadro ext. móvel ab. ext.	4
30 24 87 48	Esquadro aro fixo porta ab. ext.	4
30 92 05 10	Fechadura 3 pontos	1
30 95 50 40	Pastilha de alinhamento madeira	4
30 95 50 91	Jogo puxadores ouro	1
30 96 00 15	Esquadro alinhamento	2

VEDANTES







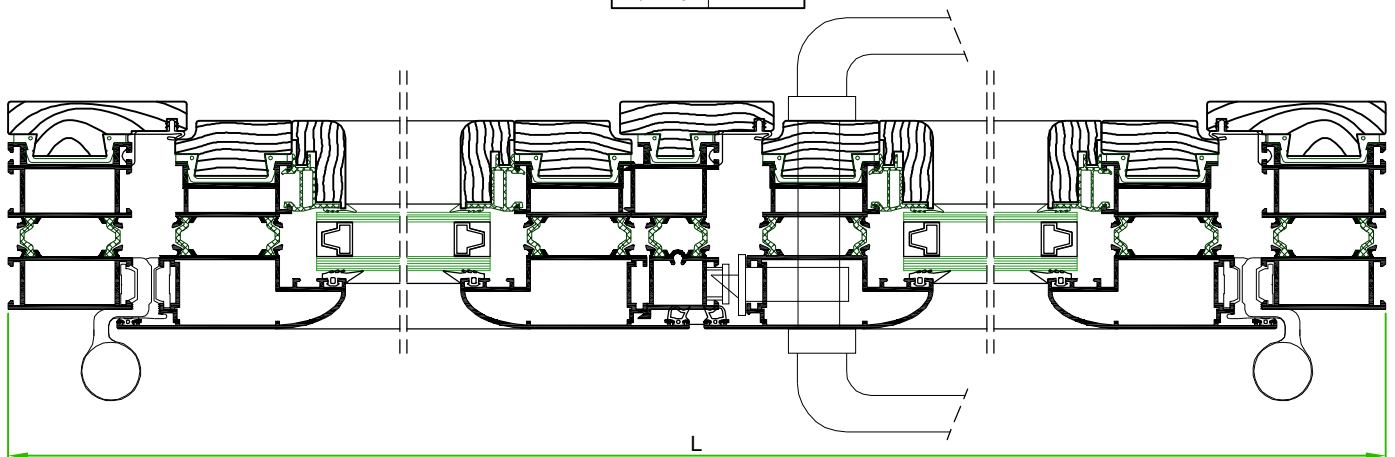

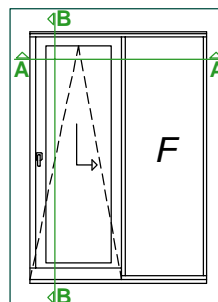
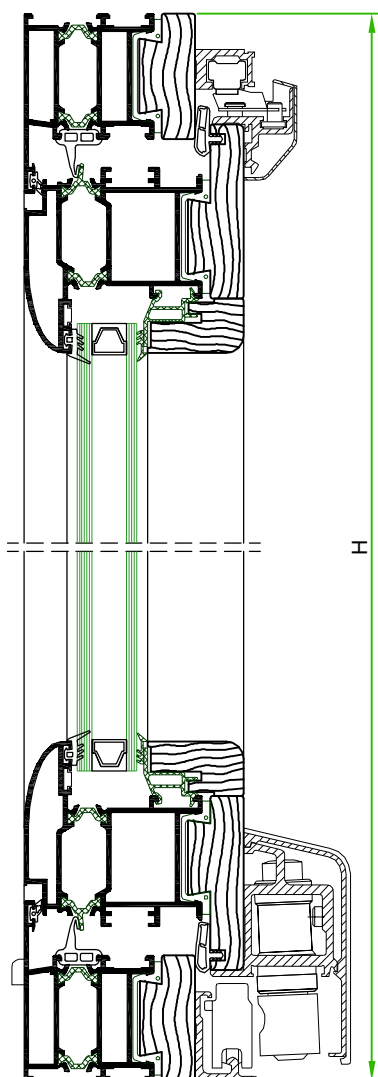

Des.	Ref.	Descrição	Quant.	Medida
	30 24 87 01	Junta interior ab. ext.	1	L
			3	H
	30 93 01 30	Junta exterior ab. ext.	2	L/2
			4	H

VIDRO

L/2-210	H1-162
L/2-210	H2-123





PORTA OSCILO-PARALELA COM FIXO LATERAL

PERFIS

Des.	Ref.	Descrição	Corte	Quant.	Medida
	AM-8	Aro fixo		2	L
	AM-10	Aro móvel		2	L1-66
	AM-6	Travessa		1	H-94
	AM-16	Bite		2	L/1-206
				2	H-232
					(L-L1)-76
					H-102
	AX-19	Barra cremone		2	Aprox. H/2

ACESSÓRIOS

Ref.	Descrição	Quant.
30 21 87 09	Esquadro aro fixo	8
30 21 87 10	Esquadro móvel porta	4
30 21 87 12	União topos porta int.	2
30 21 87 13	União topos porta ext.	2
30 92 01 00	Goteiras	4
30 95 50 40	Pastilha de alinhamento madeira	8
30 95 52 20	Puxador simples ouro	1
30 95 52 24	Transmissão simples	1
30 96 00 15	Esquadro alinhamento	4
---	Kit oscilo - paralela	1

VEDANTES

Des.	Ref.	Descrição	Quant.	Medida
	30 21 87 01	Junta interior	2	L1
			2	H
	30 21 87 02	Junta exterior	2	L1
			2	H
	30 21 87 03	Junta central	2	L1
			2	H







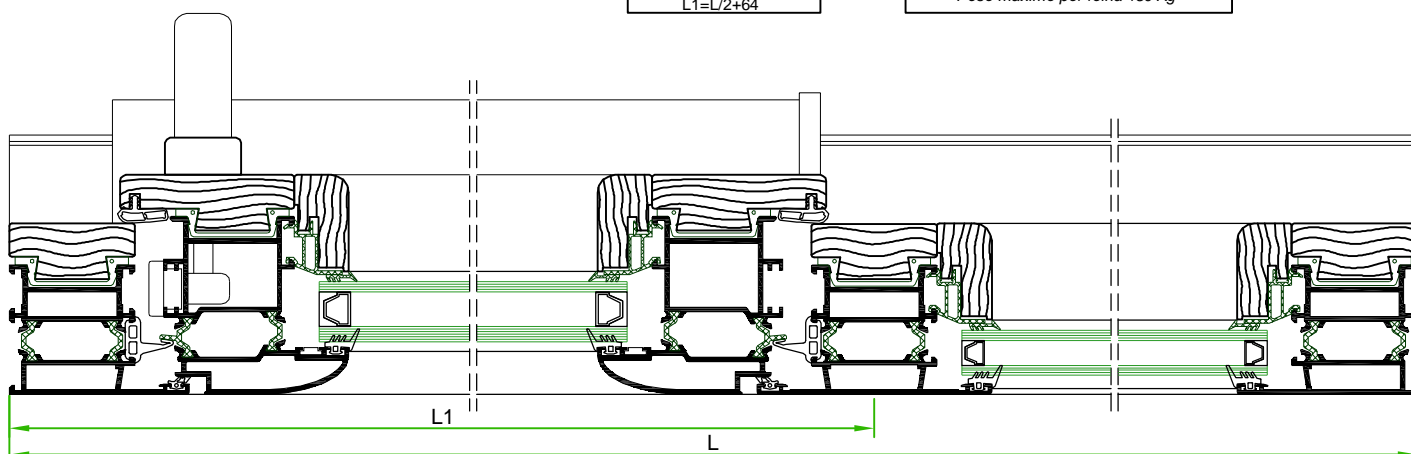

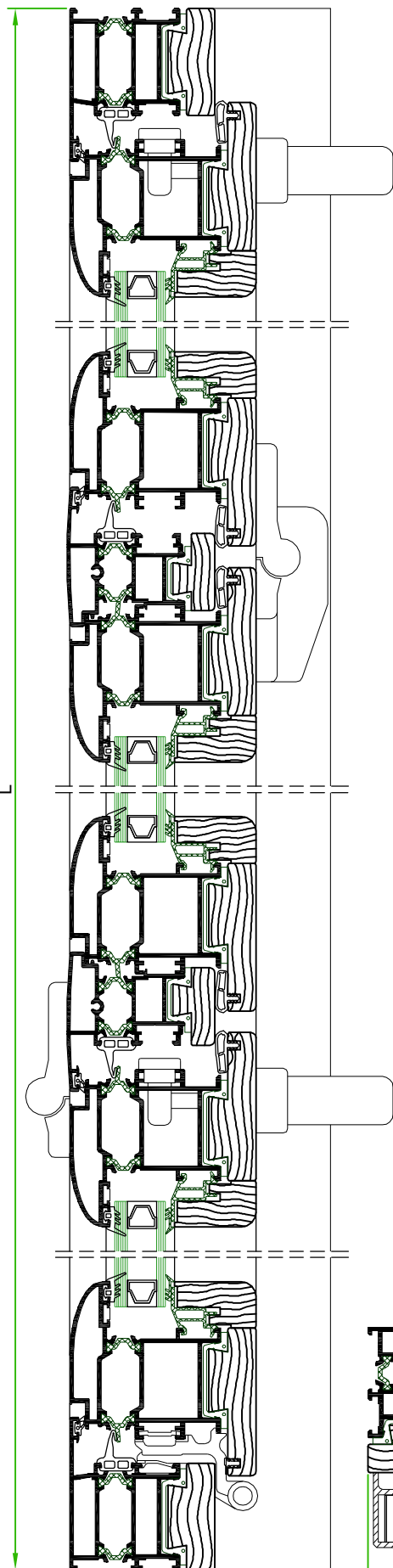
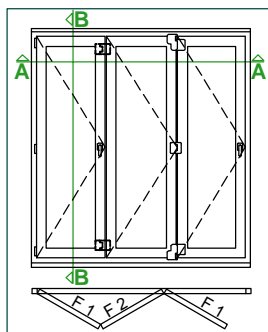



VIDRO

L1-226	H-252
(L-L1)-96	H-121
Para vidros iguais L1=L/2+64	

	Mínimo	Máximo
Largura da folha	700 mm	1650 mm
Altura da folha	850 mm	2400 mm
Peso máximo por folha 150 Kg		





PORTA 3 FOLHAS HARMÔNIO

SECÇÃO A - A

PERFIS

Des.	Ref.	Descrição	Corte	Quant.	Medida
	AM-8	Aro fixo		2	L
				2	H-51
	AM-10	Aro móvel		4	L/3-14
				2	L/3-88
				6	H-142
	AM-04	Inversor		2	H-214
	AM-16	Bite		4	L/3-154
				2	L/3-228
				6	H-280
	AX-19	Barra cremone		4	Aprox. H/2
	AM-13	Suplemento harmonio		1	L

ACESSÓRIOS

Ref.	Descrição	Quant.
30 21 87 09	Esquadro aro fixo	8
30 21 87 10	Esquadro móvel porta	12
30 21 87 15	Jogo topos inversor	2
30 92 01 00	Goteiras	4
30 95 50 40	Pastilha de alinhamento madeira	16
30 95 52 25	Transmissão dupla	2
30 95 52 12	Dobradiças ouro	3
30 95 52 20	Puxador simples ouro	2
30 96 00 15	Esquadro alinhamento	12
---	Kit harmônio	1

VEDANTES

Des.	Ref.	Descrição	Quant.	Medida
	30 21 87 01	Junta interior	6	L/3
			6	H
	30 21 87 02	Junta exterior	2	L
			4	H
	30 21 87 03	Junta central	2	L
			4	H

VIDRO

L/3-174	H-300
L/3-248	H-300

	Mínimo	Máximo
Largura da folha	600 mm	900 mm
Altura da folha	850 mm	2400 mm

Peso máximo por folha 80 Kg

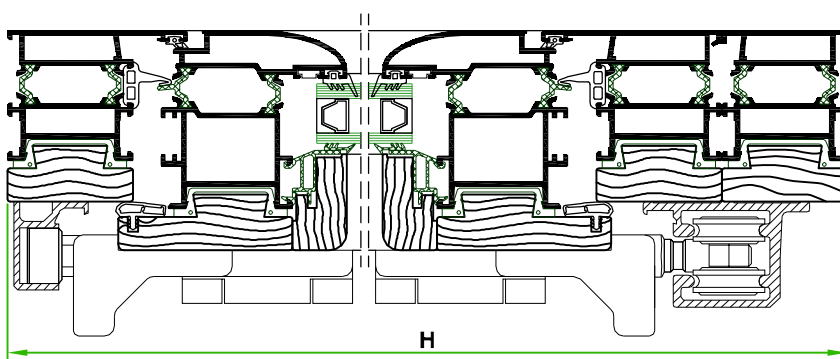
SECÇÃO B - B