

www.anicolor.pt

LÂMINAS
QUEBRA-SOL

PROTECCIÓN
SOLAR

Solariu's

 **anicolor**
Sistemas de Aluminio

LÂMINAS QUEBRA SOL

CARACTERÍSTICAS

Sistemas de alumínio preparados para montagem sobre fachadas que visam fazer o efeito quebra sol apresentando ao mesmo tempo uma forma estética.

Permitem a montagem nas seguintes formas:

- lâminas fixas;
- lâminas móveis.

Os sistemas de lâminas móveis permitem um controle sobre a sua orientação através de um mecanismo manual ou motorizado em que ambos poderão ser comandados à distância. As lâminas quebra sol existem com as secções transversais de 120, 165, 250 e 345 mm com uma espessura média dos perfis de alumínio de 1.5 mm.

PROTECCIÓN SOLAR

CARACTERÍSTICAS

Sistemas de aluminio preparados para montaje sobre fachadas que visam hacer el efecto de protección solar apresentando al mismo tiempo una forma estetica.

Permiten la montaje en las siguientes formas:

- lamas fijas;
- lamas orientables.

Los sistemas de lamas orientables permiten un control sobre su orientación mediante un mecanismo manual u motorizado en que ambos podrán ser comandados a la distancia. Las lamas de protección solar existen con las secciones transversales de 120, 165, 250 y 345 mm con un espesor medio de los perfiles de aluminio de 1.5 mm.

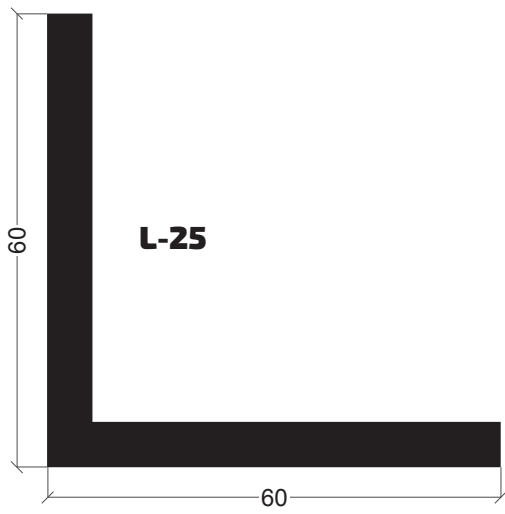

G-01

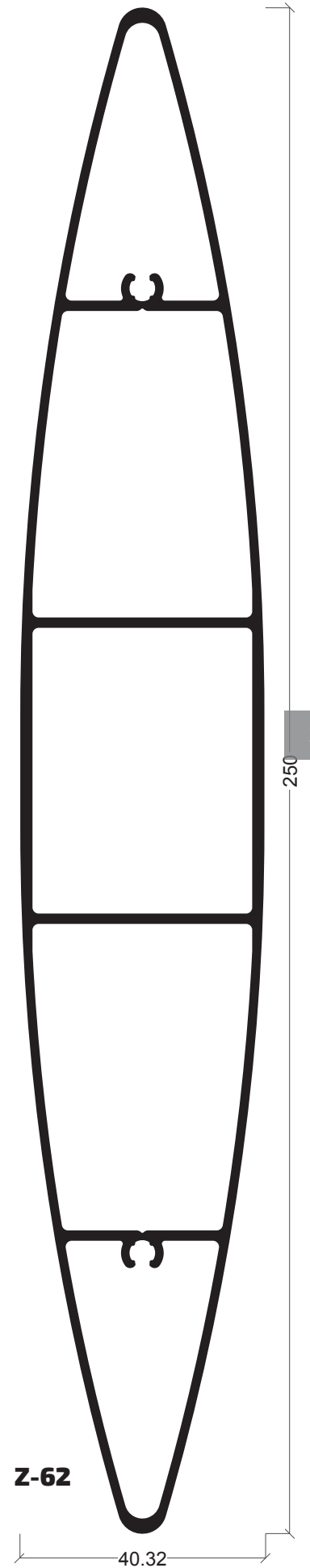
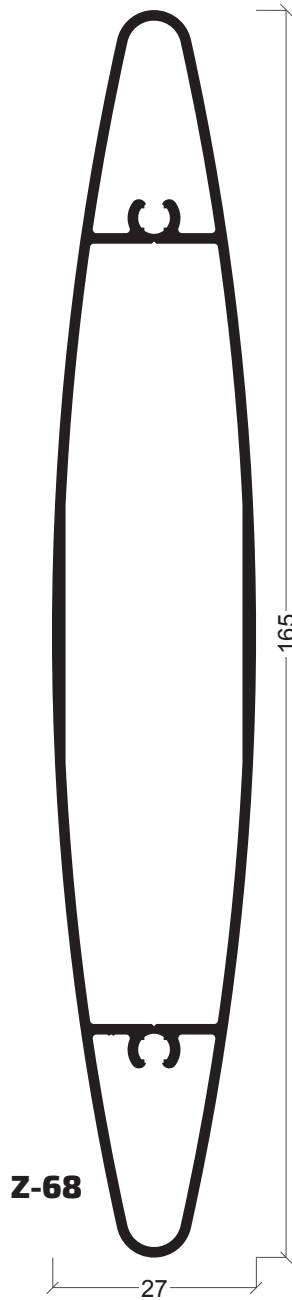
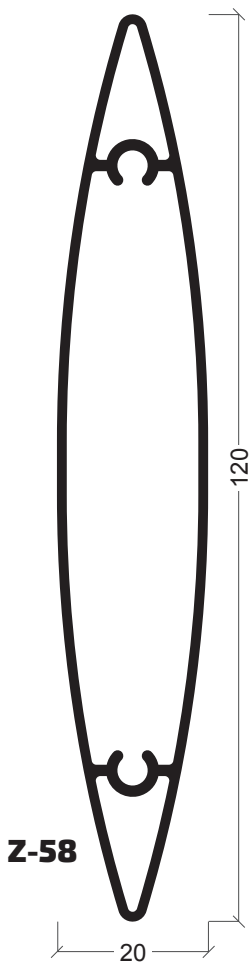

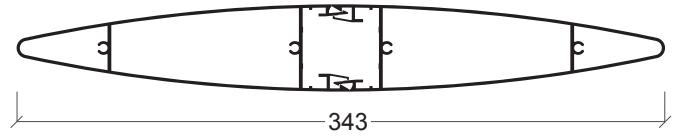

Z-65 + Z-65

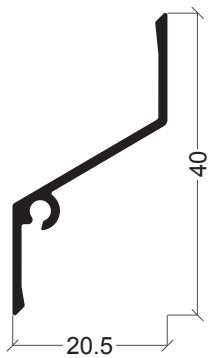

Z-26

250

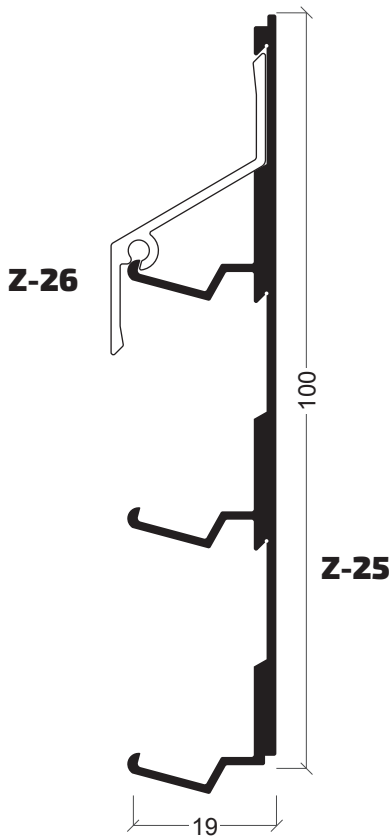

Z-25 + Z-26

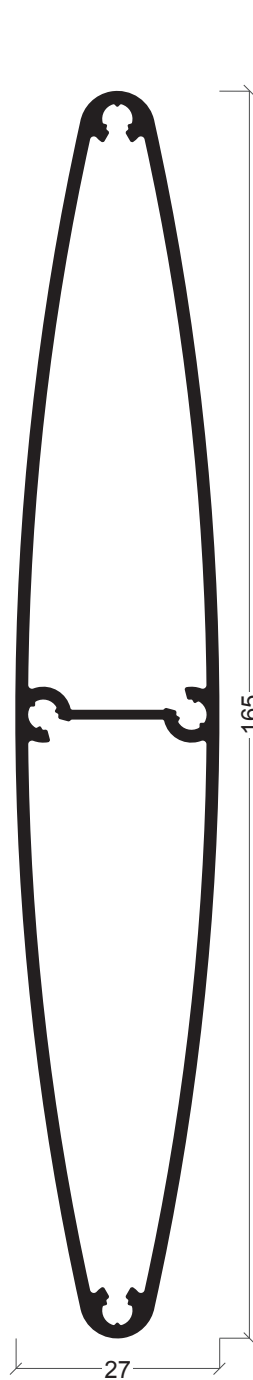

Z-64
(lámina fija • lama fija)

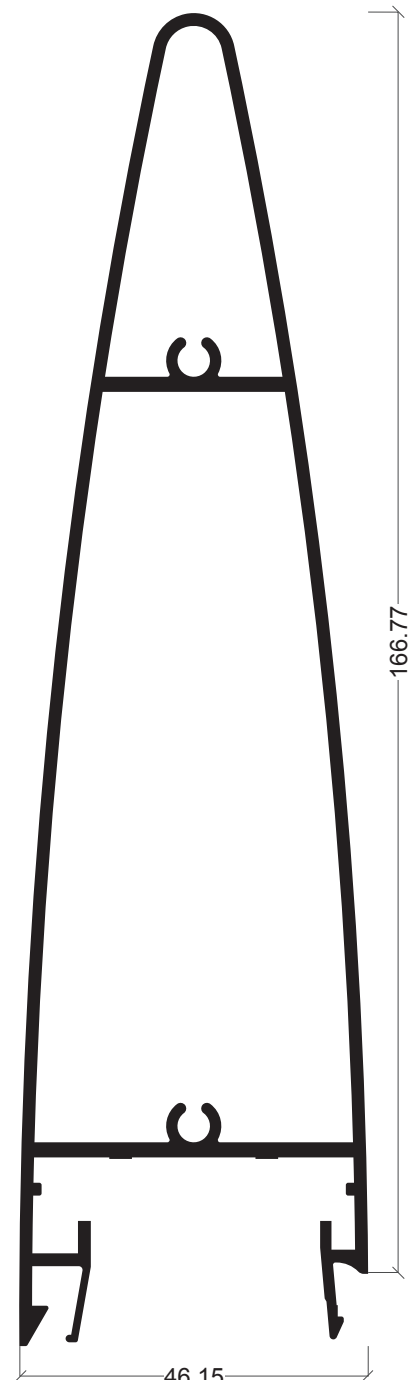

Z-65

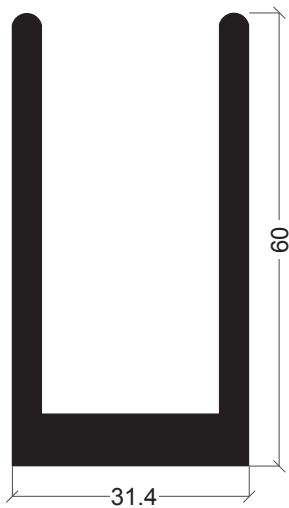

U-09

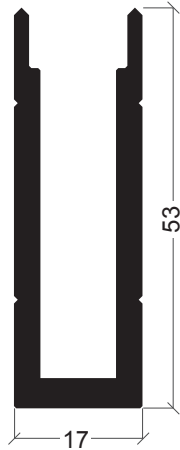

U-10



U-08

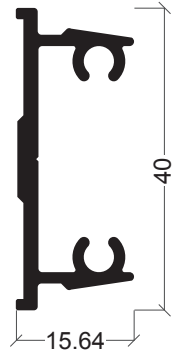

Z-63

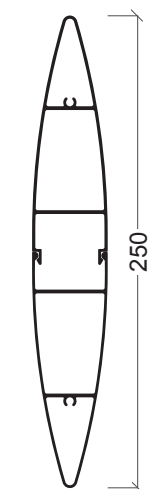

Z-56+Z57

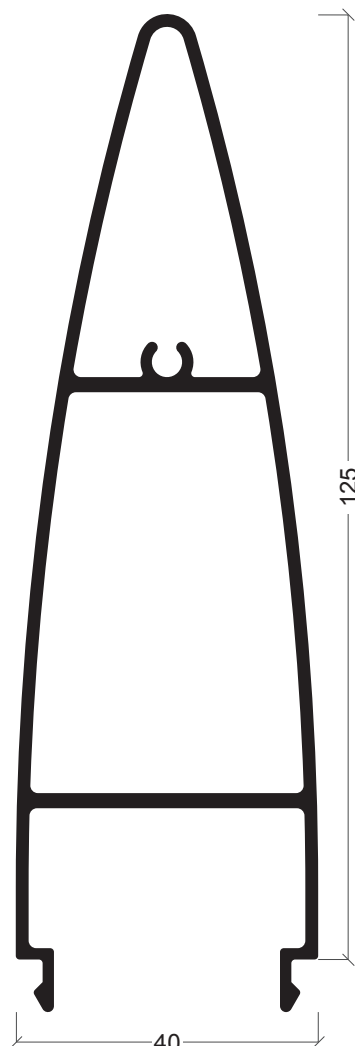

Z-56

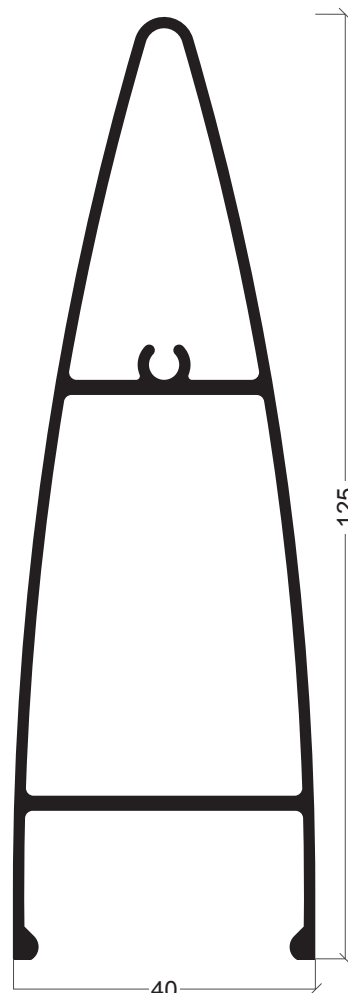

Z-57

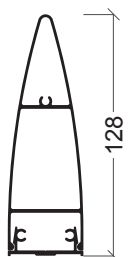

Z-57 + Z-63

252

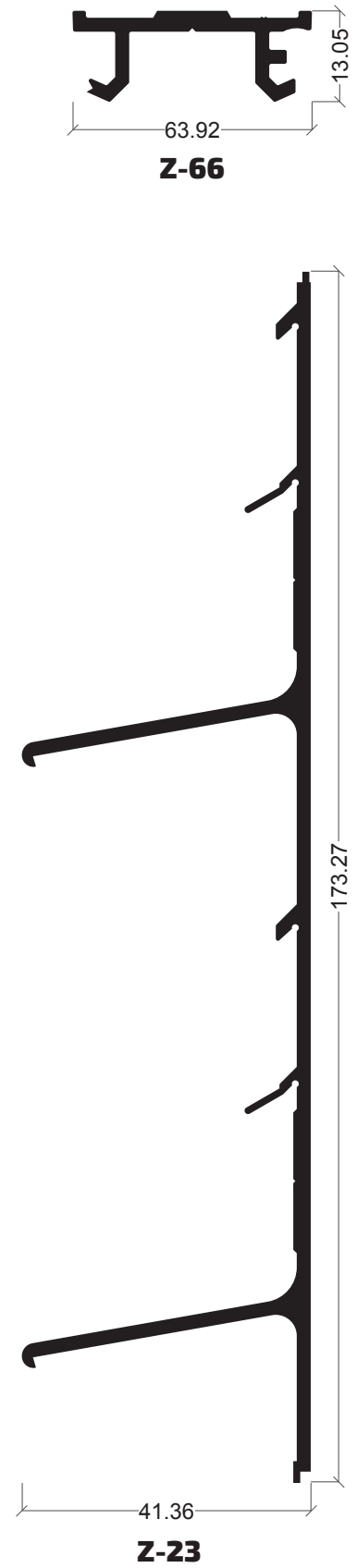
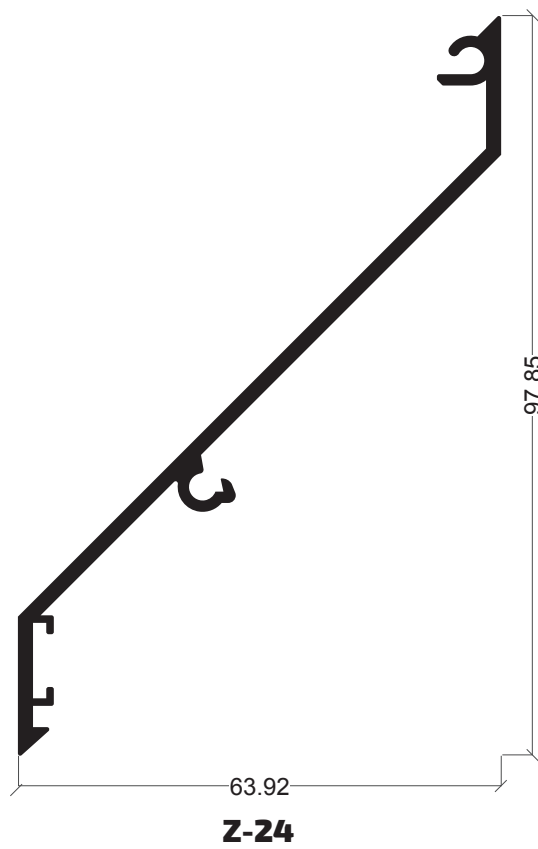
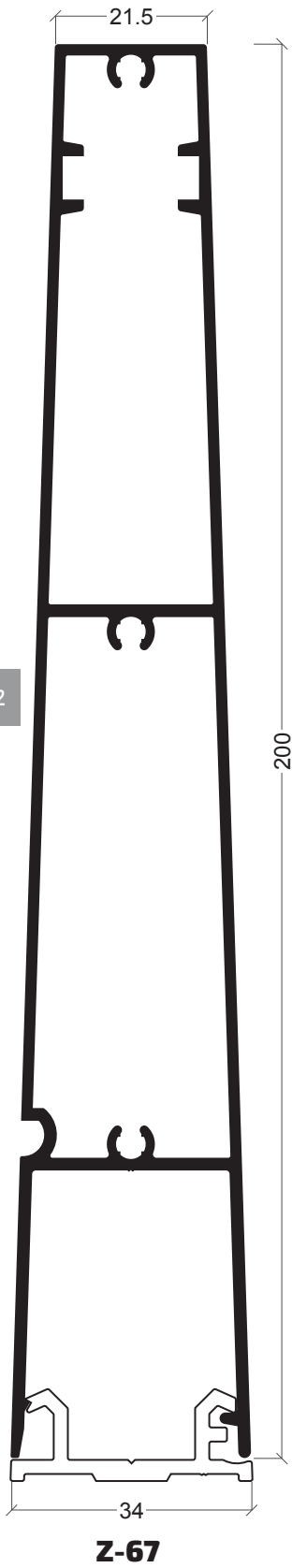

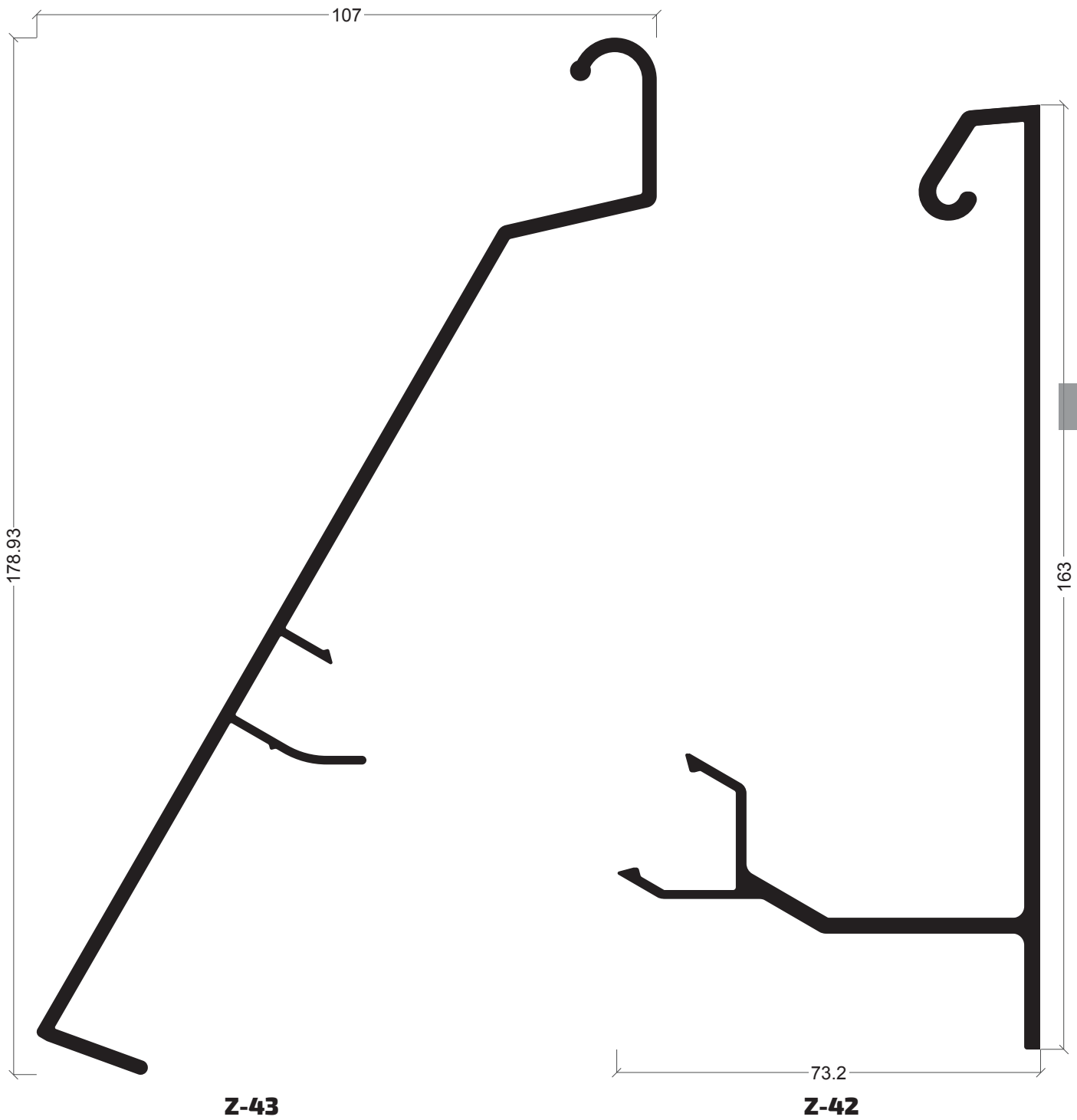

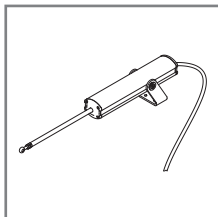

30 15 10 84

Motor eléctrico
Motor electrico

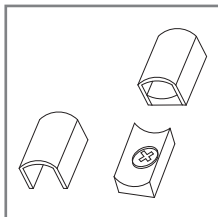

30 15 11 00

Fixador tubo comando manual
Presilla

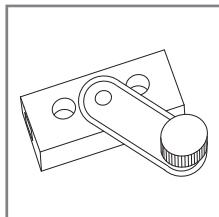

30 15 11 02

Manivela comando manual
Manilla mando manual

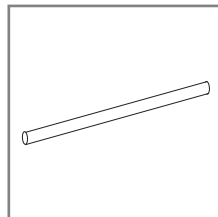

30 15 11 03

Tubo aluminio (3 mts)
Tubo aluminio (3 mts)

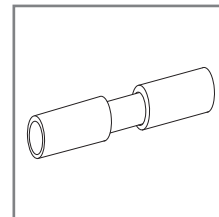

30 15 11 04

União de tubos
Unión de tubería

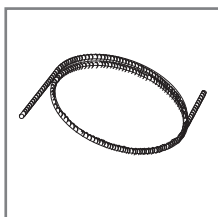

30 15 11 12

Bicha comando manual
Acople mando manual

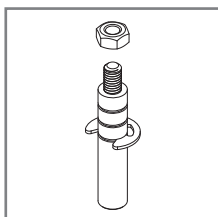

30 15 11 24

Eixo superior lâmina (Z-58 ou Z-68)
Eje superior lâmina (Z-58 ou Z-68)

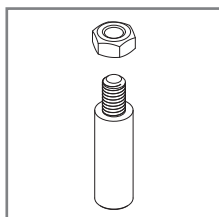

30 15 11 29

Eixo inferior (Z-58 ou Z-68)
Eje inferior (Z-58 u Z-68)

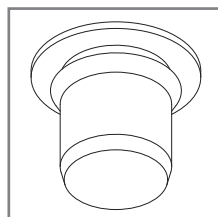

30 15 11 30

Casquillo inferior (Z-58 ou Z-68)
Casquillo inferior (Z-58 u Z-68)

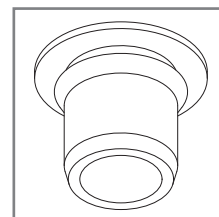

30 15 11 31

Casquillo superior (Z-58 ou Z-68)
Casquillo superior (Z-58 u Z-68)

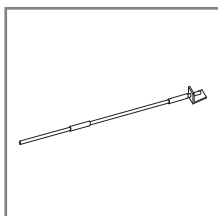

30 15 11 36

Acionador telescópico
Accionador telescopico

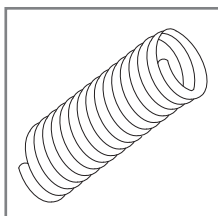

30 15 11 96

Mola fim de curso
Grapa fin de curso

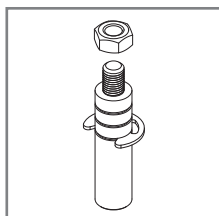

30 15 12 24

Eixo superior lâmina (Z-62 ou Z-65)
Eje superior lâmina (Z-62 u Z-65)

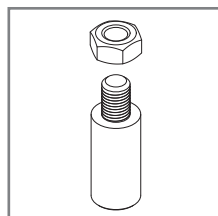

30 15 12 29

Eixo inferior lâmina (Z-62 ou Z-65)
Eje inferior lâmina (Z-62 u Z-65)

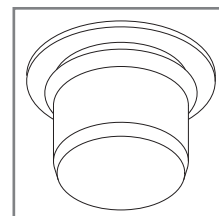

30 15 12 30

Casquillo inferior lâmina (Z-62 ou Z-65)
Casquillo inferior lâmina (Z-62 u Z-65)

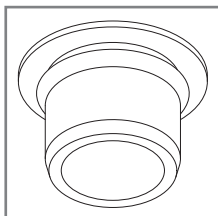

30 15 12 31

Casquillo superior lâmina (Z-62 ou Z-65)
Casquillo superior lâmina (Z-62 u Z-65)

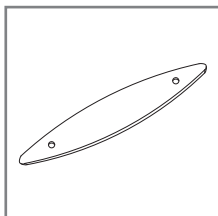

31 15 00 40

Topo simples 250 mm
Tope simples 250 mm

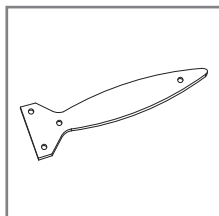

31 15 00 42

Topo fixação 120 mm
Tope fijación 120 mm

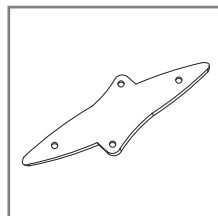

31 15 00 63

Topo fixação central 120 mm
Tope fijación central 120 mm

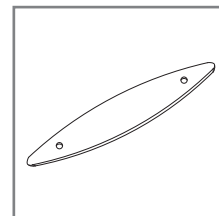

31 15 00 67

Topo simples 120 mm
Tope simples 120 mm

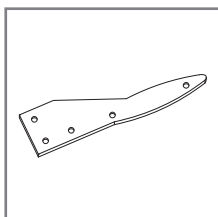

31 15 00 71

Topo fixação alongado 120 mm
Tope fijación alongada 120 mm

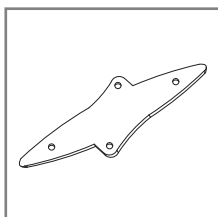

31 15 00 75

Topo fixação central 250 mm
Tope fijación central 250 mm

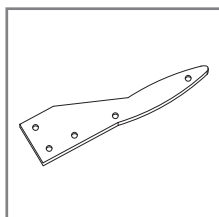

31 15 00 79

Topo fixação alongado 250 mm
Tope fijación alongado 250 mm

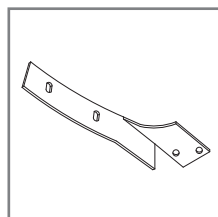

31 15 00 84

Suporte central 250 mm direito
Soporte central 250 mm derecho

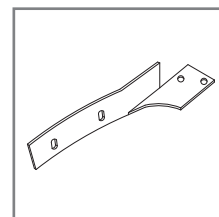

31 15 00 85

Suporte central 250 mm esquerdo
Soporte central 250 mm izquierdo

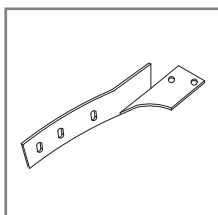

31 15 00 86 / 87

Suporte central 343 mm esquerdo / direito
Soporte central 343 mm izquierdo / derecho

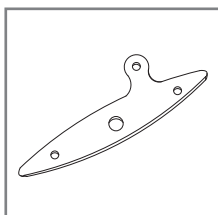

31 15 01 01

Topo lateral lâmina móvel 120 mm
Tope lateral lâmina orientable 120 mm

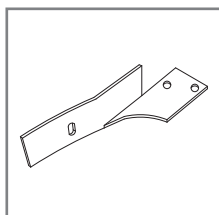

31 15 01 08

Suporte central 120 mm esquerdo
Soporte central 120 mm izquierdo

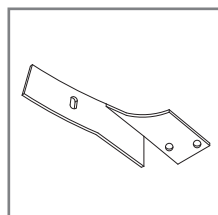

31 15 01 09

Suporte central 120 mm direito
Soporte central 120 mm derecho

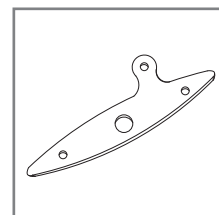

31 15 01 12

Topo lateral lâmina móvel 250 mm
Tope lateral lâmina orientable 250 mm

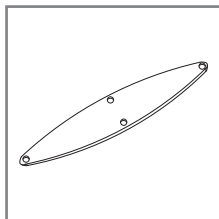

31 15 01 15

Topo simples 165 mm (Z-64)
Tope simples 165 mm (Z-64)

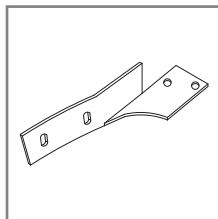

31 15 01 16

Suporte central 165 mm esquerdo
Soporte central 165 mm izquierdo

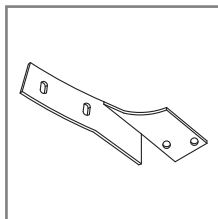

31 15 01 17

Suporte central 165 mm direito
Soporte central 165 mm derecho

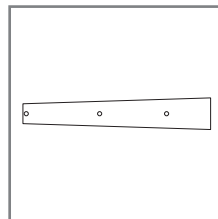

31 15 01 35

Topo para lâmina Z-67
Tope para lama Z-67

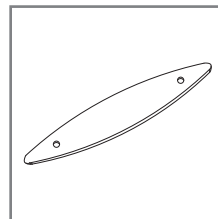

31 15 01 36

Topo simples 343 mm
Tope simples 343 mm

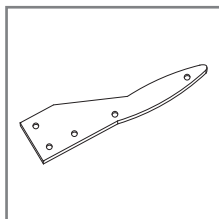

31 15 01 40

Topo fixação alongado 343 mm
Tope fijación alongada 343 mm

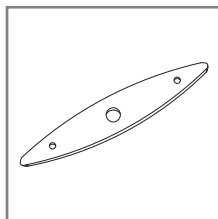

31 15 01 42

Topo lateral lâmina móvel 120 mm
Tope lateral lama orientable 120 mm

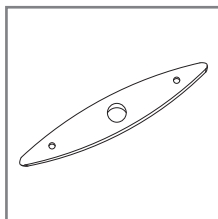

31 15 01 43

Topo lateral lâmina móvel 343 mm
Tope lateral lama orientable 343 mm

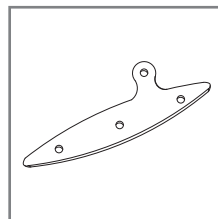

31 15 01 44

Topo lateral lâmina móvel 343 mm
Tope lateral lama orientable 343 mm

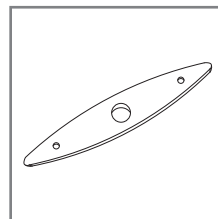

31 15 01 46

Topo lateral lâmina móvel 250 mm
Tope lateral lama orientable 250 mm

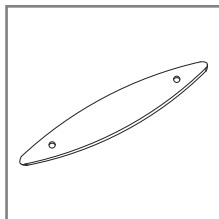

31 15 01 51

Topo simples 165 mm (Z-68)
Tope simples 165 mm (Z-68)

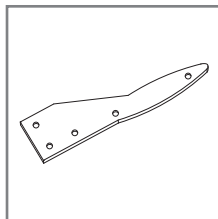

31 15 01 56

Topo fixação alongado 165 mm (Z-68)
Tope fijación alongado 165 mm (Z-68)

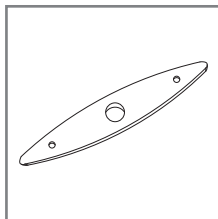

31 15 01 60

Topo lateral lâmina móvel 165 mm (Z-68)
Tope lateral lama orientable 165 mm (Z-68)

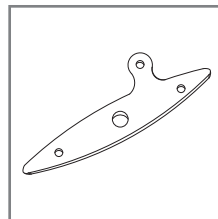

31 15 01 61

Topo lateral lâmina móvel com aba 165 mm (Z-68)
Tope lateral lama orientable con aba 165 mm (Z-68)

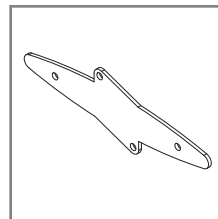

31 15 01 62

Topo fixação central 165mm (Z-68)
Tope fijación central 165mm (Z-68)

255

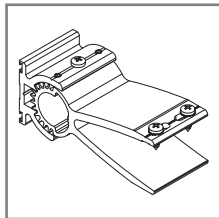

31 15 02 00

Conjunto garras Z-58 (bruto)
Conjunto garras Z-58 (crudo)

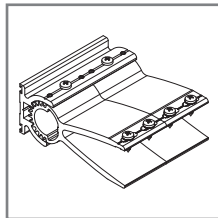

31 15 02 01

Conjunto garras duplas Z-58 (bruto)
Conjunto garras doble Z-58 (crudo)

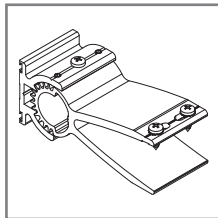

31 15 02 10

Conjunto garras Z-64/Z-68 (bruto)
Conjunto garras Z-64/Z-68 (crudo)

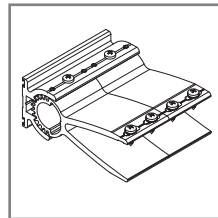

31 15 02 11

Conjunto garras duplas Z-64/Z-68 (bruto)
Conjunto garras doble Z-64/Z-68 (crudo)

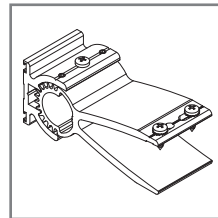

31 15 02 20

Conjunto garras Z-62 (bruto)
Conjunto garras Z-62 (crudo)

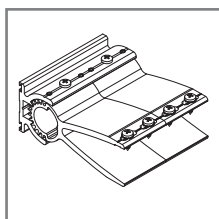

31 15 02 21

Conjunto garras duplo Z-62 (bruto)
Conjunto garras doble Z-62 (crudo)

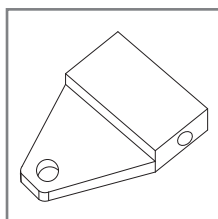

31 15 11 25

Ligação sistema elet. lâmina solar
Ligación sistema elettrico u manual

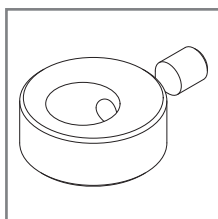

31 15 11 26

Anel freio lâmina (Z-58 u Z-68)
Anillo freno lama (Z-58 u Z-68)

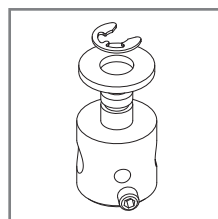

31 15 11 28

Eixo de ligação (Z-58 u Z-68)
Eje de ligación (Z-58 u Z-68)

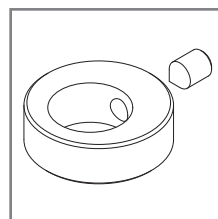

31 15 12 26

Anel freio lâmina (Z-62 u Z-65)
Anillo freno lama (Z-62 u Z-65)

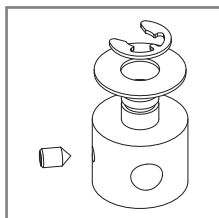

31 15 12 28

Eixo de ligação (Z-62 u Z-65)
Eje ligación lama (Z-62 u Z-65)

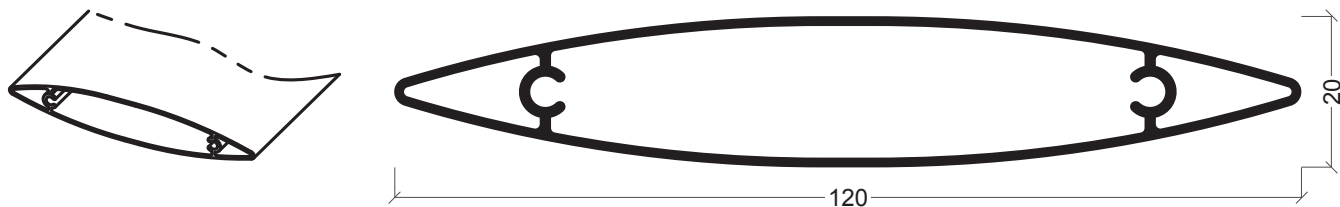

Z-58

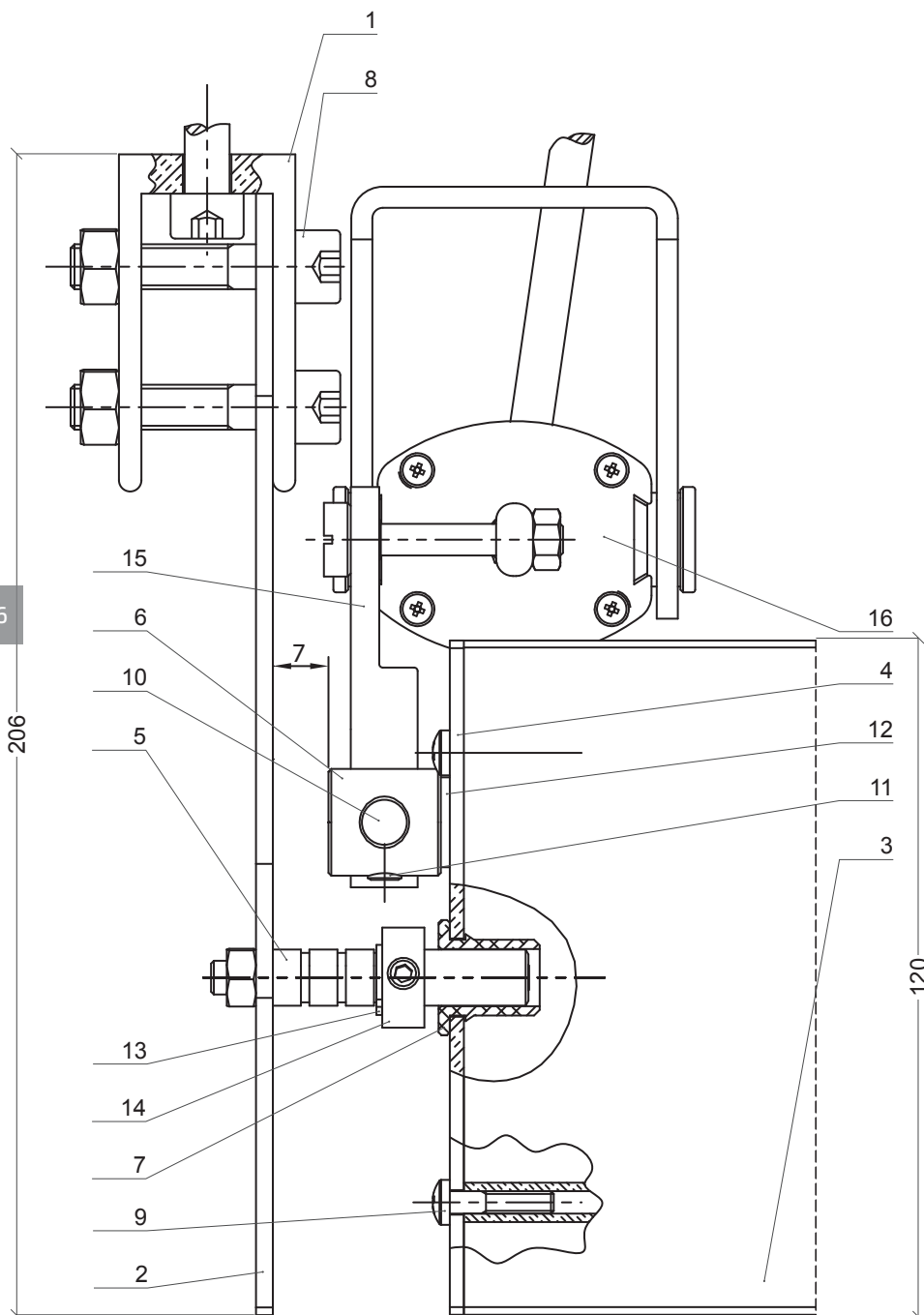

256

206

120

- 1. U-09**
Calha suporte U-09
Soporte U-09
- 2. 31 15 00 71**
Topo fixação alongado Z-58
Tope fijación alongado Z-58
- 3. Z-58**
Lâmina 120 mm
Lama 120 mm
- 4. 31 15 01 01**
Topo móvel
Tope móvil
- 5. 30 15 11 24**
Eixo para móvel de rotação
Eje para móvi de rotación
- 6. 31 15 11 28**
Eixo de ligação lâmina
Eje de ligación lama
- 7. 30 15 11 31**
Casquilho em nylon para eixo
Casquillo en nylon para eje
- 8. Parafuso • Tornillo**
DIN 912 M8x40
- 9. Parafuso • Tornillo**
ISO 7045 M4x16
- 10. G-01**
Varão 8 mm
Diámetro 8 mm
- 11. Perno**
DIN 913 M6x6
- 12. Anilha • Anilla**
em nylon 16x1.6
en nylon 16x1.6
- 13. Freio • Freno**
TRUARC
- 14. 31 15 11 26**
Anel excêntrico de ajustamento
Anillo excéntrico de ajustamiento
- 15. 31 15 11 25**
Ligação ao motor/comando manual
Ligación al motor/mando manual
- 16. 30 15 10 84**
Motor eléctrico
Motor eléctrico

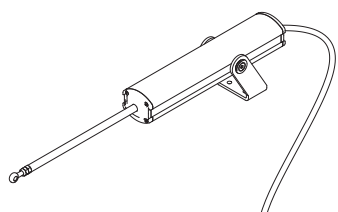

Montagem do motor sempre com o pistão virado para baixo
Montaje del motor siempre con el pistón virado abajo

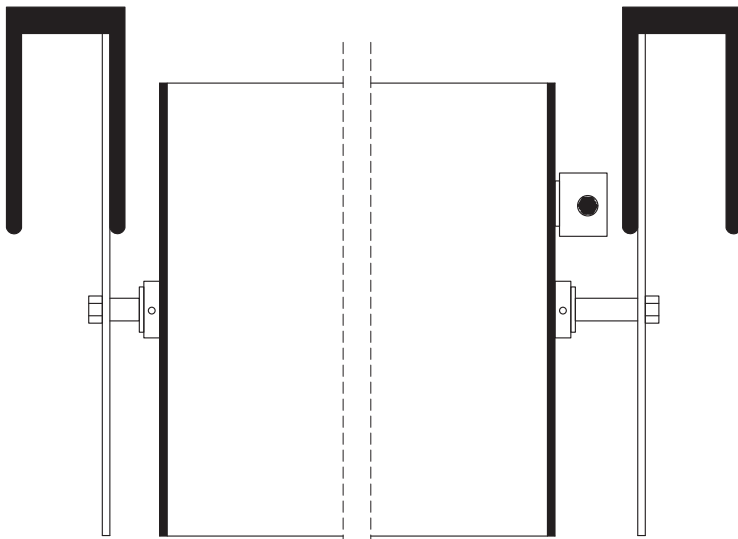
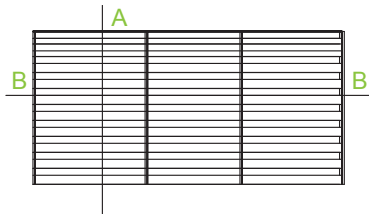

Secção B - B • Sección B - B

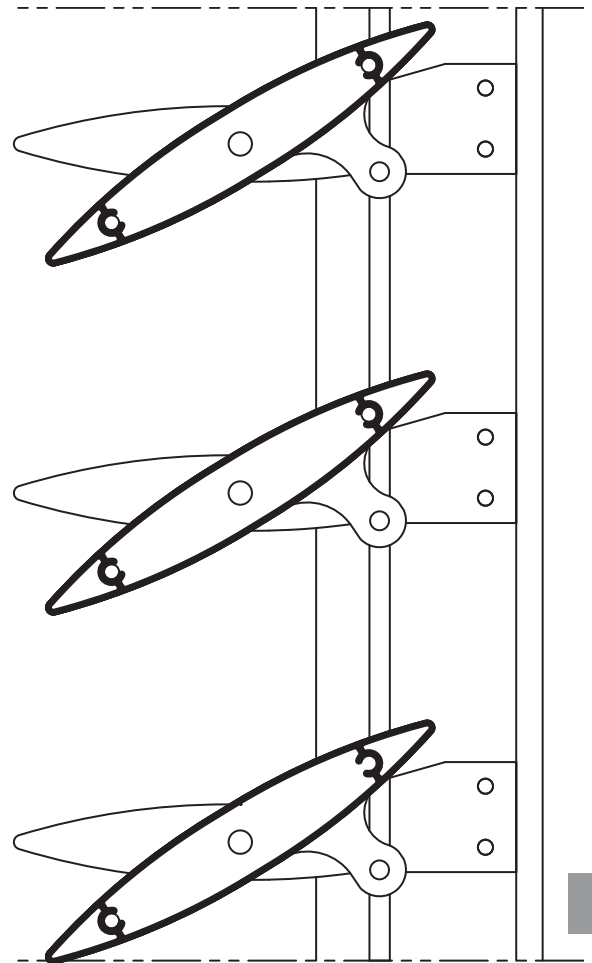

Secção A - A • Sección A - A

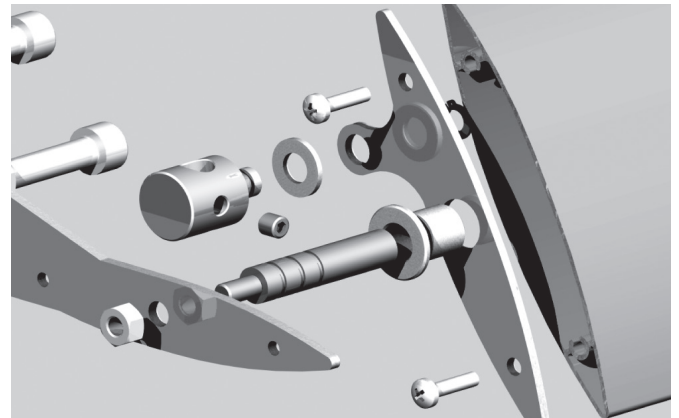
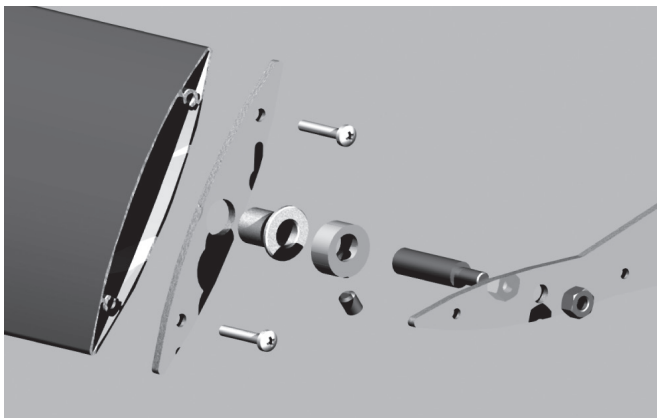

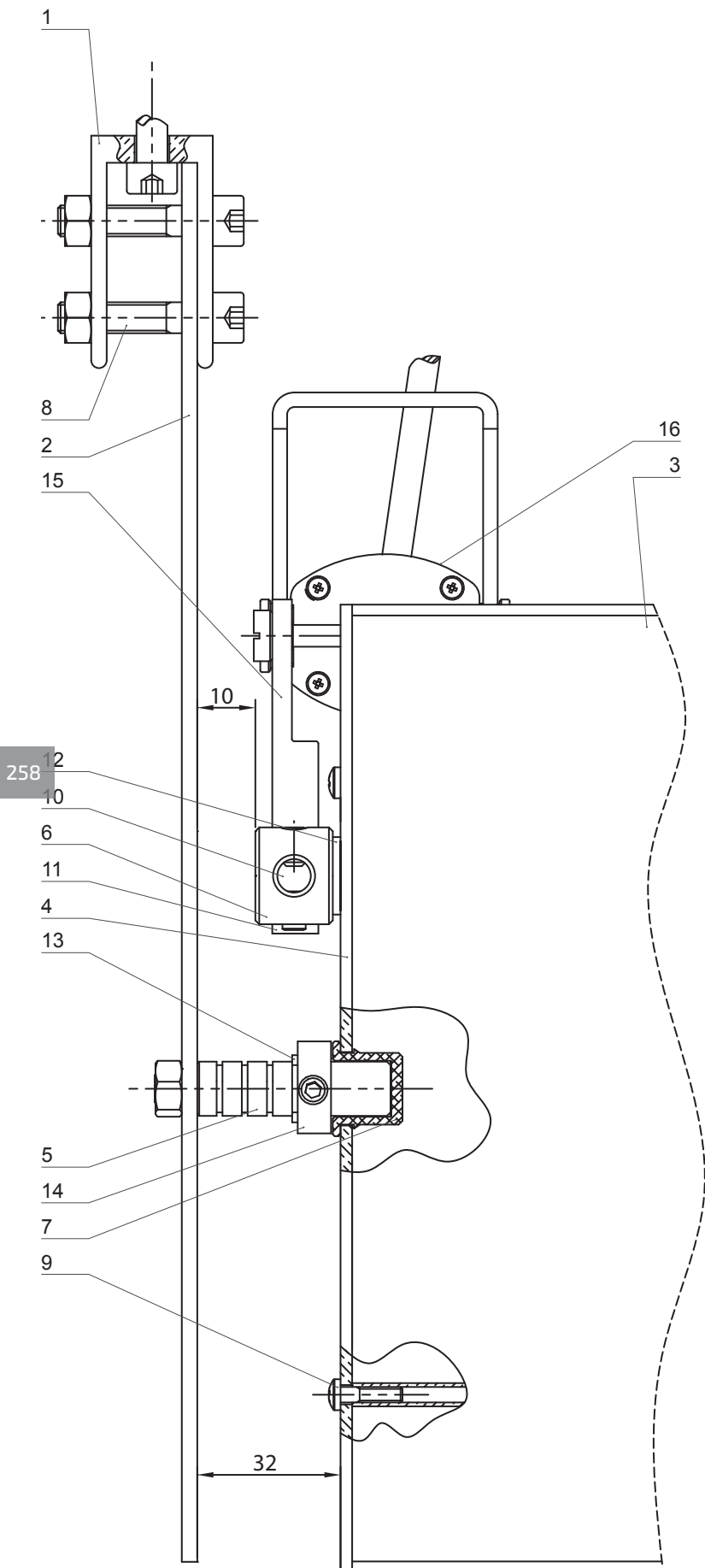

1. U-09

Calha suporte U-09
Soporte U-09

2. 31 15 00 79

Topo fixação alongado 250 mm
Tope fijación alongado 250 mm

3. Z-62

Lâmina 250 mm
Lama 250 mm

4. 31 15 01 12

Topo móvel
Tope móvil

5. 30 15 12 24

Eixo para móvel de rotação
Eje para móvi de rotación

6. 31 15 12 28

Eixo de ligação lâmina
Eje de ligación lama

7. 30 15 12 31

Casquilho em nylon para eixo
Casquillo en nylon para eje

8. Parafuso • Tornillo

DIN 912 M8x40

9. Parafuso • Tornillo

ISO 7045 M4x16

10. G-01

Varão 8 mm
Diámetro 8 mm

11. Perno

DIN 913 M6x6

12. Anilha • Anillo

em nylon 16x1.6
en nylon 16x1.6

13. Freio • Freno

TRUARC

14. 31 15 11 26

Anel excêntrico de ajustamento
Anillo excentrico de ajustamiento

15. 31 15 11 25

Ligação ao motor/comando manual
Ligación al motor/manido manual

16. 30 15 10 84

Motor eléctrico
Motor eléctrico

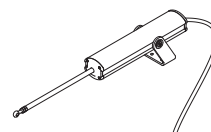

Montagem do motor sempre com o pistão virado para baixo
Montaje del motor siempre con el pistón virado abajo

Z-62

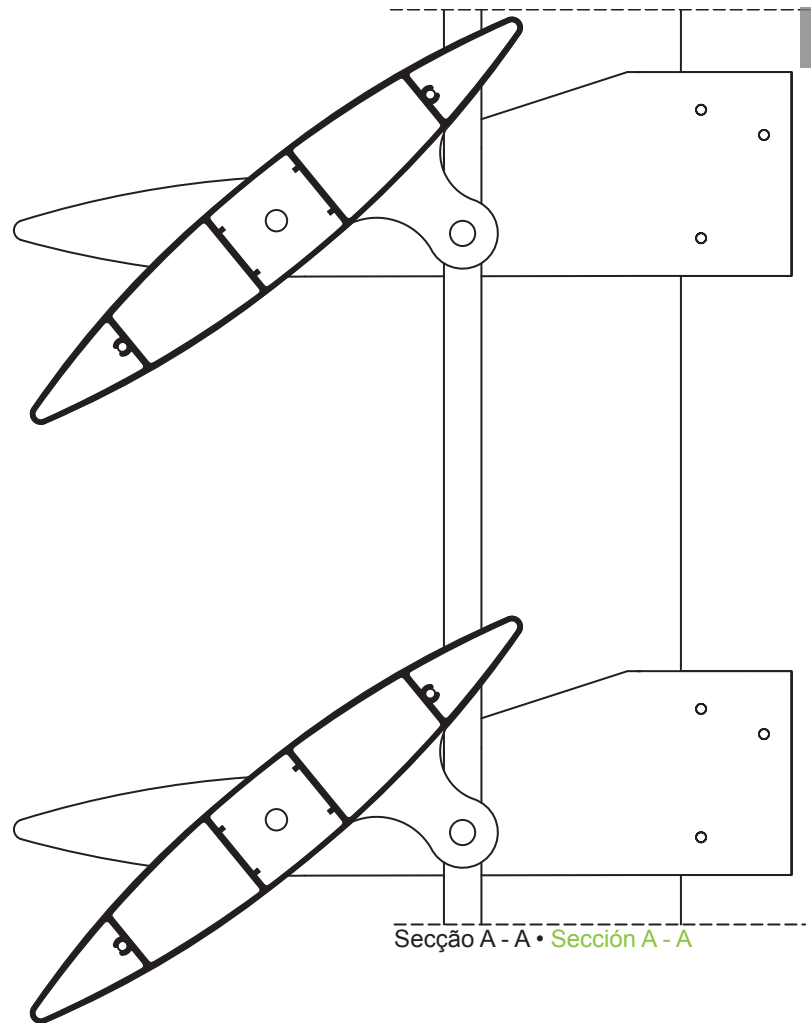
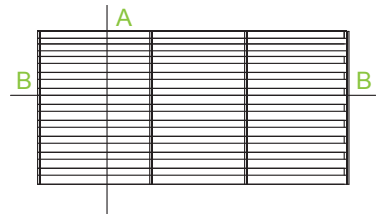
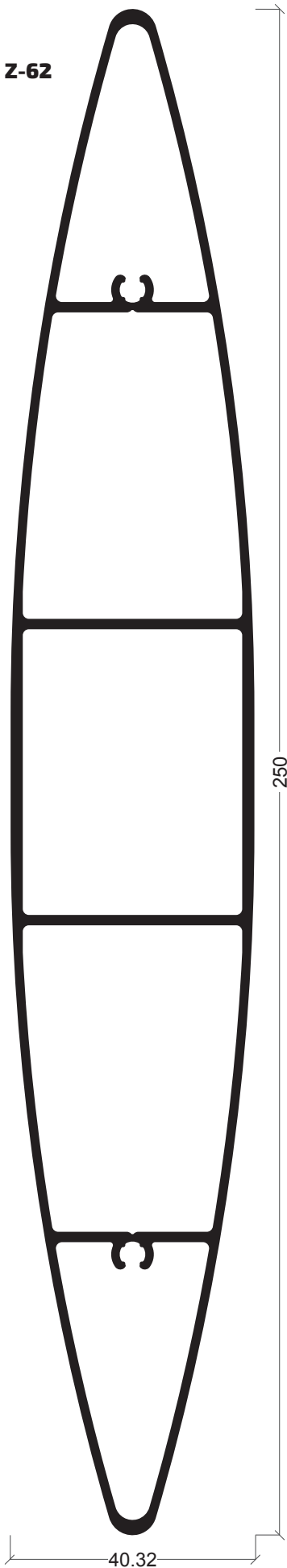

260

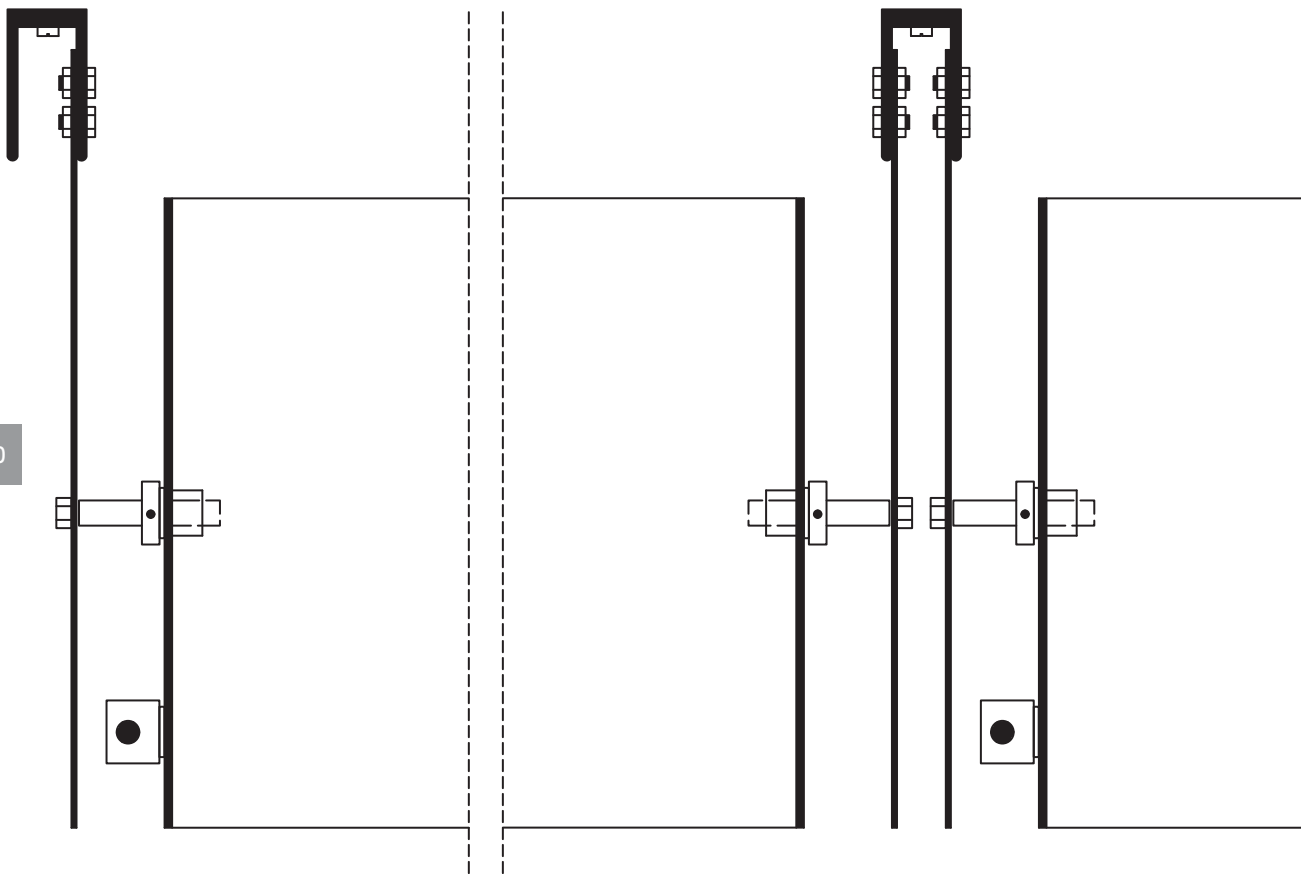

Secção B - B • Sección B - B

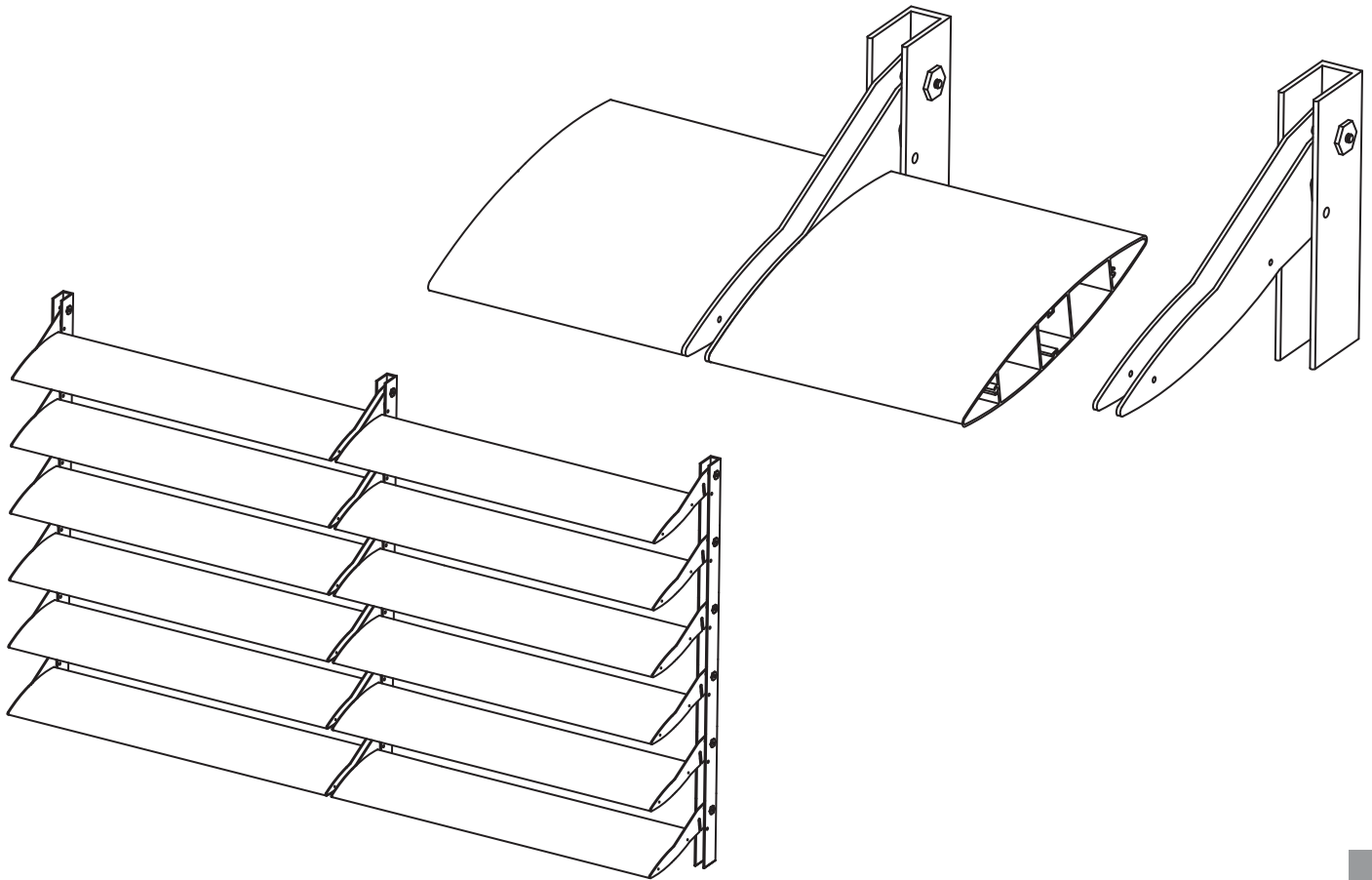

Pormenor A • **Detalle A**

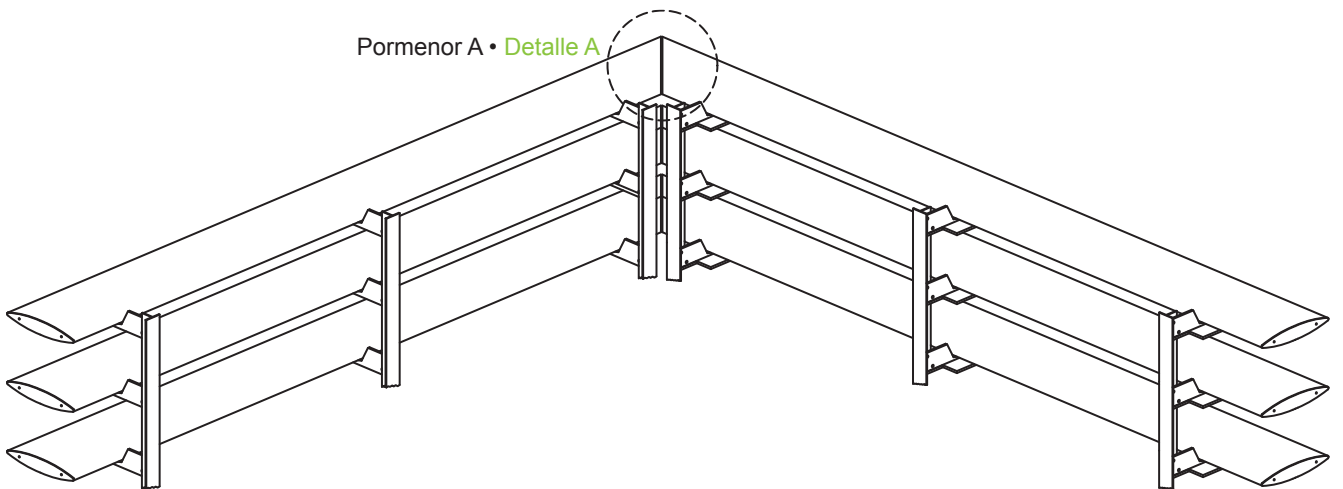

Pormenor A • **Detalle A**

Junta com silicone estrutural
Junta con silicona estructural

