



PRIME

SISTEMA MINIMALISTA
CORTE TÉRMICO 180MM

SISTEMA MINIMALISTA
PUENTE TÉRMICO 180MM

SISTEMA PRIME

Sistema de correr de conceito minimalista com corte térmico

CARACTERÍSTICAS DO SISTEMA

Sistema de alumínio com rotura térmica para executar vãos de correr de grandes dimensões de conceito minimalista procurando aliar o máximo de transparência com o mínimo de visão estrutural.

PERFIS DE ALUMÍNIO

Perfis extrudidos nas ligas de alumínio 6060 para arquitetura de acordo com norma NP EN 12020-02.

Os perfis com rotura térmica são obtidos por inserção de varetas de poliamida 6.6 reforçadas com 25% de fibra de vidro de 14.6mm nos aros fixos e de 32mm nos aros móveis. A espessura média dos perfis de alumínio é de 2mm;

AROS FIXOS

Secção do aro fixo perimetral ou de corte recto de 82.7mm mono-rail, de 180mm bi-rail ou 277.3mm tri-rail;

Perfil guia de deslizamento inferior em alumínio com rolamentos duplos de altas prestações ou com guia carril, ambos em aço inoxidável.

Este sistema inclui soluções com soleiras embutidas para permitir a integração no pavimento, assim como, pré-aros para uma melhor e eficaz aplicação dos caixilhos e drenagem mais eficiente. Existe também a possibilidade de aplicação de remates interior ou exterior.

AROS MÓVEIS

Secção dos aros móveis de vista muito reduzida de corte reto com montagem por ligação mecânica;

Vidro duplo ou triplo isolante com selagem secundária de silicone desde 34mm até 56mm de espessura total composto por tipologias de vidro exterior temperado ou termo-endurecido e de vidro interior temperado ou laminado-temperado;

Silicones estruturais recomendados para colagem vertical dos vidros: Silicone estrutural Dow Corning 895 preto ou silicone estrutural Sikasil SG20 preto.

Aros móveis reforçados para grande dimensionamento;
 Solução com rede mosquiteira.

DIMENSIONAMENTO E MANIOBRABILIDADE

Dimensões mínimas - máximas de folha abertura manual 500mm - 2500mm (L);

Dimensões mínimas - máximas de folha abertura manual 500mm - 4000mm (H);

Área máxima da folha abertura manual: 10m².

Peso máximo de 450Kg por folha abertura manual.

Dimensões mínimas - máximas de folha abertura motorizada 1000mm - 3200mm (L);

Dimensões mínimas - máximas de folha abertura motorizada 1700mm - 5000mm (H);

Área máxima da folha abertura motorizada: 16m²;

Peso máximo de 1000Kg por folha em abertura motorizada;

Tipologias de 2 a 6 folhas com folhas móveis e/ou fixas;

Possibilidade de abertura em canto ou abertura em Galandage;

O deslizamento das folhas é feito sobre perfil guia de deslizamento inferior em alumínio com rolamentos duplos de altas prestações em aço inoxidável ou com guia carril em aço inoxidável para uma fácil abertura do vão mesmo em configurações extremas de peso ou dimensões;

Tipologias dos vãos com mais de 98% de luminosidade;

Permeabilidade ao ar e estanquidade à água assegurada através de pelúcia de última geração e junta em EPDM de qualidade marítima;

Ferragem Multiponto com diversos pontos de fechos de fácil aplicação e regulação incluído possibilidade de micro-ventilação;

Puxadores específicos com tratamento de lacagem ou de anodização para facilitar a manobra de abertura e de fecho do vão;

Existe opção de aplicação de fechadura para uma abertura exterior/interior.

PERFORMANCES

Sistema certificado por laboratório credenciado, notificado para Ensaio Tipo Inicial (ITT) de acordo com a norma de produto EN 14351-1 para efeitos de Marcação CE.

Avaliação do Sistema PRIME em tipologia porta de 2 folhas com ou sem soleira embutida:

1. Permeabilidade ao ar: Classe 4 (normas de ensaio EN 12207 e EN 1026)
2. Estanquidade à água: Classe 8A (normas de ensaio EN 12208 e EN 1027)
3. Resistência ao vento: Classe B4 (normas de ensaio EN 12210 e EN 12211)

Coefficiente de atenuação acústica de vão de 2 folhas com vidro acústico 66.2 Stratophone / 16 / 88.2 Stratophone :

• Rw (C; Ctr) = 37 dB (0; -1)

Coefficiente de transmissão térmica de vão de 2 folhas com 6.0m x 3m com vidro duplo de valor Ug= 0.5 W/m²K, intercalar efeito "Warm Edge" e factor solar g=0.37:

• Uw = 0,98 W/m²K

Zonas de aplicação segundo os regulamentos REH e RECS (em função do valor Ug) : I1, I2, I3, V1, V2, V3;

SISTEMA PRIME

Sistema de corredera de concepto minimalista con puente térmico

CARACTERÍSTICAS DEL SISTEMA

Sistema de aluminio para ejecución de huecos correderos de grandes dimensiones de concepto minimalista en busca del máximo de transparencia con el mínimo de visión estructural.

PERFILES DE ALUMINIO

Perfiles extrudidos en la aleación de aluminio 6060 para arquitectura de acuerdo con la norma NP EN 12020-02.

Son obtenidos por inserción de varillas de poliamida 6.6 reforzadas con 25% fibra de vidrio de 14.6mm en los marcos y 32mm en las hojas. El espesor medio de los perfiles de aluminio es de 2mm.

MARCOS

Sección de marco fijo o de corte recto de 82.7mm monocarril, de 180mm bicarril o 277.3 tricarril;

Perfil guía inferior deslizante de aluminio con doble rodamiento de alto rendimiento o con guía de carril, ambos en acero inoxidable.

Este sistema incluye soluciones con solape empotrados para permitir la integración en el suelo, así como pre marcos para una mejor y eficaz aplicación de los marcos y un drenaje más eficiente. También existe la posibilidad de aplicar remates interiores o exteriores.

HOJAS

Sección de hojas de vista muy reducida de corte recto con montaje por ligación mecánica;

Vidrio doble o triple aislante con sellado secundario de silicona de 34 mm a 56 mm de espesor total, compuesto por tipos de vidrio exterior templado o termoendurecible y vidrio interior laminado o laminado templado.

Siliconas estructurales recomendadas: Dow Corning 895 black o Sikasil SG20 black; Hojas reforzadas para grandes dimensiones.

Solución de red mosquiteira.

DIMENSIONAMENTO Y MANIOBRABILIDAD

Dimensiones mínimas - máximas de hoja apertura manual 500mm - 2500mm (L);

Dimensiones mínimas - máximas de hoja apertura manual 500mm - 4000mm (H);

Área máxima de hoja apertura manual: 10m².

Peso máximo de 450 kg por hoja apertura manual;

Dimensiones mínimas - máximas de hoja apertura con motor 1000mm - 3200mm (L);

Dimensiones mínimas - máximas de hoja apertura con motor 1700mm - 5000mm (H);

Área máxima de hoja apertura con motor: 16m².

Peso máximo de 1000 kg por hoja apertura manual;

Possibilidades de apertura: 2 a 6 hojas, con hojas correderas y/ó fijas;

Possibilidade de abertura en esquina o abertura en Galandage;

El deslizamiento de las hojas se realiza sobre un perfil guía deslizante inferior de aluminio con doble rodamiento de alto rendimiento en acero inoxidable o con un carril guía en acero inoxidable para una fácil apertura del hueco incluso en configuraciones extremas de peso o dimensiones;

Permite que tener un hueco con más del 98% de luminosidad;

Permeabilidad al aire y estanquidad al agua aseguradas a través de la junta de EPDM de calidad marina y felpa de última generación;

Herrajes multipunto con varios puntos de cierre para una fácil aplicación y ajuste, incluyendo la posibilidad de micro ventilación;

Manillas específicas con tratamiento de lacado o anodizado para facilitar la apertura y cierre;

Existe la opción de aplicar una cerradura para una apertura exterior/interior.

ENSAYOS

Sistema certificado por laboratorio credenciado, notificado para Ensayos Tipo Inicial (ITT) de acuerdo con la norma de producto EN 14351-1 para efectos de Marcado CE.

Categorías alcanzadas en los ensayos del sistema PRIME tipologia 2 puertas con y sin solape empotrada:

1. Permeabilidad al aire: Clase 4 (norma de ensayo EN 12207 y EN 1026)
2. Estanquidad al agua: Clase 8A (norma de ensayo EN 12208 y EN 1027)
3. Resistencia al viento: Clase B4 (norma de ensayo EN 12210 y EN 12211)

Coefficiente de transmisión térmica de hueco de 2 hojas con vidrio acústico 66.2 Stratophone / 16 / 88.2 Stratophone :

• Rw (C; Ctr) = 37 dB (0; -1)

Coefficiente de transmisión térmica de hueco de 2 hojas con 6 m x 3 m con vidrio doble Ug = 0.5 W/m²K, intercalar efecto "Warm Edge" y factor solar g=0.37:

• Uw = 0,98 W/m²K

Zonas de aplicación según los regulamientos REH y RECS (en función del valor Ug): I1, I2, I3, V1, V2, V3;

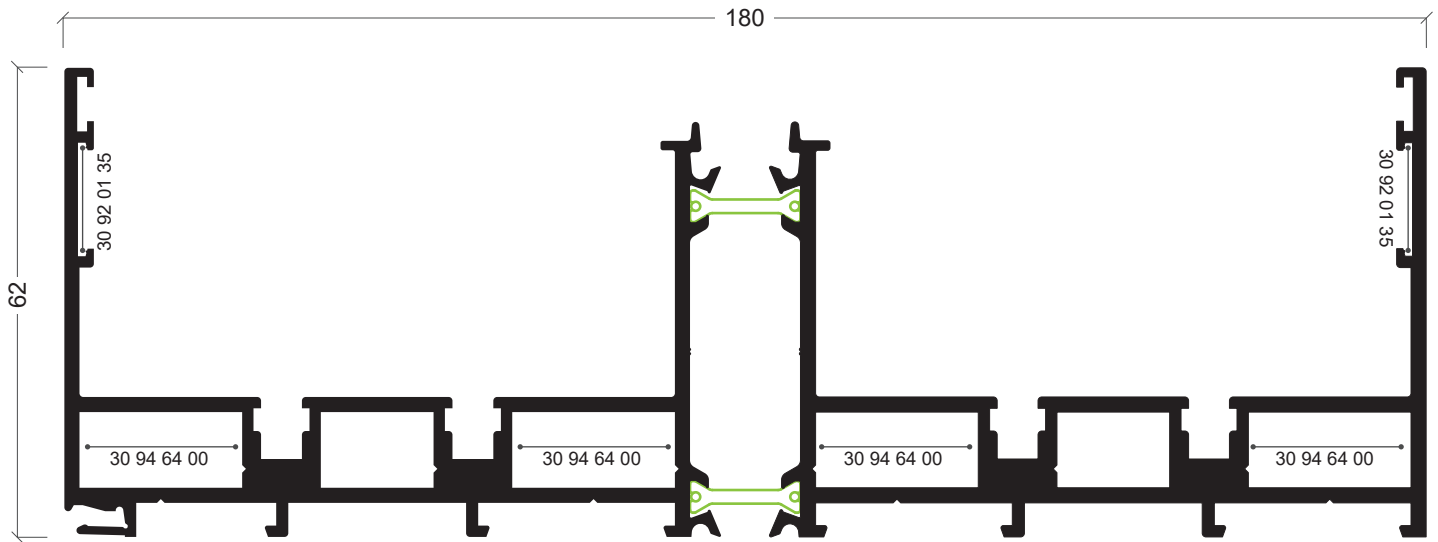

KL-49
Aro Fixo perimetral com clip
Marco Perimetral con clip

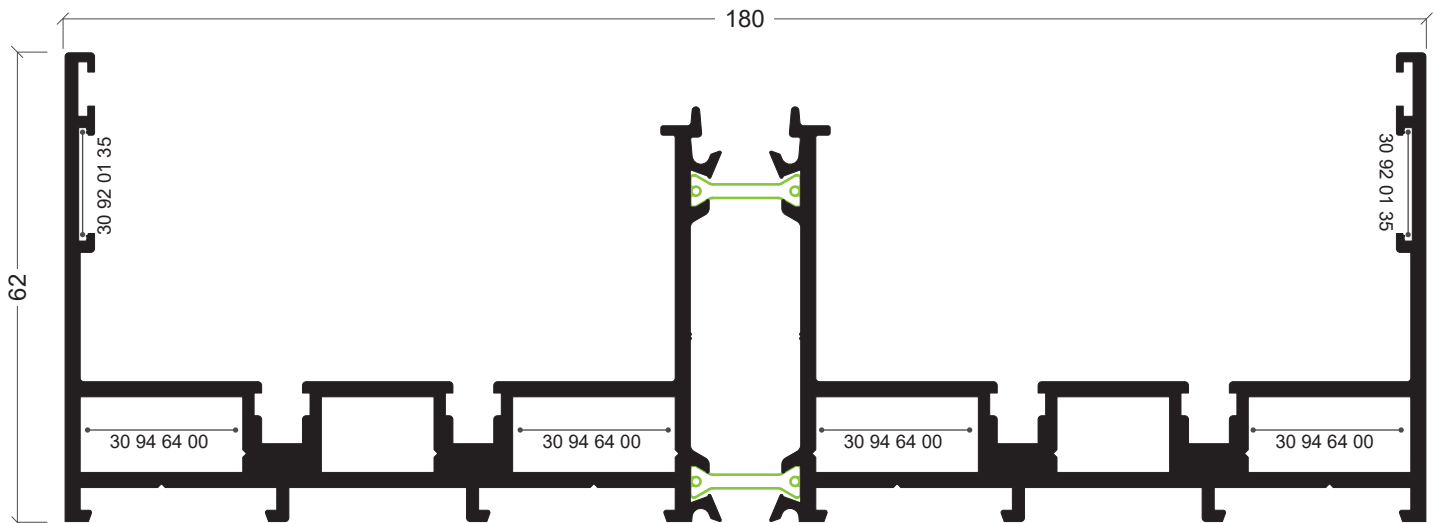

KL-51
Aro Fixo perimetral
Marco Perimetral

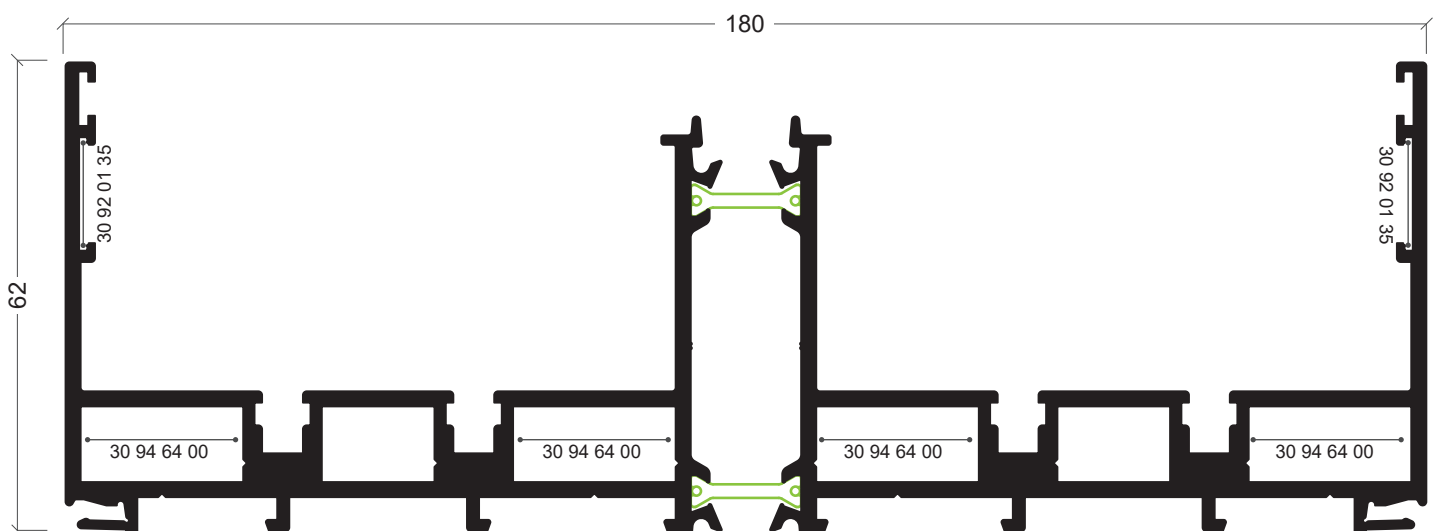

KL-50
Aro Fixo perimetral com duplo clip
Marco Perimetral con doble clip

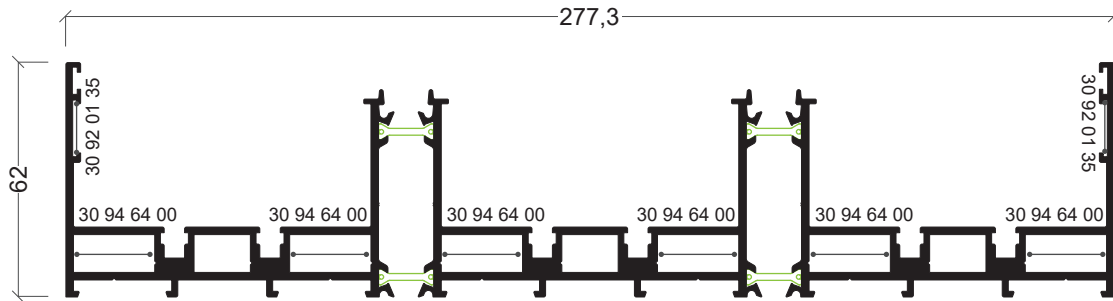

KL-73

Aro fixo perimetral tri-rail
Marco perimetral tricarril

Escala 1:2
Escala 1:2

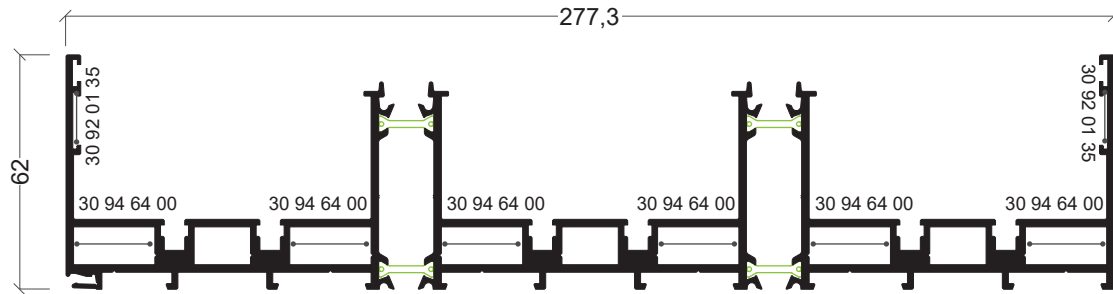

KL-74

Aro fixo perimetral tri-rail com clip
Marco Perimetral tricarril con clip

Escala 1:2
Escala 1:2

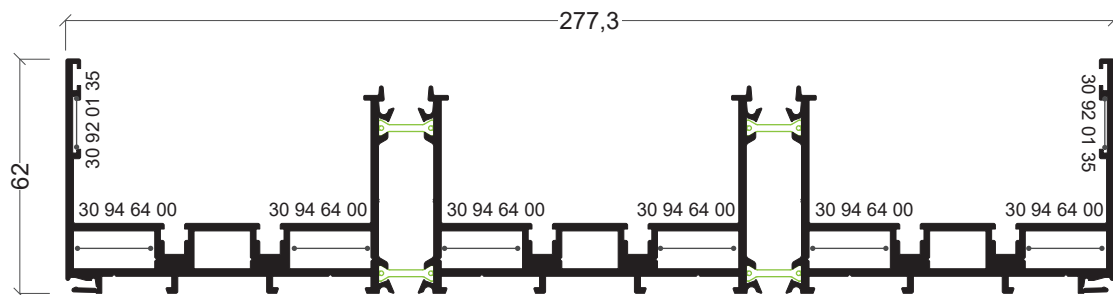

KL-75

Aro fixo perimetral tri-rail com duplo clip
Marco Perimetral tricarril con doble clip

Escala 1:2
Escala 1:2

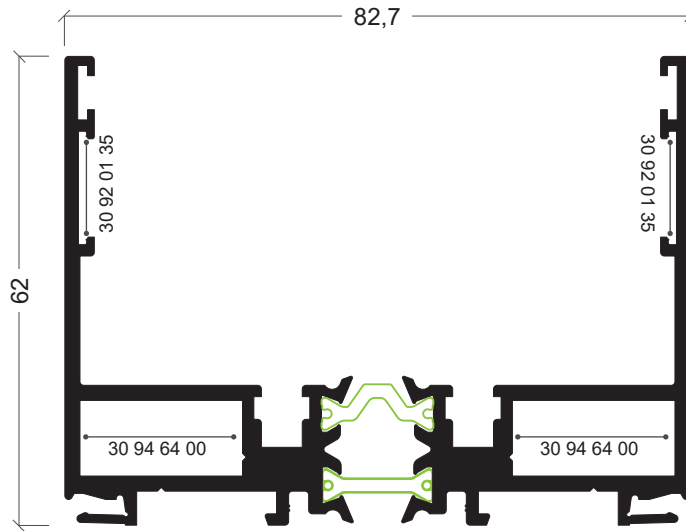

KL-90
Perfil mono-rail com duplo clip
Guia monorrail con doble clip

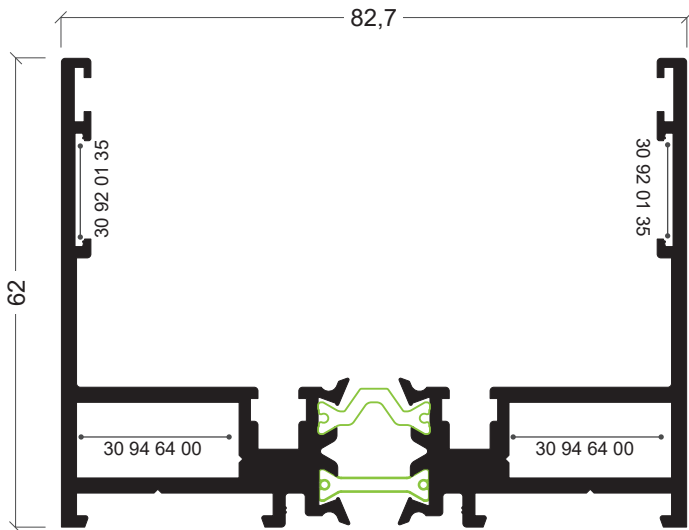

KL-91
Perfil mono-rail
Guia monorrail

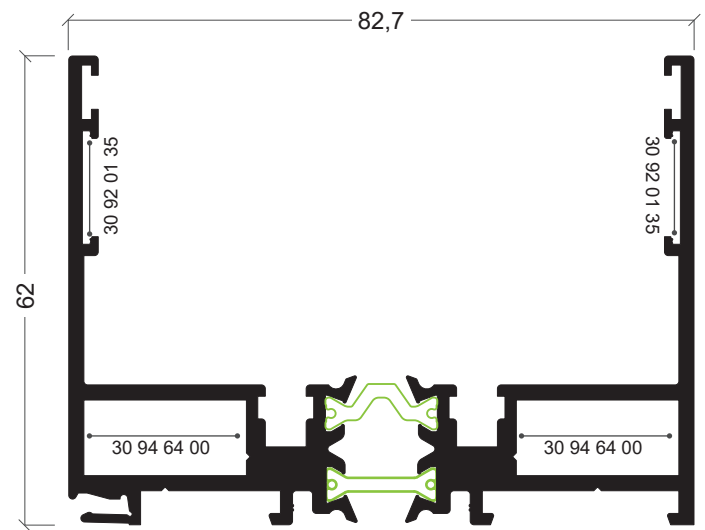

KL-92
Perfil mono-rail com clip
Guia monorrail con clip

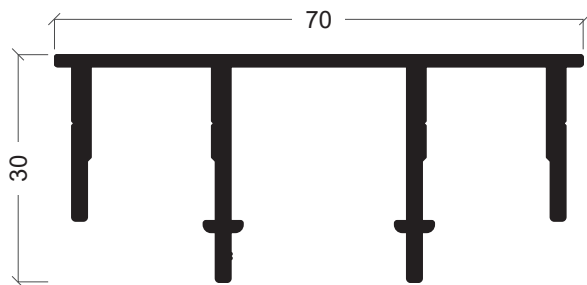

KL-55
Perfil suporte para folha fixa
Soporte para marco

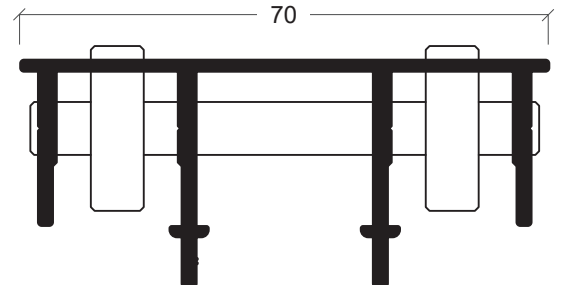

KL-55/RD
Perfil guia para folha
Guia para hoja

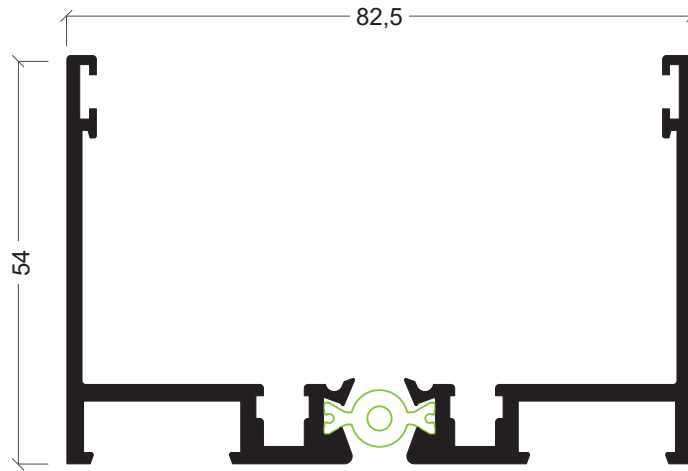

KL-82
Soleira/Padieira mono-rail
Solape monorrail

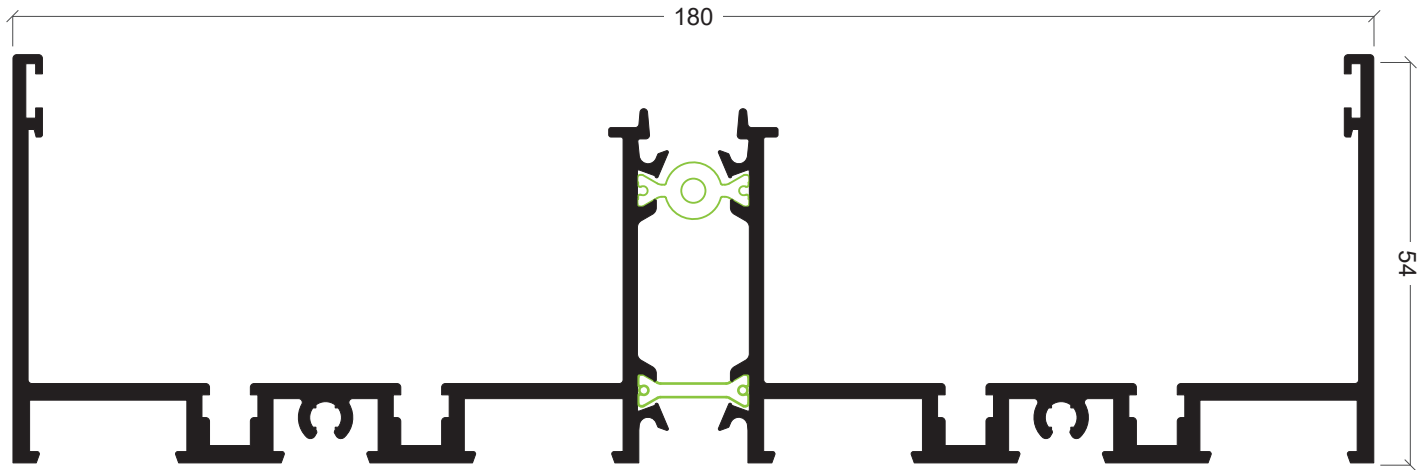

KL-83
Soleira/Padieira bi-rail
Solape bicarril

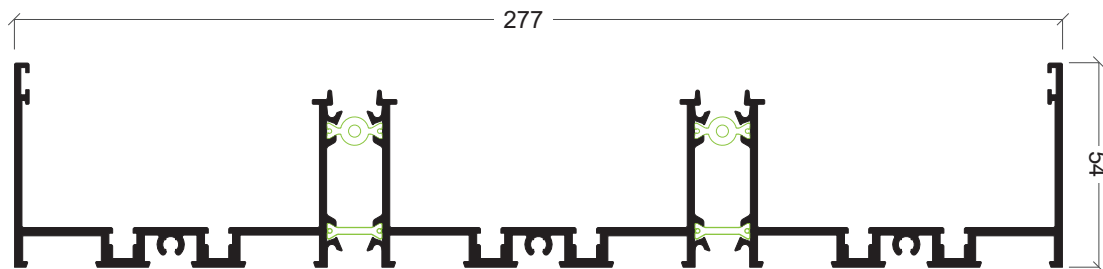

KL-84
Soleira/Padieira Tri-rail
Solape tricarril

Escala 1:2
Escala 1:2

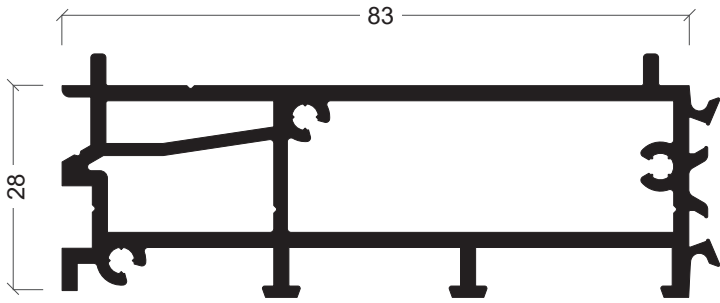

KL-93/A
Pré Aro mono-rail
Pré Marco monorrail

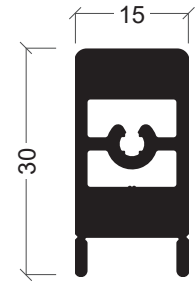

KL-87
Perfil de reforço
Refuerzo

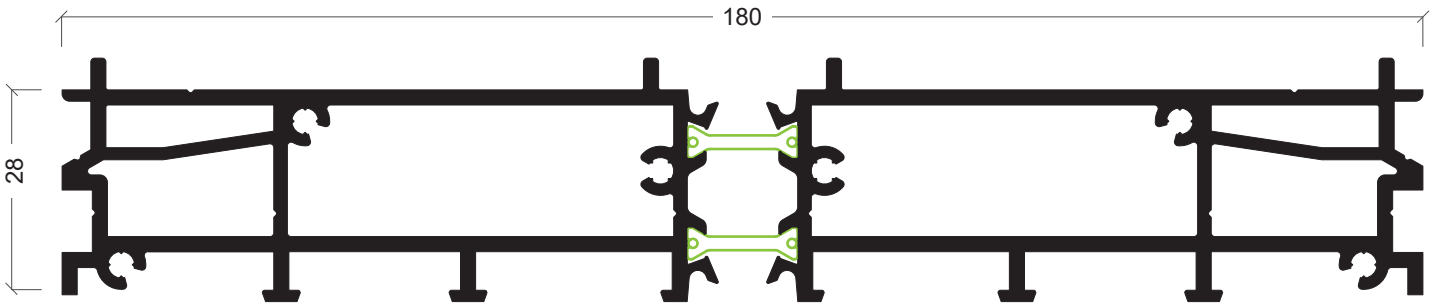

KL-93
Pré Aro bi-rail
Pré Marco bicarril

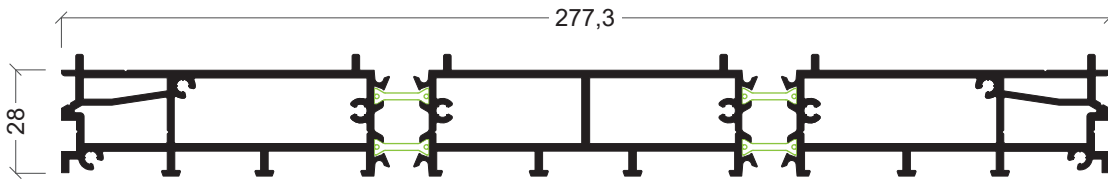

KL-94
Pré Aro tri-rail
Pré Marco tricarril

Escala 1:2
Escala 1:2

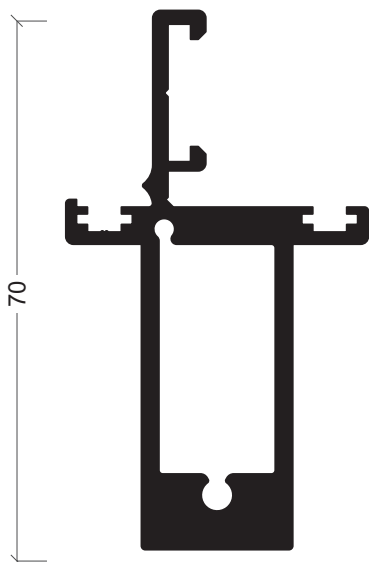

KL-86
Perfil central reforçado
Guia reforzado

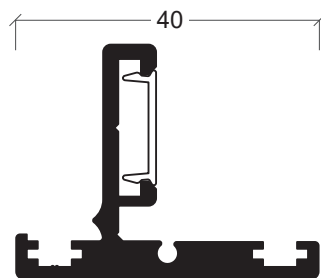

KL-85
Perfil Central
Guia central

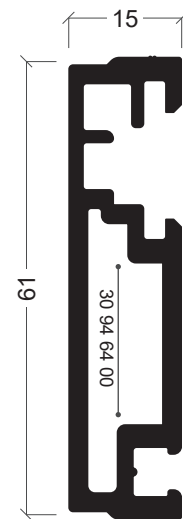

KL-60
Perfil mosquiteira
Perfil mosquitera

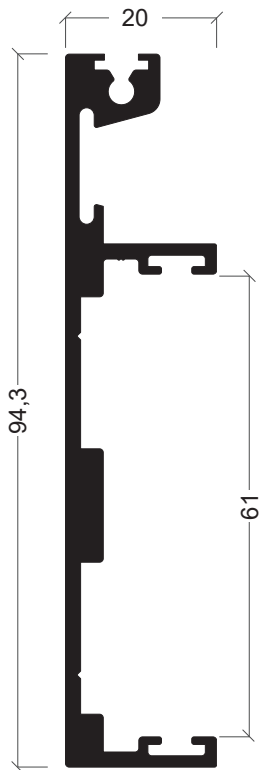

KL-59
Aro móvel central
Hoja central

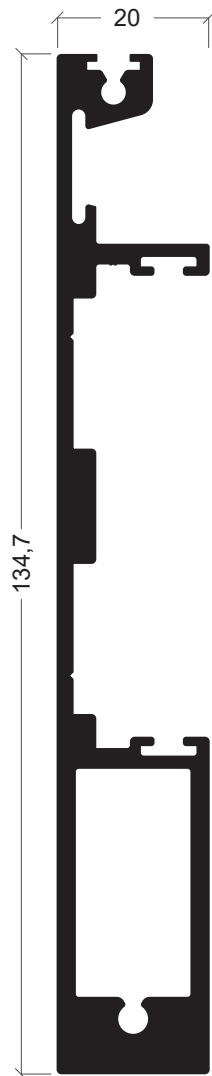

KL-52
Aro Móvel central reforçado
Hoja central reforzado

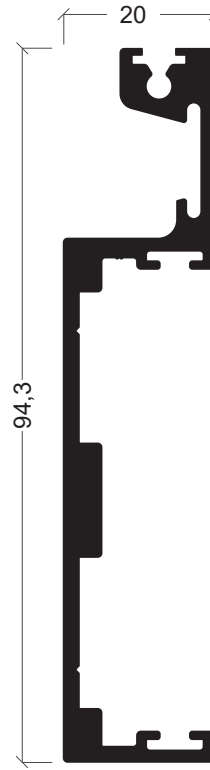

KL-64
Aro móvel central 3/4 folhas
Hoja central 3/4 hojas

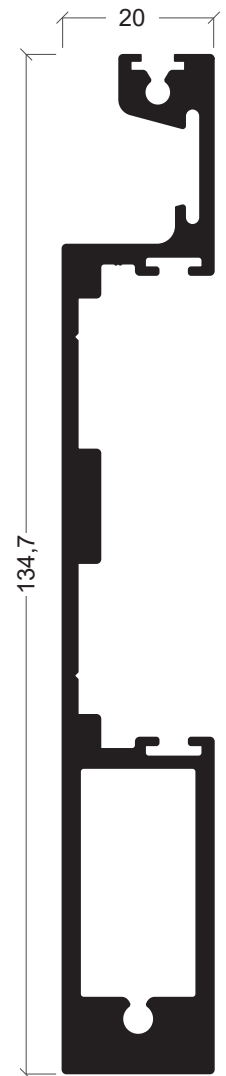

KL-62
Aro Móvel central reforçado 3/4 folhas
Hoja central reforzado 3/4 hojas

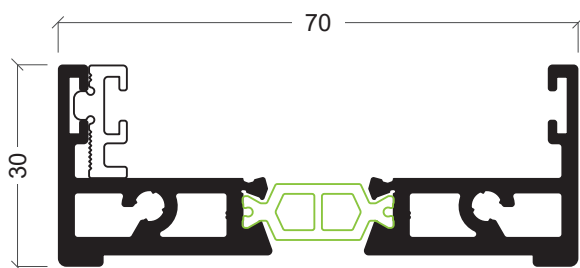

KL-57
Aro móvel superior/inferior
Hoja superior/inferior



KL-71
Redutor
Reductor

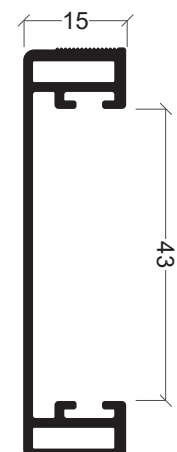

KL-81
Redutor
Reductor

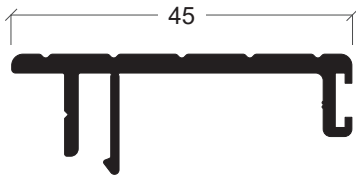

KL-67
Tampa lateral para soleira embutida rasa
Tapa lateral para solape incrustada rasa

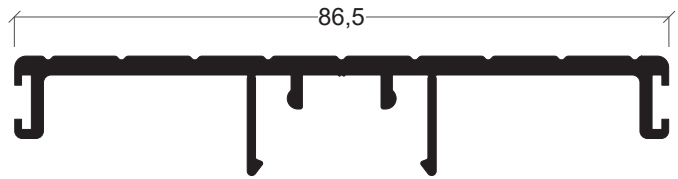

KL-68
Tampa central para soleira embutida rasa
Tapa central para solape incrustada rasa

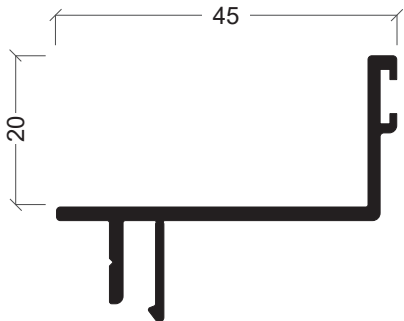

KL-65
Tampa lateral para soleira embutida
Tapa lateral para solape incrustada

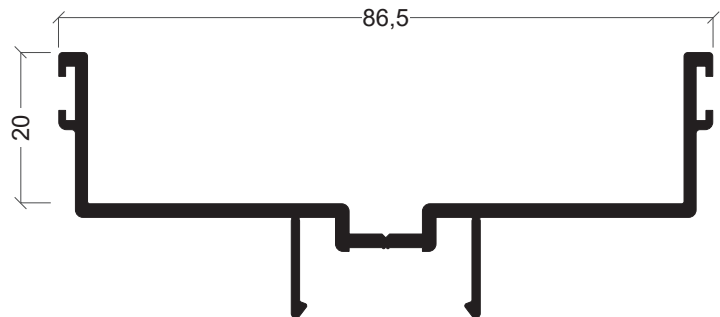

KL-66
Tampa central para soleira embutida
Tapa central para solape incrustada

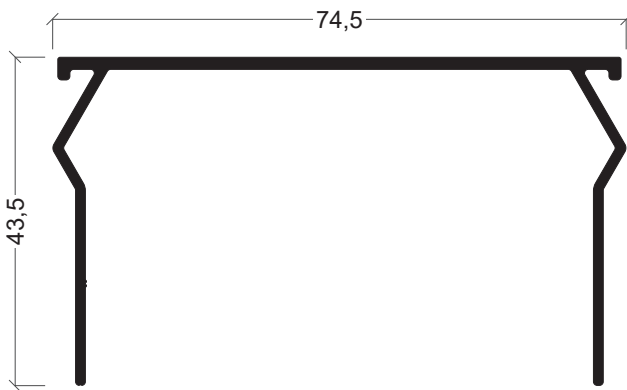

KL-63
Perfil Tampa
Embelecedor

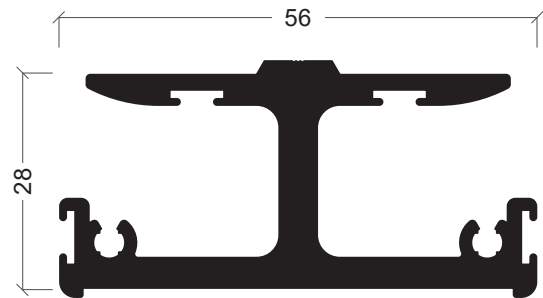

KL-70
Soleira embutida
Solape incrustada

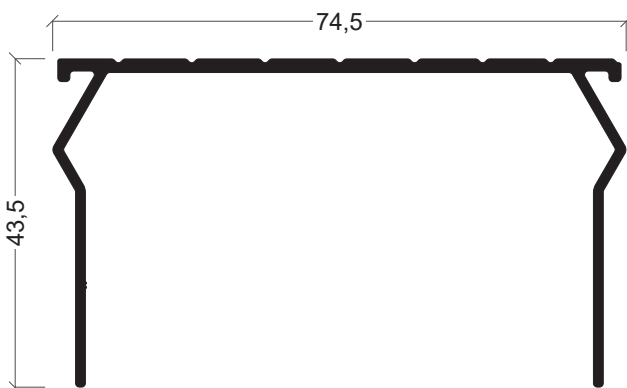

KL-69
Perfil Tampa
Perfil Tampa

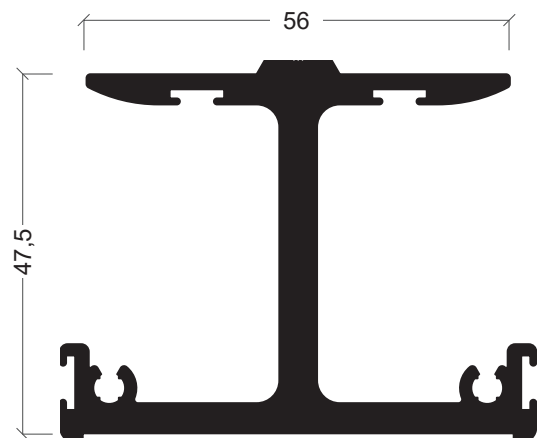

KL-54
Soleira embutida
Solape incrustada

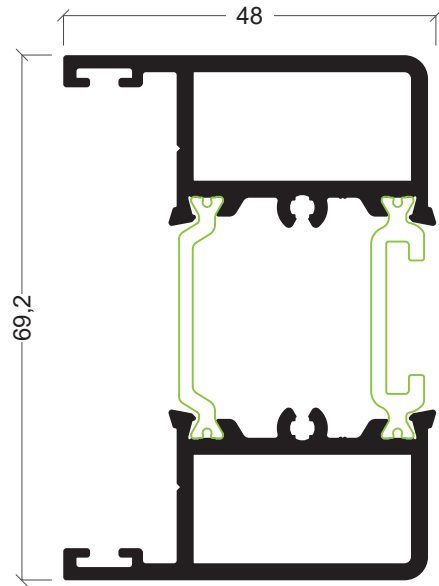

KL-53
Aro móvel lateral
Hoja lateral

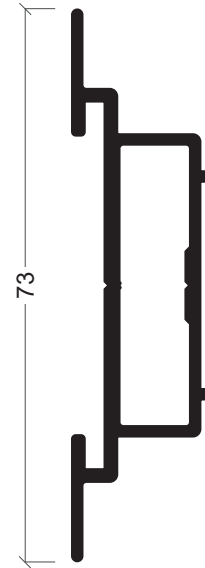

KL-58
Ombreira para fechos
Umbral para cierre

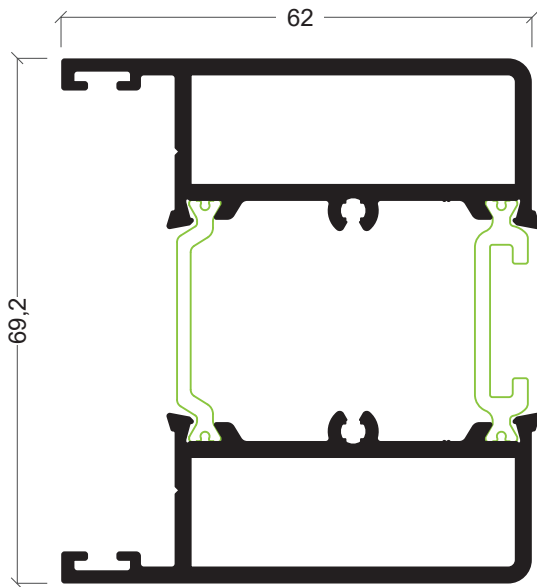

KL-78
Aro móvel para fechadura
Hoja para cierre

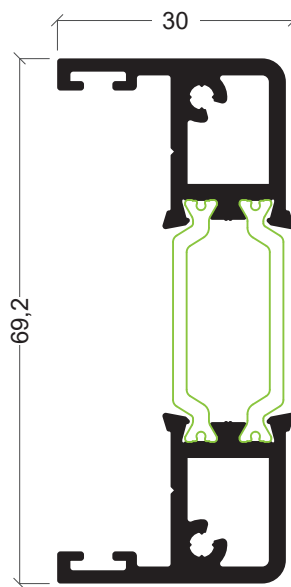

KL-72
Aro móvel lateral para motor
Hoja lateral para motor

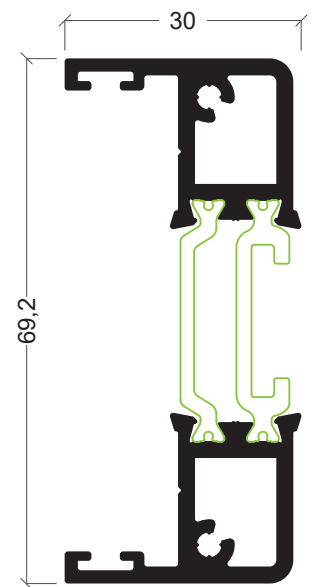

KL-56
Aro móvel lateral
Hoja lateral

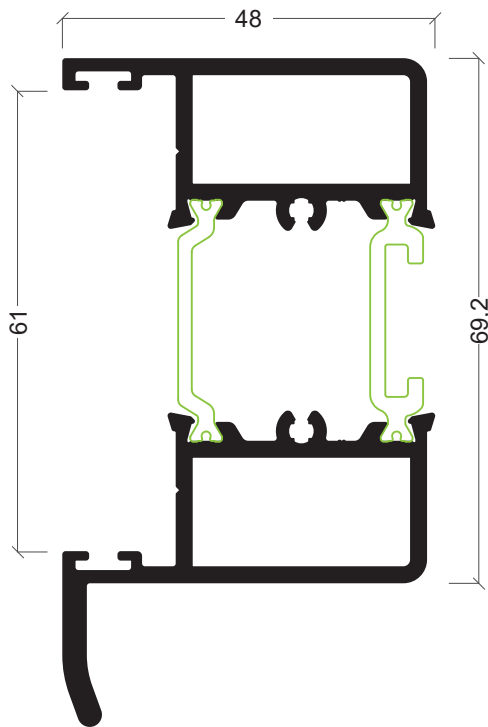

KL-76
Aro móvel lateral
Hoja cierre

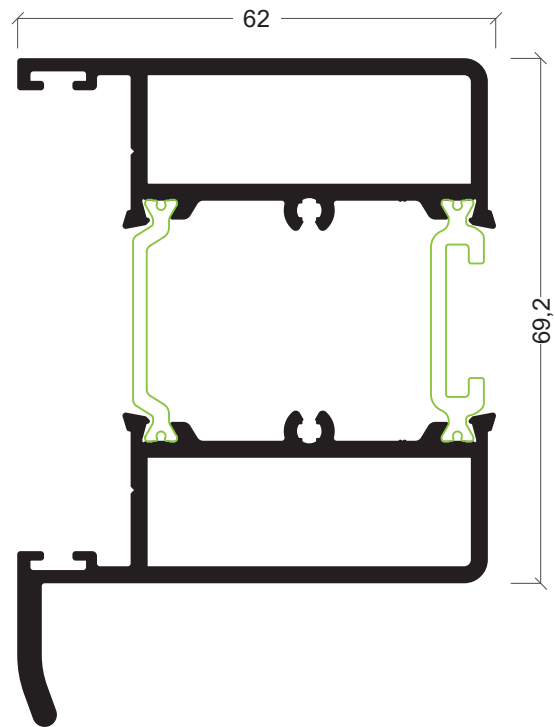

KL-79
Aro móvel para fechadura
Hoja para cierre

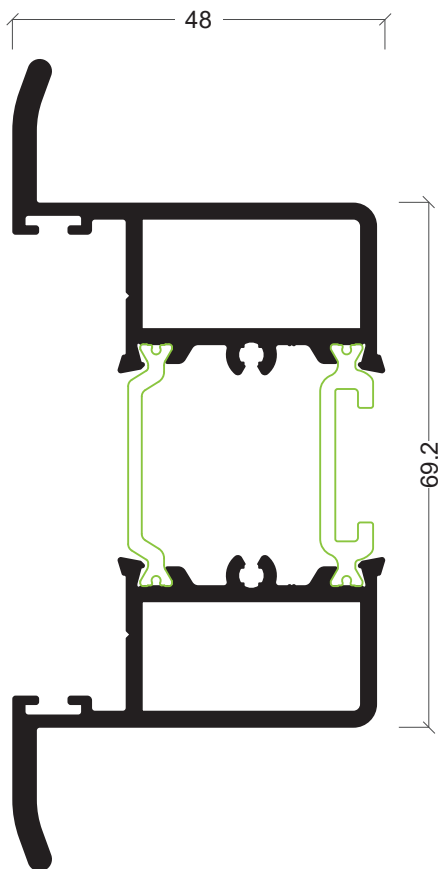

KL-77
Aro móvel lateral
Hoja lateral

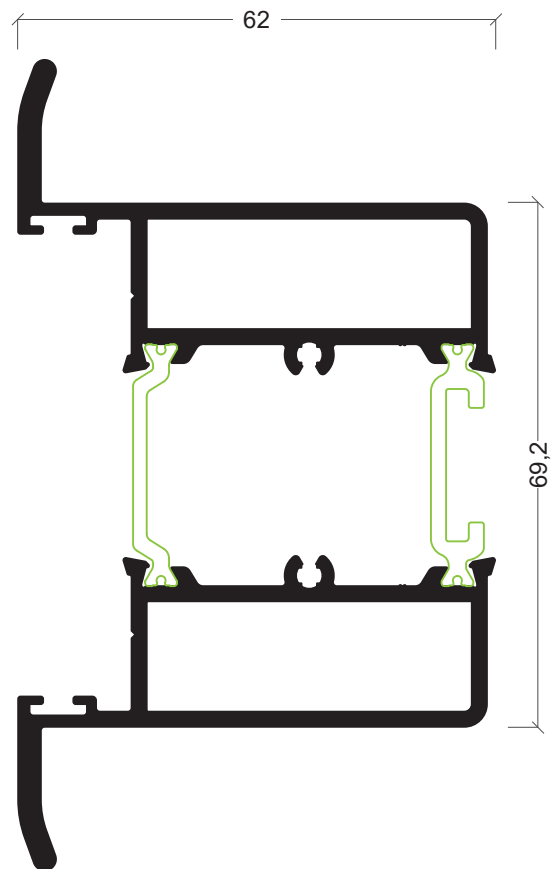

KL-80
Aro móvel para fechadura
Hoja para cierre

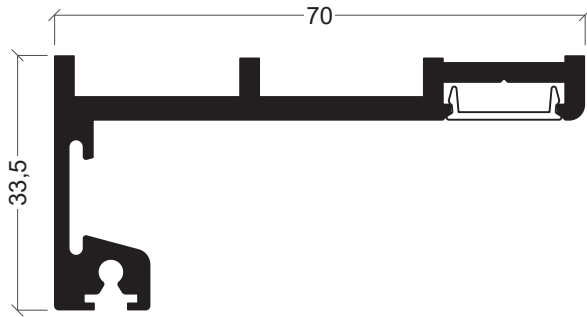

KL-48

Prumo de cruzamento
Remate de aislamiento

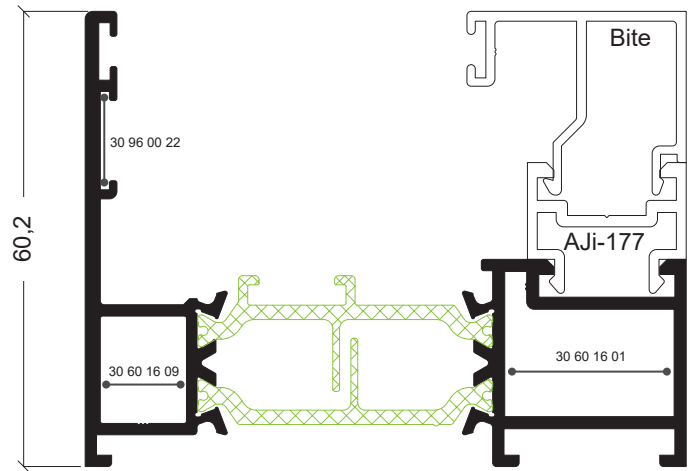

APi-103

Aro Fixo
Marco

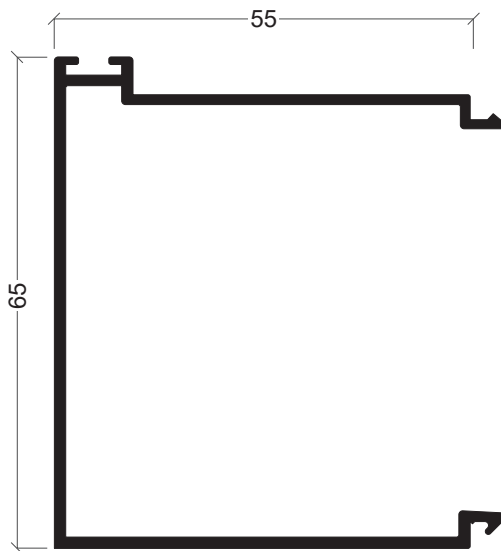

CW-29

Remate de Galandage
Remate de aislamiento

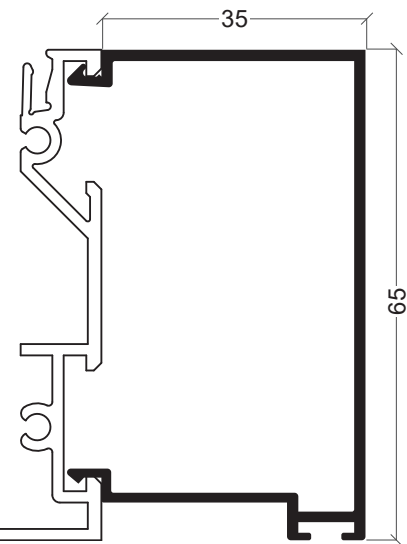

CW-12

Remate de Galandage
Remate de aislamiento

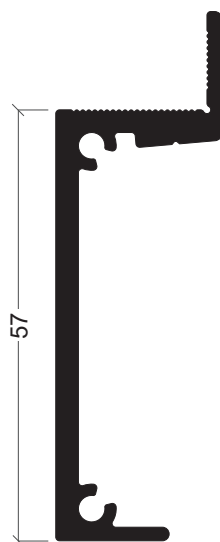

KL-46

Remate de Galandage
Remate de aislamiento

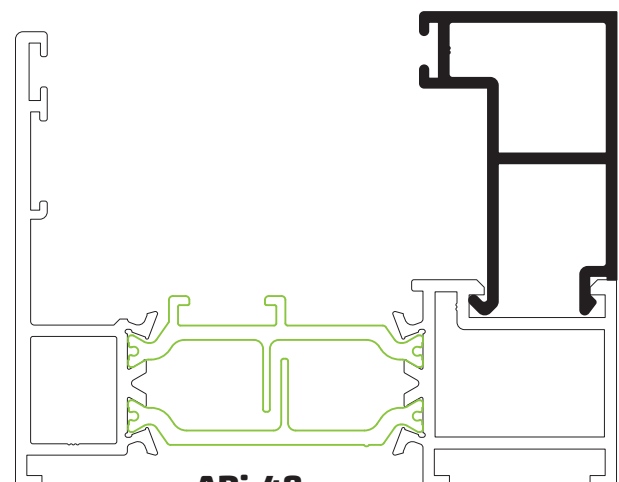

ARi-48

Bite
Bite

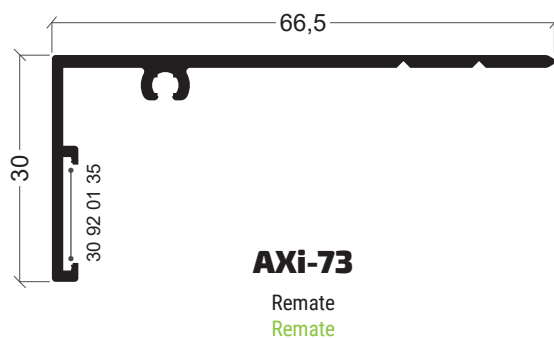
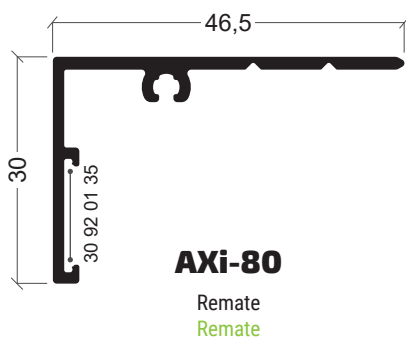
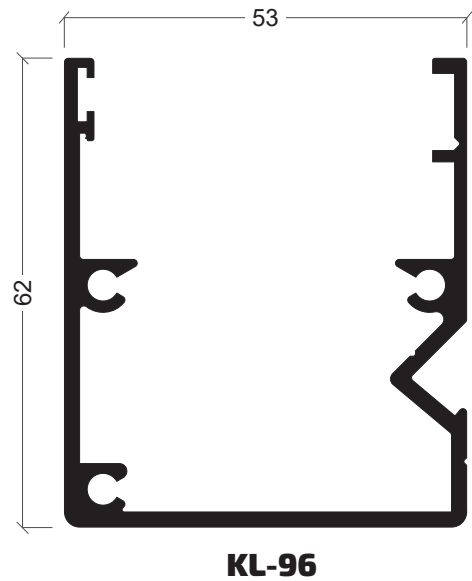
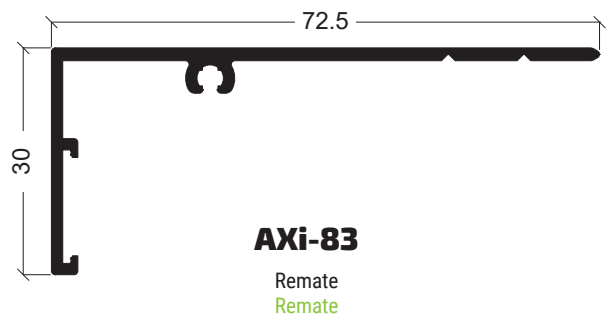
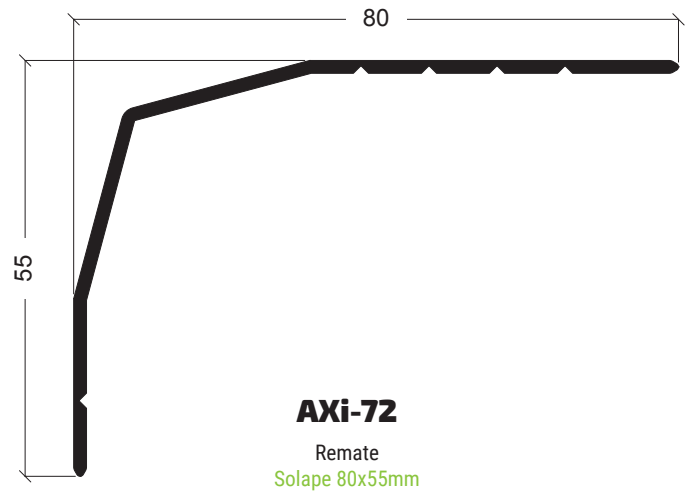
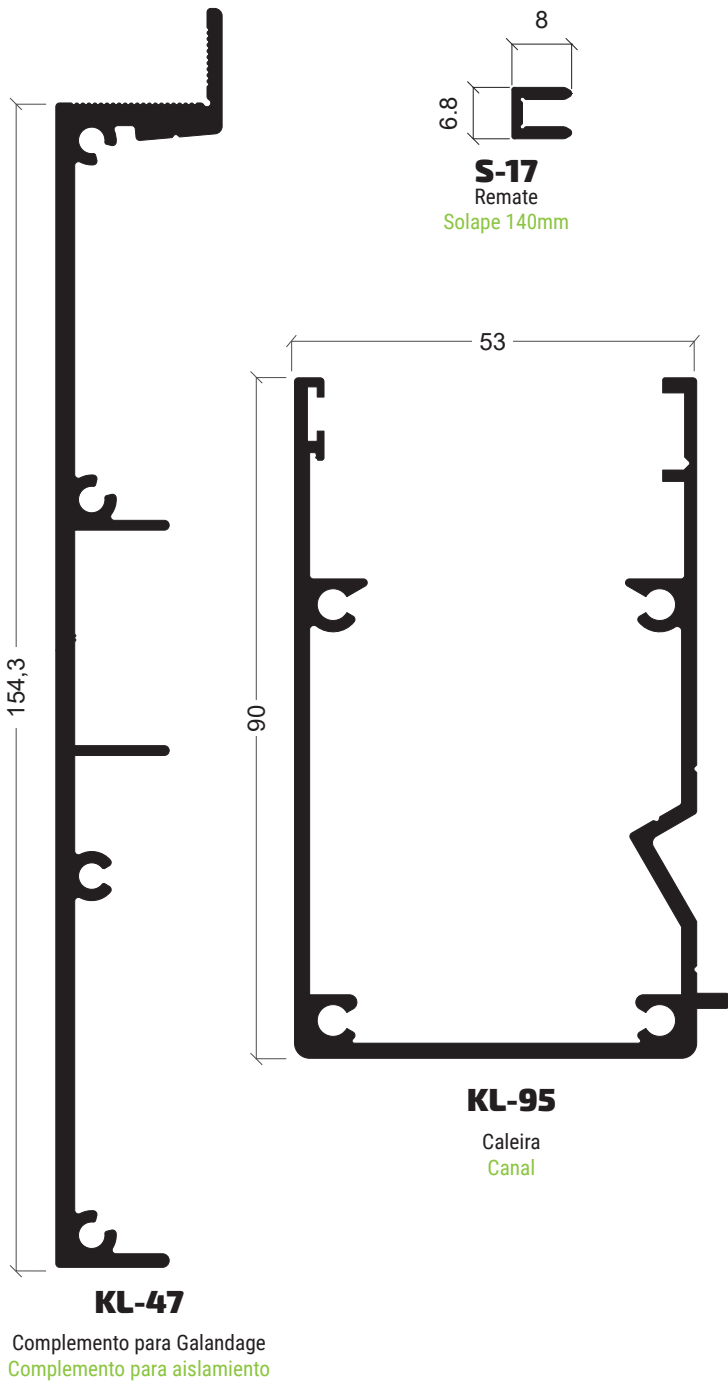



KL-04

Tampa
Tope

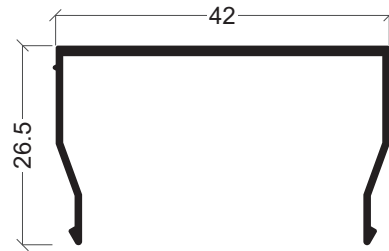

KL-13/R

Tampa c/ furação
Tapa c/ furação



AX-19

Vareta
Pletina

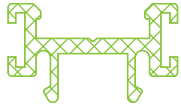

KL-06

Perfil polímero central
Perfil polímero central

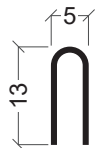

CTe-03

Guia carril (aço inox 304)
Guia marco carril inf. (AISI 304)

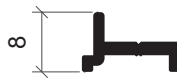

CT-94

Perfil União
Perfil União

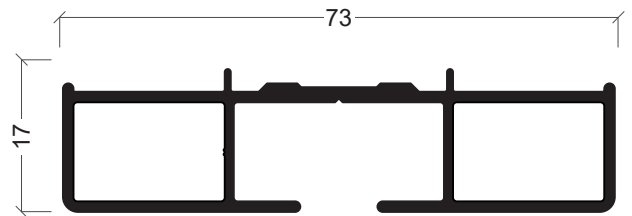

KL-88

Perfil para motor telescópico
Perfil para motor telescópico

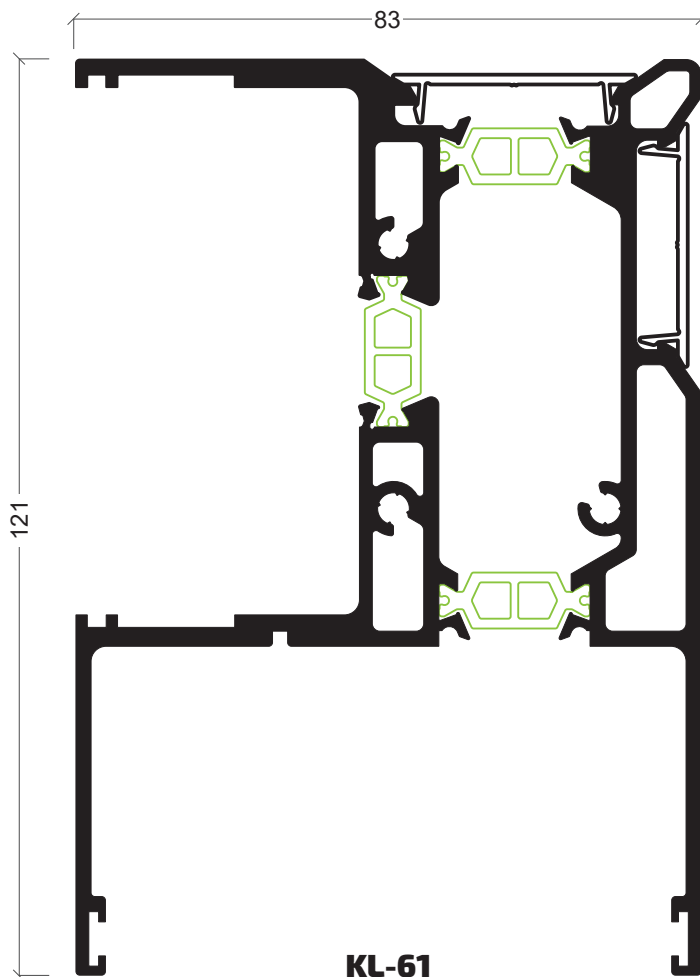

KL-61

Perfil canto
Perfil canto

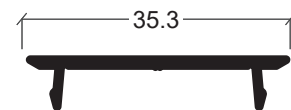

KL-16

Tampa
Tapa

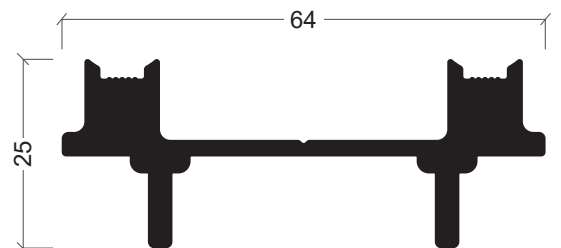

KL-97

Perfil guia Prime MagLev
Guia para Prime MagLev

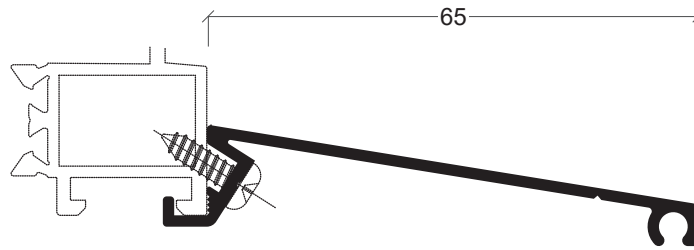

CT-30

Soleira
Solape

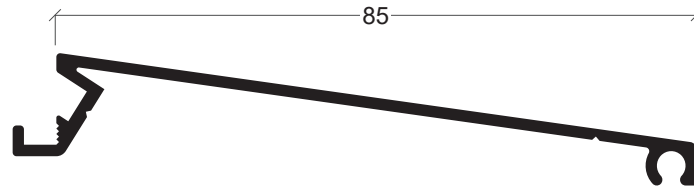

CT-31

Soleira
Solape

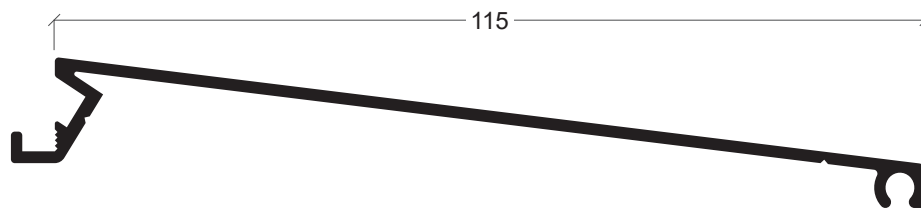

CT-32

Soleira
Solape

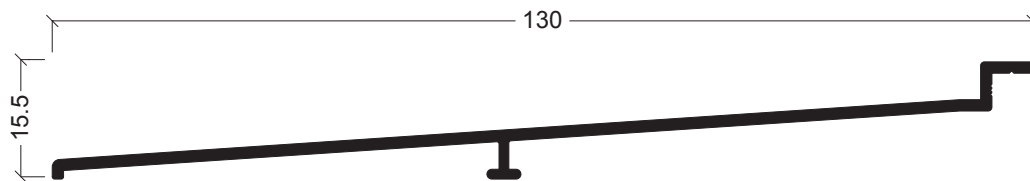

AZ-24

Soleira
Solape

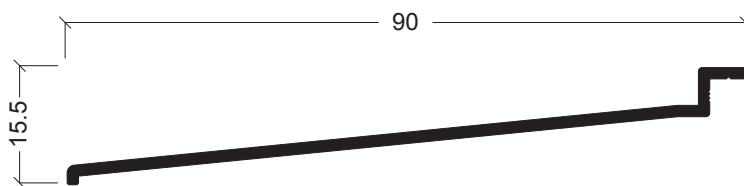

AZ-23

Soleira
Solape

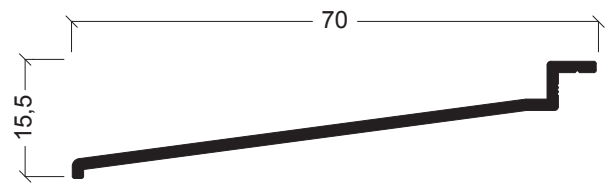

AZ-30

Soleira
Solape

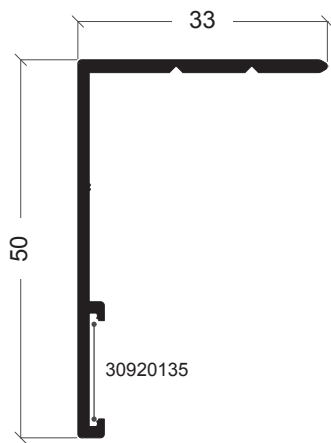

S-20
Remate
Solape 33x50mm

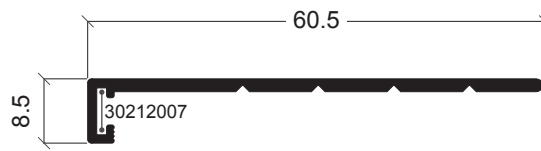

S-21
Remate
Solape 60.5x8,5mm

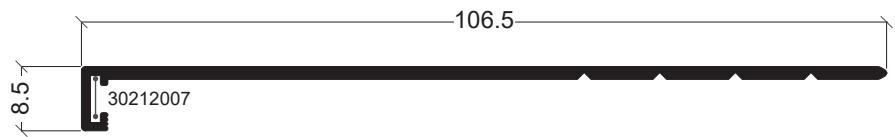

S-22
Remate
Solape 106.5x8.5mm

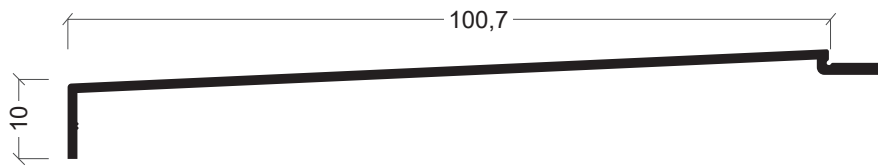

S-15
Remate
Solape 100x10mm

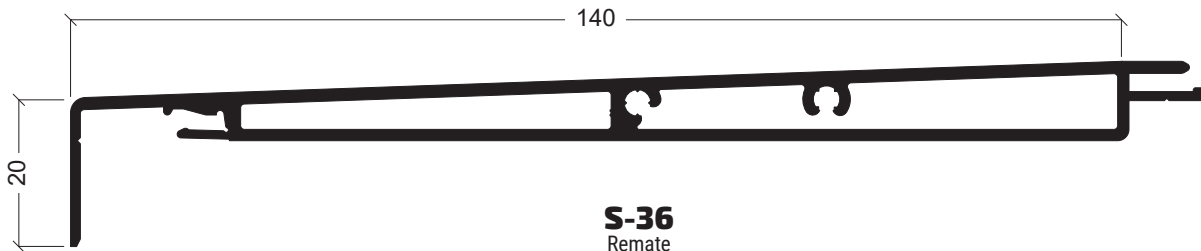

S-36
Remate
Solape 140mm

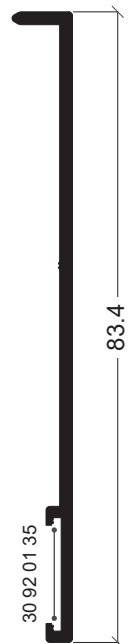

S-14
Remate
Solape 83,4mm



S-18
Remate
Solape 73,4mm



S-37
Remate
Solape 68,4mm

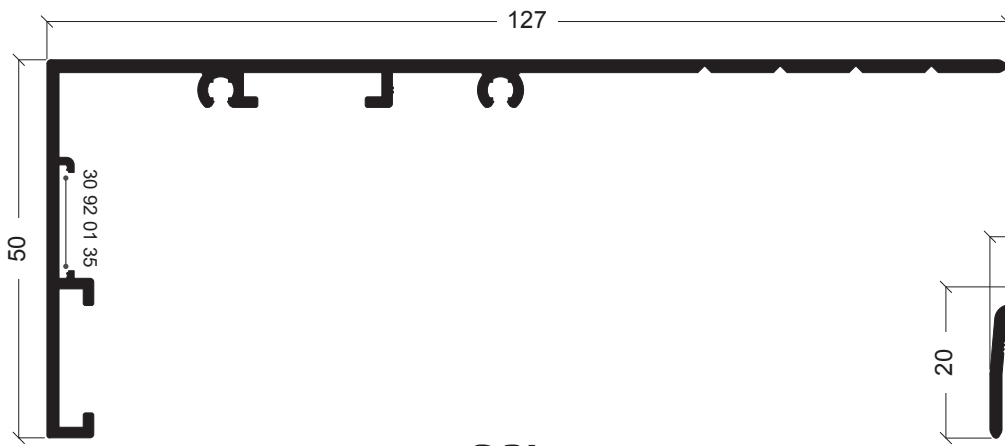

S-24
Remate
Solape 127x50mm

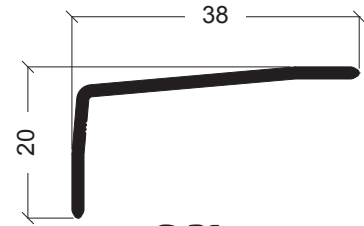

S-31
Remate
Solape 38x20mm

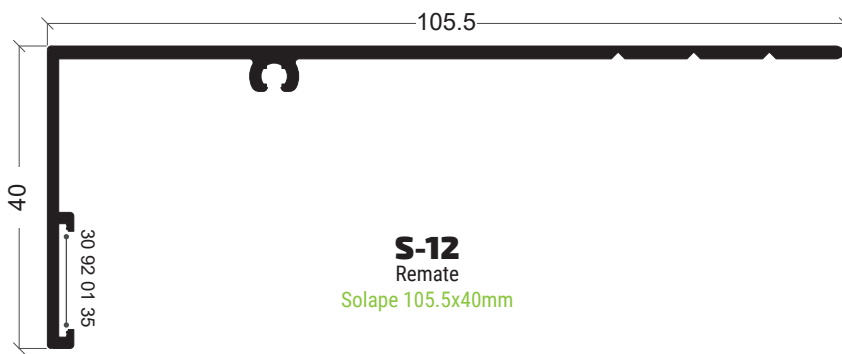

S-12
Remate
Solape 105.5x40mm

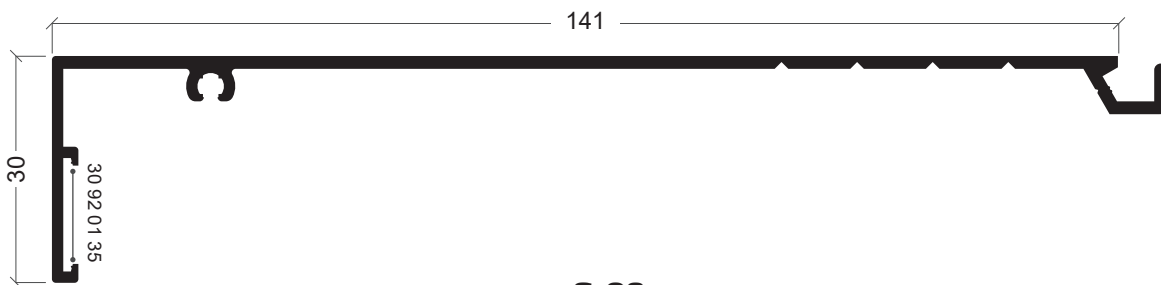

S-09
Remate
Solape 141x30mm

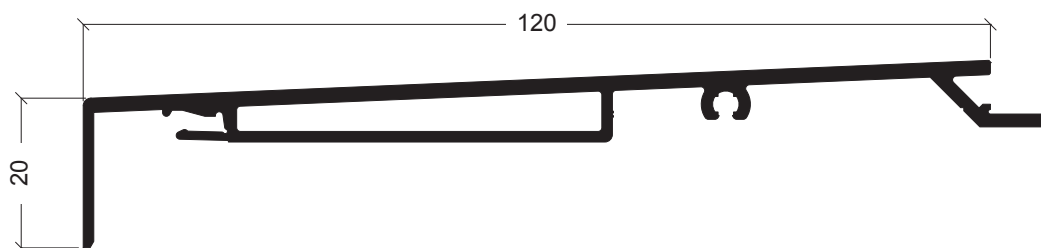

S-23
Remate
Solape 120x20mm

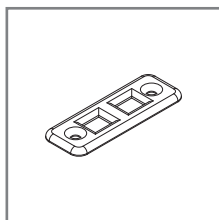

30 24 30 75

Contra-fecho inox aplicar com fechos lisos
Contra cierre doble inferior inox

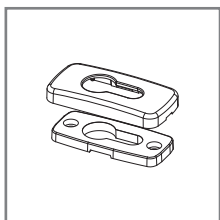

30 60 16 55/56/57

Escudo de alumínio branco/preto/2AC
Escudo de alumínio blanco/negro

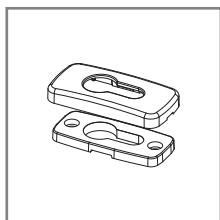

30 60 16 58/59

Escudo de alumínio champ ac/inox ac
Escudo de alumínio champ ac/ inox ac

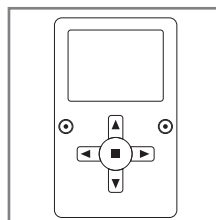

30 90 90 04

Comando para programação
Comando para programaión

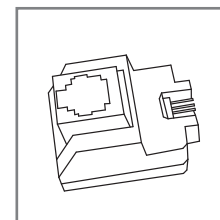

30 90 90 05

Modulo de ligação para WIFI e programação
Modulo de ligação para WIFI e programación

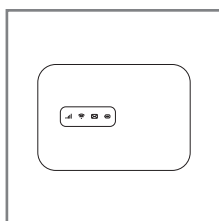

30 90 90 06

Modulo WIFI
Modulo WIFI

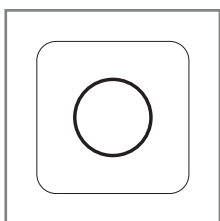

30 90 90 07

Interruptor CLEAN c/fonte 12V
Interruptor CLEAN c/fonte 12V

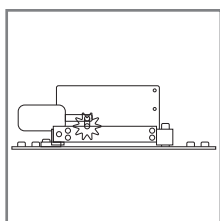

30 90 90 08

Motor 1F/2F p/ligações domótica
Motor 1F/2F c/ conexión domótica

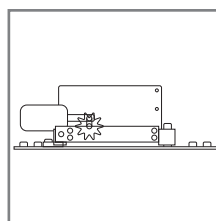

30 90 90 09

Motor telescópico p/ligações domótica
Motor telescópico 1F/2F c/ conexión domótica

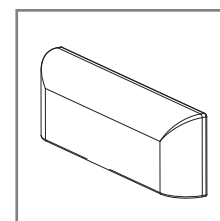

30 92 01 00/01

Goteira preto/branco
Tapa salida de aguas negro/blanco

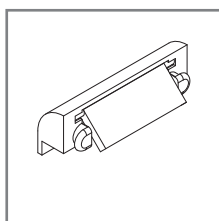

30 92 01 02/03

Goteira com válvula preto/branco
Vierteaguas con agujero negro /blanco

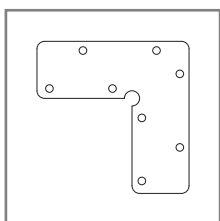

30 92 01 35

Esquadro de alinhamento
Escuadra de alineamiento

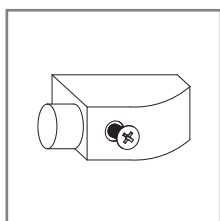

30 94 50 20

Limitador de abertura
Limitador apertura

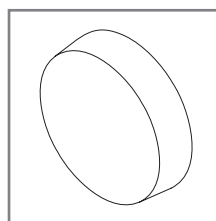

30 94 50 36

Tampa preta para parafuso cabeça de queijo 9.3
Tapa negra para tornillo

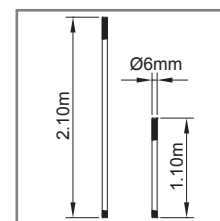

30 94 60 31

Conjunto varão alumínio 3m
Conj. varilla aluminio 3mts

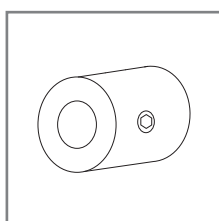

30 94 60 32

Guiador para varão por cada 500 mm
Guiador Varilla

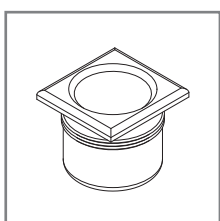

30 94 60 34

Contra-fecho central para puxador 3/4 F
+ central (preto)
Contracierre central negro

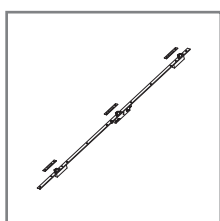

30 94 60 36

Fechadura 3 pontos sem canhão para correr
Cierre Kristal 3 puntos sin bombillo para
corredera

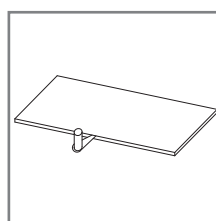

30 94 60 62

Calço para vidro 1mm
Calço para vidrio 1mm

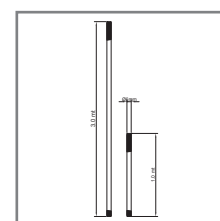

30 94 60 80

Conjunto varão inox roscado (4m)
Conjunto varilla roscada inox(4m)

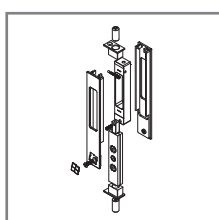

30 94 61 45/46/47

Fecho Puxador central branco/preto/natural
Cierre manilla central blanco/negro/natural

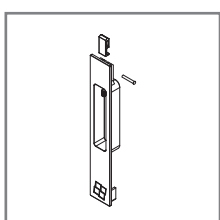

30 94 61 48/49/50

Puxador cego central branco/preto/natural
Manilla ciega central blanca/negra/natural

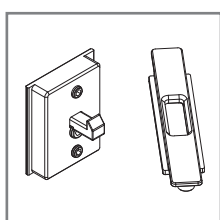

30 94 61 75

Conjunto ponto de fecho Gravity
Conjunto punto de cierre Gravity

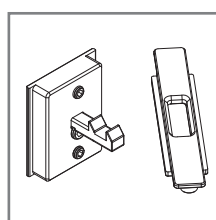

30 94 61 76

Conjunto Micro-ventilação Gravity
Conjunto micro-ventilación Gravity

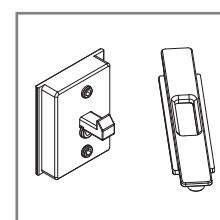

30 94 61 85

Conjunto ponto de fecho Gravity Inox
Conjunto punto de cierre Gravity Inox

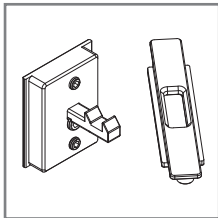

30 94 61 86

Conjunto Micro-ventilação Gravity Inox
Conjunto micro-ventilación Gravity Inox

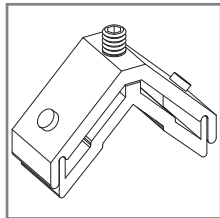

30 94 64 00

Esquadro Aro Fixo
Ecuadra

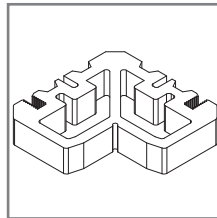

30 94 64 01

Esquadro para angulo 90
Fijación lateral montante

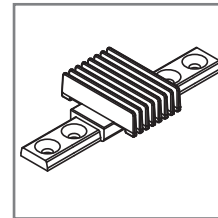

30 94 64 02

Corta-Vento
Cortaviento

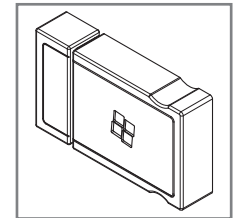

30 94 64 05/06/07

Fecho central 4F branco/preto/2AC
Cierre central 4F blanco/negro/2AC

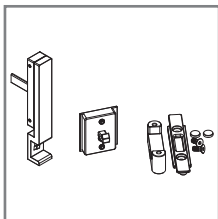

30 94 64 10/11/12

Fecho Gravity Prime branco/preto/2AC
Cierre Gravity Prime blanco/negro/2AC

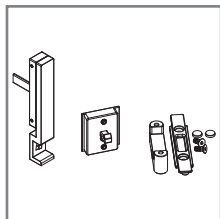

30 94 64 13/14/15

Fecho Gravity Prime manual branco/preto/2AC
Cierre Gravity Prime manual blanco/negro/2AC

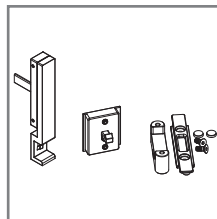

30 94 64 16/17/18

Fecho Gravity Prime Inox branco/preto/2AC
Cierre Gravity Prime Inox blanco/negro/2AC

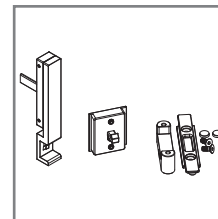

30 94 64 19/20/21

Fecho Gravity Prime manual Inox branco/
preto/2AC
Cierre Gravity Prime manual Inox blanco/
negro/2AC

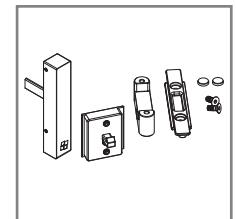

30 94 64 22/23/24

Fecho sem Aba Gravity Prime branco/preto/
natural
Cierre sin aba Gravity Prime blanco/negro/
natural

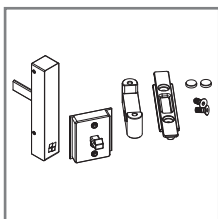

30 94 64 25/26/27

Fecho sem Aba Gravity Prime manual branco/
preto/natural
Cierre sin aba Gravity Prime manual blanco/
negro/natural

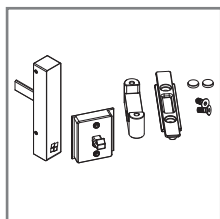

30 94 64 28/29/30

Fecho sem Aba Gravity Prime Inox branco/
preto/natural
Cierre sin aba Gravity Prime Inox blanco/negro/
natural

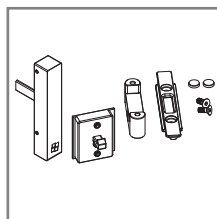

30 94 64 31/32/33

Fecho sem Aba Gravity Prime manual Inox
branco/preto/natural
Cierre sin aba Gravity Prime manual Inox blanco/
negro/natural

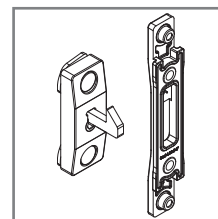

30 94 64 35

Conjunto fecho central Gravity
Conjunto cierre central Gravity

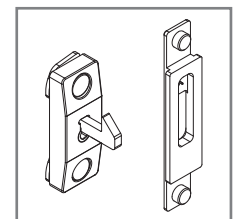

30 94 64 36

Conjunto fecho central Gravity Inox
Conjunto cierre central Gravity Inox

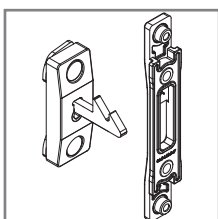

30 94 64 37

Conjunto Micro-Ventilação central Gravity
Conjunto Micro-Ventilación central Gravity

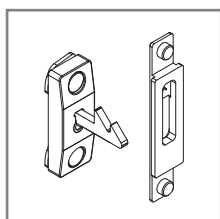

30 94 64 38

Conjunto Micro-Ventilação central Gravity Inox
Conjunto Micro-Ventilación central Gravity Inox

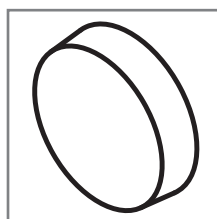

30 94 64 39

Batente
Tope

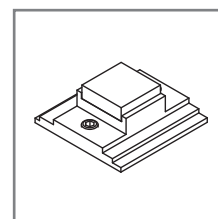

30 94 64 40

Batente lateral folha
Tope lateral

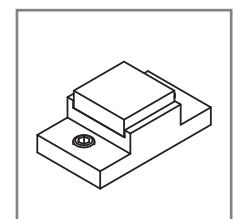

30 94 64 41

Batente central folha
Tope central

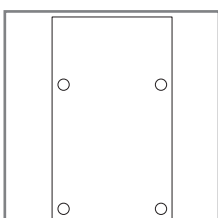

30 94 64 42

Topo caleira grande preto
Tope canal grande negro

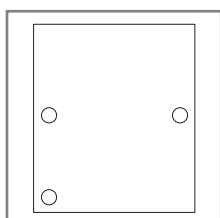

30 94 64 43

Topo caleira pequena preto
Tope canal pequena negro

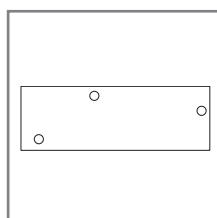

30 94 64 44

Topo pré-aro mono-rail preto
Tope ZZZZ negro

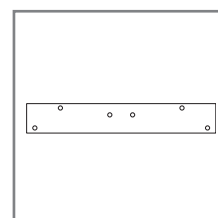

30 94 64 45

Topo pré-aro bi-rail preto
Tope pré marco bicarril negro

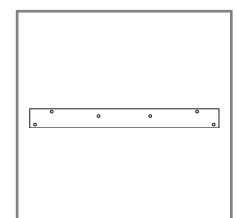

30 94 64 46

Topo pré-aro tri-rail preto
Tope pré marco tricarril negro

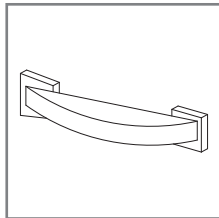

30 94 64 48

Deslizador
Deslizador

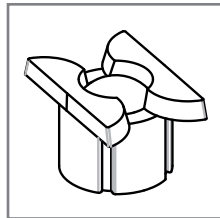

30 94 64 49

Goteira com válvula preta
Verteaguas con defletor negra

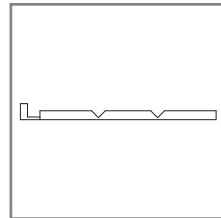

30 94 64 50/51/52

Calço para vidro 4x20/5x20/6x20
Calço para vidrio 4x20/5x20/6x20

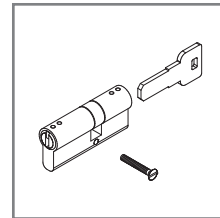

30 94 64 54

Canhão
Bombillo

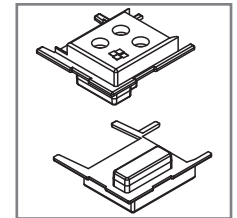

30 94 64 55

Conjunto topo canto preto
Conjunto tope canto negro

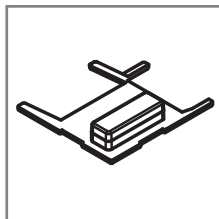

30 94 64 56

Topo Canto Embutida
Tope canto incrustada

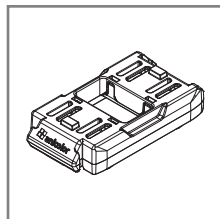

30 94 64 60

Rolamento Prime 250kg por rolamento
Rolamiento Prime 250Kg por rolamiento

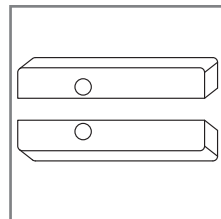

30 94 64 65/66/67

Conjunto topo central KL-85 branco/preto/2AC
Conjunto tope central KL-85 blanco/negro/2C

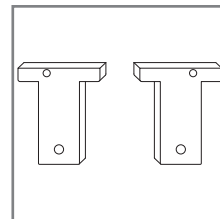

30 94 64 70/71/72

Conjunto topo central KL-86 branco/preto/2AC
Conjunto tope central KL-86 blanco/negro/2C

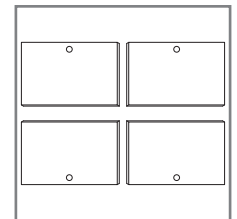

30 94 64 75

Kit juntas estanquidade KL-82
Kit juntas estanquidad KL-82

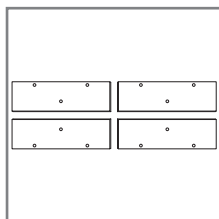

30 94 64 76

Kit juntas estanquidade KL-83
Kit juntas estanquidad KL-83

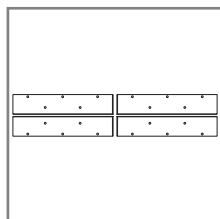

30 94 64 77

Kit juntas estanquidade KL-84
Kit juntas estanquidad KL-84

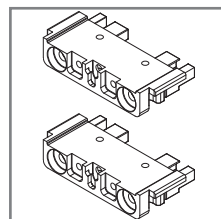

30 94 65 00/01/02

Conjunto ligação KL-52/59/62/64 branco/
preto/2AC
Conjunto ligación KL-52/59/62/64 blanco/
preto/2AC

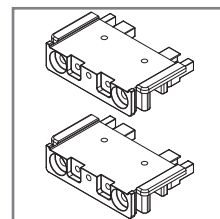

30 94 65 03/04/05

Conjunto ligação KL-56/72 branco/preto/2AC
Conjunto ligación KL-56/72 blanco/negro/2AC

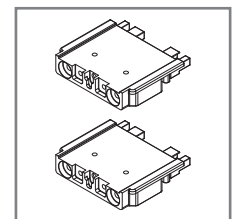

30 94 65 06/07/08

Conjunto ligação KL-53/77/76 branco/preto/2AC
Conjunto ligación KL-53/77/76 blanco/
negro/2AC

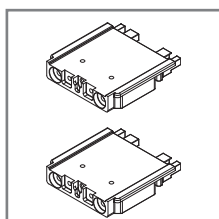

30 94 65 09/10/11

Conjunto ligação KL-78/79/80 branco/preto/2AC
Conjunto ligación KL-78/79/80 blanco/
negro/2AC

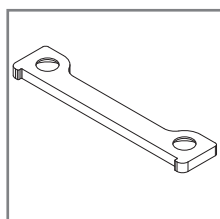

30 94 65 12

Topo Guia KL-70 preto
Tope Guia KL-70 negro

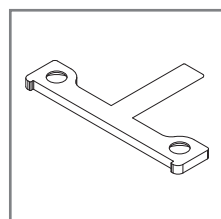

30 94 65 13

Topo Guia KL-54 preto
Tope Guia KL-54 negro

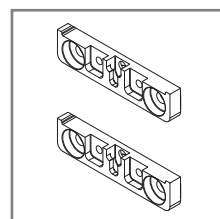

30 94 65 14

Conjunto ligação Galandage preto
Conjunto ligación Galandage negro

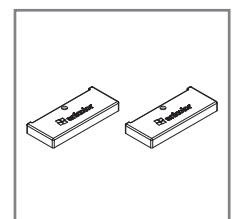

30 94 65 15/16/17

Conjunto Tampas (branco/preto/2AC)
Conjunto Tapas (blanco/negro/2AC)

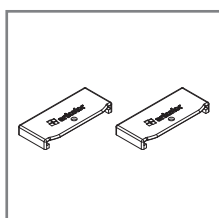

30 94 65 18/19/20

Conjunto Tampas Guia Embutida (branco/
preto/2AC)
Conjunto Tapas Guia Incrustada (blanco/
negro/2AC)

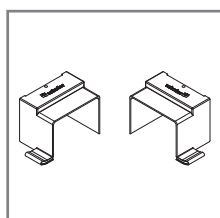

30 94 65 25/26/27

Conjunto Tampas KL-76 (branco/
preto/2AC)
Conjunto Tapas KL-76 (blanco/
negro/2AC)

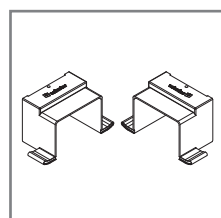

30 94 65 28/29/30

Conjunto Tampas KL-77 (branco/
preto/2AC)
Conjunto Tapas KL-77 (blanco/
negro/2AC)

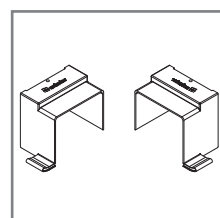

30 94 65 31/32/33

Conjunto Tampas KL-79 branco/
preto/2AC
Conjunto Tapas KL-79 blanco/negro/2AC

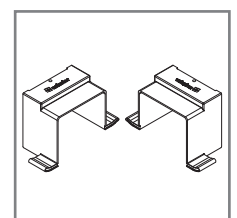

30 94 65 34/35/36

Conjunto Tampas KL-80 branco/
preto/2AC
Conjunto Tapas KL-80 blanco/negro/2AC

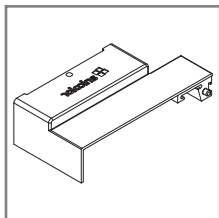

30 94 65 40/41/42

Tampa Esquerda KL-59 branco/preto/2AC
Tapa Esquerda KL-59 blanco/negro/2AC

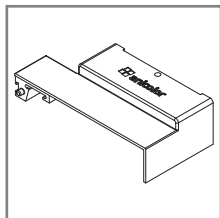

30 94 65 43/44/45

Tampa Direita KL-59 branco/preto/2AC
Tapa Derecha KL-59 blanco/negro/2AC

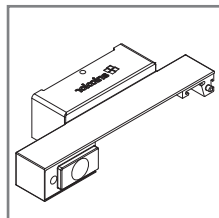

30 94 65 50/51/52

Tampa Esquerda KL-52 branco/preto/2AC
Tapa Izquierda KL-52 blanco/negro/2AC

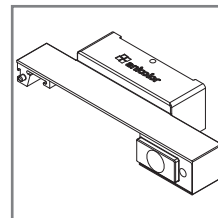

30 94 65 53/54/55

Tampa Direita KL-52 branco/preto/2AC
Tapa Derecha KL-52 blanco/negro/2AC

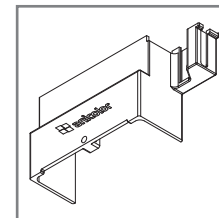

30 94 65 60/61/62

Tampa Esquerda KL-64 branco/preto/2AC
Tapa Izquierda KL-64 blanco/negro/2AC

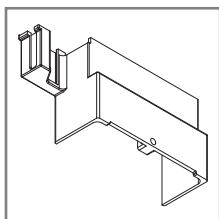

30 94 65 63/64/65

Tampa Direita KL-64 branco/preto/2AC
Tapa Derecha KL-64 blanco/negro/2AC

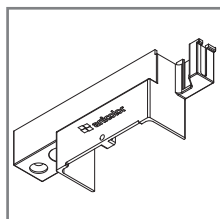

30 94 65 70/71/72

Tampa Esquerda KL-62 branco/preto/2AC
Tapa Izquierda KL-62 blanco/negro/2AC

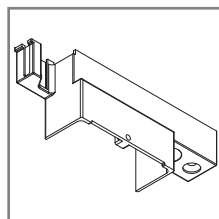

30 94 65 73/74/75

Tampa Direita KL-62 branco/preto/2AC
Tapa Derecha KL-62 blanco/negro/2AC

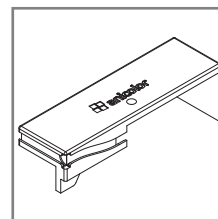

30 94 65/80/81/82

Tampa Esquerda KL-59 embutida branco/
preto/2AC
Tapa Izquierda KL-59 empotrada blanco/
negro/2AC

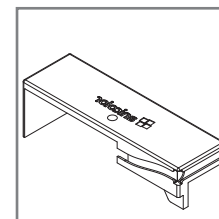

30 94 65 83/84/85

Tampa Direita KL-59 embutida branco/preto/2AC
Tapa Derecha KL-59 empotrada blanco/
negro/2AC

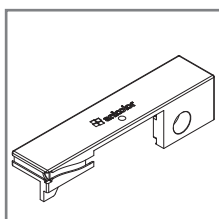

30 94 65 90/91/92

Tampa Esquerda KL-52 embutida branco/
preto/2AC
Tapa Izquierda KL-52 empotrada blanco/
negro/2AC

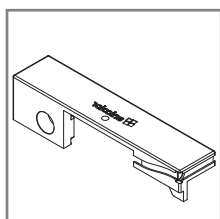

30 94 65 93/94/95

Tampa Direita KL-52 embutida branco/preto/2AC
Tapa Derecha KL-52 empotrada blanco/
negro/2AC

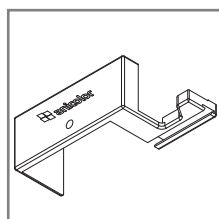

30 94 66 00/01/02

Tampa Esquerda KL-64 embutida branco/
preto/2AC
Tapa Izquierda KL-64 empotrada blanco/
negro/2AC

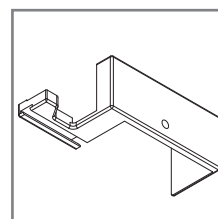

30 94 66 03/04/05

Tampa Direita KL-64 embutida branco/preto/2AC
Tapa Derecha KL-64 empotrada blanco/
negro/2AC

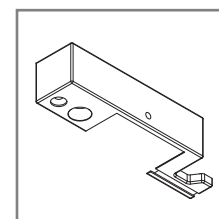

30 94 66 10/11/12

Tampa Esquerda KL-62 embutida branco/
preto/2AC
Tapa Izquierda KL-62 empotrada blanco/
negro/2AC

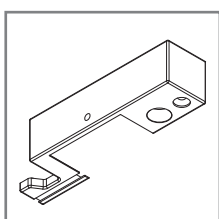

30 94 66 13/14/15

Tampa Direita KL-62 embutida branco/preto/2AC
Tapa Derecha KL-62 empotrada blanco/
negro/2AC

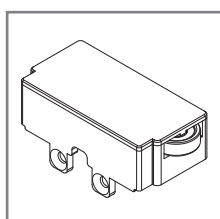

30 94 66 20

Carro guia
Carro guía

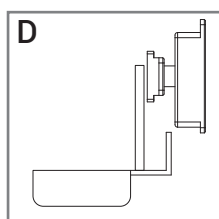

30 94 66 21/22/23

Conj. puxador direito Prime branco/preto/2AC
para perfil KL-56
Conj. manilla derecha Prime blanco/negro/2AC
para perfil KL-56

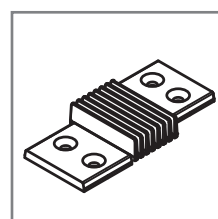

30 94 66 25

Corta-vento mono-rail
Cortaviento monorrail

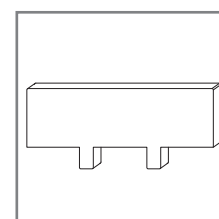

30 94 66 26

Junta de estanquidade para perfil de rolamentos
Junta de estanquidade para perfil de rolamientos

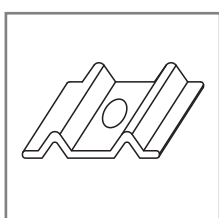

30 94 66 27

Mola para perfil de rolamento
Muelle para perfil de rolamiento

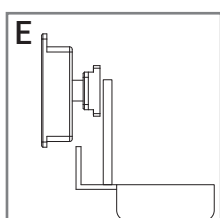

30 94 66 28/29/30

Conj. puxador esquerdo Prime branco/
preto/2AC para perfil KL-56
Conj. manilla izquierda Prime blanco/
negro/2AC para perfil KL-56

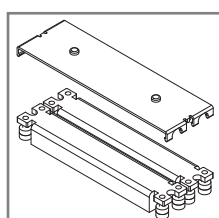

30 94 66 40

Deslizador magnetico Prime MagLev
Deslizador magnetico Prime MagLev

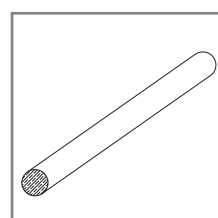

30 94 66 41

Varão calibrado magnetizado de 3m
Varilla calibrada magnetica de 3m

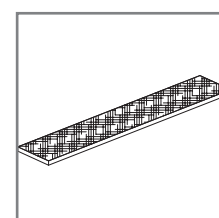

30 95 60 56

Barra de latão com 3m e fita adesiva
dupla face
Bar de latón com 3m e cinta adhesiva
dos lados

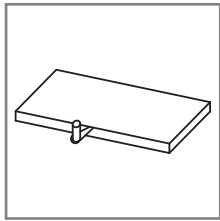
30 95 60 72/73/74/75

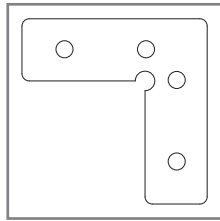
 Calço de vidro 2/30 3/30 4/30 5/30
 Calço de vidro 2/30 3/30 4/30 5/30

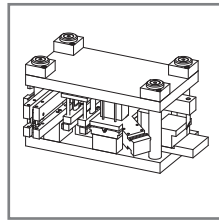
30 96 00 22

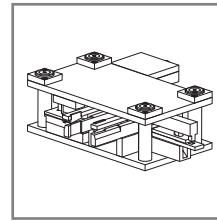
 Esquadro alinhamento
 Escuadra alineamiento

33 94 66 00

 Cunho Prime perimetral
 Troquel Prime perimetral

33 94 66 01

 Cunho Prime recto
 Troquel Prime Recto

REFERÊNCIA • REFERENCIA	DESENHO • DISEÑO	DESCRIÇÃO • DESCRIPCIÓN
30 60 00 17		Junta exterior plana vidro 2mm • Junta exterior plana vidrio 2mm
30 60 00 21		Junta para caleiras • Junta para canal
30 93 00 60		Junta exterior vidro 4mm • Junta exterior vidrio 4mm
30 93 00 61		Junta exterior vidro 2mm • Junta exterior vidrio 2mm
30 93 00 62		Junta exterior plana vidro 4mm • Junta exterior plana vidrio 4mm
30 93 00 65		Junta interior vidro 5mm • Junta interior vidrio 5mm
30 93 00 66		Junta interior vidro 4mm • Junta interior vidrio 4mm
30 93 00 67		Junta interior vidro 2mm • Junta interior vidrio 2mm
30 93 00 68		Junta interior vidro 6/7mm • Junta interior vidrio 6/7mm
30 93 00 69		Junta interior vidro 8/9mm • Junta interior vidrio 8/9mm
30 94 60 12		Pelúcia tri-fin • Burllete tri-fin
30 94 64 61		Junta de estanquidade • Junta de estanquiedad
30 94 64 80		Junta central termo-acústica • Junta central termo-acústica
30 94 64 81		Junta interior plana vidro 3mm • Junta interior plana vidrio 3mm
30 94 64 82		Junta interior plana vidro 5mm • Junta interior plana vidrio 5mm
30 94 64 83		Junta interior plana vidro 7mm • Junta interior plana vidrio 7mm
30 94 64 84		Junta interior plana vidro 9mm • Junta interior plana vidrio 9mm
30 95 00 10		Pelúcia 7x9 mm stop-fin • Burllete 7x9 mm stop-fin
30 95 00 30		Pelúcia 7x7 mm stop-fin • Burllete 7x7 mm stop-fin
30 95 00 40		Pelúcia 7x5.5 mm stop-fin • Burllete 7x5.5 mm stop-fin
30 95 00 50		Pelúcia 7x6 mm stop-fin • Burllete 7x6 mm stop-fin
30 95 60 02		Junta tapa canal • Junta tapa canal

Janela 2 folhas correr • Ventana 2 hojas corredera
PERFIS • PERFIS

DESENHO • DESEÑO	REF.	DESCRIÇÃO • DESCRIPCIÓN	CORTE CORTE	QUANTIDADE CANTIDAD	MEDIDAS • MEDIDA
	KL-51	Aro fixo Marco Fijo Doble		2	L
			2	H	
	KL-06 *	Separador fixo Separador poliamida central		2	L-98 mm
			2	H-98mm	
	KL-04	Tampa fixa Tapeta marco		4	(L/2)-125mm
			2	H-124mm	
	KL-58	Ombreira para fechos • Suplemento cierres		2	H-40mm
	AX-19	Vareta Pletina		2	H-93mm
	KL-63	Perfil tampa Embellecedor		2	H-37mm
	KL-55/RD	Perfil guia Rodamiento inferior		2	L (várias medidas)
	KL-57	Aro móvel inferior/superior Hoja inferior/superior		4	(L/2)-107mm
	KL-76	Aro móvel lateral Hoja lateral		2	H-93mm
	KL-52	Aro móvel central Hoja central con refuerzo		1	H-93mm
	KL-59	Aro móvel central Hoja central		1	H-93mm

* preferencialmente cortar juntamente com o perfil KL-51 • preferiblemente cortado junto con el perfil KL-51

ACESSÓRIOS E JUNTAS • ACCESORIOS Y JUNTAS

REF.	DESCRIÇÃO • DESCRIPTION	QUANTIDADE CANTIDAD
30 94 64 00	Esquadro Aro Fixo • Escuadra MARCO	16
30 91 01 35	Esquadro de alinhamento • Escuadra alineamiento especial	8
30 92 01 02	Goteira • Vierendeaguas blanco/negro	4
30 94 64 40	Batente Lateral • Batiente lateral	4
30 94 64 17	Fecho Gravity Inox • Cierre Gravity Inox	2
30 94 61 85	Conjunto fecho Gravity • Conjunto cierre Gravity	2
30 94 61 86	Conjunto fecho microventilação Gravity • Conj. cierre microventilación Gravity	2
30 94 65 07	Conjunto ligação KL-76 • Conjunto ligación KL-76	2
30 94 65 01	Conjunto ligação KL-52/59 • Conjunto ligación KL-52/59	2
30 94 66 20	Carro Guia • Carro guía	4
30 95 60 56	Barra de latão • Bar de latão	2L
30 94 64 02	Corta-vento • Cortaviento	2
30 94 65 26	Conjunto tampas KL-76 • Conjunto tapas KL-76	2
30 94 65 41	Tampa esq. KL-59 • Tapa izq. KL-59	1
30 94 65 44	Tampa dir. KL-59 • Tapa der. KL-59	1
30 94 65 51	Tampa esq. KL-52 • Tapa izq. KL-52	1
30 94 65 54	Tampa dir. KL-52 • Tapa der. KL-52	1
30 94 64 51	Calço 5x20 • Calzo 5x20	8
30 94 60 73	Calço 3mm • Calzo 3mm	12
30 94 64 80	Junta Central • Junta central	2H
30 95 60 02	Junta tapa canal • Junta tapa canal	4L
---	Junta vidro exterior • Junta vidrio exterior	2L+4H
---	Junta vidro interior • Junta vidrio interior	2L+4H
30 95 00 40	Pelúcia • Burlete	8L+4H
30 95 00 50	Pelúcia • Burlete	2H
30 94 64 49	Goteira com válvula preta • Vierendeaguas con deflector negro	8

VIDRO • VIDRIO

Espessura total máxima 56mm • Espesor máximo 56mm

Hv= H-116mm	Lv= (L/2) - 83mm
-------------	------------------

Aplicar intercalar do tipo Warm Edge • Selagem secundária do vidro duplo em silicone • Sellado secundario de doble vidrio de silicona
 Aplicar vidro duplo ou triplo com bordos arestados • Aplicar vidrio doble o triple con bordos rugosos

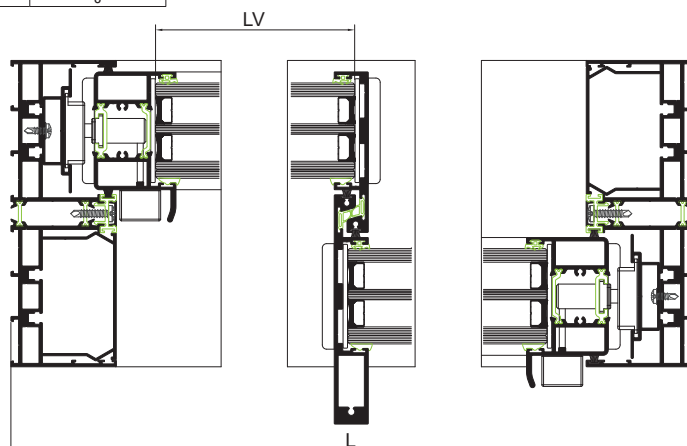
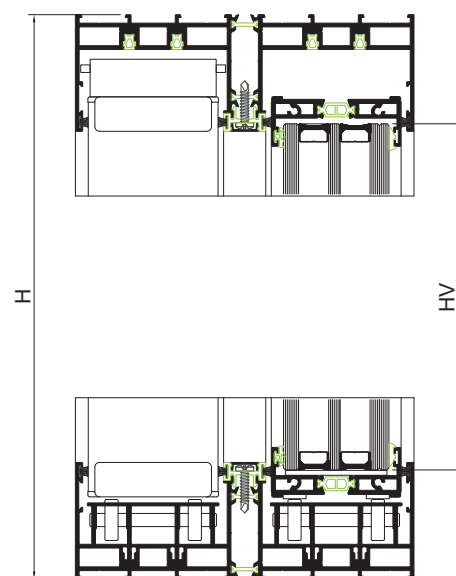
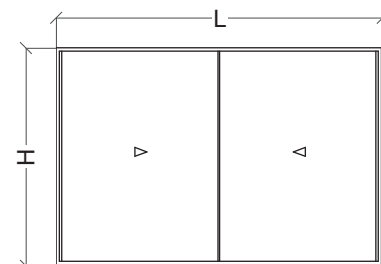

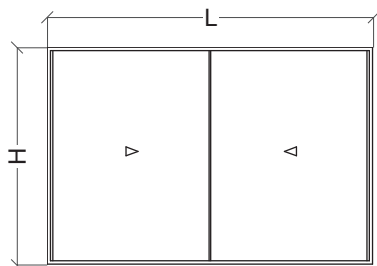
Janela 2 folhas correr minimalista • Ventana 2 hojas corredera minimalista
PERFIS • PERFIS

DESENHO • DISEÑO	REF.	DESCRIÇÃO • DESCRIPCIÓN	CORTE CORTE	QUANTIDADE CANTIDAD	MEDIDAS • MEDIDA
	KL-51	Aro fixo Marco Fijo Doble		2	L
				2	H
	KL-06 *	Separador fixo Separador poliamida central		2	L-98 mm
				2	H-98mm
	KL-04	Tampa fixa Tapeta marco		4	(L/2)-125mm
				2	H-124mm
	KL-58	Ombreira para fechos • Suplemento cierres		2	H-40mm
	AX-19	Vareta Pletina		2	H-93mm
	KL-63	Perfil tampa Embellecedor		2	H-37mm
	KL-55/RD	Perfil guia Rodamiento inferior		2	L (várias medidas)
	KL-57	Aro móvel inferior/superior Hoja inferior/superior		4	(L/2)-89mm
	KL-56	Aro móvel lateral Hoja lateral		2	H-93mm
	KL-52	Aro móvel central Hoja central con refuerzo		1	H-93mm
	KL-59	Aro móvel central Hoja central		1	H-93mm

ACESSÓRIOS E JUNTAS • ACCESORIOS Y JUNTAS

REF.	DESCRIÇÃO • DESCRIPTION	QUANTIDADE CANTIDAD
30 94 64 00	Esquadro Aro Fixo • Escuadra Marco	16
30 91 01 35	Esquadro de alinhamento • Escuadra alineamiento especial	8
30 92 01 02	Goteira • Vierendeaguas blanco/negro	4
30 94 64 40	Batente Lateral • Batiente lateral	4
30 94 66 22	Conjunto puxador Prime • Conjunto manilla Prime	2
30 94 61 85	Conjunto fecho Gravity • Conjunto cierre Gravity	2
30 94 61 86	Conjunto fecho microventilação Gravity • Conj. cierre microventilación Gravity	2
30 94 65 16	Conjunto ligação KL-56 • Conjunto ligación KL-56	2
30 94 65 01	Conjunto ligação KL-52/59 • Conjunto ligación KL-52/59	2
30 94 66 20	Carro Guia • Carro guia	4
30 95 60 56	Barra de latão • Bar de latão	2L
30 94 64 02	Corta-vento • Cortaviento	2
30 94 65 16	Conjunto tampas • Conjunto tapas	2
30 94 65 41	Tampa esq. KL-59 • Tapa izq. KL-59	1
30 94 65 44	Tampa dir. KL-59 • Tapa der. KL-59	1
30 94 65 51	Tampa esq. KL-52 • Tapa izq. KL-52	1
30 94 65 54	Tampa dir. KL-52 • Tapa der. KL-52	1
30 94 64 51	Calço 5x20 • Calzo 5x20	8
30 94 60 73	Calço 3mm • Calzo 3mm	12
30 94 64 80	Junta Central • Junta central	2H
30 95 60 02	Junta tapa canal • Junta tapa canal	4L
---	Junta vidro exterior • Junta vidrio exterior	2L+4H
---	Junta vidro interior • Junta vidrio interior	2L+4H
30 95 00 40	Pelúcia • Burlete	8L+6H
30 94 64 49	Goteira com válvula preta • Vierendeaguas con deflector negro	8

VIDRO • VIDRIO

Espessura total máxima 56mm • Espesor máximo 56mm

Hv= H-116mm Lv= (L/2) - 65mm

























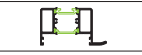





Aplicar intercalar do tipo Warm Edge •

Selagem secundária do vidro duplo em silicone • Sellado secundario de doble vidrio de silicona

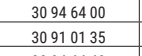
Aplicar vidro duplo ou triplo com bordos arestados • Aplicar vidrio doble o triple con bordos rugosos

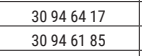
Janela 3 folhas com pré-aro • Ventana 3 hojas con pre-marco

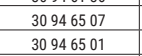
PERFIS • PERFIS

DESENHO • DESEÑO	REF.	DESCRIÇÃO • DESCRIPCIÓN	CORTE CORTE	QUANTIDADE CANTIDAD	MEDIDAS • MEDIDA
	KL-51	Aro fixo Marco fijo doble		2	L
	KL-06 *	Separador fixo Separador poliámidá central		2	L-98 mm
	KL-04	Tampa fixa Tapeta marco		4	(L/3)-46mm
				2	(L/3)-86mm
	KL-58	Ombreira para fechos • Suplemento cierres		2	H-68mm
	AX-19	Vareta Pletina		2	H-121mm
	KL-63	Perfil tampa Embelecedor		2	H-65mm
	KL-55/RD	Perfil guia Rodamiento inferior		2	L (várias medidas)
	KL-57	Aro móvel inferior/superior Hoja inferior/superior		6	(L/3)-78mm
	KL-76	Aro móvel lateral Hoja lateral		2	H-121mm
	KL-52	Aro móvel central Hoja central con refuerzo		2	H-121mm
	KL-59	Aro móvel central Hoja central		2	H-121mm
	KL-93	Pré-Aro • Pre-marco doble		1	L-6mm
	KL-95	Caleira • Canalón		1	L-6mm
	KL-13/R	Tampa com furação • Embelecedor troquelado		1	L-6mm

* preferencialmente cortar juntamente com o perfil KL-51 • preferiblemente cortado junto con el perfil KL-51

ACESSÓRIOS E JUNTAS • ACCESORIOS Y JUNTAS

REF.	DESCRIÇÃO • DESCRIPTION	QUANTIDADE CANTIDAD
30 94 64 00	Esquadro Aro Fixo • Escuadra Marco	16
30 91 01 35	Esquadro de alinhamento • Escuadra alineamiento especial	8
30 94 64 40	Batente Lateral • Batiente lateral	4
30 94 64 17	Fecho Gravity Inox • Cierre Gravity Inox	2
30 94 61 85	Conjunto fecho Gravity • Conjunto cierre Gravity	2
30 94 61 86	Conjunto fecho microventilação Gravity • Conj. cierre microventilación Gravity	2
30 94 65 07	Conjunto ligação KL-76 • Conjunto ligación KL-76	2
30 94 65 01	Conjunto ligação KL-52/59 • Conjunto ligación KL-52/59	4
30 94 66 20	Carro Guia • Carro guía	6
30 95 60 56	Barra de latão • Bar de latão	2L
30 94 64 02	Corta-vento • Cortaviento	4
30 94 65 26	Conjunto tampas KL-76 • Conjunto tapas KL-76	2
30 94 65 41	Tampa esq. KL-59 • Tapa izq. KL-59	2
30 94 65 44	Tampa dir. KL-59 • Tapa der. KL-59	2
30 94 65 51	Tampa esq. KL-52 • Tapa izq. KL-52	2
30 94 65 54	Tampa dir. KL-52 • Tapa der. KL-52	2
30 94 64 42	Topo caleira • Tope canalon	2
30 94 64 45	Topo pré-aro • Tope pré-marco	2
30 94 64 51	Calço 5x20 • Calzo 5x20	16
30 94 60 73	Calço 3mm • Calzo 3mm	18
30 94 64 80	Junta Central • Junta central	4H
30 95 60 02	Junta tapa canal • Junta tapa canal	4L
---	Junta vidro exterior • Junta vidrio exterior	2L+6H
---	Junta vidro interior • Junta vidrio interior	2L+6H
30 95 00 40	Pelúcia • Burlete	8L+4H
30 95 00 50	Pelúcia • Burlete	4H
30 94 64 49	Goteira com válvula preta • Vierteaguas con deflector negro	30







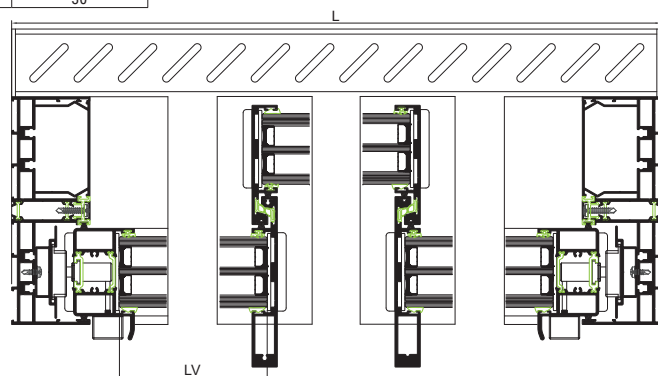
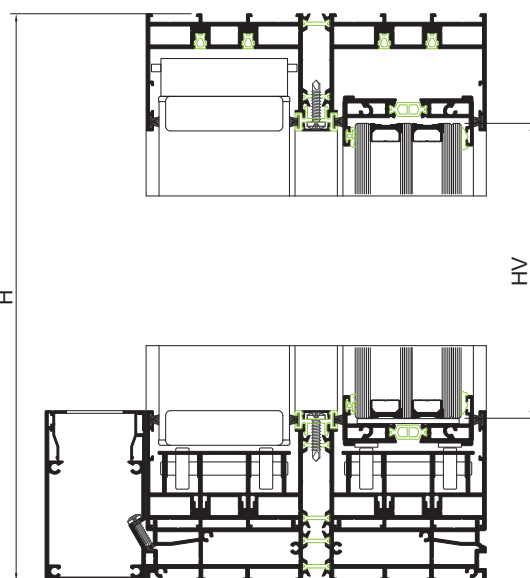
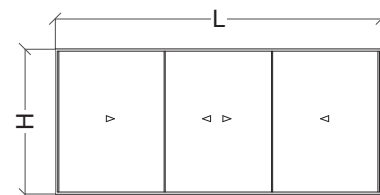



















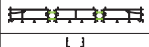

VIDRO • VIDRIO

Espessura total máxima 56mm • Espesor máximo 56mm

Hv= H-144mm	Lv= (L/3) - 54mm
-------------	------------------

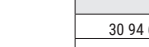
 Aplicar intercalar do tipo Warm Edge • Selagem secundária do vidro duplo em silicone • Sellado secundario de doble vidrio de silicona
 Aplicar vidro duplo ou triplo com bordos arestados • Aplicar vidrio doble o triple con bordes rugosos

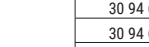
Janela 3 folhas tri-rail com pré-aro • Ventana 3 hojas tri-rail con pré-marco
PERFIS • PERFIS

DESENHO • DESEÑO	REF.	DESCRIÇÃO • DESCRIPCIÓN	CORTE CORTE	QUANTIDADE CANTIDAD	MEDIDAS • MEDIDA
	KL-73	Aro fixo tri-rail Marco Fijo triple		2	L
	KL-06 *	Separador fixo Separador poliamida central		4	L-98 mm
	KL-04	Tampa fixa Tapeta marco		4	H-126mm
	KL-58	Ombreira para fechos • Suplemento cierres		2	H-152mm
	AX-19	Vareta Pletina		2	H-68mm
	KL-63	Perfil tampa Embelecedor		2	H-121mm
	KL-55/RD	Perfil guia Rodamiento inferior		4	H-65mm
	KL-57	Aro móvel inferior/superior Hoja inferior/superior		3	L (várias medidas)
	KL-76	Aro móvel lateral Hoja lateral		6	(L/3)-78mm
	KL-52	Aro móvel central Hoja central con refuerzo		2	H-121mm
	KL-59	Aro móvel central Hoja central		2	H-121mm
	KL-94	Pré-Aro • Premarco triple		1	L-6mm
	KL-95	Caleira • Canalon		1	L-6mm
	KL-13/R	Tampa com furação • Embellecedor troquelado		1	L-6mm

* preferencialmente cortar juntamente com o perfil KL-73 • preferiblemente cortado junto con el perfil KL-73

ACESSÓRIOS E JUNTAS • ACCESORIOS Y JUNTAS

REF.	DESCRIÇÃO • DESCRIPTION	QUANTIDADE CANTIDAD
30 94 64 00	Esquadro Aro Fixo • Escuadra Marco	24
30 91 01 35	Esquadro de alinhamento • Escuadra alineamiento especial	8
30 94 64 40	Batente Lateral • Batiente lateral	4
30 94 64 17	Fecho Gravity Inox • Cierre Gravity Inox	2
30 94 61 85	Conjunto fecho Gravity • Conjunto cierre Gravity	2
30 94 61 86	Conjunto fecho microventilação Gravity • Conj. cierre microventilación Gravity	2
30 94 65 07	Conjunto ligação KL-76 • Conjunto ligación KL-76	2
30 94 65 01	Conjunto ligação KL-52/59 • Conjunto ligación KL-52/59	4
30 94 66 20	Carro Guia • Carro guía	6
30 95 60 56	Barra de latão • Bar de latón	2L
30 94 64 02	Corta-vento • Cortaviento	4
30 94 65 26	Conjunto tampas KL-76 • Conjunto tapas KL-76	2
30 94 65 41	Tampa esq. KL-59 • Tapa izq. KL-59	2
30 94 65 44	Tampa dir. KL-59 • Tapa der. KL-59	2
30 94 65 51	Tampa esq. KL-52 • Tapa izq. KL-52	2
30 94 65 54	Tampa dir. KL-52 • Tapa der. KL-52	2
30 94 64 42	Topo caleira • Tope canalon	2
30 94 64 46	Topo pré-aro • Tope pré-marco	2
30 94 64 51	Calço 5x20 • Calzo 5x20	16
30 94 60 73	Calço 3mm • Calzo 3mm	18
30 94 64 80	Junta Central • Junta central	4H
30 95 60 02	Junta tapa canal • Junta tapa canal	6L
---	Junta vidro exterior • Junta vidrio exterior	2L+6H
---	Junta vidro interior • Junta vidrio interior	2L+6H
30 95 00 40	Pelúcia • Burlete	12L+4H
30 95 00 50	Pelúcia • Burlete	4H
30 94 64 49	Goteira com válvula preta • Vierteaguas con deflector negro	42

VIDRO • VIDRIO







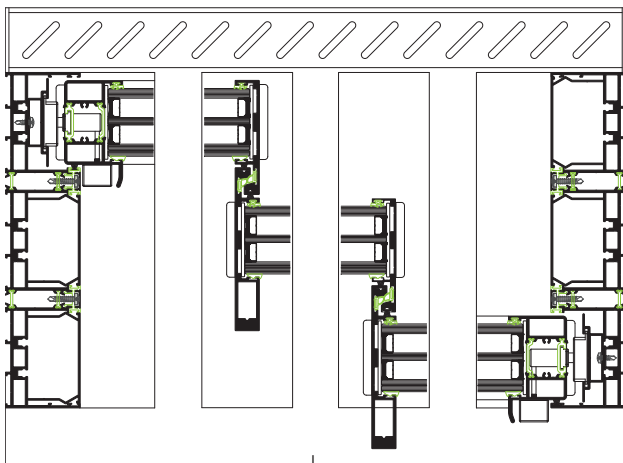
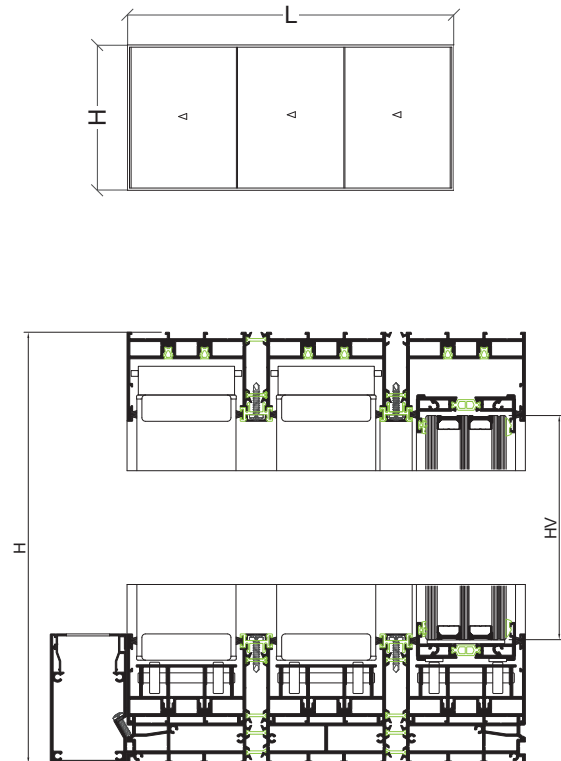















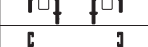



Espessura total máxima 56mm • Espesor máximo 56mm

Hv= H-144mm Lv= (L/3) - 54mm

Aplicar intercalar do tipo Warm Edge •
 Selagem secundária do vidro duplo em silicone • Sellado secundario de doble vidrio de silicona
 Aplicar vidro duplo ou triplo com bordos arestados • Aplicar vidrio doble o triple con bordos rugosos



Janela 3 folhas tri-rail com corte recto • Ventana 3 hojas tri-rail con corte recto
PERFIS • PERFIS

DESENHO • DESEÑO	REF.	DESCRIÇÃO • DESCRIPCIÓN	CORTE CORTE	QUANTIDADE CANTIDAD	MEDIDAS • MEDIDA
	KL-73	Aro fixo tri-rail Marco Fijo triple		2	H
	KL-84	Soleira/Padieira tri-rail Solape tricarril		2	L-37mm
	KL-06 *	Separador fixo Separador poliamida central		4	L-110 mm
				4	H-108mm
	KL-04	Tampa fixa Tapeta marco		4	(L/3)-46mm
				2	(L/3)-86mm
				2	(L/2)-18mm
	KL-58	Ombreira para fechos • Suplemento cierres		2	H-24mm
	AX-19	Vareta Pletina		2	H-77mm
	KL-63	Perfil tampa Embelecedor		4	H-21mm
	KL-55/RD	Perfil guia Rodamiento inferior		3	L (várias medidas)
	KL-57	Aro móvel inferior/superior Hoja inferior/superior		6	(L/3)-78mm
	KL-76	Aro móvel lateral Hoja lateral		2	H-77mm
	KL-52	Aro móvel central Hoja central con refuerzo		2	H-77mm
	KL-59	Aro móvel central Hoja central		2	H-77mm

* preferencialmente cortar juntamente com o perfil KL-73 • preferiblemente cortado junto con el perfil KL-73

ACESSÓRIOS E JUNTAS • ACCESORIOS Y JUNTAS

REF.	DESCRIÇÃO • DESCRIPTION	QUANTIDADE CANTIDAD
30 94 64 40	Batente Lateral • Batiante lateral	4
30 94 64 17	Fecho Gravity Inox • Cierre Gravity Inox	2
30 94 61 85	Conjunto fecho Gravity • Conjunto cierre Gravity	2
30 94 61 86	Conjunto fecho microventilação Gravity • Conj. cierre microventilación Gravity	2
30 94 65 07	Conjunto ligação KL-76 • Conjunto ligación KL-76	2
30 94 65 01	Conjunto ligação KL-52/59 • Conjunto ligación KL-52/59	4
30 94 66 20	Carro Guia • Carro guía	6
30 95 60 56	Barra de latão • Bar de latón	2L
30 94 64 02	Corta-vento • Cortaviento	4
30 94 65 26	Conjunto tampas KL-76 • Conjunto tapas KL-76	2
30 94 65 41	Tampa esq. KL-59 • Tapa izq. KL-59	2
30 94 65 44	Tampa dir. KL-59 • Tapa der. KL-59	2
30 94 65 51	Tampa esq. KL-52 • Tapa izq. KL-52	2
30 94 65 54	Tampa dir. KL-52 • Tapa der. KL-52	2
30 94 64 76	Kit juntas estanquidade KL-83 • Kit juntas estanquidad KL-83	1
30 94 64 51	Calço 5x20 • Calzo 5x20	16
30 94 60 73	Calço 3mm • Calzo 3mm	18
30 94 64 80	Junta Central • Junta central	4H
30 95 60 02	Junta tapa canal • Junta tapa canal	6L
---	Junta vidro exterior • Junta vidrio exterior	2L+6H
---	Junta vidro interior • Junta vidrio interior	2L+6H
30 95 00 40	Pelúcia • Burlete	12L+8H











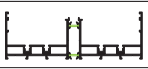



















VIDRO • VIDRIO

Espessura total máxima 56mm • Espesor máximo 56mm

Hv= H-100mm Lv= (L/3) - 54mm

Aplicar intercalar do tipo Warm Edge •
 Selagem secundária do vidro duplo em silicone • Sellado secundario de doble vidrio de silicona
 Aplicar vidro duplo ou triplo com bordos arestados • Aplicar vidrio doble o triple con bordos rugosos

Janela 4 folhas minimalista • Ventana 4 hojas minimalista
PERFIS • PERFIS

DESENHO • DESEÑO	REF.	DESCRIÇÃO • DESCRIPCIÓN	CORTE CORTE	QUANTIDADE CANTIDAD	MEDIDAS • MEDIDA
	KL-51	Aro fixo Marco Fijo Doble		2	L
	KL-06 *	Separador fixo Separador poliamida central		2	L-98 mm
	KL-04	Tampa fixa Tapeta marco		4	(L/4)-31mm
				4	(L/4)-71mm
				2	H-124mm
	KL-58	Ombreira para fechos • Suplemento cierres		2	H-40mm
	AX-19	Vareta Pletina		2	H-93mm
	KL-63	Perfil tampa Embellecedor		2	H-37mm
	KL-55/RD	Perfil guia Rodamiento inferior		2	L (várias medidas)
	KL-57	Aro móvel inferior/superior Hoja inferior/superior		8	(L/4)-63mm
	KL-76	Aro móvel lateral Hoja lateral		2	H-93mm
	KL-52	Aro móvel central Hoja central con refuerzo		2	H-93mm
	KL-59	Aro móvel central Hoja central		2	H-93mm
	KL-62	Aro móvel central Hoja central		1	H-93mm
	KL-64	Aro móvel central Hoja central		1	H-93mm

* preferencialmente cortar juntamente com o perfil KL-51 • preferiblemente cortado junto con el perfil KL-51

ACESSÓRIOS E JUNTAS • ACCESORIOS Y JUNTAS

REF.	DESCRIÇÃO • DESCRIPTION	QUANTIDADE CANTIDAD
30 94 64 00	Esquadro Aro Fixo • Escuadra Marco	16
30 91 01 35	Esquadro de alinhamento • Escuadra alineamiento especial	8
30 92 01 02	Goteira • Vierendeaguas (negro)	4
30 94 64 40	Batente Lateral • Batiente lateral	4
30 94 64 17	Fecho Gravity Inox • Cierre Gravity Inox	2
30 94 61 85	Conjunto fecho Gravity • Conjunto cierre Gravity	2
30 94 61 86	Conjunto fecho microventilação Gravity • Conj. cierre microventilación Gravity	2
30 94 64 06	Fecho Central 4F • Cierre central 4F	2
30 94 65 07	Conjunto ligação KL-76 • Conjunto ligación KL-76	2
30 94 65 01	Conjunto ligação KL-52/59/62/64 • Conjunto ligación KL-52/59/62/64	6
30 94 66 20	Carro Guia • Carro guía	8
30 95 60 56	Barra de latão • Bar de latão	2L
30 94 64 02	Corta-vento • Cortaviento	6
30 94 65 26	Conjunto tampas KL-76 • Conjunto tapas KL-76	2
30 94 65 41	Tampa esq. KL-59 • Tapa izq. KL-59	2
30 94 65 44	Tampa dir. KL-59 • Tapa der. KL-59	2
30 94 65 51	Tampa esq. KL-52 • Tapa izq. KL-52	2
30 94 65 54	Tampa dir. KL-52 • Tapa der. KL-52	2
30 94 65 61	Tampa esq. KL-64 • Tapa izq. KL-64	1
30 94 65 64	Tampa dir. KL-64 • Tapa der. KL-64	1
30 94 65 71	Tampa esq. KL-62 • Tapa izq. KL-62	1
30 94 65 74	Tampa dir. KL-62 • Tapa der. KL-62	1
30 94 64 51	Calço 5x20 • Calzo 5x20	24
30 94 60 73	Calço 3mm • Calzo 3mm	20
30 94 64 80	Junta Central • Junta central	6H
30 95 60 02	Junta tapa canal • Junta tapa canal	4L
---	Junta vidro exterior • Junta vidrio exterior	2L+8H
---	Junta vidro interior • Junta vidrio interior	2L+8H
30 95 00 40	Pelúcia • Burlete	8L+4H
30 95 00 50	Pelúcia • Burlete	6H
30 94 64 49	Goteira com válvula preta • Vierendeaguas con deflector negro	16

VIDRO • VIDRIO







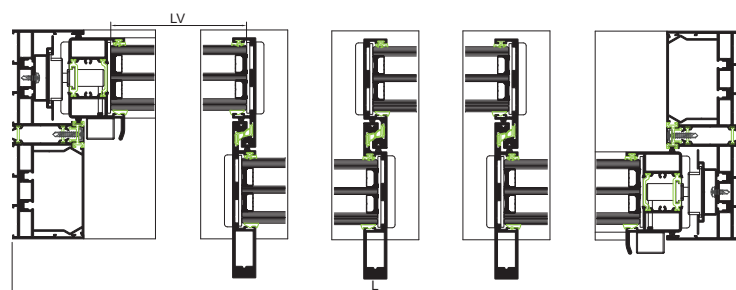
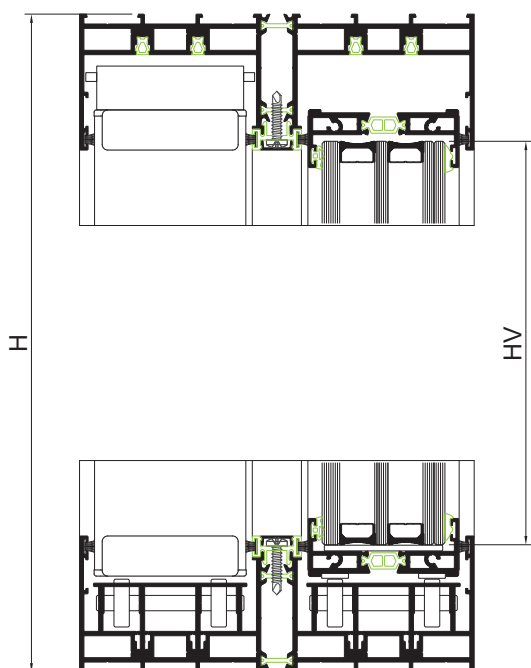
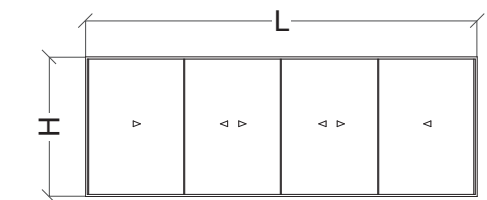













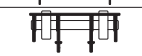







Espessura total máxima 56mm • Espesor máximo 56mm

Hv= H-116mm Lv= (L/4) - 40mm

Aplicar intercalar do tipo Warm Edge • Selagem secundária do vidro duplo em silicone • Sellado secundario de doble vidrio de silicona
 Aplicar vidro duplo ou triplo com bordos arestados • Aplicar vidrio doble o triple con bordos rugosos



Janela 2 folhas com soleira embutida • Ventana 2 hojas con solape empotrada
PERFIS • PERFIS

DESENHO • DISEÑO	REF.	DESCRIÇÃO • DESCRIPCIÓN	CORTE CORTE	QUANTIDADE CANTIDAD	MEDIDAS • MEDIDA
	KL-51	Aro fixo Marco Fijo Doble		2	L
	KL-06 *	Separador fixo Separador poliámidia central		2	L-98 mm
	KL-04	Tampa fixa Tapeta marco		4	(L/2)-125mm
	KL-58	Ombreira para fechos • Suplemento cierres		2	H-40mm
	AX-19	Vareta Pletina		2	H-141mm
	KL-63	Perfil tampa Embelecedor		2	H-37mm
	KL-55/RD	Perfil guia Rodamiento inferior		2	L (várias medidas)
	KL-57	Aro móvel inferior/superior Hoja inferior/superior		4	(L/2)-107mm
	KL-76	Aro móvel lateral Hoja lateral		2	H-141mm
	KL-52	Aro móvel central Hoja central con refuerzo		1	H-141mm
	KL-59	Aro móvel central Hoja central		1	H-141mm
	KL-54	Soleira Embutida Solape de unión		2	(L/2)-27mm
	KL-65	Tampa lateral Embelecedor lateral		2	(L/2)-62mm
	KL-66	Tampa Central Embelecedor Central		2	(L/2)-35mm

* preferencialmente cortar juntamente com o perfil KL-51 • preferiblemente cortado junto con el perfil KL-51

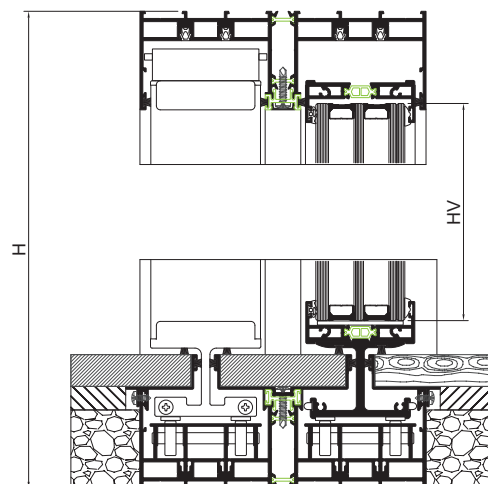
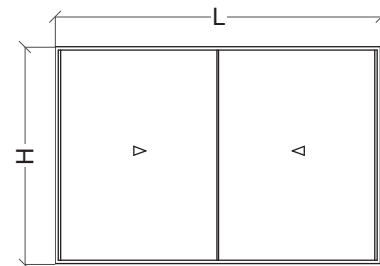
ACESSÓRIOS E JUNTAS • ACCESORIOS Y JUNTAS

REF.	DESCRIÇÃO • DESCRIPTION	QUANTIDADE CANTIDAD
30 94 64 00	Esquadro Aro Fixo • Escuadra Marco	16
30 91 01 35	Esquadro de alinhamento • Escuadra alineamiento especial	8
30 92 01 02	Goteira • Vierendeaguas blanco/negro	4
30 94 64 40	Batente Lateral • Batiente lateral	4
30 94 64 17	Fecho Gravity Inox • Cierre Gravity Inox	2
30 94 61 85	Conjunto fecho Gravity • Conjunto cierre Gravity	2
30 94 61 86	Conjunto fecho microventilação Gravity • Conj. cierre microventilación Gravity	2
30 94 65 07	Conjunto ligação KL-76 • Conjunto ligación KL-76	2
30 94 65 01	Conjunto ligação KL-52/59 • Conjunto ligación KL-52/59	2
30 94 66 20	Carro Guia • Carro guia	4
30 95 60 56	Barra de latão • Bar de latão	2L
30 94 64 02	Corta-vento • Cortaviento	1
30 94 65 26	Conjunto tampas KL-76 • Conjunto tapas KL-76	1
30 94 65 19	Conjunto tampas guia embutida • Conjunto tapas guia incrustada	1
30 94 65 44	Tampa dir. KL-59 • Tapa der. KL-59	1
30 94 65 54	Tampa dir. KL-52 • Tapa der. KL-52	1
30 94 65 81	Tampa esq. embutida KL-59 • Tapa izq. incrustada KL-59	1
30 94 65 91	Tampa esq. embutida KL-52 • Tapa izq. incrustada KL-52	1
30 94 65 13	Topo guia KL-54 • Tope guia KL-54	4
30 94 64 48	Deslizador • Deslizador	8
30 94 64 51	Calço 5x20 • Calzo 5x20	8
30 94 60 73	Calço 3mm • Calzo 3mm	12
30 94 64 80	Junta Central • Junta central	2H
30 95 60 02	Junta tapa canal • Junta tapa canal	4L
---	Junta vidro exterior • Junta vidrio exterior	2L+4H
---	Junta vidro interior • Junta vidrio interior	2L+4H
30 95 00 40	Pelúcia • Burlete	4L+4H
30 95 00 30	Pelúcia • Burlete	2L
30 95 00 50	Pelúcia • Burlete	4L+2H
30 94 64 49	Goteira com válvula preta • Vierendeaguas con deflector negro	8

VIDRO • VIDRIO

Espessura total máxima 56mm • Espesor máximo 56mm

Hv= H-164mm	Lv= (L/2) - 83mm
-------------	------------------







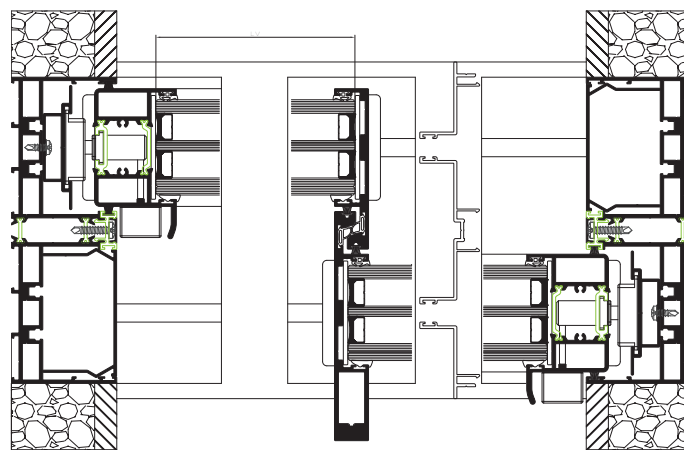

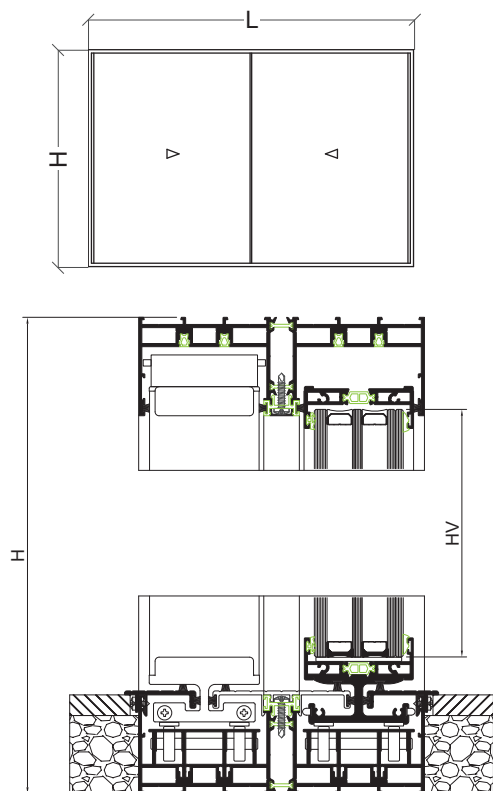



























Aplicar intercalado do tipo Warm Edge •

Selagem secundária do vidro duplo em silicone • Sellado secundario de doble vidrio de silicona

Aplicar vidro duplo ou triplo com bordos arestados • Aplicar vidrio doble o triple con bordes rugosos

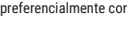

Janela 2 folhas com soleira embutida rasa • Ventana 2 hojas con solape emprotada rasa

PERFIS • PERFIS

DESENHO • DESEÑO	REF.	DESCRIÇÃO • DESCRIPCIÓN	CORTE CORTE	QUANTIDADE CANTIDAD	MEDIDAS • MEDIDA
	KL-51	Aro fixo Marco Fijo Doble		2	L
				2	H
	KL-06 *	Separador fixo Separador poliamida central		2	L-98 mm
				2	H-98mm
	KL-04	Tampa fixa Tapeta marco		4	(L/2)-125mm
				2	H-124mm
	KL-58	Ombreira para fechos • Suplemento cierres		2	H-40mm
	AX-19	Vareta Pletina		2	H-121mm
	KL-69	Perfil tampa Embelecedor		2	H-37mm
	KL-55/RD	Perfil guia Rodamiento inferior		2	L (várias medidas)
	KL-57	Aro móvel inferior/superior Hoja inferior/superior		4	(L/2)-107mm
	KL-76	Aro móvel lateral Hoja lateral		2	H-121mm
	KL-52	Aro móvel central Hoja central con refuerzo		1	H-121mm
	KL-59	Aro móvel central Hoja central		1	H-121mm
	KL-70	Soleira Embutida Solape de unión		2	(L/2)-27mm
	KL-67	Tampa lateral Embelecedor lateral		2	(L/2)-62mm
				2	(L/2)-35mm
	KL-68	Tampa Central Embelecedor Central		2	(L/2)-35mm

* preferencialmente cortar juntamente com o perfil KL-51 • preferiblemente cortado junto con el perfil KL-51

ACESSÓRIOS E JUNTAS • ACCESORIOS Y JUNTAS

REF.	DESCRIÇÃO • DESCRIPTION	QUANTIDADE CANTIDAD
30 94 64 00	Esquadro Aro Fixo • Escuadra Marco	16
30 91 01 35	Esquadro de alinhamento • Escuadra alineamiento especial	8
30 92 01 02	Goteira • Vierendeaguas blanco/negro	4
30 94 64 40	Batente Lateral • Batiente lateral	4
30 94 64 17	Fecho Gravity Inox • Cierre Gravity Inox	2
30 94 61 85	Conjunto fecho Gravity • Conjunto cierre Gravity	2
30 94 61 86	Conjunto fecho microventilação Gravity • Conj. cierre microventilación Gravity	2
30 94 65 07	Conjunto ligação KL-76 • Conjunto ligación KL-76	2
30 94 65 01	Conjunto ligação KL-52/59 • Conjunto ligación KL-52/59	2
30 94 66 20	Carro Guia • Carro guía	4
30 95 60 56	Barra de latão • Bar de latão	2L
30 94 64 02	Corta-vento • Cortaviento	1
30 94 65 26	Conjunto tampas guia embutida • Conjunto tapas guía incrustada	1
30 94 65 19	Conjunto tampas guia embutida • Conjunto tapas guía incrustada	1
30 94 65 44	Tampa dir. KL-59 • Tapa der. KL-59	1
30 94 65 54	Tampa dir. KL-52 • Tapa der. KL-52	1
30 94 65 81	Tampa esq. embutida KL-59 • Tapa izq. incrustada KL-59	1
30 94 65 91	Tampa esq. embutida KL-52 • Tapa izq. incrustada KL-52	1
30 94 65 12	Topo guia KL-70 • Tope guía KL-70	4
30 94 64 48	Deslizador • Deslizador	8
30 94 64 51	Calço 5x20 • Calzo 5x20	8
30 94 60 73	Calço 3mm • Calzo 3mm	12
30 94 64 80	Junta Central • Junta central	2H
30 95 60 02	Junta tapa canal • Junta tapa canal	4L
---	Junta vidro exterior • Junta vidrio exterior	2L+4H
---	Junta vidro interior • Junta vidrio interior	2L+4H
30 95 00 40	Pelúcia • Burlete	4L+4H
30 95 00 30	Pelúcia • Burlete	2L
30 95 00 50	Pelúcia • Burlete	4L+2H
30 94 64 49	Goteira com válvula preta • Vierendeaguas con deflector negro	8

VIDRO • VIDRIO

Espessura total máxima 56mm • Espesor máximo 56mm

Hv= H-144mm	Lv= (L/2) - 83mm
-------------	------------------

Aplicar intercalar do tipo Warm Edge •
 Selagem secundária do vidro duplo em silicone • Sellado secundario de doble vidrio de silicona
 Aplicar vidro duplo ou triplo com bordos arestados • Aplicar vidrio doble o triple con bordos rugosos

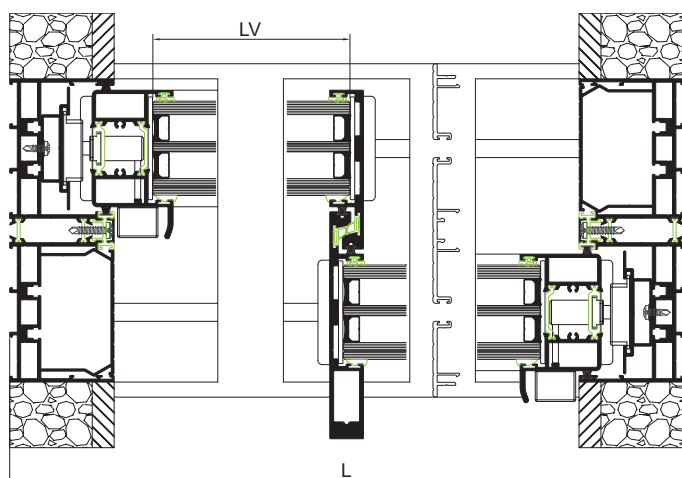

PORTUGAL

ALGARVE

AVEIRO

CASTELO BRANCO

CHAVES

COIMBRA

GUARDA

LEIRIA

LISBOA

MINHO

PORTO

S.J. DA MADEIRA

UISEU

ESPAÑA

CÁDIS

CORDOBA

IBIZA

JAÉN

LEÓN

MADRID

MÁLAGA

MAIORCA

MÚRCIA

OURENSE

SEVILHA

VALÈNCIA

