

www.anicolor.pt

**SISTEMA DE CORRER
COM RPT - 105 mm**

**SISTEMA CORREDERA
CON RPT - 105 mm**

CW

 **anicolor**
Sistemas de Alumínio

SISTEMA CW

Sistema de correr com RPT - 105 mm

CARACTERÍSTICAS DO SISTEMA

Sistema de alumínio com rotura térmica para executar vãos de correr.
 O sistema de correr CW possibilita a execução de 4 versões de caixilharia:
 Perimetral, Minimal, Galandage e Elevatória.

PERFIS DE ALUMÍNIO

Os perfis de alumínio são extrudidos na liga de alumínio 6060 para arquitetura de acordo com norma NP EN 12020-02.
 Perfis com rotura térmica obtida por inserção de varetas isolantes de poliamida de 6.6 mm reforçadas com 25% de fibra de vidro de 30 mm nos aros fixos e de 14.6 mm nos aros móveis.
 Espessura média dos perfis de alumínio de 1.5 mm.

AROS FIXOS

Secção do aro fixo perimetral de 2 guias de 105 mm para montagem a meia esquadria;
 Perfil guia de deslizamento inferior em aço inoxidável AISI 304 para evitar desgaste das peças.

AROS MÓVEIS

Secção dos aros móveis perimetrais de 48 mm com montagem a meia esquadria;
 Enchimento de 4 a 36 mm;
 Aros móveis de linha recta com ou sem bite ou com bite reduzido;
 Bites rectos;
 Estantidade assegurada através de juntas em EPDM e pelúcia tipo Fin-Seal.

DIMENSIONAMENTO E MANOBRABILIDADE

Dimensões mínimas - máximas de folha: 300 mm - 2500 mm (L); 350 mm - 2675 mm (H);
 Peso máximo de 300 Kg por folha (com 2 rolamentos)
 Tipologias de 2, 3, 4, 6 e 8 folhas móveis e/ou fixas;
 Tipologias de correr Galandage de 1, 2, 3, 4 e 6 folhas;
 Rolamento duplo oscilante com regulação;
 Rolamentos de agulhas em inox com eixo temperado retificado sendo possível a substituição sem desmontagem da folha;
 Suporte exterior com tratamento cataforese (anti-corrosivo);
 Abertura do vão com fecho lateral ou ferragem multiponto com 2 ou mais pontos de fecho;
 Puxadores desviados (esquerdo ou direito) para ferragem multiponto permitindo maior facilidade de abertura;
 Possibilidade de aplicação de ferragem elevatória de média dimensão;
 Puxador específico para ferragem elevatória de modo a facilitar as manobras de abertura e fecho do vão;
 Existe a opção de puxador duplo com colocação de canhão com chave para permitir a abertura do vão pelo exterior.

PERFORMANCES

Sistema certificado por laboratório credenciado, notificado para Ensaios Tipo Inicial (ITT) de acordo com a norma de produto EN 14351-1 para efeitos de Marcação CE.

Categorias alcançadas na avaliação do sistema CW tipologia janela:

1. Permeabilidade ao ar: Classe 3 (norma de ensaio EN 10207 e EN 1026)
2. Estantidade à água: Classe 7A (norma de ensaio EN 12208 e EN 1027)
3. Resistência ao vento: Classe C5 (norma de ensaio EN 12210 e EN 12211)

Categorias alcançadas na avaliação do sistema CW tipologia porta:

1. Permeabilidade ao ar: Classe 3 (norma de ensaio EN 10207 e EN 1026)
2. Estantidade à água: Classe 6A (norma de ensaio EN 12208 e EN 1027)
3. Resistência ao vento: Classe B3 (norma de ensaio EN 12210 e EN 12211)

Categorias alcançadas na avaliação do sistema CW tipologia porta elevatória:

1. Permeabilidade ao ar: Classe 4 (norma de ensaio EN 10207 e EN 1026)
2. Estantidade à água: Classe 7A (norma de ensaio EN 12208 e EN 1027)
3. Resistência ao vento: Classe C3 (norma de ensaio EN 12210 e EN 12211)

Categorias alcançadas na avaliação do sistema CW para determinação das forças de manobra (EN 12046):

1. Libertação da ferragem de fecho: Classe 2
2. Abertura da folha: Classe 1
3. Fecho da folha: Classe 2
4. Engate da ferragem de fecho: Classe 2

Categoria alcançada na determinação da resistência a abertura e fecho repetidos (5000 ciclos): Classe 1 (EN 1191)

Coefficiente de transmissão térmica de vão de 2 folhas com 4.0 m x 2.4 m com vidro Ug = 0.7 W/m²K, com intercalar efeito "Warm Edge":
 • Uw = 1.48 W/m²K

Coefficiente de atenuação acústica de vão de 2 folhas com vidro acústico 6/16/44.1:
 • Rw (C; Ctr) = 34 dB (-1; -6)

Zonas de aplicação segundo RCCTE (em função do valor Ug): I1, I2, I3, V1, V2, V3.

Sistema certificado pelo laboratório francês CSTB de acordo com as seguintes características:

- Certificado QB49
- Documento técnico de aplicação (DTA) nas tipologias de correr Bi-rail e Tri rail, Galandage e minimal com o avis technique 6/19-2399_V1.

SISTEMA CW

Sistema corredera con RPT - 105 mm

CARACTERÍSTICAS DEL SISTEMA

Sistema de aluminio con rotura térmica para ejecución de huecos de correr.
 El sistema corredero CW permite la ejecución de 4 versiones de marcos:
 Perimetral, Minimal e Galandage

PERFILES DE ALUMINIO

Los perfiles de aluminio son extruidos en aleación de aluminio 6060 para arquitectura de acuerdo con la norma NP EN 12020-02.
 Los perfiles con rotura térmica son obtenidos por inserción de varillas aislantes de poliamida 6.6 mm reforzadas con 25% de fibra de vidrio de 30mm en los marcos y de 14.6mm en las hojas.
 Espesor medio de los perfiles de aluminio de 1.5 mm.

MARCOS

Profundidad del marco perimetral de 2 guías de 105 mm para montaje a englete;
 Perfil guía de deslizamiento inferior en acero inoxidable AISI 304, para evitar el desgaste de las piezas.

HOJAS

Profundidad de las hojas perimetrales de 48 mm para montaje a englete;
 Acrislamiento de 4 mm a 36 mm;
 Hojas de linea recta con y sin junquillo y con junquillo reducido;
 Estanteidad asegurada mediante juntas en EPDM y burlete tipo Sin-Feal.

DIMENSIONAMIENTO Y MANIOBRABILIDAD

Dimensiones miniomas-máximas de hoja: 300mm - 2500mm (L); 350mm - 2675mm (H);
 Peso máximo de 300 Kg por hoja (con 2 rodamientos);
 Posibilidades de apertura: 2, 3, 4, 6 y 8 hojas con hojas correderas y/o fijas;
 Tipologias corredera Galandage de 1, 2, 3, 4 u 6 hojas;
 Rodamiento doble oscilante con regulación;
 Rodamientos de agujas inox con eje templado rectificado siendo posible la sustitución de la hoja sin desmontar la ventana;
 Soporte exterior con tratamiento anticorrosión;
 Apertura del hueco con cierre lateral u herraje multipunto con 2 u más puntos de cierre.
 Manilla desplazadas (izquierdo u derecho) para herraje multipunto permitiendo más facilidad de apertura;
 Posibilidad de aplicación de herraje elevable de media dimensión;
 Manilla de herraje elevable específica para facilitar las maniobras de apertura y cierre del hueco;
 Existe la opción de doble manilla con colocación de bombillo con llave para permitir la apertura del hueco por el exterior.

ENSAYOS

Sistema certificado por laboratorio credenciado, notificado para Ensayos Tipo Inicial (ITT) de acuerdo con la norma de producto EN 14351-1 para efectos de Marcado CE.

Categorias alcanzadas en los ensayos del sistema CW tipologia ventana:

1. Permeabilidad al aire: Clase 3 (norma de ensayo EN 10207 e EN 1026)
2. Estanteidad al agua: Clase 7A (norma de ensayo EN 12208 e EN 1027)
3. Resistencia al viento: Clase C5 (norma de ensayo EN 12210 e EN 12211)

Categorias alcanzadas en los ensayos del sistema CW tipologia puerta:

1. Permeabilidad al aire: Clase 3 (norma de ensayo EN 10207 e EN 1026)
2. Estanteidad al agua: Clase 6A (norma de ensayo EN 12208 e EN 1027)
3. Resistencia al viento: Clase B3 (norma de ensayo EN 12210 e EN 12211)

Categorias alcanzadas en los ensayos del sistema CW tipologia puerta elevable:

1. Permeabilidad al aire: Clase 4 (norma de ensayo EN 10207 e EN 1026)
2. Estanteidad al agua: Clase 7A (norma de ensayo EN 12208 e EN 1027)
3. Resistencia al viento: Clase C3 (norma de ensayo EN 12210 e EN 12211)

Categorias alcanzadas en los ensayos del sistema CW para determinación de las fuerzas de manobra (EN 12046):

1. Libertación de la herraje de cierre: Clase 2
2. Apertura de la hoja: Clase 1
3. Cierre de la hoja: Clase 2
4. Engate de la herraje de cierre: Clase 2

Categoria alcanzada en la determinación de la resistencia a apertura y cierre repetidos (5000 ciclos): Clase 1 (EN 1191)

Coefficiente de transmisión térmica de hueco de 2 hojas con 4.00 m x 2.40 m con vidrio Ug = 0.7 W/m²K con intercalar efecto "Warm Edge":
 • Uw = 1.48 W/m²K

Coefficiente de atenuación acústica de hueco de 2 hojas con vidrio acústico 6/16/44.1:
 • Rw (C; Ctr) = 34 dB (-1; -6)

Sistema certificado por el laboratorio francés CSTB según las siguientes características:

- Certificado QB49
- Documento de solicitud técnica (DTA) en Bi-rail y Tri-rail, Galandage y tipologías de deslizamiento mínimo con avis technique 6 / 19-2399_V1.

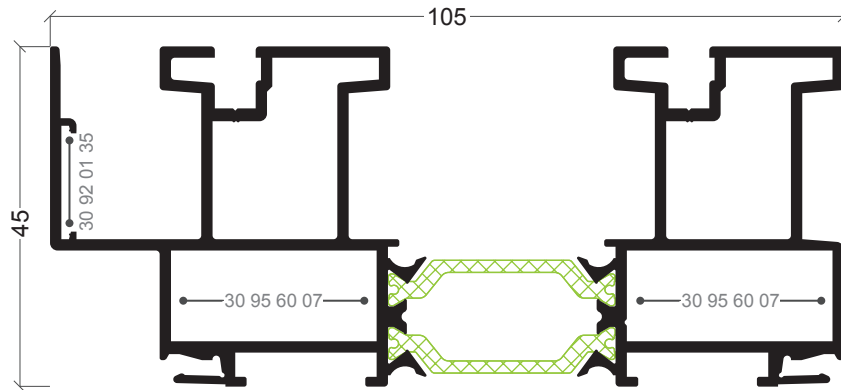

CW-01

Aro fixo perimetral
Marco bicarril con enganches

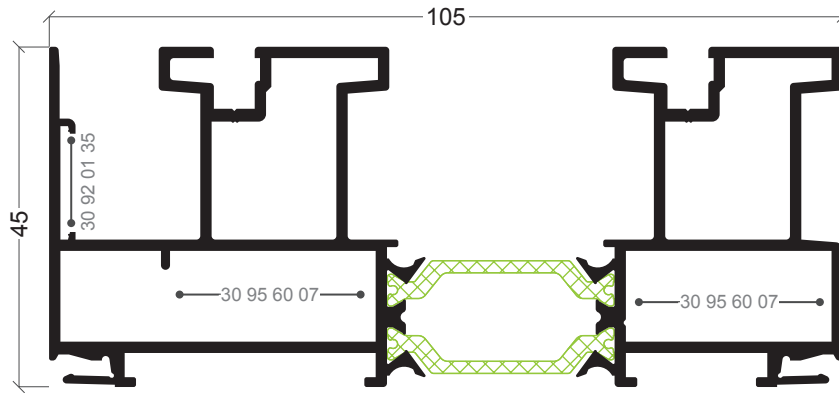

CW-05

Aro fixo perimetral
Marco bicarril con enganches

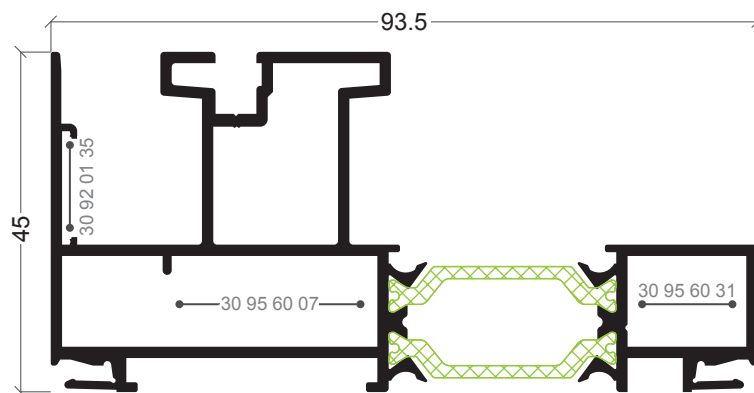

CW-07

Aro fixo mono-rail galandage
Marco mono carril galandage

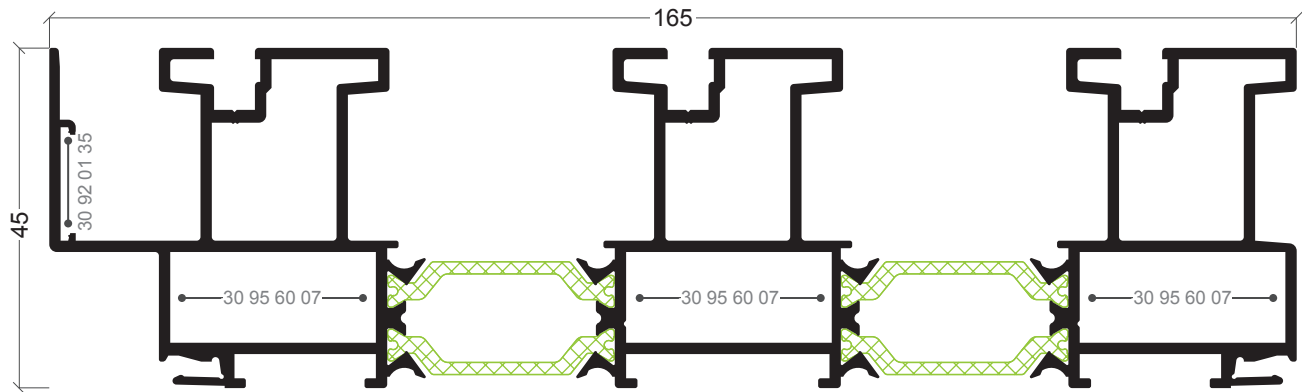

CW-08

Aro fixo tri-rail perimetral
Marco tricarril con enganches

356

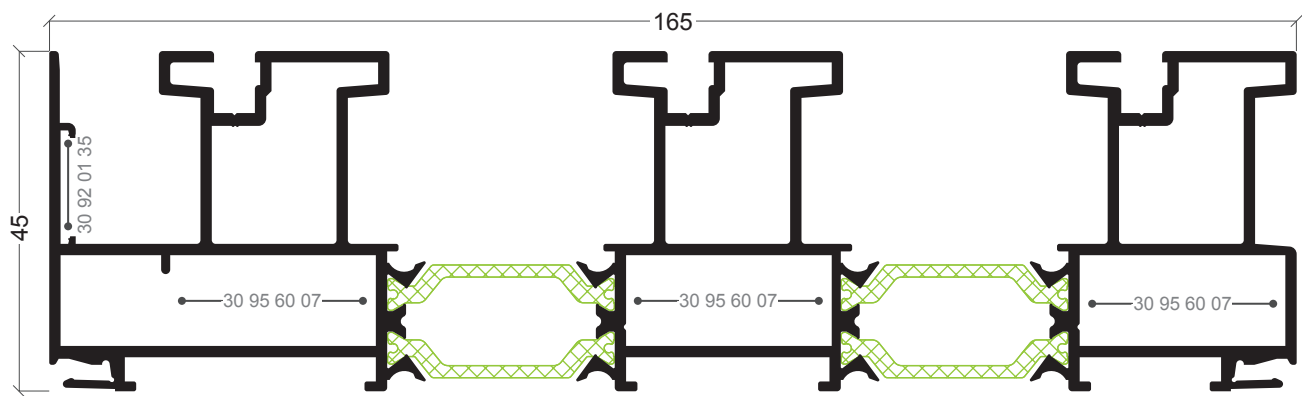

CW-09

Aro fixo tri-rail perimetral
Marco tricarril con enganches

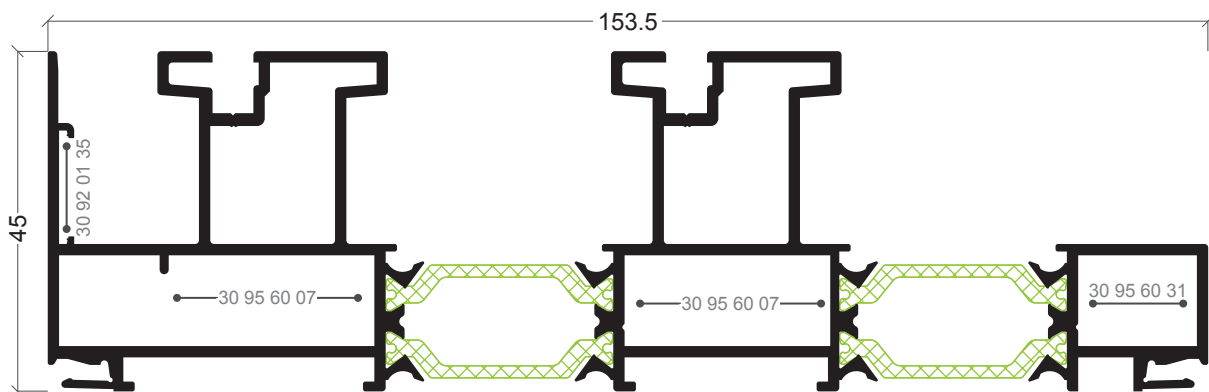

CW-10

Aro fixo bi-rail galandage
Marco bicarril galandage con enganches

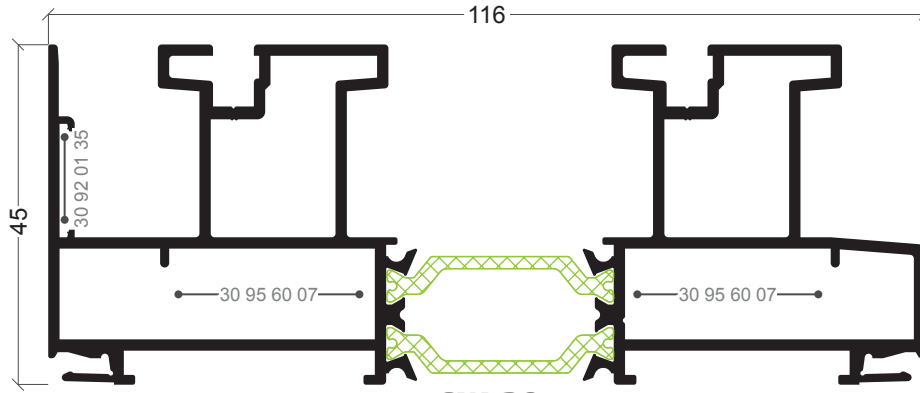

CW-20

Aro fixo bi-rail
Marco bicarril con enganches

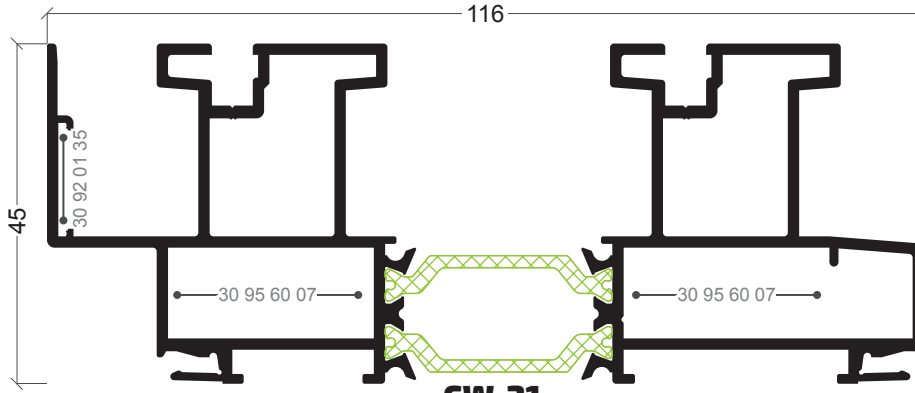

CW-21

Aro fixo bi-rail
Marco bicarril con enganches

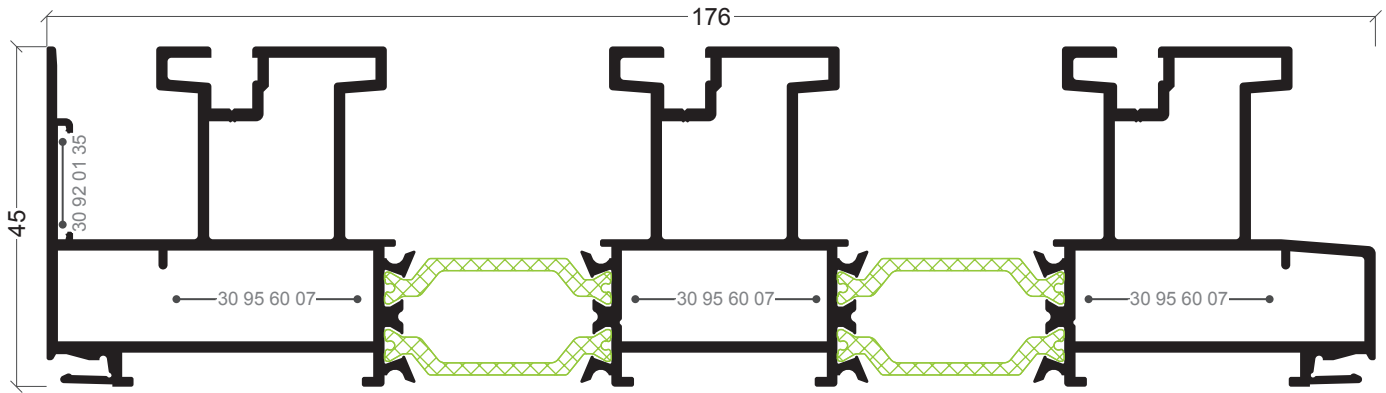

CW-22

Aro fixo tri-rail
Marco tricarril con enganches

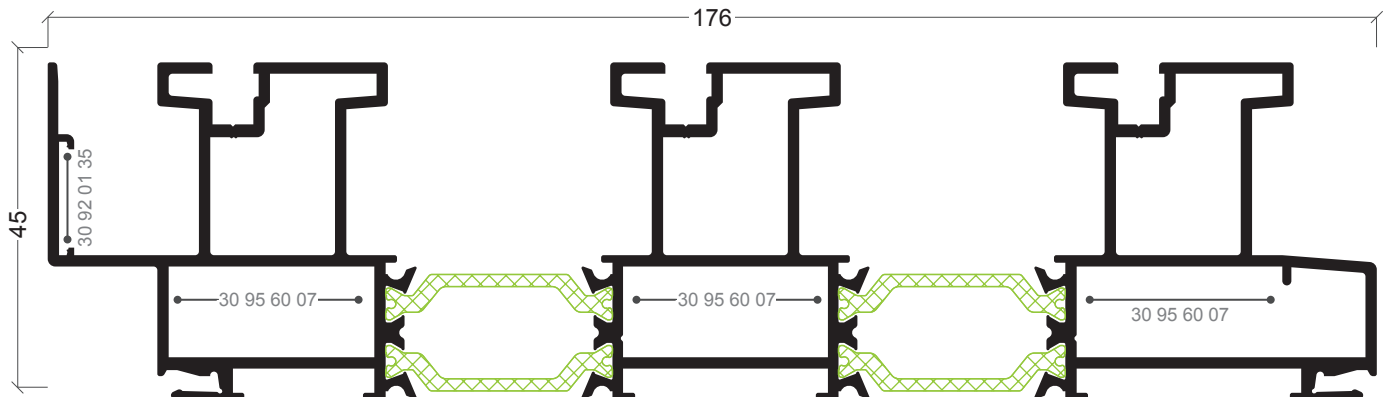

CW-23

Aro fixo tri-rail
Marco tricarril con enganches

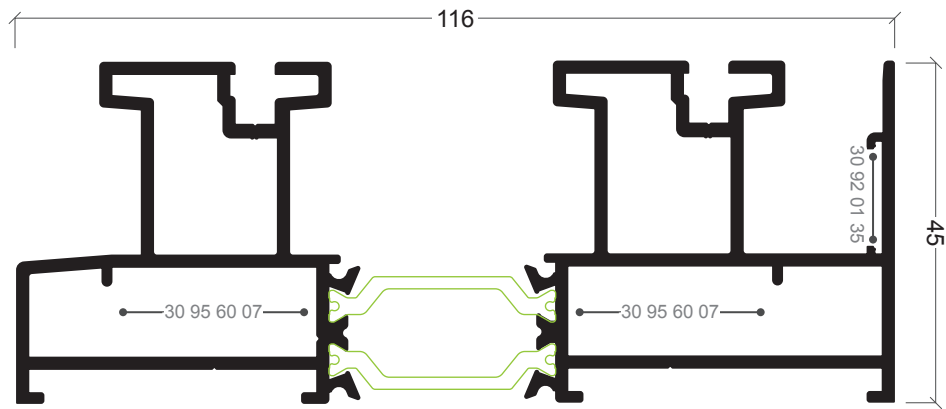

CW-30

Aro Fixo Perimetral
Marco Bicarril

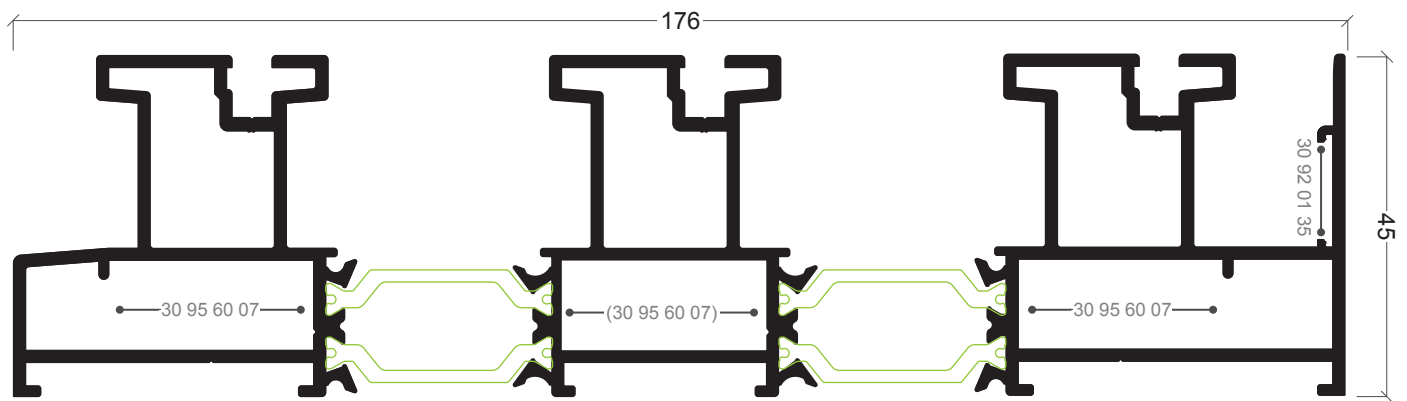

CW-31

Aro Fixo Perimetral tri-rail
Marco Tricarril

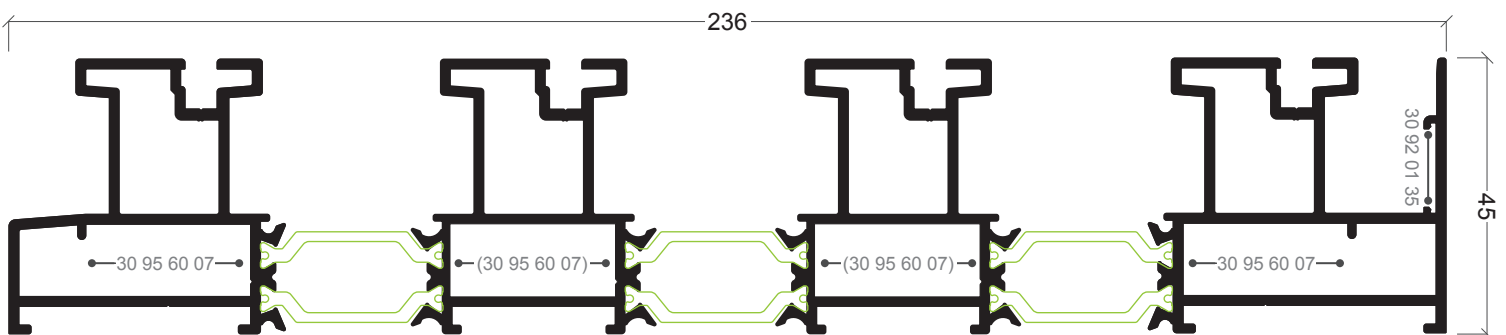

CW-32

Aro Fixo Perimetral Quadri-rail
Marco Quadricarril

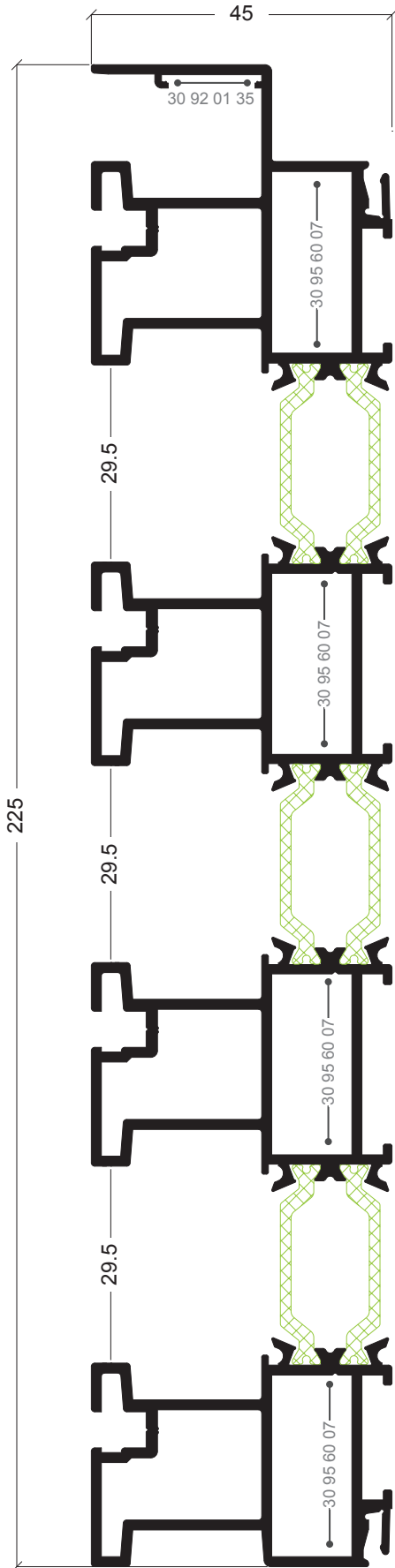

CW-17

Soleira Quadri-rail
Soleira Quadri-rail

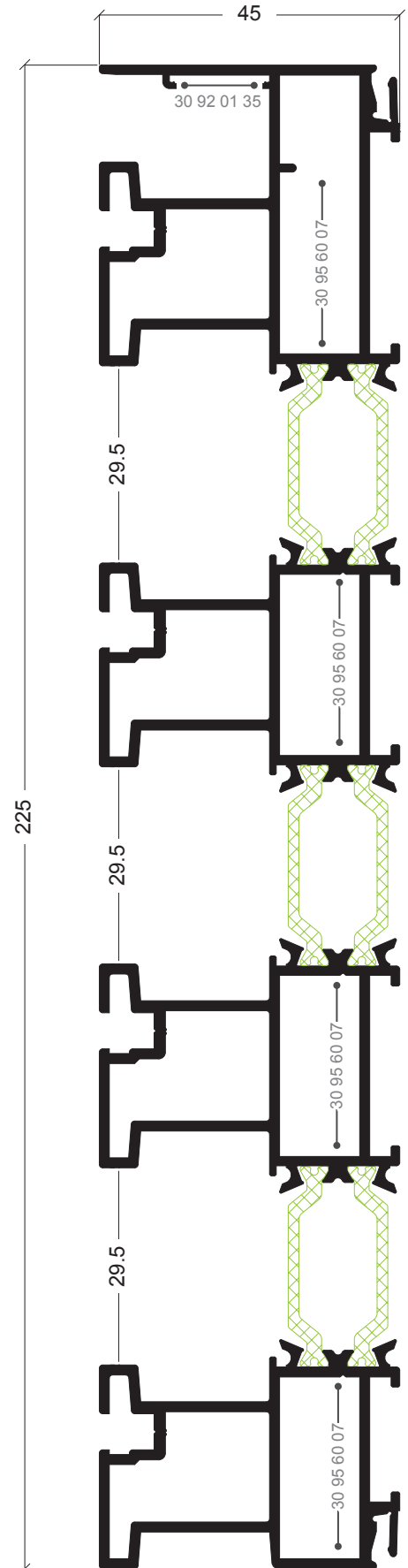

CW-18

Soleira Quadri-rail
Soleira Quadri-rail

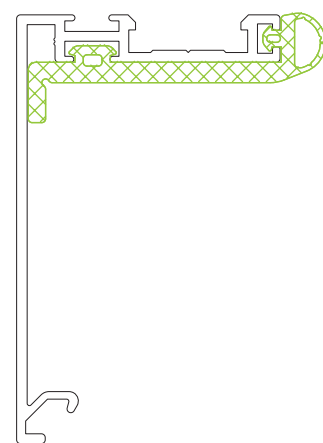
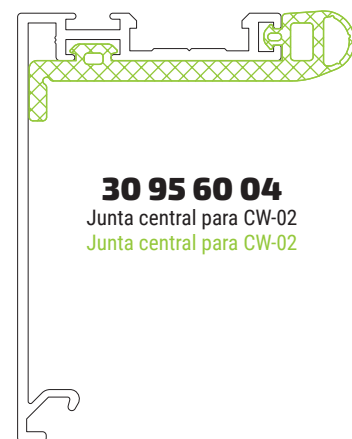
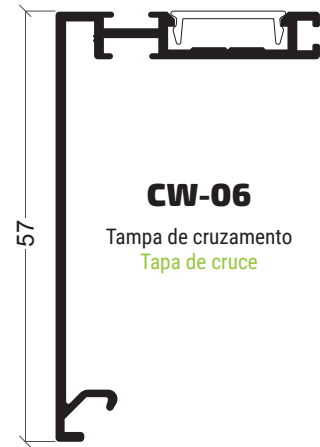
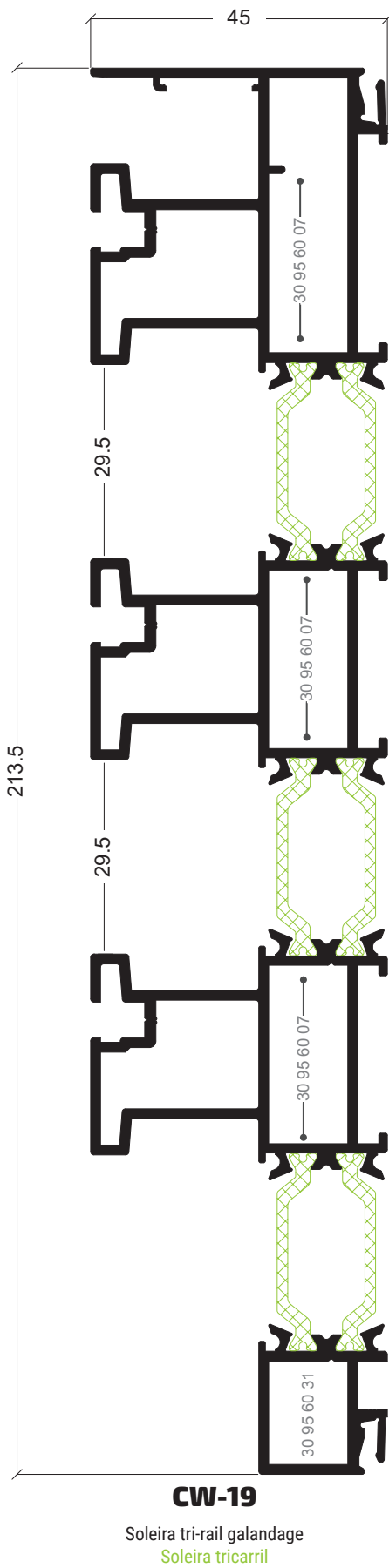

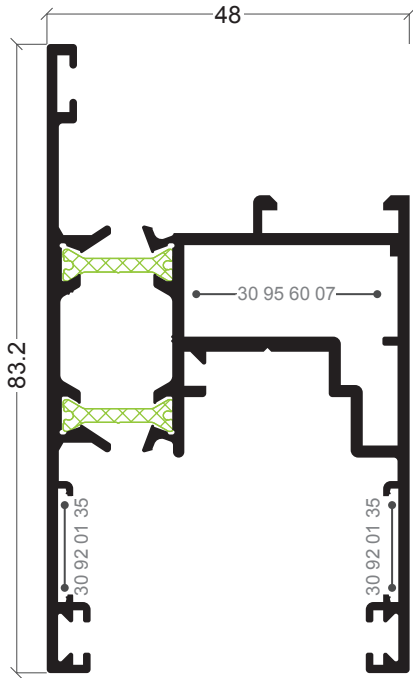

CW-02
Aro móvel perimetral
Hoja perimetral

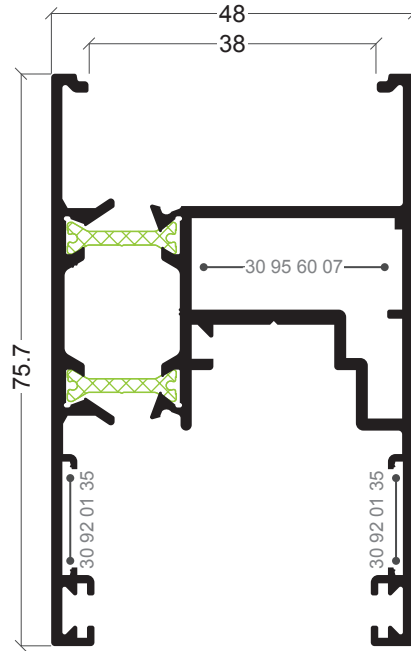

CW-03
Aro móvel perimetral
Hoja perimetral

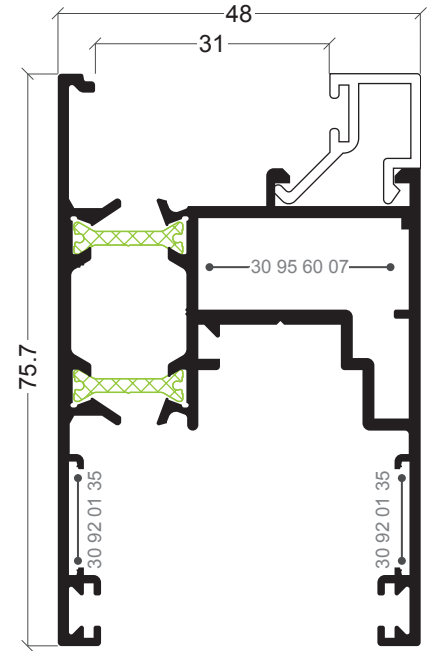

CW-04
Aro móvel perimetral
Hoja perimetral

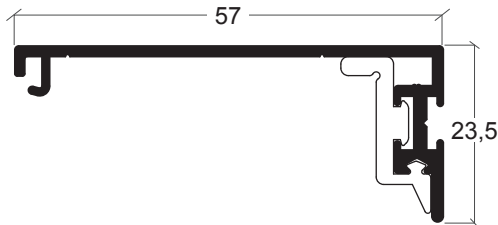

CW-26
Tampa de cruzamento CW minimal
Tope de cruce CW minimal

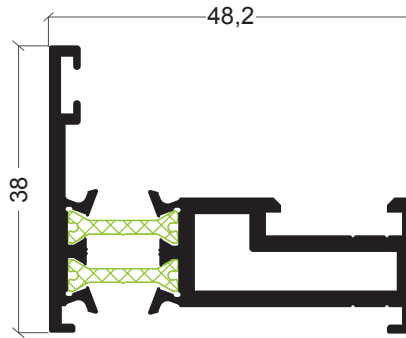

CW-24
Prumo Central CW minimal
Prumo Central CW minimal

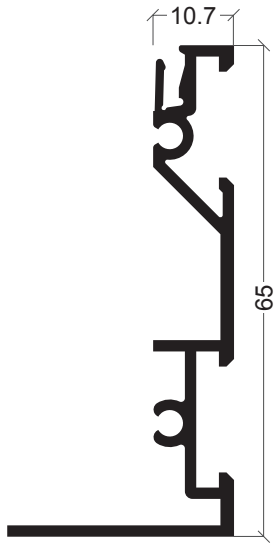

CW-11

Remate de isolamento
Remate de aislamiento

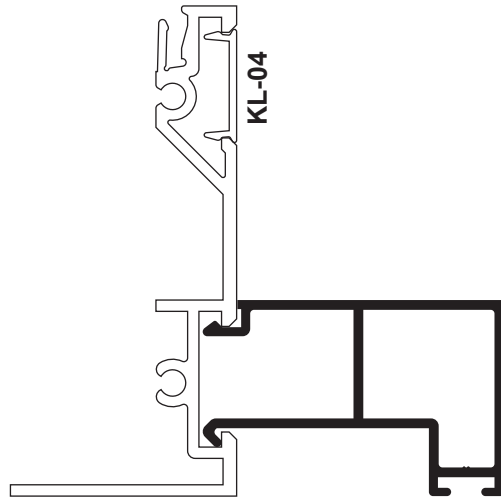

ARi-48

Bite
Junquillo

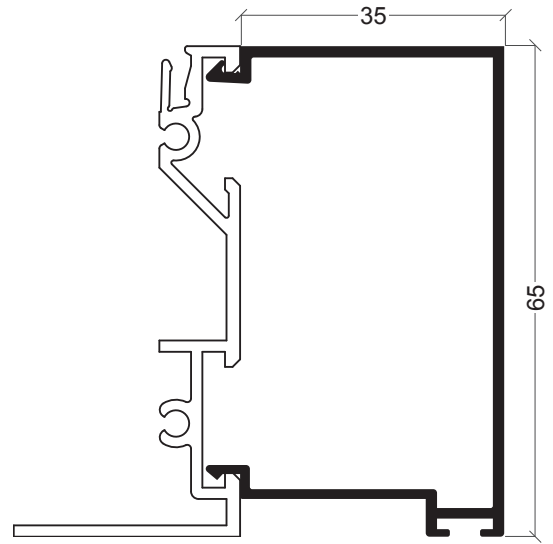

CW-12

Remate de Galandage
Remate de aislamiento

362

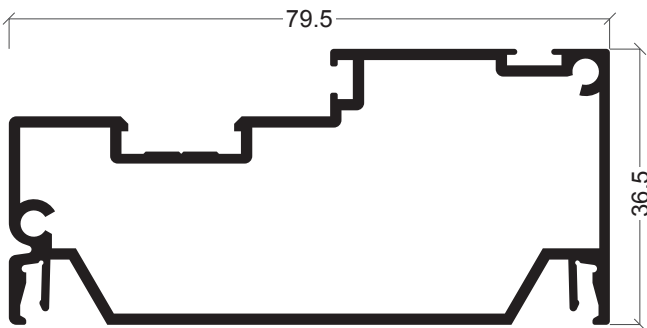

CW-13

Prumo de Cruzamento
Remate de aislamiento

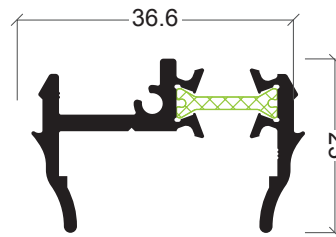

CTe-09

Perfil 4 folhas
Perfil 4 hojas

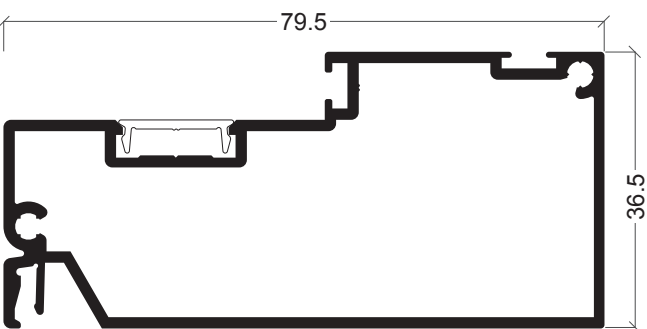

CW-28

Prumo de Cruzamento
Remate de aislamiento

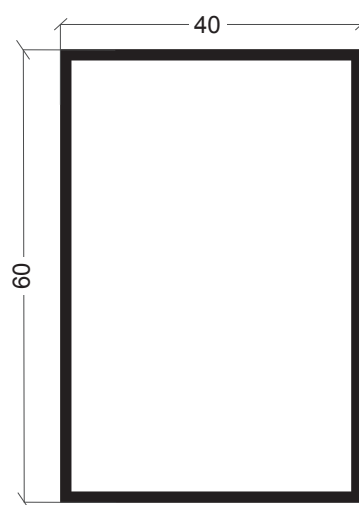

P-20

Perfil para gandalage
Perfil para gandalage

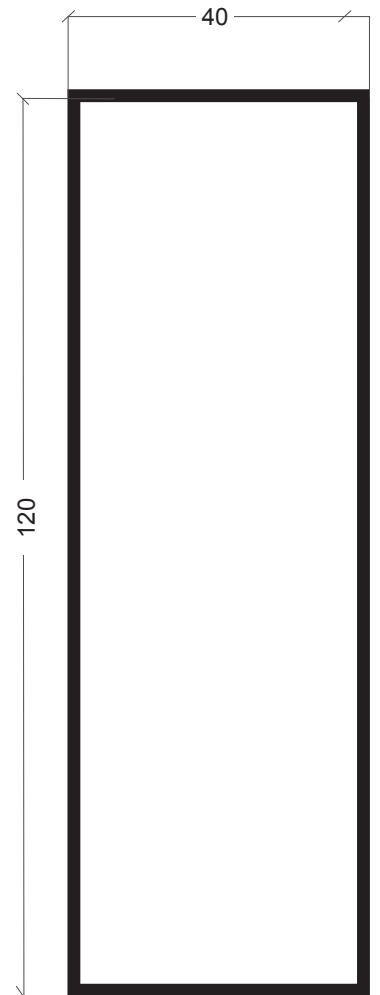

P-30

Perfil para gandalage
Perfil para gandalage

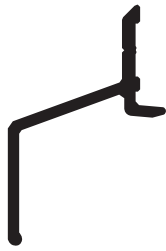

CT-29

Pingadeira superior
Viertaguas superior

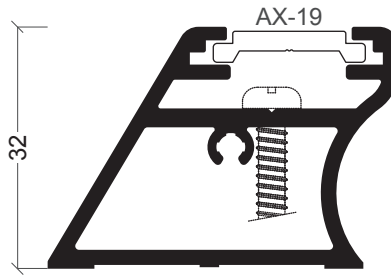

CT-28

Reforço
Refuerzo

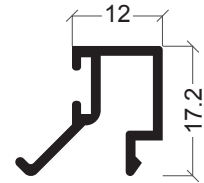

AX-70

Bite CW-04
Junquillo CW-04



CTe-03

Perfil guia
Guia marco carril inf. (AISI 304)

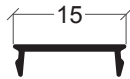

KL-04

Perfil complementar
Perfil tapa central

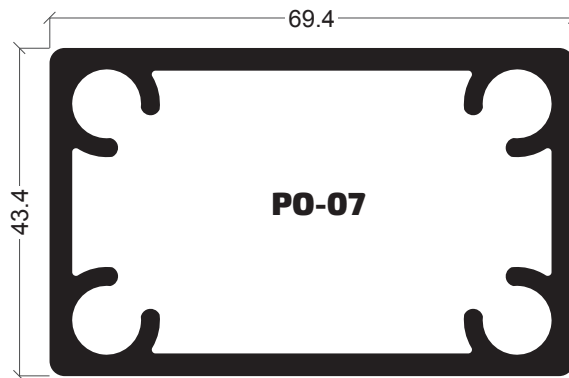

PO-07



CT-94

Perfil união
Perfil unión



AX-19

Vareta
Varilla

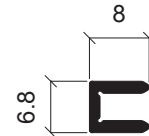

S-17

Perfil união
Perfil Unión



CW-15

Tampa
Tope

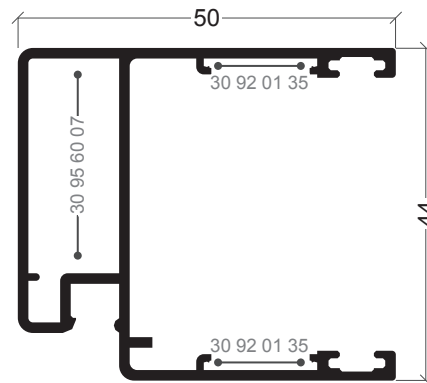

CW-14

Perfil para rede mosquiteira
Perfil para mosquiteira

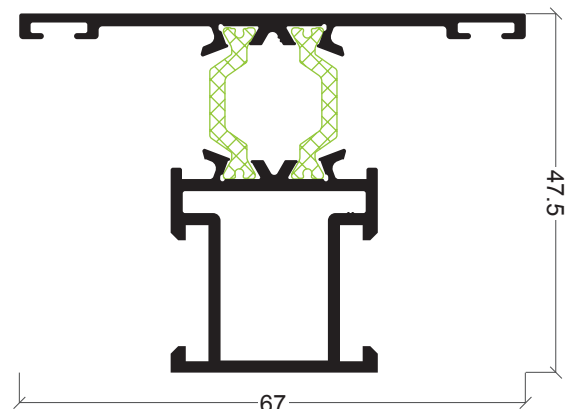

CW-16

Travessa
Travesaño 67x47.5mm

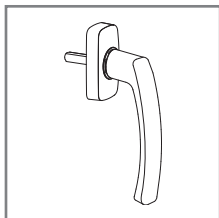

30 60 16 40/41

Puxador de alumínio branco/preto
Manilla de alumínio blanco/negro

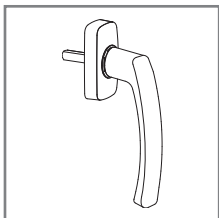

30 60 16 42/43

Puxador de alumínio 2 ac/champ ac
Manilla de alumínio 2 ac/champ ac

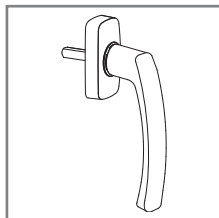

30 60 16 44

Puxador de alumínio inox ac
Manilla de alumínio inox ac

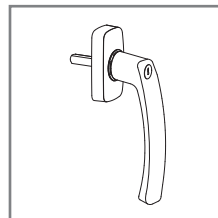

30 60 16 45/46/47

Puxador c/ chave de alumínio branco/preto/2AC
Manilla c/ llave de alumínio blanco/negro/2AC

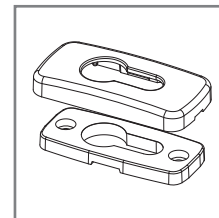

30 60 16 55/56

Escudo de alumínio branco/preto
Espejo de alumínio blanco/negro

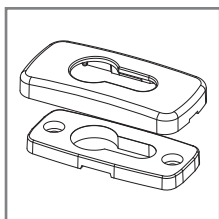

30 60 16 57/58

Escudo de alumínio 2 ac/champ ac
Espejo de alumínio 2 ac/champ ac

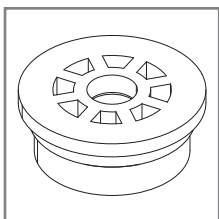

30 91 20 60

Canal
Desague carril inferior

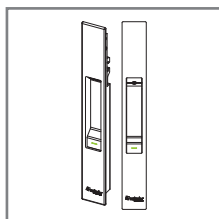

30 91 40 39/40/41

Fecho embutir manual (natural/branco/preto)
Cierre embutir manual (natural/blanco/negro)

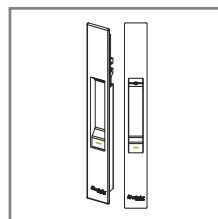

30 91 40 42/43/44

Fecho embutir automático (branco/preto/natural)
Cierre embutir automático (blanco/negro/natural)

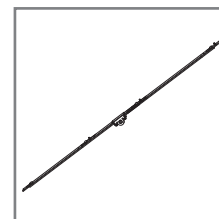

30 91 41 29

Barra multiponto 4 pontos (1800 mm)
Cierre multipunto 4 puntos (1800 mm)

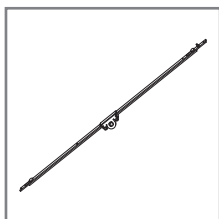

30 91 41 30

Barra multiponto 2 pontos (600 mm)
Cierre multipunto 2 puntos (600 mm)

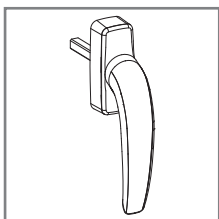

30 91 41 47/48

Cremone multiponto (branco/preto)
Cremona multipunto (blanco/negro)

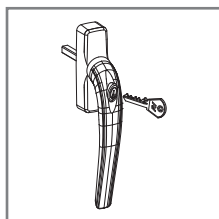

30 91 41 56/57

Cremone com chave multiponto (branco/preto)
Cremona con llave multipunto (blanco/negro)

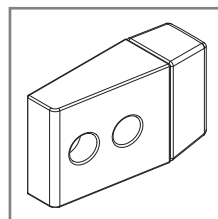

30 91 41 71

Topo limitador de abertura
Tope limitador de apertura

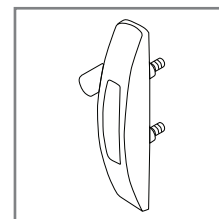

30 91 42 00/01

Fecho janela multiponto branco/preto
Cierre ventana multipunto blanco/negro

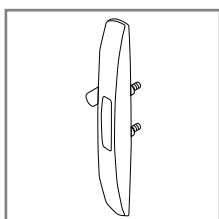

30 91 42 05/06

Fecho porta multiponto branco/preto
Cierre puerta multipunto blanco/negro

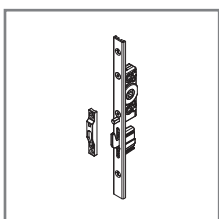

30 91 42 21

Barra multiponto inox c/ 2 pontos de fecho
Barra multipunto inox c/ 2 puntos de cierre

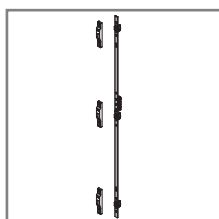

30 91 42 22

Barra Multiponto Inox c/ 3 pontos de fecho
Barra Multipunto Inox c/ 3 puntos de cierre

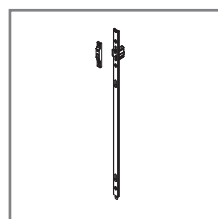

30 91 42 23

Extensão superior para multiponto inox
Extensión superior para multipunto inox

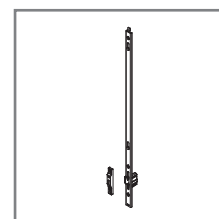

30 91 42 33

Extensão inferior para multiponto inox
Extensión inferior para multipunto inox

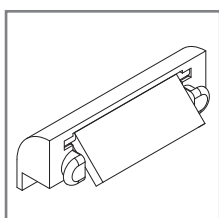

30 92 01 02/03

Goteira (preto/branco)
Tapa salida de aguas con deflector (negro/blanco)

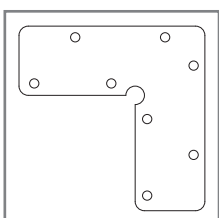

30 92 01 35

Esquadro de alinhamento
CW-01/02/03/04/05/08/09
Escuadra de alineamiento
CW-01/02/03/04/05/08/09

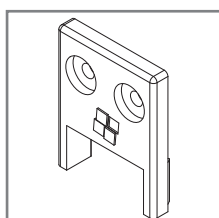

30 94 50 35

Tampa guia móvel recta CW-06
Tope guia hoja recta CW-06

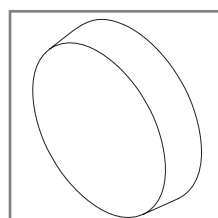

30 94 50 36

Tapa preta para parafuso cabeça de queijo 9.3
Tapa para 30 94 50 35

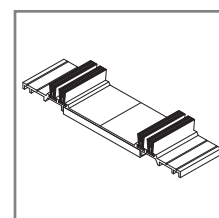

30 94 50 41

Cortavento superior elevável
Cortaviento superior elevable

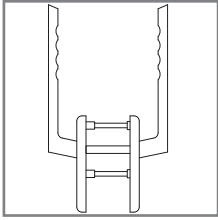

30 94 52 00/01/02/03

Puxador duplo para correr-elevatória (natural/preto/inox/branco)
Manilla doble para corredera elevable (natural/negro/inox/blanco)

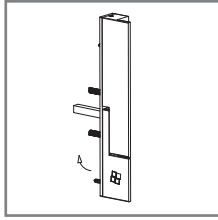

30 94 60 97/98

Fecho Minimalista direito branco/preto
Cierre Minimalista derecho blanco/negro

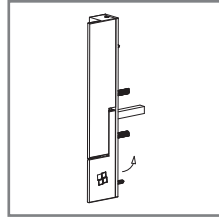

30 94 60 99/30 94 61 00

Fecho Minimalista esquerdo branco/preto
Cierre Minimalista izquierdo blanco/negro

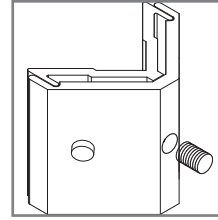

30 95 60 07

Esquadro 27x12 mm centrado
Escuadra 27x12 mm centrada

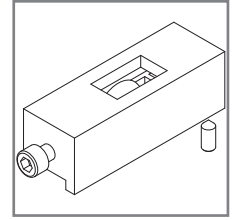

30 95 60 08

Rolamento simples regulável CW
(50 kg por rolamento)
Rodamiento simple regulable
(50 kg rodamiento)

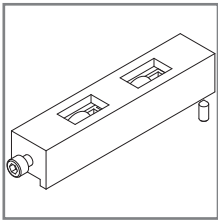

30 95 60 09

Rolamento duplo regulável CW
(100 kg por rolamento)
Rodamiento doble regulable CW
(100 kg por rodamiento)

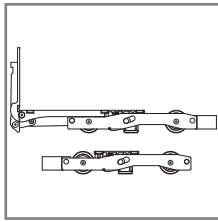

30 95 60 10

Conjunto rolamentos elevável 250kg
Conjunto rodamientos elevable 250kg

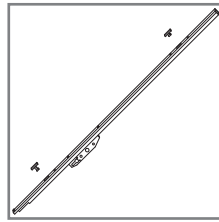

30 95 60 11

Ferragem correr/elevatória 170
Herraje corredera/elevable 170

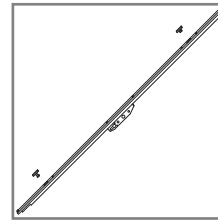

30 95 60 12

Ferragem correr/elevatória 220
Herraje corredera/elevable 220

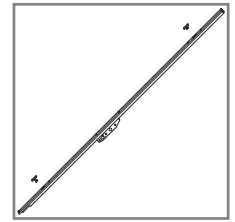

30 95 60 13

Ferragem correr/elevatória 260
Herraje corredera/elevable 260

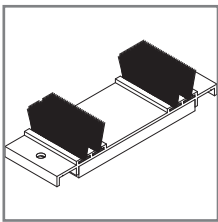

30 95 60 14

Corta-vento inferior/superior
Cortaviento inferior/superior

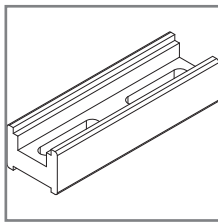

30 95 60 15

Calço multiponto nº 4
Calzo multipunto nº 4

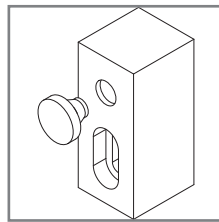

30 95 60 16

Batente lateral
Batiente lateral

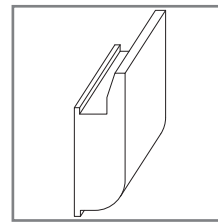

30 95 60 17

Guia
Guia

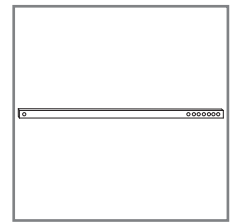

30 95 60 18/19/20

Barra de ligação 150/200/250
Barra de ligación 150/200/250

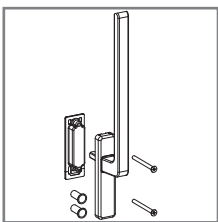

30 95 60 21/22/23/24/25

Conjunto puxador elevável
(natural/preto/branco/inox/bronze)
Conjunto manilla elevable
(natural/negro/blanco/inox/bronze)

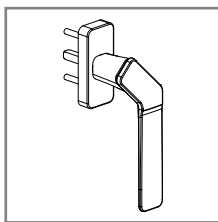

30 95 60 26/28

Puxador desviado M-P direito branco/preto
Manilla desplazado MP derecho blanco/negro

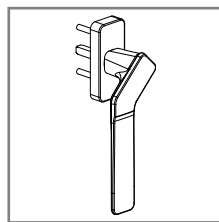

30 95 60 27/29

Puxador desviado M-P esquerdo branco/preto
Manilla desplazado MP izquierdo blanco/negro

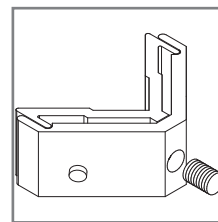

30 95 60 31

Esquadro 15x12 mm exterior
Escuadra 15x12 mm exterior

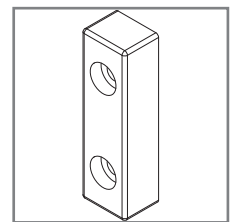

30 95 60 34

Calço 3/4 folhas
Calzo 3/4 hojas

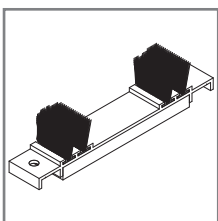

30 95 60 35

Corta-vento inferior/superior galvanizado
Cortaviento inferior/superior galvanizado

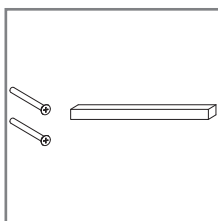

30 95 60 36

Conjunto perno + parafuso para puxador
multiponto desviado duplo
Conjunto perno + tornillo para manilla multipunto
desplazado doble

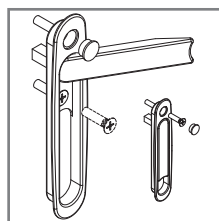

30 95 60 37/38

Fecho rotativo multiponto branco/preto
Cierre rotativo multipunto blanco/negro

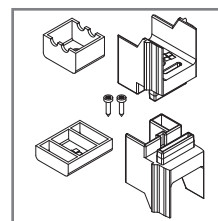

30 95 60 42

Topo para CTe-09 4 folhas elevável preto
Tope para CTe-09 4 hojas corredera elevable

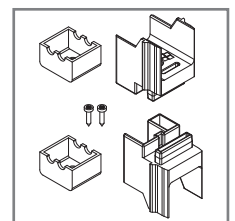

30 95 60 43

Topo para CTe-09 4 folhas correr preto
Tope para CTe-09 4 hojas corredera

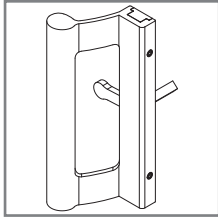

30 95 60 44/45/46

Puxador multiponto branco/preto/anodizado natural
Manilla multipunto blanco/negro/anodizado natural

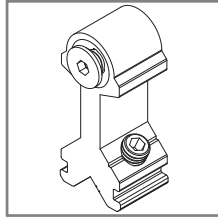

30 95 60 48

União travessa interior CW-24
Unión travessa interior CW-24

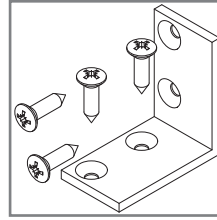

30 95 60 49

Canto Exterior CW-24
Canto Exterior CW-24

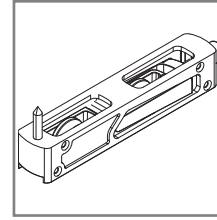

30 95 60 50

Rolamentos Duplo Regulável CW(150Kg por rolamento)
Rodamientos Doble Regulable CW (150Kg por rodamiento)

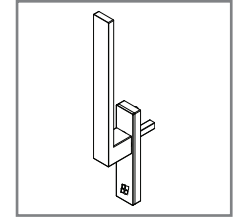

30 95 60 51/52

Puxador elevável recto branco/preto
Manilla elevable recto blanco/negro

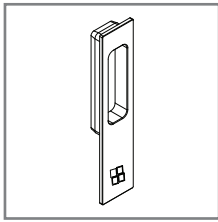

30 95 60 53/54

Concha p/ puxador elevável recto branco/preto
Uñero p/ manilla elevable recto blanco/negro

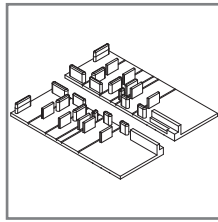

30 95 60 60

Conjunto de vedação preto
Conjunto de vedación negro

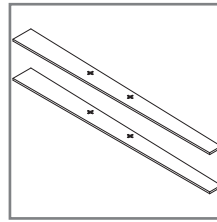

30 95 60 61

Conjunto de juntas
Conjunto de juntas

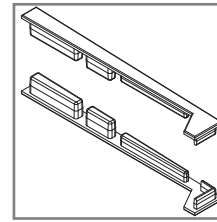

30 95 60 62

Conjunto de topos S-36
Conjunto de topos S-36

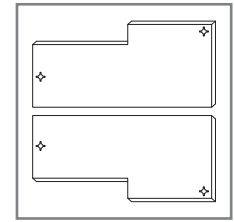

30 95 60 63

Conjunto de Juntas de estanquidade CW-28
Conjunto de Juntas de estanquidad CW-28

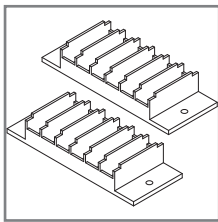

30 95 60 64

Conjunto de corta-ventos cw preto
Conjunto de corta-vientos cw negro

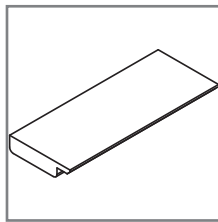

30 95 60 65

Suporte p/calço de vidro CW-02/04
Soporte p/calço de vidrio CW-02/04

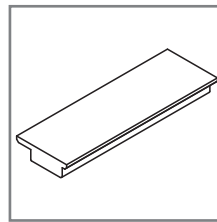

30 95 60 66

Suporte p/calço de vidro CW-16
Soporte p/calço de vidrio CW-16

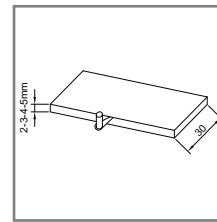

30 95 60 72/73/74/75

Calço de vidro 2/30 3/30 4/30 5/30
Calço de vidrio 2/30 3/30 4/30 5/30

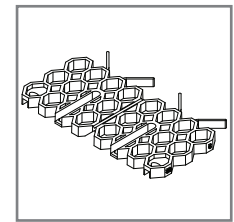

30 95 60 76

Suporte BOK para vidro CW-3
Soporte BOK para vidrio CW-3

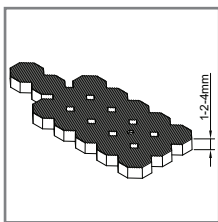

30 95 60 77/78/79

Calço BOK para vidro 1mm/2mm/4mm
Calço BOK para vidrio 1mm/2mm/4mm

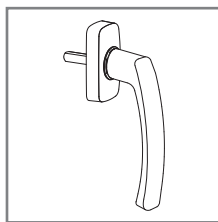

31 70 16 40

Puxador de alumínio em bruto
Manilla de aluminio crudo

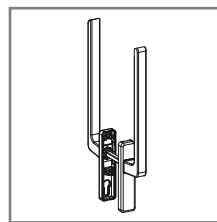

31 90 85 54

Conjunto puxador duplo elevável (para cores lacado)
Conjunto manilla doble elevable (para colores lacado)

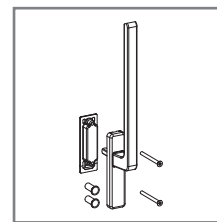

31 90 85 55

Conjunto puxador elevável (para cores lacado)
Conjunto manilla elevable (para colores lacado)

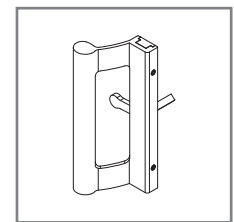

31 90 85 62

Asa Multiponto (cores)
Asa Multipunto(colores)

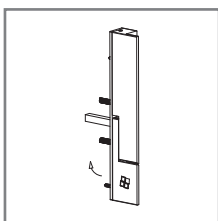

31 94 60 25

Fecho Minimalista Direito
Cierre Minimalista Derecho

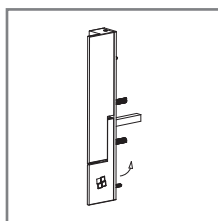

31 94 60 26

Fecho Minimalista Esquerdo
Cierre Minimalista Izquierdo

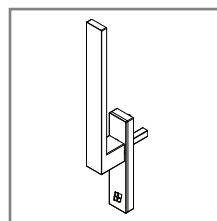

31 95 60 51

Puxador elevável recto cores
Manilla elevable recto cores

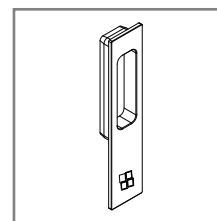

31 95 60 53

Concha p/ puxador elevável recto branco/preto
Uñero p/ manilla elevable recto blanco/negro

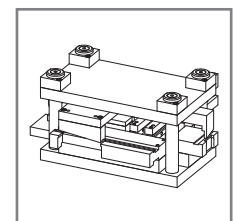





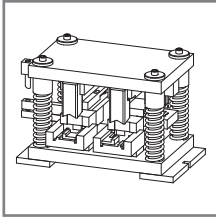





















33 92 29 99

Cunho CW
Troquel CW

33 92 30 00

 Cunho CW minimal
 Troquel CW minimal

REFERÊNCIA • REFERENCIA	DESENHO • DISEÑO	DESCRIÇÃO • DESCRIPCIÓN
30 20 26 03		Junta interior/exterior • Junta interior/exterior
30 93 00 60		Junta exterior do vidro • Junta exterior vidrio
30 93 00 61		Junta vedação exterior vidro 2 mm • Junta estanqueidad exterior vidrio 2 mm
30 93 00 62		Junta plana para vidro • Junta plana para vidrio
30 93 00 65		Junta interior para vidro (5 mm) • Junta interior para vidrio (5 mm)
30 93 00 66		Junta interior para vidro (4 mm) • Junta interior para vidrio (4 mm)
30 93 00 67		Junta interior para vidro (2 mm) • Junta interior para vidrio (2 mm)
30 93 00 68		Junta interior para vidro (6/7 mm) • Junta interior para vidrio (6/7 mm)
30 93 00 69		Junta interior para vidro (8/9 mm) • Junta interior para vidrio (8/9 mm)
30 94 01 46		Junta para CW-13 • Junta para CW-13
30 94 60 12		Pelúcia tri-fin • Burlete tri-fin
30 95 00 10		Pelúcia 7x9 mm • Burlete 7x9 mm
30 95 00 40		Pelúcia 7x5.5 mm • Burlete 7x5.5 mm
30 95 60 01		Junta tapa canal central • Junta tapa canal central
30 95 60 02		Junta tapa canal aro fixo • Junta tapa canal marco
30 95 60 03		Junta vedação aro móvel • Junta estanqueidad hoja
30 95 60 04		Junta central CW-02 • Junta central CW-02
30 95 60 05		Junta central CW-03/04 • Junta central CW-03/04
30 95 60 06		Junta em U para vidro de 30 mm • Junta en U para vidrio de 30 mm
30 95 60 30		Junta isolante CW • Junta aislante CW
30 95 60 47		Junta central CW-24 + CW-26 • Junta central CW-24 + CW-26
30 60 00 17		Junta Exterior vidro plana 2mm preto • Junta exterior vidrio plana 2mm negro
30 94 01 46		Junta interior e exterior • Junta interior e exterior
30 95 00 30		Pelúcia 7x7 FIN • Burlete 7x7 FIN

REFERÊNCIA • REFERENCIA	DESENHO • DISEÑO	APLICAÇÃO • APLICACIÓN
30 99 00 14		CW-01; CW-05; CW-07; CW-08; CW-09; CW-10; CW-17; CW-18; CW-19; CW-20; CW-21; CW-22 e CW-23;
30 99 00 15		CW-02; CW-03; CW-04;
30 99 00 16		CW-02 ou CW-24;

Janela 2 folhas correr - Conceito Minimalista

Ventana 2 hojas corredera - Concepto Minimalista

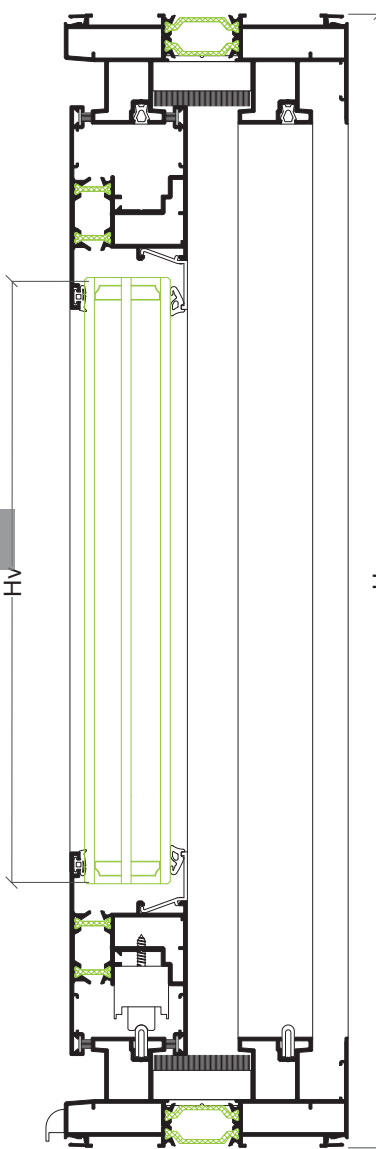
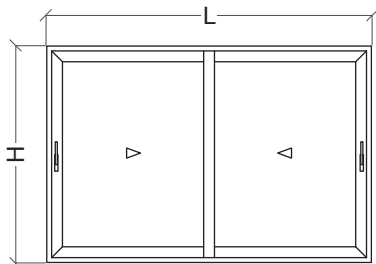

PERFIS • PERFIS

DESENHO • DISEÑO	REF.	DESCRIÇÃO • DESCRIPCIÓN	CORTE CORTE	QUANTIDADE CANTIDAD	MEDIDAS • MEDIDA
	CW-20	Aro fixo perimetral • Marco perimetral		2	L
			2	H	
	CW-02	Aro móvel perimetral • Hoja perimetral		4	L/2-38 mm
			2	H-75 mm	
	CW-24	Aro fixo CW Minimal • Marco CW Minimal		2	H-75 mm
	CW-26	Tampa de cruzamento minimal • Tope de cruce minimal		2	H-75 mm
	CTe-03	Perfil guia • Perfil guia		2	L-74 mm
	---	Bite horizontal • Junquillo horizontal		4	L/2-101 mm
	---	Bite vertical • Junquillo vertical		4	H-241.5 mm

ACESSÓRIOS E JUNTAS • ACCESORIOS Y JUNTAS

REF.	DESCRIÇÃO • DESCRIPTION	QUANTIDADE CANTIDAD
30 95 60 07	Esquadro • Escuadra	12
30 92 01 35	Esquadro de alinhamento • Escuadra de alineamiento	12
30 95 60 64	Conjunto Corta-vento CW preto • Conjunto de corta-vientos cw negro	1
30 95 60 16	Batente lateral • Batiente lateral	4
30 94 50 35	Tampa guia • Tapa guia	4
30 92 01 02	Goteira com válvula (preto) • Tapa salida de aguas con deflector (negro)	diversas • diversas
30 94 50 36	Tampa parafuso • Tapón tornillo	8
30 95 60 45	Asa Multiponto (preto) • Multicierre (negro)	1
30 95 60 38	Fecho rotativo multiponto preto • Cierre rotativo multicierre negro	1
30 91 41 30	Ferragem multiponto 600mm • Herraje multicierre 600mm	2
30 95 60 15	Calço multiponto nº4 • Calzo multipunto nº4	8
30 91 41 71	Limitador • Limitador	1
30 95 60 09	Rolamento duplo regulável • Doble rodamiento regulable	4
30 95 60 48	União travessa interior CW-24 • Unión travessaño inferior CW-24	4
30 95 60 49	Canto exterior CW-24 • Canto exterior CW-24	4
30 95 00 40	Pelúcia 7x5.5 fin-seal • Burlete 7x5.5 fin-seal	4L+2H
30 95 60 01	Junta tapa canal central • Junta tapa canal central	2L+2H
30 95 60 02	Junta tapa canal • Junta tapa canal	2L+4H
30 95 60 03	Junta de vedação • Junta de estanqueidad	4H
30 95 60 47	Junta central CW-24+CW-26 • Junta central CW-24+CW-26	2H
30 95 60 17	Guia • Guia	12
---	Junta exterior para vidro • Junta exterior para vidrio	2L+4H
---	Junta interior para vidro • Junta interior para vidrio	2L+4H





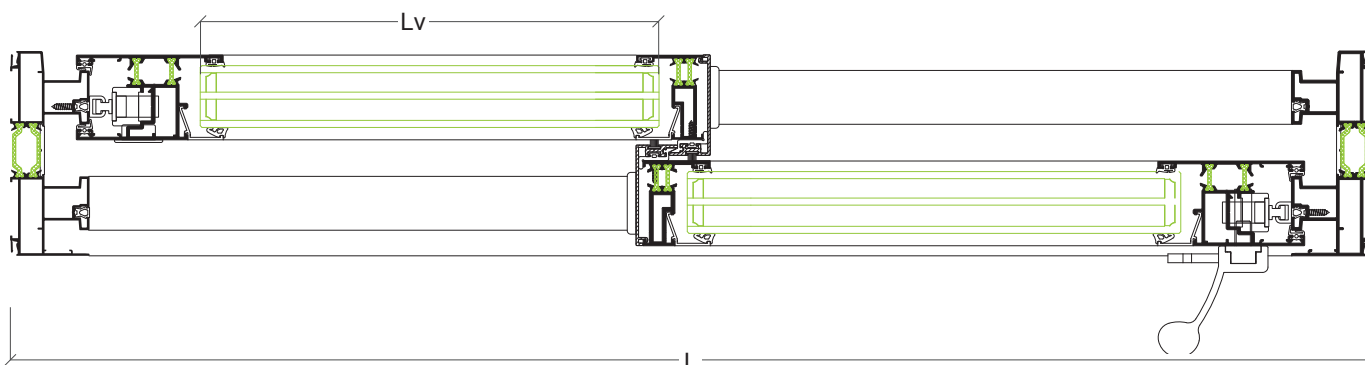





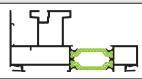

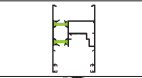

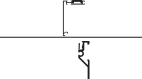

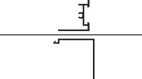

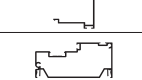







VIDRO • VIDRIO

Hv = H-215 mm	Lv = L/2-116 mm
---------------	-----------------

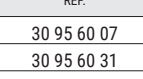

Porta 1 folha galandage • Puerta 1 hoja galandage

PERFIS • PERFIS

DESENHO • DISEÑO	REF.	DESCRIÇÃO • DESCRIPCIÓN	CORTE CORTE	QUANTIDADE CANTIDAD	MEDIDAS • MEDIDA
	CW-07	Aro fixo perimetral Marco monocarril galandage		2	(Lx2)+112 mm
			2	H+15 mm	
	CW-03	Aro móvel perimetral • Hoja perimetral		2	L+52 mm
			2	H-60 mm	
	CW-06	Tampa de cruzamento • Tapa de cruce		1	H-60 mm
	CW-11	Remate de isolamento Perfil para aislamiento		1	L+167 mm
			2	H-39 mm	
	CW-12	Remate de Galandage Remate de aislamiento		1	L+106 mm
			2	L+106 mm	
	CW-13	Prumo de cruzamento Remate de aislamiento		1	H-24 mm
	CTe-03	Perfil guia • Perfil guia		1	(Lx2)+38 mm
	KL-04	Perfil tampa central • Perfil tapa central		1	H-24 mm
			1	H-60 mm	
	AXi-88	Remate lateral de isolamento exterior Complemento solape		1	(Lx2)+126 mm
			2	H+45 mm	
	AXi-88	Remate lateral de isolamento interior Complemento solape		1	L+188 mm
			2	H+1.5 mm	
	AXi-91	Remate lateral de isolamento interior Complemento solape		1+1	L

ACESSÓRIOS E JUNTAS • ACCESORIOS Y JUNTAS







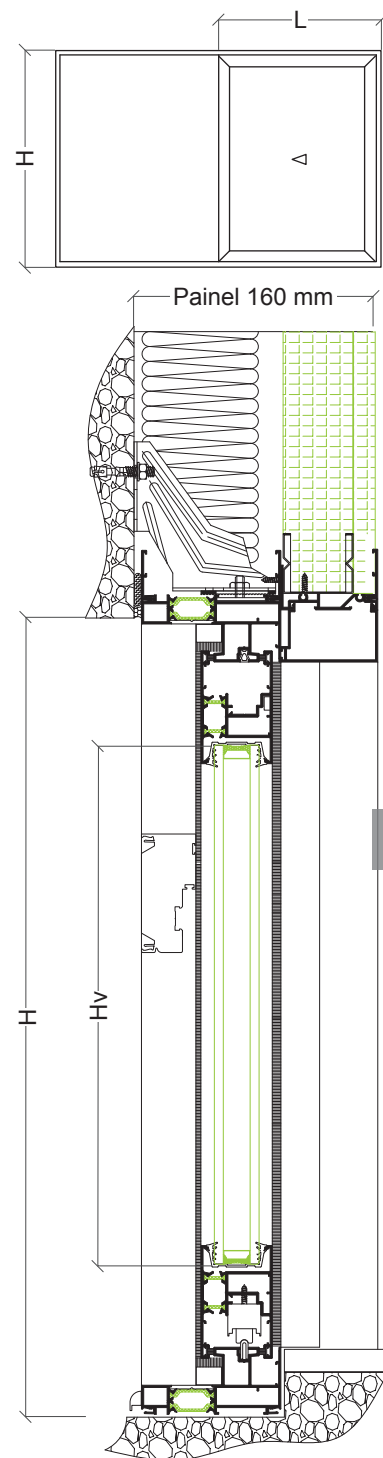
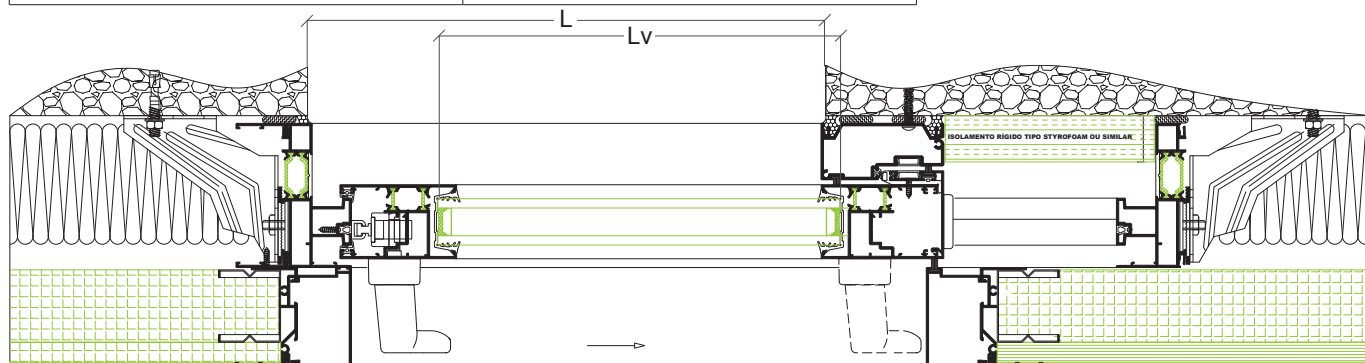

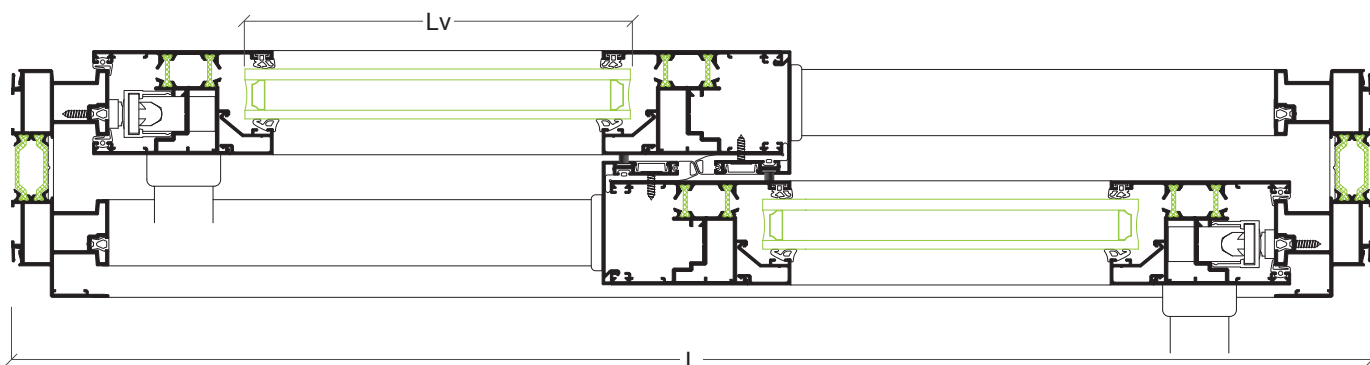
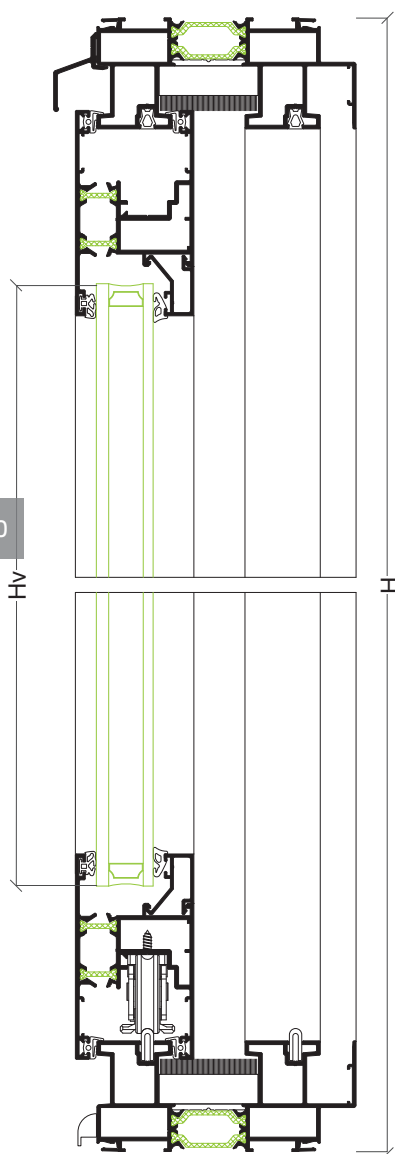
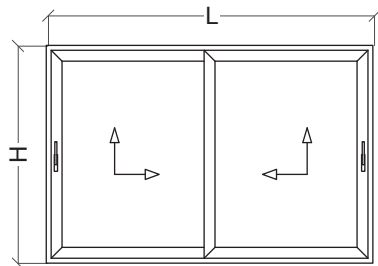

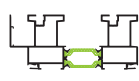

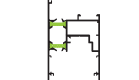

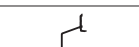

REF.	DESCRIÇÃO • DESCRIPTION	QUANTIDADE • CANTIDAD
30 95 60 07	Esquadro • Escuadra	8
30 95 60 31	Esquadro exterior • Escuadra exterior	4
30 92 01 35	Esquadro alinhamento • Escuadra alineamiento	18
30 95 60 35	Corta-vento inferior/superior mono-rail • Cortaviento inferior/superior monocarril	2
30 95 60 16	Batente lateral • Batiente lateral	2
30 94 50 35	Tampa guia • Tapa guia	2
30 92 01 02	Goteira com válvula (preto) • Tapa salida de agua con deflector (negro)	diversas • diversas
30 91 41 48	Puxador preto • Manilla negro	1
30 95 60 09	Rolamento duplo regulável • Rodamiento doble regulable	2
30 91 41 30	Ferragem multiponto 600 mm • Herraje multipunto 600 mm	2
30 95 60 15	Calço MP nº 4 • Calzo MP nº 4	4
30 95 00 40	Pelúcia 7x5.5 mm fin-seal • Burlete 7x5.5 mm fin-seal	4L+2H
30 95 60 01	Junta tapa-canal central • Junta tapa-canal central	4L+2H
30 95 60 02	Junta tapa-canal • Junta tapa-canal	4L+4H
30 95 60 03	Junta de vedação • Junta de estanqueidad	2H
30 95 60 05	Junta central CW-03/04 • Junta central CW-03/04	H
30 59 60 06	Junta para vidro (30 mm) • Junta para vidrio (30 mm)	2L+2H
30 94 01 46	Junta para CW-13 • Junta para CW-13	H
30 95 00 10	Pelúcia 7x9 mm • Burlete 7x9 mm	H
30 94 01 46	Junta para CW-13 • Junta para CW-13	H
30 95 60 17	Guia • Guia	6
30 91 20 60	Canal • Desaque carril inferior	2
30 95 60 63	Conjunto de Juntas de estanqueidad • Conjunto de Juntas de estanqueidad	1

VIDRO • VIDRIO

Hv = H-186 mm	Lv = L-75 mm
---------------	--------------

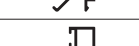

Porta 2 folhas correr elevável • Puerta 2 hojas corredera elevadora

PERFIS • PERFIS

DESENHO • DISEÑO	REF.	DESCRIÇÃO • DESCRIPCIÓN	CORTE CORTE	QUANTIDADE CANTIDAD	MEDIDAS • MEDIDA
	CW-01	Aro fixo perimetral Marco perimetral con recogida		2	L
				2	H
	CW-02	Aro móvel perimetral • Hoja perimetral		4	L/2+2 mm
				4	H-75 mm
	CW-06	Tampa de cruzamento • Tapa de cruce		2	H-75 mm
	CTe-03	Perfil guia • Perfil guia		2	L-74 mm
	CT-29	Pingadeira • Viertaguas superior		1	L
	KL-04	Perfil tampa central • Perfil tapa central		2	H-75 mm
	---	Bite horizontal • Junquillo horizontal		4	L/2-124.5 mm
	---	Bite vertical • Junquillo vertical		4	H-241.5 mm











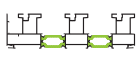

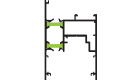



ACESSÓRIOS E JUNTAS • ACCESORIOS Y JUNTAS

REF.	DESCRIÇÃO • DESCRIPTION	QUANTIDADE CANTIDAD
30 95 60 07	Esquadro • Escuadra	16
30 92 01 35	Esquadro de alinhamento • Escuadra de alineamiento	20
30 95 60 14	Corta-vento inferior • Cortaviento inferior/superior	1
30 94 50 41	Corta-vento superior (elevável) • Corta viento superior (elevable)	1
30 94 50 35	Tampa guia • Tapa guía	4
30 92 01 02	Goteira com válvula (preto) • Tapa salida de aguas con deflector (negro)	diversas • diversas
30 95 60 XX	Ferragem correr/elevatória • Ferrage correr/elevable	2
30 95 60 10	Conjunto rolamentos elevável • Conjunto rodamientos elevable	2
30 95 60 XX	Conjunto puxador elevável • Conjunto manilla elevable	2
30 95 60 XX	Barra de ligação • Bar de ligación	2
30 91 41 71	Limitador • Tope limitador de apertura	1
30 95 00 40	Pelúcia 7x5.5 mm fin-seal • Burlete 7x5.5 mm fin-seal	2H
30 95 60 01	Junta tapa-canal central • Junta tapa-canal central	2L+2H
30 95 60 02	Junta tapa-canal • Junta tapa-canal	2L+4H
30 95 60 03	Junta de vedação • Junta de estanqueidad	4L+4H
30 95 60 04	Junta central CW-02 • Junta central CW-02	2H
---	Junta exterior para vidro • Junta exterior para vidrio	2L+4H
---	Junta interior para vidro • Junta interior para vidrio	2L+4H
30 95 60 16	Batente Lateral • Practicable Lateral	2
30 95 60 17	Guia • Guía	12

VIDRO • VIDRIO

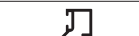
Hv = H-215 mm	Lv = L/2-138 mm
---------------	-----------------

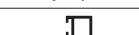
Porta 3 folhas correr tri-rail • Puerta 3 hojas corredera 3 carriles
PERFIS • PERFIS

DESENHO • DISEÑO	REF.	DESCRIÇÃO • DESCRIPCIÓN	CORTE CORTE	QUANTIDADE CANTIDAD	MEDIDAS • MEDIDA
	CW-09	Aro fixo tri-rail perimetral • Marco tricarril		2	L
				2	H
	CW-02	Aro móvel perimetral • Hoja perimetral		6	L/3+28 mm
				6	H-75 mm
	CW-06	Tampa de cruzamento • Tapa de cruce		4	H-75 mm
	CTe-03	Perfil guia • Guia marco carril inferior		3	L-74 mm
	CT-29	Pingadeira • Vientaguas superior		1	L
	KL-04	Perfil tampa central • Perfil tapa central		4	H-75 mm
	---	Bite horizontal • Junquillo horizontal		6	L/3-98.5 mm
	---	Bite vertical • Junquillo vertical		6	H-241.5 mm

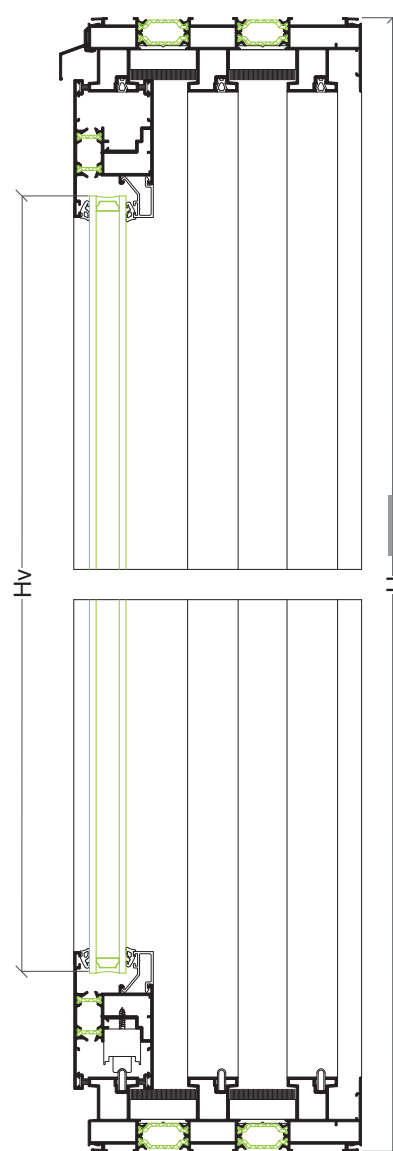
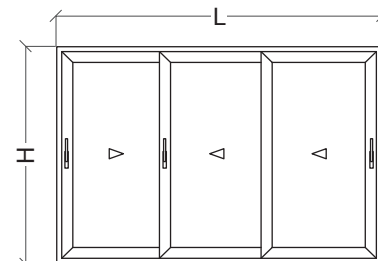
ACESSÓRIOS E JUNTAS • ACCESORIOS Y JUNTAS

REF.	DESCRIÇÃO • DESCRIPTION	QUANTIDADE CANTIDAD
30 95 60 07	Esquadro • Escuadra	24
30 92 01 35	Esquadro de alinhamento • Escuadra de alineamiento	28
30 95 60 14	Corta-vento inferior/superior • Cortaviento inferior/superior	4
30 95 60 16	Batente lateral • Batiente lateral	4
30 94 50 35	Tampa guia • Tapa guía	8
30 92 01 02	Goteira com válvula (preto) • Tapa salida de aguas con deflector (negro)	diversas • diversas
30 95 60 29	Puxador desviado esquerdo (preto) • Manilla desplazado izquierdo (negro)	1
30 95 60 28	Puxador desviado direito (preto) • Manilla desplazado derecho (negro)	1
30 91 41 30	Ferragem multiponto 600 mm • Herraje multipunto 600 mm	2
30 95 60 15	Calço MP nº 4 • Calzo MP nº 4	8
30 91 41 71	Limitador • Tope limitador de apertura	2
30 95 60 09	Rolamento duplo regulável • Rodamiento doble regulable	6
30 95 00 40	Pelúcia 7x5.5 mm fin-seal • Burlete 7x5.5 mm fin-seal	4H+4L
30 95 60 01	Junta tapa-canal central • Junta tapa-canal central	4L+4H
30 95 60 02	Junta tapa-canal • Junta tapa-canal	3L+6H
30 95 60 03	Junta de vedação • Junta de estanqueidad	4H
30 95 60 04	Junta central CW-02 • Junta central CW-02	4H
---	Junta exterior para vidro • Junta exterior para vidrio	2L+6H
---	Junta interior para vidro • Junta interior para vidrio	2L+6H
30 95 60 17	Guia • Bisagra	18

VIDRO • VIDRIO

Hv = H-215 mm	Lv = L/3-113 mm
---------------	-----------------

