

[www.anicolor.pt](http://www.anicolor.pt)

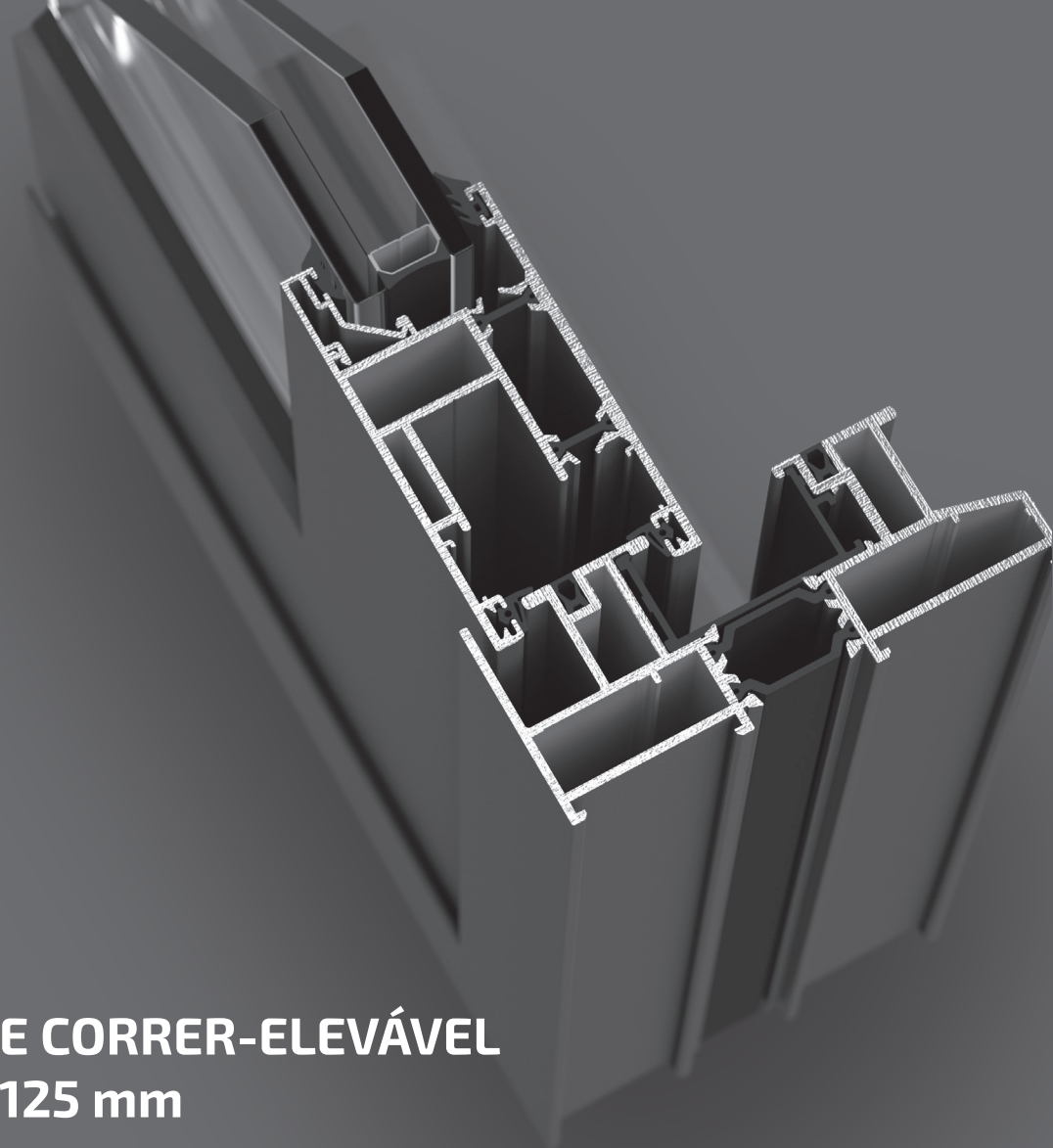

**SISTEMA DE CORRER-ELEVÁVEL  
COM RPT - 125 mm**

**SISTEMA CORREDERA-ELEVABLE  
CON RPT - 125 mm**

**CTe**

 **anicolor**  
Sistemas de Alumínio

## SISTEMA CTe

### Sistema de correr elevatório com RPT - 125 mm

#### CARACTERÍSTICAS DO SISTEMA

Sistema de alumínio com rotura térmica para executar vãos de correr eleváveis.

#### PERFIS DE ALUMÍNIO

Os perfis de alumínio são extrudidos na liga de alumínio 6060 para arquitetura de acordo com norma NP EN 12020-02.  
 Perfis com rotura térmica obtida por inserção de varetas isolantes de poliamida de 6.6 mm reforçadas com 25% de fibra de vidro de 24 mm ou 30 mm nos aros fixos e de 14.6 mm nos aros móveis.  
 Espessura média dos perfis de alumínio de 2 mm.

#### AROS FIXOS

Secção dos aros fixos de 2 guias de 127.4 mm para montagem em corte recto;  
 Secção dos aros fixos de 3 guias (tri-rail) de 189.4 mm para montagem em corte recto;  
 Secção do aro fixo perimetral de 2 guias de 123 mm para montagem a meia esquadria;  
 Secção do aro fixo perimetral de 3 guias (tri-rail) de 185 mm para montagem a meia esquadria;  
 Perfil guia de deslizamento inferior em aço inoxidável AISI 304 para evitar desgaste das peças.

#### AROS MÓVEIS

Secção dos aros móveis perimetrais de 50.6 mm com montagem a meia esquadria;  
 Enchimento de 4 a 38 mm;  
 Aros móveis de linha recta ou curva;  
 Bites rectos ou curvos;  
 Estanquidade assegurada através de juntas em EPDM e pelúcia tipo Fin-Seal.

#### DIMENSIONAMENTO E MANOBRABILIDADE

Dimensões mínimas - máximas de folha: 720 mm - 3350 mm (L); 1190 mm - 2690 mm (H) com opção de 3325 mm com prolongador;  
 Peso máximo de 300 kg por folha com a ferragem base, com opção de 400 kg por folha com kit suplementar;  
 Tipologias de 2, 3, 4 e 6 folhas móveis e/ou fixas;  
 Sistema de correr elevável com funcionamento baseado numa ferragem montada em conjunto nas folhas e que permite a elevação destas aquando da sua abertura, mesmo com configurações extremas de peso ou dimensão. Quando fechada a folha comprime as juntas em EPDM permitindo uma estanquidade perimetral perfeita;  
 Ferragem base com 2 pontos de fecho e possibilidade de adicionar mais 1 ou 2 pontos suplementares;  
 Ferragem base com micro ventilação;  
 Ferragem constituída por carrinhos de 4 rodas em pvc reforçadas com fibra de vidro e rolamentos de agulha de alta prestação;  
 Puxador específico para facilitar as manobra de abertura e fecho do vão;  
 Existe a opção de puxador duplo com colocação de canhão com chave para permitir a abertura pelo exterior.

#### PERFORMANCES

Sistema certificado por laboratório credenciado, notificado para Ensaio Tipo Inicial (ITT) de acordo com a norma de produto EN 14351-1 para efeitos de Marcação CE.

Categorias alcançadas na avaliação do sistema CTe:

1. Permeabilidade ao ar: Classe 3 (norma de ensaio EN 10207 e EN 1026)
2. Estanquidade à água: Classe 7A (norma de ensaio EN 12208 e EN 1027)
3. Resistência ao vento: Classe C2 (norma de ensaio EN 12208 e EN 12211)

Coefficiente de transmissão térmica de vão de 2 folhas com 5.0 m x 2.5 m com vidro Ug = 0.7 W/m<sup>2</sup>K, com intercalar efeito "Warm Edge": Uw = 1.37 W/m<sup>2</sup>K

Coefficiente de atenuação acústica de vão de 2 folhas com vidro acústico 6/16/44.1: Rw (C; Ctr) = 41 dB (-1; -5)

Zonas de aplicação segundo RCCTE (em função do valor Ug): I1, I2, I3, V1, V2, V3.

## SISTEMA CTe

### Sistema corredera-elevable con RPT - 125 mm

#### CARACTERÍSTICAS DEL SISTEMA

Sistema de aluminio con rotura térmica para ejecución de huecos de correr elevables.

#### PERFILES DE ALUMINIO

Los perfiles de aluminio son extruidos en aleación de aluminio 6060 para arquitectura de acuerdo con la norma NP EN 12020-02.  
 Perfiles con rotura térmica obtenida por inserción de varillas aislantes de poliamida, reforzadas con 25% de fibra de vidrio, con 24mm u 30mm en los marcos y 14.6mm en las hojas.  
 Espesor medio de los perfiles de aluminio de 2mm.

#### MARCOS

Profundidad de los marcos de 2 guias de 127.4 mm para montaje en corte recto;  
 Profundidad de los marcos de 3 guias (tricaril) de 189.4 mm para montaje en corte recto;  
 Profundidad del marco perimetral de 2 guias de 123 mm para montaje a englete;  
 Profundidad del marco perimetral de 3 guias (tricaril) de 185 mm para montaje a englete;  
 Perfil guía de deslizamiento inferior en acero inoxidable AISI 304 para evitar el desgaste de las piezas.

#### HOJAS

Profundidad de las hojas perimetrales de 50.6 mm con montaje a englete;  
 Acrisalamiento de 4 a 38 mm;  
 Hojas de línea recta y curva;  
 Junquillos rectos y curvos;  
 Estanquidad asegurada mediante juntas de EPDM y burlete tipo Fin-Seal.

#### DIMENSIONAMIENTO Y MANIOBRABILIDAD

Dimensiones mínimas - máximas de hoja: 720 mm - 3350 mm (L); 1190 mm - 2690 mm (H) con opción de 3325mm con prolongador;  
 Peso máximo de 300 kg por hoja con herraje base, con opción de 400 kg por hoja con kit suplementario;  
 Tipologias de 2, 3, 4 y 6 hojas móviles y/ó fijas;  
 Sistema corredera elevable con funcionamiento basado en una herraje ensamblado al conjunto de las hojas que permite la elevación de estas durante su apertura, en situaciones incluso de configuraciones extremas en peso y dimensiones. Cuando la hoja está cerrada, la hoja comprime las juntas de EPDM permitiendo una estanquidad perimetral perfecta;  
 Herraje base con 2 puntos de cierre y con posibilidad de añadir más 1 ó 2 puntos de cierre complementarios;  
 Herraje base con microventilación;  
 Herraje constituída por rodamientos de 4 ruedas en pvc reforzadas con fibra de vidrio y rodamientos de aguja de alta prestación;  
 Manilla específica para facilitar las maniobras de apertura y cierre del hueco;  
 Existe la opción de manilla doble con colocación de bombillo con llave para permitir la apertura por el exterior.

#### ENSAYOS

Sistema certificado por laboratório credenciado, notificado para Ensayos Tipo Inicial (ITT) de acuerdo con la norma de producto EN 14351-1 para efectos de Marcado CE.

Categorias alcanzadas en los ensayos del sistema CTe:

1. Permeabilidad al aire: Clase 3 (norma de ensayo EN 10207 y EN 1026)
2. Estanquidad al agua: Clase 7A (norma de ensayo EN 12208 y EN 1027)
3. Resistencia al viento: Clase C2 (norma de ensayo EN 12208 e EN 12211)

Coefficiente de transmisión térmica de hueco de 2 hojas con 5.0 m x 2.5 m con vidrio Ug = 0.7 W/m<sup>2</sup>K, con intercalar efecto "Warm Edge": Uw = 1.37 W/m<sup>2</sup>K

Coefficiente de atenuación acústica de hueco de 2 hojas con vidrio acústico 6/16/44.1: Rw (C; Ctr) = 41 dB (-1; -5)

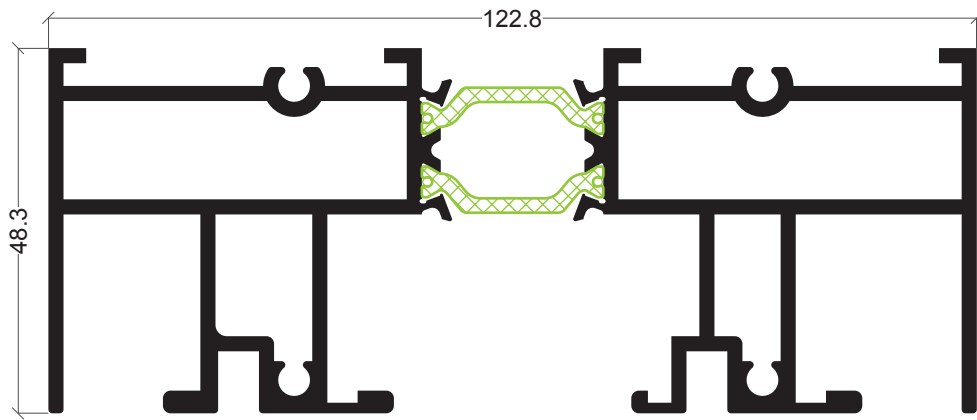

**CTe-05**

Padieira  
Marco superior

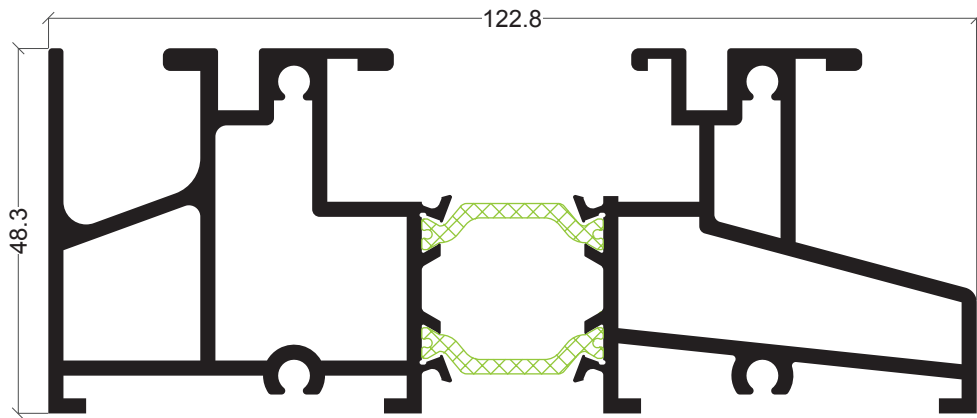

**CTe-01**

Soleira  
Marco inferior

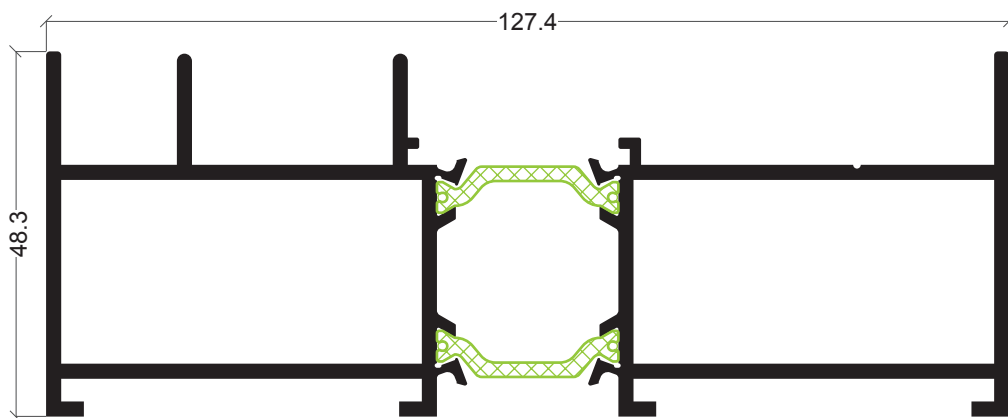

**CTe-08**

Ombreira  
Marco lateral

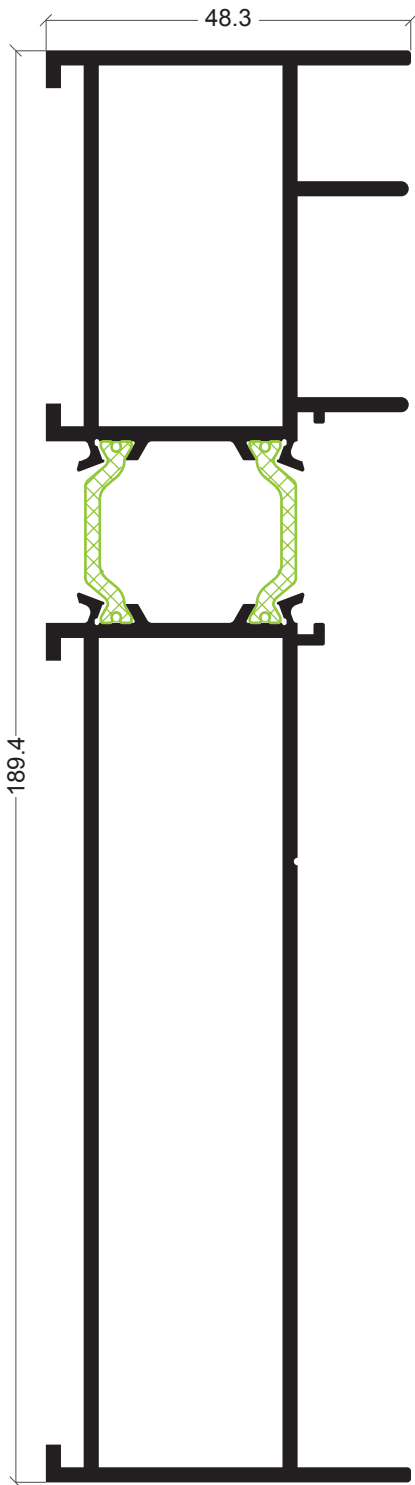

**CTe-12**  
Ombreira tri-rail  
Marco lateral tricarril

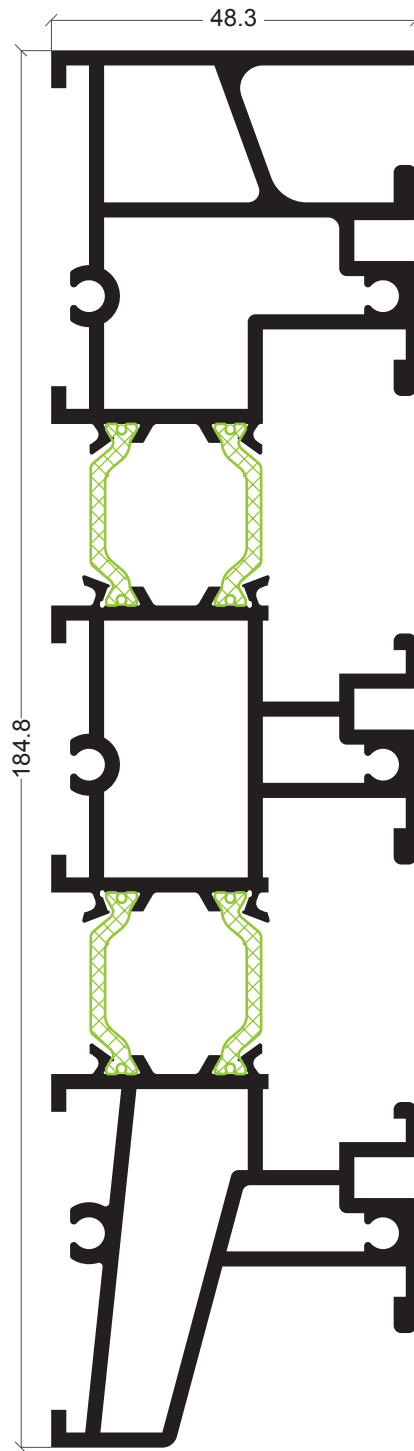

**CTe-13**  
Soleira tri-rail  
Marco perimetral tricarril

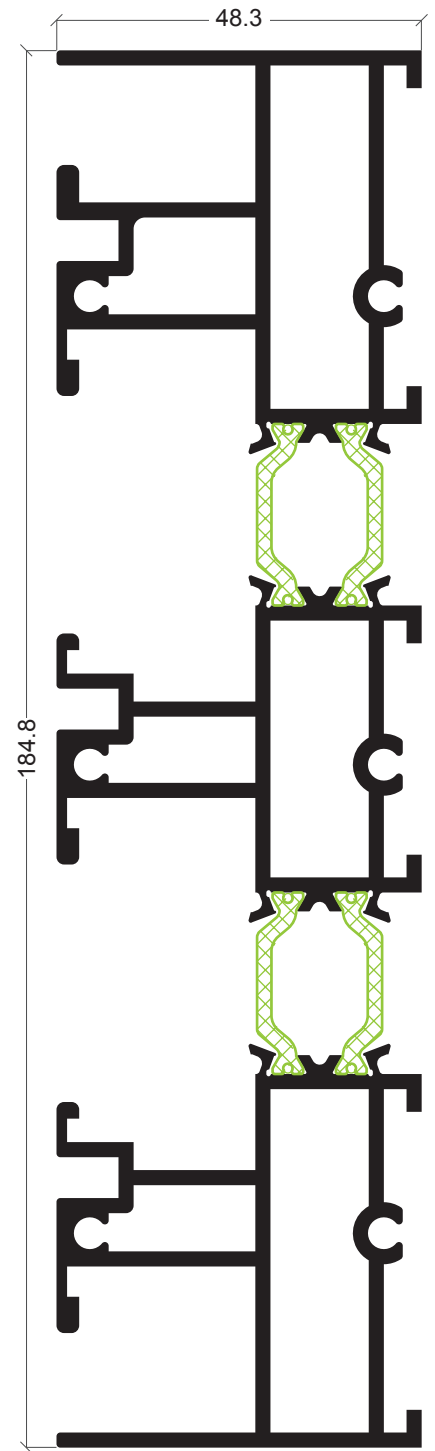

**CTe-11**  
Padeira tri-rail  
Marco superior tricarril

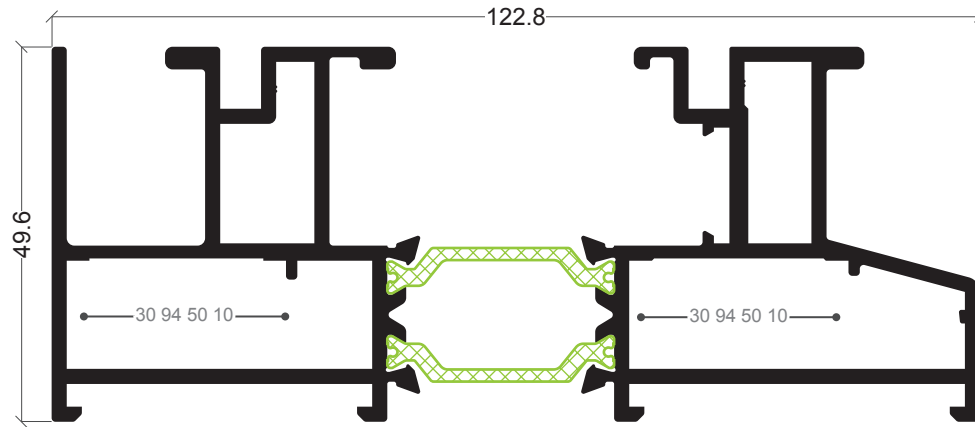

**CTe-14**

Soleira perimetral  
Marco inferior bicarril

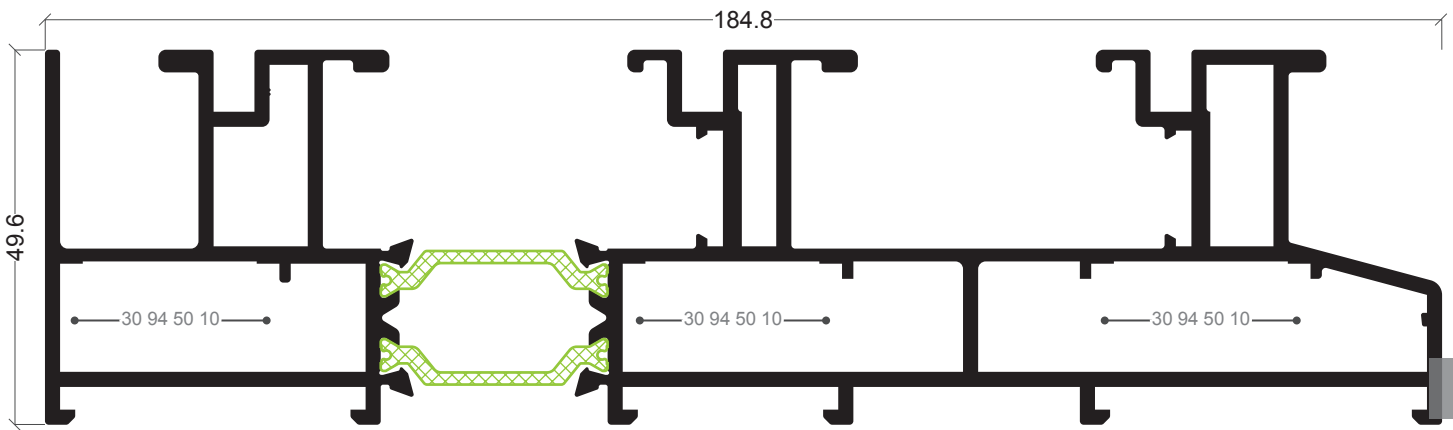

**CTe-15**

Soleira perimetral tri-rail  
Marco inferior tricarril



**CTe-03**

Guia carril (aço inox 304)  
Guia marco carril inf. (AISI 304)



**CTe-07**

Tampa aro inf. PVC CTe-01/13  
Tapamarco PVC CTe-01/13



**CTe-16**

Tampa aro inf. PVC CTe-05/11/14/15  
Tapamarco PVC CTe-05/11/14/15



**CT-94**

Perfil união  
Perfil união

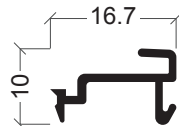

**AX-33**

Mola bite  
Grapa junquillo

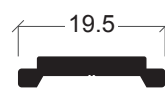

**AX-19**

Vareta  
Pletina falleba

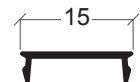

**KL-04**

Tampa para CTe-18  
Tope p/ CTe-18

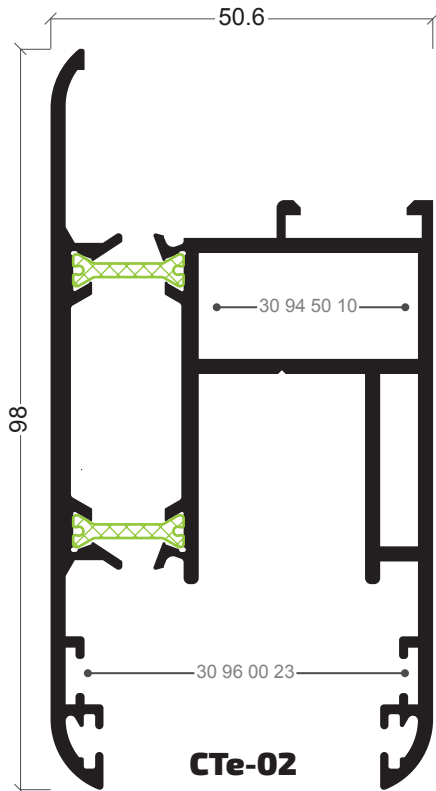

**CTe-02**  
Aro móvel perimetral  
Hoja perimetral

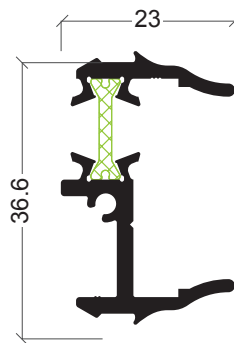

**CTe-09**  
União 3/4 folhas  
Unión 3/4 Hojas

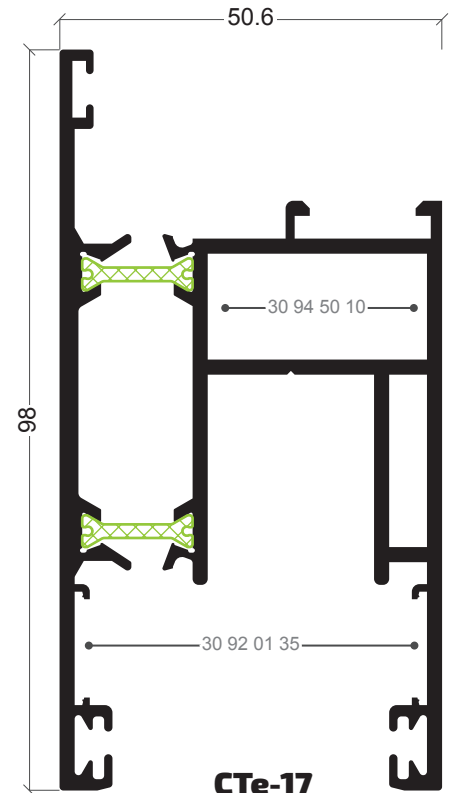

**CTe-17**  
Aro móvel perimetral  
Hoja perimetral

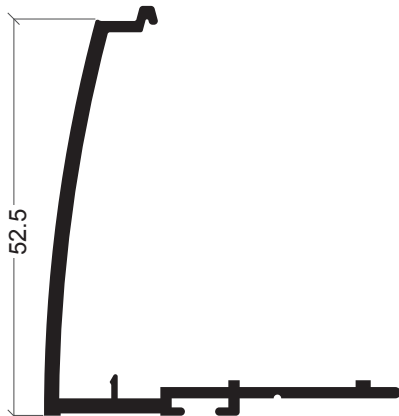

**CTe-06**  
Tampa cruzamento  
Tope cruzamiento

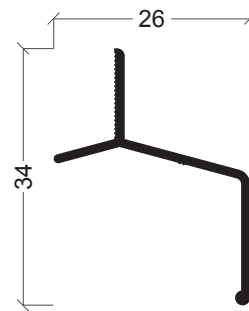

**CTe-07**  
Pingadeira superior  
Vierteaguas superior

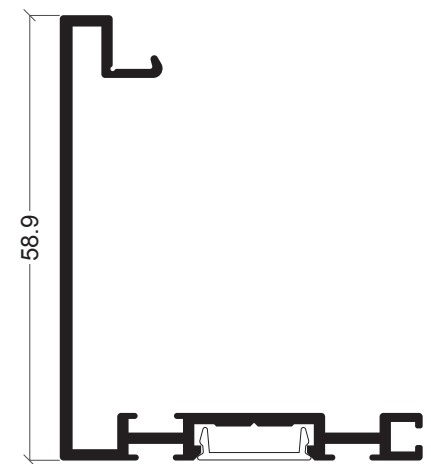

**CTe-18**  
Tampa cruzamento recta  
Tope cruzamiento recta

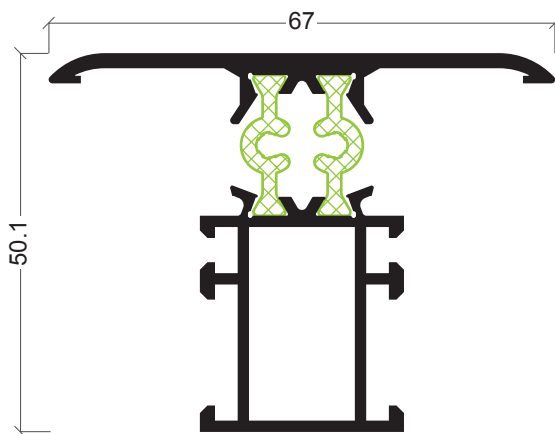

**CTe-10**  
Travessa  
Travesaño

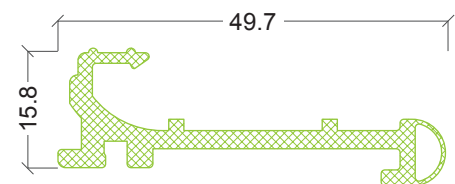

**CTe-04**  
Cruzamento para perfil CTe-02  
Engatillado para perfil CTe-02

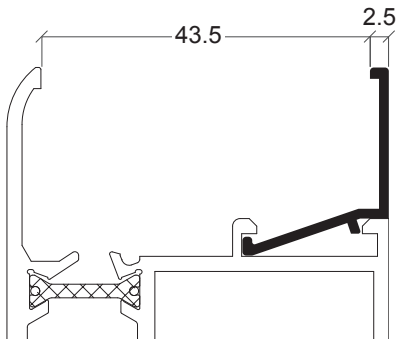

**AX-69**

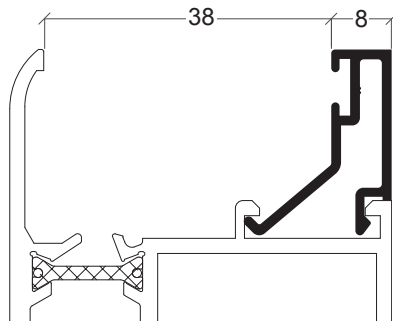

**AX-74**

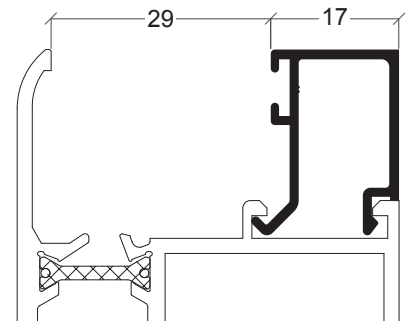

**AX-46**

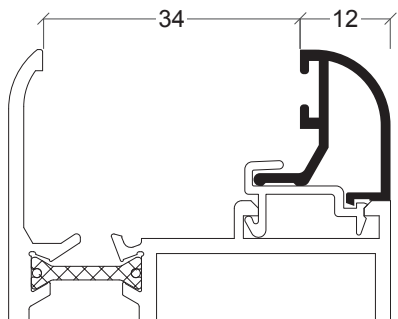

**AX-37**

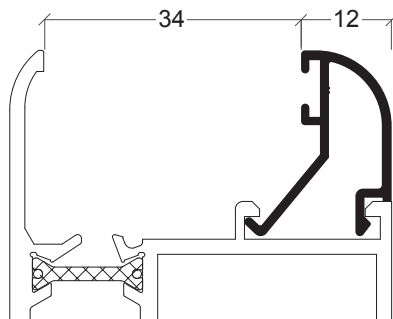

**AZ-08**

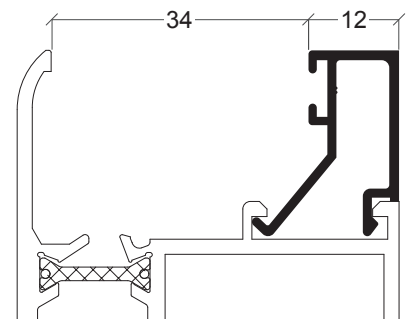

**AX-36**

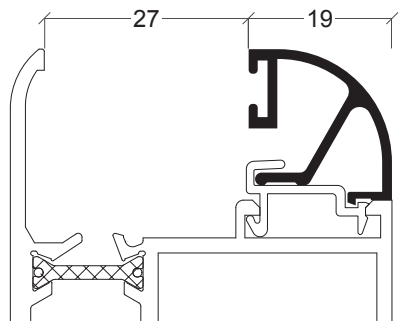

**AX-30**

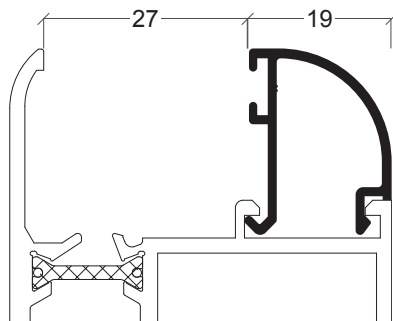

**AZ-07**

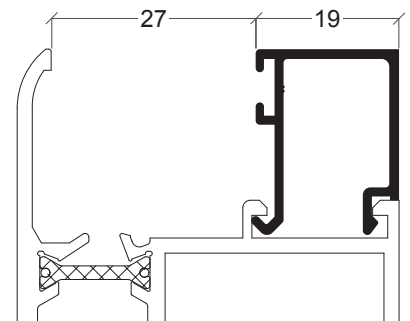

**AX-35**

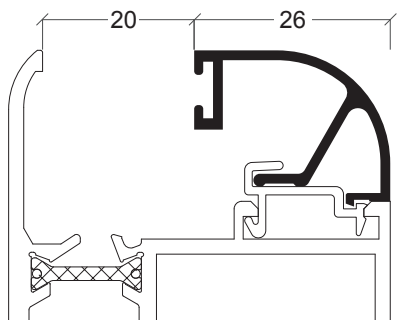

**AX-29**

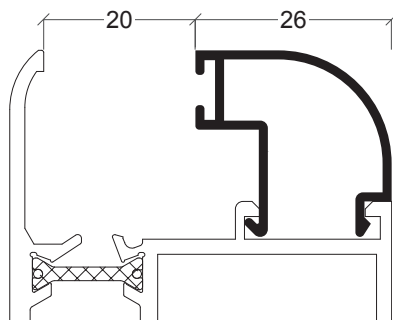

**AZ-06**

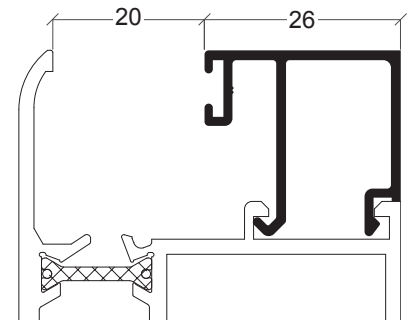

**AX-31**

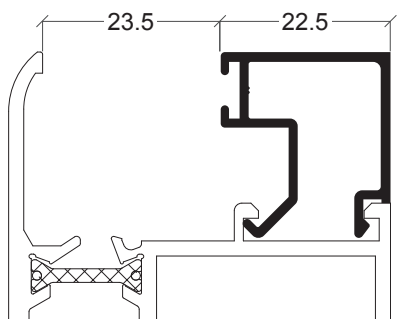

**AX-78**

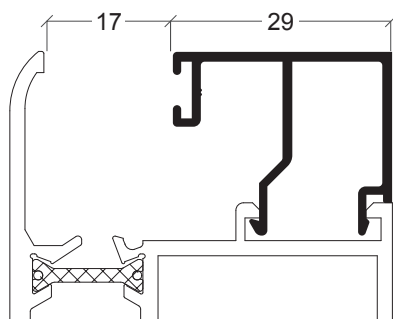

**AX-81**

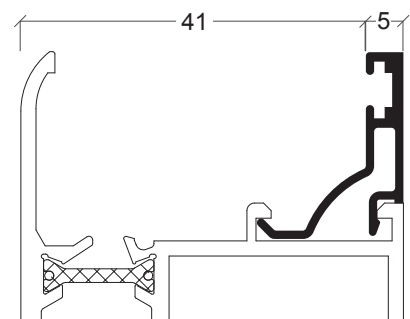

**AX-82**

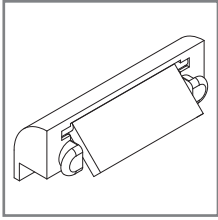

**30 92 01 02/03**

Goteira preto/branco  
Vierteaguas con deflector negro/blanco

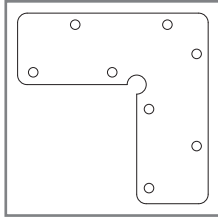

**30 92 01 35**

Esquadro alinhamento  
Escuadra alineamiento

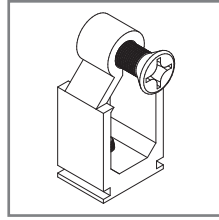

**30 92 01 40**

União Travessa  
Unión travesaño

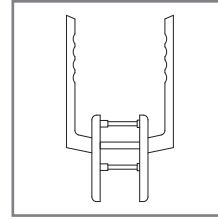

**30 94 52 00/01/02/03**

Puxador duplo para correr-elevatória  
(natural/preto/inox/branco)  
Manilla doble para corredera-elevable  
(natural/negro/inox/blanco)

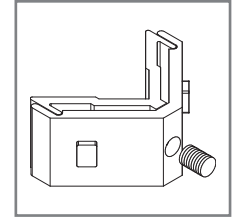

**30 94 50 10**

Esquadro  
Escuadra

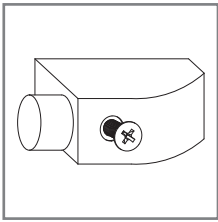

**30 94 50 20**

Limitador abertura  
Limitador apertura

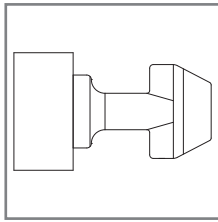

**30 94 50 22**

Ponto de fecho nº 1 para CTe-14/15  
Punto de cierre nº 1 para CTe-14/15

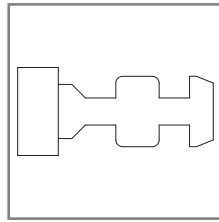

**30 94 50 23**

Ponto de fecho nº 2 para CTe-14/15  
Punto de cierre nº 2 para CTe-14/15

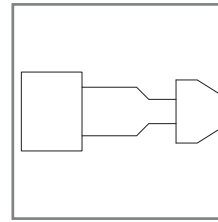

**30 94 50 24**

Ponto de fecho nº 3 para CTe-08/09/12  
Punto de cierre nº 3 para CTe-08/09/12

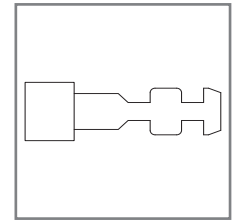

**30 94 50 25**

Ponto de fecho nº 4 para CTe-08/09/12  
Punto de cierre nº 4 para CTe-08/09/12

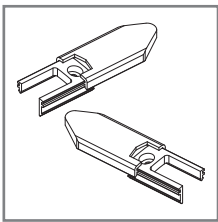

**30 94 50 30**

Tampa guia móvel CTe-06  
Juego topes CTe-06

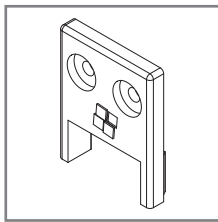

**30 94 50 35**

Tampa guia móvel CTe-18  
Topes CTe-18

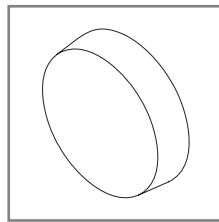

**30 94 50 36**

Tampa preta para parafuso cabeça de queijo 9.3  
Tapa negra para tornillo

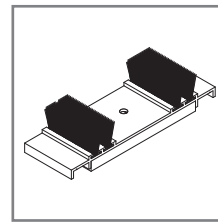

**30 94 50 40**

Corta vento inf. CTe-01/13  
Cortaviento inf. CTe-01/13

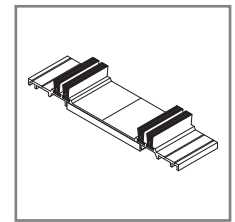

**30 94 50 41**

Corta vento inf./sup para CTe-05/11/14/15  
Cortaviento inf./sup. para CTe-05/11/14/15

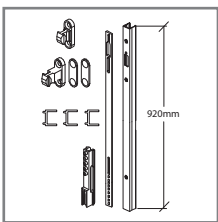

**30 94 50 50**

Prolongador para folhas 2690mm<HF-3325mm  
Prolongador hojas 2690mm<HF-3325mm

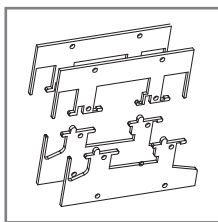

**30 94 50 60**

Junta estanq. aro inf./sup.  
Junta estanq. marco inf./sup.

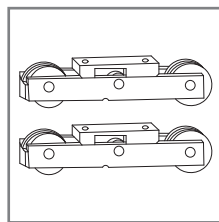

**30 94 50 70**

Jogo rolamento folha fixa 225Kg  
Juego rodamiento hoja fija 225 Kg

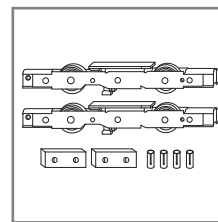

**30 94 51 95**

Kit Suplementar  
Kit Suplementar

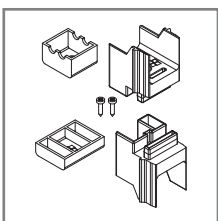

**30 95 60 42**

Conjunto topo 4 folhas elevável preto  
Conjunto tope 4 hojas elevable negro

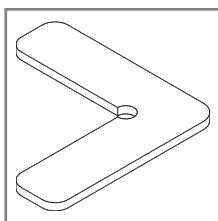

**30 96 00 23**

Esquadro alinhamento  
Escuadra alineamiento

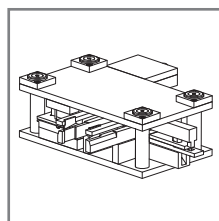

**33 94 59 99**

Cunho CTe  
Troquel CTe

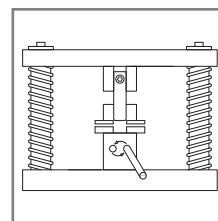

**33 94 69 99**



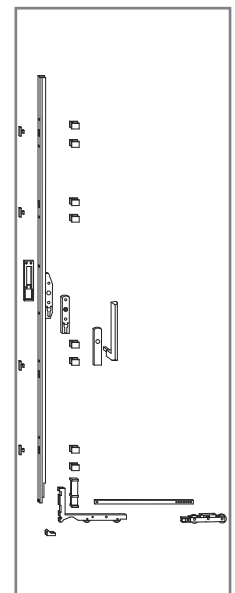











Cunho CTe-18  
Troquel CTe-18



**Ver tabela · Ver tabla**

Kit correr-elevatório para folha até 300kg  
Kit corredera elevable para hoja hasta 300kg



REFERÊNCIA • REFERENCIA	DESENHO • DISEÑO	DESCRIÇÃO • DESCRIPCIÓN
30 60 00 17		Junta exterior vidro plana 2 mm preto Junta exterior vidro plana 2 mm preto
30 93 00 60		Junta exterior para vidro para o perfil CTe-17 (4 mm) Junta exterior para vidrio para el perfil CTe-17 (4 mm)
30 93 00 61		Junta de vedação exterior para o perfil CTe-17 (2 mm) Junta de estanqueidad exterior para el perfil CTe-17 (2 mm)
30 93 00 62		Junta exterior plana para vidro para o perfil CTe-17 (4 mm) Junta exterior plana de vidrio para el perfil CTe-17 (4 mm)
30 93 00 65		Junta interior para vidro (5 mm) Junta interior para vidrio (5 mm)
30 93 00 66		Junta interior para vidro (4 mm) Junta interior para vidrio (4 mm)
30 93 00 67		Junta interior para vidro (2 mm) Junta interior para vidrio (2 mm)
30 93 00 68		Junta interior para vidro (6/7 mm) Junta interior para vidrio (6/7 mm)
30 93 00 69		Junta interior para vidro (8/9 mm) Junta interior para vidrio (8/9 mm)
30 94 50 90		Junta para os perfis CTe-2 ou CTe-17 Junta para los perfiles CTe-2 u CTe-17
30 94 50 95		Junta para o perfil CTe-18 Junta para lo perfil CTe-18
30 94 51 00		Junta para os perfis CTe-8 ou CTe-12 Junta para los perfiles CTe-8 u CTe-12
30 95 00 40		Pelúcia 7x5.5 mm Fin-Seal para o perfil CTe-06 Burlete 7x5.5 mm Fin-Seal para lo perfil CTe-06
30 95 00 50		Pelúcia 7x6 mm Fin-Seal para o perfil CTe-18 Burlete 7x6 mm Fin-Seal para lo perfil CTe-18
30 95 60 02		Junta tapa-canal Junta tapa-canal

Largura mínima da folha • Ancho mínima hoja: 720 mm  
Largura máxima da folha • Ancho máxima hoja: 3350 mm

Altura mínima da folha • Alto mínima hoja: 1190 mm  
Altura máxima da folha • Alto máxima hoja: 2690 mm \*

KITS CORRER-ELEVÁVEISITS (PESO MÁXIMO POT FOLHA 300kg) <sup>a</sup> • CORREDERA ELEVABLES (PESO MÁXIMO POR HOJA 300kg) <sup>b</sup>							
LARGURA LF ANCHO LF	ALTURA HF ALTO HF	COR COLOR	REFERÊNCIA REFERENCIA	COR COLOR	REFERÊNCIA REFERENCIA	COR COLOR	REFERÊNCIA REFERENCIA
720/1500	1190/1790	Branco • Blanco	30 94 51 06	Preto • Negro	30945107	Natural	30945108
720/1500	1791/2090	Branco • Blanco	30 94 51 11	Preto • Negro	30945112	Natural	30945113
720/1500	2091/2390	Branco • Blanco	30 94 51 16	Preto • Negro	30945117	Natural	30945118
720/1500	2391/2690	Branco • Blanco	30 94 51 21	Preto • Negro	30945122	Natural	30945123
1501/2000	1190/1790	Branco • Blanco	30 94 51 26	Preto • Negro	30945127	Natural	30945128
1501/2000	1791/2090	Branco • Blanco	30 94 51 31	Preto • Negro	30945132	Natural	30945133
1501/2000	2091/2390	Branco • Blanco	30 94 51 36	Preto • Negro	30945137	Natural	30945138
1501/2000	2391/2690	Branco • Blanco	30 94 51 41	Preto • Negro	30945142	Natural	30945143
2011/2500	1190/1790	Branco • Blanco	30 94 51 46	Preto • Negro	30945147	Natural	30945148
2011/2500	1791/2090	Branco • Blanco	30 94 51 51	Preto • Negro	30945152	Natural	30945153
2011/2500	2091/2390	Branco • Blanco	30 94 51 56	Preto • Negro	30945157	Natural	30945158
2011/2500	2391/2690	Branco • Blanco	30 94 51 61	Preto • Negro	30945162	Natural	30945163
2501/3350	1190/1790	Branco • Blanco	30 94 51 66	Preto • Negro	30945167	Natural	30945168
2501/3350	1791/2090	Branco • Blanco	30 94 51 71	Preto • Negro	30945172	Natural	30945173
2501/3350	2091/2390	Branco • Blanco	30 94 51 76	Preto • Negro	30945177	Natural	30945178
2501/3350	2391/2690	Branco • Blanco	30 94 51 81	Preto • Negro	30945182	Natural	30945183











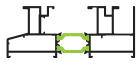

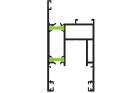





Cor inox sob encomenda • Color Inox según pedido

(a) Altura máxima até 3325 mm com prolongador (sob encomenda) • Alto máximo hasta 3325 mm con prolongador (según pedido)

(b) Para folha com peso inferior a 300kg. Para folha entre 301kg e 400kg acrescentar o kit suplementar 30945195 • Para hoja con peso inferior a 300kg. Para hoja entre 301kg y 400kg añadir el kit suplementario 30945195

## Porta 2 folhas correr elevável perimetral • Puerta 2 hojas elevable perimetral

### PERFIS • PERFIS

DESENHO • DESEÑO	REF.	DESCRIÇÃO • DESCRIPCIÓN	CORTE CORTE	QUANTIDADE CANTIDAD	MEDIDAS • MEDIDA
	CTe-14	Aro fixo perimetral Marco inferior bicarril		2	L
			2	H	
	CTe-17	Aro móvel perimetral Hoja perimetral		4	L/2+4 mm
			4	H-83 mm	
	CTe-18	Tampa de cruzamento Tope de cruzamiento recta		2	H-83 mm
	CTe-03	Perfil guia Guia marco carril inferior		2	L-83 mm
	CT-07	Pingadeira Vierteaguas		1	L
	----	Bite reto Junquillo		4	L/2-152 mm
				4	H-279 mm
	CTe-16*	Tampa aro perimetral PVC Tapamarco		2	L-47 mm
				2	H-47 mm
	KL-04	Tampa para CTe-18 Tope para CTe-18		2	H-83 mm

\* cortar juntamente com o perfil CTe-14 • cortar con el perfil CTe-14

### ACESSÓRIOS E JUNTAS • ACCESORIOS Y JUNTAS







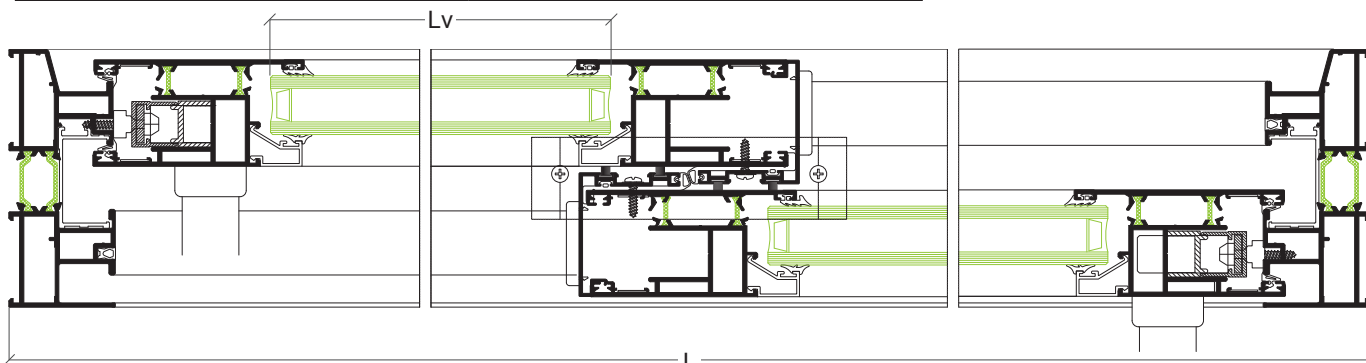

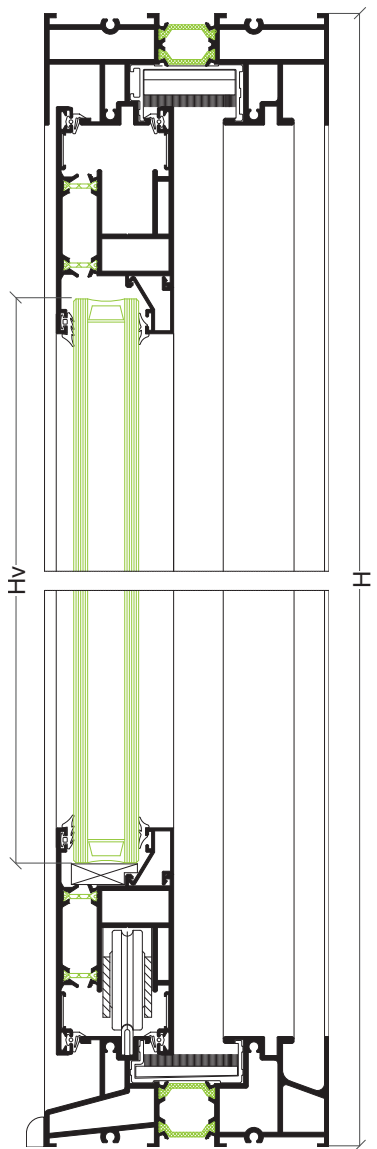
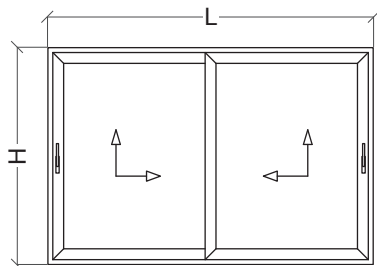

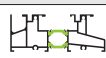

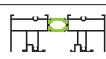

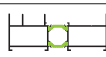







REF.	DESCRIÇÃO • DESCRIPTION	QUANTIDADE • CANTIDAD	
		MÓVEL / FIXA HOJA / FIJO	MÓVEL / MÓVEL HOJA / HOJA
----	Kit elevável • Kit elevable	1	2
30 94 50 10	Esquadro • Escuadra	16	16
30 94 50 35	Tampa guia lateral • Tope guia lateral	4	4
30 92 01 35	Esquadro alinhamento • Escuadra alineamiento	16	16
30 94 50 41	Corta ventos • Cortavientos	2	2
30 92 01 02	Goteira com válvula (cor preto) Vierteaguas con deflector (color negro)	diversas	diversas
30 95 00 50	Pelúcia 7x6 mm Fin-Seal • Burlete 7x6 mm Fin-seal	4H	4H
30 94 50 95	Junta central CTe-Recta • Junta central CTe-Recta	2H	2H
30 94 50 90	Junta Aro Móvel perimetral • Junta hoja perimetral	2L+4H	2L+4H
----	Junta para vidro (interior) • Junta para vidrio (interior)	2L+4H	2L+4H
----	Junta para vidro (exterior) • Junta para vidrio (exterior)	2L+4H	2L+4H
30 94 51 95	Kit suplementar (folha com 301kg-400kg) Kit suplementario (hoja com 301kg-400kg)	1 (opcional)	2 (opcional)
30 94 50 50	Prolongador (Hf -> 2790 mm-3325 mm) Prolongador (Hf -> 2790 mm-3325 mm)	1 (opcional)	2 (opcional)
30 94 50 20	Limitador de abertura • Limitador de apertura	-	1
30 94 50 70	Rolamento folha fixa • Rodamiento hoja fija	1	-
30 95 60 02	Junta tapa canal aro fixo • Junta tapa canal marco	2L+4H	2L+4H
30 94 50 36	Tampa preta para parafuso • Tapa negra para tornillo	8	8

### VIDRO • VIDRIO

Hv = H-253 mm	Lv = L/2-162 mm
---------------	-----------------



**Porta 2 folhas correr elevável • Puerta 2 hojas elevables**

**PERFIS • PERFIS**

DESENHO • DESEÑO	REF.	DESCRIÇÃO • DESCRIPCIÓN	CORTE CORTE	QUANTIDADE CANTIDAD	MEDIDAS • MEDIDA
	CTe-01	Soleira Marco inferior		1	L-67 mm
	CTe-05	Padieira Marco superior		1	L-67 mm
	CTe-08	Ombreira Marco lateral		2	H
	CTe-17	Aro Móvel perimetral Hoja perimetral		4	L/2+6 mm
				4	H-81 mm
	CTe-18	Tampa cruzamento Tope de cruzamiento recta		2	H-81 mm
	CTe-03	Perfil guia Guia marco carril inferior		2	L-67 mm
	----	Bite reto Junquillo recto		4	L/2-150 mm
				4	H-277 mm
	CTe-16*	Tampa para padieira Tapamarco		1	L-67 mm
	CTe-07*	Tampa para Soleira Tapamarco		1	L-67 mm
	KL-04	Tampa para CTe-18 Tope para CTe-18		2	H-83 mm

\* cortar juntamente com o respectivo perfil de alumínio • cortar con el respectivo perfil de aluminio

**ACESSÓRIOS E JUNTAS • ACCESORIOS Y JUNTAS**







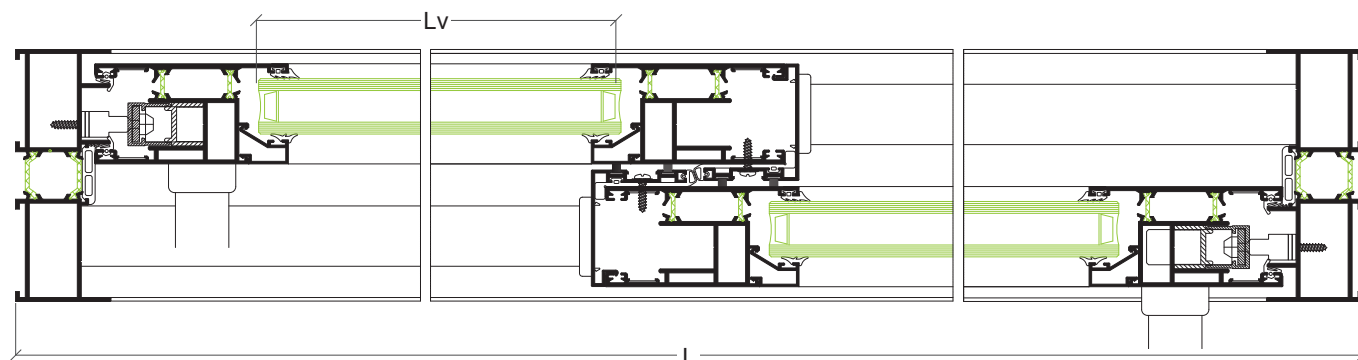



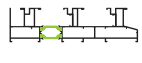

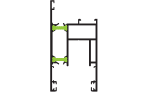



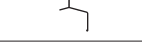

REF.	DESCRIÇÃO • DESCRIPTION	QUANTIDADE CANTIDAD
----	Kit elevável • Kit elevable	2
30 94 50 10	Esquadro • Escuadra	8
30 94 50 35	Tampa guia lateral • Tope guia lateral	4
30 92 01 35	Esquadro alinhamento • Escuadra alineamiento	16
30 94 50 40	Corta vento inferior • Cortaviento inferior	1
30 94 50 41	Corta vento superior • Cortaviento superior	1
30 94 50 60	Kit de juntas de estanquidade • Kit de juntas de estanqueidad	1
30 92 01 02	Goteira com válvula (cor preto) • Vierteaguas con deflector (color negro)	diversas
30 95 00 50	Pelúcia 7x6 mm Fin-Seal • Burlete 7x6 mm Fin-Seal	4H
30 94 50 90	Junta aro móvel perimetral • Junta marco perimetral	4L+4H
30 94 51 00	Junta ombreira • Junta marco lateral	2H
30 94 50 95	Junta central CTe-Recta • Junta central CTe-Recta	2H
----	Junta para vidro (interior) • Junta para vidrio (interior)	2L+4H
----	Junta para vidro (exterior) • Junta para vidrio (exterior)	2L+4H
30 94 51 95	Kit suplementar (flha com 301kg-400kg) Kit suplementario (hoja con 301kg-400kg)	2 (opcional)
30 94 50 50	Prolongador (Hf -> 2790 mm-3325 mm) Prolongador (Hf -> 2790 mm-3325 mm)	2 (opcional)
30 94 50 20	Limitador de abertura • Limitador de apertura	1

**VIDRO • VIDRIO**

Hv = H-253 mm	Lv = L/2-164 mm
---------------	-----------------



**Porta 3 folhas correr elevável tri-rail • Puerta 3 hojas elevable tricarril**
**PERFIS • PERFIS**

DESENHO • DISEÑO	REF.	DESCRIÇÃO • DESCRIPCIÓN	CORTE CORTE	QUANTIDADE CANTIDAD	MEDIDAS • MEDIDA
	CTe-15	Aro fixo tri-rail perimetral Marco tricarril perimetral		2	L
			2	H	
	CTe-17	Aro móvel perimetral Hoja perimetral		6	L/3+33 mm
			6	H-83 mm	
	CTe-18	Tampa de cruzamento Tope de cruzamiento recta		4	H-83 mm
	CTe-03	Perfil guia Guia marco carril inferior		3	L-83 mm
	CT-07	Pingadeira Vierteaguas		1	L
	----	Bite reto Junquillo recto		6	L/3-123 mm
				6	H-279 mm
	CTe-16*	Tampa aro perimetral PVC Tapamarco		4	L-47 mm
				4	H-47 mm
	KL-04	Tampa para CTe-18 Tope para CTe-18		4	H-83 mm

\* cortar juntamente com o perfil CTe-15 • cortar con el perfil CTe-15

**ACESSÓRIOS E JUNTAS • ACCESORIOS Y JUNTAS**

REF.	DESCRIÇÃO • DESCRIPTION	QUANTIDADE CANTIDAD
----	Kit elevável • Kit elevable	3
30 94 50 10	Esquadro • Escuadra	24
30 94 50 35	Tampa guia lateral • Tope guia lateral	8
30 92 01 35	Esquadro alinhamento • Escuadra alineamiento	24
30 94 50 41	Corta ventos • Cortavientos	4
30 92 01 02	Goteira com válvula (cor preto) • Vierteaguas con deflector (color negro)	diversas
30 95 00 50	Pelúcia 7x6 mm Fin-Seal • Burlete 7x6 mm Fin-seal	8H
30 94 50 95	Junta central CTe-recta • Junta central CTe-Recta	4H
30 94 50 90	Junta aro móvel perimetral • Junta hoja perimetral	4L+4H
----	Junta para vidro (interior) • Junta para vidrio (interior)	2L+6H
----	Junta para vidro (exterior) • Junta para vidrio (exterior)	2L+6H
30 94 51 95	Kit suplementar (folha com 301kg-400kg) Kit suplementario (hoja con 301kg-400kg)	3 (opcional)
30 94 50 50	Prolongador (Hf -> 2790 mm-3325 mm) Prolongador (Hf -> 2790 mm-3325 mm)	3 (opcional)
30 94 50 20	Limitador de abertura • Limitador de apertura	2
30 95 60 02	Junta tapa-canal • Junta tapa-canal	3L+6H
30 94 50 36	Tampa preta para parafuso • Tapa negra para tornillo	16

**VIDRO • VIDRIO**

Hv = H-253 mm	Lv = L/3-137 mm
---------------	-----------------

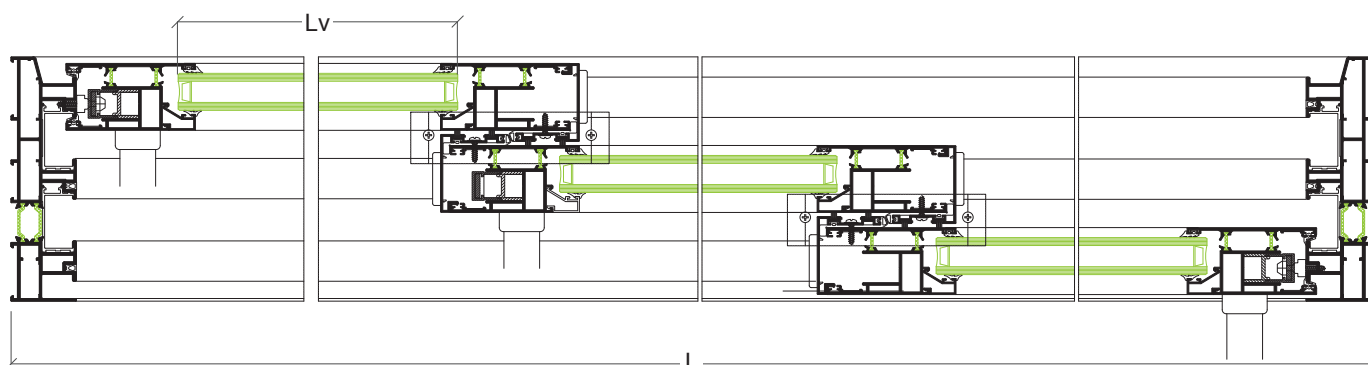

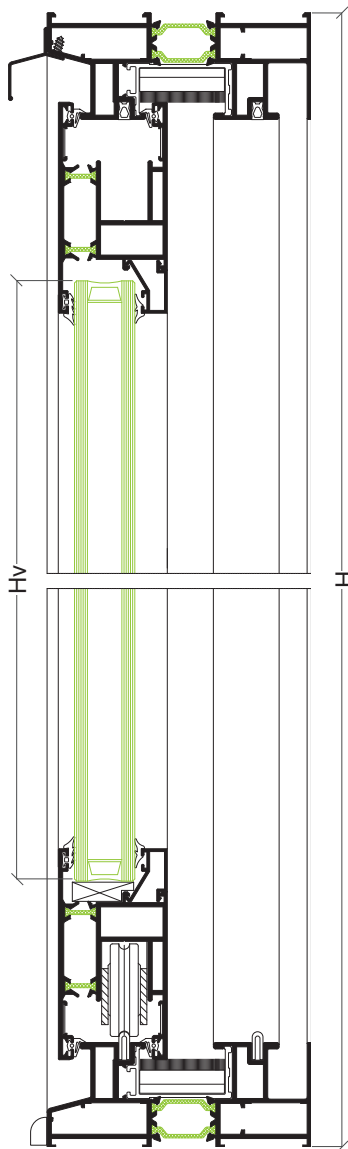
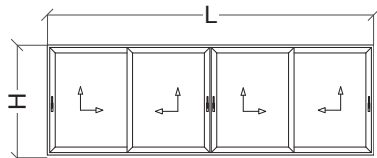
**Porta 4 folhas correr elevável • Puerta 4 hojas elevables**

**PERFIS • PERFIS**

DESENHO • DESEÑO	REF.	DESCRIÇÃO • DESCRIPCIÓN	CORTE CORTE	QUANTIDADE CANTIDAD	MEDIDAS • MEDIDA
	CTe-14	Aro fixo perimetral Marco inferior bicarril		2	L
				2	H
	CTe-17	Aro móvel perimetral Hoja perimetral		8	L/4+23 mm
				8	H-83 mm
	CTe-18	Tampa de cruzamento Tope de cruzamiento recta		4	H-83 mm
	CTe-03	Perfil guia Guia marco carril inferior		2	L-83 mm
	CT-07	Pingadeira Vieriteaguas		1	L
	CTe-09	União 3/4 F Unión 3/4 hojas		1	H-83 mm
	---	Bite reto Junquillo		8	L/4-133 mm
				8	H-279 mm
	CTe-16*	Tampa aro perimetral PVC Tapamarco		2	L-47 mm
				2	H-47 mm
	KL-04	Tampa para CTe-18 Tope para CTe-18		4	H-83 mm

\* cortar juntamente com o perfil CTe-14 • cortar con el perfil CTe-14

**ACESSÓRIOS E JUNTAS • ACCESORIOS Y JUNTAS**







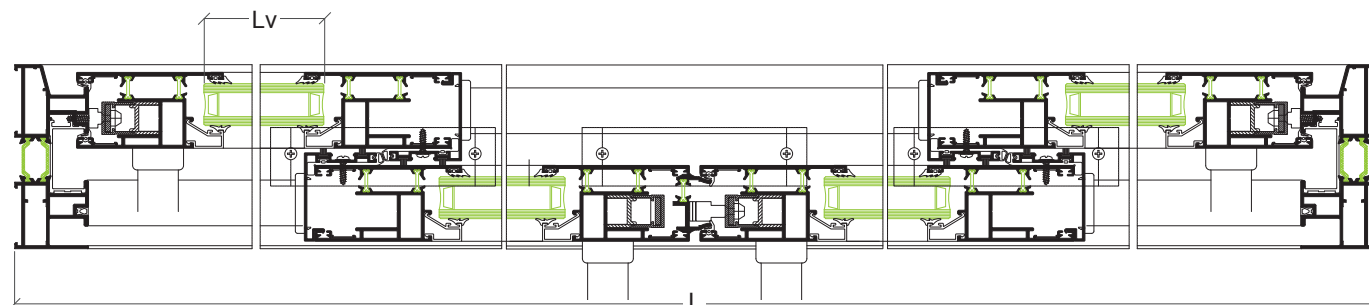



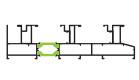











REF.	DESCRIÇÃO • DESCRIPTION	QUANTIDADE CANTIDAD
----	Kit elevável • Kit elevable	4
30 94 50 10	Esquadro • Escuadra	24
30 94 50 35	Tampa guia lateral • Tope guía lateral	8
30 92 01 35	Esquadro alinhamento • Escuadra alineamiento	32
30 94 50 41	Corta ventos • Cortavientos	6
30 92 01 02	Goteira com válvula (cor preto) • Vieriteaguas con deflector (color negro)	diversas
30 95 00 50	Pelúcia 7x6 mm Fin-Seal • Burlete 7x6 mm Fin-seal	8H
30 94 50 95	Junta central CTe-recta • Junta central CTe-Recta	4H
30 94 50 90	Junta Aro Móvel perimetral • Junta hoja perimetral	4L+6H
----	Junta para vidro (interior) • Junta para vidrio (interior)	2L+8H
----	Junta para vidro (exterior) • Junta para vidrio (exterior)	2L+8H
30 94 51 95	Kit suplementar (folha com 301kg-400kg) Kit suplementario (hoja con 301kg-400kg)	4 (opcional)
30 94 50 50	Prolongador (Hf -> 2790 mm-3225 mm) • Prolongador (Hf -> 2790 mm-3225 mm)	4 (opcional)
30 94 50 20	Limitador de abertura • Limitador de apertura	2
30 95 60 42	Conjunto topo 4 folhas elevável preto • Conjunto tope 4 hojas elevable negro	1
30 95 60 02	Junta tapa-canal • Junta tapa-canal	2L+4H
30 94 50 36	Tampa preta para parafuso • Tapa negra para tornillo	16

**VIDRO • VIDRIO**

Hv = H-253 mm	Lv = L/4-147 mm
---------------	-----------------



**Porta 6 folhas correr elevável tri-rail • Puerta 6 hojas elevable tricarril**
**PERFIS • PERFIS**

DESENHO • DISEÑO	REF.	DESCRIÇÃO • DESCRIPCIÓN	CORTE CORTE	QUANTIDADE CANTIDAD	MEDIDAS • MEDIDA
	CTe-15	Soleira tri-rail		2	L
		Marco inferior tricarril		2	H
	CTe-17	Aro móvel perimetral		12	L/6+46 mm
		Hoja perimetral		12	H-83 mm
	CTe-18	Tampa de cruzamento Tope de cruzamiento recta		8	H-83 mm
	CTe-09	Perfil para 3/4 folhas Unión 3/4 hojas		1	H-83 mm
	CTe-03	Perfil guia Guía marco carril inferior		3	L-83 mm
	CT-07	Pingadeira Vierteaguas		1	L
	----	Bite reto		12	L/6-110 mm
		Junquillo		12	H-279 mm
	CTe-16*	Tampa aro perimetral PVC		4	L-47 mm
		Tapamarco		4	H-47 mm
	KL-04	Tampa para CTe-18 Tope para CTe-18		8	H-83 mm

\* cortar juntamente com o perfil CTe-15 • cortar con el perfil CTe-15

**ACESSÓRIOS E JUNTAS • ACCESORIOS Y JUNTAS**

REF.	DESCRIÇÃO • DESCRIPTION	QUANTIDADE CANTIDAD
----	Kit elevável • Kit elevable	4
30 94 50 10	Esquadro • Escuadra	36
30 94 50 35	Tampa guia lateral • Tope guia lateral	16
30 92 01 35	Esquadro alinhamento • Escuadra alineamiento	48
30 94 50 41	Corta ventos • Cortavientos	10
30 92 01 02	Goteira com válvula (cor preto) • Vierteaguas con deflector (color negro)	diversas
30 95 00 50	Pelúcia 7x8 mm Fin-seal • Burlete 7x6 mm Fin-seal	16H
30 94 50 95	Junta central CTe-Recta • Junta central CTe-Recta	8H
30 94 50 90	Junta Aro Móvel perimetral • Junta hoja perimetral	4L+6H
----	Junta para vidro (interior) • Junta para vidrio (interior)	2L+12H
----	Junta para vidro (exterior) • Junta para vidrio (exterior)	2L+12H
30 94 50 70	Rolamento para folha fixa (250kg máx. folha) Rodamiento para hoja fija (250kg máx. hoja)	4
30 94 51 95	Kit suplementar (folha com 301kg-400kg) Kit suplementario (hoja con 301kg-400kg)	4 (opcional)
30 94 50 50	Prolongador (Hf -> 2790 mm-3225 mm) Prolongador (Hf -> 2790 mm-3225 mm)	4 (opcional)
30 94 50 20	Limitador de abertura • Limitador de apertura	2
30 95 60 42	Conjunto topo 4 folhas elevável preto • Conjunto tope 4 hojas elevable negro	1
30 95 60 02	Junta tapa-canal • Junta tapa-canal	3L+6H
30 94 50 36	Tampa preta para parafuso • Tapa negra para tornillo	32

**VIDRO • VIDRIO**

Hv = H-253 mm	Lv = L/6-124 mm
---------------	-----------------

