

www.anicolor.pt

**SISTEMA DE
CORRER - 95 mm**

**SISTEMA
CORREDERA - 95 mm**

CS

 **anicolor**
Sistemas de Alumínio

SISTEMA CS

Sistema de correr - 95 mm

CARACTERÍSTICAS DO SISTEMA

Sistemas de alumínio tradicional e sistema euro para execução de vãos de correr.

PERFIS DE ALUMÍNIO

Os perfis de alumínio são extrudidos na liga de alumínio 6060 para arquitetura de acordo com norma NP EN 12020-02.

Espessura média dos perfis de alumínio de 1.4 mm.

AROS FIXOS

Secção do aro fixo de 1 guia de 47 mm para montagem a corte recto;

Secção do aro fixo de 2 guias de 95 mm para montagem a corte recto;

Secção do aro fixo de 3 guias de 135.5 mm para montagem a corte recto.

AROS MÓVEIS

Secção dos aros móveis de 34.6 mm para montagem a corte recto;

Enchimento de 4 mm a 23 mm;

Estanquidade assegurada através de pelúcia tipo Fin-Seal.

DIMENSIONAMENTO E MANIOBRABILIDADE

Peso máximo de 90 kg por folha (com 2 rolamentos duplos);

Possibilidades de abertura: 1, 2, 3, 4 e 6 folhas, com folhas móveis e/ou fixas;

Rolamento duplo com regulação.

PERFORMANCES

Sistema certificado por laboratório credenciado, notificado do ensaio tipo inicial (ITT) de acordo com a norma de produto EN 14351-1 para efeitos de Marcação CE.

Categorias alcançadas na avaliação do sistema CS tipologia janela:

1. Permeabilidade ao ar: Classe 3 (norma de ensaio EN 1027 e EN 1026)
2. Estanquidade à água: Classe 6A (norma de ensaio EN 12208 e EN 1027)
3. Resistência ao vento: Classe C4 (norma de ensaio EN 12210 e EN 12211)

Categorias alcançadas na avaliação do sistema CS tipologia porta:

1. Permeabilidade ao ar: Classe 3 (norma de ensaio EN 1027 e EN 1026)
2. Estanquidade à água: Classe 6A (norma de ensaio EN 12208 e EN 1027)
3. Resistência ao vento: Classe C2 (norma de ensaio EN 12210 e EN 12211)

Coefficiente de transmissão térmica de vão de 2 folhas com 1.80 m x 2.20 m com vidro Ug = 1.4 W/m²K: Uw = 2.60 W/m²K

Coefficiente de atenuação acústica de vão de 2 folhas com vidro 5/12/5: Rw (C; Ctr) = 26 dB (-1; -2)

Zonas de aplicação segundo RCCTE (em função do valor Ug): I1, I2, I3, V1, V2, V3;

SISTEMA CS

Sistema corredera - 95 mm

CARACTERÍSTICAS DEL SISTEMA

Sistemas tradicionales de aluminio y euro sistema para luces correderas.

PERFILES DE ALUMINIO

Los perfiles de aluminio están extrudidos en la aleación de aluminio 6060 para arquitectura según la norma NP EN 12020-02.

Espesor medio de perfiles de aluminio de 1,4 mm.

MARCOS

Sección de marco de 1 guía de 47 mm para montaje de corte recto;

Sección de marco con 2 guías de 95 mm para montaje de corte recto;

Tramo de marco con 3 guías de 135,5 mm para montaje en corte recto.

HOJAS

Sección de hojas de 34,6 mm para montaje en corte recto;

Llenado de 4 mm a 23 mm;

Estanqueidad asegurada por Fin-Seal tipo felpa.

DIMENSIONAMIENTO Y MANIOBRABILIDAD

Peso máximo de 90 kg por hoja (con 2 rodamientos dobles);

Possibilidades de abertura: 1, 2, 3, 4 y 6 hojas, con hojas móviles y / o fijas;

Rodamiento doble con regulación.

ENSAYOS

Sistema certificado por laboratorio credenciado, notificado de la prueba de tipo inicial (ITT) según la norma de producto EN 14351-1 a efectos de Marcado CE.

Categorías logradas en la evaluación del sistema de ventanas de tipología CS:

1. Permeabilidad al aire: Clase 3 (norma de prueba EN 1027 y EN 1026)
2. Estanqueidad al agua: Clase 6A (prueba estándar EN 12208 y EN 1027)
3. Resistencia al viento: Clase C4 (estándar de prueba EN 12210 y EN 12211)

Categorías logradas en la evaluación del sistema de puertas de tipología CS:

1. Permeabilidad al aire: Clase 3 (norma de prueba EN 1027 y EN 1026)
2. Estanqueidad al agua: Clase 6A (norma de prueba EN 12208 y EN 1027)
3. Resistencia al viento: Clase C2 (norma de prueba EN 12210 y EN 12211)

Coefficiente de transmisión térmica de 2 hojas con 1,80 m x 2,20 m con vidrio Ug = 1,4 W / m²K: Uw = 2,60 W / m²K

Coefficiente de atenuación acústica de 2 hojas con vidrio 5/12/5: Rw (C; Ctr) = 26 dB (-1; -2)

Áreas de aplicación según RCCTE (según el valor Ug): I1, I2, I3, V1, V2, V3;

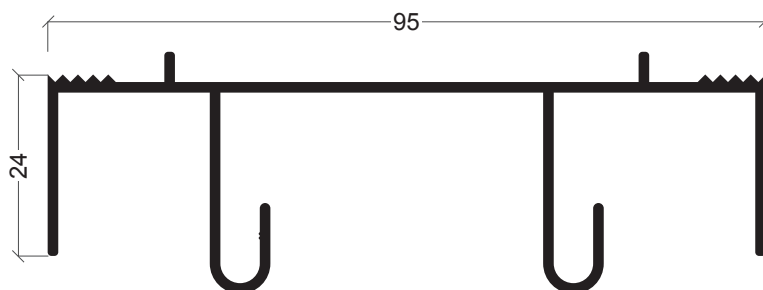

CS-01

Padieira
Marco superior

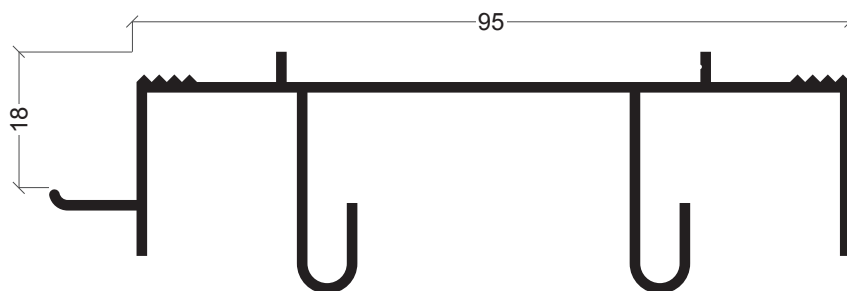

CS-21

Padieira
Marco superior

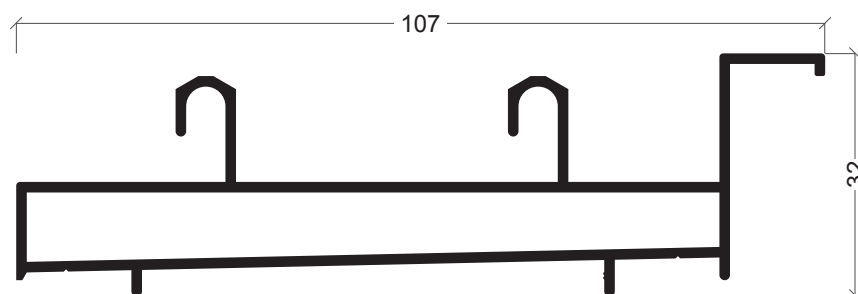

CS-29

Soleira
Marco inferior

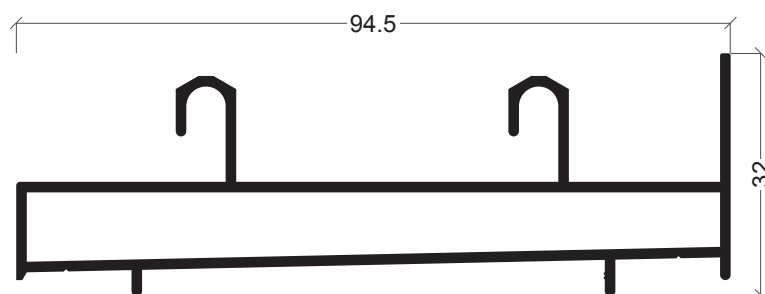

CS-39

Soleira
Marco inferior

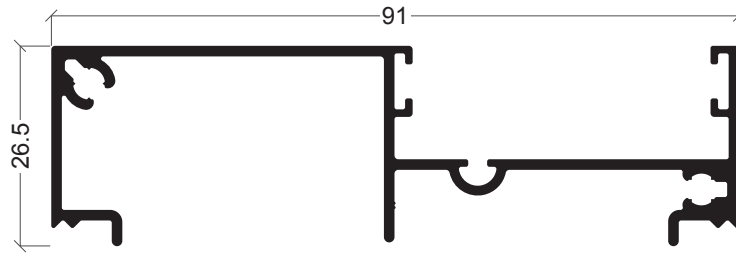

CS-04

Ombreira
Marco lateral

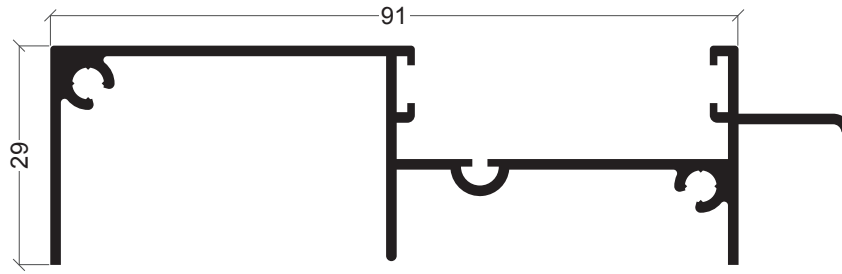

CS-54

Ombreira
Marco lateral

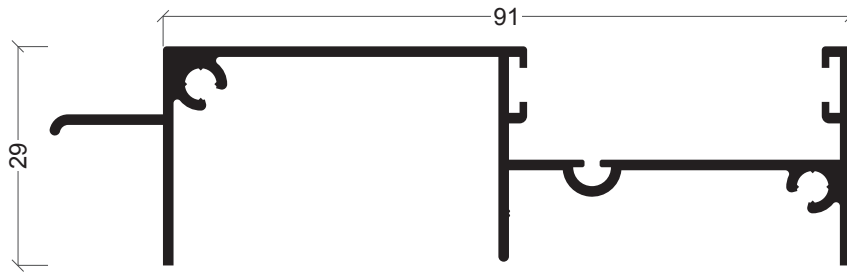

CS-55

Ombreira
Marco lateral

154

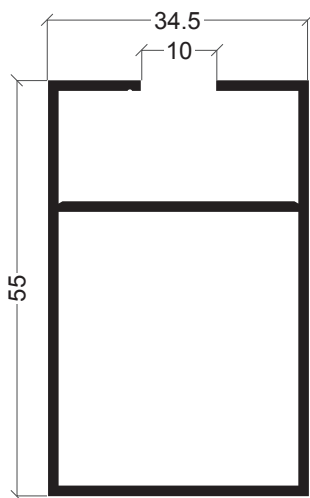

CS-75

Aro móvel lateral
Hoja lateral

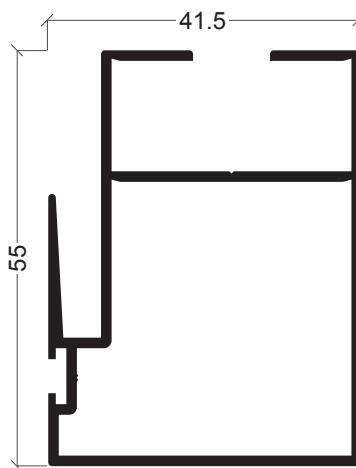

CS-76

Aro móvel central
Hoja central

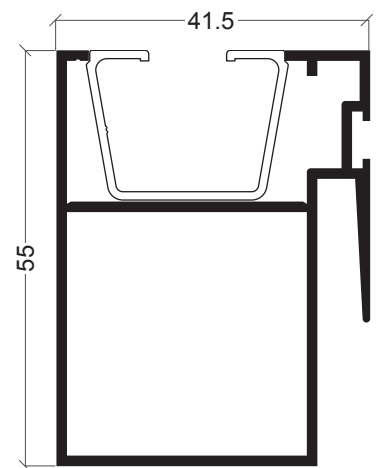

CS-87

Aro móvel central 3F
Hoja central 3F

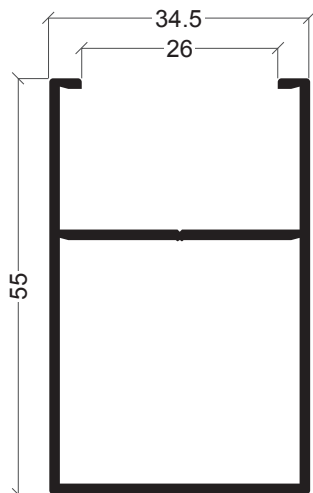

CS-85

Aro móvel lateral
Hoja lateral

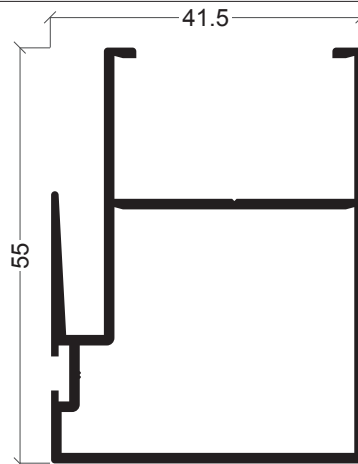

CS-86

Aro móvel central
Hoja central

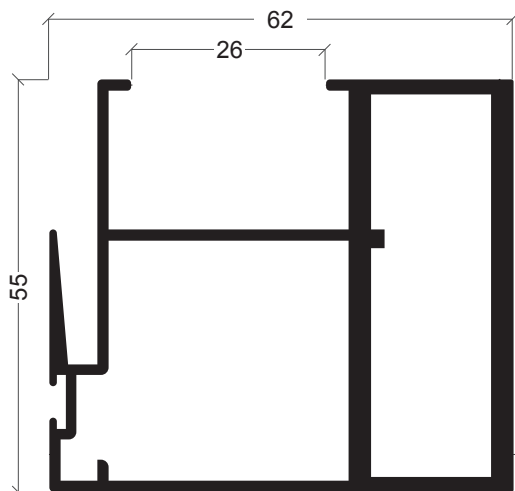

CS-90

Aro móvel central
Hoja central

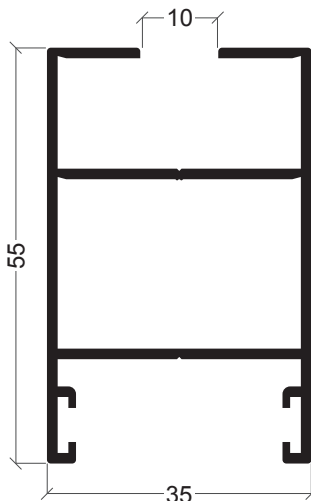

CS-94

Aro móvel lateral
Hoja lateral

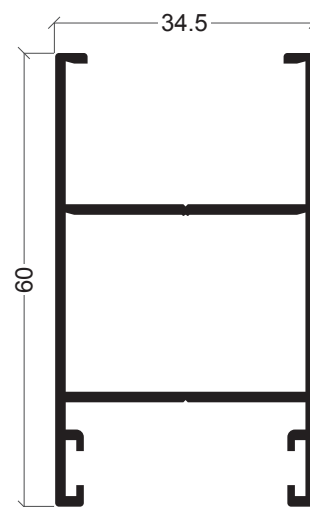

CS-96

Aro móvel lateral
Hoja lateral

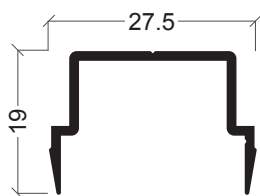

CS-48

União 3/4F com os perfis CS-93/95
Unión 3/4F con los perfiles CS-93/95

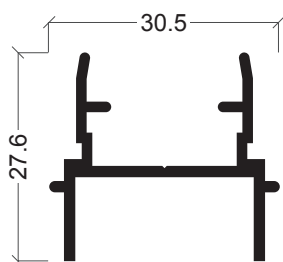

CS-38

União 3/4F com os perfis CS-94/96
Unión 3/4F con los perfiles CS-94/96

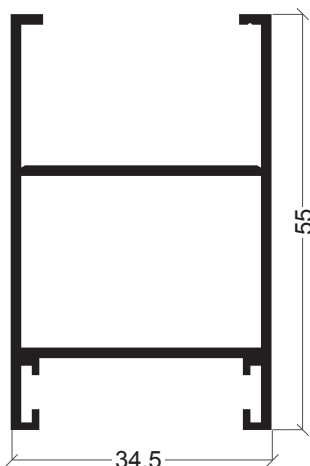

CS-93

Aro móvel lateral
Hoja lateral

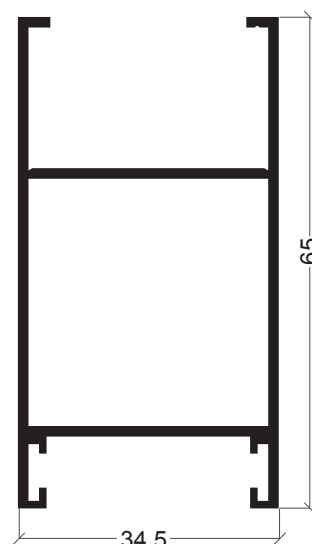

CS-95

Aro móvel lateral
Hoja lateral

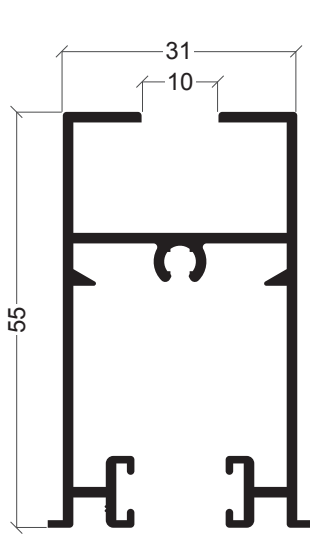

CS-70

Aro móvel carrinho
Hoja ruedas

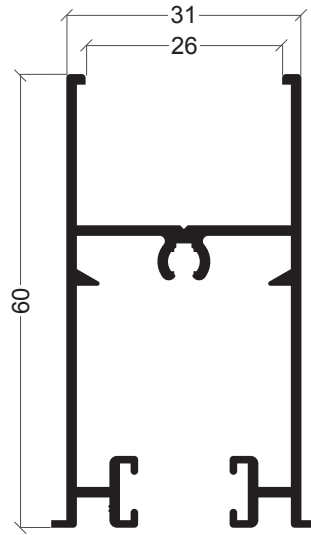

CS-80

Aro móvel carrinho
Hoja ruedas

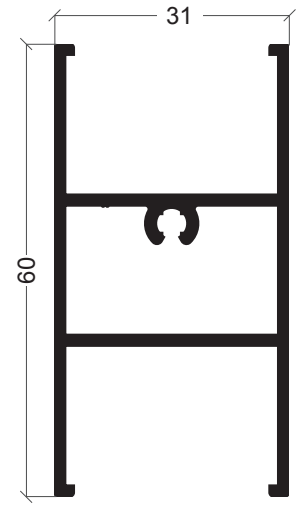

CS-83

Travessa
Travesaño

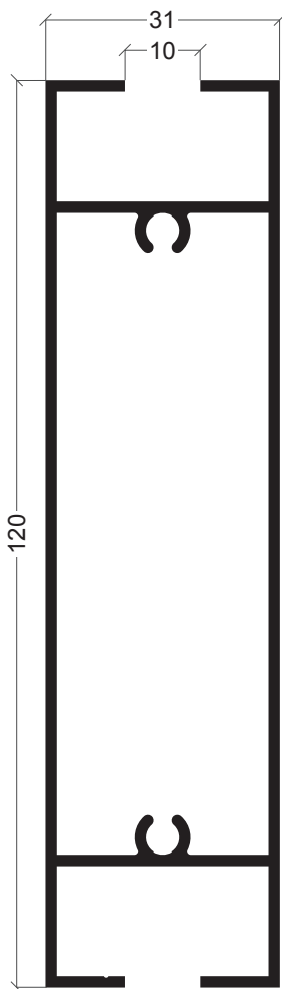

CS-71

Travessa
Travesaño

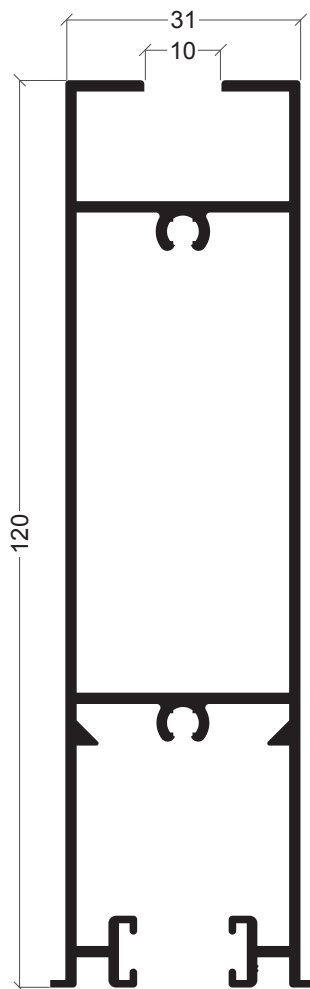

CS-72

Aro móvel carrinho
Hoja ruedas

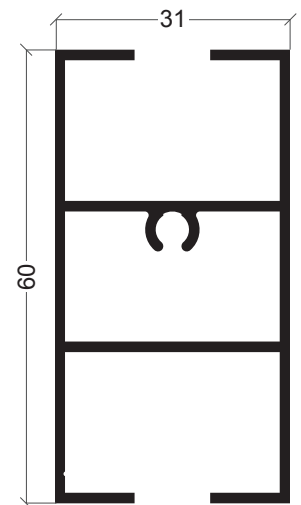

CS-73

Travessa
Travesaño

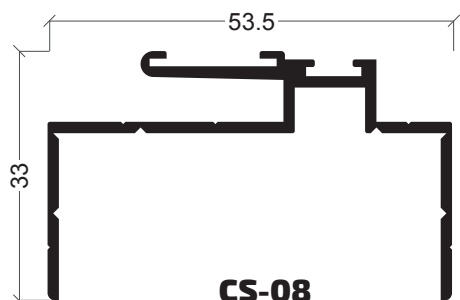

CS-08
Central mono-rail
Central monocarril

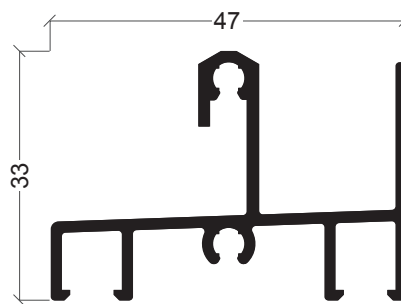

CS-05
Aro fixo sup/inferior mono-rail
Marco superior / inferior monocarril

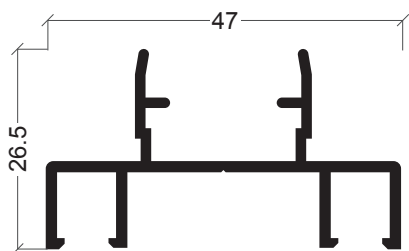

CS-07
Ombreira mono-rail
Lateral monocarril

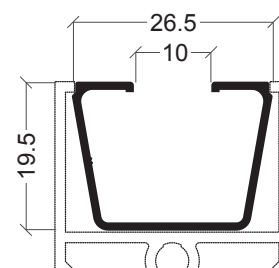

CS-74
Redutor
Reductor 10 mm

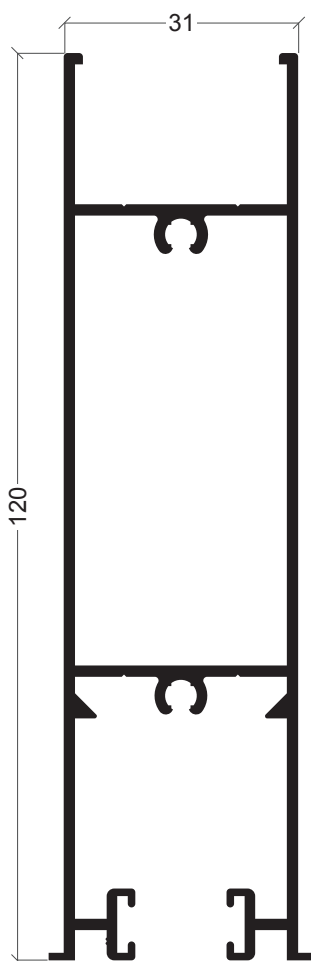

CS-82
Aro Móvel carrinho
Zócalo ruedas

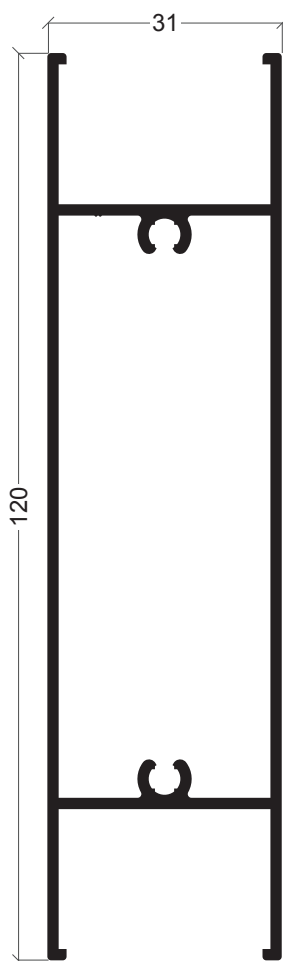

CS-81
Travessa
Travesaño 120x31 mm

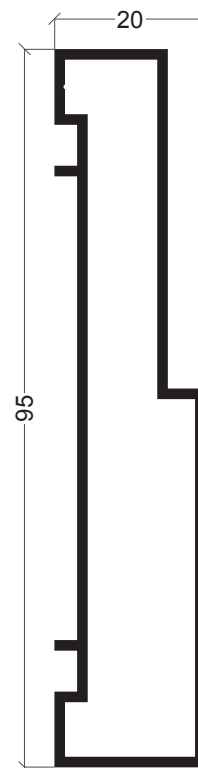

CS-15
União de aros
Unión marcos

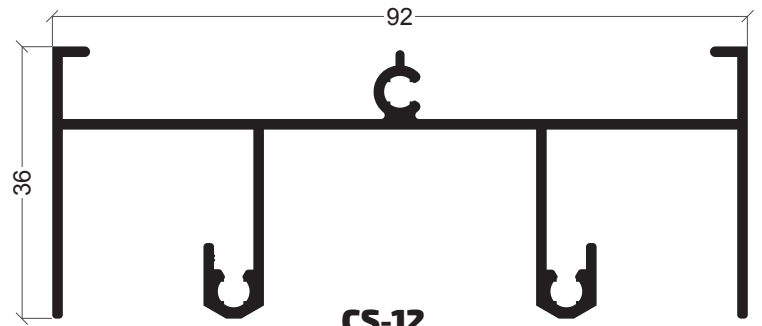

CS-12
Padieira
Marco superior

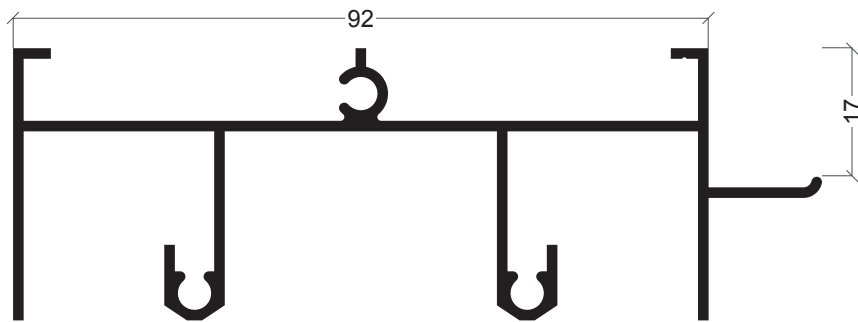

CS-51
Padieira
Marco superior

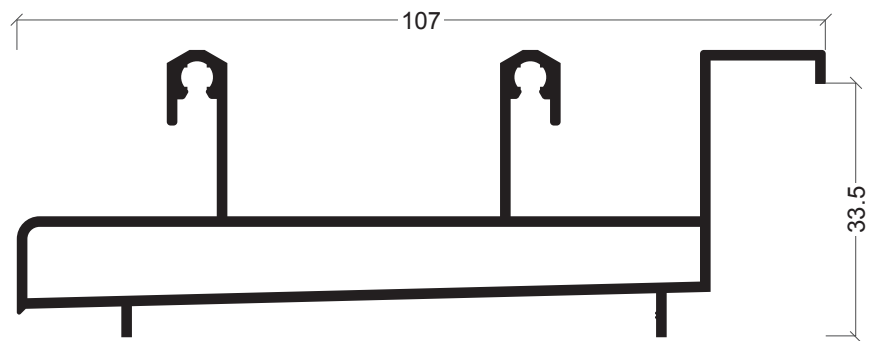

CS-69
Soleira
Marco inferior

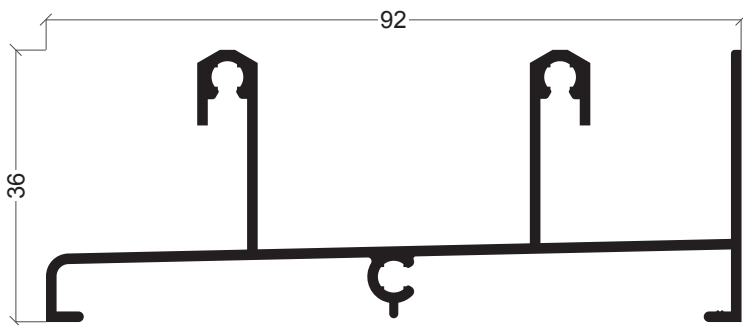

CS-19
Soleira
Marco inferior

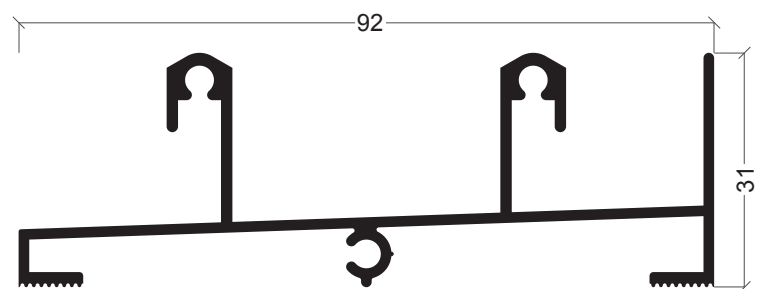

CS-49
Soleira
Marco inferior

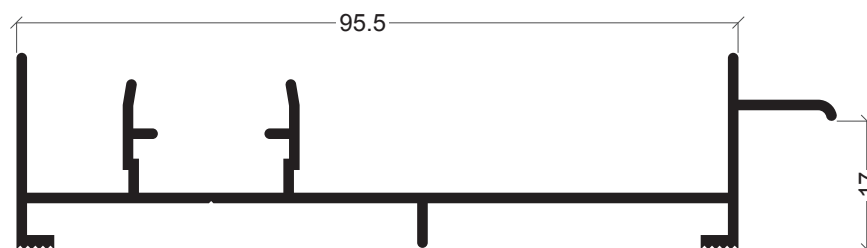
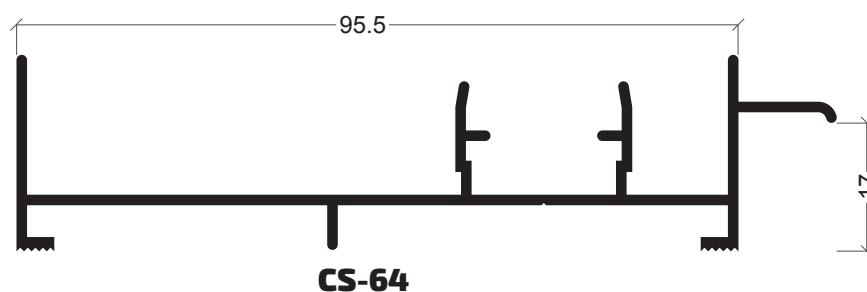
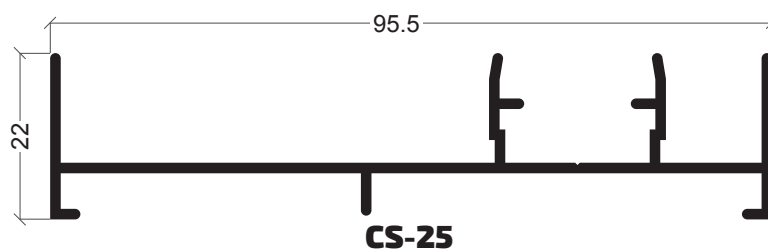
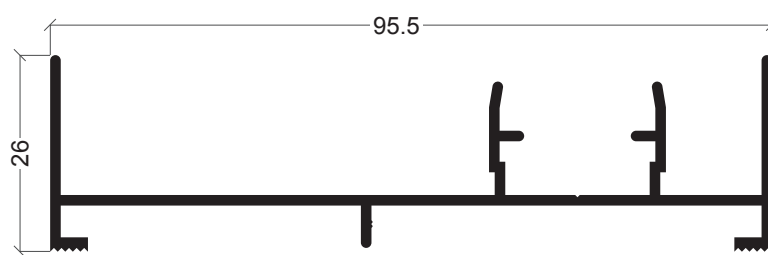
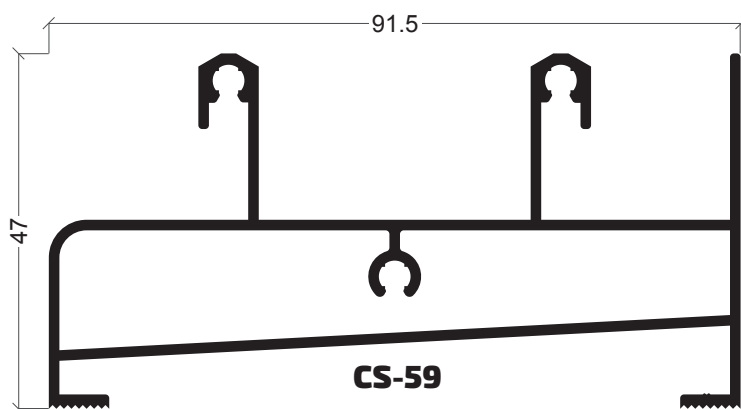

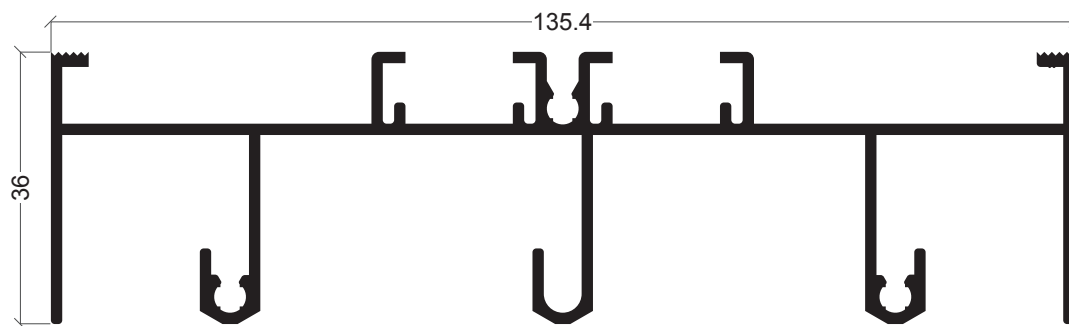

CS-22
Padeira tri-rail
Marco superior tricarril

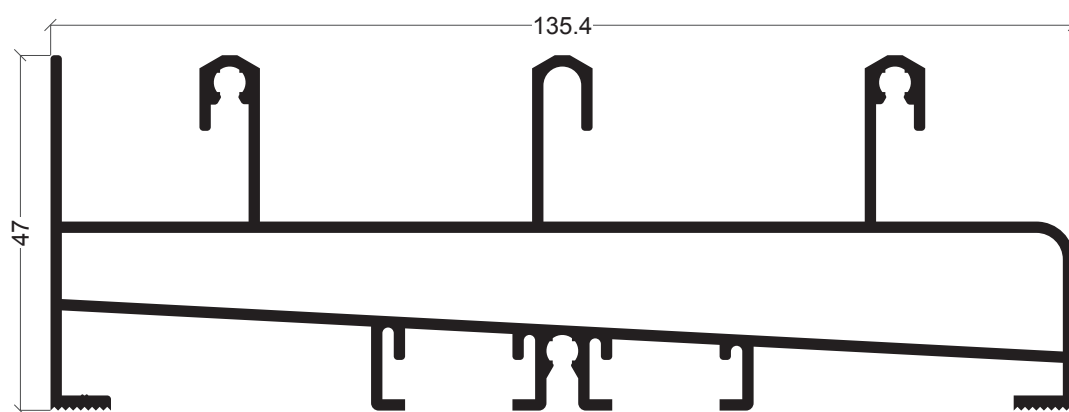

CS-79
Soleira tri-rail
Marco inferior tricarril

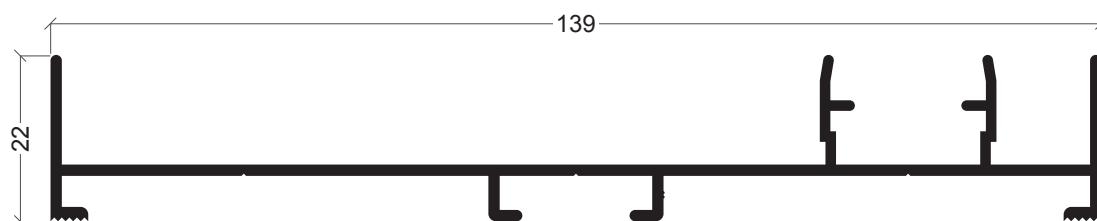

CS-14
Ombreira tri-rail
Marco lateral tricarril

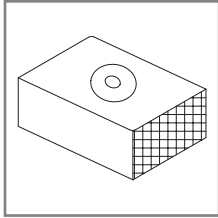

30 91 41 10

Taco anti-levantamento
Taco antilevantamiento negro

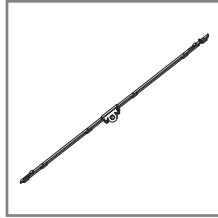

30 91 41 31

Barra 2 pontos com apoios (600 mm)
com CS-25/14
Barra 2 puntos con apoios (600 mm)
con CS-25/14

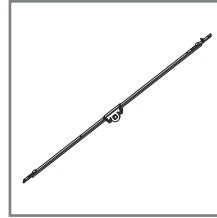

30 91 41 32

Barra 3 pontos com apoios (1670 mm)
com CS-25/14
Barra 3 puntos con apoios (1670 mm)
con CS-25/14

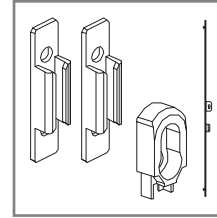

30 91 41 33

Ferragem multiponto c/ chave
Herraje MP CS Euro com llave

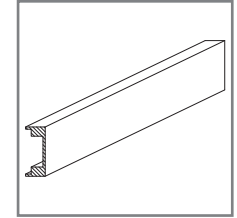

30 91 41 34

Calha multiponto(3mts)
Calha multipunto(3mts)

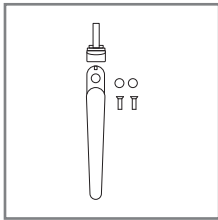

30 91 41 45/46

Puxador baixo multiponto branco/preto
Manilla Baja multipunto Blanco/negro

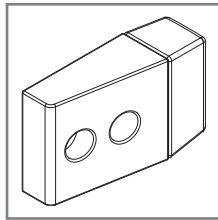

30 91 41 71

Tope limitador de abertura
Tope limitador de apertura CT

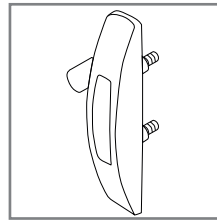

30 91 42 00/01

Fecho janela correr multiponto branco/preto
Cierre ventana correr multipunto blanco/negro

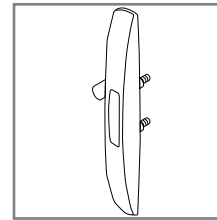

30 91 42 05/06

Fecho porta correr multiponto branco/preto
Cierre puerta correr multipunto blanco/negro

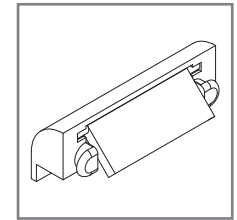

30 92 01 02/03

Goteira com válvula branco/preto
Vierteaguas con Deflector blanco/negro

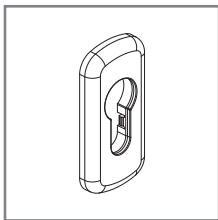

30 92 22 85/86

Escudo para canhão branco/preto
Escudo para bombillo blanco/negro

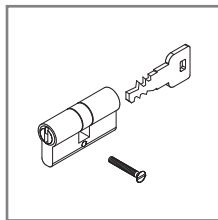

30 93 02 45

Canhão
Bombillo

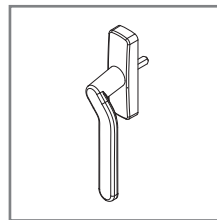

30 95 60 26/28

Puxador desviado multiponto c/chave direito
branco/preto
Manilla desviada multipunto c/llave derecha
blanco/negro

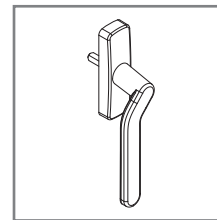

30 95 60 27/29

Puxador desviado multiponto c/chave esquerdo
branco/preto
Manilla desviada multipunto c/chave izquierdo
blanco/negro

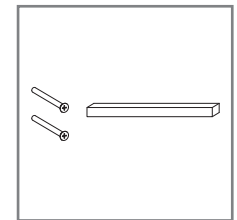

30 95 60 36

Conjunto perno+parafuso para puxador desviado
Conjunto Perno + Tornillo para manilla doble

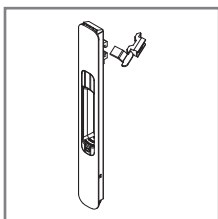

30 97 10 01/02

Fecho lateral automático branco/preto
Cierre lateral automatico CS blanco/negro

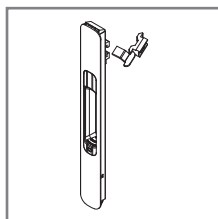

30 97 10 03/04

Fecho lateral manual branco/preto
Cierre lateral manual CS blanco/negro

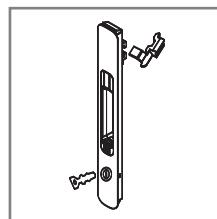

30 97 10 05/06

Fecho lateral com chave branco/preto
Cierre lateral con llave CS blanco/negro

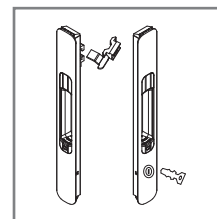

30 97 10 07/08

Fecho lateral duplo com chave branco/preto
Cierre lateral doble con llave CS blanco/negro

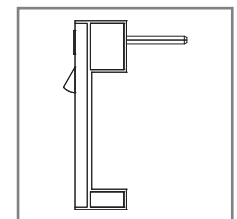

30 97 10 13/14

Fecho central preto/branco
Cierre central negro/blanco

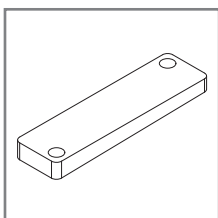

30 97 10 19

Tope de vedação para soleiras CS-29/39
Tope de vedación CS-29 / CS-39

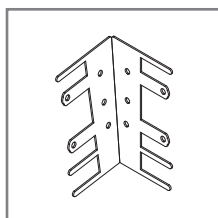

30 97 10 20

Kit Juntas Estanquidade
Kit Juntas Estanquidad

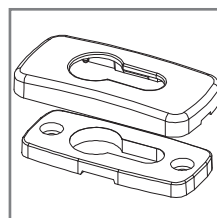

31 70 16 43

Escudo de alumínio
Escudo de aluminio

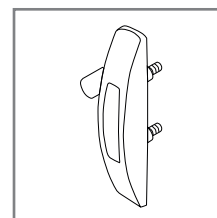

31 90 85 63

Fecho janela correr multiponto(cores)
Cierre ventana correr multipunto(colores)

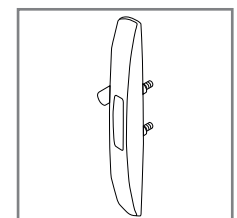

31 90 85 64

Fecho porta correr multiponto(cores)
Cierre puerta correr multipunto(colores)

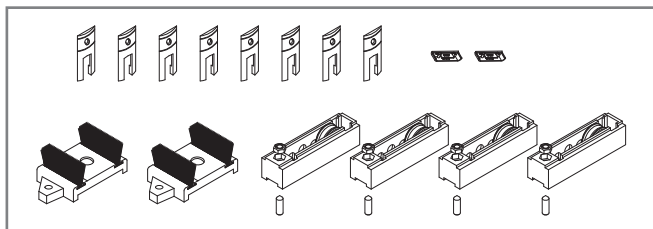

30 97 10 09

Kit janela 2F CS normal(50Kg/folha)
Kit ventana 2 hojas CS Norma(50Kg/hoja)

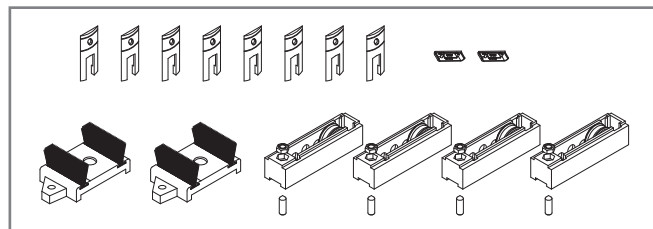

30 97 10 10

Kit janela 2F CS euro(50Kg/folha)
Kit ventana 2 hojas CS Euro(50Kg/hoja)

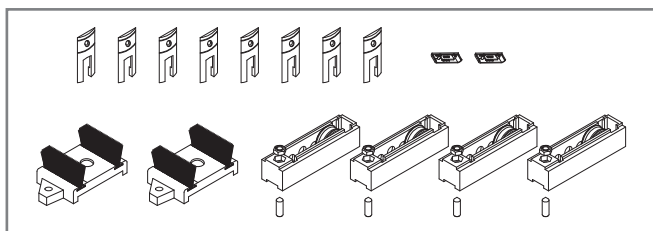

30 97 10 11

Kit porta 2F CS normal(90 Kg/folha)
Kit puerta 2 hojas CS Normal (90 Kg/hoja)

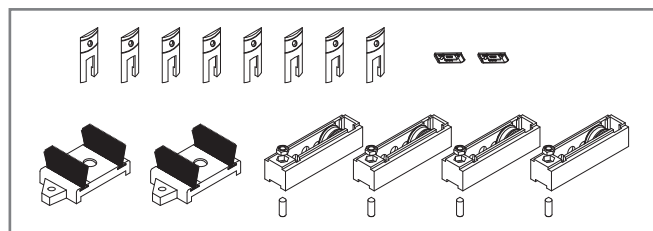

30 97 10 12

Kit porta 2F CS euro (90 Kg/folha)
Kit puerta 2 hojas CS Euro(90 Kg/hoja)

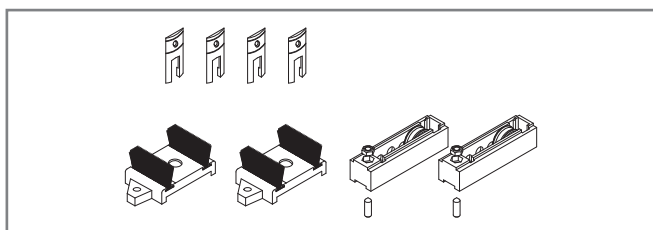

30 97 10 15

Kit janela suplementar 3F CS normal (50Kg/folha)
Kit suplementario ventana 3 hojas CS Normal(50Kg/hoja)

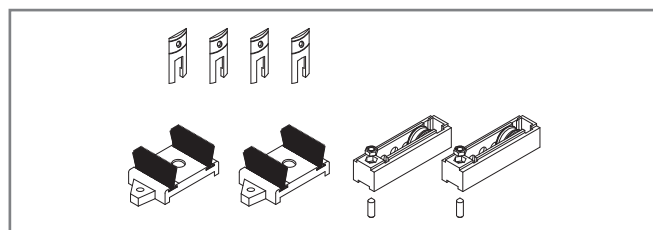

30 97 10 16

Kit janela suplementar 3F CS euro (50Kg/folha)
Kit suplementario ventana 3 hojas CS Euro(50Kg/hoja)

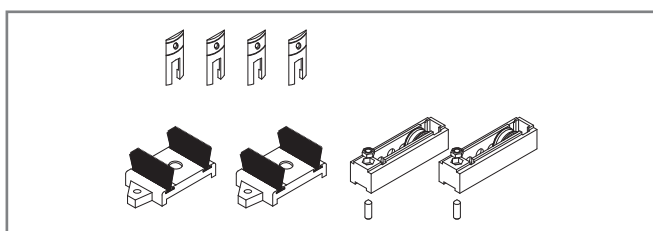

30 97 10 17

Kit porta suplementar 3F F CS normal (90 Kg/folha)
Kit suplementario puerta 3 hojas CS Normal (90 Kg/hoja)

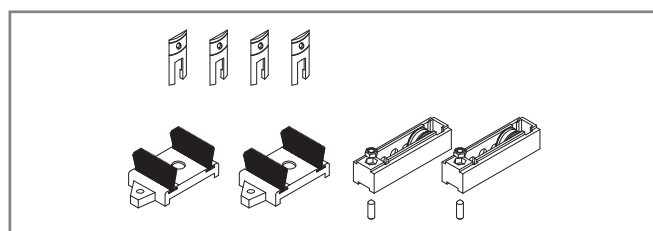







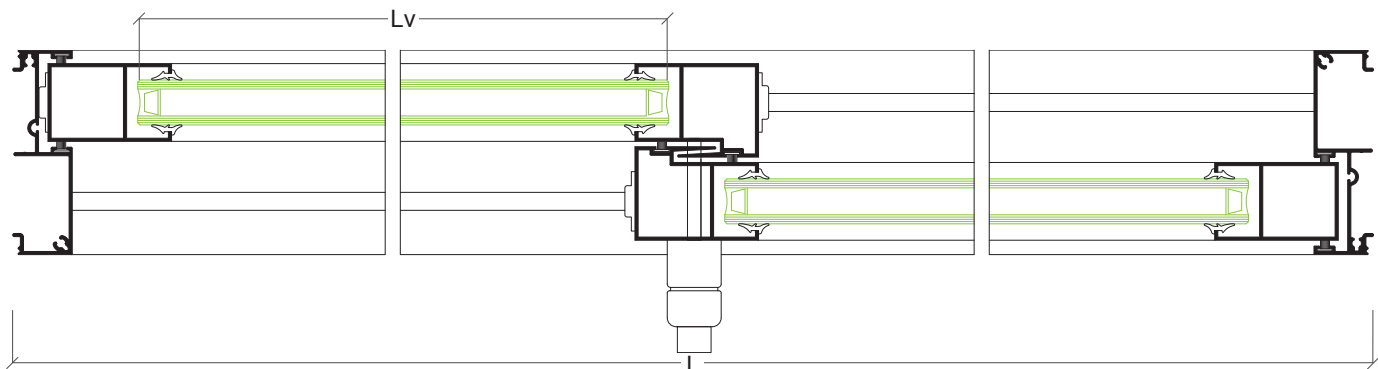
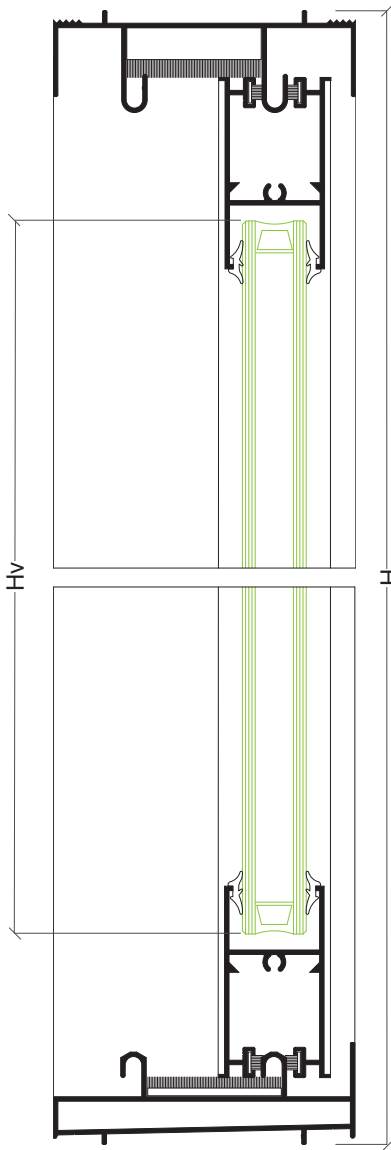
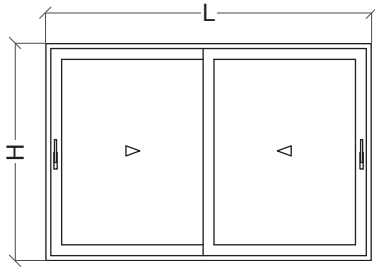



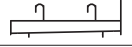

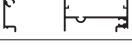
30 97 10 18

Kit porta suplementar 3F F CS euro (90 Kg/folha)
Kit suplementario puerta 3 hojas CS Euro (90 Kg/hoja)

REFERÊNCIA • REFERENCIA	DESENHO • DISEÑO	DESCRIÇÃO • DESCRIPCIÓN
30 95 00 40		Pelúcia 7x5.5 mm • Burlete 7x5.5 mm STOP-FIN
30 97 10 25		Junta U CS vidro 22 mm • Junta U CS vidro 22 mm
30 97 10 26		Junta U CS vidro 20/21 mm • Junta U CS vidro 20/21 mm
30 95 00 80		Pelúcia 7x5 mm • Burlete 7x5 mm STOP-FIN

Janela 2 folhas correr • Ventana 2 hojas correr

PERFIS • PERFIS

DESENHO • DISEÑO	REF.	DESCRIÇÃO • DESCRIPCIÓN	CORTE CORTE	QUANTIDADE CANTIDAD	MEDIDAS • MEDIDA
	CS-01	Padieira • Marco Superior		1	L
	CS-39	Soleira • Marco inferior		1	L
	CS-04	Ombreira • Marco lateral		2	H-20 mm
	CS-80	Móvel carrinho • Hoja ruedas		4	L/2+9 mm
	CS-85	Móvel lateral • Hoja lateral		2	H-44 mm
	CS-86	Móvel central • Hoja central		2	H-44 mm









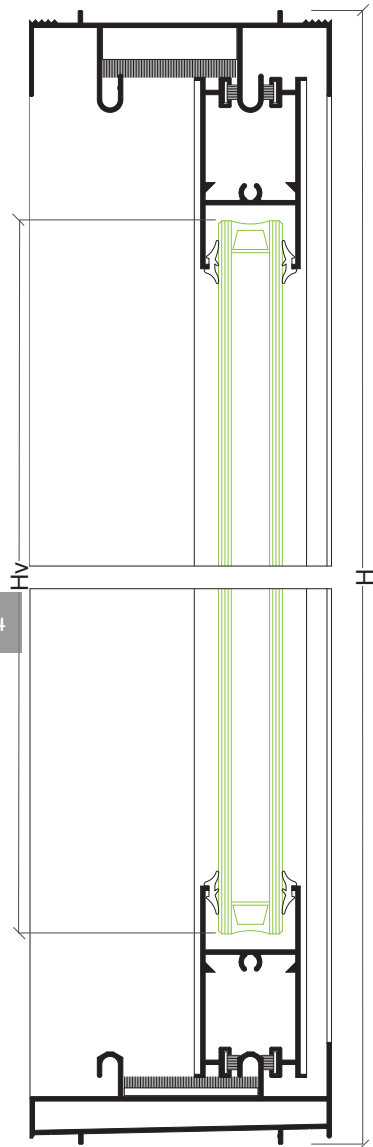
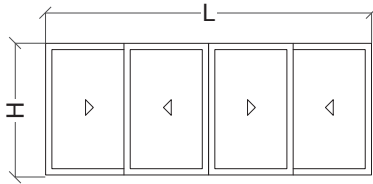

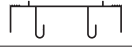

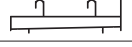

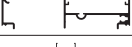

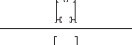
ACESSÓRIOS E JUNTAS • ACCESORIOS Y JUNTAS

REF.	DESCRIÇÃO • DESCRIPTION	QUANTIDADE CANTIDAD
30 97 10 14	Fecho central branco • Cierre central blanco	1
30 97 10 09	Kit janela 2F CS normal • Kit ventana 2 hojas CS normal	1
30 97 10 19	Topo para soleira • Tope de vedación CS-29 / CS-39	2
30 95 00 80	Pelúcia 7x5 mm • Burlete 7x5 mm FIN-SEAL	4L
30 95 00 40	Pelúcia 7x5.5 mm • Burlete 7x5.5 mm FIN-SEAL	6H
-	Junta de vidro • Junta de vidrio	4L/8H

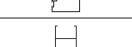
VIDRO • VIDRIO

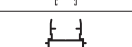
Hv = H-132 mm	Lv = L/2-68 mm
---------------	----------------

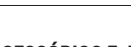
Janela 4 folhas correr • Ventana 4 hojas correr

PERFIS • PERFIS

DESENHO • DISEÑO	REF.	DESCRIÇÃO • DESCRIPCIÓN	CORTE CORTE	QUANTIDADE CANTIDAD	MEDIDAS • MEDIDA
	CS-01	Padieira • Marco superior		1	L
	CS-39	Soleira • Marco inferior		1	L
	CS-04	Ombreira • Marco lateral		2	H-20 mm
	CS-80	Móvel carrinho • Hoja ruedas		8	L/4+10 mm
	CS-85	Móvel lateral • Hoja lateral		2	H-44 mm
	CS-86	Móvel central • Hoja central		4	H-44 mm
	CS-96	Móvel central • Hoja lateral		2	H-44 mm
	CS-38	União 3/4F • Unión 3/4 hojas		1	H-44 mm

ACESSÓRIOS E JUNTAS • ACCESORIOS Y JUNTAS

REF.	DESCRIÇÃO • DESCRIPTION	QUANTIDADE CANTIDAD
30 97 10 14	Fecho central branco • Cierre central blanco	2
30 97 10 09	Kit janela 2F CS normal • Kit ventana 2 hojas CS normal	2
30 97 10 19	Topo para soleira • Tope de vedación CS-29 / CS-39	2
30 95 00 80	Pelúcia 7x5 mm • Burlete 7x5 mm FIN-SEAL	4L
30 95 00 40	Pelúcia 7x5.5 mm • Burlete 7x5.5 mm FIN-SEAL	10H
-	Junta de vidro • Junta de vidrio	4L/16H







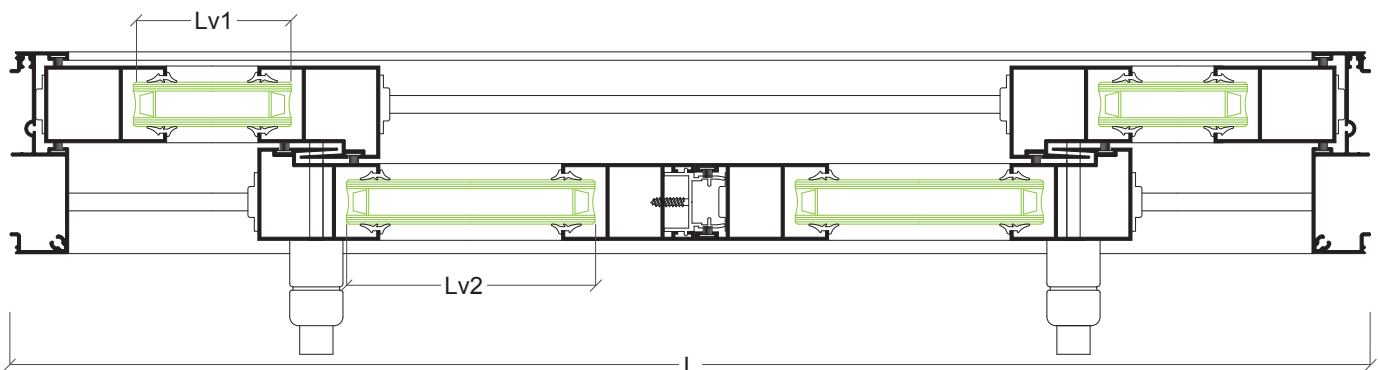



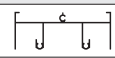

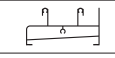
VIDRO • VIDRIO

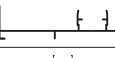
Hv = H-132 mm	Lv1 = L/4-68 mm
Hv = H-132 mm	Lv2 = L/4-59 mm

164

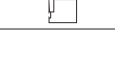

Janela 2 folhas correr • Ventana 2 hojas correr
PERFIS • PERFIS

DESENHO • DISEÑO	REF.	DESCRIÇÃO • DESCRIPCIÓN	CORTE CORTE	QUANTIDADE CANTIDAD	MEDIDAS • MEDIDA
	CS-12	Padieira • Marco superior		1	L-16 mm
	CS-59	Soleira • Marco inferior		1	L-16 mm
	CS-24	Ombreira • Marco lateral		2	H
	CS-80	Móvel carrinho • Hoja ruedas		4	L/2+0.5 mm
	CS-96	Móvel lateral • Hoja lateral		2	H-64 mm
	CS-86	Móvel central • Hoja central		2	H-64 mm

ACESSÓRIOS E JUNTAS • ACCESORIOS Y JUNTAS

REF.	DESCRIÇÃO • DESCRIPTION	QUANTIDADE CANTIDAD
30 97 10 01	Fecho lateral automático branco • Cierre lateral automatico CS blanco	2
30 97 10 10	Kit janela 2 folhas CS Euro • Kit ventana 2 hojas CS Euro	1
30 91 41 10	Taco anti-levantamento • Taco antilevantamiento negro	2
30 95 00 80	Pelúcia 7x5 mm • Burlete 7x5 mm FIN-SEAL	4L/4H
30 95 00 40	Pelúcia 7x5.5 mm • Burlete 7x5.5 mm FIN-SEAL	2H
30 97 10 20	Junta de estanquidade • Junta de estanqueidad	2
---	Junta de vidro • Junta de vidrio	4L/8H

VIDRO • VIDRIO



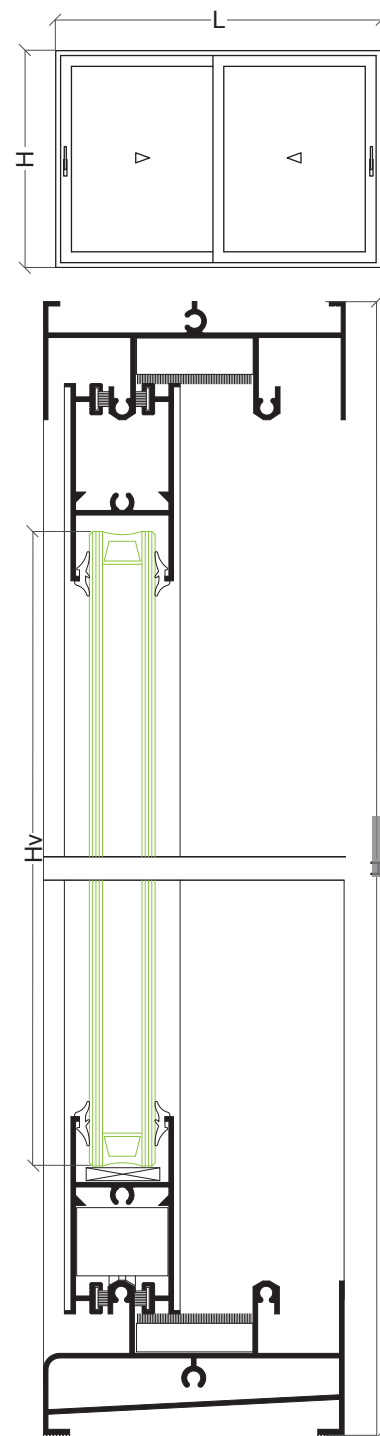



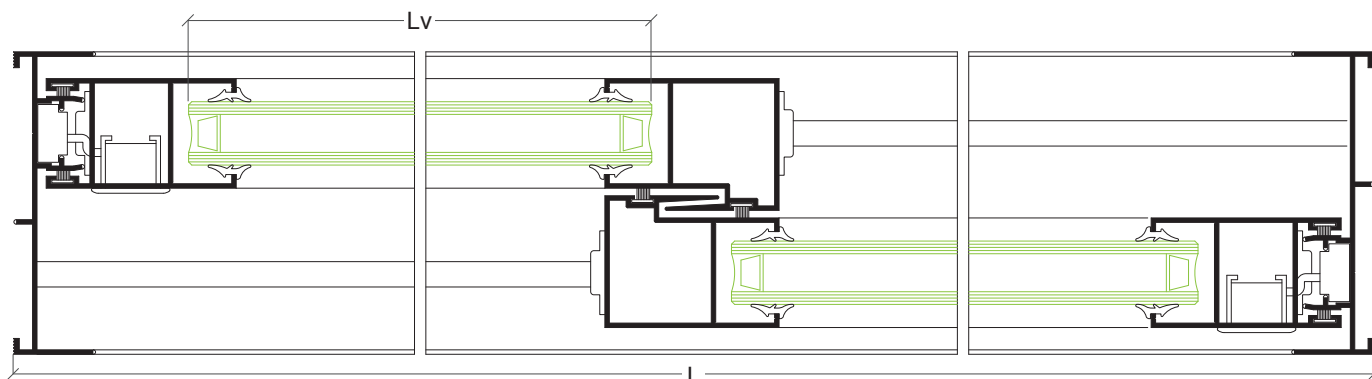

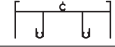

Hv = H-152 mm	Lv = L/2-68 mm
---------------	----------------

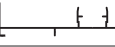
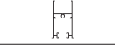

165

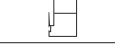

Janela 4 folhas correr • Ventana 4 hojas correr
PERFIS • PERFIS

DESENHO • DISEÑO	REF.	DESCRIÇÃO • DESCRIPCIÓN	CORTE CORTE	QUANTIDADE CANTIDAD	MEDIDAS • MEDIDA
	CS-12	Padieira • Marco superior		1	L-16 mm
	CS-19	Soleira • Marco inferior		1	L-16 mm
	CS-24	Ombreira • Marco lateral		2	H
	CS-80	Móvel carrinho • Hoja ruedas		8	L/4+5 mm
	CS-96	Móvel lateral • Hoja lateral		4	H-53 mm
	CS-86	Móvel central • Hoja central		4	H-53 mm
	CS-38	União 3/4F • Unión 3/4 hojas		1	H-53 mm

ACESSÓRIOS E JUNTAS • ACCESORIOS Y JUNTAS

REF.	DESCRIÇÃO • DESCRIPTION	QUANTIDADE CANTIDAD
30 97 10 01	Fecho lateral automático branco • Cierre lateral automatico CS blanco	3
30 97 10 10	Kit janela 2 folhas CS Euro • Kit ventana 2 hojas CS Euro	2
30 91 41 10	Taco anti-levantamento • Taco antilevantamiento negro	3
30 95 00 80	Pelúcia 7x5 mm • Burlete 7x5 mm FIN-SEAL	4L/6H
30 95 00 40	Pelúcia 7x5.5 mm • Burlete 7x5.5 mm FIN-SEAL	4H
30 97 10 20	Junta de estanquidade • Junta de estanqueidad	2
-	Junta de vidro • Junta de vidrio	4L/16H

VIDRO • VIDRIO

Hv = H-140 mm	Lv = L/4-63 mm
---------------	----------------

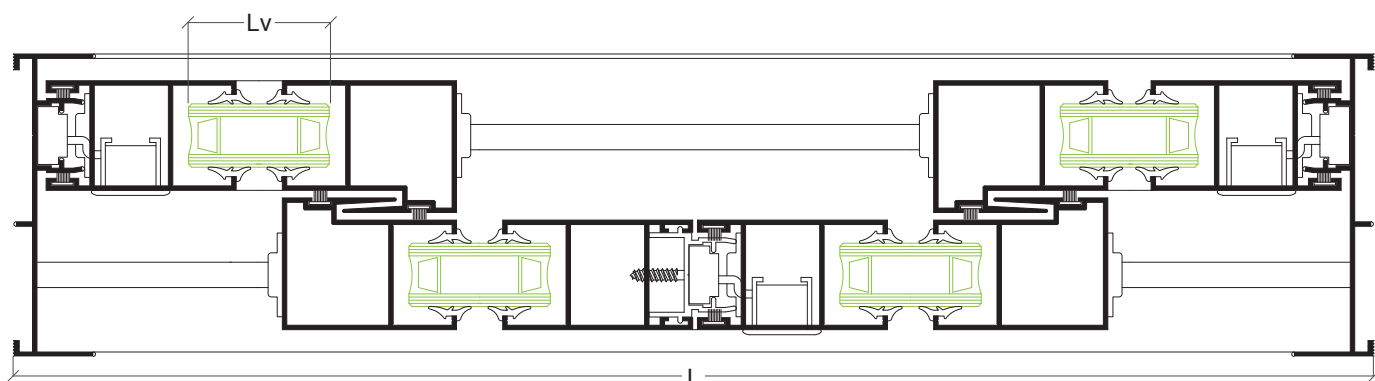
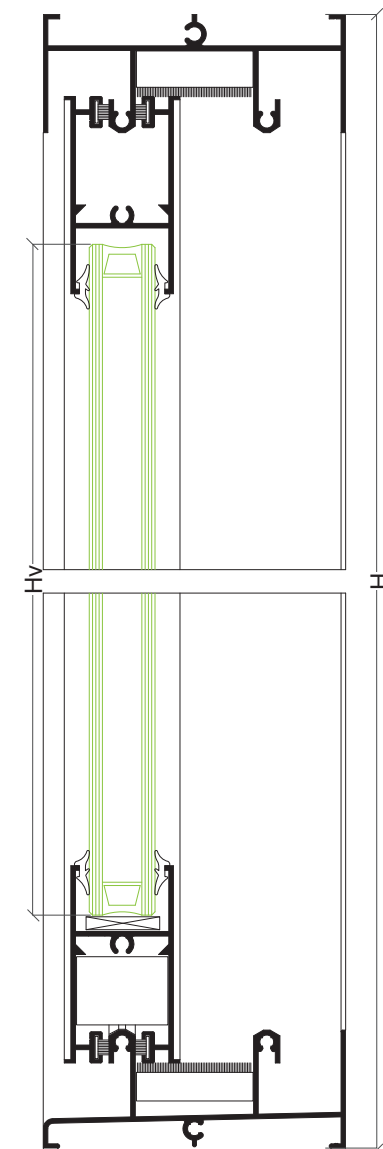
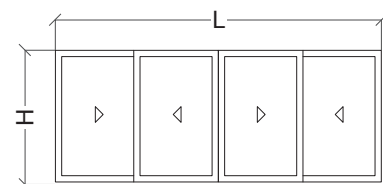

Porta 2 folhas correr multiponto • Puerta 2 hojas correr multipunto

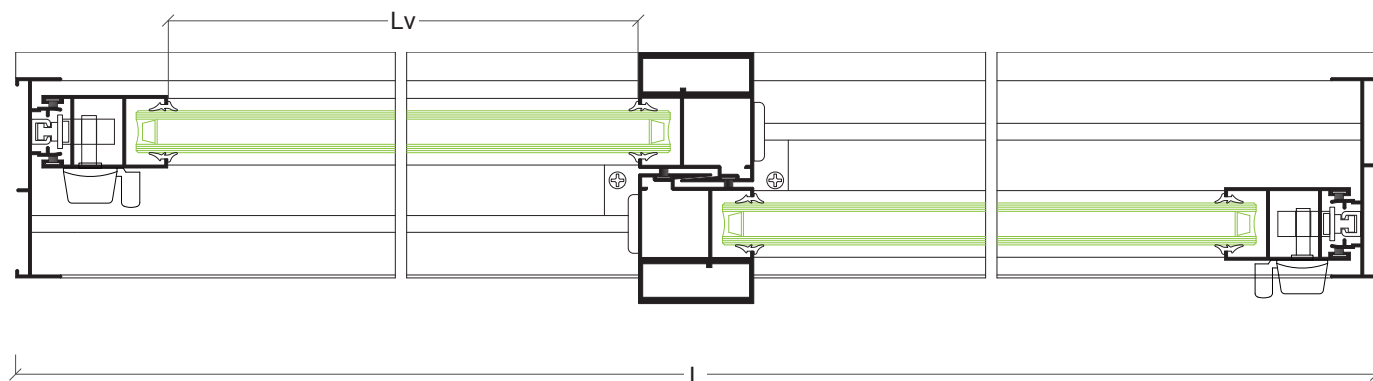
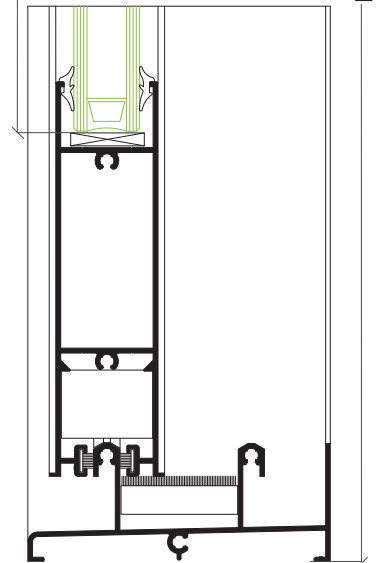
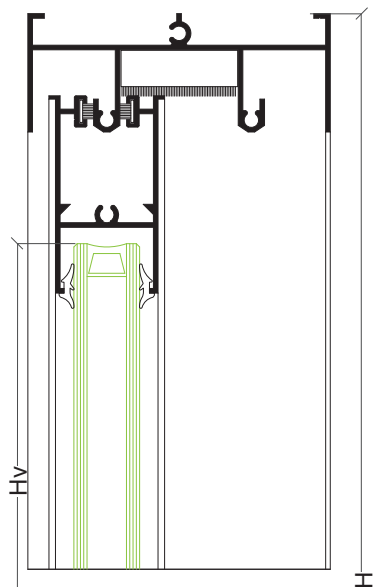
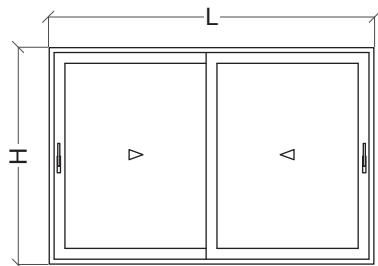

PERFIS • PERFIS

DESENHO • DISEÑO	REF.	DESCRIÇÃO • DESCRIPCIÓN	CORTE CORTE	QUANTIDADE CANTIDAD	MEDIDAS • MEDIDA
	CS-12	Padieira • Marco superior		1	L-16 mm
	CS-19	Soleira • Marco inferior		1	L-16 mm
	CS-25	Ombreira • Marco lateral		2	H
	CS-80	Móvel carrinho • Hoja ruedas		2	L/2-1 mm
	CS-82	Almofada • Zócalo ruedas		2	L/2-1 mm
	CS-96	Móvel lateral • Hoja lateral		2	H-53 mm
	CS-90	Móvel central • Hoja central		2	H-53 mm











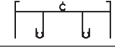

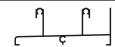

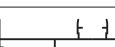

ACESSÓRIOS E JUNTAS • ACCESORIOS Y JUNTAS

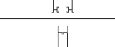
REF.	DESCRIÇÃO • DESCRIPTION	QUANTIDADE CANTIDAD
30 91 41 32	Barra 3 pontos (1670 mm) • Barra 3 puntos	2
30 97 10 12	Kit porta 2 folhas CS Euro • Kit puerta 2 hojas CS Euro	1
30 91 41 71	Topo limitador • Tope limitador	1
30 95 00 80	Pelúcia 7x5 mm • Burlete 7x5 mm	4L/4H
30 95 00 40	Pelúcia 7x5.5 mm • Burlete 7x5.5 mm	2H
30 97 10 20	Junta de estanquidade • Junta de estanquidad	2
-	Junta de vidro • Junta de vidrio	4L/8H
30 91 42 06	Fecho porta multiponto • Cierre puerta multipunto	2

VIDRO • VIDRIO

Hv = H-201 mm	Lv = L/2-70 mm
---------------	----------------

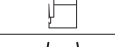
Porta 4 folhas correr multiponto • Puerta 4 hojas corrermultipunto
PERFIS • PERFIS

DESENHO • DESEÑO	REF.	DESCRIÇÃO • DESCRIPCIÓN	CORTE CORTE	QUANTIDADE CANTIDAD	MEDIDAS • MEDIDA
	CS-12	Padieira • Marco superior		1	L-16 mm
	CS-19	Soleira • Marco inferior		1	L-16 mm
	CS-25	Ombreira • Marco lateral		2	H
	CS-80	Móvel carrinho • Hoja ruedas		4	L/4+4 mm
	CS-82	Almofada • Zócalo ruedas		4	L/4+4 mm
	CS-96	Móvel lateral • Hoja lateral		4	H-53 mm
	CS-86	Móvel central • Hoja central		4	H-53 mm
	CS-38	União 3/4F • Unión 3/4 hojas		1	H-44 mm

ACESSÓRIOS E JUNTAS • ACCESORIOS Y JUNTAS

REF.	DESCRIÇÃO • DESCRIPTION	QUANTIDADE CANTIDAD
30 91 41 32	Barra 3 pontos (1670 mm) • Barra 3 puntos (1670 mm)	3
30 97 10 12	Kit porta 2 folhas CS Euro • Kit puerta 2 hojas CS Euro	2
30 91 41 71	Topo limitador • Tope limitador	2
30 95 00 80	Pelúcia 7x5 mm • Burlete 7x5 mm	4L/6H
30 95 00 40	Pelúcia 7x5.5 mm • Burlete 7x5.5 mm	4H
30 97 10 20	Junta de estanquidade • Junta de estanquidad	2
-	Junta de vidro • Junta de vidrio	4L/16H
30 91 42 06	Fecho porta multiponto • Cierre puerta multipunto	3

VIDRO • VIDRIO

Hv = H-201 mm	Lv = L/4-65 mm
---------------	----------------

