

www.anicolor.pt



**SISTEMA DE BATENTE
COM RPT - 60 mm**

**SISTEMA PRACTICABLE DE CANAL EUROPEO
COM RPT - 60 mm**

ARi

 **anicolor**
Sistemas de Alumínio

SISTEMA ARi

Sistema de batente com RPT - 60 mm

CARACTERÍSTICAS DO SISTEMA

Sistema de batente com rotura térmica e de elevadas prestações térmicas e acústicas. O sistema ARi possibilita a execução de 5 versões de caixilharia:

linha recta, curva, tradição, oval e oculta.

O sistema ARi permite a aplicação de vidros duplos ou triplos de alto rendimento de modo a responder às exigências de isolamento térmico e acústico.

A versão ARi Folha Oculta permite a ocultação do aro móvel.

Com um ótimo isolamento térmico aliado à aplicação de um inovador produto designado por ThermoProfile, o Sistema ARi proporciona elevadas prestações de conforto e de economia energética.

PERFIS DE ALUMÍNIO

Os perfis de alumínio são extrudidos na liga de alumínio 6060 para arquitetura de acordo com norma NP EN 12020-02.

Rotura térmica obtida por inserção de varetas isolantes de poliamida tipo ómega de 24 mm, reforçadas com 25% de fibra de vidro.

Espessura média dos perfis de alumínio de 1.5 mm para janelas e de 1.7 mm para portas.

AROS FIXOS

Secção dos aros fixos de 60 mm ou 84.5 mm com tripla câmara;

Aros fixos com esquadros duplos para montagem a meia esquadria;

Aros fixos tradicionais para mercado interno;

Aros fixos com clip exterior e aba de remate direta de 25 mm ou 45 mm;

Aros fixos com clip exterior e interior para aplicação de remate de 30 mm.

AROS MÓVEIS

Secção dos aros móveis de 68 mm com tripla câmara;

Enchimento para vidro duplo ou triplo de 10 mm a 45 mm para o sistema ARi;

Enchimento para vidro duplo até 23 mm para o sistema ARi Folha Oculta;

Aros móveis de linha recta, curva, tradição ou oval;

Aros móveis com esquadros duplos para montagem a meia esquadria;

Perfil inversor de linha recta.

72 DIMENSIONAMENTO E MANOBRABILIDADE

Dimensões mínimas - máximas de folha: 400 mm - 1500 mm (L); 400 mm - 2700 mm (H);

Possibilidades de abertura: fixo, batente interior 1 ou 2 folhas com oscilo-batente, exterior, basculante, projectante, pivotante, harmónio e oscilo-paralela;

Estanquidade assegurada através de juntas triplas em EPDM.

Possibilidades de abertura com micro-ventilação

PERFORMANCES

Sistema certificado por laboratório credenciado, notificado para Ensaio Tipo Inicial de acordo com a norma de produto EN 14351-1 para efeitos de Marcação CE.

Categorias alcançadas na avaliação do sistema ARi tipologia janela:

1. Permeabilidade ao ar: Classe 4 (norma de ensaio EN 10207 e EN 1026)
2. Estanquidade à água: Classe E750 (norma de ensaio EN 12208 e EN 1027)
3. Resistência ao vento: Classe C5 (norma de ensaio EN 12208 e EN 12211)

Categorias alcançadas na avaliação do sistema ARi tipologia porta:

1. Permeabilidade ao ar: Classe 4 (norma de ensaio EN 10207 e EN 1026)
2. Estanquidade à água: Classe 9A (norma de ensaio EN 12208 e EN 1027)
3. Resistência ao vento: Classe C3 (norma de ensaio EN 12208 e EN 12211)
4. Resistência à torção estática: Apto 350N (norma de ensaio EN 14609)

Categorias alcançadas na avaliação do sistema ARi-Folha Oculta tipologia janela:

1. Permeabilidade ao ar: Classe 3 (norma de ensaio EN 10207 e EN 1026)
2. Estanquidade à água: Classe 7A (norma de ensaio EN 12208 e EN 1027)
3. Resistência ao vento: Classe C5 (norma de ensaio EN 12208 e EN 12211)

Coefficiente de transmissão térmica de vão de 2 folhas, sistema ARi, com 1.20 m x 1.50 m com vidro Ug = 0.7 W/m²K, com intercalar efeito "Warm Edge":

• Uw = 1.54 W/m²K

Coefficiente de transmissão térmica de vão de 2 folhas, sistema ARi Folha Oculta com

1.80 m x 2.20 m com vidro Ug = 1.1 W/m²K, com intercalar efeito "Warm Edge":

• Uw = 1.70 W/m²K

Coefficiente de atenuação acústica de vão de 2 folhas com vidro 4/16 (gás Árgon)/6 (sistema ARi):

• Rw (C; Ctr) = 38 dB (-2; -6)

Coefficiente de atenuação acústica de vão de 2 folhas com vidro 4/16 (gás Árgon)/6 (ARi - Folha Oculta):

• Rw (C; Ctr) = 29 dB (-1; -3)

Zonas de aplicação segundo RCCTE (em função do valor Ug): I1, I2, I3, V1, V2, V3.

SISTEMA ARi

Sistema practicable de canal europeo com RPT - 60 mm

CARACTERÍSTICAS DEL SISTEMA

Sistema practicable con rotura térmica y de elevado rendimiento térmico y acústico.

El sistema ARi posibilita la ejecución de 4 versiones de carpintería:

línea recta, línea curva, línea rústica, línea oval e hoja oculta.

El sistema ARi permite la aplicación de vidrios dobles u triplos de alto rendimiento por forma a responder a los requisitos de aislamiento térmico y acústico.

La versión ARi Hoja Oculta permite la ocultación de la hoja.

Con un excelente aislamiento térmico combinado con la aplicación de un producto innovador llamado ThermoProfile, el Sistema ARi ofrece beneficios de confort y ahorro energético.

PERFILES DE ALUMINIO

Los perfiles de aluminio son extrudidos en aleación de aluminio 6060 para arquitectura de acuerdo con la norma NP EN 12020-02. Perfiles con rotura térmica obtenida por inserción de varillas aislantes de poliamida de 24mm reforzadas con 25% de fibra de vidrio.

Espesor medio de los perfiles de aluminio de 1.5 mm para ventanas y de 1.7 mm para puertas.

MARCOS

Profundidad de los marcos de 60mm u 84.5mm con triple cámara;

Marcos con escuadras dobles para montaje a englete;

Marcos rústicos;

Marcos con enganche exterior y solape de 25mm u 45mm;

Marcos con enganche exterior e interior para aplicación de solape de 30 mm.

HOJAS

Profundidad de las hojas de 68mm con triple cámara;

Acrisolamiento para vidrio doble u triplo de 10 mm a 45 mm para lo sistema ARi;

Acrisolamiento para vidrio doble hasta 23 mm para lo sistema ARi Hoja Oculta;

Hojas de línea recta, curva, rústico u oval (sin junquillo);

Hojas con escuadras para montaje a englete;

Perfil inversor de línea recta.

DIMENSIONAMIENTO Y MANIOBRABILIDAD

Dimensiones mínimas - máximas de hoja: 400 mm - 1500 mm (L); 400 mm - 2700 mm (H);

Possibilidades de abertura: fijo, practicable interior 1 u 2 hojas con oscilobatiente, exterior, abatible, proyectante, pivotante, plegable y oscilo-paralela;

Estanquidad asegurada mientras juntas triples de EPDM;

Posibilidades de abertura con microventilación

ENSAYOS

Sistema certificado por laboratório credenciado, notificado para Ensayos Tipo Inicial (ITT) de acuerdo con la norma de producto EN 14351-1 para efectos de Marcado CE.

Categorias alcanzadas en los ensayos del sistema ARi tipologia ventana:

1. Permeabilidad al aire: Clase 4 (norma de ensayo EN 10207 y EN 1026)
2. Estanquidad al agua: Clase E750 (norma de ensayo EN 12208 y EN 1027)
3. Resistencia ao vento: Clase C5 (norma de ensayo EN 12208 y EN 12211)

Categorias alcanzadas en los ensayos del sistema ARi tipologia puerta:

1. Permeabilidad al aire: Clase 4 (norma de ensayo EN 10207 y EN 1026)
2. Estanquidad al agua: Clase 9A (norma de ensayo EN 12208 y EN 1027)
3. Resistencia al viento: Clase C3 (norma de ensayo EN 12208 y EN 12211)
4. Resistencia a la torsión estática: Apto 350N (norma de ensayo EN 14609)

Categorias alcanzadas en los ensayos del sistema ARi-Hoja Oculta tipologia ventana:

1. Permeabilidad al aire: Clase 3 (norma de ensayo EN 10207 y EN 1026)
2. Estanquidad al agua: Clase 7A (norma de ensayo EN 12208 y EN 1027)
3. Resistencia al viento: Clase C5 (norma de ensayo EN 12208 y EN 12211)

Coefficiente de transmisión térmica de hueco de 2 hojas, sistema ARi con 1.20 m x 1.50 m con vidrio Ug = 0.7 W/m²K, con intercalar efecto "Warm Edge":

• Uw = 1.54 W/m²K

Coefficiente de transmisión térmica de hueco de 2 hojas, sistema ARi Hoja Oculta con

1.80 m x 2.20 m con vidrio Ug = 1.1 W/m²K, con intercalar efecto "Warm Edge":

• Uw = 1.70 W/m²K

Coefficiente de atenuación acústica de hueco de 2 hojas con vidrio

4/16 (gás Árgon)/6 (sistema ARi):

• Rw (C; Ctr) = 38 dB (-2; -6)

Coefficiente de atenuación acústica de hueco de 2 hojas con vidrio 4/16 (gás Árgon)/6 (ARi - Folha Oculta):

• Rw (C; Ctr) = 29 dB (-1; -3)

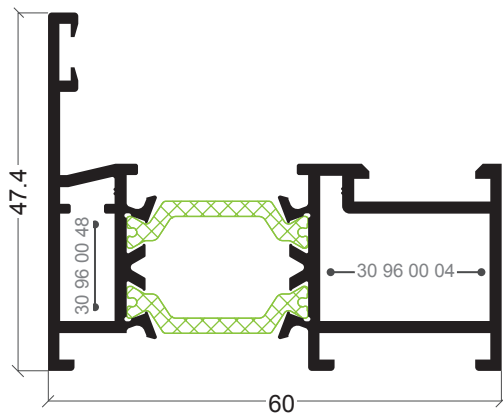

ARi-03

Aro fixo
Marco ventana

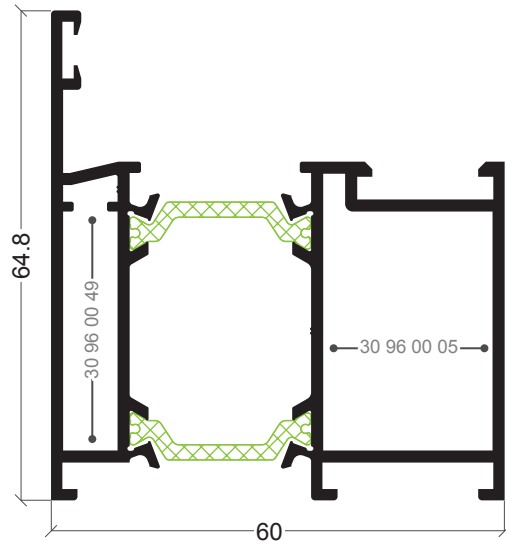

ARi-08

Aro fixo
Marco puerta

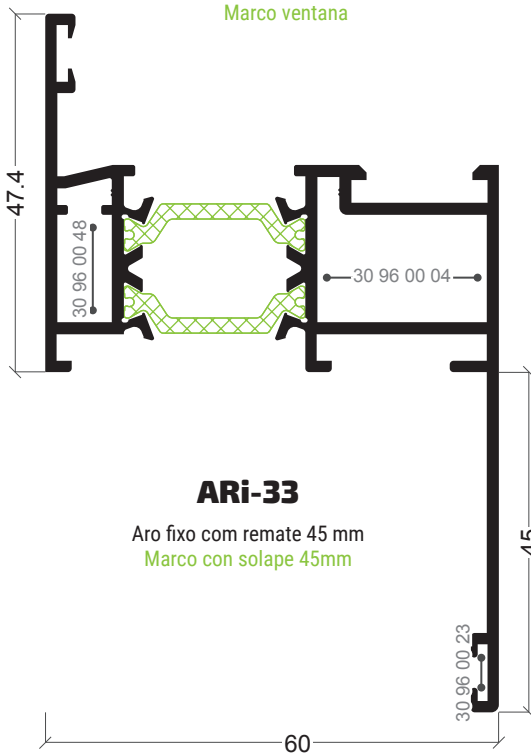

ARi-33

Aro fixo com remate 45 mm
Marco con solape 45mm

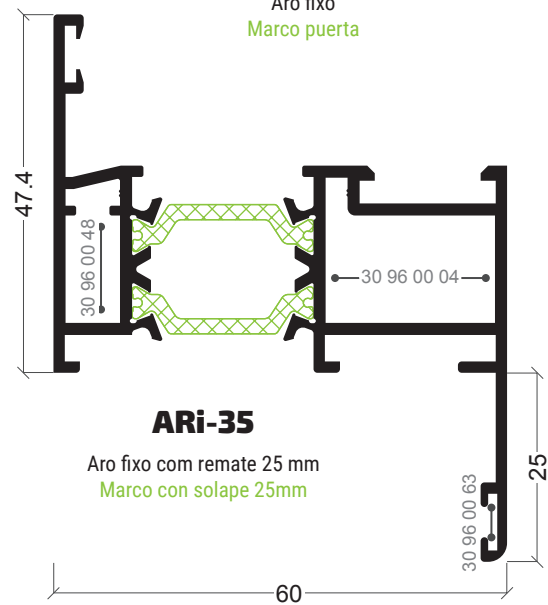

ARi-35

Aro fixo com remate 25 mm
Marco con solape 25mm

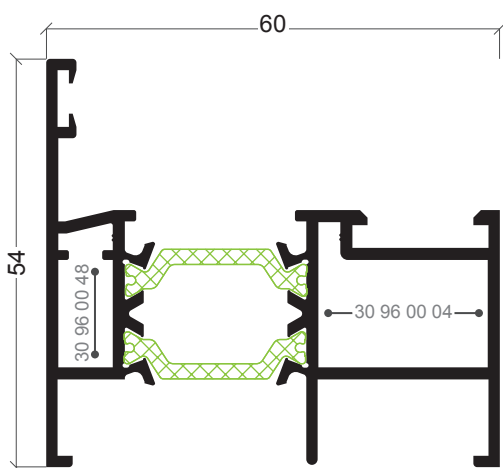

ARi-81

Aro fixo
Marco intermedio

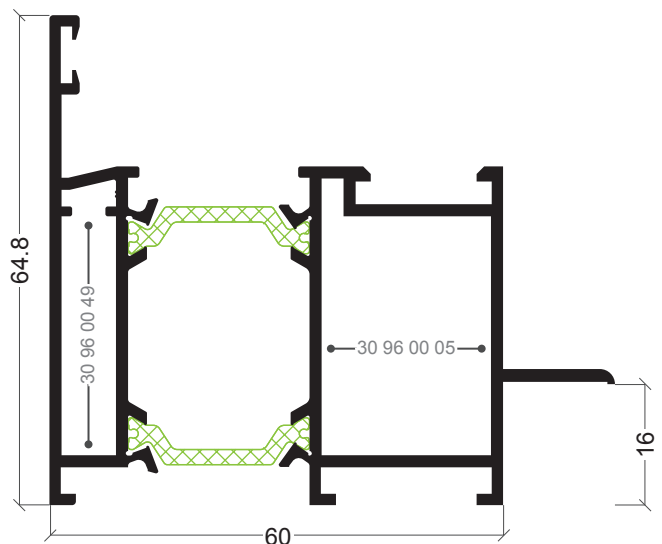

ARi-68

Aro fixo para apainelado
Marco puerta con precerco

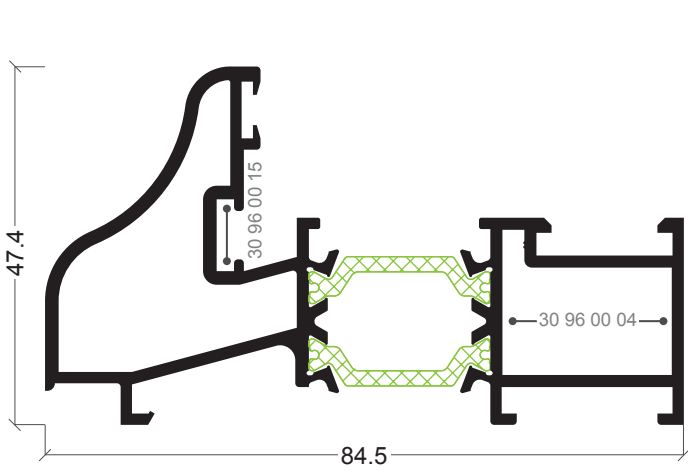

ARi-57

Aro fixo tradição
Marco ventana rústico

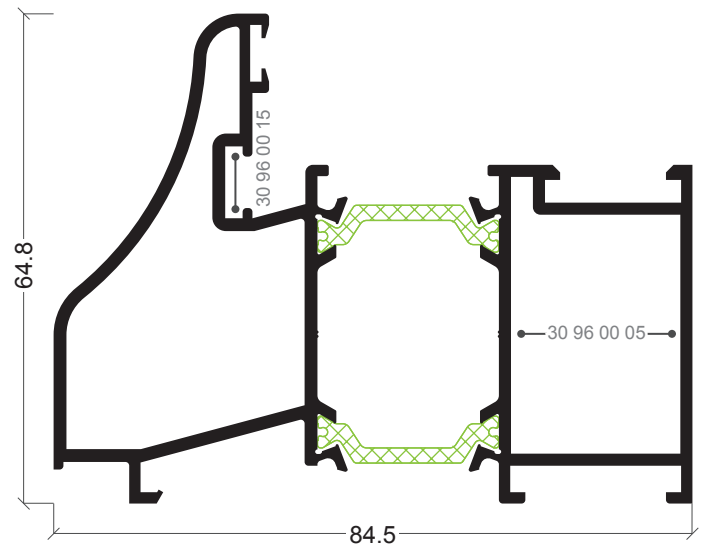

ARi-59

Aro fixo tradição
Marco puerta rústico

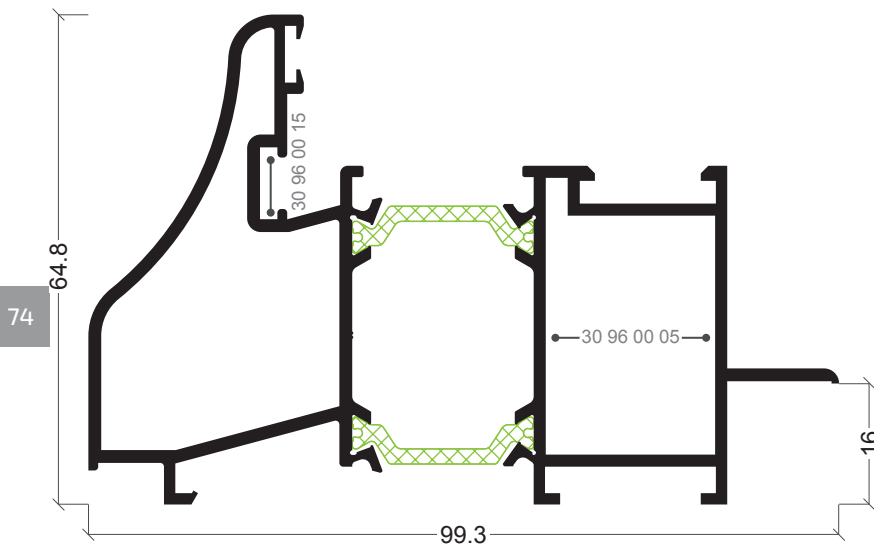

ARi-69

Aro fixo tradição para apanelado
Marco rústico con precerco

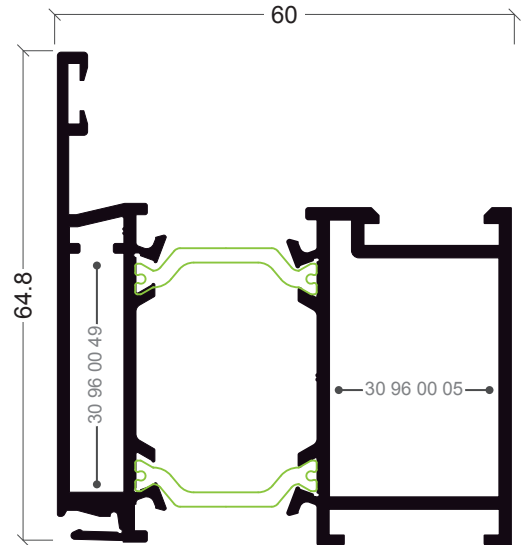

ARi-92

Aro fixo com clip exterior
Marco puerta con enganche exterior

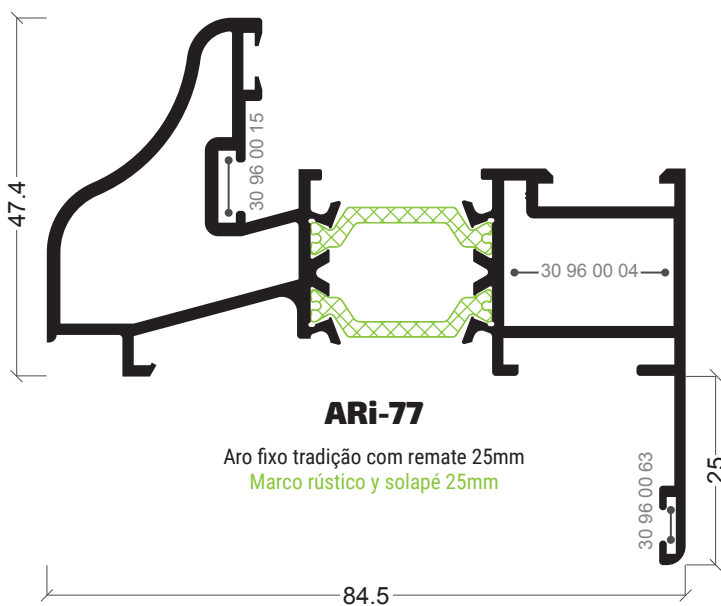

ARi-77

Aro fixo tradição com remate 25mm
Marco rústico y solapé 25mm

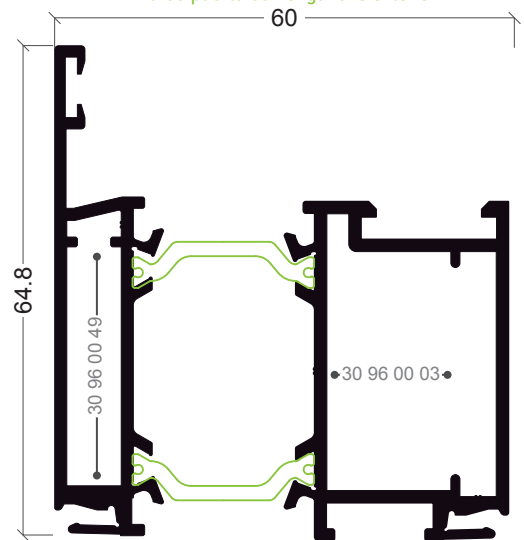

ARi-94

Aro fixo com clip interior e exterior
Marco puerta con enganche interior y exterior

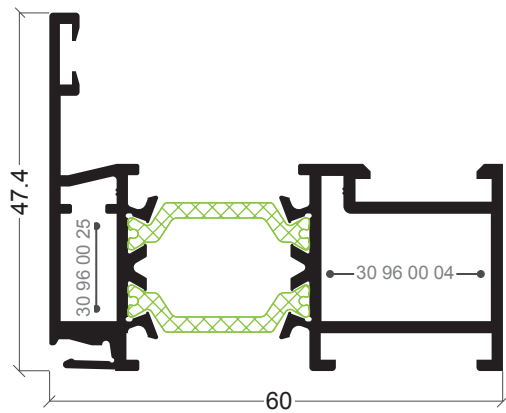

ARi-76

Aro fixo
Marco com enganche exterior

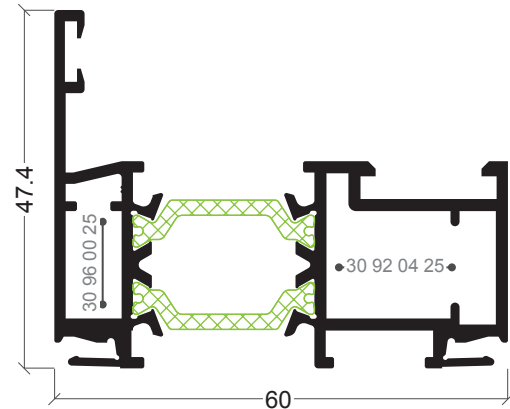

ARi-80

Aro fixo
Marco com enganche int./ext.

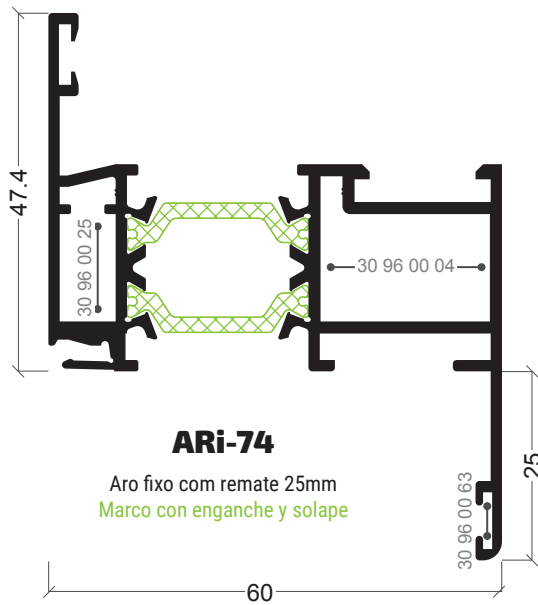

ARi-74

Aro fixo com remate 25mm
Marco com enganche y solape

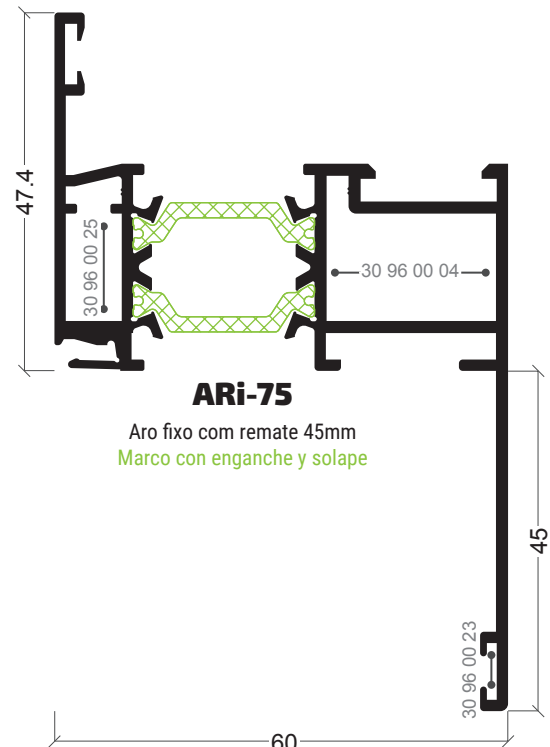

ARi-75

Aro fixo com remate 45mm
Marco com enganche y solape

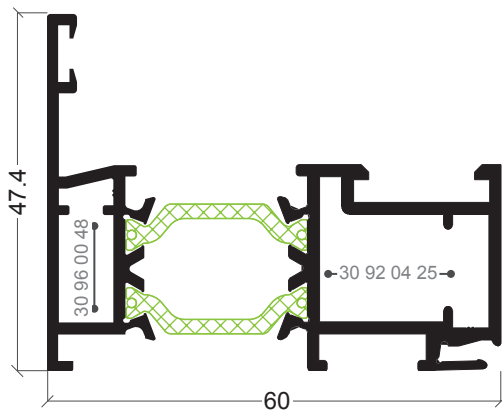

ARi-91

Aro fixo
Marco com enganche interior

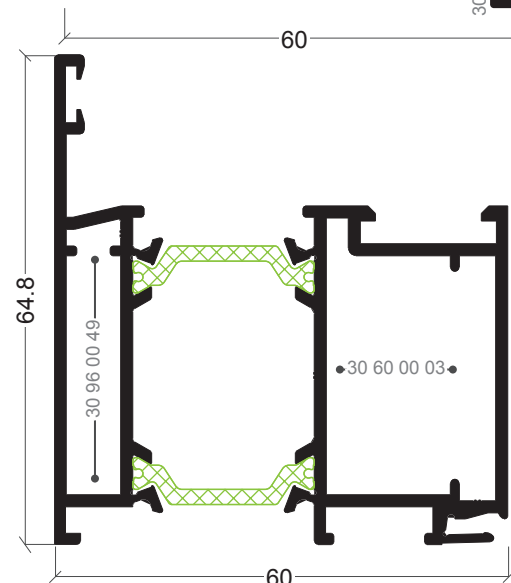

ARi-93

Aro fixo
Marco com enganche interior

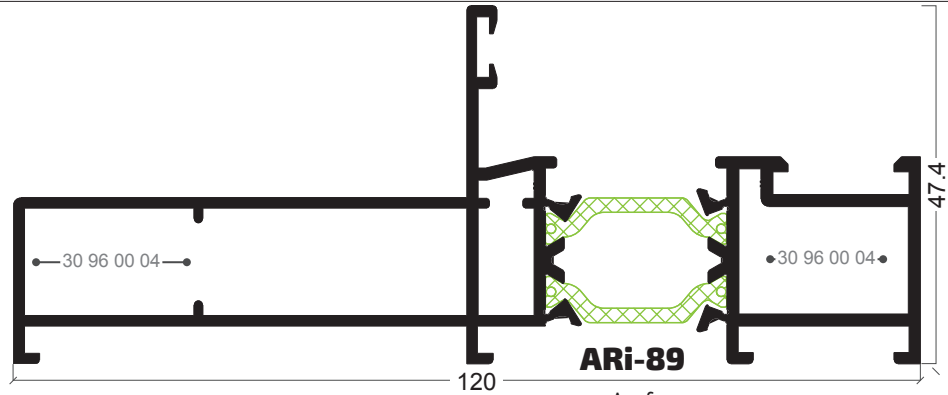

ARi-89
Aro fijo
Marco ventana

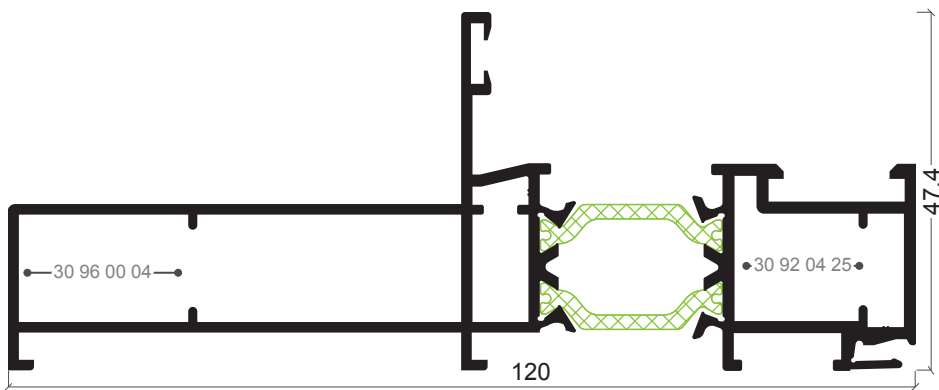

ARi-88
Aro fijo
Marco con enganche interior

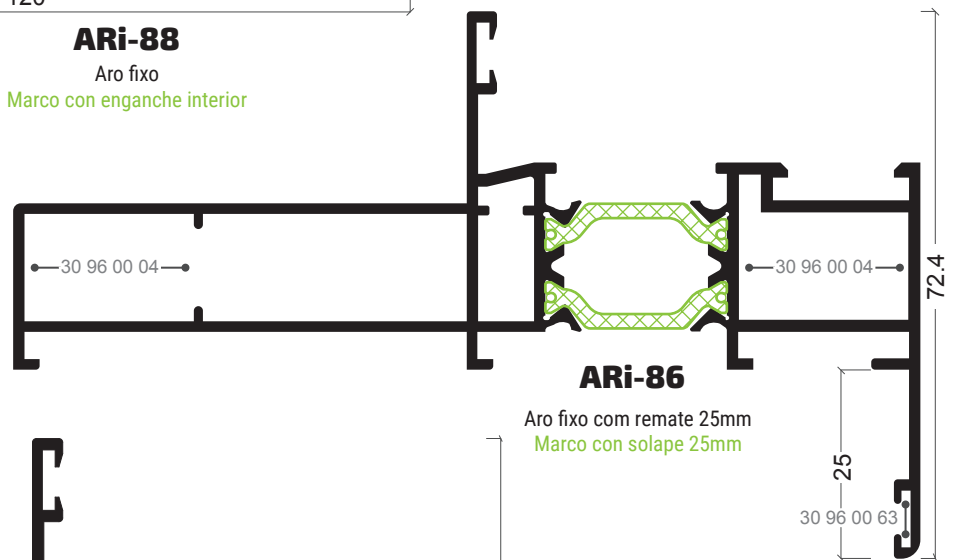

ARi-86
Aro fijo con remate 25mm
Marco con solape 25mm

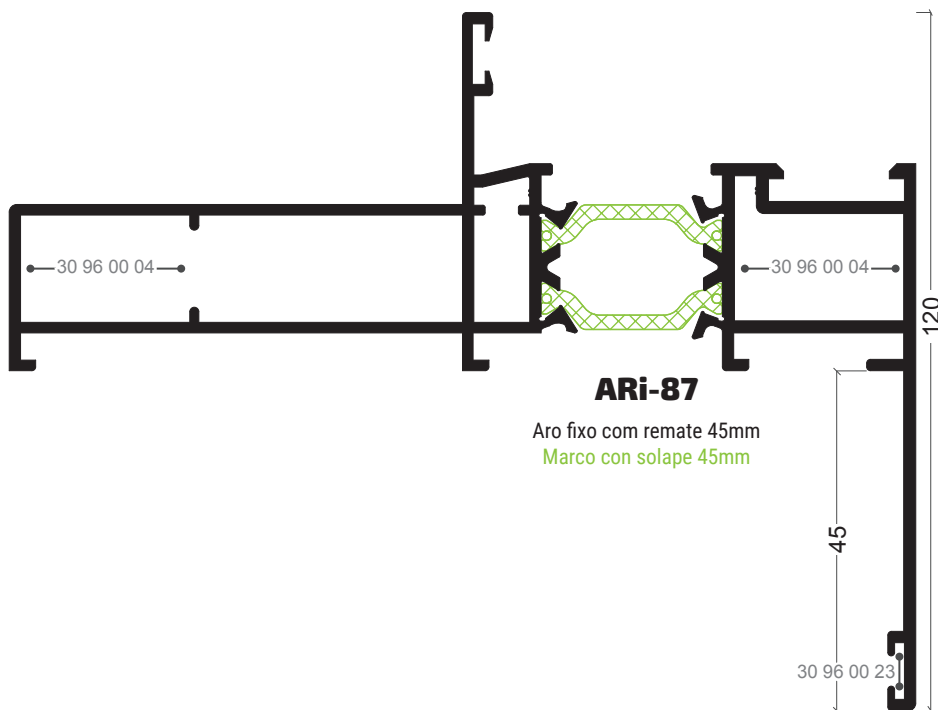

ARi-87
Aro fijo con remate 45mm
Marco con solape 45mm

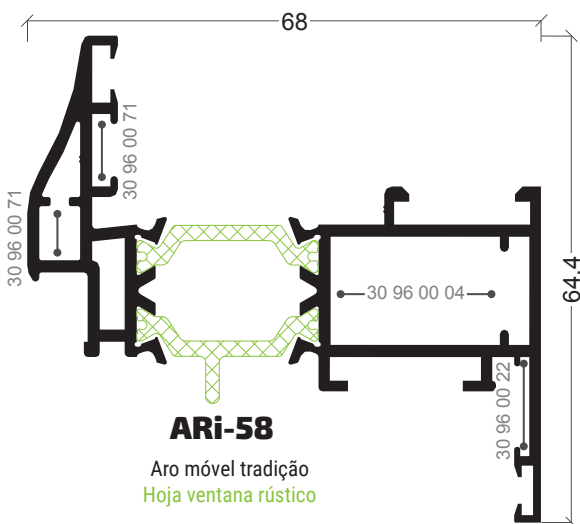
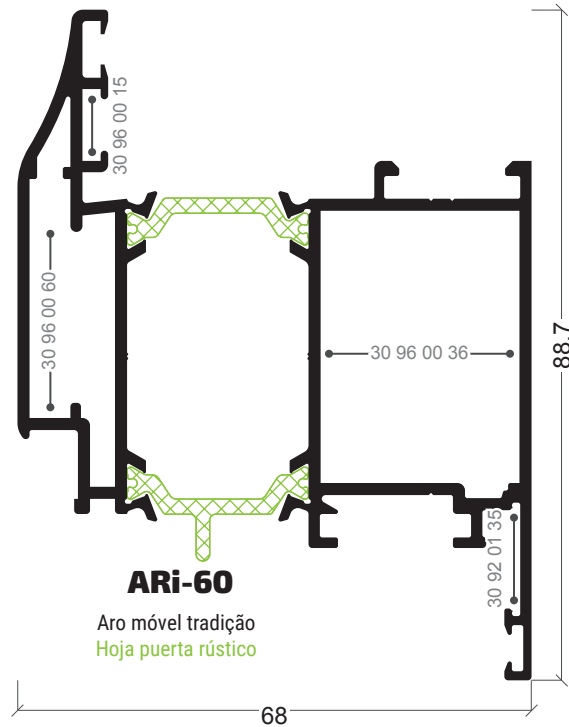
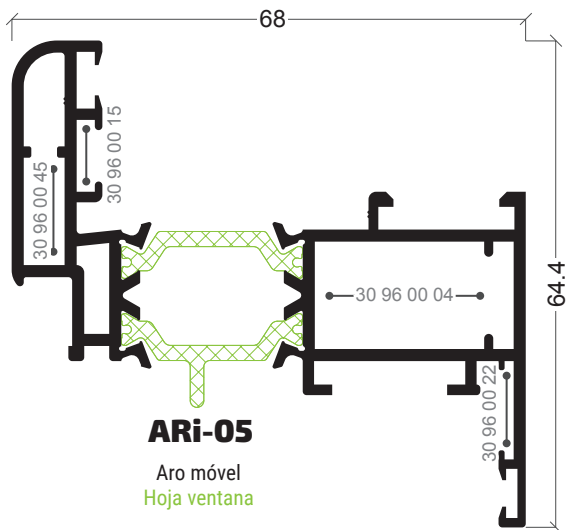
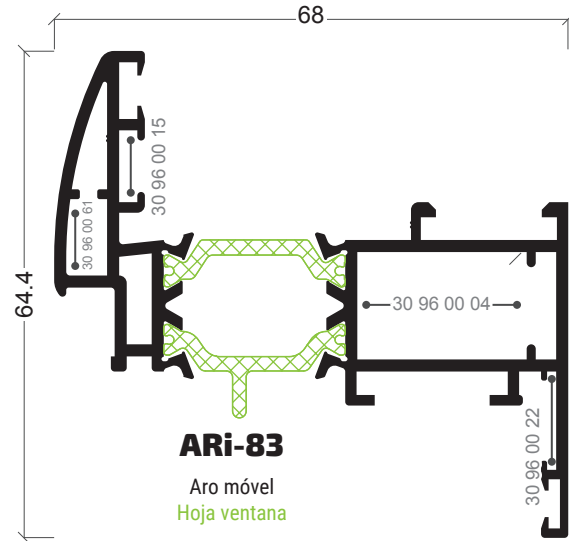
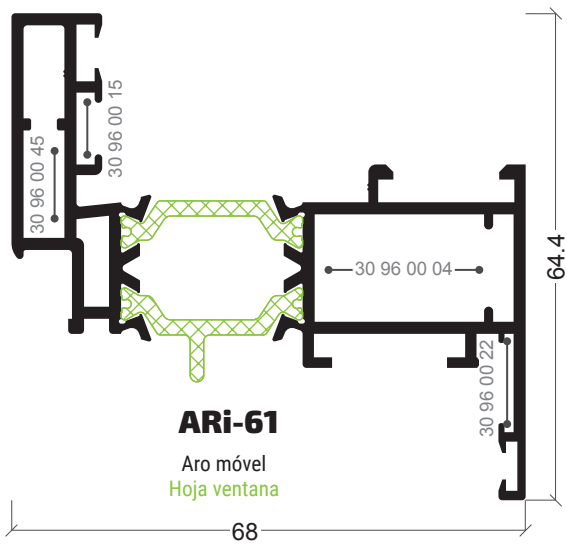

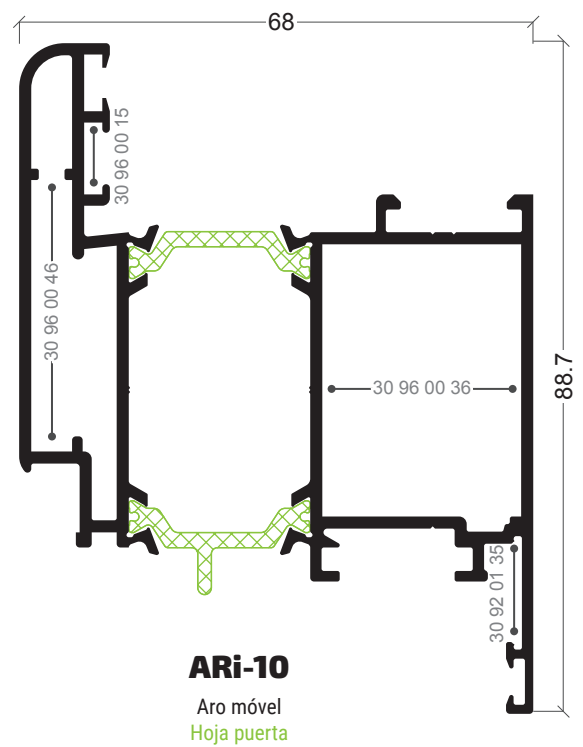
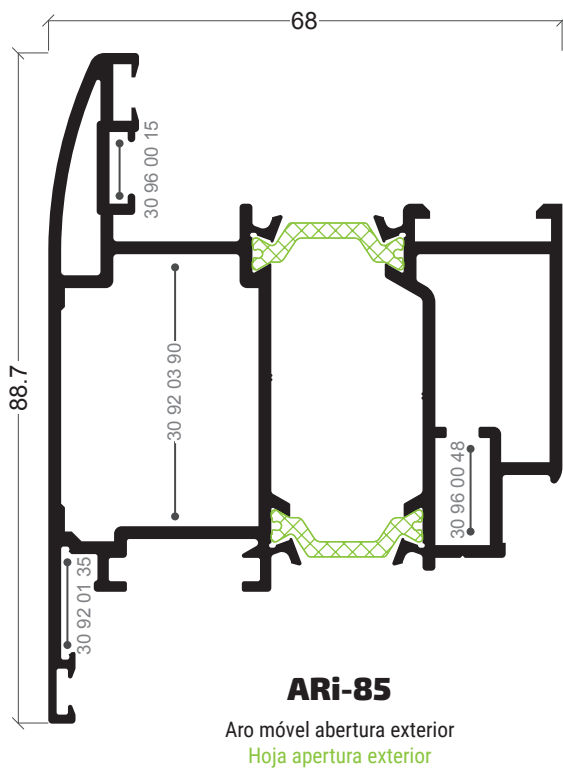
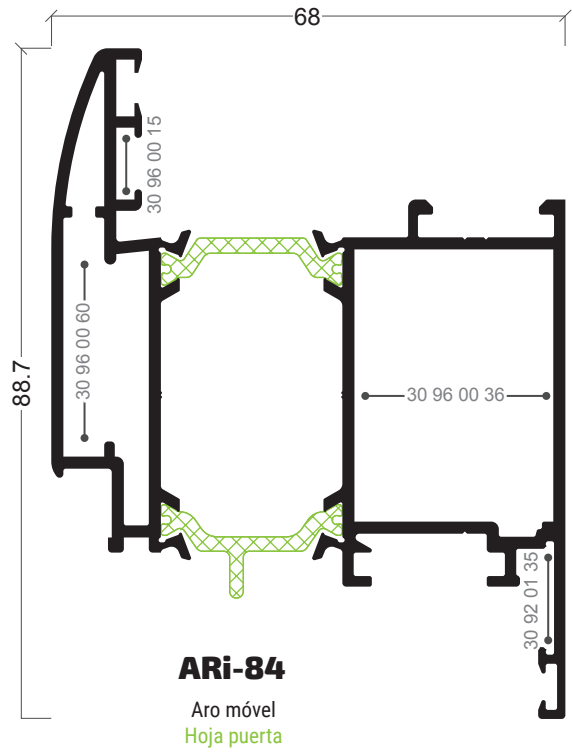
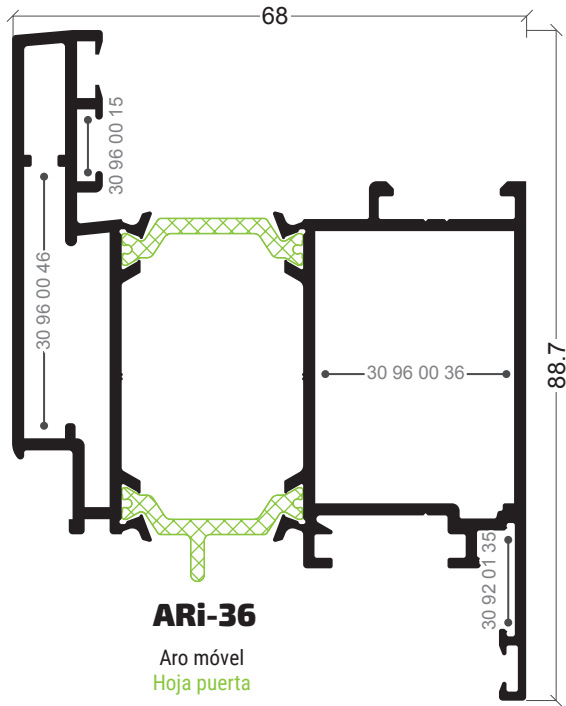

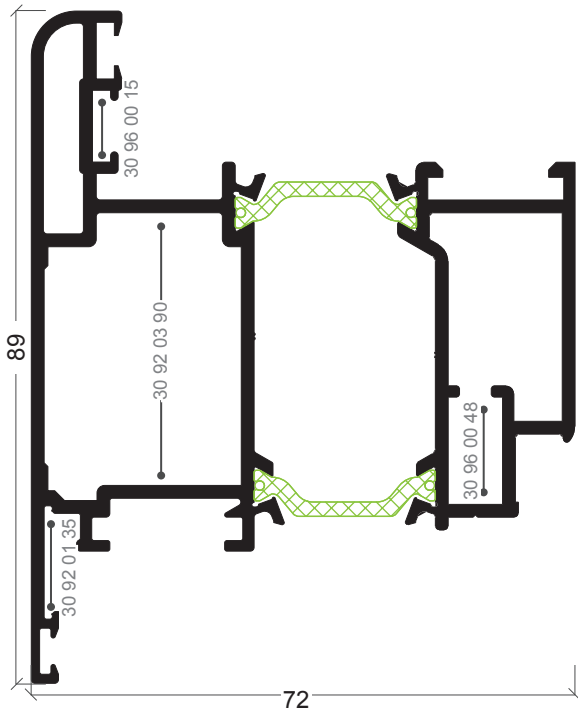

ARi-90

Aro móvel abertura exterior
Hoja abertura exterior

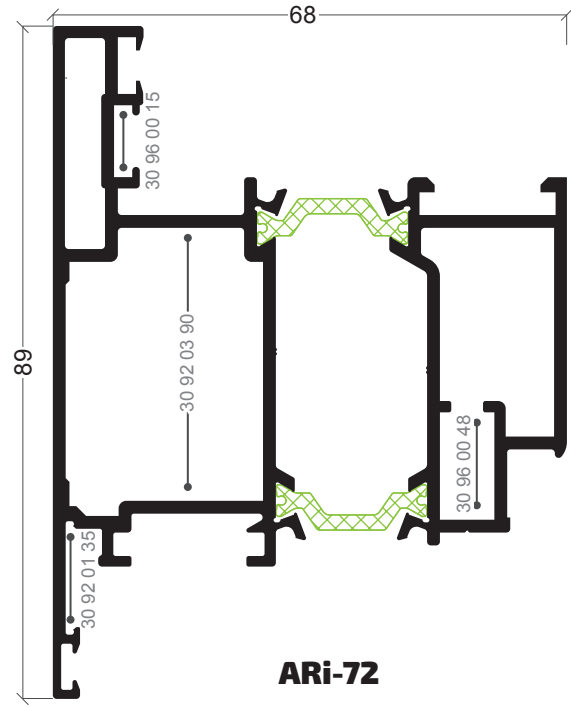

ARi-72

Aro móvel abertura exterior
Hoja abertura exterior

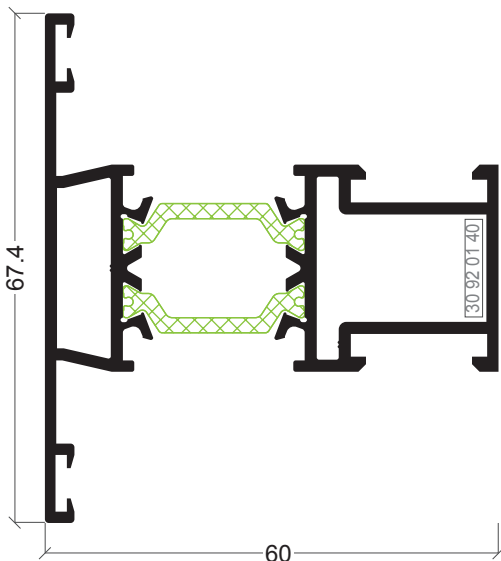

ARi-01

Travessa
Travesaño ventana

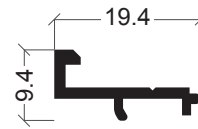

ARi-29

Apoio bite ARi-07/ARi-95
Apoyo ARi-07 ARi-95



AXi-32

Complemento abertura projectante
Complemento abertura proyectante

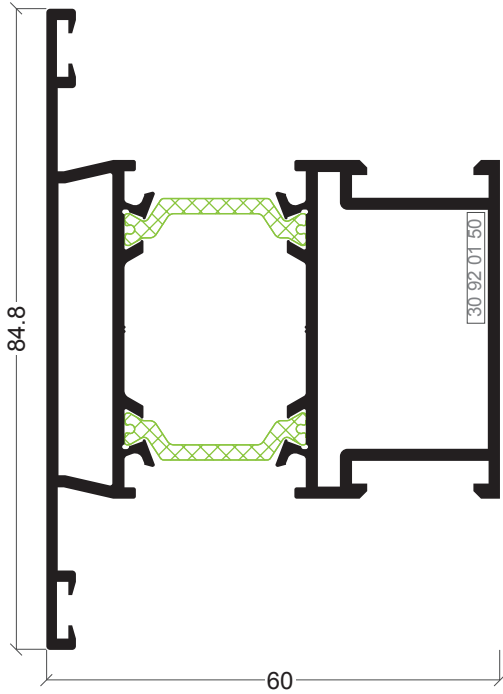

ARi-06
Travessa
Travesaño puerta

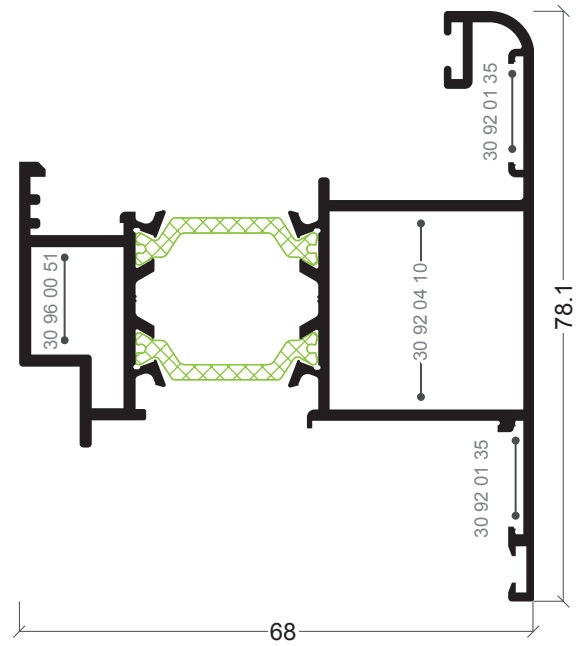

ARi-07
Aro móvil proyectante
Hoja proyectante

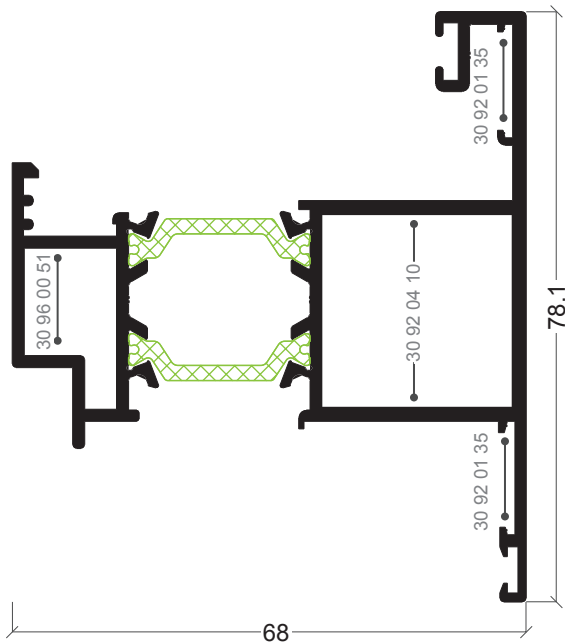

ARi-95
Aro móvil proyectante
Hoja proyectante

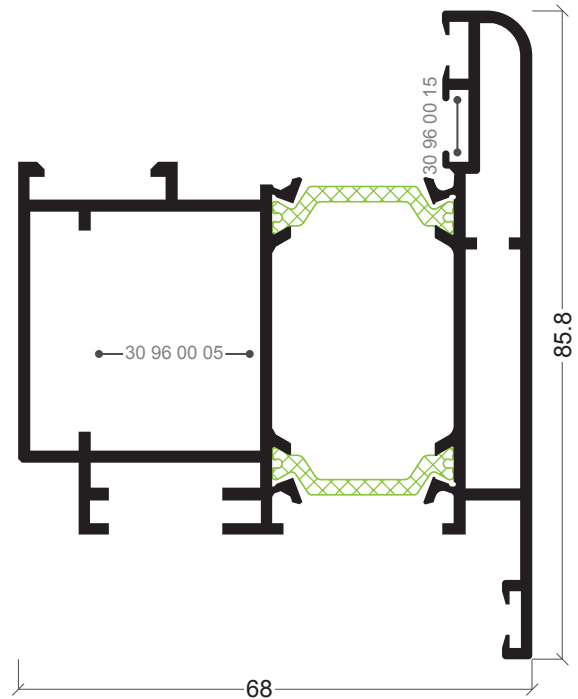

ARi-25
Aro móvil pivotante
Hoja apertura pivotante

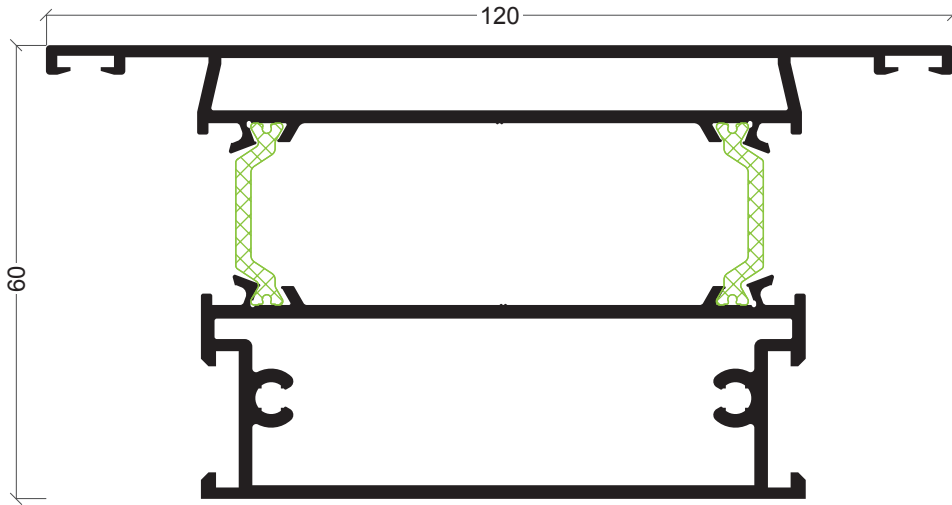

ARi-12

Travessa 120x60mm
Zócalo 120x60mm

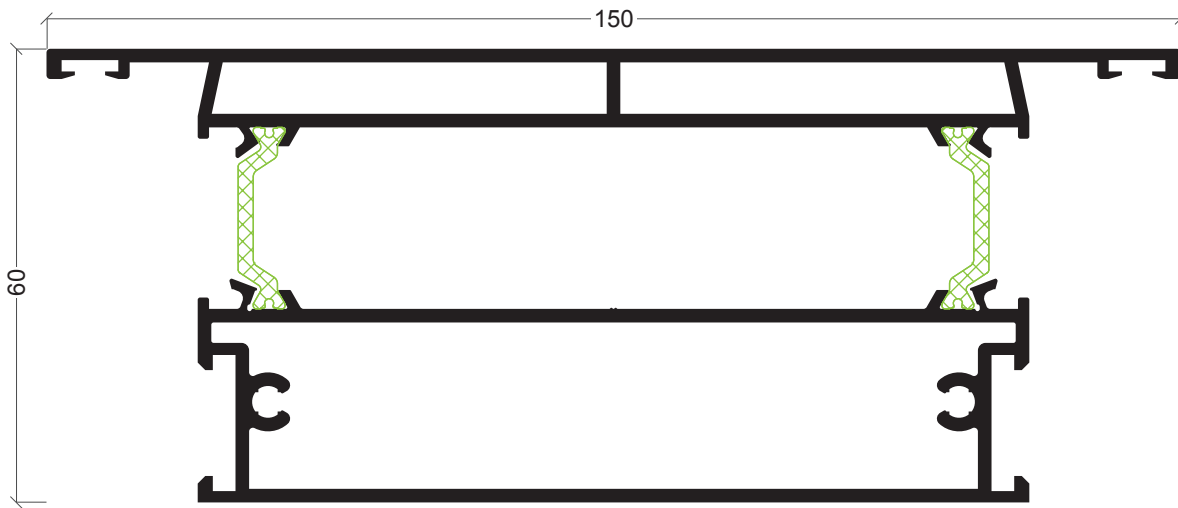

ARi-13

Travessa
Zócalo 150x60mm

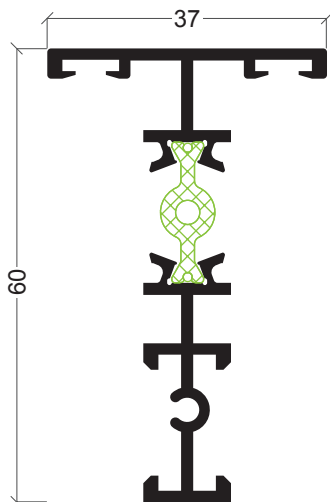

ARi-40

Divisor de vidro
Divisoria de vidro

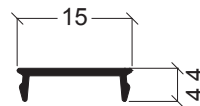

KL-04

Tampa
Tapa



CT-94

Perfil de união
Perfil de unión



AX-19

Vareta
Pletina falleba



AX-33

Mola Bite
Grapa junquillo

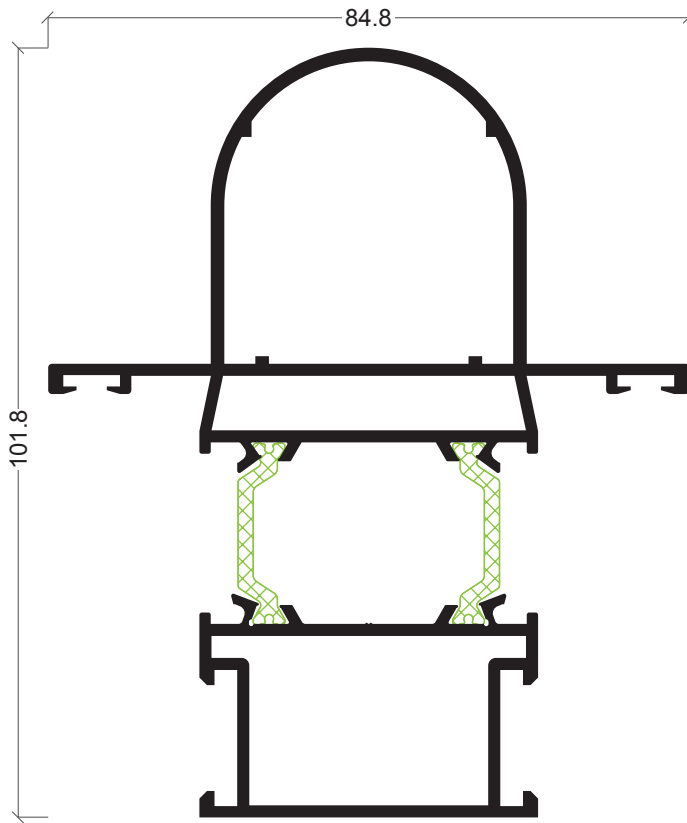

ARi-17

Montante curvo
Rigidizador 102mm curvo

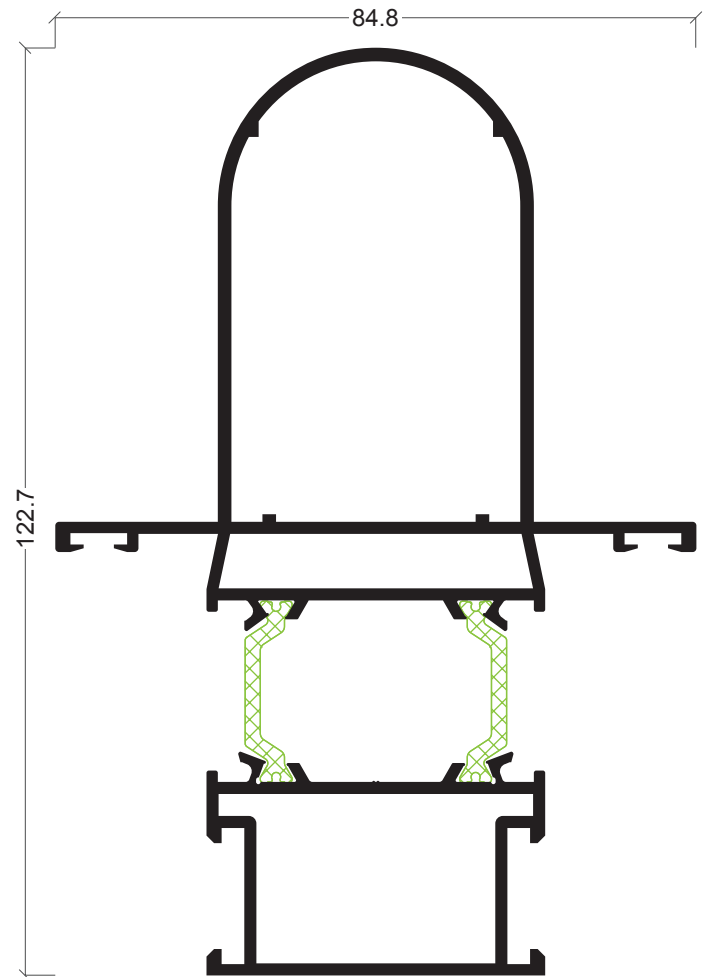

ARi-18

Montante curvo
Rigidizador 123mm curvo

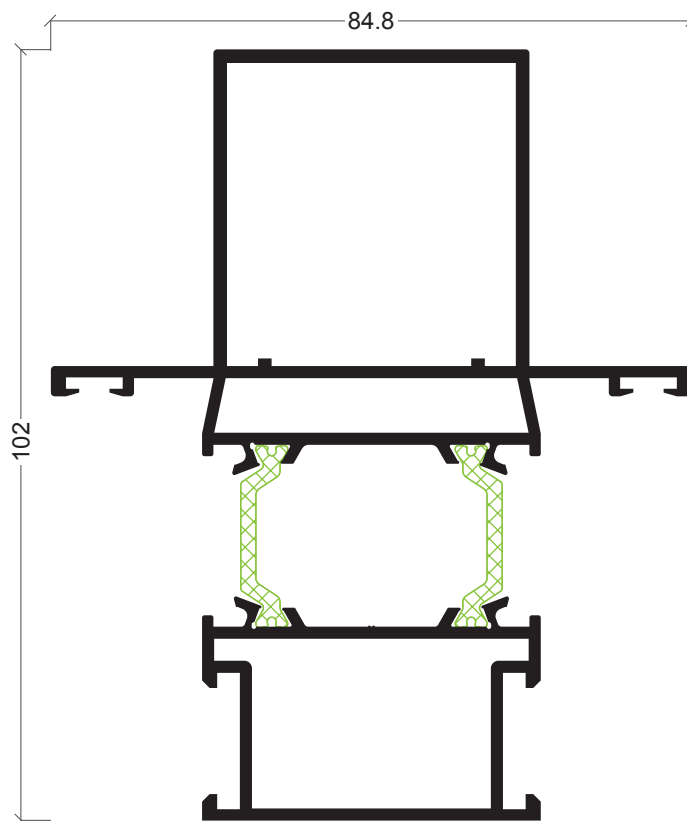

ARi-79

Montante recto
Rigidizador 102mm recto

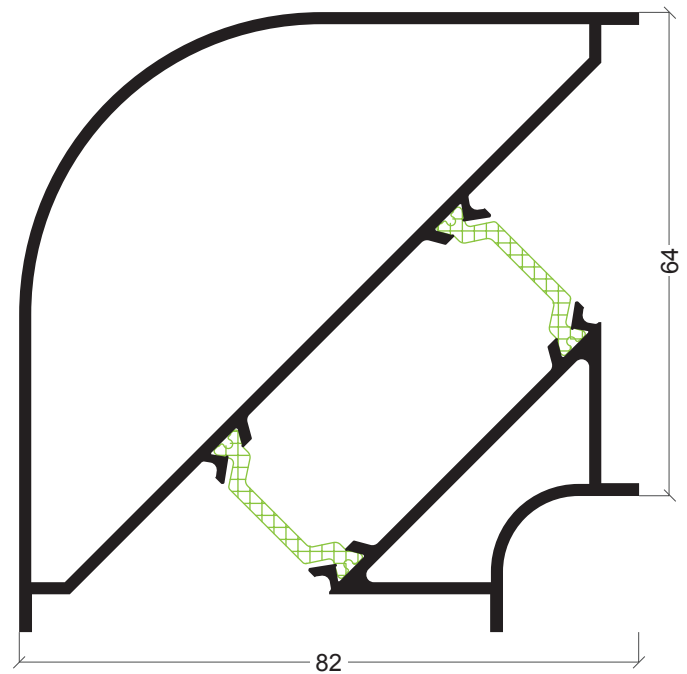

ARi-16

Esquina 90°
Esquinero 90° curvo

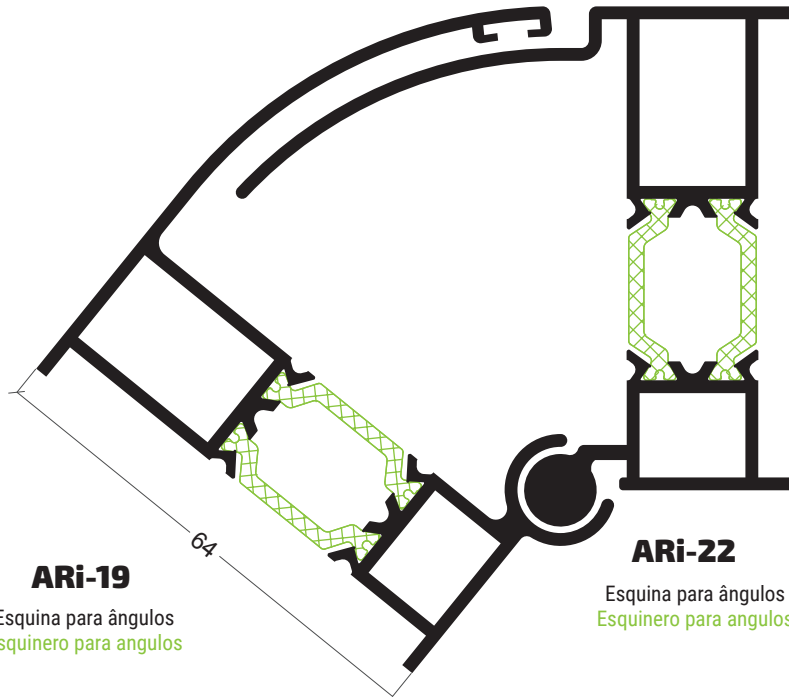

ARi-19

Esquina para ângulos
Esquinero para angulos

ARi-22

Esquina para ângulos
Esquinero para angulos

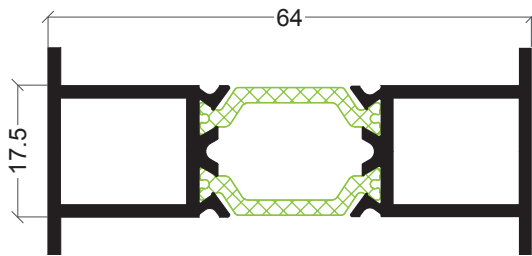

ARi-21

União de aros
Unión de marcos

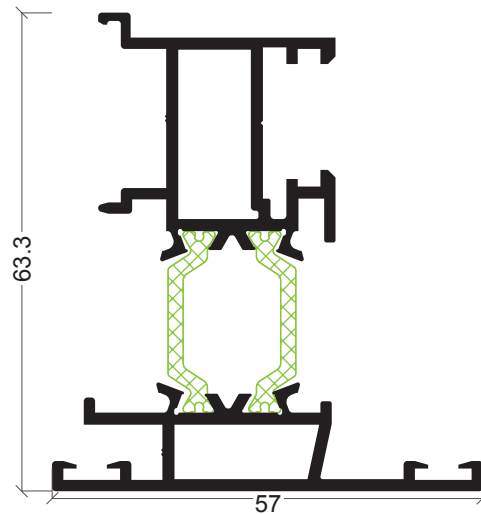

ARi-04

Inversor
Inversor

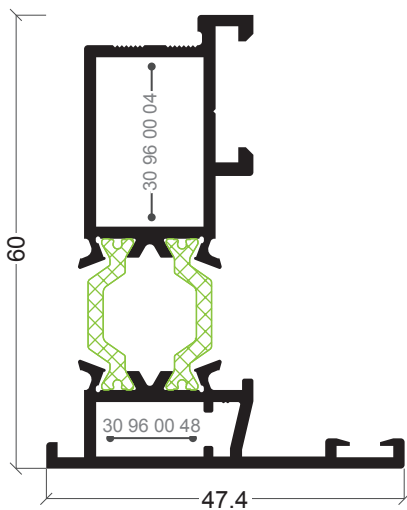

ARi-73

Inversor de sentido de abertura
Inversor de sentido de abertura

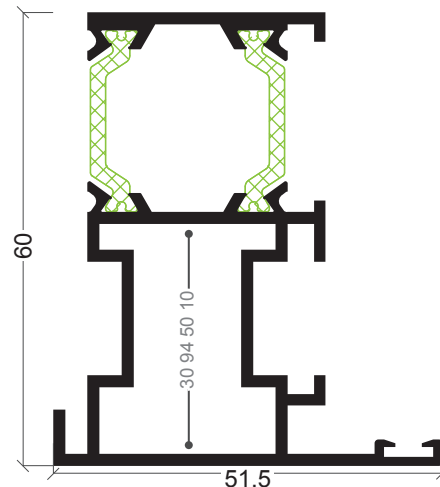

ARi-14

Inversor pivotante
Inversor pivotante

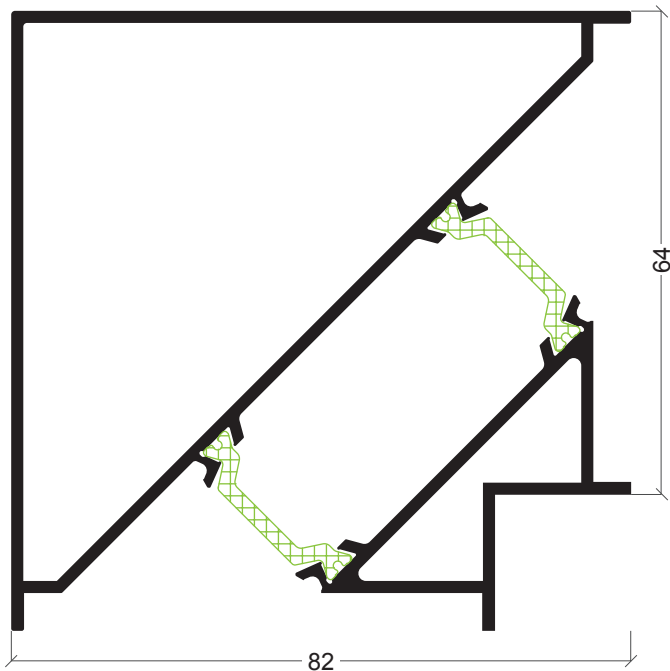

ARi-64
Esquina 90°
Esquinero 90° recto

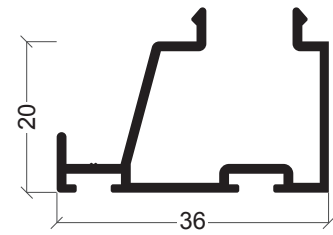

AX-15
Bite remate
Junquillo acople

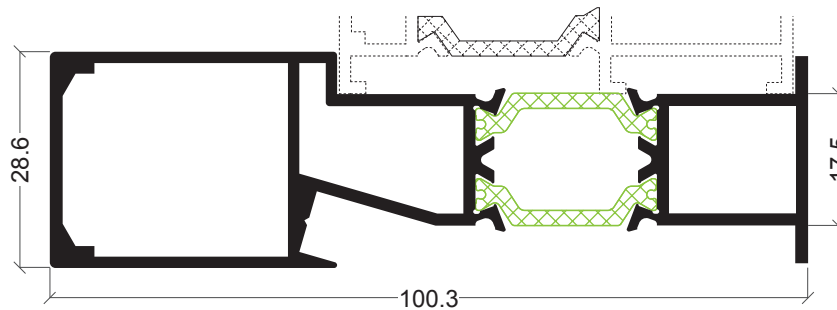

ARi-65
União de aros com reforço
Unión de marcos con refuerzo

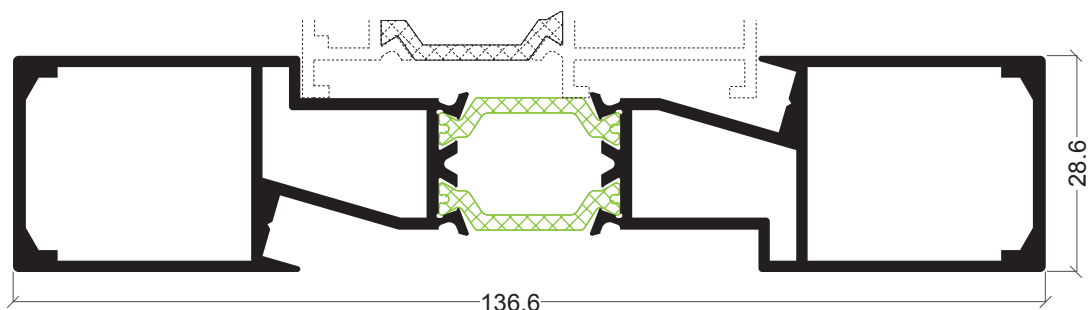

ARi-67
União de aros com reforço
Unión de marcos con doble refuerzo

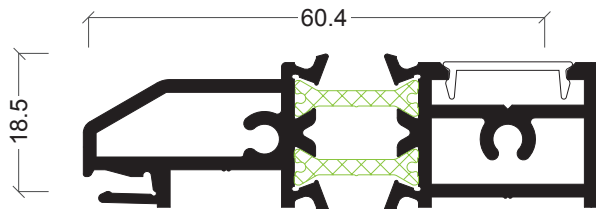

ARi-96

Soleira
Acople inferior

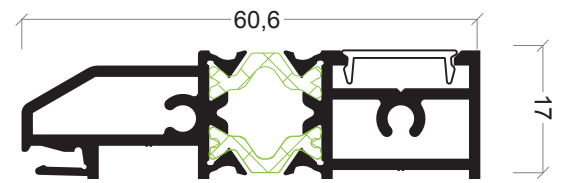

ARi-99

Soleira
Acople inferior

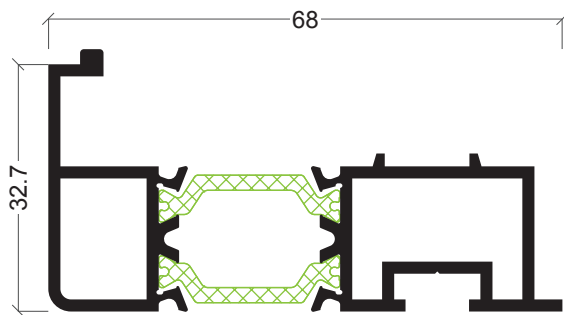

ARi-23

Remate almofada
Acople de hoja p/ zócalo inferior

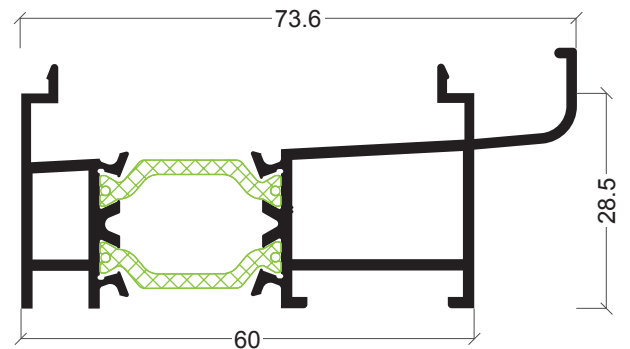

CT-11

Soleira condensação
Condensación

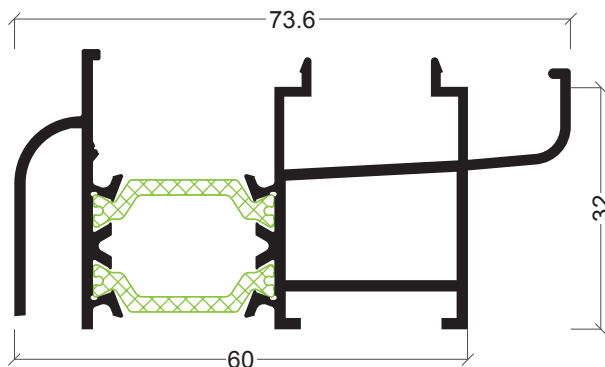

ARi-49

Soleira condensação
Condensación

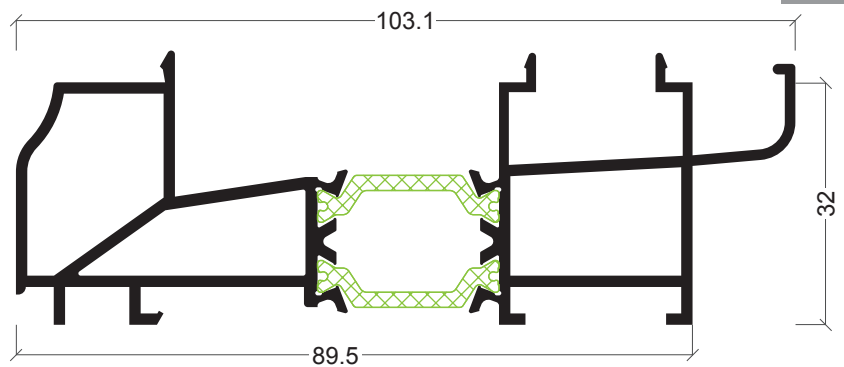

ARi-56

Soleira condensação tradição
Condensación rústico

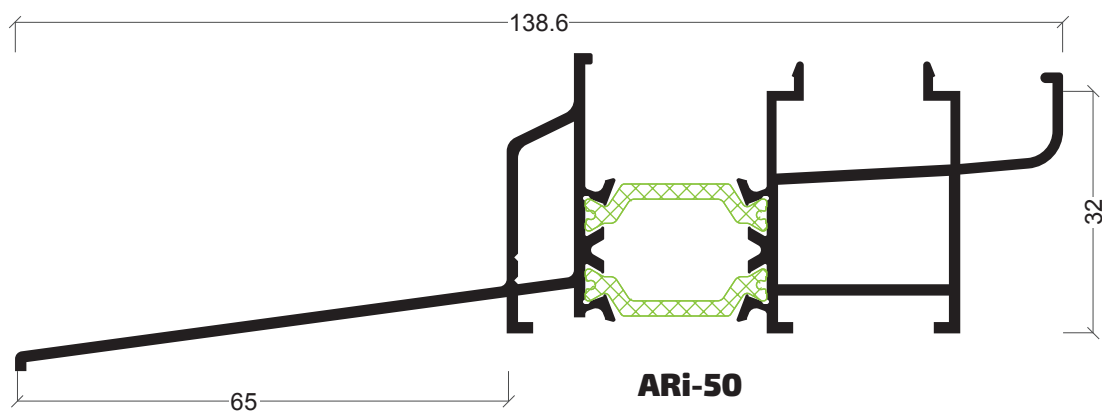

ARi-50

Soleira condensação com pingadeira
Condensación con alargadera

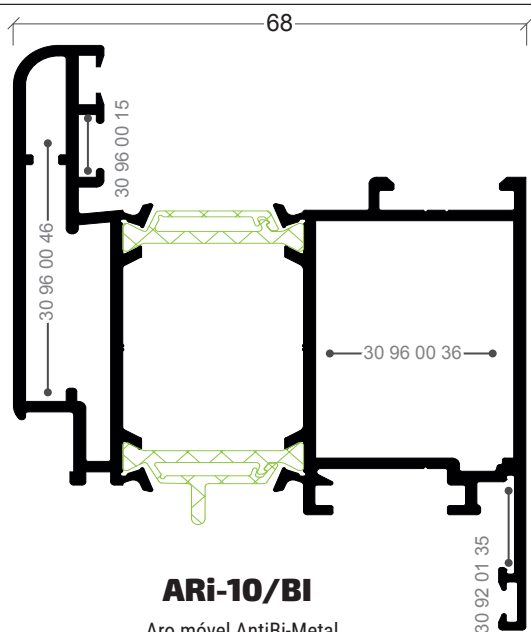

ARi-10/BI
Aro móvil AntiBi-Metal
Hoja AntiBi-Metal

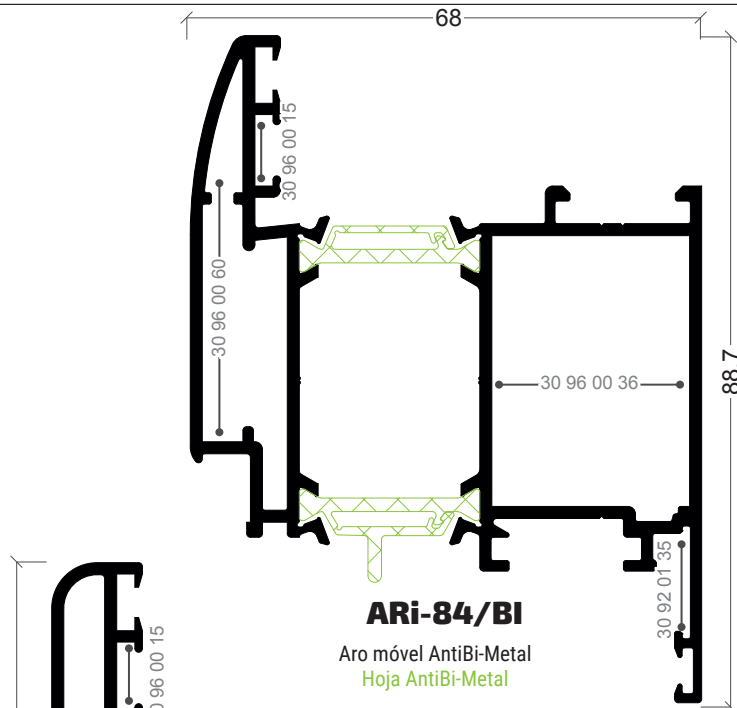

ARi-84/BI
Aro móvil AntiBi-Metal
Hoja AntiBi-Metal

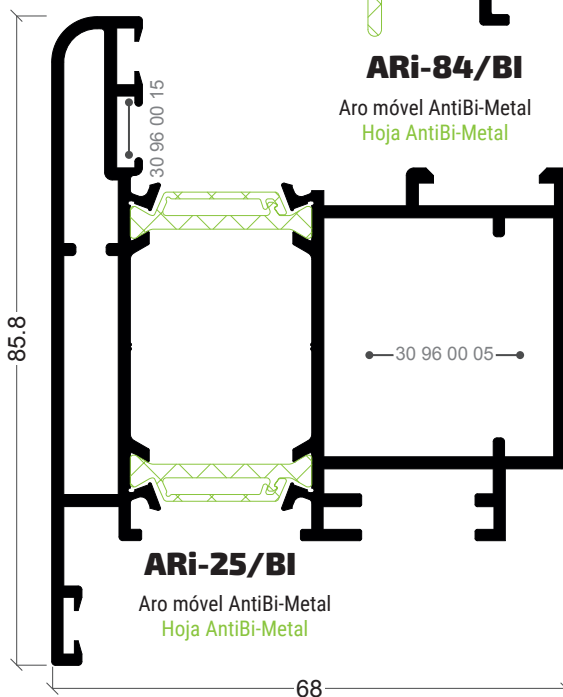

ARi-25/BI
Aro móvil AntiBi-Metal
Hoja AntiBi-Metal

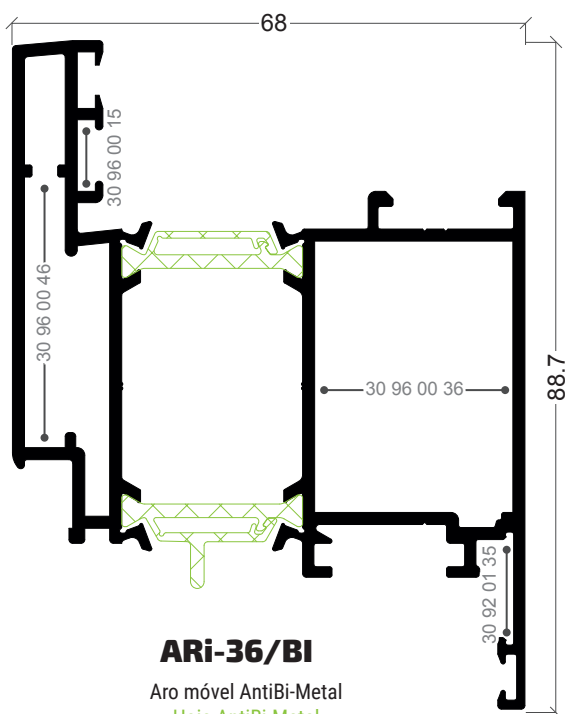

ARi-36/BI
Aro móvil AntiBi-Metal
Hoja AntiBi-Metal

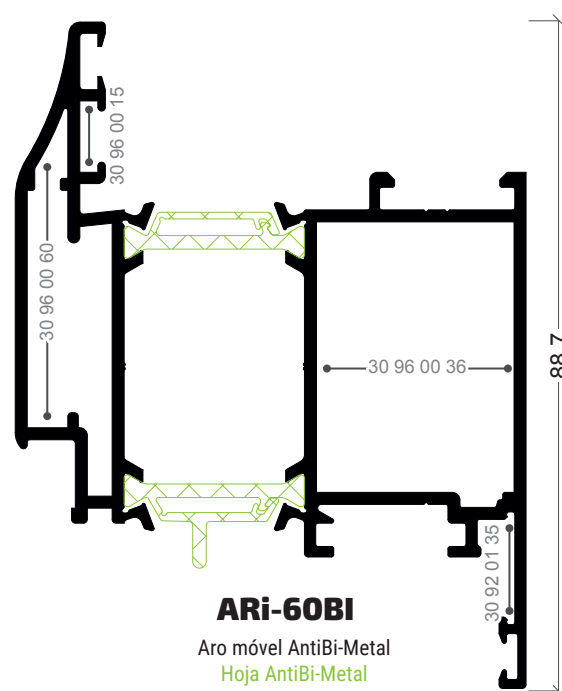

ARi-60BI
Aro móvil AntiBi-Metal
Hoja AntiBi-Metal

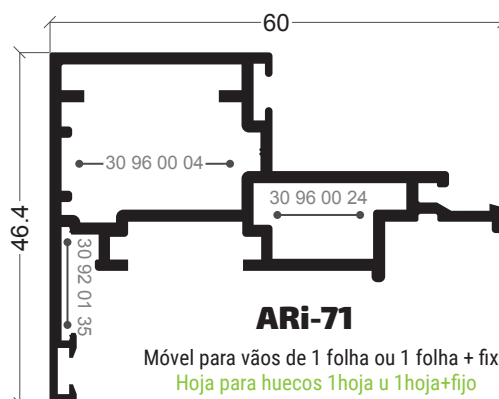
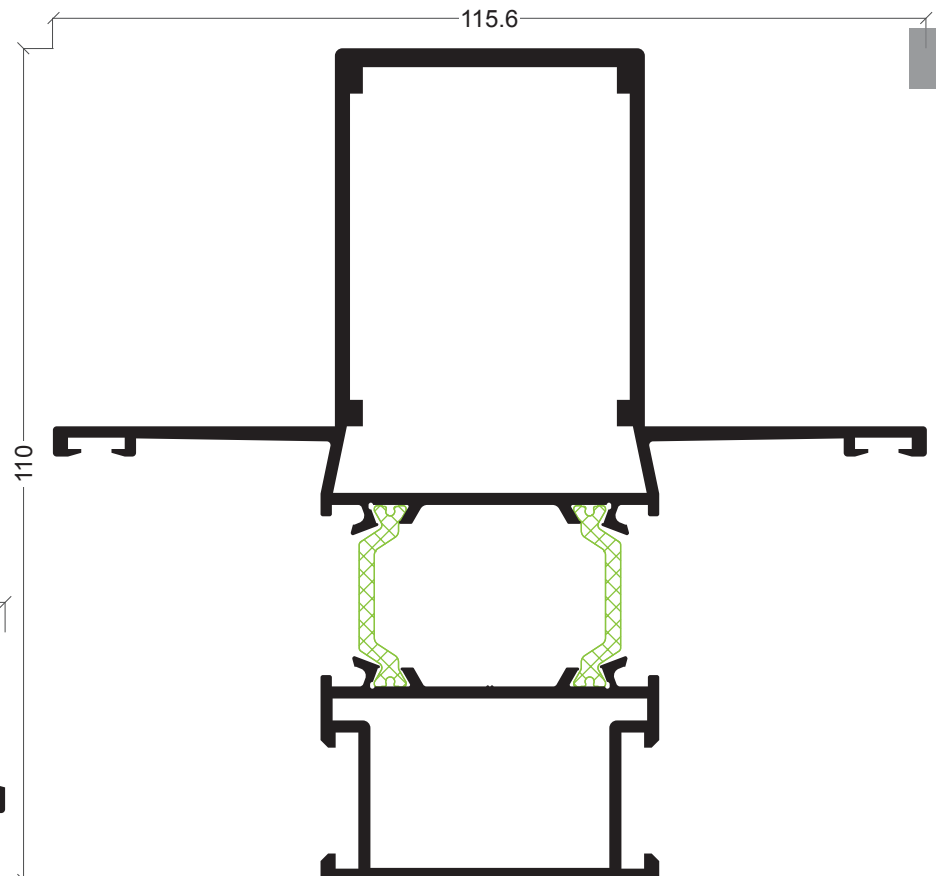
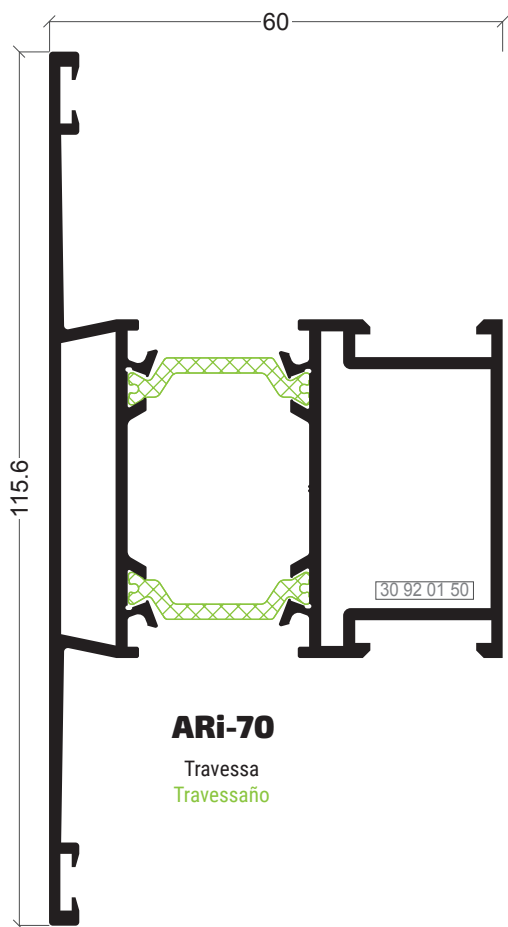
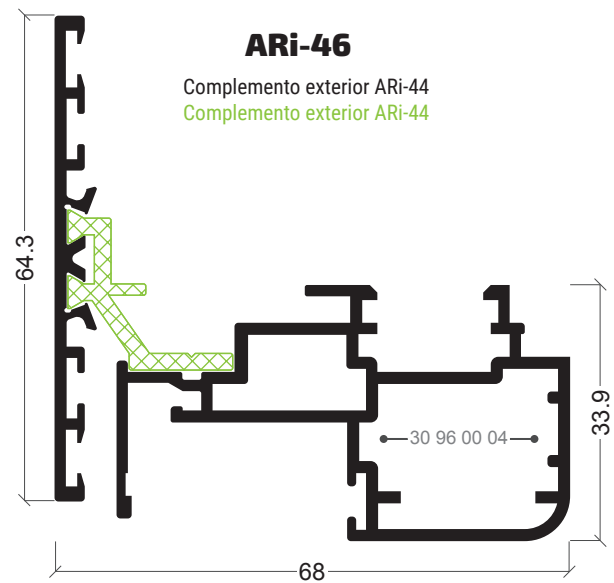
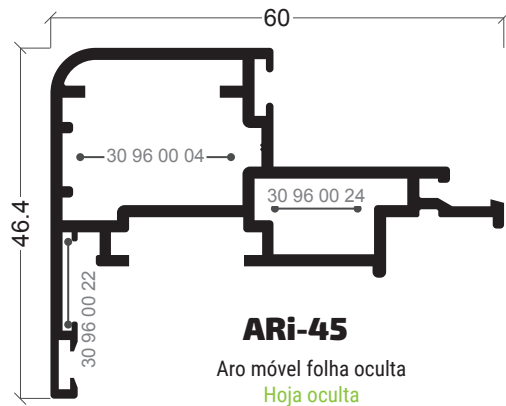

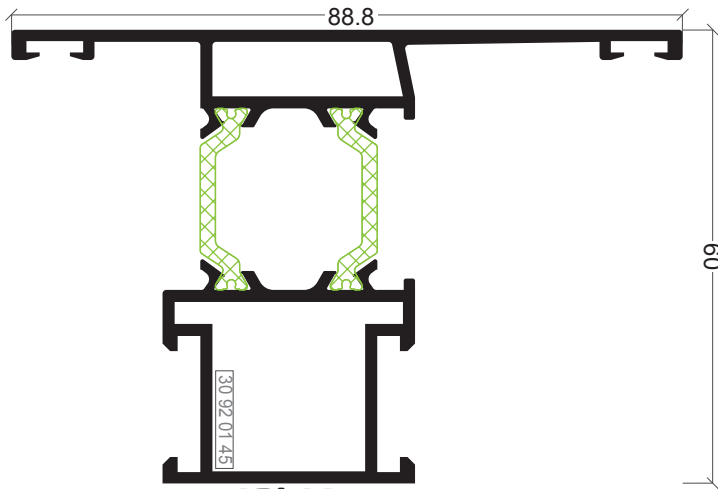

ARi-41

Travessa folha oculta
Travessaño hoja oculta

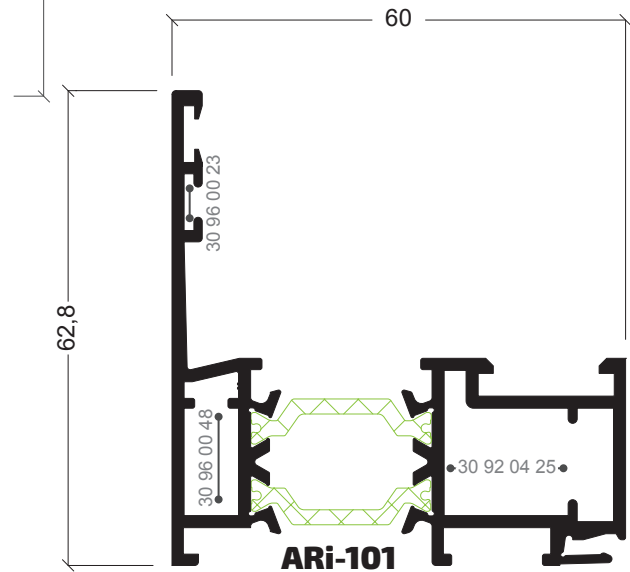

ARi-101

Aro fixo folha oculta
Marco hoja oculta

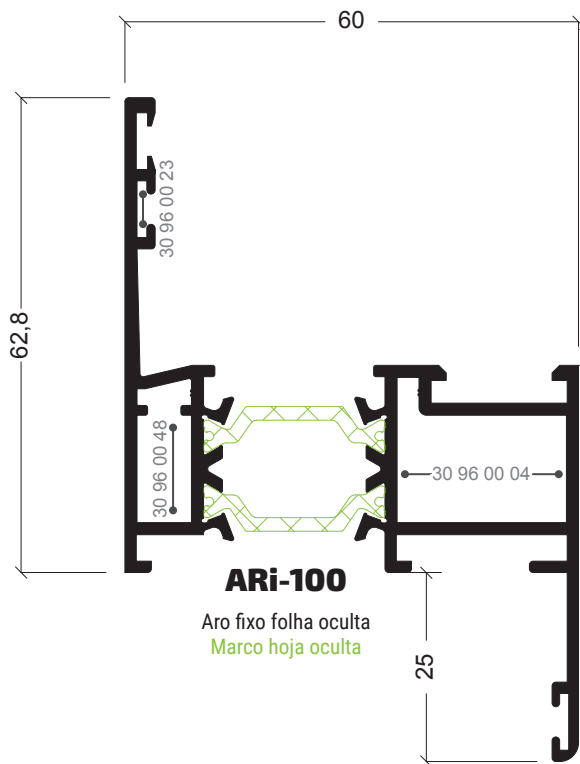

ARi-100

Aro fixo folha oculta
Marco hoja oculta

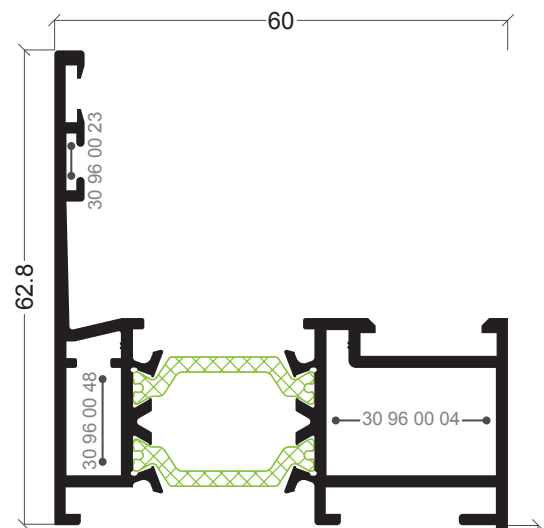

ARi-42

Aro fixo com remate folha oculta
Marco con solape 45mm hoja oculta

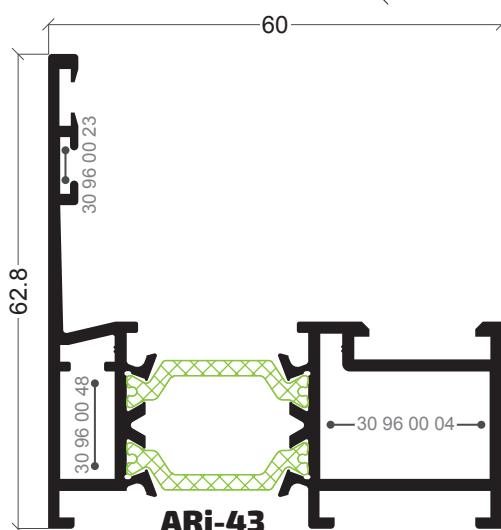

ARi-43

Aro fixo folha oculta
Marco hoja oculta



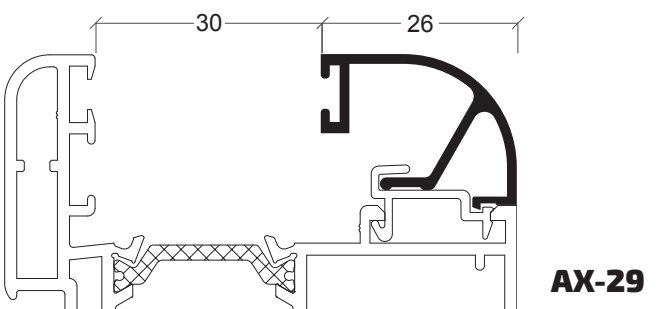
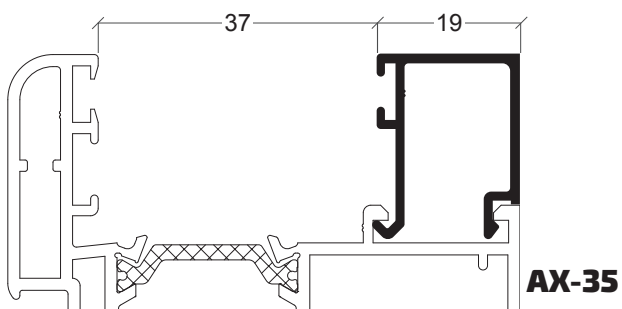
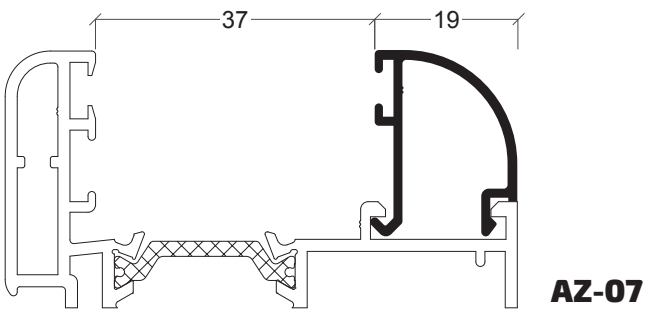
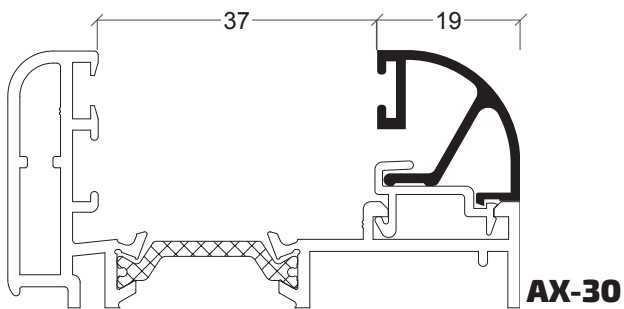
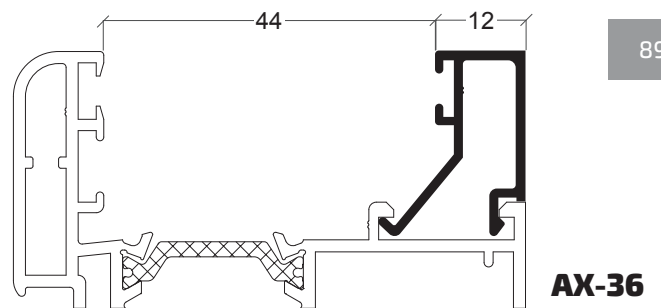
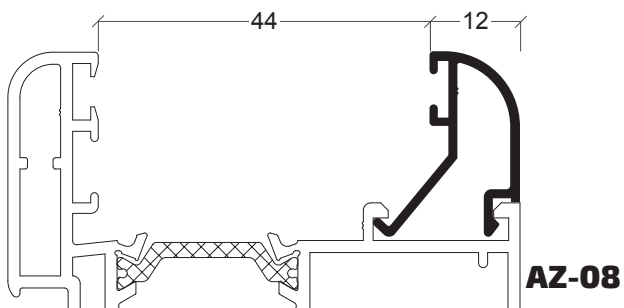
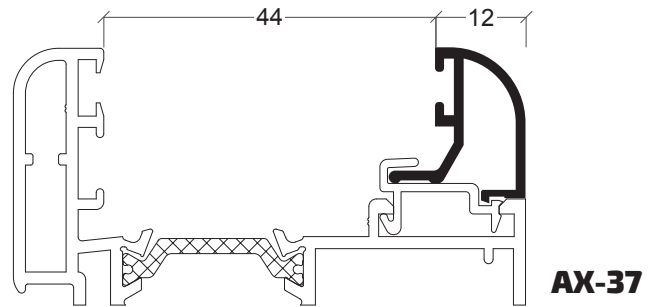
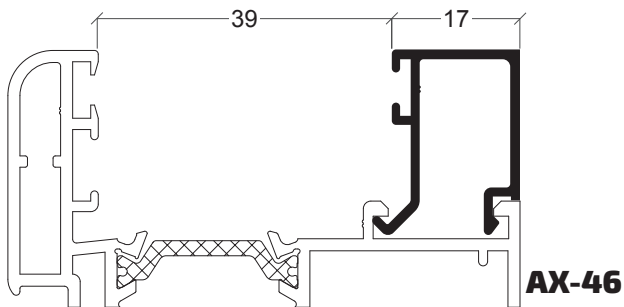
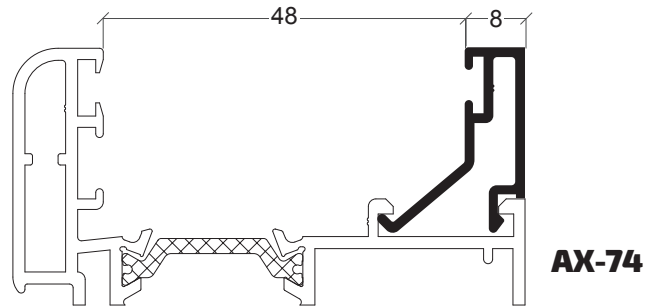
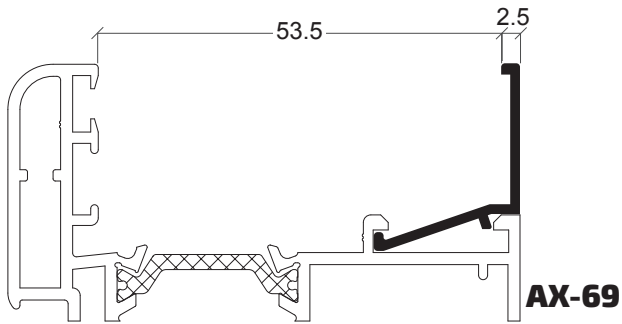

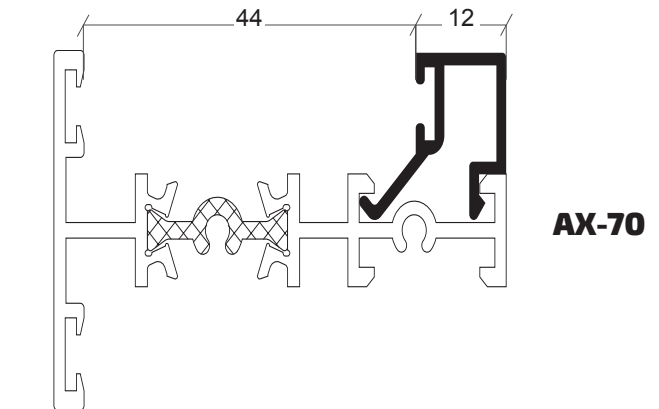
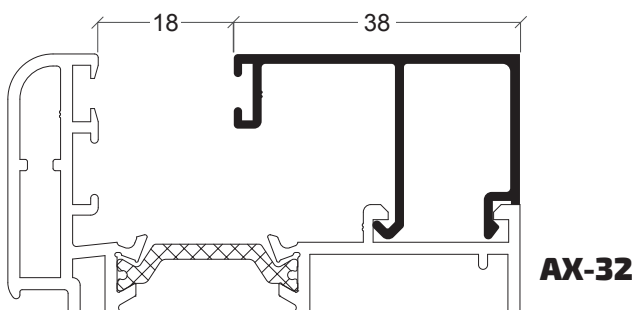
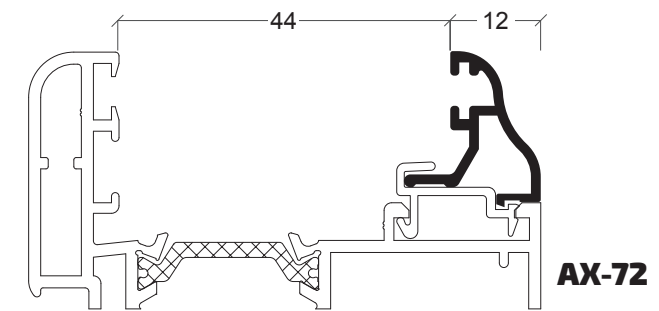
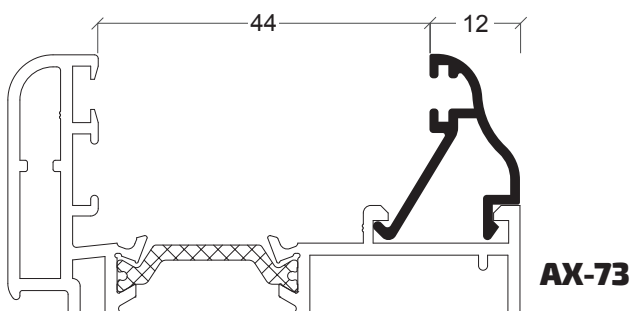
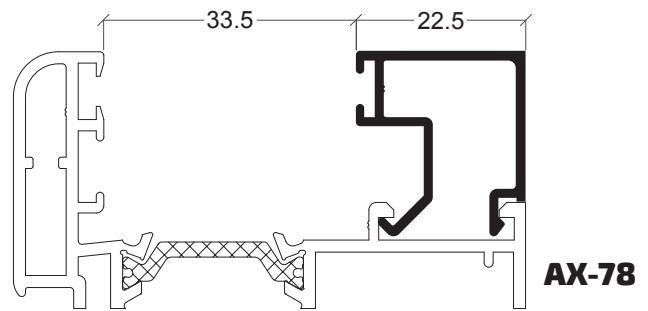
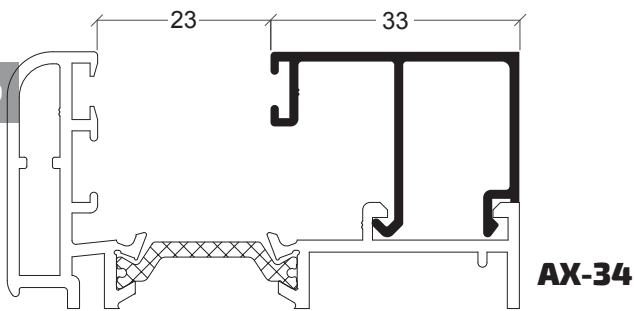
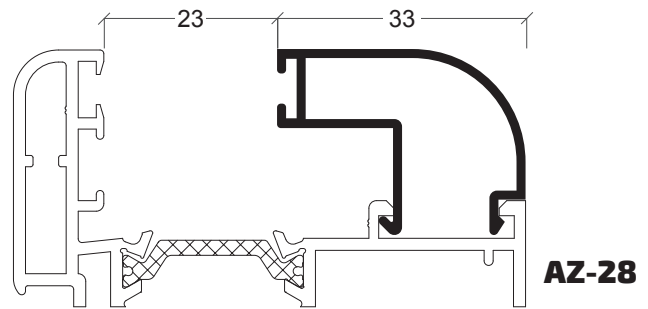
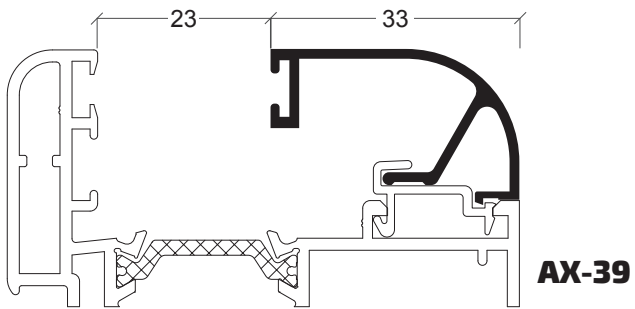
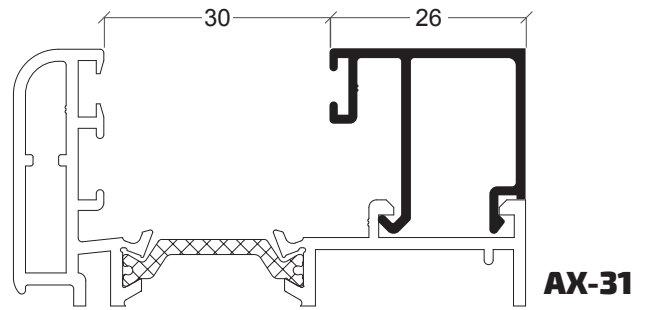
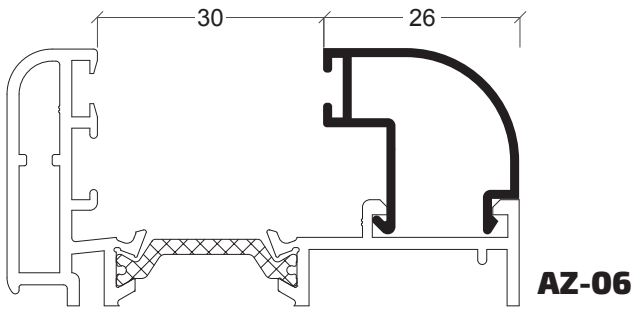

90

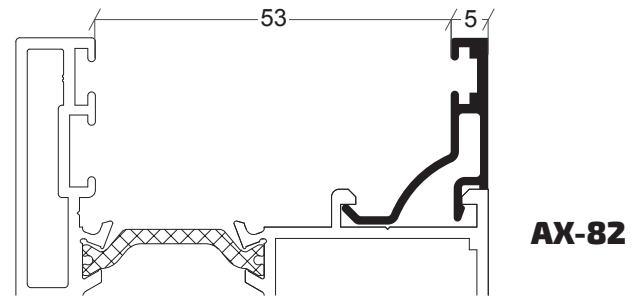
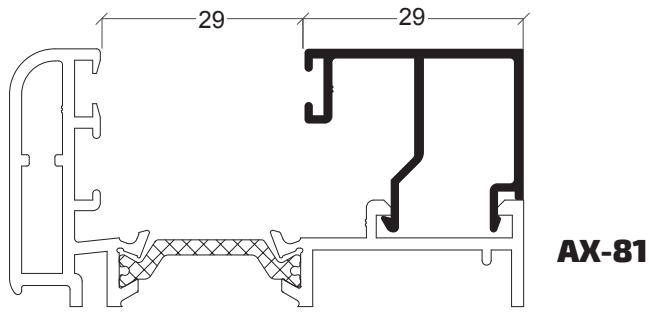

Bites ARi Folha Oculta:

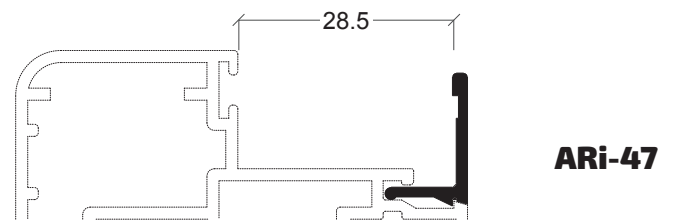
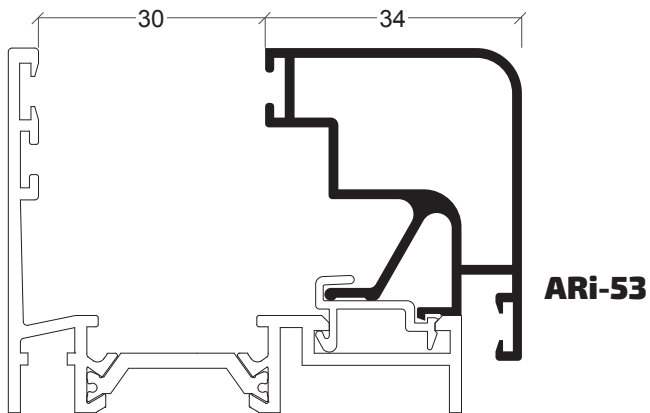
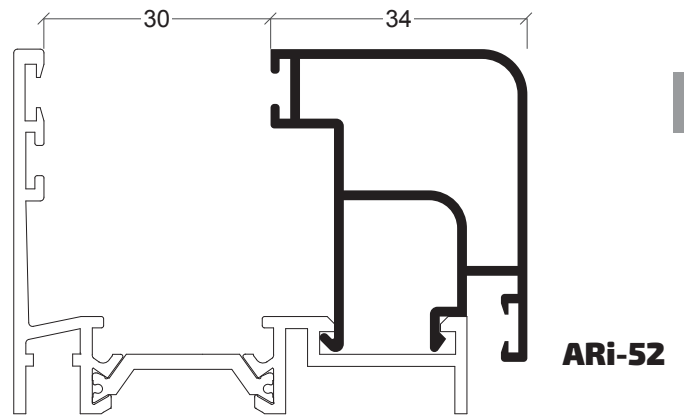
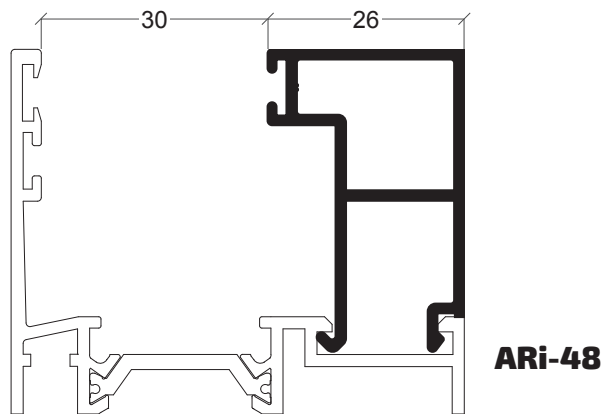

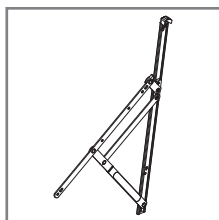

30 00 95 71

Compasso projectante deslizante até 75kg/folha
Compás projectante deslizante hasta 75 kg/hoja

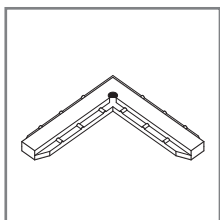

30 21 20 07

Esquadro de alinhamento
Escuadra de alineamiento

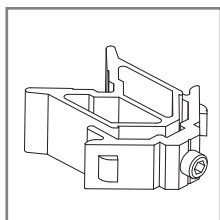

30 60 00 03

Esquadro interior ARi-93
Escuadra interior ARi-93

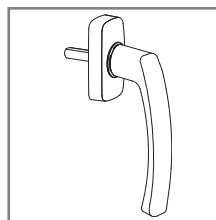

30 60 16 40/41

Puxador de alumínio branco/preto
Manilla de alumínio branco/negro

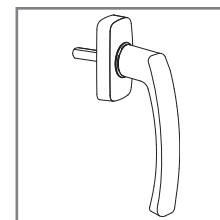

30 60 16 42/43

Puxador de alumínio 2ac/ champ ac
Manilla de alumínio 2 ac/champ ac

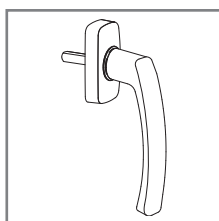

30 60 16 44

Puxador de alumínio inox ac
Manilla de alumínio inox ac

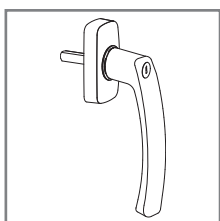

30 60 16 45/46

Puxador de alumínio com chave branco/preto
Manilla con llave de alumínio branco/negro

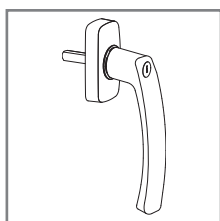

30 60 16 47/48

Puxador de alumínio com llave 2 ac/ champ ac
Manilla con llave de alumínio 2 ac/ champ ac

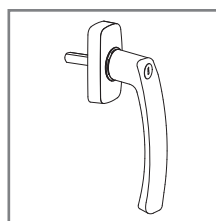

30 60 16 49

Puxador de alumínio com chave 2 inox ac
Manilla con llave de alumínio inox ac

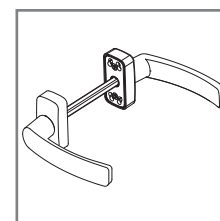

30 60 16 50/51

Puxador duplo de alumínio branco/preto
Manilla doble de alumínio branco/negro

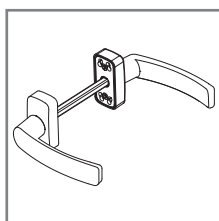

30 60 16 52/53

Puxador duplo de alumínio ac/champ ac
Manilla doble de alumínio 2 ac/champ ac

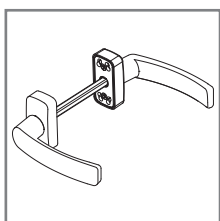

30 60 16 54

Puxador duplo de alumínio inox ac
Manilla doble de alumínio inox ac

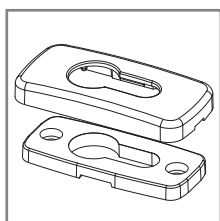

30 60 16 55/56

Espelho de alumínio p/ canhão branco/preto
Escudo de alumínio branco/negro

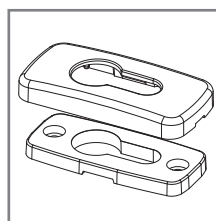

30 60 16 57/58

Espelho de alumínio p/ canhão champ ac
Escudo de alumínio 2 ac/champ ac

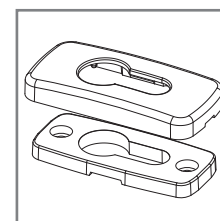

30 60 16 59

Espelho de alumínio p/ canhão inox ac
Escudo de alumínio inox ac

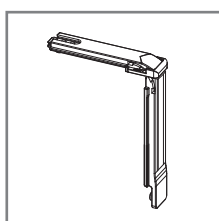

30 90 20 42

Ângulo de reenvio
Angulo de reenvio

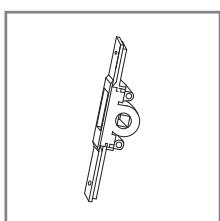

30 90 20 44

Transmissão para abertura exterior
Transmisión para apertura exterior

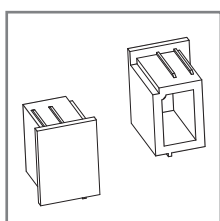

30 91 21 20

Jogo topos condensação para Y-20
Juego topos condensación para Y-20

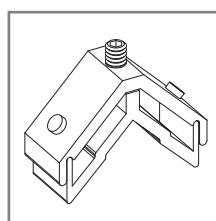

30 91 40 15

Esquadro aro fixo ARi-38
Escuadra marco ARi-38

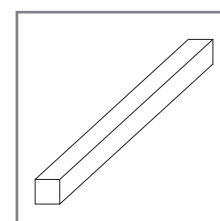

30 91 41 23

Perno 7x131 mm
Perno 7x131 mm

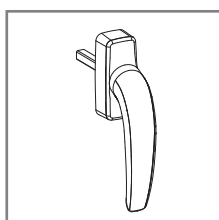

30 91 41 47/48

Cremona pivotante especial branco/preto
Cremona pivotante especial blanco/negro

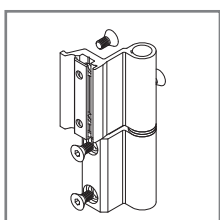

30 92 00 20/21

Dobradiça C.E. branco/preto
Bisagra C.E. blanco/negro

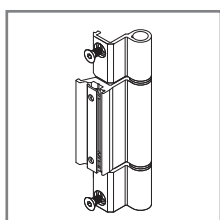

30 92 00 27/28

Dobradiça três nós (branco/preto)
Bisagra tres nudos (blanco/negro)

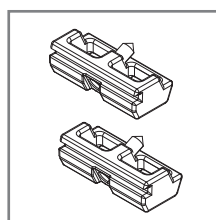

30 92 00 50

Contra-fecho
Contra-cierre

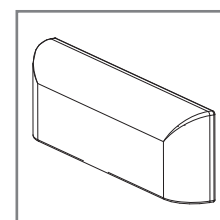

30 92 01 00/01

Goteiras preto/branco
Tapa salida de aguas negro/blanco

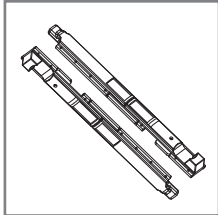

30 92 01 20

Jogo fecho C.E.
Juego cierre C.E.

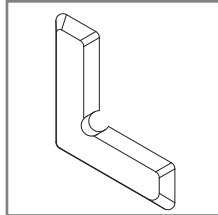

30 92 01 35

Esquadro alinhamento móvel
Escuadra alineamiento hoja

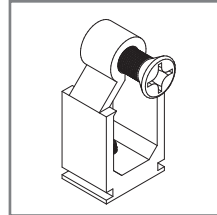

30 92 01 40

União topos janela
Unión topos ventana

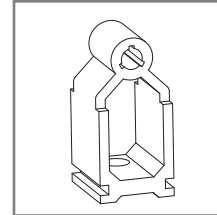

30 92 01 45

União topos janela folha oculta
Unión topos ventana hoja oculta

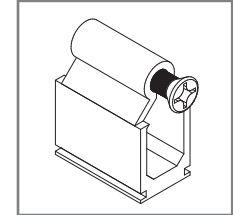

30 92 01 50

União topos porta
Unión topos puerta

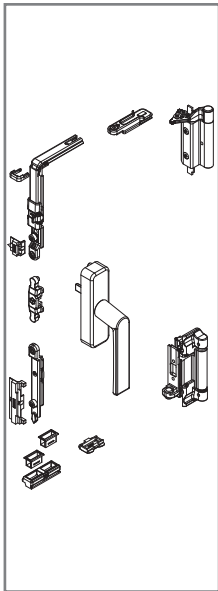

30 92 02 20/21

Kit oscilobatente branco/preto
Kit oscilobatiente blanco/negro

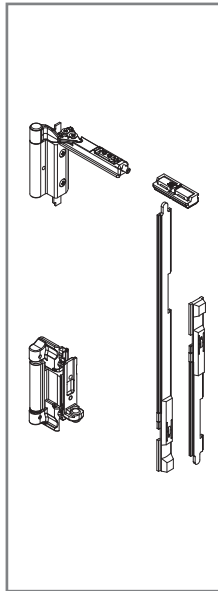

30 92 02 24/25

Kit 2ª folha OB branco/preto
Kit 2ª hoja OB blanco/negro

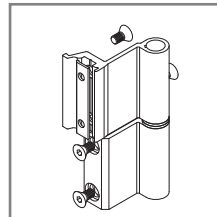

30 92 01 70/80

Dobradora 3 folhas branco/preto
Bisagra 3 hojas blanco/negro

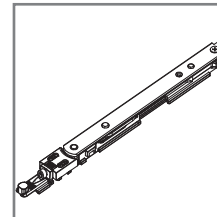

30 92 02 10/11/12

Compasso oscilo 300/400/500
Compás oscilo 300/400/500

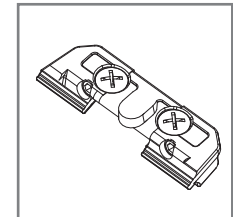

30 92 02 15

Fecho para micro-ventilação
Cierre para microventilación

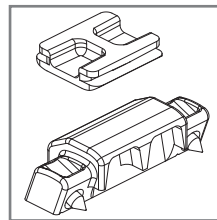

30 92 02 60

Apoio da folha
Apoyo hoja

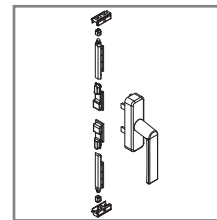

30 92 03 10/11

Kit cremone branco/preto
Kit cremona blanco/negro

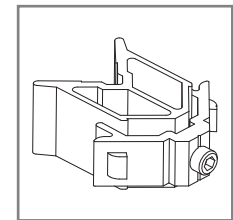

30 92 03 90

Esquadro porta
Escuadra puerta

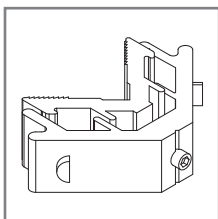

30 92 04 25

Esquadro ARI-80
Escuadra ARI-80

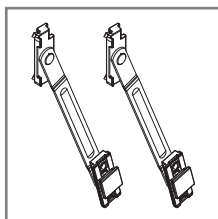

30 92 04 75

Jogo compasso basculante
Juego compás abatible

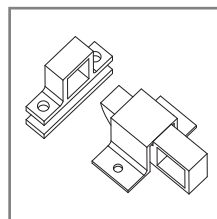

30 92 04 76/77

Fecho clack (branco/preto)
Cierre golpete (blanco/negro)

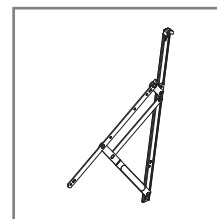

30 92 04 80

Compasso projectante deslizante até 50 kg/folha
Compás projectante deslizante hasta 50 kg/hoja

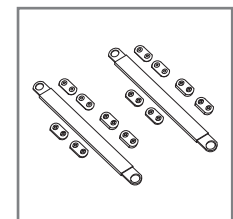

30 92 04 85

Jogo compasso
Juego compás

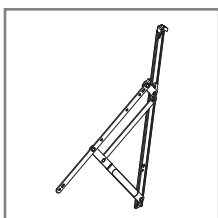

30 92 04 90

Compasso projectante deslizante até 65 kg/folha
Compás projectante deslizante hasta 65 kg/hoja

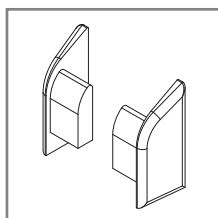

30 92 05 00

Jogo topos
Juego topes

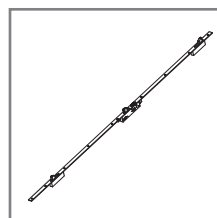

30 92 05 10

Fechadura 3 pontos (35 mm)
Cierre 3 puntos (35 mm)

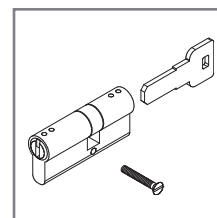

30 92 05 50

Canhão fechadura 30x40
Bombillo cierre 30 x 40

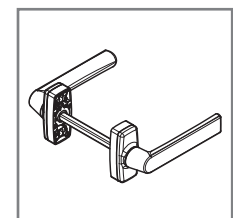

30 92 05 60/61

Puxador duplo branco/preto
Manilla doble blanco/negro

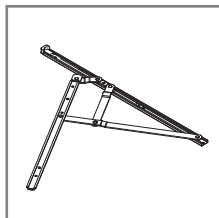

30 92 06 00

Compasso projectante deslizante até 35 kg/folha

Compás projectante deslizante hasta 35 kg/hoja

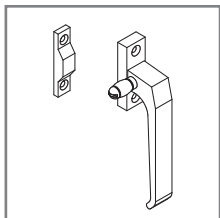

30 92 06 10/11

Cremona de lingueta branco/preto

Cremona de presión blanco/negro

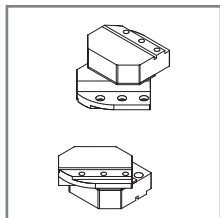

30 92 07 12

Jogo pivotante vertical especial ARi preto (130 kg)

Juego pivotante vertical especial ARi negro (130 kg)

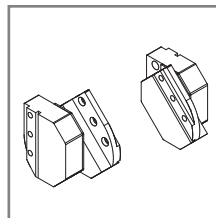

30 92 07 13

Jogo pivotante horizontal especial ARi preto (130 kg)

Juego pivotante horizontal especial ARi negro (130 kg)

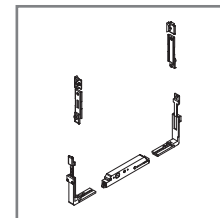

30 92 07 16

Fecho perimetral pivotante especial

Cierre perimetral pivotante especial

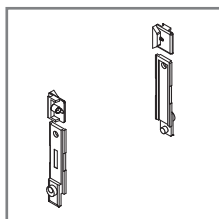

30 92 07 17

Fecho suplementar pivotante especial

Cierre suplementario pivotante especial

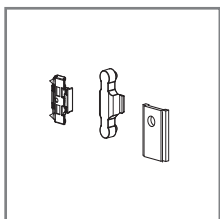

30 92 22 43

Ponto fecho suplementar

Punto cierre suplementario

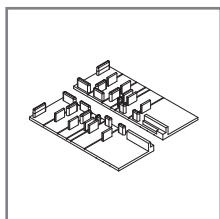

30 95 60 60

Conjunto de vedação preto

Conjunto de vedação negro

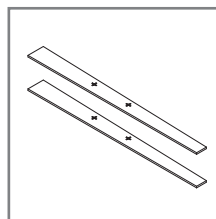

30 95 60 61

Conjunto de juntas

Conjunto de juntas

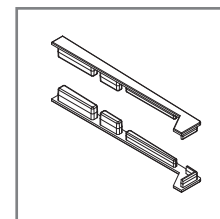

30 95 60 62

Conjunto de topos S-36

Conjunto de topos S-36

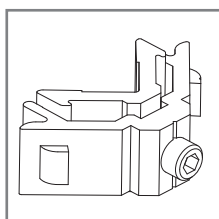

30 96 00 04

Esquadro janela

Escuadra ventana

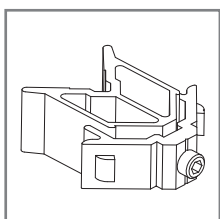

30 96 00 05

Esquadro aro fixo porta

Escuadra marco puerta

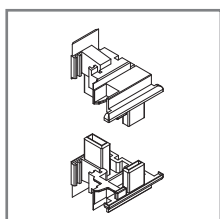

30 96 00 08

Jogo topos inversor ARi

Juego topos inversor ARi

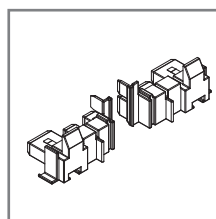

30 96 00 10

Jogo topos ARi-23

Juego topos ARi-23

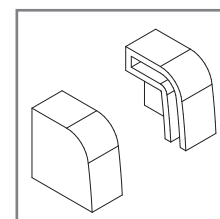

30 96 00 12

Jogo topos condensação

Juego topos condensación

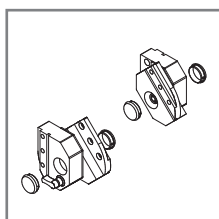

30 96 00 13

Jogo pivotante (60 kg)

Juego pivotante (60 kg)

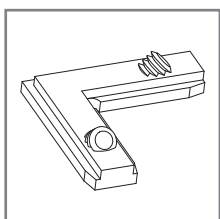

30 96 00 15

Esquadro alinhamento móvel

Escuadra alineamiento hoja

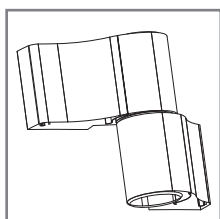

30 96 00 16/20

Dobraçã lisa (branco/preto)

Bisagra lisa (blanco/negro)

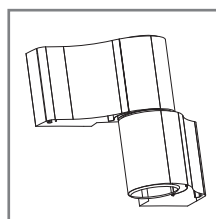

30 96 00 17/21

Dobraçã com ressalto (branco/preto)

Bisagra con ressalto (blanco/negro)

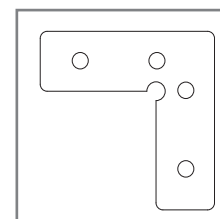

30 96 00 22

Esquadro alinhamento especial

Escuadra alineamiento especial

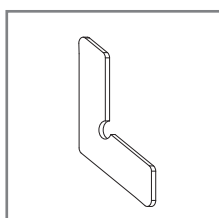

30 96 00 23

Esquadro alinhamento aro fixo

Escuadra alineamiento marco

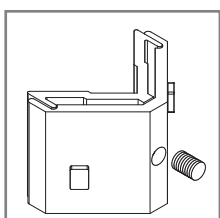

30 96 00 24

Esquadro exterior móvel folha oculta

Escuadra exterior hoja oculta

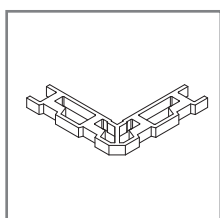

30 96 00 25

Esquadro exterior aro fixo

Escuadra exterior marco

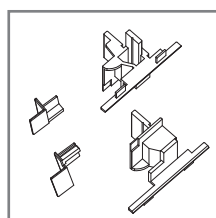

30 96 00 26

Jogo topos inversor folha oculta

Juego topos inversor hoja oculta

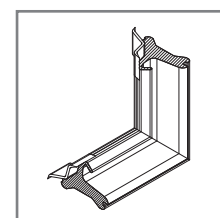

30 96 00 35

Canto vulcanizado

Angulo vulcanizado

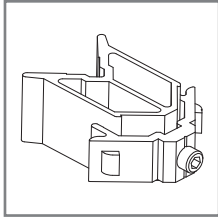

30 96 00 36

Esquadro aro móvel porta
Escuadra hoja puerta

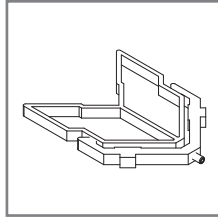

30 96 00 41

Esquadro alinhamento aro móvel porta
Escuadra alineamiento hoja puerta

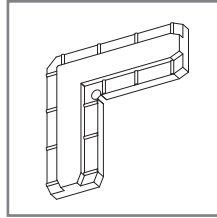

30 96 00 43

Esquadro alinhamento
Escuadra alineamiento

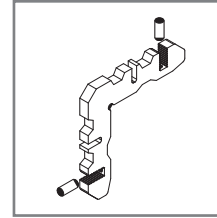

30 96 00 45

Esquadro de alinhamento 5.2x14 com
parafusos
Escuadra alineamiento 5.2x14 con
tornillos

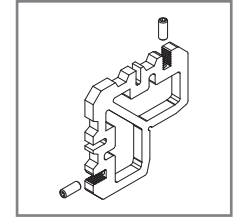

30 96 00 46

Esquadro de alinhamento 5.2x36 com
parafusos
Escuadra alineamiento 5.2x36 con
tornillos

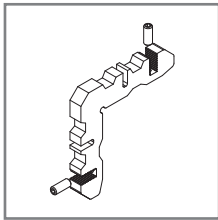

30 96 00 48

Esquadro de alinhamento 7x14 c/
parafusos
Escuadra alineamiento 7x14 c/ tornillos

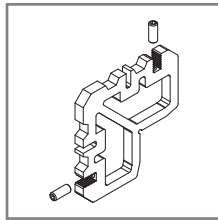

30 96 00 49

Esquadro de alinhamento aro fixo com
parafusos
Escuadra alineamiento marco con
tornillos

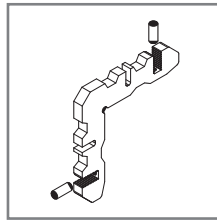

30 96 00 51

Esquadro alinhamento
Escuadra alineamiento

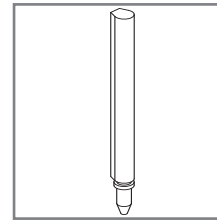

30 96 00 55

Perno alternativo para fixação de
esquadro
Perno alternativo para fijación de
escuadra

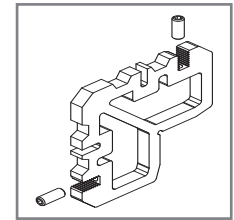

30 96 00 60

Esquadro de alinhamento 5.2x31.6 com
parafusos
Escuadra alineamiento 5.2x31.6 con
tornillos

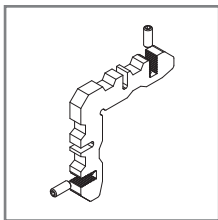

30 96 00 61

Esquadro de alinhamento ARi-83 perfil
exterior
Escuadra alineamiento ARi-83 perfil
exterior

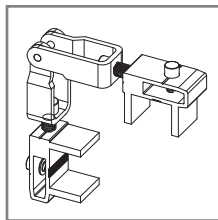

30 96 00 64

Esquadro Angular 31 ARi-08/59/68/69
Escuadra Angular 31 ARi-08/59/68/69

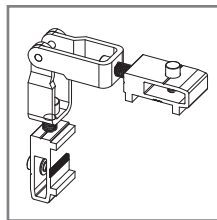

30 96 00 68

Esquadro Angular 14 ARi-03/05/33/
35/57/58/61/74/76/77/81/83/97
Escuadra Angular 14 ARi-03/05/33/
35/57/58/61/74/76/77/81/83/97

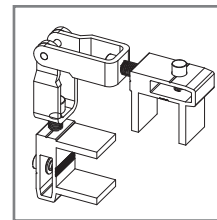

30 96 00 69

Esquadro Angular 36 ARi-10/36/60/54
Escuadra Angular 36 ARi-10/36/60/54

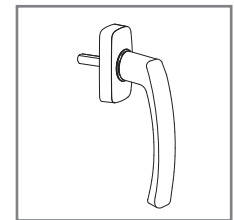

31 70 16 40

Puxador de alumínio
Manilla de alumínio

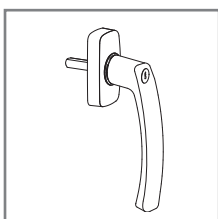

31 70 16 42

Puxador com chave de alumínio
Manilla con llave de alumínio

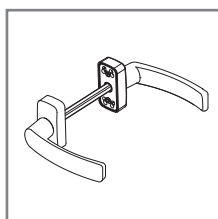

31 70 16 43

Puxador duplo de alumínio bruto
Manilla doble de alumínio crudo

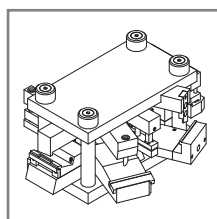

33 96 79 99

Cunho C.E.
Troquel C.E.

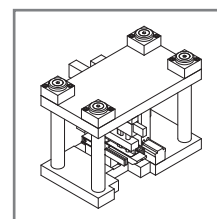





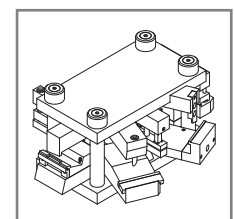



















33 96 87 99

Cunho esquadro interior e exterior ARi/AKi
Troquel escuadra interior y exterior ARi/AKi



33 20 70 02

Cunho ARi Folha Oculta
Troquel ARi Hoja Oculta

REFERÊNCIA - REFERENCIA	DESENHO - DISEÑO	DESCRIÇÃO - DESCRIPCIÓN
30 00 95 15		Junta vedação interior curta • Junta estanqueidad interior curta
30 20 30 03		Junta isolante • Junta aislante
30 20 70 03		Pelúcia remate porta 11x12 mm • Burlete acople puerta 11x12 mm
30 60 00 17		Junta exterior vidro plana 2 mm preto • Junta exterior vidrio plana 2 mm negro
30 92 04 70		Espuma isolante • Espuma aislante
30 93 00 60		Vedante exterior de vidro (opcional) • Junta exterior de vidrio (opcional)
30 93 00 61		Junta vedação exterior vidro 2 mm • Junta estanqueidad exterior vidrio 2 mm
30 93 00 62		Junta plana para vidro • Junta plana para vidrio
30 93 00 65		Junta interior para vidro (5 mm) • Junta interior para vidrio (5 mm)
30 93 00 66		Junta interior para vidro (4 mm) • Junta interior para vidrio (4 mm)
30 93 00 67		Junta interior para vidro (2 mm) • Junta interior para vidrio (2 mm)
30 93 00 68		Junta interior para vidro (6/7 mm) • Junta interior para vidrio (6/7 mm)
30 93 00 69		Junta interior para vidro (8/9 mm) • Junta interior para vidrio (8/9 mm)
30 93 00 70		Vedante interior de vidro (opcional) • Junta interior de vidrio (opcional)
30 93 00 80		Junta de vedação inferior ARi-42 • Junta de estanqueidad inferior ARi-42
30 93 00 82		Junta vedação inferior • Junta estanqueidad inferior
30 93 00 84		Junta para pingadeiras AZ-60 e AZ-70 • Junta para viertaguas AZ-60 e AZ-70
30 93 01 20		Junta interior • Junta interior
30 93 01 30		Junta exterior (abertura exterior/projectante) • Junta exterior (apertura exterior/proyectante)
30 95 00 10		Pelúcia 7x9 mm • Burlete 7x9 mm
30 96 00 02		Junta exterior • Junta exterior
30 96 00 03		Junta central • Junta central
30 96 00 09		Junta central abertura exterior (ARi-25) ou tapa-canal • Junta central apertura exterior (ARi-25) u tapa canal
30 96 00 18		Junta interior (abertura projectante/deslizante) • Junta interior (apertura proyectante/deslizante)
30 96 00 27		Junta exterior folha oculta • Junta exterior hoja oculta

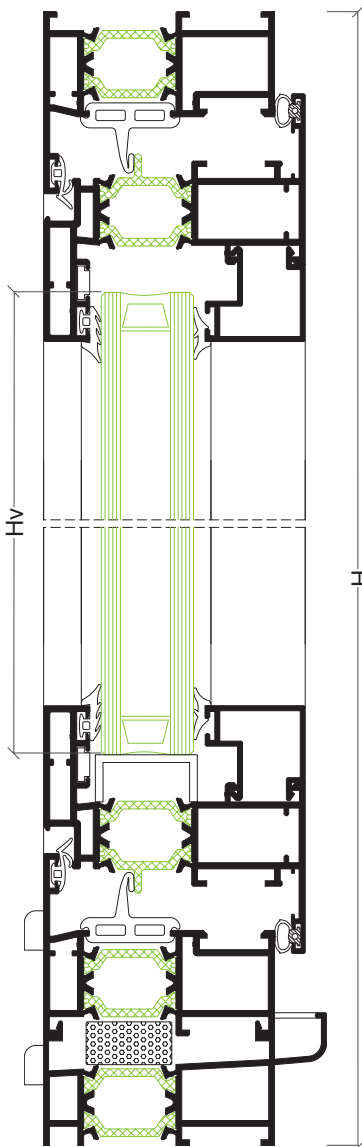
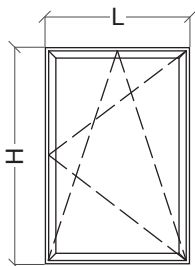
Janela 1 folha abrir e oscilo-batente • Ventana 1 hoja practicable y oscilobatiente

PERFIS • PERFIS

DESENHO • DISEÑO	REF.	DESCRIÇÃO • DESCRIPCIÓN	CORTE • CORTE	QUANTIDADE • CANTIDAD	MEDIDAS • MEDIDA
	ARI-03	Aro fixo • Marco ventana		2	L
				2	H-28.5 mm
	ARI-61	Aro móvel • Hoja ventana		2	L-43 mm
				2	H-71.5 mm
	---	Bite • Junquillo		2	L-132 mm
				2	H-200.5 mm
	CT-11	Soleira condensação • Condensación		1	L
	AX-19	Vareta • Pletina falleba		1+1	Apro. H+L

ACESSÓRIOS E JUNTAS • ACCESORIOS Y JUNTAS

REF.	DESCRIÇÃO • DESCRIPTION	QUANTIDADE • CANTIDAD	
		ABRIR PRATICABLE	OSCILO-BATENTE OSCILOBATIENTE
30 92 00 20	Dobradiças C.E. • Bisagras C.E.	2	---
30 92 01 00	Goteiras • Tapa salida de aguas	4	4
30 92 02 XX	Compasso O.B. • Compás O.B.	---	1
30 92 02 20	Kit oscilo-batente • Kit oscilobatiente	---	1
30 92 02 60	Apoio da folha • Apoyo hoja	1	---
30 92 03 10	Kit cremone • Kit cremona	1	---
30 96 00 04	Esquadro janela • Escuadra ventana	8	8
30 96 00 48	Esquadro alinhamento aro fixo • Escuadra alineamiento marco	4	4
30 96 00 12	Jogo topos condensação • Juego topos condensación	1	1
30 96 00 15	Esquadro alinhamento móvel • Escuadra alineamiento hoja	4	4
30 96 00 22	Esquadro alinhamento móvel • Escuadra alineamiento hoja	4	4
30 96 00 45	Esquadro alinhamento exterior móvel • Escuadra alineamiento exterior hoja	4	4
30 96 00 35	Canto vulcanizado • Angulo vulcanizado	4	4
30 92 04 70	Espuma isolante • Espuma aislante	L	
30 96 00 02	Junta exterior • Junta exterior	2L+2H	
30 96 00 03	Junta central • Junta central	2L+2H	
30 93 01 20	Junta interior • Junta interior	2L+2H	
---	Junta exterior vidro • Junta exterior vidrio	2L+2H	
---	Junta interior vidro • Junta interior vidrio	2L+2H	

VIDRO • VIDRIO

Hv = H-174 mm	Lv = L-146 mm
---------------	---------------

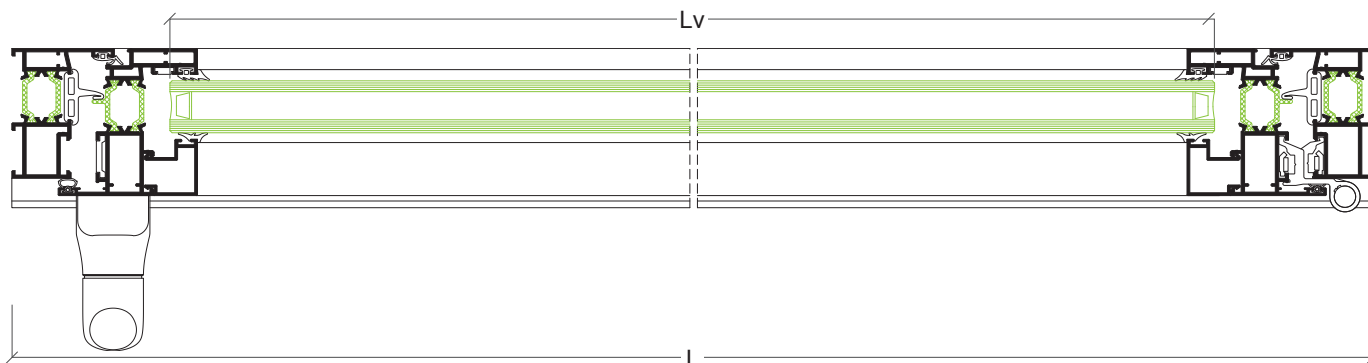

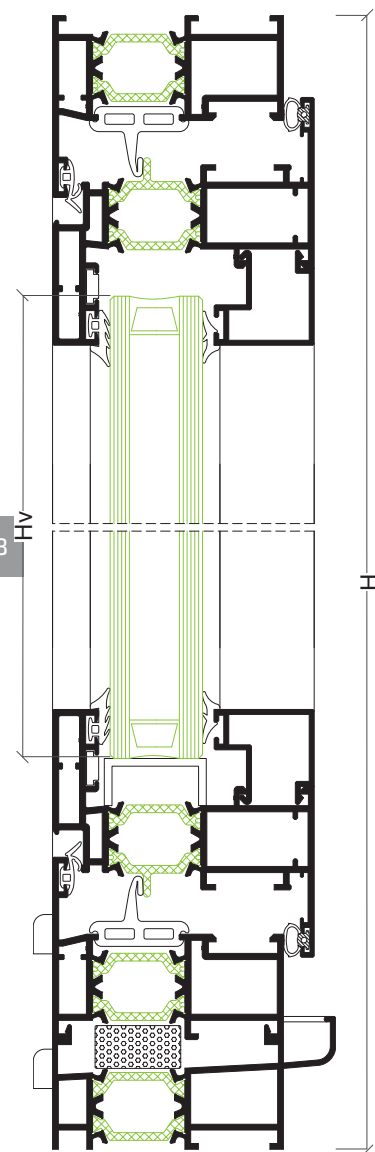
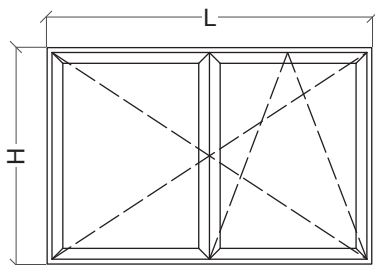
Janela 2 folhas abrir e oscilo-batente • Ventana 2 hojas practicable y oscilobatiente

PERFIS • PERFIS

DESENHO • DESEÑO	REF.	DESCRIÇÃO • DESCRIPCIÓN	CORTE • CORTE	QUANTIDADE • CANTIDAD	MEDIDAS • MEDIDA
	ARi-03	Aro fixo • Marco ventana		2	L
				2	H-28.5 mm
	ARi-61	Aro móvel • Hoja ventana		2	L/2-24 mm
				2	H-71.5 mm
	ARi-04	Inversor • Inversor		1	H-139.5 mm
	---	Bite • Junquillo		4	L/2-113 mm
				4	H-200.5 mm
	CT-11	Soleira condensação • Condensación		1	L
	AX-19	Vareta • Pletina falleba		1+1	Apro. H+L

ACESSÓRIOS E JUNTAS • ACCESORIOS Y JUNTAS







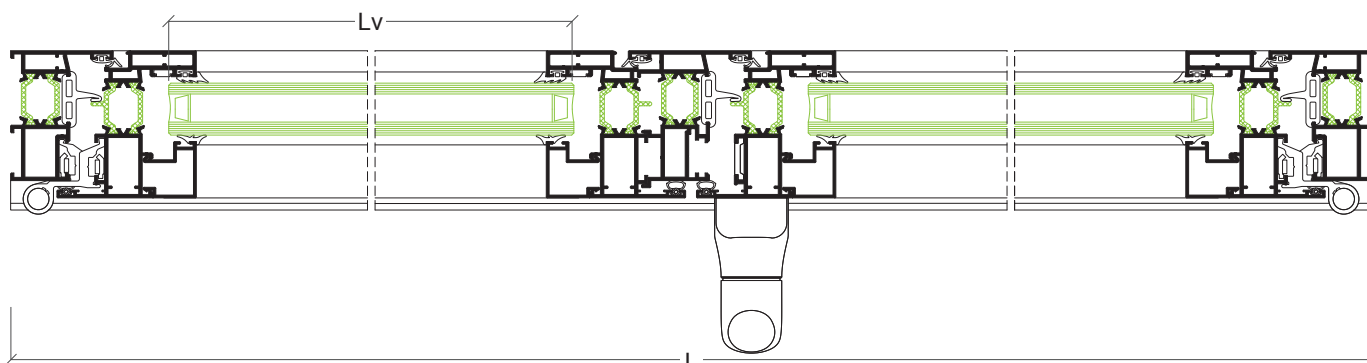

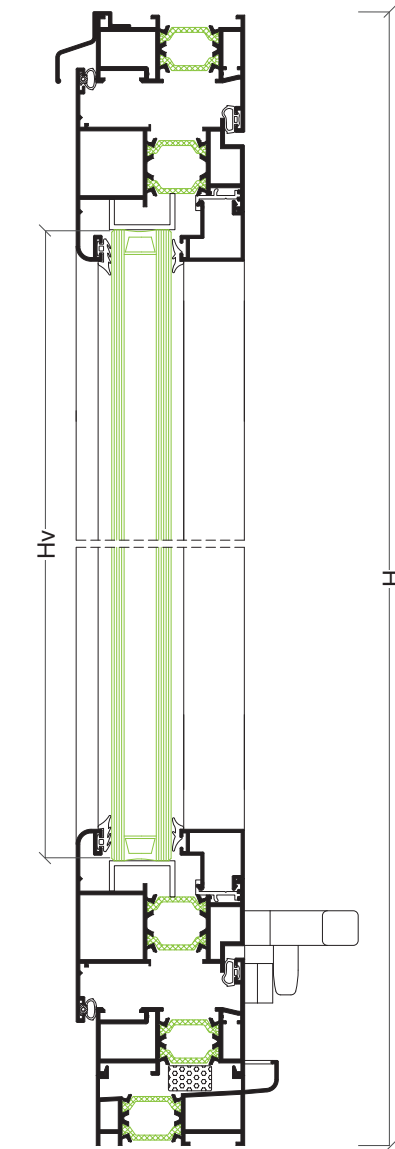
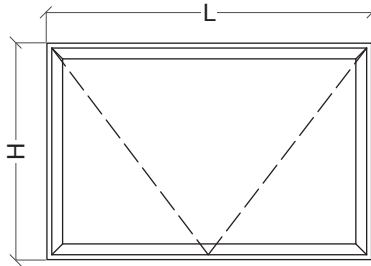

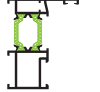







REF.	DESCRIÇÃO • DESCRIPTION	QUANTIDADE • CANTIDAD	
		ABRIR PRATICABLE	OSCILO-BATENTE OSCIOBATIENTE
30 92 00 20	Dobradiças C.E. • Bisagras C.E.	4	---
30 92 01 00	Goteiras • Tapa salida de aguas	4	4
30 92 01 20	Jogo fecho C.E. • Juego cierre C.E.	1	---
30 92 02 XX	Compasso O.B. • Compás O.B.	---	1
30 92 02 20	Kit oscilo-batente • Kit oscilobatiente	---	1
30 92 02 24	Kit 2ª folha oscilo-batente • Kit 2ª hoja oscilobatiente	---	1
30 92 02 60	Apoio da folha • Apoyo hoja	1	---
30 92 03 10	Kit cremone • Kit cremona	1	---
30 96 00 04	Esquadro janela • Escuadra ventana	12	12
30 96 00 48	Esquadro alinhamento aro fixo • Escuadra alineamiento marco	8	8
30 96 00 08	Jogo topos inversor • Juego topos inversor	1	1
30 96 00 12	Jogo topos condensação • Juego topos condensación	1	1
30 96 00 15	Esquadro alinhamento móvel • Escuadra alineamiento	8	8
30 96 00 22	Esquadro alinhamento móvel • Escuadra alineamiento	8	8
30 96 00 45	Esquadro alinhamento exterior móvel • Escuadra alineamiento exterior hoja	4	4
30 96 00 35	Canto vulcanizado • Anqulo vulcanizado	4	4
30 92 04 70	Espuma isolante • Espuma aislante	L	
30 96 00 02	Junta exterior • Junta exterior	2L+4H	
30 96 00 03	Junta central • Junta central	2L+3H	
30 93 01 20	Junta interior • Junta interior	2L+4H	
---	Junta exterior vidro • Junta exterior vidrio	2L+2H	
---	Junta interior vidro • Junta interior vidrio	2L+2H	

VIDRO • VIDRIO

Hv = H-174 mm	Lv = L/2-127 mm
---------------	-----------------

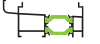

Janela projectante deslizante • Ventana proyectante deslizante

PERFIS • PERFIS

DESENHO • DISEÑO	REF.	DESCRIÇÃO • DESCRIPCIÓN	CORTE • CORTE	QUANTIDADE CANTIDAD	MEDIDAS • MEDIDA
	ARI-03	Aro fixo • Marco ventana		2	L
			2	H-28.5 mm	
	ARI-07	Aro móvel abertura projectante deslizante Marco abertura proyectante deslizante		2	L-43 mm
			2	H-71.5 mm	
	---	Bite • Junquillo		4	L-159 mm
				4	H-227.5 mm
	AXi-45	Pingadeira superior • Vierteaguas superior		1	L
	AXi-32	Complemento abertura projectante Complemento apertura proyectante		2	segundo medida compasso • segundo medida compás
	ARI-29	Apoio bite • Apoyo junquillo		2	L-140 mm
				2	H-168.5 mm
	CT-11	Soleira condensação Condensación		1	L

ACESSÓRIOS E JUNTAS • ACCESORIOS Y JUNTAS

REF.	DESCRIÇÃO • DESCRIPTION	QUANTIDADE CANTIDAD
30 92 01 00	Goteiras • Tapa salida de aguas	2
30 92 04 90	Jogo compasso projectante deslizante 550 • Juego compás proyectante deslizante 550	1
30 92 06 10	Cremona de lingueta • Cremona de presión	2
30 92 04 10	Esquadro janela abertura exterior • Escuadra ventana abertura exterior	4
30 96 00 12	Jogo topos condensação • Juego topos condensación	1
30 96 00 48	Esquadro alinhamento aro fixo • Escuadra alineamiento marco	4
30 96 00 42	Esquadro alinhamento interno móvel • Escuadra alineamiento interno hoja	4
30 92 04 70	Espuma isolante • Espuma aislante	L
30 93 01 20	Junta exterior • Junta exterior	2L+2H
30 96 00 04	Esquadro janela • Escuadra ventana	4
30 96 00 18	Junta interior projectante deslizante • Junta interior proyectante deslizante	2L+2H
---	Junta exterior vidro • Junta exterior vidrio	2L+2H
---	Junta interior vidro • Junta interior vidrio	2L+2H

VIDRO • VIDRIO



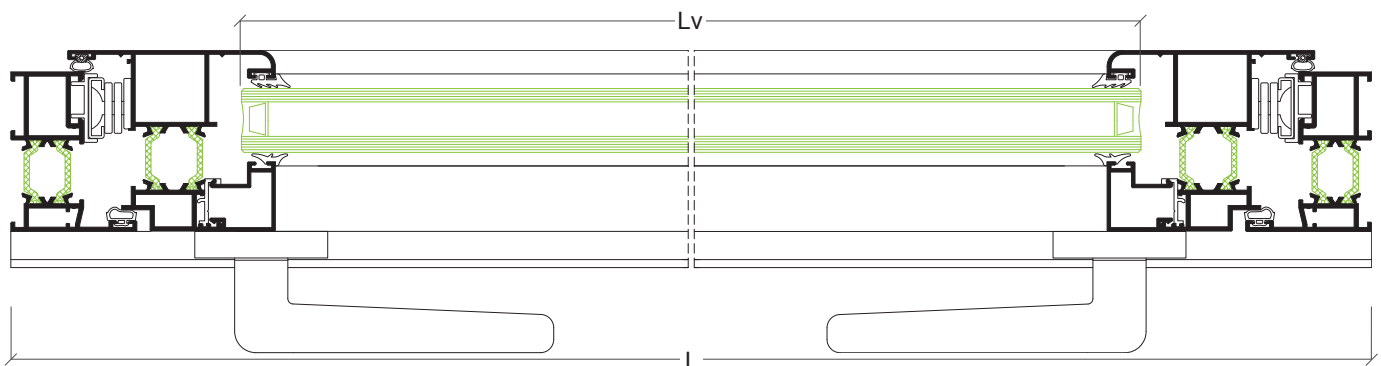



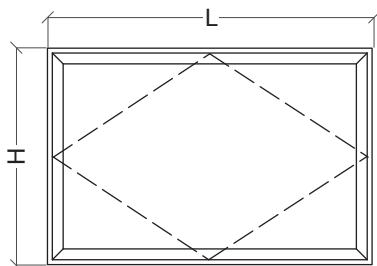





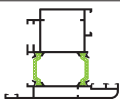

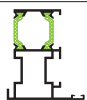

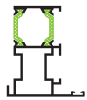
Hv = H-201 mm	Lv = L-173 mm
---------------	---------------



Janela pivotante horizontal • Ventana pivotante horizontal



PERFIS • PERFIS

DESENHO • DISEÑO	REF.	DESCRIÇÃO • DESCRIPCIÓN	CORTE • CORTE	QUANTIDADE CANTIDAD	MEDIDAS • MEDIDA
	ARI-03	Aro fixo • Marco ventana		2	L
				2	H-28.5 mm
	ARI-25	Aro móvel abertura exterior Hoja apertura exterior		2	L-107 mm
				2	H-135.5 mm
	ARI-14	Inversor pivotante superior Inversor pivotante superior		1	L-46 mm
				2	H/2-23 mm
	ARI-14	Inversor pivotante inferior Inversor pivotante inferior		1	L-46 mm
				2	H/2-51.5 mm
	---	Bite • Junquillo		2	L-239 mm
				2	H-307.5 mm
	CT-11	Soleira condensação Condensación		1	L
	AX-19	Vareta • Pletina falleba		1+1	L+H
				1+1	L+H

ACESSÓRIOS E JUNTAS • ACCESORIOS Y JUNTAS

REF.	DESCRIÇÃO • DESCRIPTION	QUANTIDADE CANTIDAD
30 92 01 00	Goteiras • Tapa salida de aguas	4
30 94 50 10	Esquadro inversor • Escuadra inversor	4
30 96 00 04	Esquadro janela • Escuadra ventana	4
30 96 00 05	Esquadro móvel • Escuadra hoja	4
30 96 00 48	Esquadro alinhamento exterior janela • Escuadra alineamiento exterior ventana	4
30 96 00 12	Jogo topos condensação • Juego topos condensación	1
30 92 07 13	Jogo pivotante horizontal • Juego pivotante horizontal	1
30 92 07 16	Fecho perimetral pivotante • Cierre perimetral pivotante	1
30 96 00 15	Esquadro alinhamento móvel • Escuadra alineamiento hoja	4
30 96 00 49	Esquadro alinhamento móvel • Escuadra alineamiento hoja	4
30 91 41 48	Cremona • Cremona	1
30 92 04 70	Espuma isolante • Espuma aislante	L
30 96 00 18	Junta exterior • Junta exterior	4L+4H
30 93 01 20	Junta interior • Junta interior	2L+2H
---	Junta exterior vidro • Junta exterior vidrio	2L+2H
---	Junta interior vidro • Junta interior vidrio	2L+2H

VIDRO • VIDRIO

Hv = H-281 mm	Lv = L-253 mm
---------------	---------------

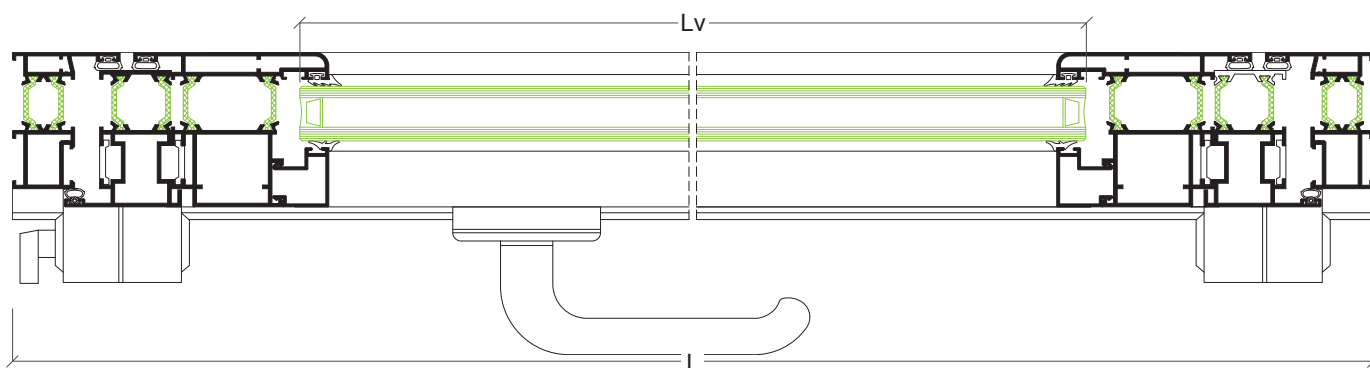
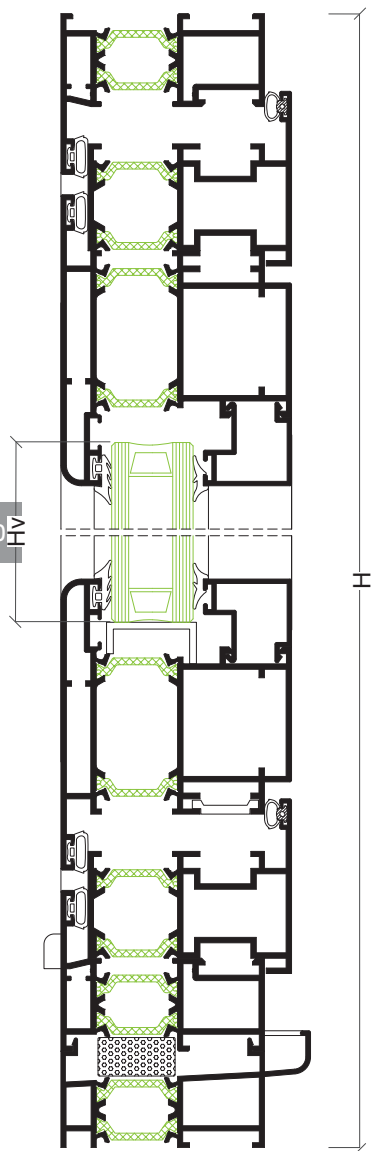

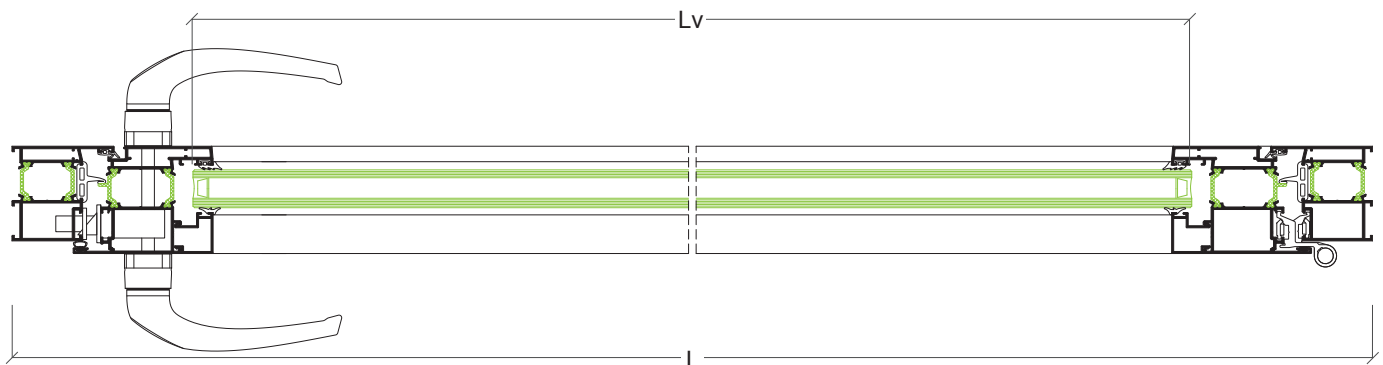
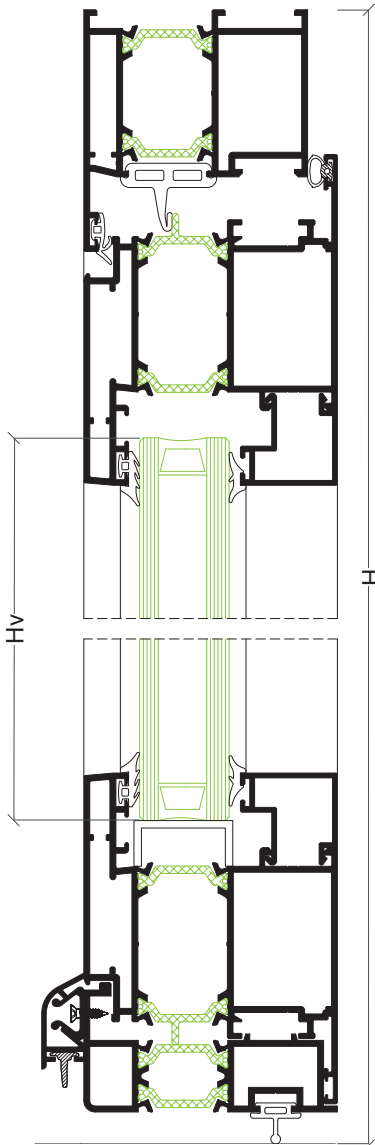
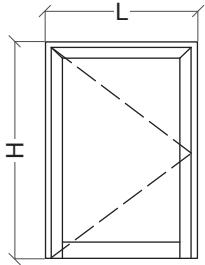
Porta 1 folha • Puerta 1 hoja

PERFIS • PERFIS

DESENHO • DESEÑO	REF.	DESCRIÇÃO • DESCRIPCIÓN	CORTE • CORTE	QUANTIDADE CANTIDAD	MEDIDAS • MEDIDA
	ARI-08	Aro fixo • Marco puerta		1	L
				2	H
	ARI-36	Aro móvel • Hoja puerta		2	L-78 mm
				2	H-46 mm
	ARI-23	Remate Almofada • Acople de hoja p/ zocalo inferior		1	L-147 mm
	---	Bite • Junquillo		4	L-216 mm
				4	H-226 mm
	AZ-60	Pingadeira • Vierteaguas puerta		1	L-148 mm

ACESSÓRIOS E JUNTAS • ACCESORIOS Y JUNTAS

REF.	DESCRIÇÃO • DESCRIPTION	QUANTIDADE CANTIDAD
30 92 00 20	Dobradiças C.E. • Bisagras C.E.	3
30 92 01 35	Esquadro alinhamento móvel • Escuadra alineamiento hoja	4
30 92 05 10	Fechadura 3 pontos • Cierre 3 puntos	1
30 92 05 50	Canhão fechadura 30x40 • Bombillo cierre	1
30 92 05 60	Puxador duplo • Manilla doble	1
30 96 00 05	Esquadro aro porta • Escuadra marco puerta	2
30 96 00 15	Esquadro alinhamento móvel • Escuadra alineamiento hoja	4
30 96 00 36	Esquadro móvel porta • Escuadra hoja puerta	4
30 96 00 46	Esquadro alinhamento aro móvel porta • Escuadra alineamiento marco	4
30 96 00 49	Esquadro alinhamento aro fixo • Escuadra alineamiento marco	2
30 96 00 10	Jogo topos ARI-23 • Juego topes ARI-23	1
31 03 40 00	Mola para pingadeira • Grapa para vierteaguas	A cada 200 mm
30 96 00 35	Canto vulcanizado • Angulo vulcanizado	2
30 92 05 00	Jogo topos AZ-60 • Juego topes AZ-60	1
30 93 00 80	Junta inferior • Junta inferior	L
30 93 00 84	Junta para pingadeiras AZ-60 e AZ-70 • Junta para vierteaguas AZ-60 e AZ-70	L
30 96 00 02	Junta exterior • Junta exterior	L+2H
30 96 00 03	Junta central • Junta central	L+2H
30 93 01 20	Junta interior • Junta interior	L+2H
---	Junta exterior vidro • Junta exterior vidrio	2L+2H
---	Junta interior vidro • Junta interior vidrio	2L+2H

VIDRO • VIDRIO

Hv = H-200 mm	Lv = L-230 mm
---------------	---------------

Porta 2 folhas abertura exterior • Puerta 2 hojas apertura exterior

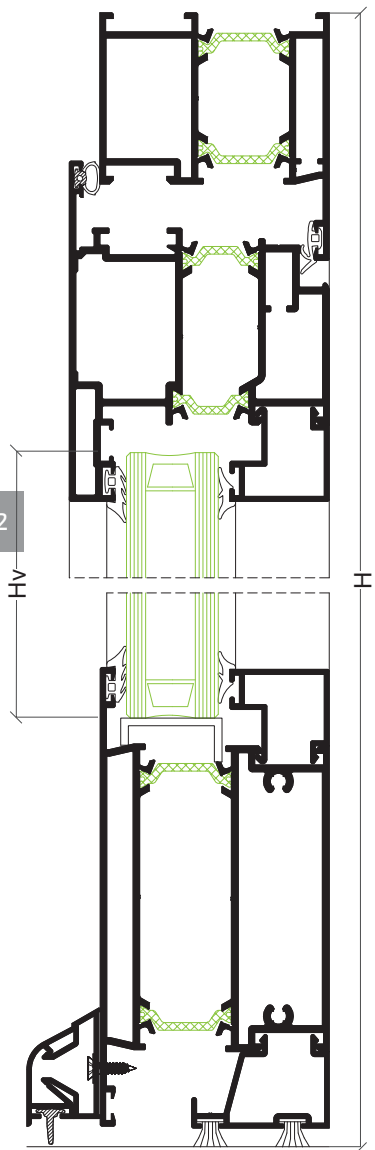
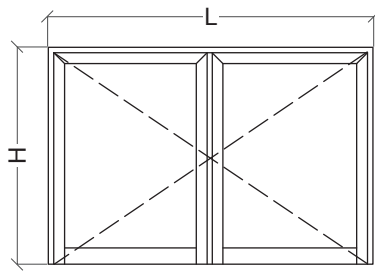

PERFIS • PERFIS

DESENHO • DISEÑO	REF.	DESCRIÇÃO • DESCRIPCIÓN	CORTE • CORTE	QUANTIDADE CANTIDAD	MEDIDAS • MEDIDA
	ARI-08	Aro fixo • Marco puerta		1	L
				2	H
	ARI-72	Aro móvel abertura exterior • Hoja apertura exterior		2	L/2-41.5 mm
				4	H-44 mm
	ARI-04	Inversor • Inversor		1	H-78 mm
	ARI-12	Travessa • Zócalo 120x60mm		2	L/2-169.5 mm
	AX-15	Bite remate • Junquillo acople		2	L/2-160.5 mm
	---	Bite • Junquillo		4	L/2-179 mm
				4	H-253 mm
	AZ-60	Pingadeira • Vierendeaguas puerta		1	L/2-112.5 mm
				1	L/2-43 mm
	AZ-61	Suplemento para pingadeira Complemento para vierendeaguas		2	L/2-219.5 mm

ACESSÓRIOS E JUNTAS • ACCESORIOS Y JUNTAS

REF.	DESCRIÇÃO • DESCRIPTION	QUANTIDADE CANTIDAD
30 92 01 20	Jogo fecho C.E. • Juego cierre C.E.	1
30 92 05 10	Fechadura 3 pontos • Cierre 3 puntos	1
30 92 05 50	Canhão fechadura 30x40 • Bombillo cierre 30x40	1
30 92 05 60	Puxador duplo • Manilla doble	1
30 96 00 05	Esquadro porta • Escuadra puerta	2
30 96 00 08	Jogo topos inversor • Juego topos inversor	1
30 92 00 20	Dobradiça C.E. • Bisagra C.E.	6
30 95 00 10	Pelúcia 7x9 mm • Burlete 7x9 mm	2L
30 95 05 00	Jogo topos AZ-60 • Juego topos AZ-60	1
30 92 03 90	Esquadro móvel exterior • Escuadra hoja exterior	4
30 92 01 35	Esquadro alinhamento móvel • Escuadra alineamiento hoja	4
30 96 00 15	Esquadro alinhamento móvel exterior • Escuadra alineamiento hoja exterior	4
30 96 00 45	Esquadro móvel interior • Escuadra hoja interior	4
30 96 00 49	Esquadro móvel exterior • Escuadra hoja exterior	2
30 93 00 84	Junta para pingadeiras AZ-60 e AZ-70 • Junta para vierendeaguas AZ-60 e AZ-70	L
30 93 01 20	Junta exterior • Junta exterior	2L
30 96 00 02	Junta interior • Junta interior	L+4H
---	Junta exterior vidro • Junta exterior vidrio	2L+4H
---	Junta interior vidro • Junta interior vidrio	2L+4H

VIDRO • VIDRIO

Hv = H-228 mm	Lv = L/2-194 mm
---------------	-----------------

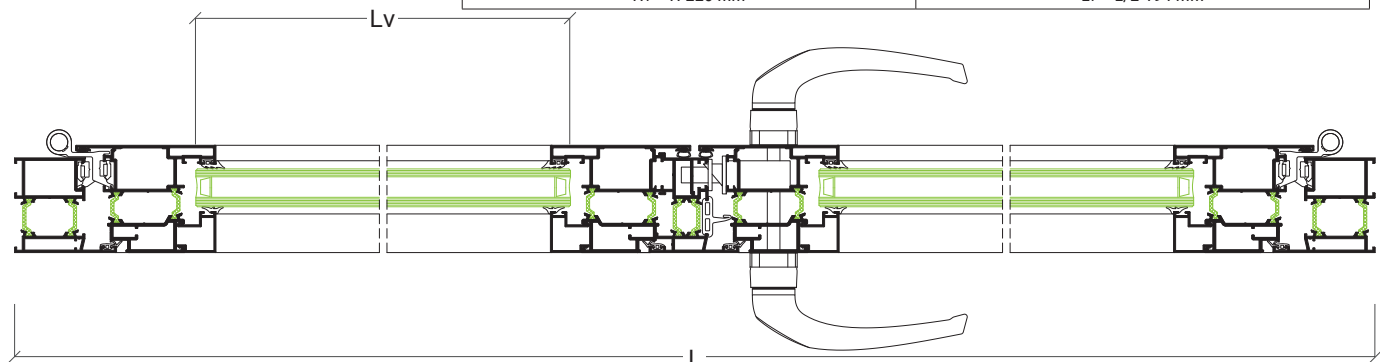

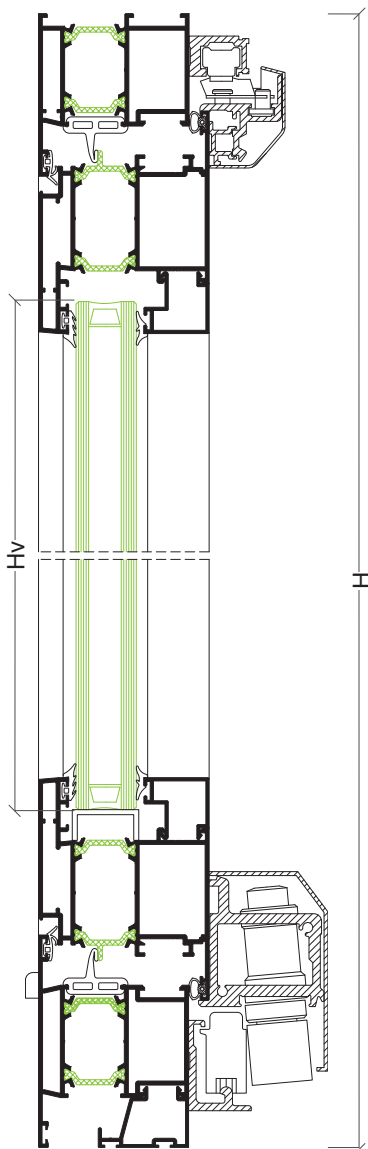
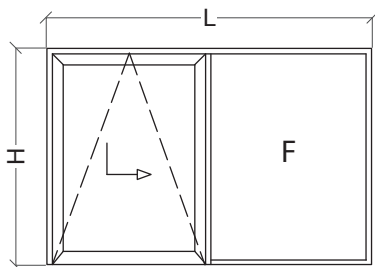
Porta oscilo-paralela com fixo lateral • Puerta oscilo-paralela con fijo lateral

PERFIS • PERFIS

DESENHO • DESEÑO	REF.	DESCRIÇÃO • DESCRIPCIÓN	CORTE • CORTE	QUANTIDADE CANTIDAD	MEDIDAS • MEDIDA
	ARi-08	Aro fixo • Marco puerta		1	L
				2	H
	ARi-06	Travessa • Travesaño puerta		1	L-80.5 mm
				1	H-100.5 mm
	ARi-36	Aro móvel • Hoja		2	L1-55.5 mm
				4	H-98 mm
	---	Bite (folha) • Junquillo (hoja)		2	L1-193 mm
				2	H-275.5 mm
	---	Bite (fixo) • Junquillo (fijo)		2	L2-67.5 mm
				2	H-150 mm
	AX-15	Bite remate • Junquillo acople		1	L-90 mm
	AX-19	Varetta • Pletina falleba		1+1	Aprox. L+H

ACESSÓRIOS E JUNTAS • ACCESORIOS Y JUNTAS

REF.	DESCRIÇÃO • DESCRIPTION	QUANTIDADE CANTIDAD
30 92 01 00	Goteiras • Tapa salida de aguas	4
30 92 01 35	Esquadro alinhamento móvel • Escuadra alineamiento hoja	4
30 92 01 50	União topos porta • Unión topes puerta	4
30 96 00 05	Esquadro aro fixo • Escuadra marco	2
30 96 00 15	Esquadro alinhamento móvel • Escuadra alineamiento hoja	4
30 96 00 36	Esquadro aro móvel • Escuadra hoja	4
30 96 00 46	Esquadro alinhamento exterior aro móvel • Escuadra alineamiento exterior hoja	4
30 96 00 49	Esquadro alinhamento aro fixo • Escuadra alineamiento marco	2
---	Kit oscilo-paralela • Kit oscilo-paralela	1
30 96 00 35	Canto vulcanizado • Angulo vulcanizado	4
30 96 00 02	Junta exterior • Junta exterior	2L1+2H
30 96 00 03	Junta central • Junta central	2L1+2H
30 93 01 20	Junta interior • Junta interior	2L1+2H
---	Junta exterior vidro • Junta exterior vidrio	2L+2H
---	Junta interior vidro • Junta interior vidrio	2L+2H

VIDRO • VIDRIO







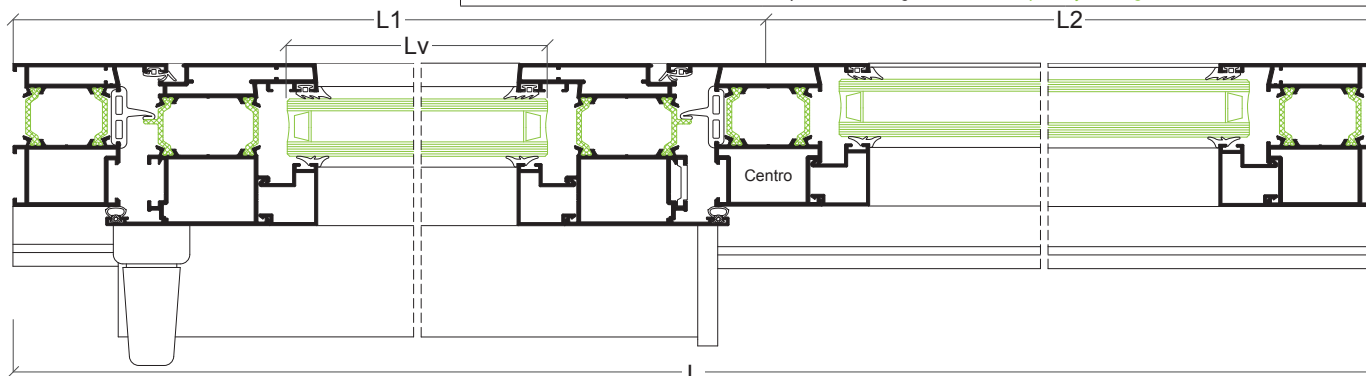

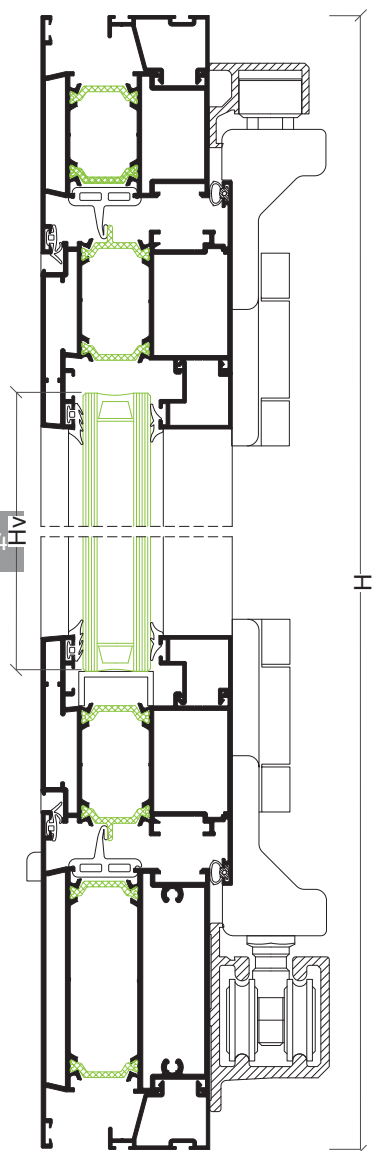
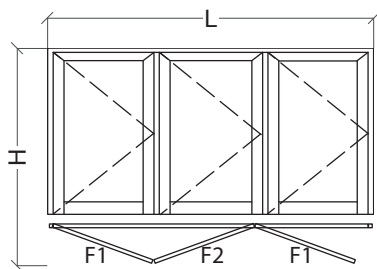



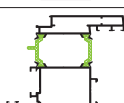
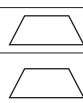

Hv folha = H-249 mm • Hv hoja = H-249 mm	Lv folha = L1-206 mm • Lv hoja = L1-206 mm
Hv fixo = H-124 mm • Hv fijo = H-124 mm	Lv fixo = L2-81 mm • Lv fijo = L2-81 mm

	Mínimo • Mínimo	Máximo • Máximo
Largura da folha • Largo da hoja	700mm	1650 mm
Altura da folha • Alto da hoja	850 mm	2400 mm

Peso máximo por folha 160 kg • **Peso máximo por hoja 160 kg**



Porta 3 folhas harmónio • Puerta 3 hojas harmónico

PERFIS • PERFIS

DESENHO • DISEÑO	REF.	DESCRIÇÃO • DESCRIPCIÓN	CORTE • CORTE	QUANTIDADE CANTIDAD	MEDIDAS • MEDIDA
	ARi-08	Aro fixo • Marco		2	H
	ARi-06	Travessa • Travessaño		1	L-80.5 mm
	ARi-12	Travessa • Travessaño		1	L-80.5 mm
	ARi-36	Aro móvel • Hoja		6	consultar •
	ARi-04	Inversor • Inversor		2	consultar •
	---	Bite (folha) Bite (hoja)		6	consultar •
	AX-15	Bite remate • Bite solape		2	L-90 mm
	AX-19	Vareta • Pletina falleba		2	2H

ACESSÓRIOS E JUNTAS • ACCESORIOS Y JUNTAS

REF.	DESCRIÇÃO • DESCRIPTION	QUANTIDADE CANTIDAD
30 92 01 00	Goteiras • Tapa salida de agua	6
30 92 01 35	Esquadro alinhamento aro móvel • Escuadra alineamiento hoja	12
30 96 00 08	Jogo topos inversor • Juego topes inversor	2
30 96 00 15	Esquadro alinhamento aro móvel • Escuadra alineamiento hoja	12
30 96 00 36	Esquadro aro móvel porta • Escuadra hoja puerta	12
30 96 00 46	Esquadro alinhamento exterior porta • Escuadra alineamiento exterior puerta	12
---	Kit harmónio (3+0) • Kit harmónio (3+0)	1
30 92 01 50	União topo porta • Unión tope puerta	2
30 92 01 20	Jogo fecho C.E. • Juego cierre C. E.	1
30 96 00 35	Canto vulcanizado • Canto vulcanizado	4
30 96 00 02	Junta exterior • Junta exterior	2L+6H
30 96 00 03	Junta central • Junta central	2L+4H
30 93 01 20	Junta interior • Junta interior	2L+6H
---	Junta exterior vidro • Junta exterior vidrio	2L+2H
---	Junta interior vidro • Junta interior vidrio	2L+2H

VIDRO • VIDRIO

	Lv Folha 1 = consultar	
	Lv Folha 2 = consultar	
	Mínimo • Mínimo	Máximo • Máximo
Largura da folha • Anchura da hoja	600 mm	900 mm
Altura da folha • Altura da hoja	850 mm	2400 mm
Peso máximo por folha 80 kg • Peso máximo por hoja 80kg		

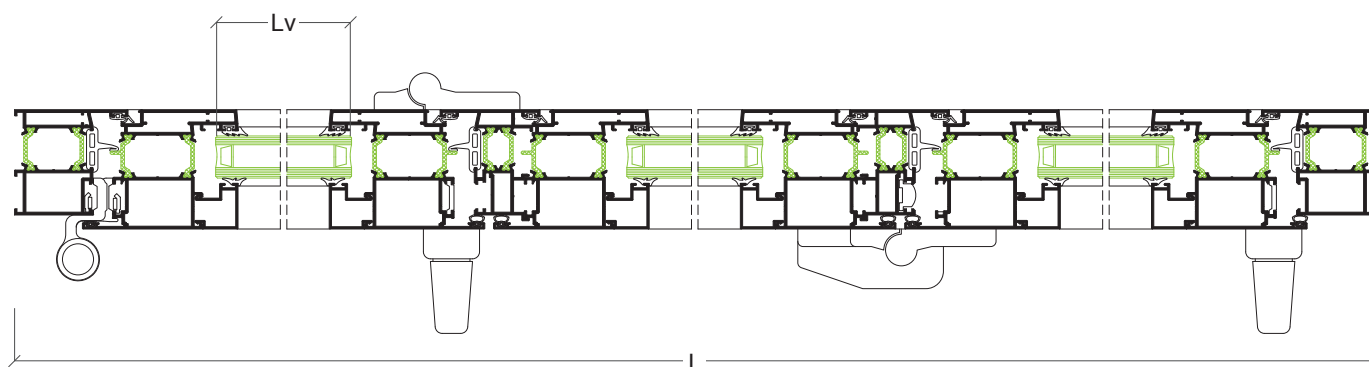

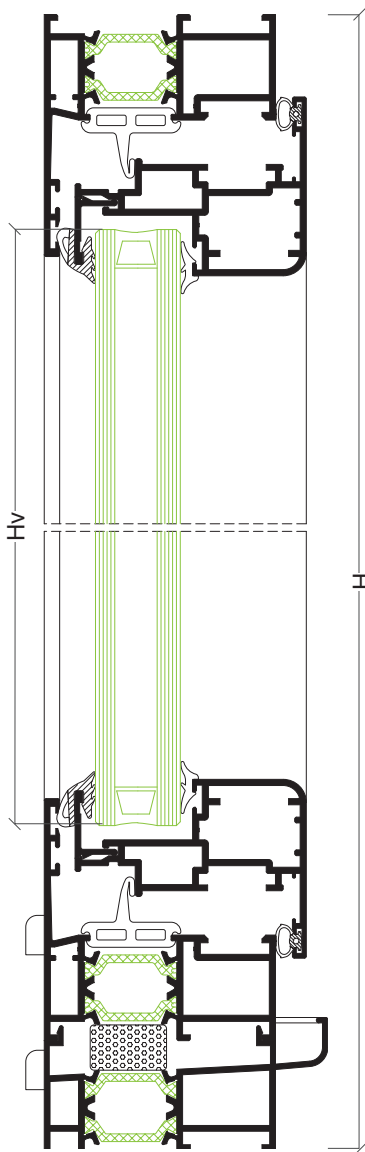
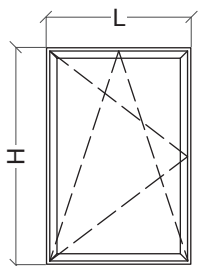
Janela 1 folha abrir e oscilo-batente • Puerta 1 hoja practicable y oscilobatiente

DESENHO • DESEÑO	REF.	DESCRIÇÃO • DESCRIPCIÓN	CORTE • CORTE	QUANTIDADE • CANTIDAD	MEDIDAS • MEDIDA
	ARI-43	Aro fixo folha oculta Marco hoja oculta		2	L
				2	H-28.5 mm
	ARI-45	Aro móvel folha oculta Hoja oculta		2	L-43 mm
				2	H-71.5 mm
	ARI-47	Bite folha oculta Junquillo hoja oculta		2	L-94 mm
				2	H-122.5 mm
	CT-11	Soleira condensação Condensación		1	L
	AX-19	Vareta • Pletina falleba		1+1	L+H

ACESSÓRIOS E JUNTAS • ACCESORIOS Y JUNTAS

REF.	DESCRIÇÃO • DESCRIPTION	QUANTIDADE • CANTIDAD	
		ABRIR PRATICABLE	OSCILO-BATENTE OSCILOBATIENTE
30 92 00 20	Dobradiças C.E. • Bisagras C.E.	2	---
30 92 01 00	Goteiras • <i>Tapa salida de aguas</i>	4	4
30 92 02 XX	Compasso O.B. • <i>Compás O.B.</i>	---	1
30 92 02 20	Kit oscilo-batente • <i>Kit oscilobatiente</i>	---	1
30 92 02 60	Apoio da folha • <i>Apoyo de la hoja</i>	1	---
30 92 03 10	Kit cremone • <i>Kit cremona</i>	1	---
30 96 00 04	Esquadro janela • <i>Escuadra ventana</i>	8	8
30 96 00 48	Esquadro alinhamento aro fixo • <i>Escuadra alineamiento marco</i>	4	4
30 96 00 12	Jogo topos condensação • <i>Juego topos condensación</i>	1	1
30 96 00 23	Esquadro alinhamento aro fixo • <i>Escuadra alineamiento marco</i>	4	4
30 96 00 24	Esquadro alinhamento aro móvel • <i>Escuadra alineamiento hoja</i>	4	4
30 96 00 22	Esquadro alinhamento interior móvel <i>Escuadra alineamiento interior hoja</i>	4	4
30 96 00 35	Canto vulcanizado • <i>Angulo vulcanizado</i>	4	4
30 92 04 70	Espuma isolante • <i>Espuma aislante</i>	L	
30 96 00 27	Junta exterior folha oculta • <i>Junta exterior hoja oculta</i>	2L+2H	
30 96 00 03	Junta central • <i>Junta central</i>	2L+2H	
30 93 01 20	Junta interior • <i>Junta interior</i>	2L+2H	
---	Junta interior vidro • <i>Junta interior vidrio</i>	2L+2H	

VIDRO • VIDRIO

Hv = H-139 mm	Lv = L-110 mm
---------------	---------------

