

CANAL 16
SISTEMA ARi

ROTURA TÉRMICA 60mm

SISTEMA ARi Canal 16

Sistema de batente com RPT - 60 mm

CARACTERÍSTICAS DO SISTEMA

O sistema ARi Canal 16 está desenhado com câmara de 16 mm para permitir a aplicação de ferragens especiais com afinação tridimensional para uma maior eficiência em termos de rendimento, desempenho e segurança.

O sistema ARi Canal 16 possibilita a execução de 2 versões de caixilharia: linha recta e linha rústica.

O sistema ARi Canal 16 permite a aplicação de vidros duplos ou triplos de alto rendimento de modo a responder aos requisitos de isolamento térmico e acústico, de acordo com a directiva nº 2010/31/EU.

Com um ótimo isolamento térmico aliado à aplicação de um inovador produto designado por ThermoProfile, o Sistema ARi Canal 16 proporciona elevadas prestações de conforto e de economia energética.

PERFIS DE ALUMÍNIO

Perfis com rotura térmica obtida por inserção de varetas isolantes de poliamida tipo ómega de 15 e 24 mm reforçadas com 25% de fibra de vidro.

Espessura média dos perfis de alumínio de 1,7 mm.

AROS FIXOS

Profundidade dos aros fixos de 60 mm com tripla câmara

Perfis com rotura térmica obtida através de varetas de poliamida tipo ómega de 24mm;

Aros fixos com duplo esquadro de aperto rápido e esquadros de alinhamento para montagem a meia esquadria;

Aros fixos para a versão rústica.

Aros fixos com clip exterior e remate directo de 25 mm ou 45 mm;

Aros fixos com clip exterior e interior para aplicação de remate de 30, 50, 65 ou 80mm;

AROS MÓVEIS

Profundidade dos aros móveis de 68 mm com tripla câmara;

Aros móveis com rotura térmica, obtida através de varetas de poliamida tipo ómega de 24 mm;

Folhas com duplo esquadro de aperto rápido e esquadros de alinhamento para montagem a meia esquadria;

Perfil inversor com olhal para uma melhor aplicação do topo inversor.

Aro móvel porta especial para portas de entrada, folha oculta, com um processo inovador de aplicação do painel substituível.

DIMENSIONAMENTO E MANOBRABILIDADE

Dimensões mínimas - máximas de folha: 391 mm - 1640 mm (L); 520 mm - 2840 mm (H);

Peso máximo para janelas ou portas de sacada com oscilobatente até 130 Kg;

Peso máximo para portas de entrada até 150 Kg/folha;

Possibilidades de abertura: fixo, abertura interior 1 ou 2 folhas com ou sem oscilobatente, abertura exterior, basculante, harmónio e oscilo-paralela;

Enchimento para vidro duplo ou triplo de 20 mm a 46 mm;

Três tipos de ferragens especiais para canal 16 com uma afinação tridimensional rápida e cómoda e com um tratamento superficial de alta qualidade:

• Ferragens UniJet C, UniJet D e UniJet CC Oculta.

Estanqueidade assegurada através de juntas em EPDM (interior e central); opção com junta exterior no aro fixo.

PERFORMANCES

Sistema certificado por laboratório notificado para Ensaio Tipo Inicial (ITT) de acordo com a norma de produto EN 14351-1:2006+A2:2019 para efeitos de Marcação CE.

Objetivo de categorias na avaliação do sistema ARi Canal 16:

1. Permeabilidade ao ar: Classe 4 (norma de ensaio EN 10207 e EN 1026)
2. Estanqueidade à água: Classe E1500 (norma de ensaio EN 12208 e EN 1027)
3. Resistência ao vento: Classe C5 (normas de ensaio EN 12210 e EN 12211)

Coefficiente de Transmissão térmica de vão de 2 folhas, Sistema ARi Canal 16, com 1.20m x 1.50m com vidro triplo Ug = 0.5 W/m²K, com intercalar efeito "Warm Edge":

• Uw = 1.16 W/m²K

Coefficiente de atenuação acústica de vão de 2 folhas Sistema ARi canal 16 com 1,20 m x 1,50m:

• Rw (C; Ctr) = 42 dB (-1; -4)

Zonas de aplicação segundo os regulamentos REH e RECS (em função do valor Ug): I1, I2, I3, V1, V2, V3.

SISTEMA ARi Canal 16

Sistema practicable con RPT - 60 mm

CARACTERÍSTICAS DEL SISTEMA

El sistema ARi Canal 16 está diseñado con cámara de 16 mm para permitir la aplicación de herrajes especiales con afinación tridimensional para una mayor eficiencia en términos de rendimiento, desempeño y seguridad.

El sistema ARi Canal 16 posibilita la ejecución de 2 versiones de carpintería: línea recta y línea rústica.

El sistema ARi permite la aplicación de vidrios dobles o triplos de alto rendimiento por forma a responder a los requisitos de aislamiento térmico y acústico, de acuerdo con la directiva nº 2010/31/EU.

Con un óptimo aislamiento térmico aliado a la aplicación de un innovador producto llamado ThermoProfile, el Sistema ARi Canal 16 proporciona elevadas prestaciones de confort y de economía energética.

PERFILES DE ALUMINIO

Perfiles con rotura térmica obtenida por inserción de varillas aislantes de poliamida tipo ómega de 18, 24, 30 mm reforzadas con 25% de fibra de vidrio.

Espesor medio de los perfiles de aluminio de 1,7 mm.

MARCOS

Profundidad de los marcos de 60 mm con triple cámara

Perfiles con rotura térmica obtenidas a través de varillas de poliamida tipo ómega de 24 mm;

Marcos con doble escuadra de rápido agarre y escuadras de alineamiento para montaje a englete;

Marcos rústicos;

Marcos con clip exterior y solape directa de 25 mm o 45 mm;

Marcos con clip exterior e interior para aplicación de solape de 30, 50, 65 o 80 mm;

HOJAS

Profundidad de las hojas de 68mm con triple cámara;

Hojas con rotura térmica, obtenidas a través de varillas de poliamida tipo ómega de 24mm;

Hojas con doble escuadra de rápido agarre y escuadras de alineamiento para montaje a englete;

Perfil inversor con agujero para una mejor aplicación del tope inversor;

Hojas puerta especial para puertas de entrada, hoja oculta, con un proceso innovador de aplicación del panel substituível;

DIMENSIONAMIENTO Y MANIOBRABILIDAD

Dimensiones mínimas - máximas de hoja: 391 mm - 1640 mm (L); 520 mm - 2840 mm (H);

Peso máximo para ventanas o puertas de balconera con oscilobatiente hasta 130 Kg;

Peso máximo para puertas de entrada hasta 150 Kg/hoja;

Possibilidades de abertura: fijo, practicable interior 1 o 2 hojas con oscilobatiente, exterior, abatible, proyectante, pivotante, plegable y oscilo-paralela;

Acrilamiento para doble o triple vidrio de 20 mm a 46 mm;

Tres tipos de herrajes especiales para canal 16 con una afinación tridimensional rápida, cómoda y con un tratamiento superficial de alta calidad:

• Herrajes UniJet C, UniJet D y UniJet CC Oculta.

Estanqueidad asegurado a través de juntas triples de EPDM (interior y central); opción con junta exterior en el marco.

ENSAYOS

Sistema certificado por laboratorio acreditado, notificado para Ensayos Tipo Inicial (ITT) de acuerdo con la norma de producto EN 14351-1:2006+A2:2019 para efectos de Marcado CE.

Objetivo de categorías alcanzadas en los ensayos del sistema ARi Canal 16:

1. Permeabilidad al aire: Clase 4 (norma de ensayo EN 10207 y EN 1026)
2. Estanqueidad al agua: Clase E1500 (norma de ensayo EN 12208 y EN 1027)
3. Resistencia al viento: Clase C5 (norma de ensayo EN 12210 y EN 12211)

Coefficiente de transmisión térmica de ventana de 2 hojas, Sistema ARi Canal 16, con 1.20m x 1.50m con vidrio triple Ug = 0.5 W/m²K, con intercalar efecto "Warm Edge":

• Uw = 1.16 W/m²K

Coefficiente de atenuación acústica de ventana 2 hojas Sistema de ARi Canal 16 con 1,20 m x 1,50 m:

• Rw (C; Ctr) = 42 dB (-1; -4)

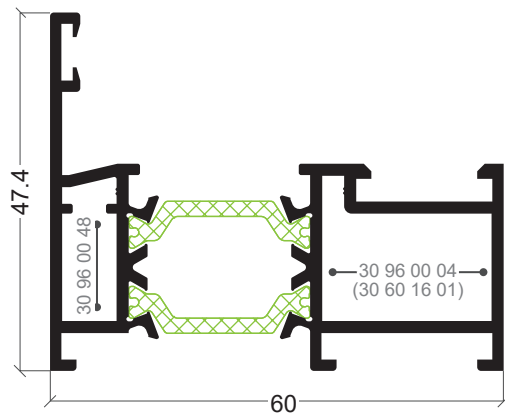

ARi-03

Aro fixo
Marco ventana

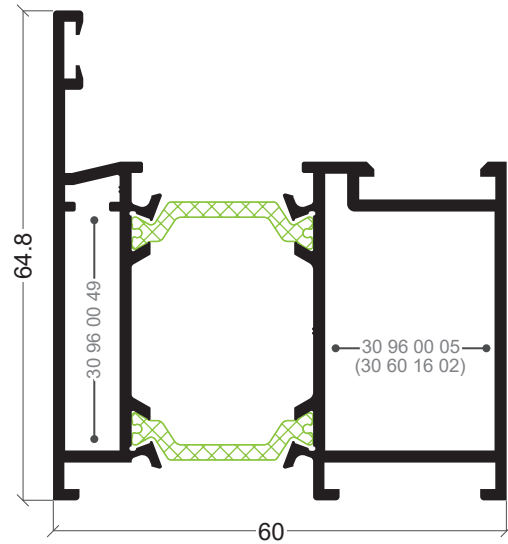

ARi-08

Aro fixo
Marco puerta

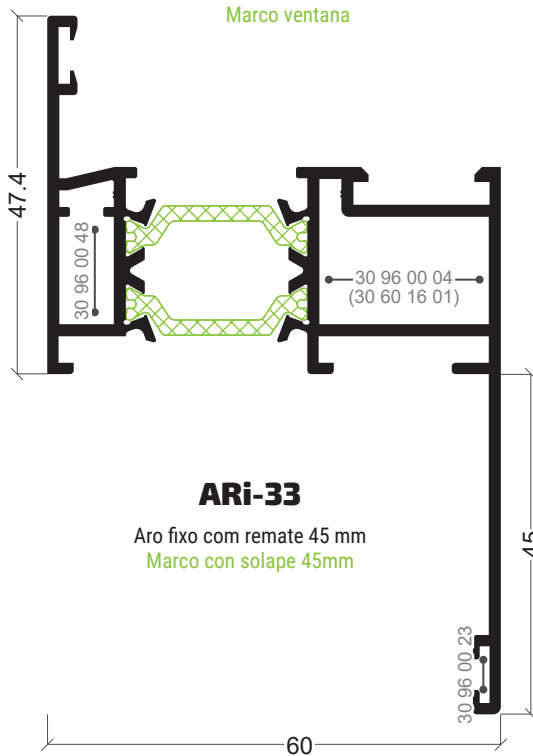

ARi-33

Aro fixo com remate 45 mm
Marco con solape 45mm

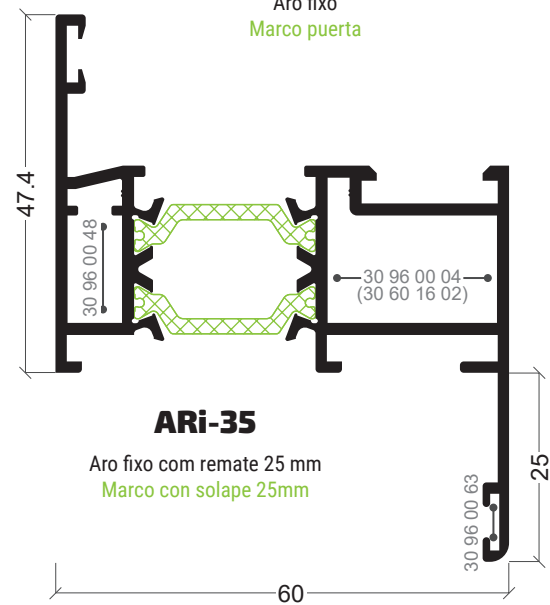

ARi-35

Aro fixo com remate 25 mm
Marco con solape 25mm

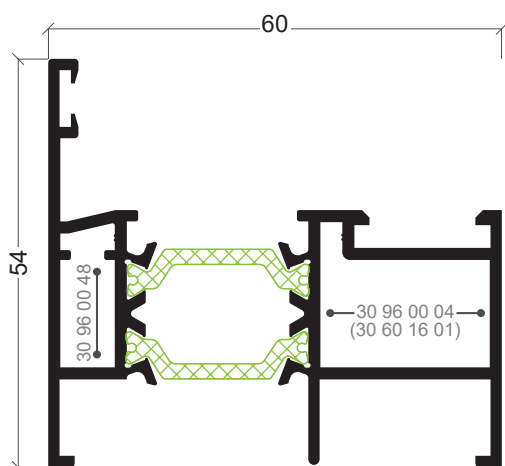

ARi-81

Aro fixo
Marco intermedio

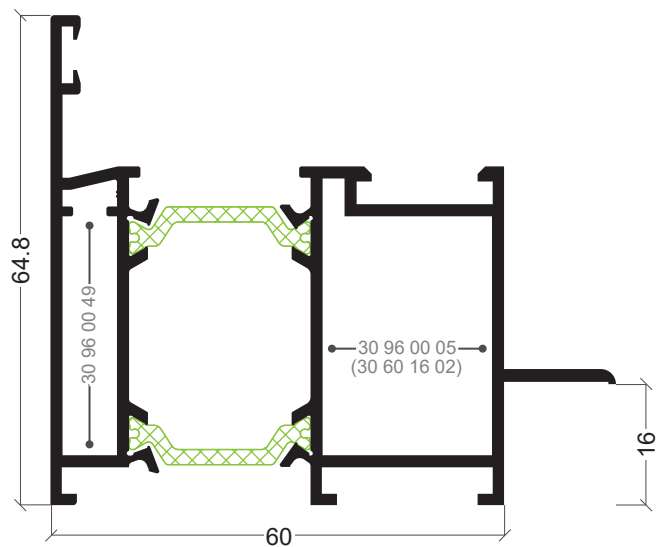

ARi-68

Aro fixo para apainelado
Marco puerta con precerco

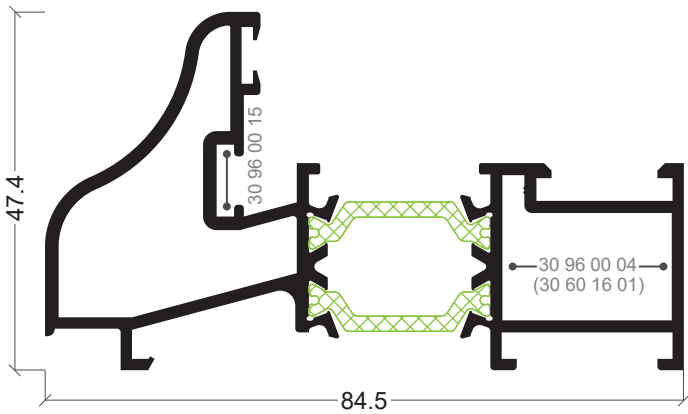

ARi-57

Aro fixo tradição
Marco rústico

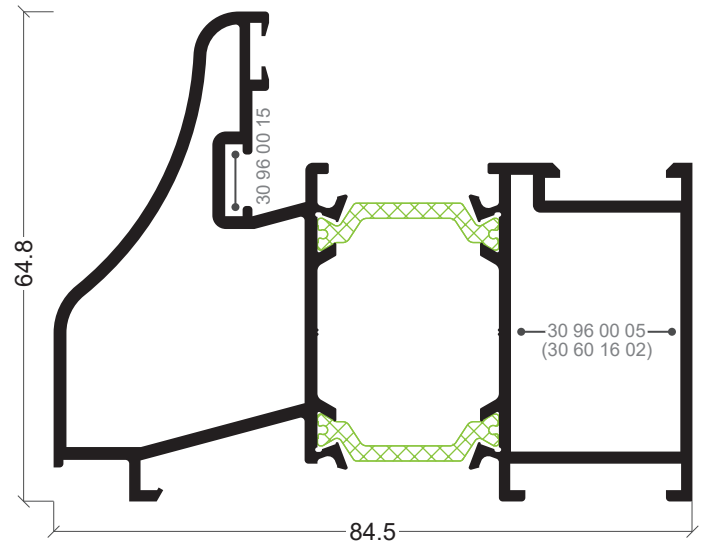

ARi-59

Aro fixo tradição
Marco rústico

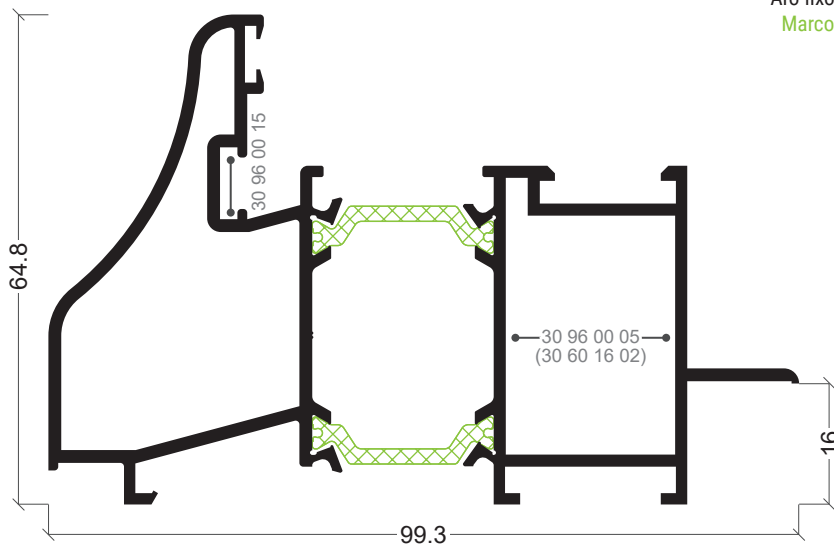

ARi-69

Aro fixo tradição para apanelado
Marco con precerco

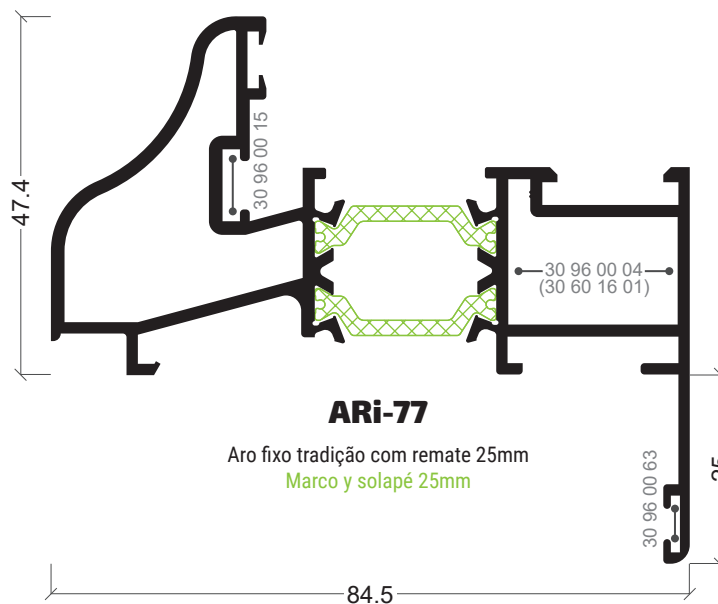

ARi-77

Aro fixo tradição com remate 25mm
Marco y solapé 25mm

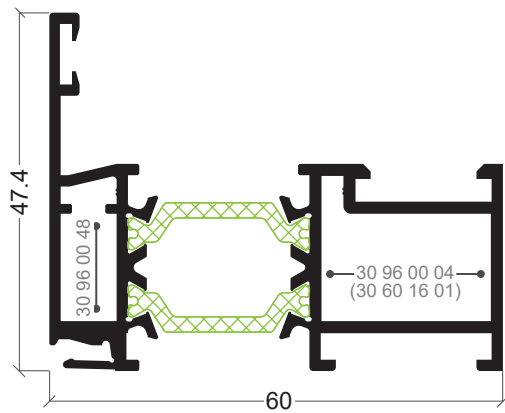

ARi-76

Aro fixo
Marco com enganche exterior

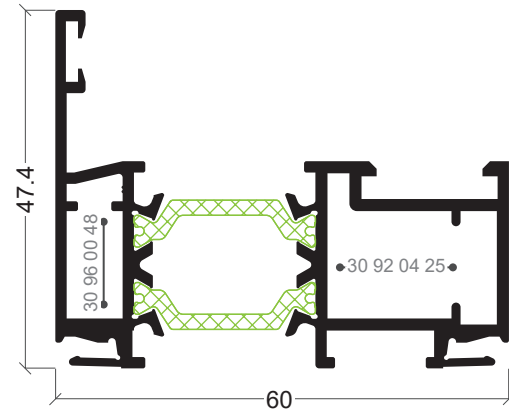

ARi-80

Aro fixo
Marco com enganche int./ext.

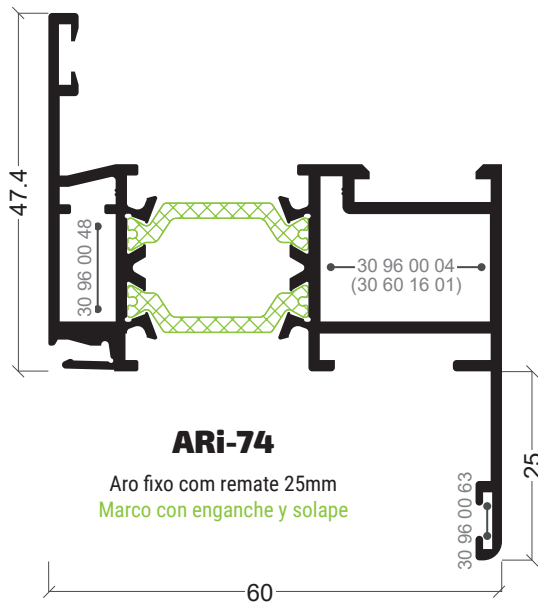

ARi-74

Aro fixo com remate 25mm
Marco com enganche y solape

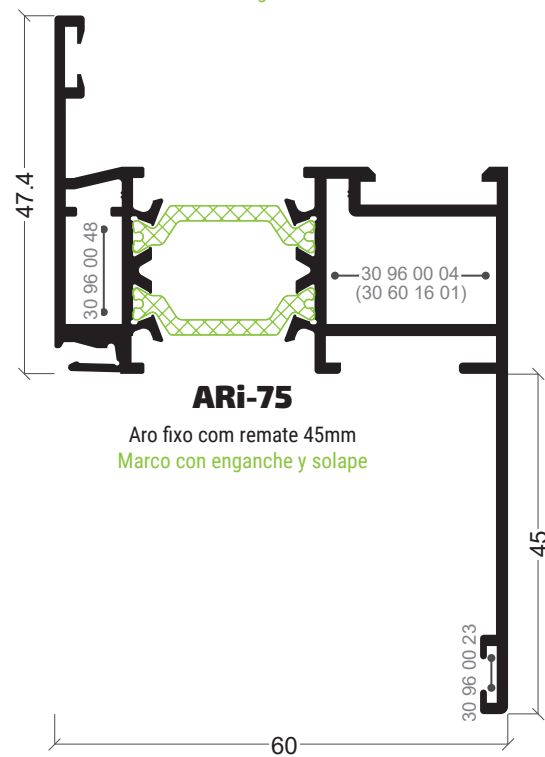

ARi-75

Aro fixo com remate 45mm
Marco com enganche y solape

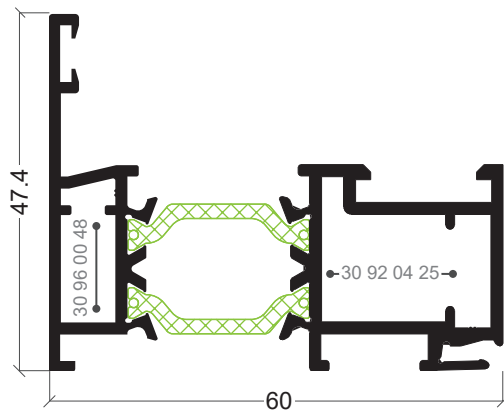

ARi-91

Aro fixo
Marco com enganche interior

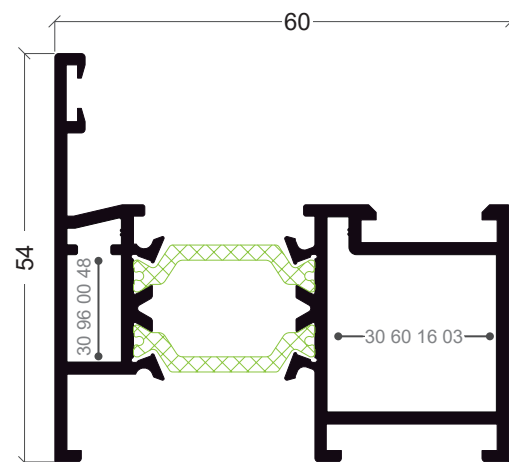

ARi-125

Aro fixo porta
Marco puerta

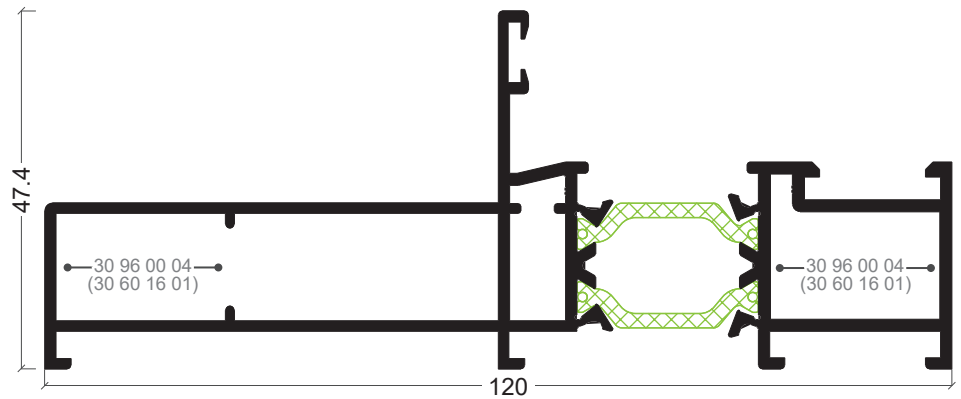

ARi-89

Aro fijo
Marco ventana

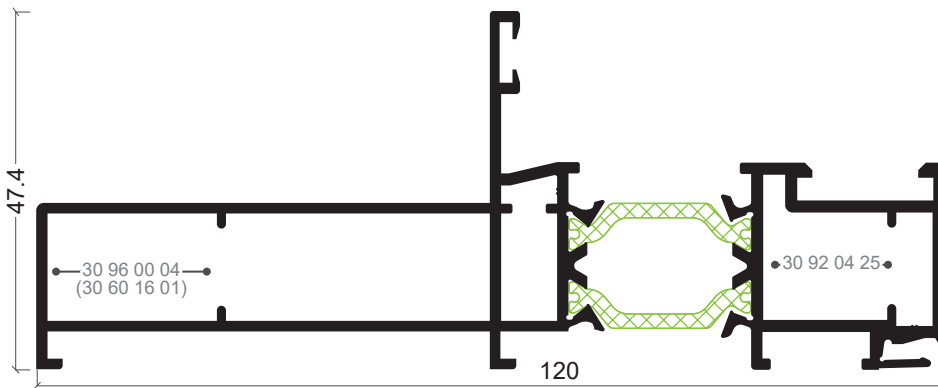

ARi-88

Aro fijo
Marco con enganche interior

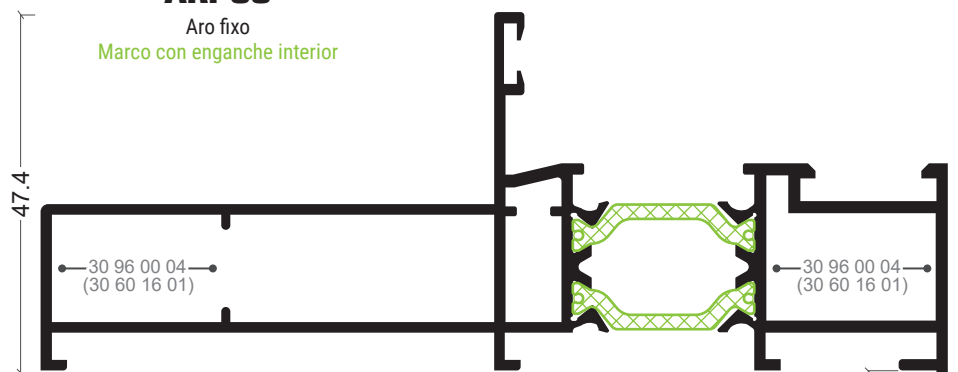

ARi-86

Aro fijo con remate 25mm
Marco con solape 25mm

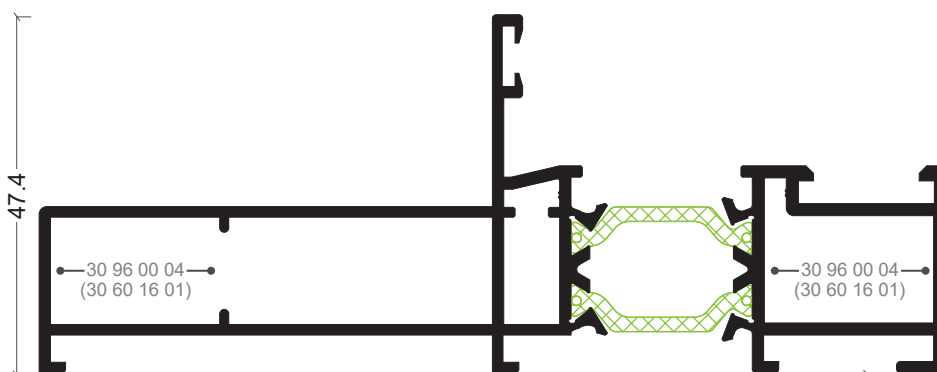
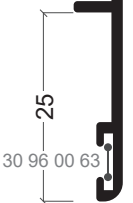

ARi-87

Aro fijo con remate 45mm
Marco con solape 45mm

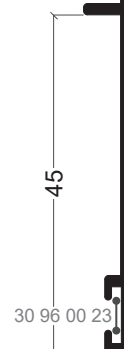

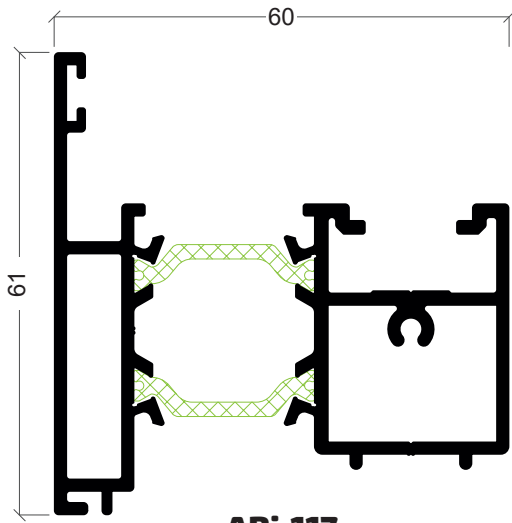

ARi-117

Inversor
Inversor

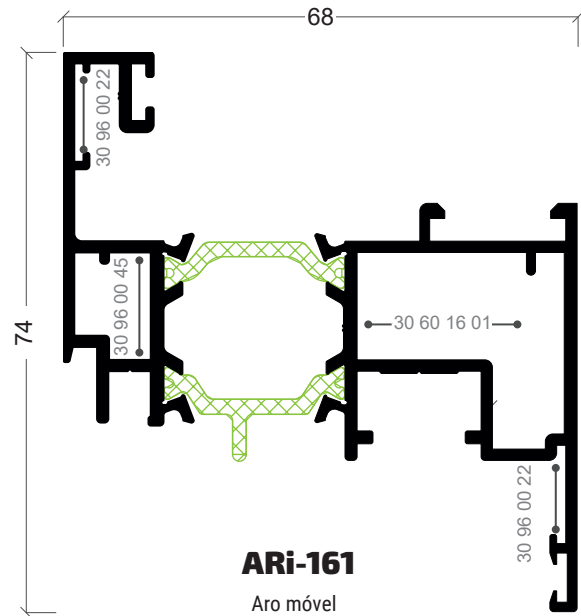

ARi-161

Aro móvel
Hoja

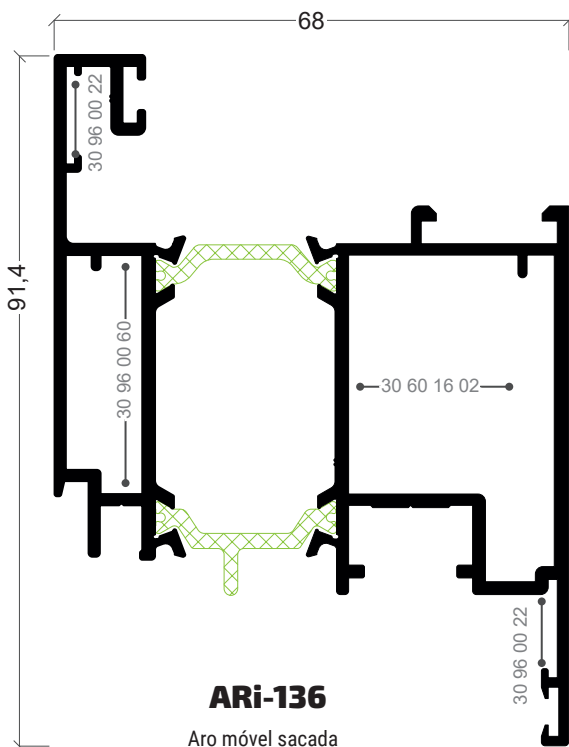

ARi-136

Aro móvel sacada
Hoja balconera

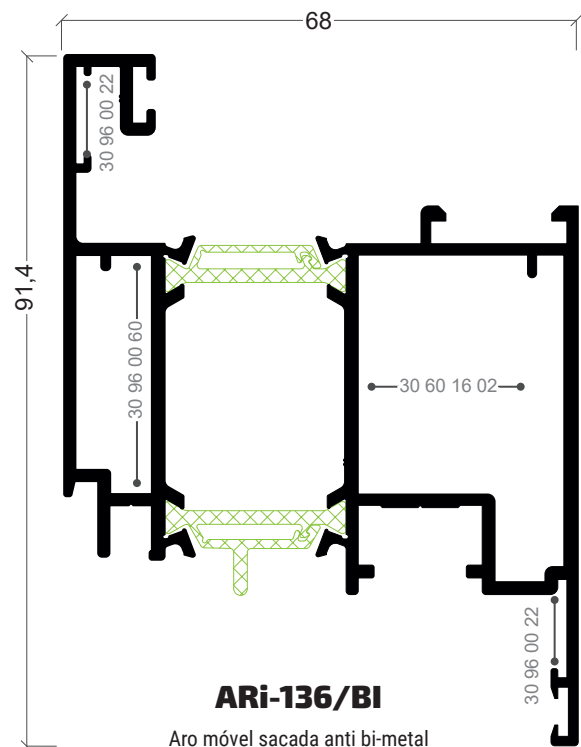

ARi-136/BI

Aro móvel sacada anti bi-metal
Hoja balconera anti bimetálica

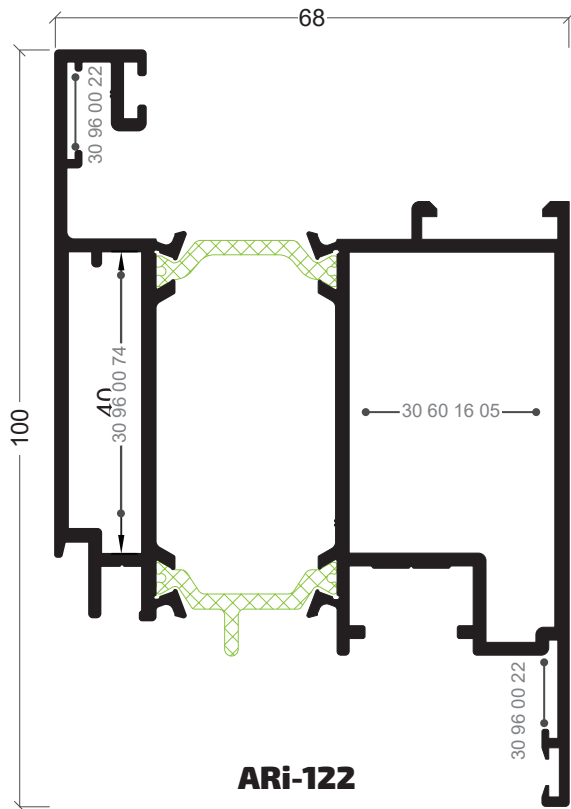

ARi-122

Aro Móvel Porta
Hoja puerta

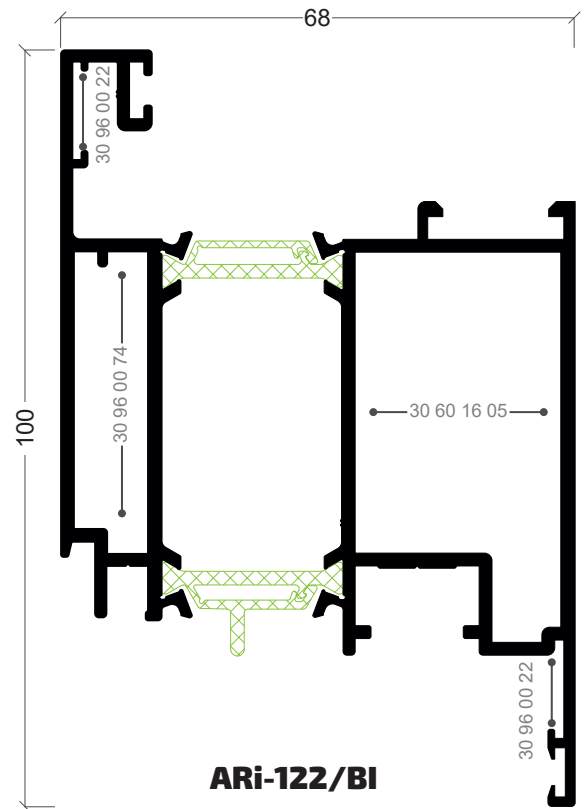

ARi-122/BI

Aro Móvel Porta Anti Bi-Metal
Hoja puerta anti bimetal

8

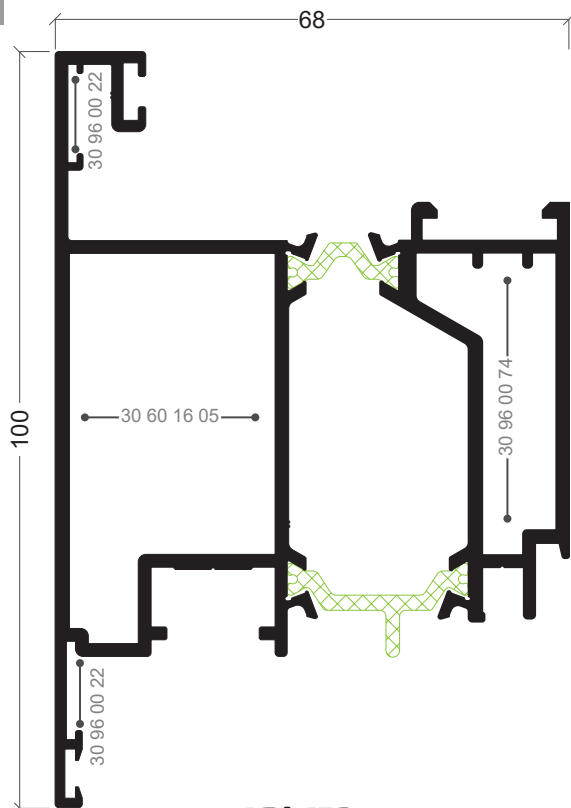

ARi-172

Aro Móvel Porta Exterior
Hoja Puerta Exterior

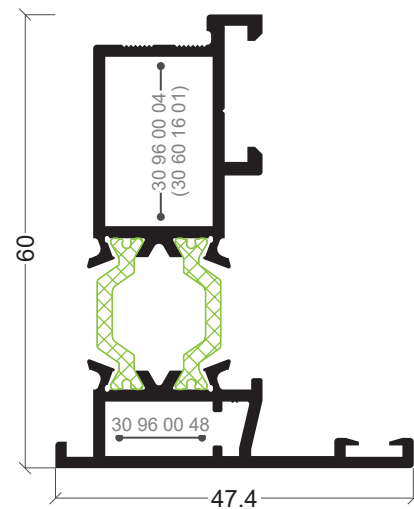

ARi-73

Inversor de sentido de abertura
Inversor de sentido de apertura



FX-38

Tampa
Tapa

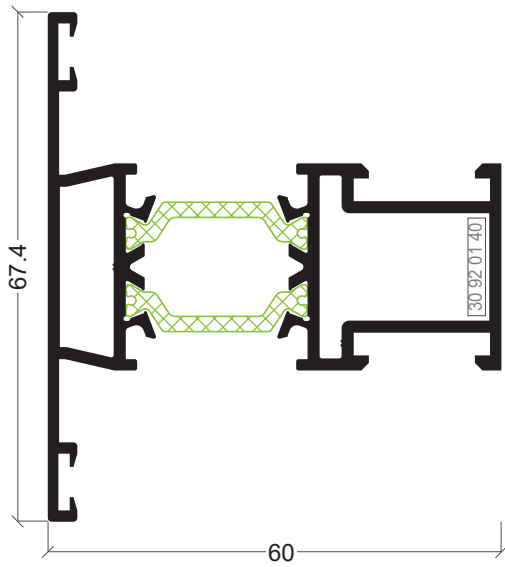

ARi-01
Traveça
Travesaño

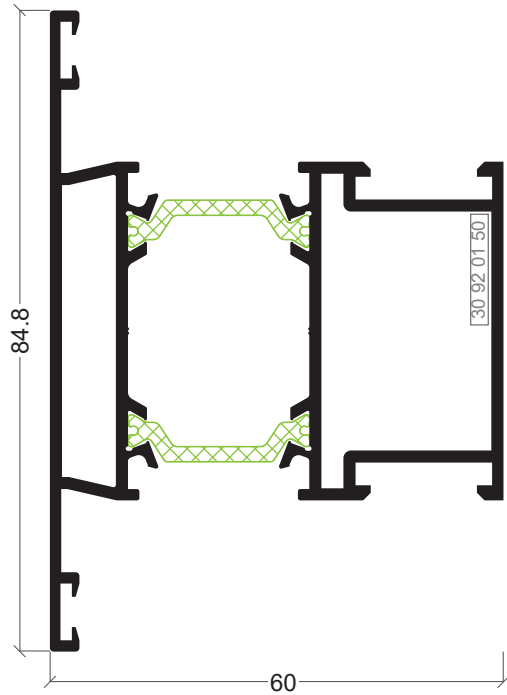

ARi-06
Traveça
Travesaño

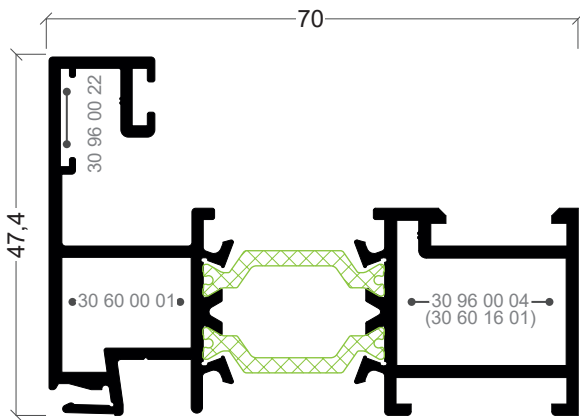

ARi-111
Aro Fixo Rústico
Marco Rustico

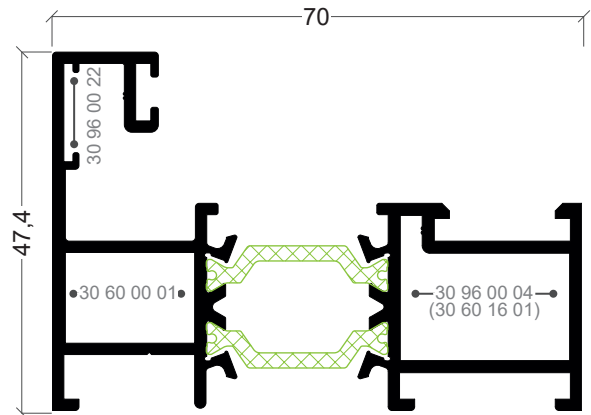

ARi-108
Aro Fixo Rústico
Marco Rustico

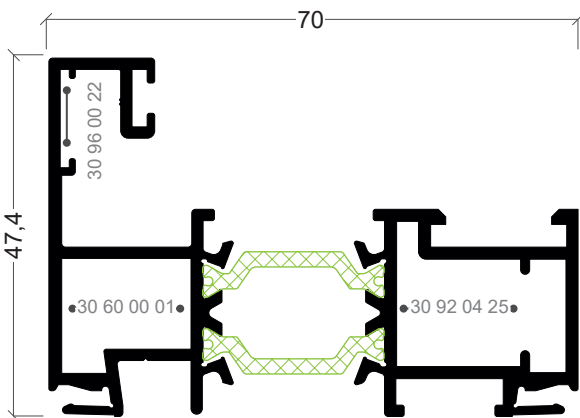

ARi-112
Aro Fixo Rústico
Marco Rustico

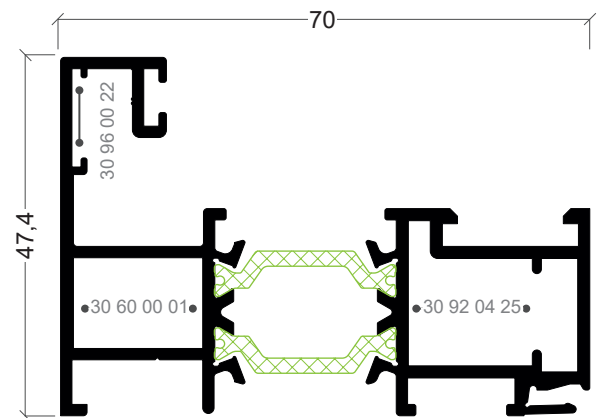

ARi-109
Aro Fixo Rústico
Marco Rustico

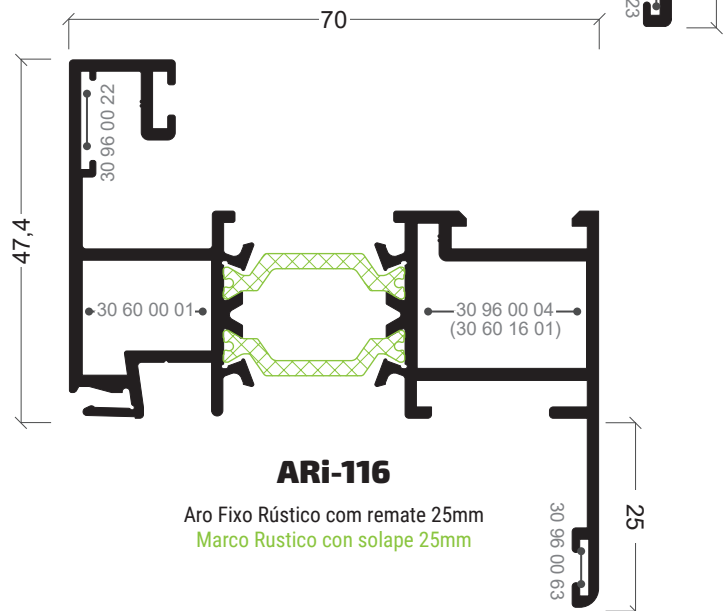
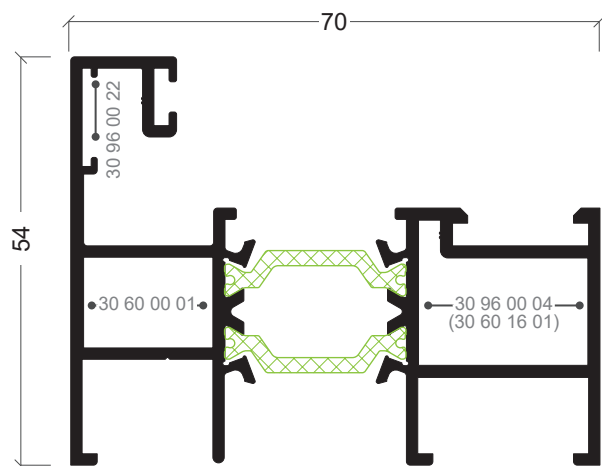
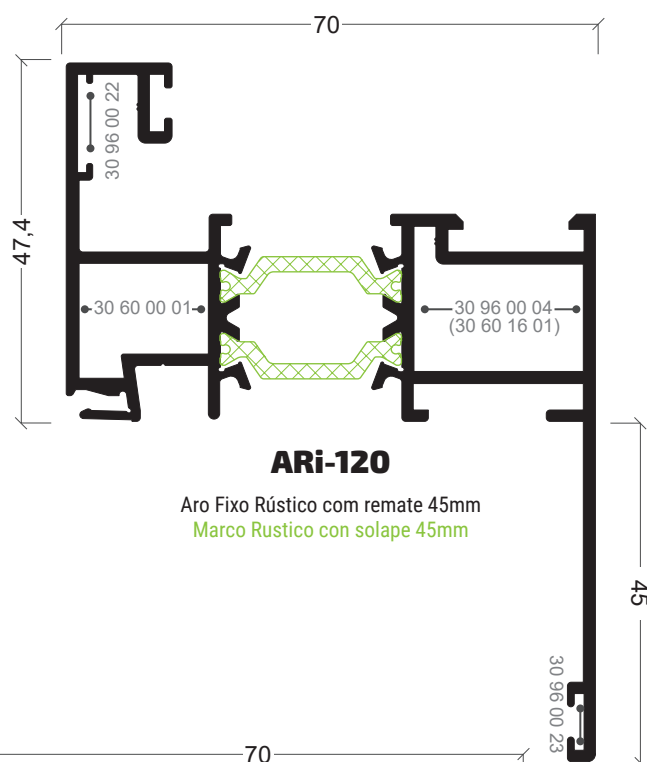
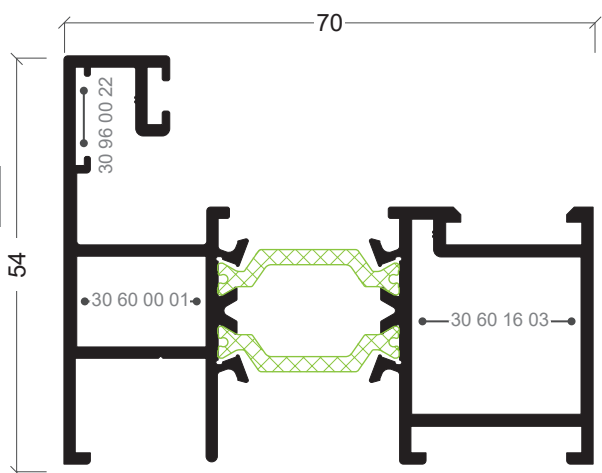
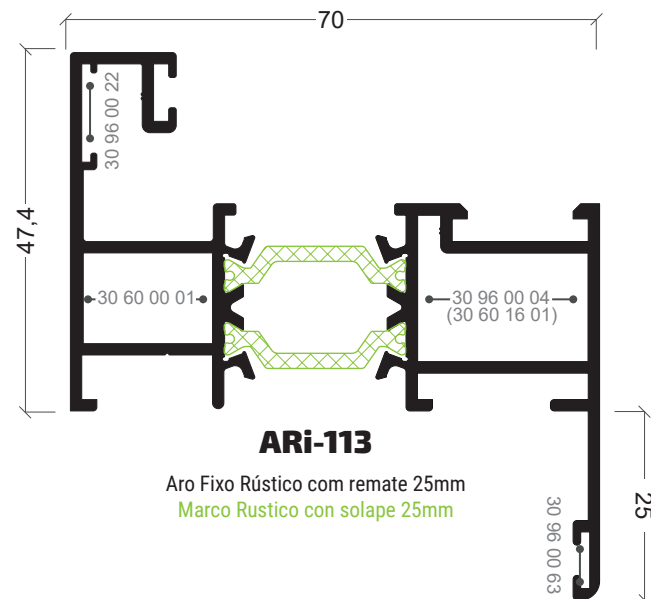
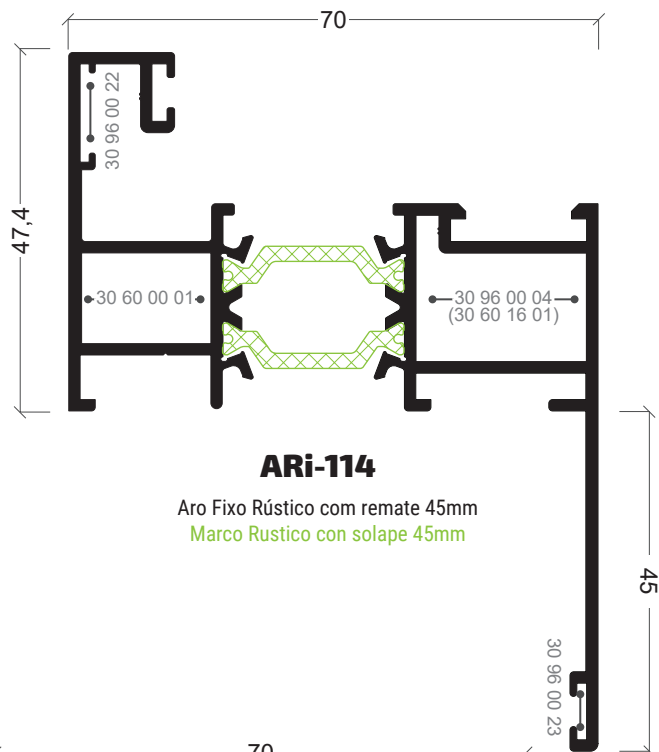

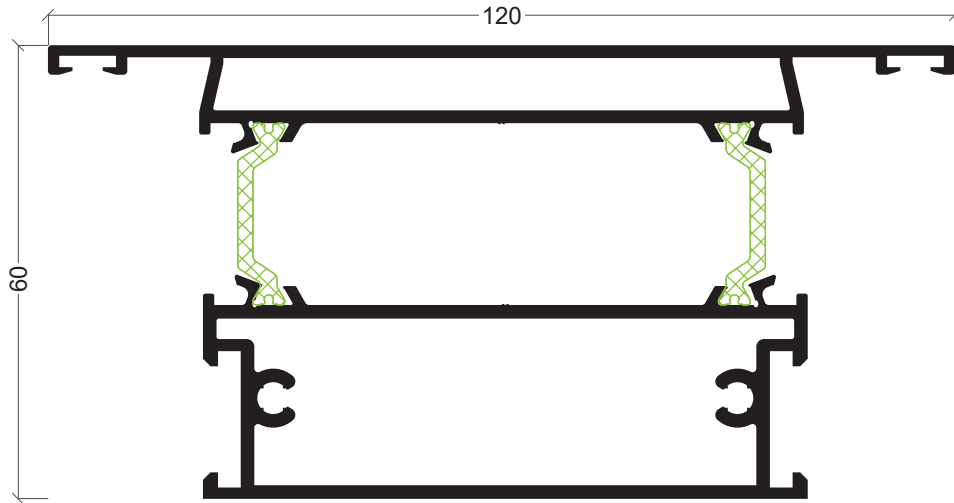

ARi-12

Travessa 120x60mm
Zócalo 120x60mm



S-38

Remate de Clip
Acople de Clip

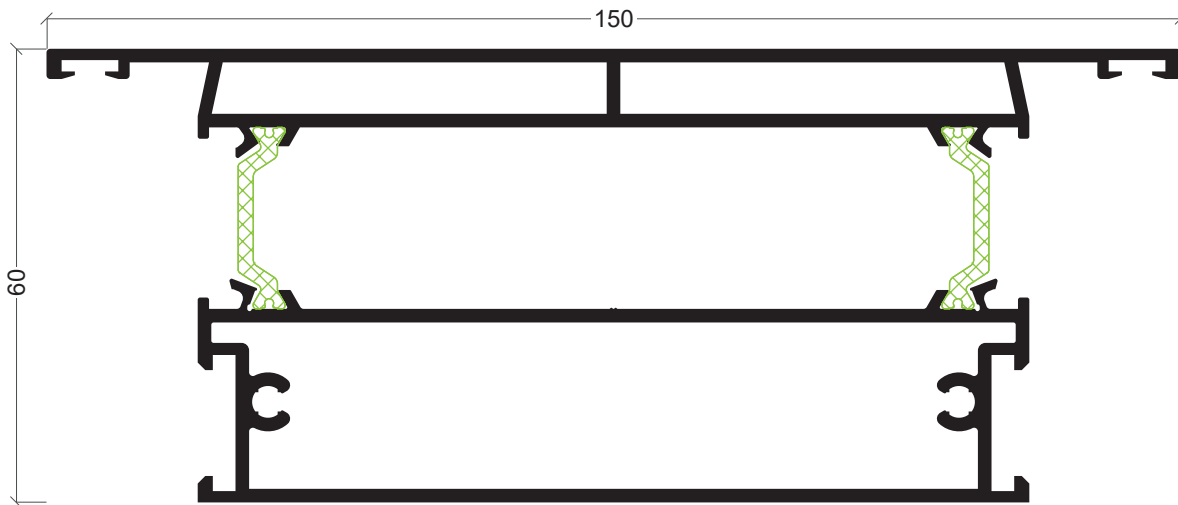

ARi-13

Travessa
Zócalo 150x60mm

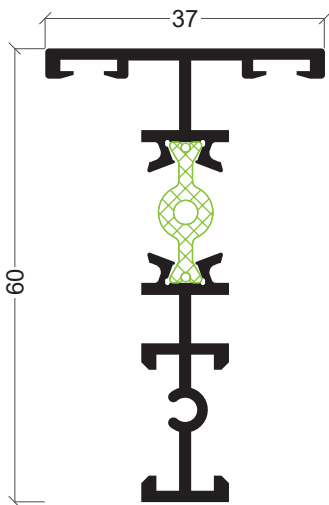

ARi-40

Divisor de vidro
Divisoria de vidro

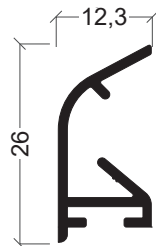

AZ-60

Pingadeira
Vieriteguas

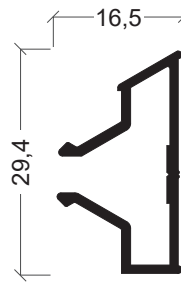

AZ-61

Clip Pingadeira
Clip Vieriteguas

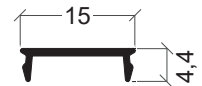

KL-04

Tampa
Tapa



CT-94

Perfil de união
Perfil de unión

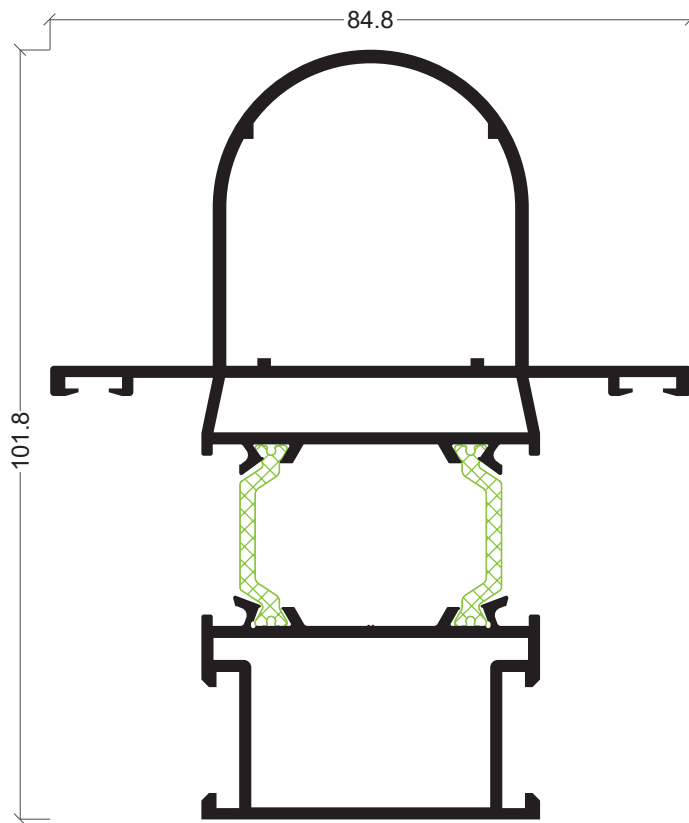

ARi-17

Montante curvo
Rigidizador 102mm curvo

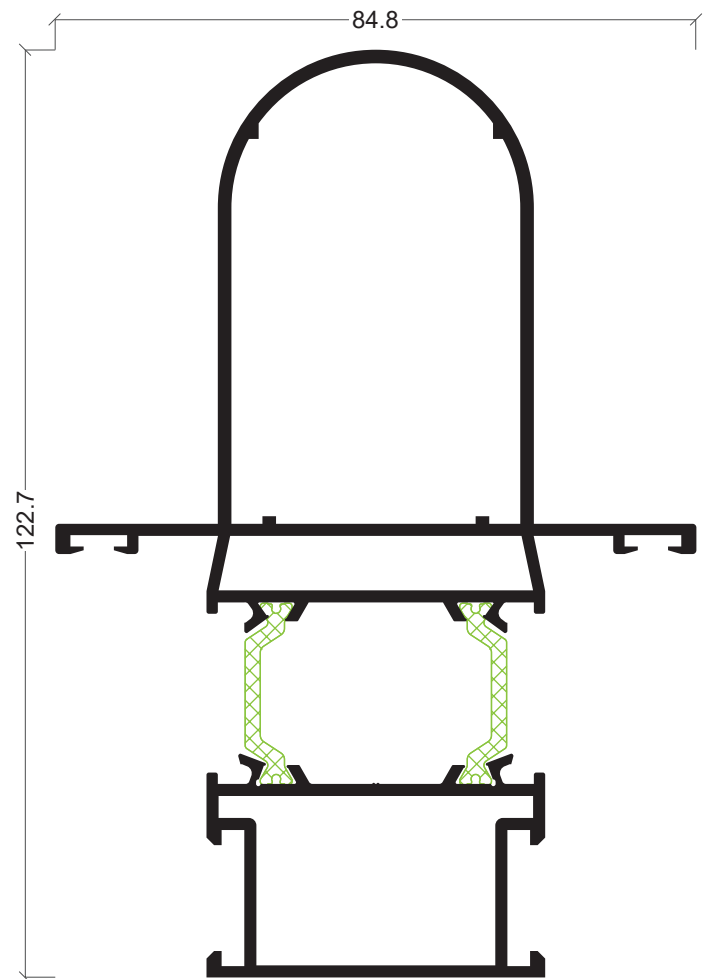

ARi-18

Montante curvo
Rigidizador 123mm curvo

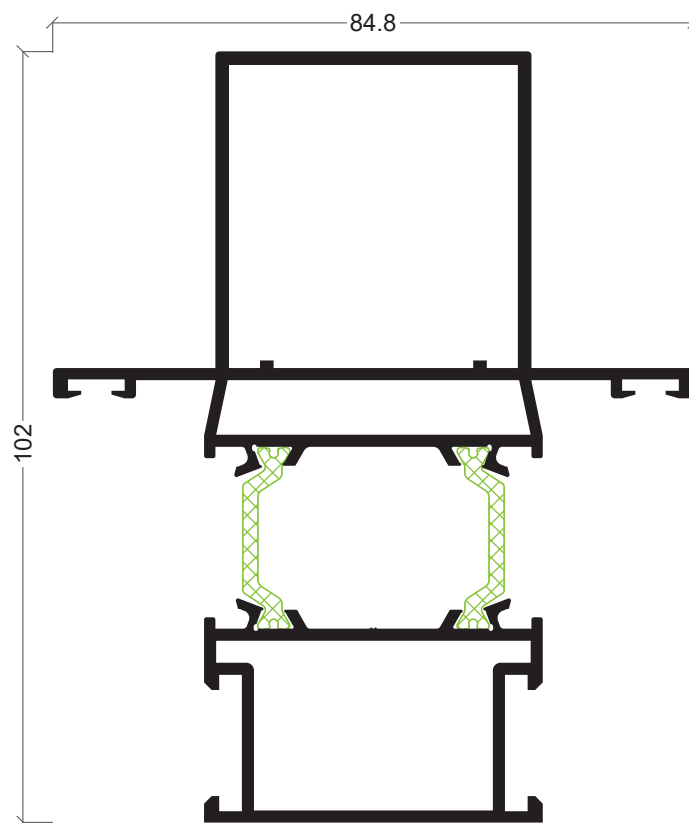

ARi-79

Montante recto
Rigidizador 102mm recto

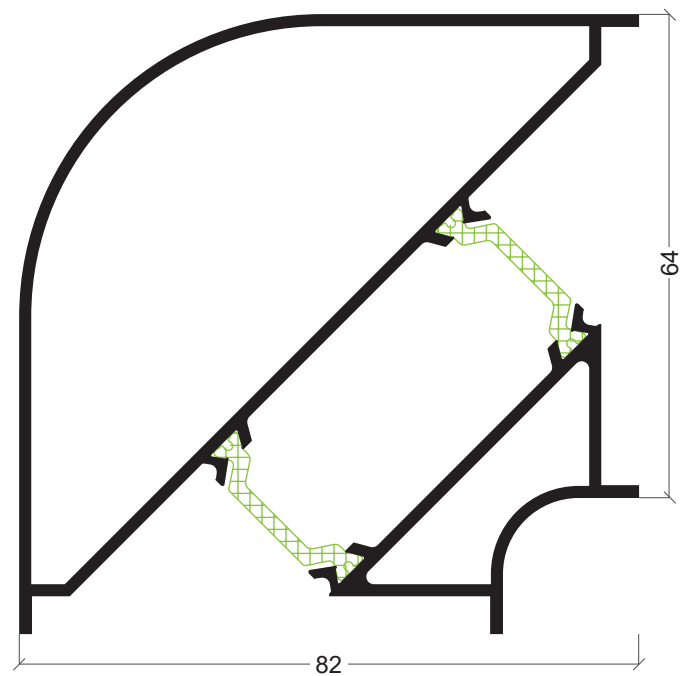

ARi-16

Esquina 90°
Esquinero 90° curvo

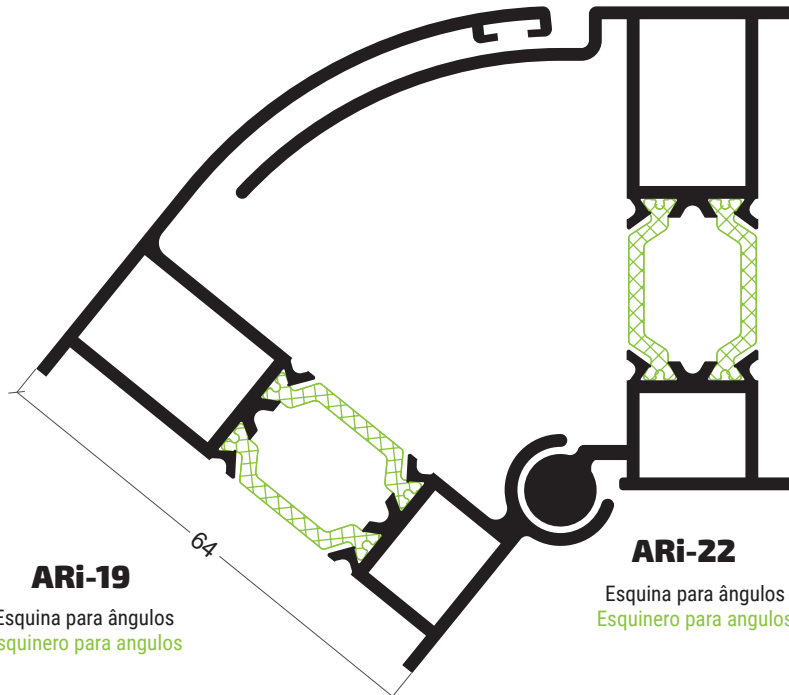

ARi-19
Esquina para ângulos
Esquinero para angulos

ARi-22
Esquina para ângulos
Esquinero para angulos

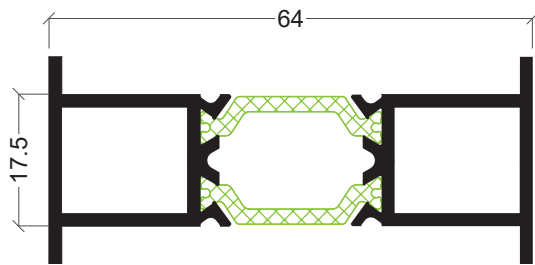

ARi-21
União de aros
Unión de marcos

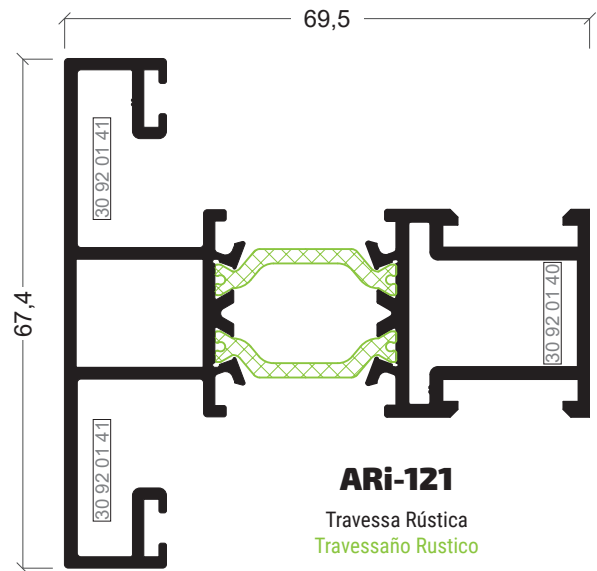

ARi-121
Travessa Rústica
Travessaño Rustico

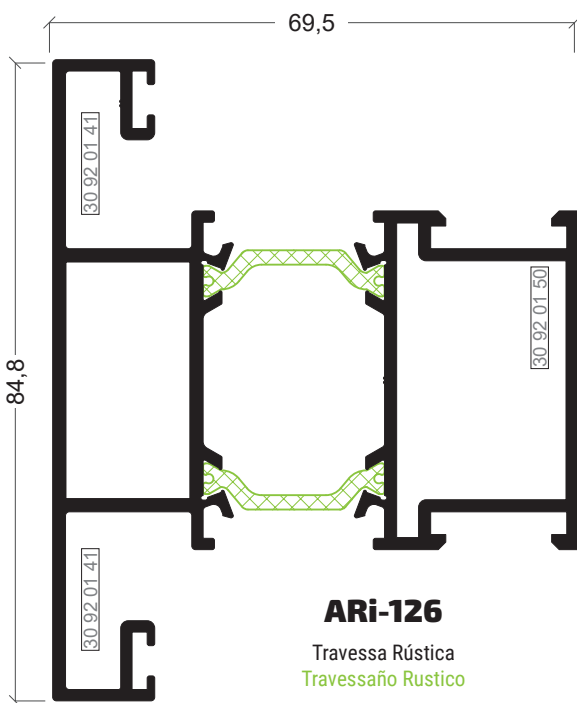

ARi-126
Travessa Rústica
Travessaño Rustico

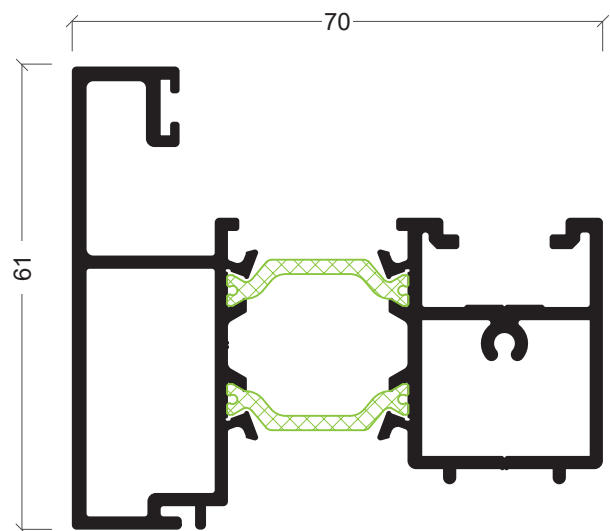

ARi-124
Inversor Rústica
Inversor Rustico

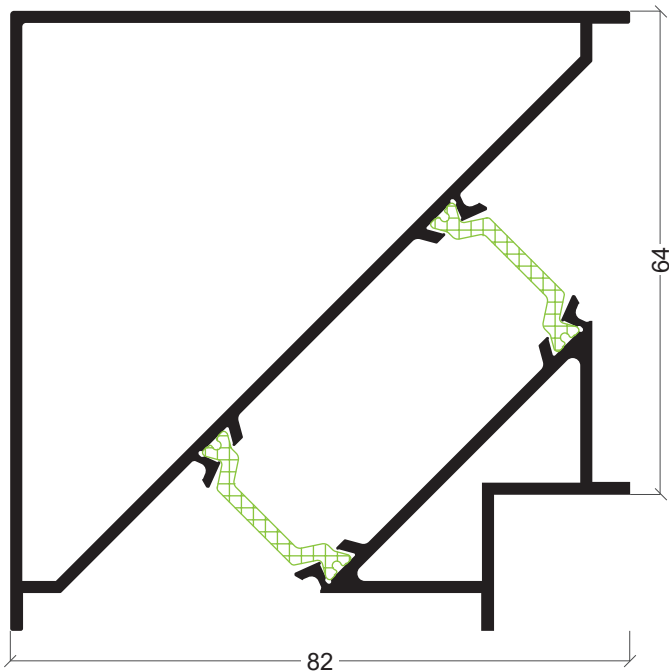

ARi-64
Esquina 90°
Esquinero 90° recto

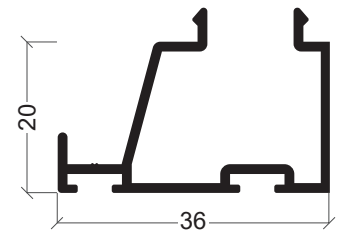

AX-15
Bite remate
Junquillo acople

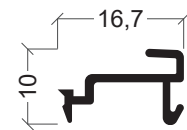

AX-33
Mola bite
Grapa junquillo

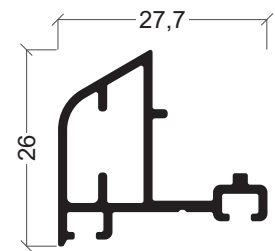

AZ-79
Pingadeira
Vierteaguas puerta

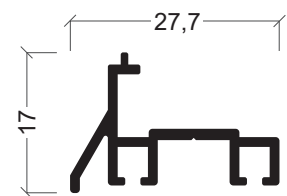

AJi-62
Pingadeira inferior porta sacada
Vierteaguas inferior puerta

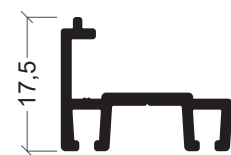

APi-62
Pingadeira
Vierteaguas puerta

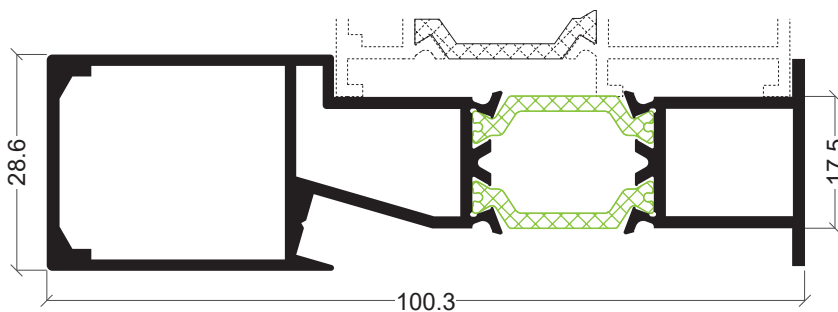

ARi-65
União de aros com reforço
Unión de marcos con refuerzo

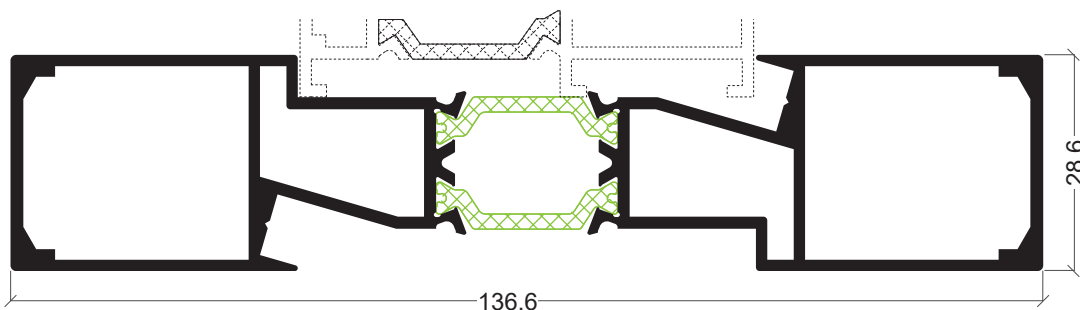

ARi-67
União de aros com reforço
Unión de marcos con doble refuerzo

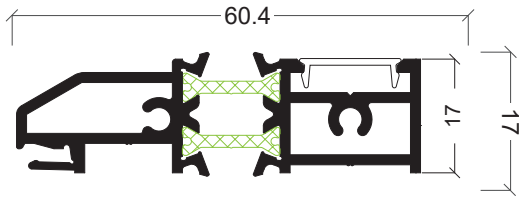

ARi-96

Soleira
Acople inferior

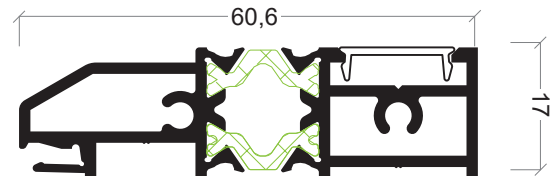

ARi-99

Soleira
Acople inferior

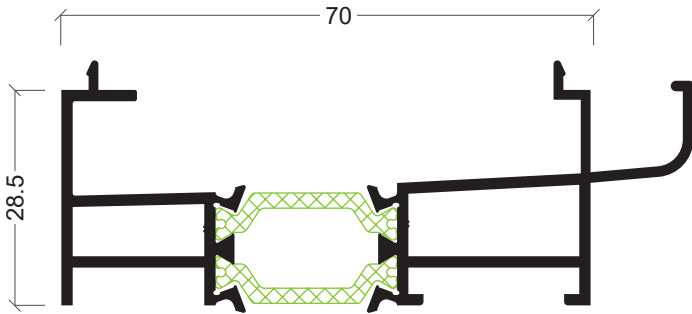

Aji-34

Soleira condensação aro rústico
Condensación rústico

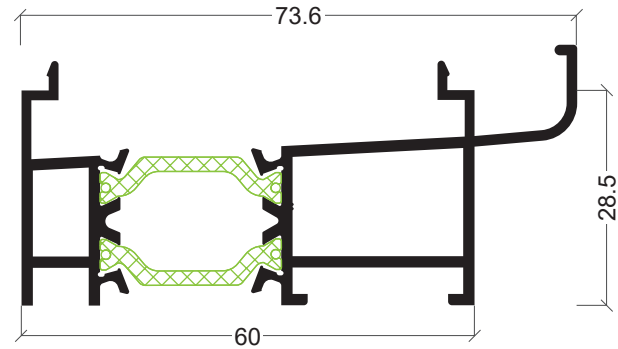

CT-11

Soleira condensação
Condensación

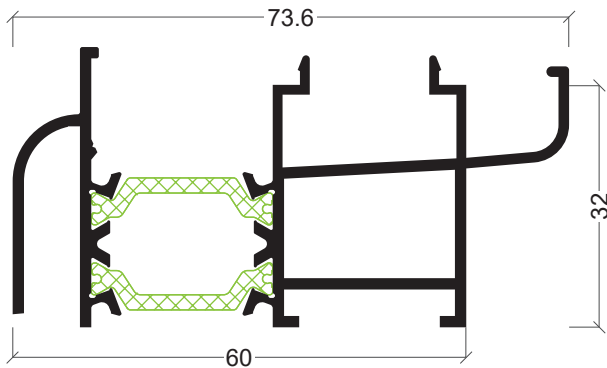

ARi-49

Soleira condensação
Condensación

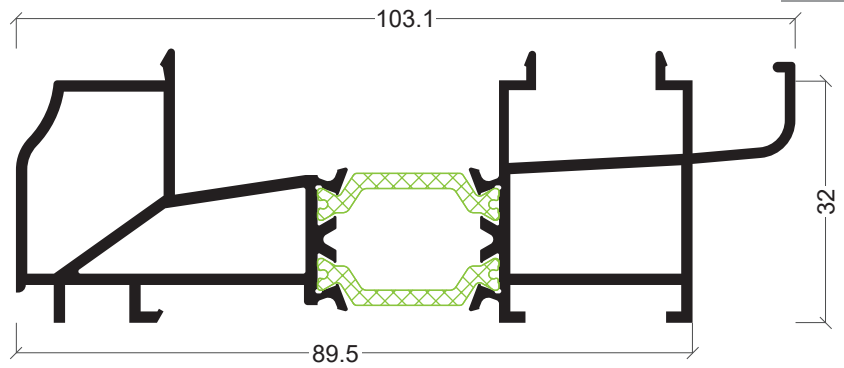

ARi-56

Soleira condensação tradição
Condensación rústico

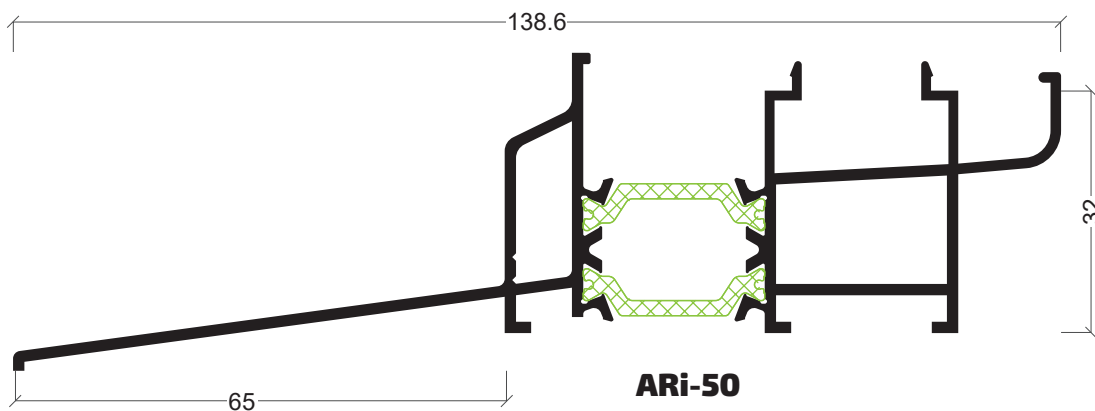

ARi-50

Soleira condensação com pingadeira
Condensación con alargadera

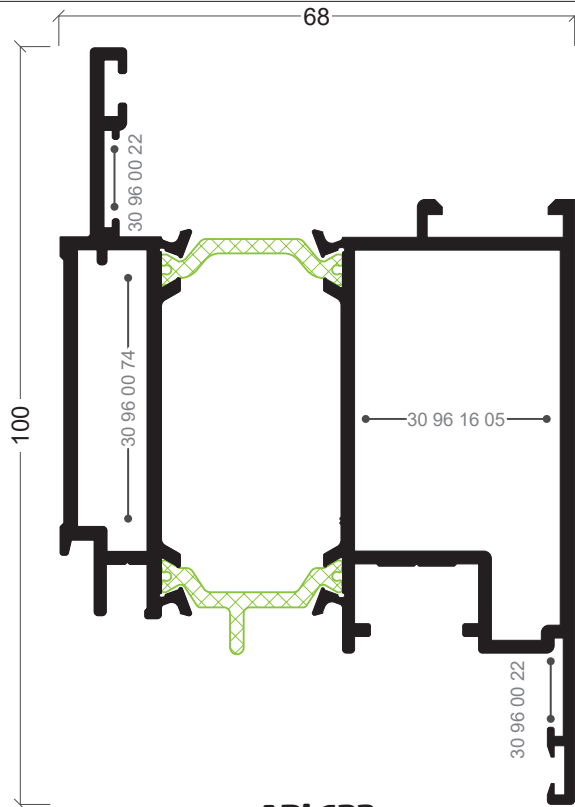

ARi-123

Aro móvil porta para painel
Hoja puerta para painel

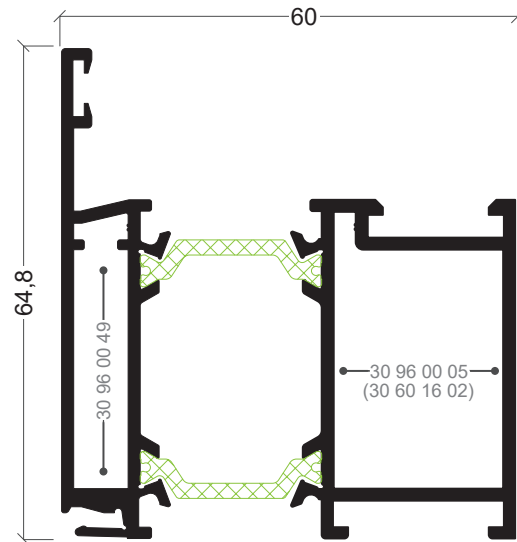

ARi-92

Aro fixo porta
Marco con enganche exterior

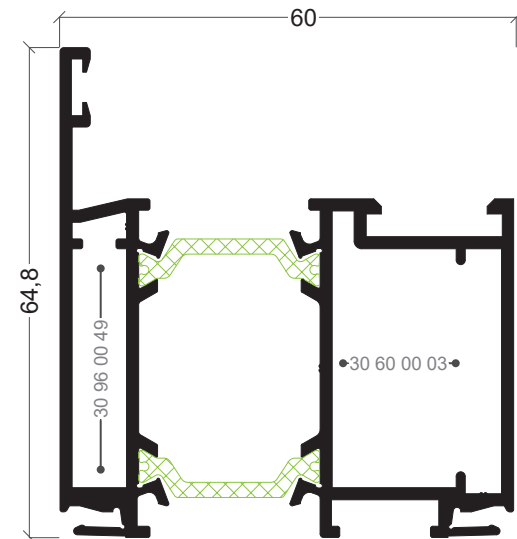

ARi-94

Aro fixo porta
Marco con duplo enganche

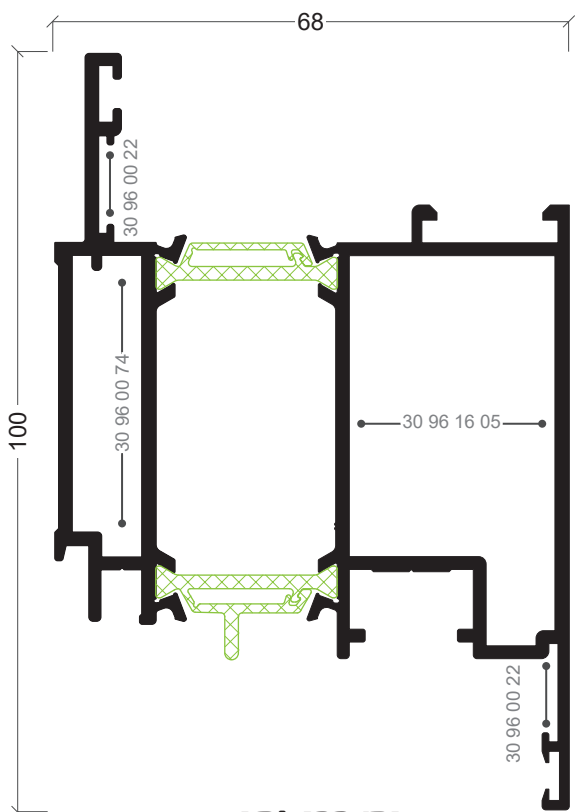

ARi-123/BI

Aro móvil porta para painel anti bi-metal
Hoja puerta para painel anti bimetal

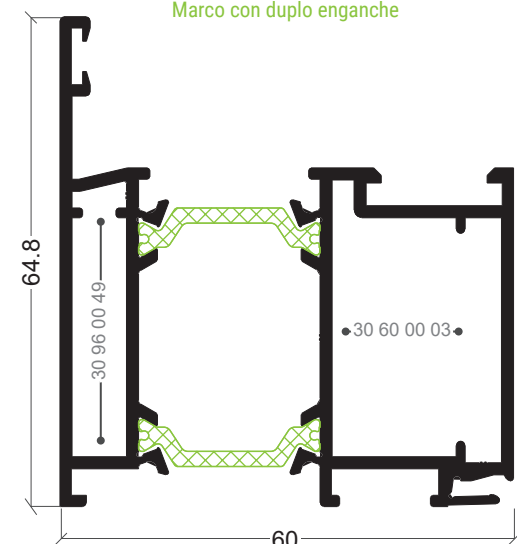

ARi-93

Aro fixo Porta
Marco con enganche interior

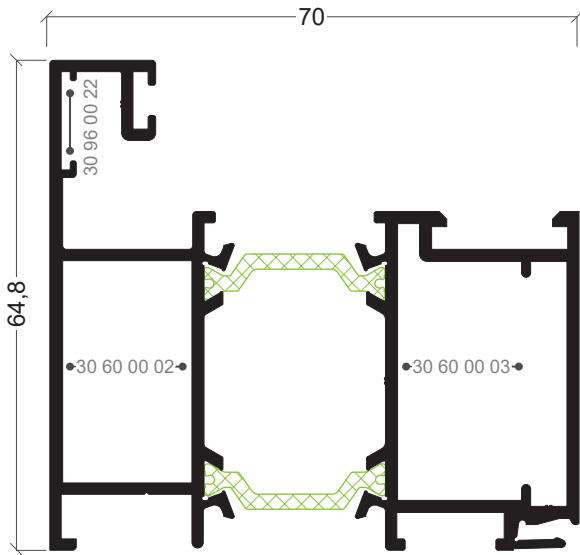

ARi-127

Aro fixo porta rústico
Marco puerta rustico

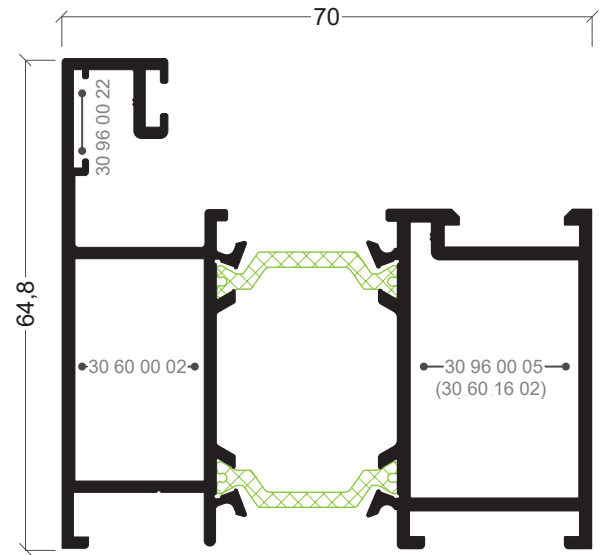

ARi-128

Aro fixo porta rústico
Marco puerta rustico

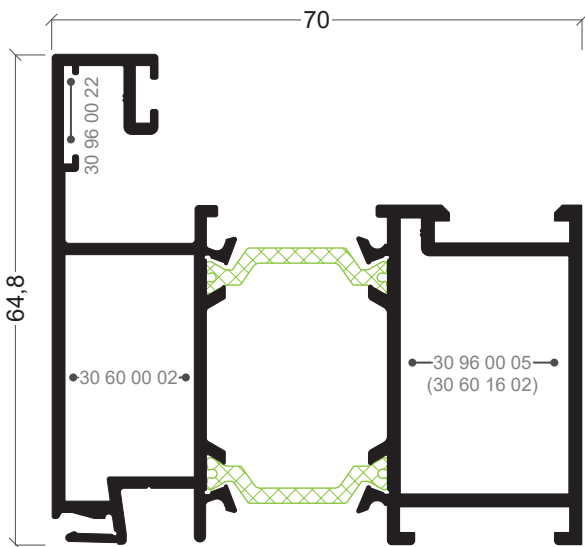

ARi-130

Aro fixo porta rústico
Marco puerta rustico

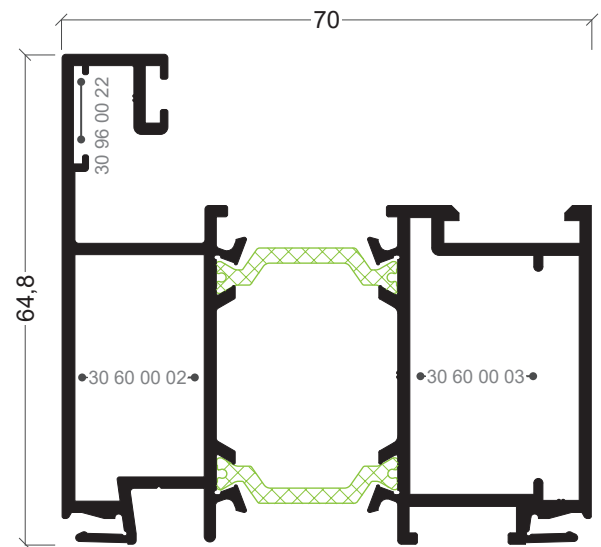

ARi-131

Aro fixo porta rústico
Marco puerta rustico

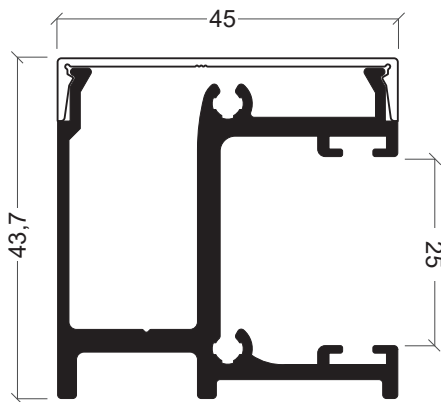

BL-27

Guarda Julieta
Guarda Julieta

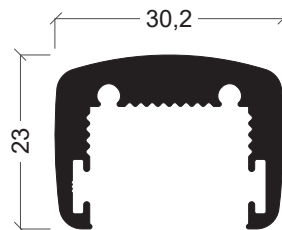

BL-24

Passa-mão (para vidro temperado laminado 88.4)
Pasamano (para vidro templado-laminado 88.4)

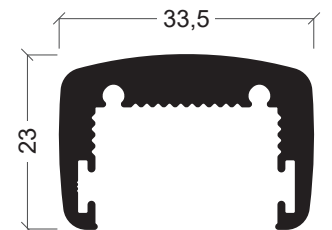

BL-25

Passa-mão (para vidro laminado 1010.2)
Pasamano (para vidro laminado 1010.2)

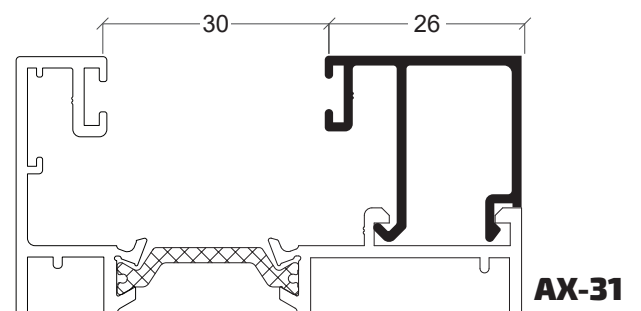
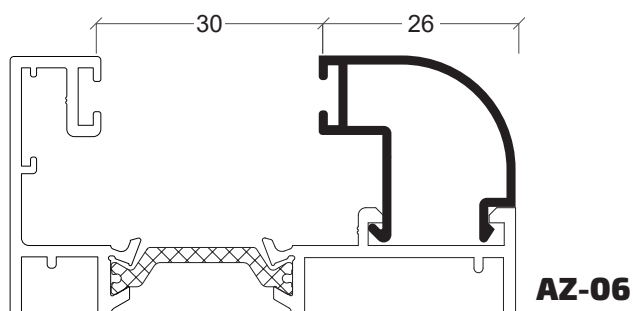
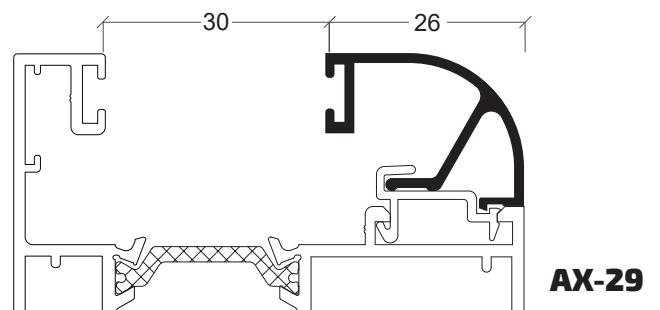
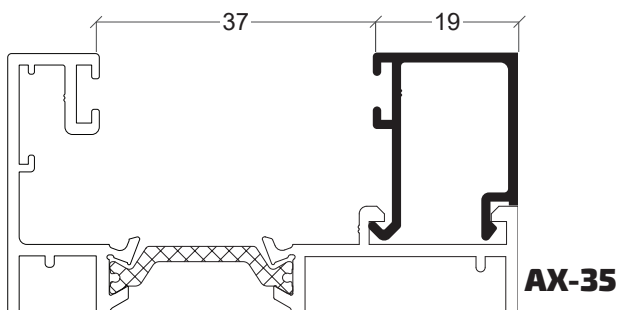
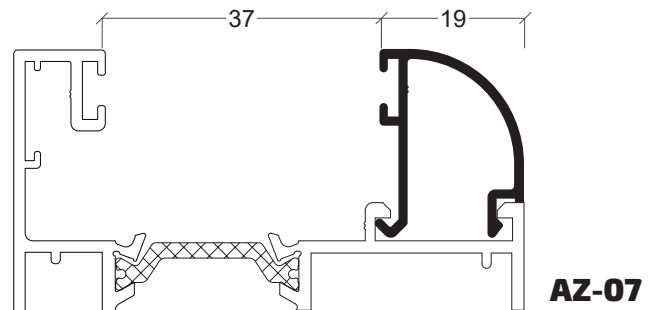
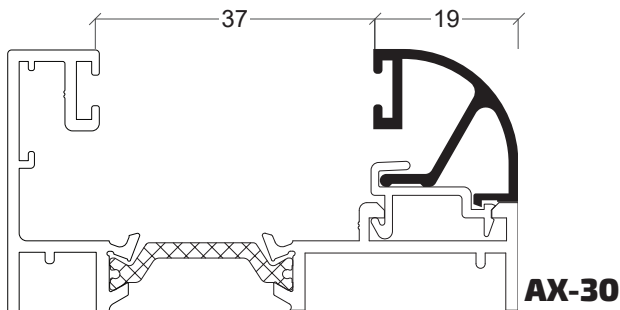
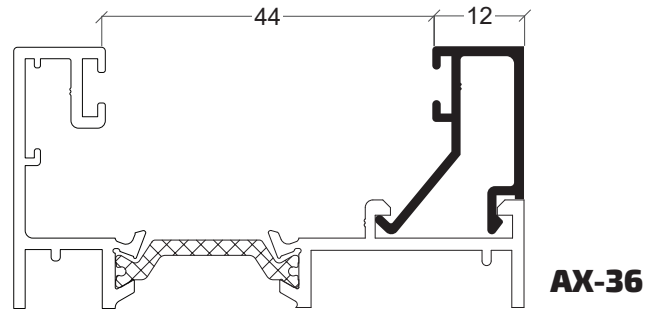
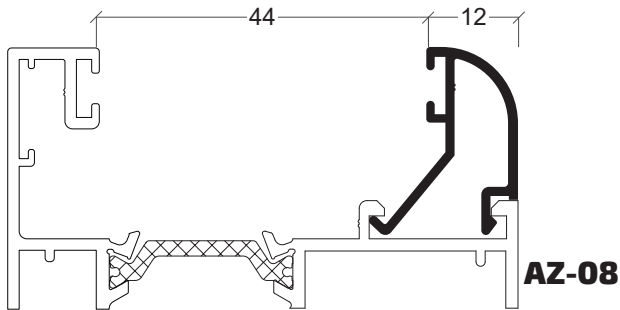
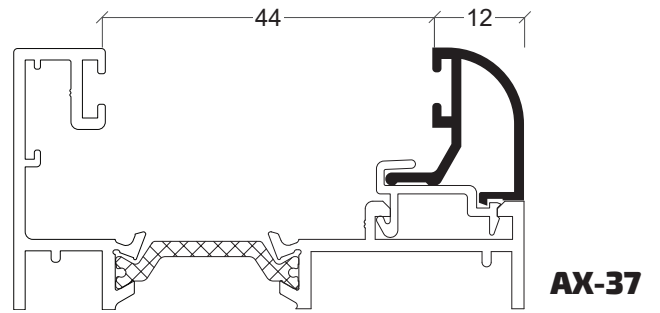
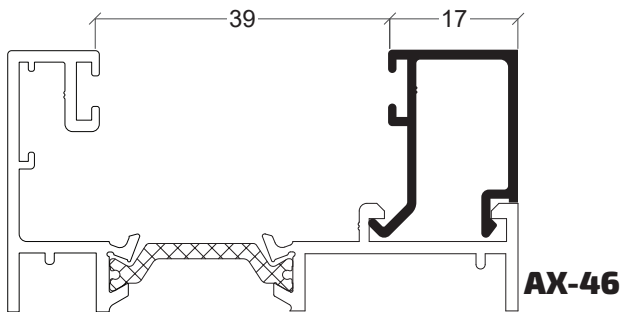
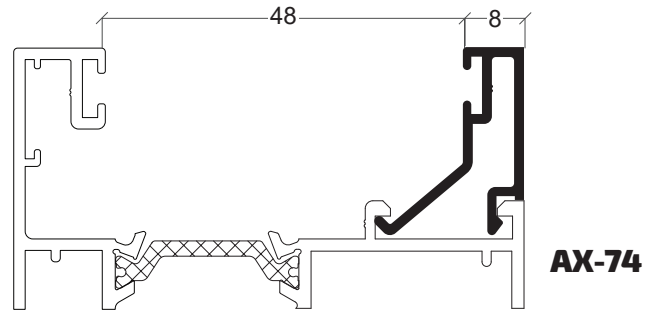
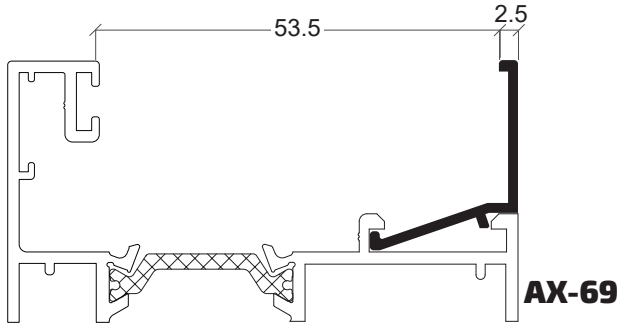

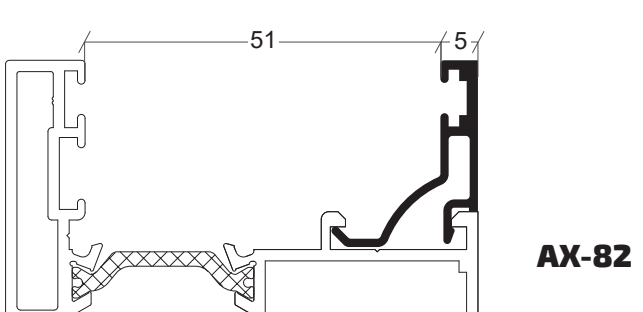
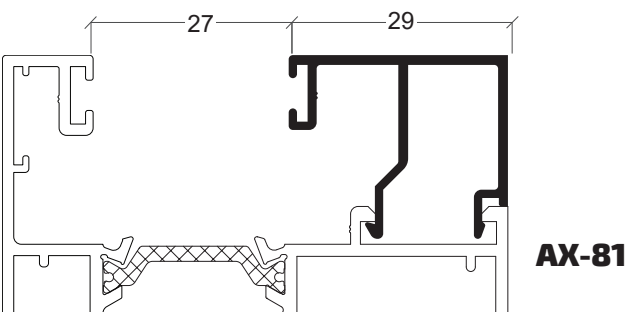
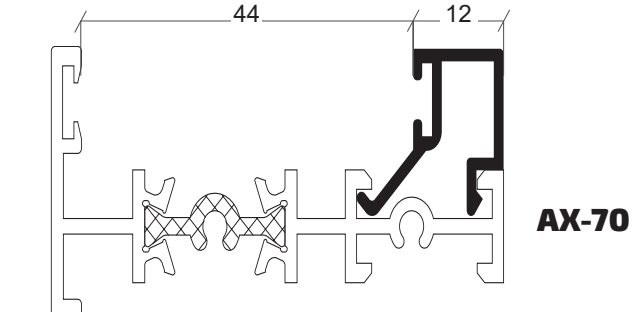
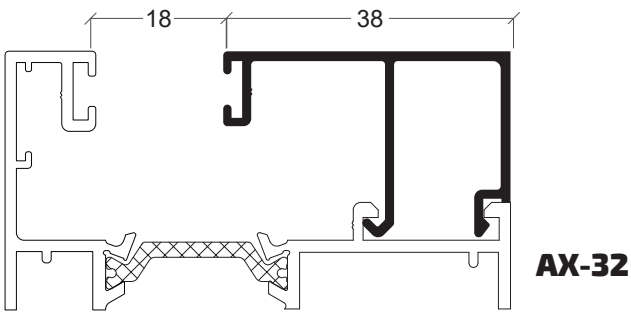
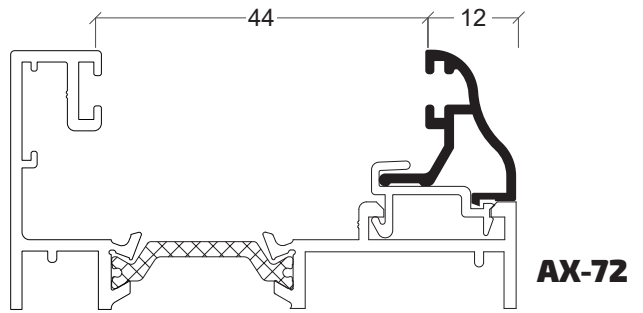
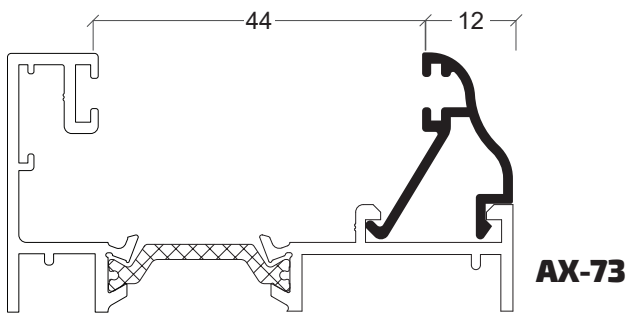
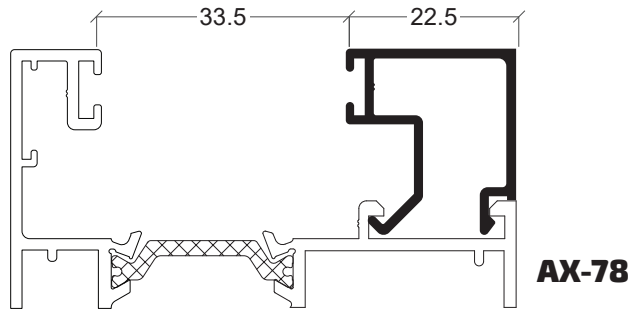
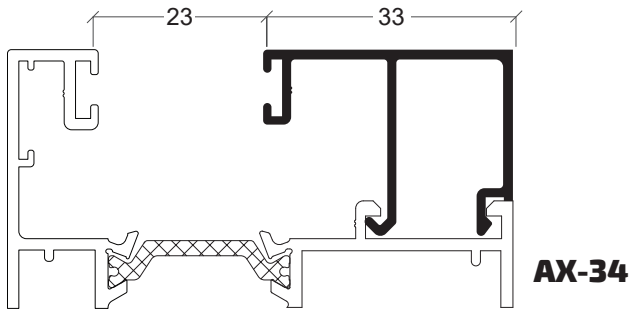
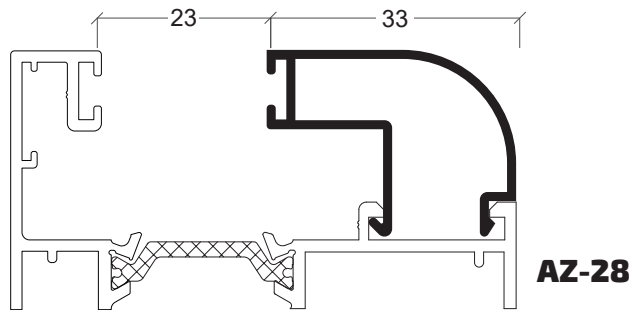
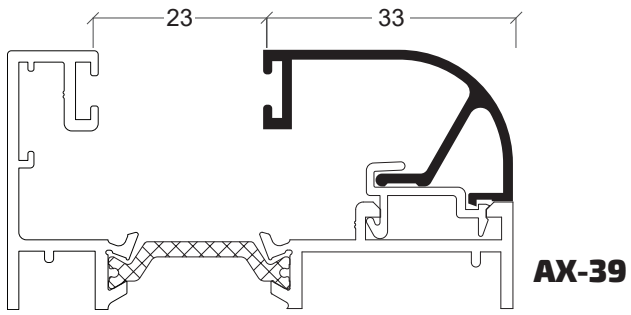

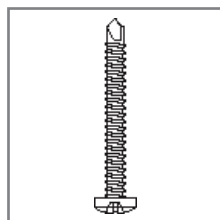

30 00 96 58

Parafuso auto-perfurante 63mm
Tornillo autopercorante 63mm

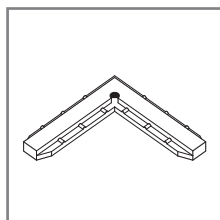

30 21 20 07

Esquadro de alinhamento
Escuadra de alineamiento

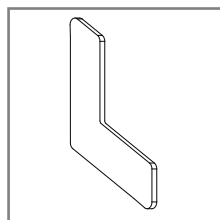

30 21 20 08

Esquadro alinhamento inox
Escuadra de alineamiento inoxidable

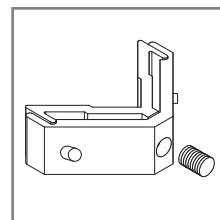

30 60 00 01

Esquadro exterior janela
Escuadra exterior ventana

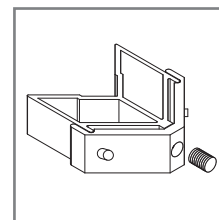

30 60 00 02

Esquadro exterior porta
Escuadra exterior puerta

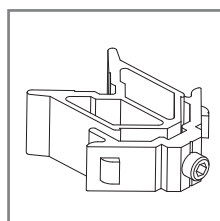

30 60 00 03

Esquadro interior ARI-93
Escuadra interior ARI-93

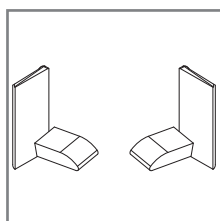

30 60 00 13

Conjunto topos AJI-62
Conjunto topos AJI-62

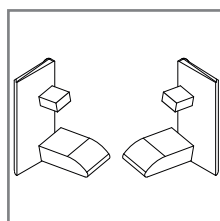

30 60 00 19

Conjunto Topos API-62
Conjunto Topos API-62

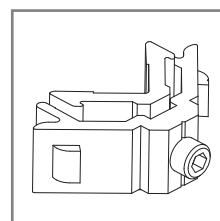

30 60 16 01

Esquadro interior janela C16
Escuadra interior ventana C16

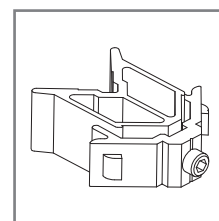

30 60 16 02

Esquadro interior porta C16
Escuadra interior puerta C16

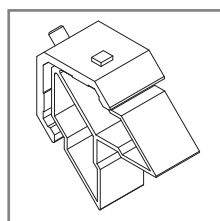

30 60 16 05

Esquadro interior móvel porta entrada
Escuadra interior hoja puerta entrada

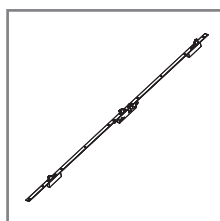

30 60 16 20

Fechadura 3 pontos (35 mm)
Cierre 3 puntos (35 mm)

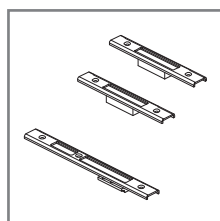

30 60 16 21

Conjunto chapa-testas direitas para aro fixo
Conjunto chapa-testas derechas para marco

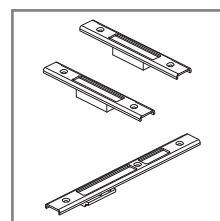

30 60 16 22

Conjunto chapa-testas esquerdas para aro fixo
Conjunto chapa-testas izquierdas para marco

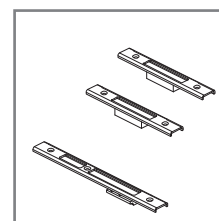

30 60 16 23

Conjunto chapa-testas direitas para inversor
Conjunto chapa-testas derechas para inversor

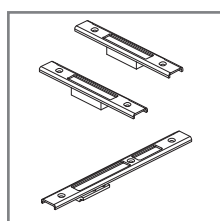

30 60 16 24

Conjunto chapa-testas esquerdas para inversor
Conjunto chapa-testas izquierdas para inversor

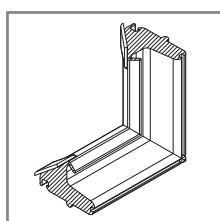

30 60 16 31

Canto vulcanizado C16
Angulo vulcanizado C16

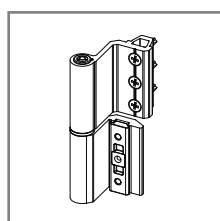

30 60 16 35/36

Dobradiça Canal 16 2 abas com afinação branco/preto
Bisagra Canal 16 2 abas con afinación blanco/negro

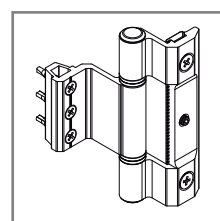

30 60 16 38/39

Dobradiça Canal 16 3 nós reversível branco/preto
Bisagra Canal 16 3 nós reversible blanco/negro

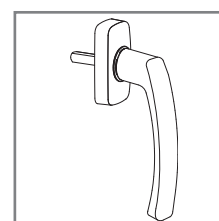

30 60 16 40/41

Puxador de alumínio branco/preto
Manilla de alumínio blanco/negro

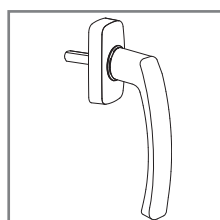

30 60 16 42/43

Puxador de alumínio 2ac/ champ ac
Manilla de alumínio 2 ac/champ ac

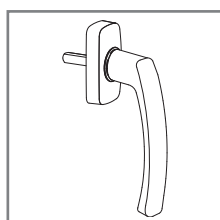

30 60 16 44

Puxador de alumínio inox ac
Manilla de alumínio inox ac

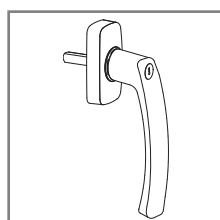

30 60 16 45/46

Puxador de alumínio com chave branco/preto
Manilla de alumínio c/ llave blanco/negro

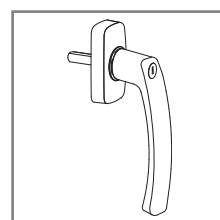

30 60 16 47/48

Puxador de alumínio com chave 2ac/ champ ac
Manilla de alumínio con llave 2ac/ champ ac

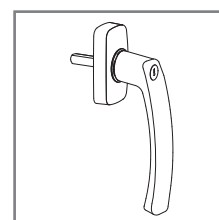

30 60 16 49

Puxador de alumínio com chave inox ac
Manilla con llave de alumínio inox ac

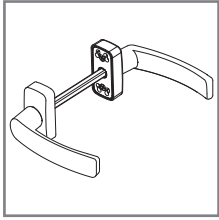

30 60 16 50/51

Puxador duplo de alumínio branco/preto
Manilla doble de alumínio blanco/negro

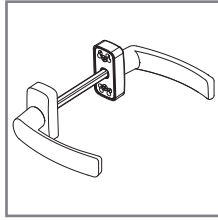

30 60 16 52/53

Puxador duplo de alumínio 2 AC/champac
Manilla doble de alumínio 2 AC/champac

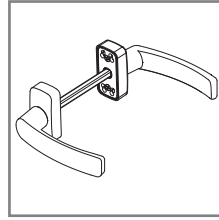

30 60 16 54

Puxador duplo de alumínio inox ac
Manilla doble de alumínio inox ac

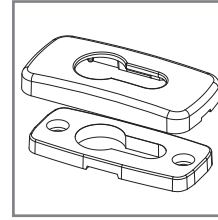

30 60 16 55/56

Espelho de alumínio p/ canhão branco/preto
Escudo de alumínio blanco/negro

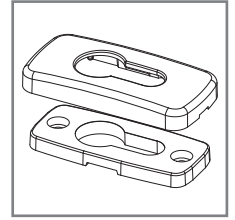

30 60 16 57/58

Espelho de alumínio p/ canhão 2 AC/champac
Escudo de alumínio 2 AC/champac

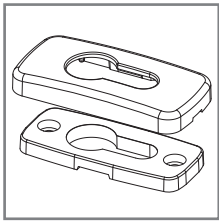

30 60 16 59

Espelho de alumínio p/ canhão inox ac
Escudo de alumínio inox ac



30 60 16 98

Prolongador 250mm
Prolongador 250mm

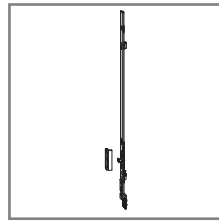

30 60 16 99

Prolongador 500mm (com 1 ponto de fecho)
Prolongador 500mm (con un punto de cierre)

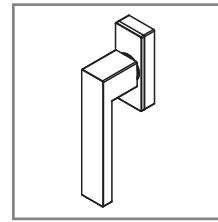

30 60 17 60/61/62

Puxador Recto de alumínio lac. branco/preto/2AC
Manilla recto de alumínio blanco/negro/2AC

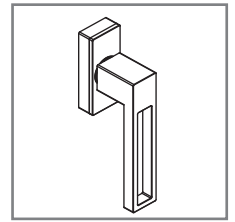

30 60 17 63/64

Puxador Kutt Recto de alumínio lac. Branco/preto
Manilla Kutt recto de alumínio blanco/negro

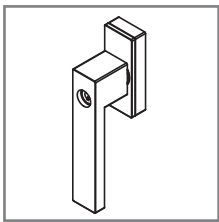

30 60 17 65/66/67

Puxador c/chave recto de alumínio lac. Branco/Preto/2AC
Manilla de alumínio recto c/llave blanco/negro/2AC

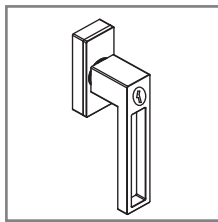

30 60 17 68/69

Puxador Kutt c/chave Recto de alumínio lac. Branco/Preto
Manilla Kutt de alumínio recto c/llave blanco/negro

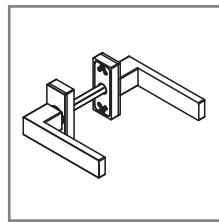

30 60 17 70/71/72

Puxador duplo Recto de alumínio lac. Branco/Preto/2AC
Manilla de alumínio doble recto c/llave blanco/negro/2AC

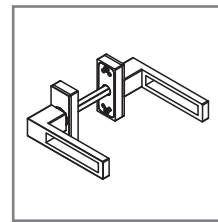

30 60 17 73/74

Puxador duplo Kutt Recto de alumínio lac. Branco/Preto
Manilla de alumínio Kutt recto doble c/llave blanco/negro/2AC

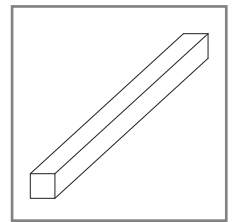

30 91 41 23

Perno 7x131 mm
Perno 7x131 mm

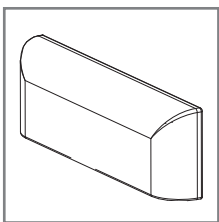

30 92 01 00/01

Goteiras preto/branco
Tapa salida de aguas negro/blanco

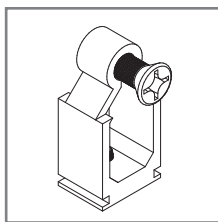

30 92 01 40

União topos janela
Unión topos ventana

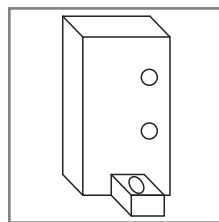

30 92 01 41

União topos exterior ARI-121/126
Unión topos exterior ARI-121/126

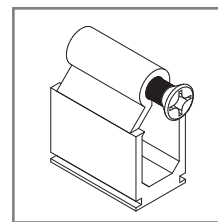

30 92 01 50

União topos porta
Unión topos puerta

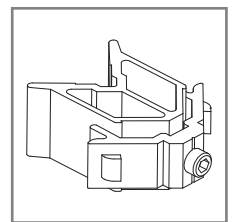

30 92 03 90

Esquadro porta
Escuadra puerta

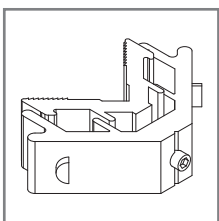

30 92 04 25

Esquadro ARI-80
Escuadra ARI-80

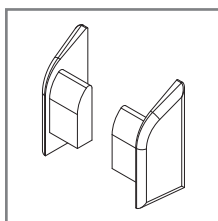

30 92 05 00

Jogo topos para AZ-60
Juego topos para AZ-60

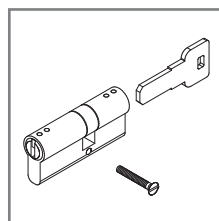

30 92 05 50

Canhão fechadura 30x60
Bombillo cierre 30x60

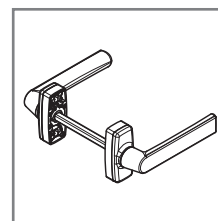

30 92 05 60/61

Puxador duplo branco/preto
Manilla doble blanco/negro

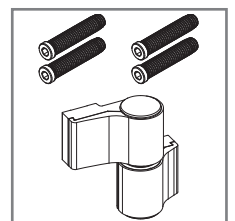

30 92 22 88/89

Dob.2 abas porta ab. exterior fixação directa branco/preto
Bisagra 2 abas puera ap. exterior fijación derecha blanco/negro

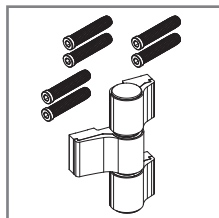

30 92 22 90/91

Dob.3 abas porta ab. exterior fixação directa
branco/preto

Bisagra 3 abas porta ap. exterior fijación
derechas blanco/negro

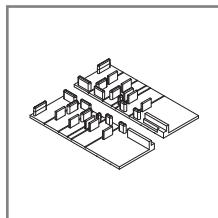

30 95 60 60

Conjunto de vedação preto
Conjunto de vedación negro

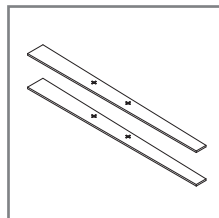

30 95 60 61

Conjunto de juntas
Conjunto de juntas

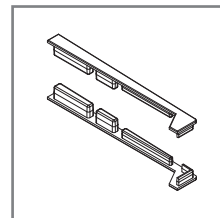

30 95 60 62

Conjunto de topos S-36
Conjunto de topos S-36

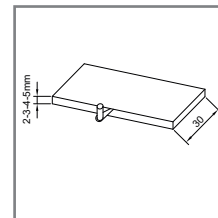

30 95 60 72/73/74/75

Calço de vidro 2/30 3/30 4/30 5/30
Calço de vidrio 2/30 3/30 4/30 5/30

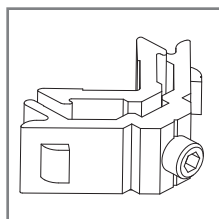

30 96 00 04

Esquadro janela
Escuadra ventana

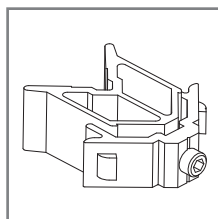

30 96 00 05

Esquadro aro fixo porta
Escuadra marco puerta

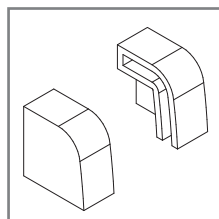

30 96 00 12

Jogo topos condensação
Juego topos condensación

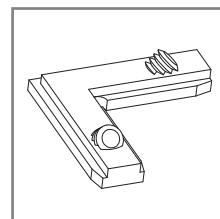

30 96 00 15

Esquadro alinhamento móvel
Escuadra alineamiento hoja

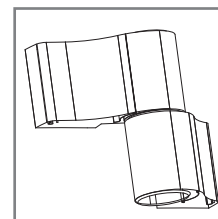

30 96 00 16/20

Dobradiça lisa (branco/preto)
Bisagra lisa (blanco/negro)

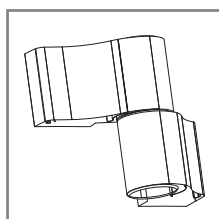

30 96 00 17/21

Dobradiça com ressalto (branco/preto)
Bisagra con resalto (blanco/negro)

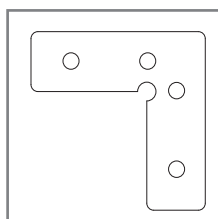

30 96 00 22

Esquadro alinhamento especial
Escuadra alineamiento especial

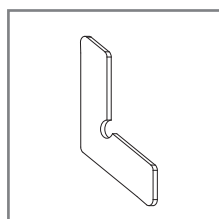

30 96 00 23

Esquadro alinhamento aro fixo
Escuadra alineamiento marco

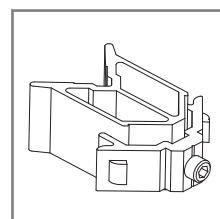

30 96 00 36

Esquadro aro móvel porta
Escuadra hoja puerta

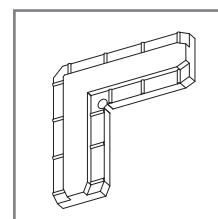

30 96 00 43

Esquadro alinhamento
Escuadra alineamiento

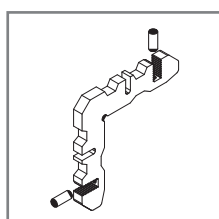

30 96 00 45

Esquadro de alinhamento 5.2x14 com
parafusos
Escuadra alineamiento 5.2x14 con
tornillos

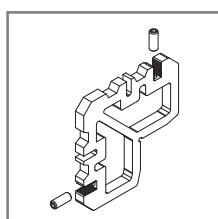

30 96 00 46

Esquadro de alinhamento 5.2x36 com
parafusos
Escuadra alineamiento 5.2x36 con
tornillos

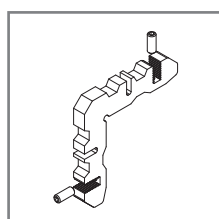

30 96 00 48

Esquadro de alinhamento 7x14 c/
parafusos
Escuadra alineamiento 7x14 c/ tornillos

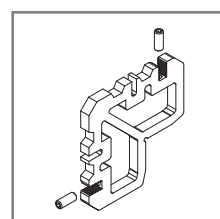

30 96 00 49

Esquadro de alinhamento aro fixo com
parafusos
Escuadra alineamiento marco con
tornillos

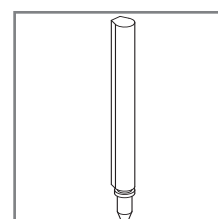

30 96 00 55

Perno alternativo para fixação de
esquadro
Perno alternativo para fijación de
escuadra

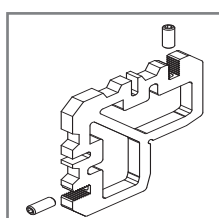

30 96 00 60

Esquadro de alinhamento 5.2x31.6 com
parafusos
Escuadra alineamiento 5.2x31.6 con
tornillos

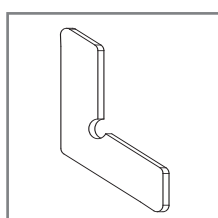

30 96 00 63

Esquadro alinhamento
Escuadra alineamiento

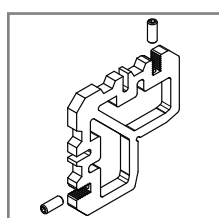

30 96 00 74

Esquadro de alinhamento exterior porta
Escuadra alineamiento exterior puerta

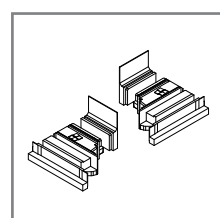

30 96 00 75

Conjunto topos inversor ARi C16
Conjunto topos inversor ARi C16

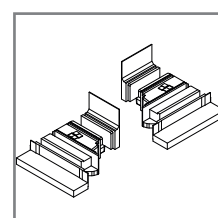

30 96 00 76

Conjunto topos inversor rústico
Conjunto topos inversor rustico

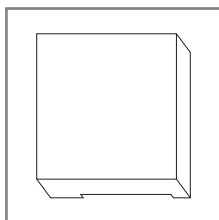

30 96 10 01

Calço para vidro
Calço para vidro

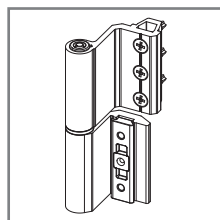

31 70 16 37

Dobradiça Canal 16 2 abas com afinação
Bisagra Canal 16 2 abas con afinación

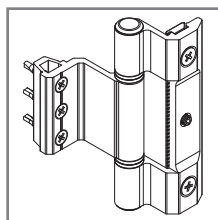

31 70 16 39

Dobradiça Canal 16 3 nós reversível
Bisagra Canal 16 3 abas reversible

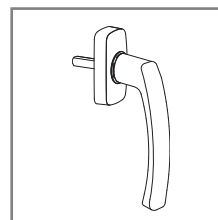

31 70 16 40

Puxador de alumínio
Manilla de alumínio

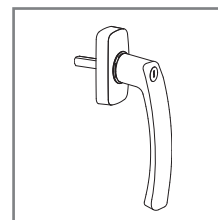

31 70 16 41

Puxador com chave de alumínio cores
Manilla con llave de alumínio colores

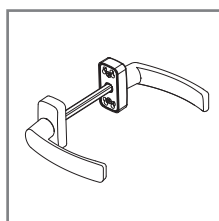

31 70 16 42

Puxador duplo de alumínio cores
Manilla doble de alumínio colores

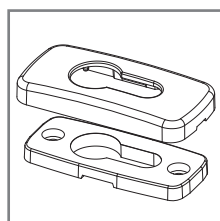

31 70 16 43

Espelho de alumínio cores
Escudo de alumínio colores

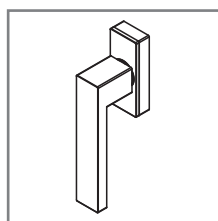

31 70 16 44

Puxador Recto de alumínio lac. Cores
Manilla de alumínio recto colores

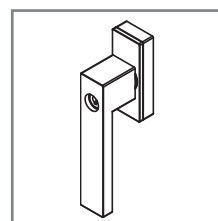

31 70 16 45

Puxador c/chave Recto de alumínio Cores
Manilla de alumínio recto c/llave colores

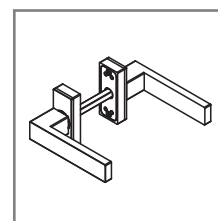

31 70 16 46

Puxador duplo Recto de alumínio lac. Cores
Manilla de alumínio recto doble colores

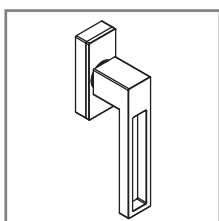

31 70 16 47

Puxador Kutt Recto de alumínio Cores
Manilla de alumínio Kutt recto colores

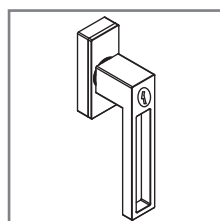

31 70 16 48

Puxador Kutt c/chave Recto de alumínio Cores
Manilla de alumínio Kutt recto c/llave colores

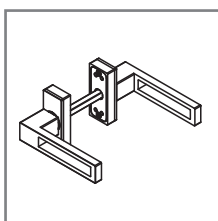

31 70 16 49

Puxador duplo Kutt Recto de alumínio Cores
Manilla de alumínio Kutt recto doble colores

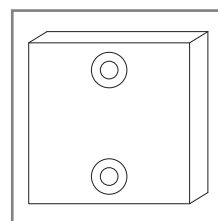

31 90 85 47

Topo para Julieta
Tope para Julieta

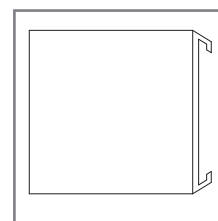

31 90 85 49

Tampa para Julieta
Tapa para Julieta

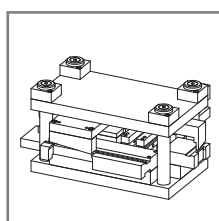





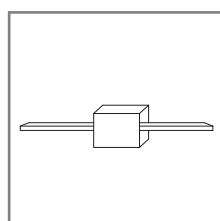





















33 98 15 99





Cunho ARi C16
Cunho ARi C16



33 98 30 10

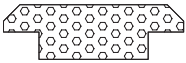
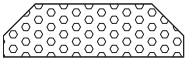

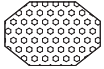



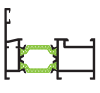

Conjunto de corte ferragem
Conjunto de corte herrage

REFERÊNCIA • REFERENCIA	DESENHO • DISEÑO	DESCRIÇÃO • DESCRIPCIÓN
30 00 95 15		Junta vedação interior curta • Junta estanqueidad interior curta
30 20 30 03		Junta isolante • Junta aislante
30 60 00 14		Pelúcia preta 18mm • Burlete Negro 18mm
30 60 00 17		Junta exterior plana vidro 2 mm preto • Junta exterior plana vidro 2 mm negro
30 60 00 18		Junta isolante aros fixos rústicos • Junta aislante marco rustico
30 60 00 21		Junta exterior acústica • Junta exterior acustica
30 60 16 30		Junta Central Canal 16 mm • Junta Central Canal 16 mm
30 90 85 75		Junta para BL-24/BL-25 • Junta para BL-24/BL-25
30 92 04 70		Espuma isolante • Espuma aislante
30 93 00 60		Vedante exterior de vidro 4mm • Junta exterior de vidrio 4mm
30 93 00 61		Junta vedação exterior vidro 2 mm • Junta estanqueidad exterior vidrio 2 mm
30 93 00 62		Junta exterior plana para vidro 4mm • Junta exterior plana para vidrio 4mm
30 93 00 65		Junta interior para vidro (5 mm) • Junta interior para vidrio (5 mm)
30 93 00 66		Junta interior para vidro (4 mm) • Junta interior para vidrio (4 mm)
30 93 00 67		Junta interior para vidro (2 mm) • Junta interior para vidrio (2 mm)
30 93 00 68		Junta interior para vidro (6/7 mm) • Junta interior para vidrio (6/7 mm)
30 93 00 69		Junta interior para vidro (8/9 mm) • Junta interior para vidrio (8/9 mm)
30 93 00 82		Junta vedação inferior • Junta estanqueidad inferior
30 93 00 84		Junta para pingadeira AZ-60 • Junta para viertagua AZ-60
30 93 01 20		Junta interior • Junta interior
30 94 64 81		Junta interior plana vidro 3mm • Junta interior plana vidrio 3mm
30 94 64 82		Junta interior plana vidro 5mm • Junta interior plana vidrio 5mm
30 94 64 83		Junta interior plana vidro 7mm • Junta interior plana vidrio 7mm
30 94 64 84		Junta interior plana vidro 9mm • Junta interior plana vidrio 9mm
30 95 00 10		Pelúcia 7x9 mm • Burlete 7x9 mm
30 96 00 09		Junta tapa-canal • Junta tapa canal

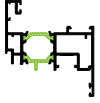
REFERÊNCIA • REFERENCIA	DESENHO THERMOPROFILE • DISEÑO THERMOPROFILE	DESCRIÇÃO • DESCRIPCIÓN
30 99 00 03		ARi-01; ARi-03; ARi-11; ARi-19; ARi-21; ARi-22; ARi-33; ARi-35; ARi-49; ARi-50; ARi-56; ARi-57; ARi-65; ARi-67; ARi-73; ARi-74; ARi-75; ARi-76; ARi-77; ARi-80; ARi-81; ARi-86; ARi-87; ARi-88; ARi-89; ARi-91; ARi-95; ARi-108; ARi-109; ARi-111; ARi-112; ARi-113; ARi-114; ARi-116; ARi-118; ARi-119; ARi-120; ARi-121; ARi-125;
30 99 00 04		ARi-01; ARi-03; ARi-06; ARi-08; ARi-12; ARi-13; ARi-17; ARi-18; ARi-33; ARi-35; ARi-57; ARi-59; ARi-68; ARi-69; ARi-74; ARi-75; ARi-76; ARi-77; ARi-79; ARi-80; ARi-81; ARi-86; ARi-87; ARi-88; ARi-89; ARi-91; ARi-92; ARi-93; ARi-94; ARi-108; ARi-109; ARi-111; ARi-112; ARi-113; ARi-114; ARi-116; ARi-118; ARi-119; ARi-120; ARi-121; ARi-125; ARi-126; ARi-127; ARi-128; ARi-130; ARi-131;
30 99 00 05		ARi-161; ARi-136; ARi-136/Bi; ARi-122; ARi-122/Bi; ARi-172
30 99 00 08		ARi-08; ARi-12; ARi-13; ARi-17; ARi-18; ARi-59; ARi-68; ARi-69; ARi-79; ARi-92; ARi-93; ARi-94; ARi-127; ARi-128; ARi-130; ARi-131; ARi-136/Bi;
30 99 00 09		ARi-12; ARi-13; ARi-122/Bi; ARi-123/Bi; ARi-172;
30 99 00 18		ARi-117; ARi-124; ARi-161;
30 99 00 19		ARi-136;
30 99 00 20		ARi-16; ARi-64; ARi-122; ARi-123;

Janela 1 folha abrir e oscilo-batente • Ventana 1 hoja practicable y oscilobatiente

PERFIS • PERFIS

DESENHO • DISEÑO	REF.	DESCRIÇÃO • DESCRIPCIÓN	CORTE • CORTE	QUANTIDADE CANTIDAD	MEDIDAS • MEDIDA
	ARi-03	Aro fixo • Marco ventana		2	L
				2	H
	ARi-161	Aro móvel • Hoja ventana		2	L- 39mm
				2	H- 39mm
	---	Bite • Junquillo		2	L- 147mm
				2	H- 187mm

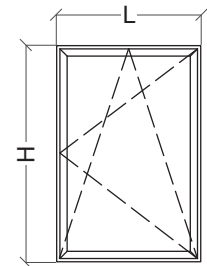

ACESSÓRIOS E JUNTAS • ACCESORIOS Y JUNTAS

REF.	DESCRIÇÃO • DESCRIPTION	QUANTIDADE • CANTIDAD	
		ABRIR PRATICABLE	OSCILO-BATENTE OSCILOBATIENTE
30 60 16 01	Esquadro interior • Escuadra Interior	8	
30 96 00 48	Esquadro exterior fixo • Escuadra exterior marco	4	
30 96 00 45	Esquadro exterior móvel • Escuadra exterior hoja	4	
30 96 00 22	Esquadro alinhamento móvel • Escuadra alineamiento hoja	8	
30 96 10 01	Calço para vidro • Calço para vidrio	4	6
30 60 16 41	Puxador • Manilla	1	
-----	Ferragem Canal 16 • Herraje Canal 16	1	
30 92 01 02	Goteiras • Tapa salida de aguas	2 ou mais	
30 93 01 20	Junta interior • Junta interior	2L + 2H	
30 60 16 30	Junta central • Junta central	2L + 2H	
30 60 16 31	Canto vulcanizado • Angulo vulcanizado	4	
---	Junta exterior vidro • Junta exterior vidrio	2L+2H	
---	Junta interior vidro • Junta exterior vidrio	2L+2H	

VIDRO • VIDRIO

Hv = H-161 mm	Lv = L-161 mm
---------------	---------------

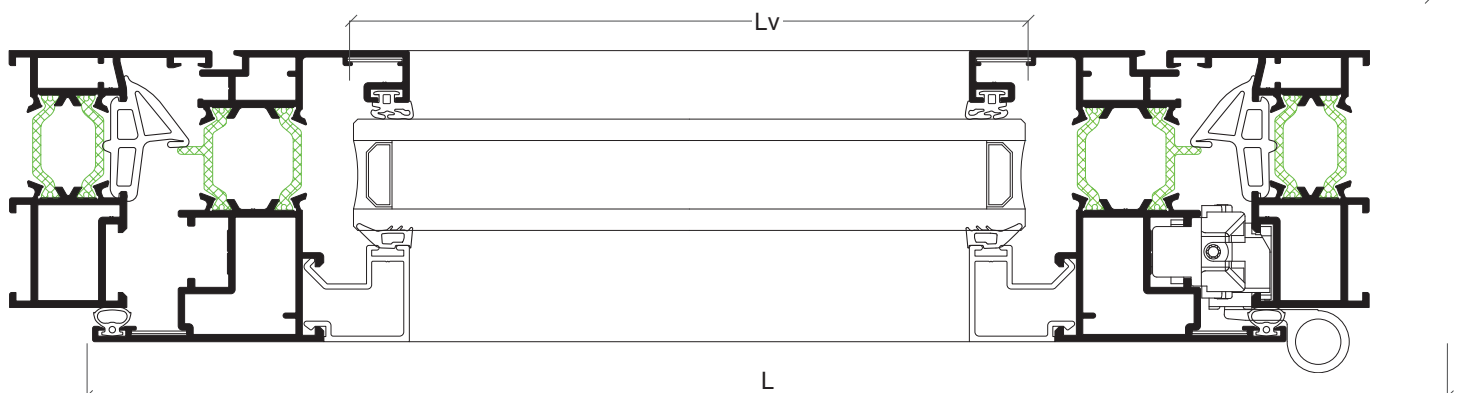
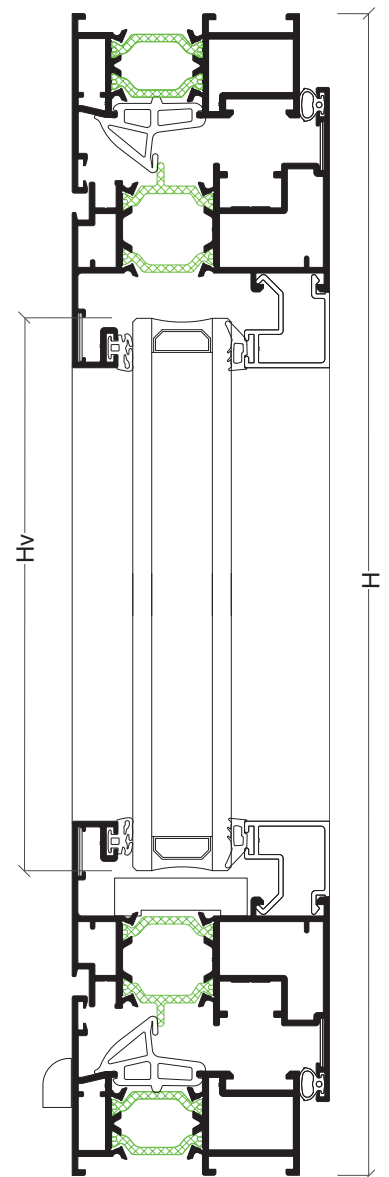

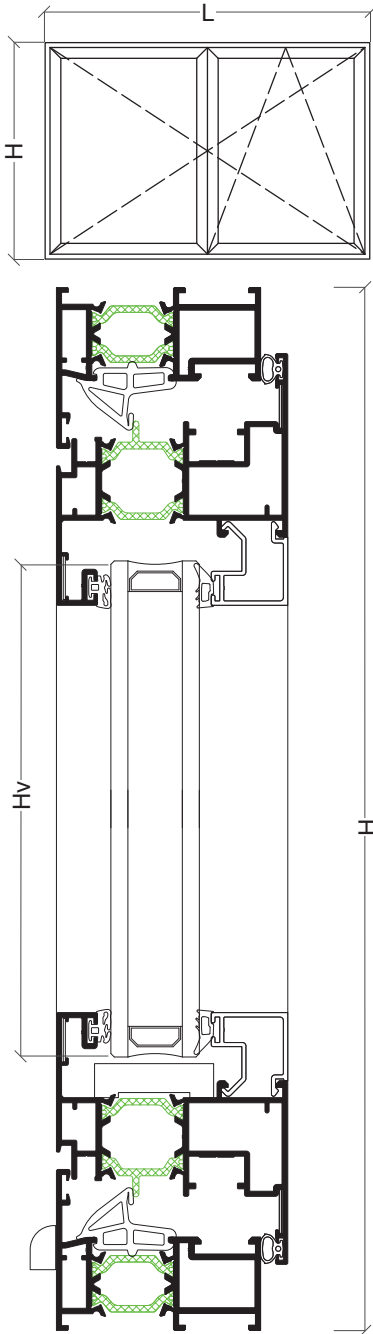
Janela 2 folhas abrir e oscilo-batente • Ventana 2 hojas practicable y oscilobatiente

PERFIS • PERFIS

DESENHO • DISEÑO	REF.	DESCRIÇÃO • DESCRIPCIÓN	CORTE • CORTE	QUANTIDADE CANTIDAD	MEDIDAS • MEDIDA
	ARi-03	Aro fixo • Marco ventana		2	L
				2	H
	ARi-161	Aro móvel • Hoja ventana		4	L/2-22 mm
				4	H-39 mm
	---	Bite • Junquillo		4	L/2-130 mm
				4	H-187 mm
	ARi-117	Inversor • Inversor		1	H-115 mm

ACESSÓRIOS E JUNTAS • ACCESORIOS Y JUNTAS

REF.	DESCRIÇÃO • DESCRIPTION	QUANTIDADE • CANTIDAD	
		ABRIR PRATICABLE	OSCILO-BATENTE OSCILOBATIENTE
30 60 16 01	Esquadro interior • Escuadra Interior	12	
30 96 00 48	Esquadro exterior fixo • Escuadra exterior marco	4	
30 96 00 45	Esquadro exterior móvel • Escuadra exterior hoja	8	
30 96 00 22	Esquadro alinhamento móvel • Escuadra alineamiento hoja	16	
30 96 10 01	Calço para vidro • Calço para vidrio	8	10
30 60 16 41	Puxador • Manilla	1	
-----	Ferragem Canal 16 • Herraje Canal 16	1	
30 92 01 02	Goteiras • Tapa salida de aguas	2 ou mais	
30 96 00 75	Jogo topos inversor • Juego topes inversor	1	
30 93 01 20	Junta interior • Junta interior	2L + 4H	
30 60 16 30	Junta central • Junta central	2L + 3H	
30 60 16 31	Canto vulcanizado • Angulo vulcanizado	4	
---	Junta exterior vidro • Junta exterior vidrio	2L + 4H	
---	Junta interior vidro • Junta interior vidrio	2L + 4H	





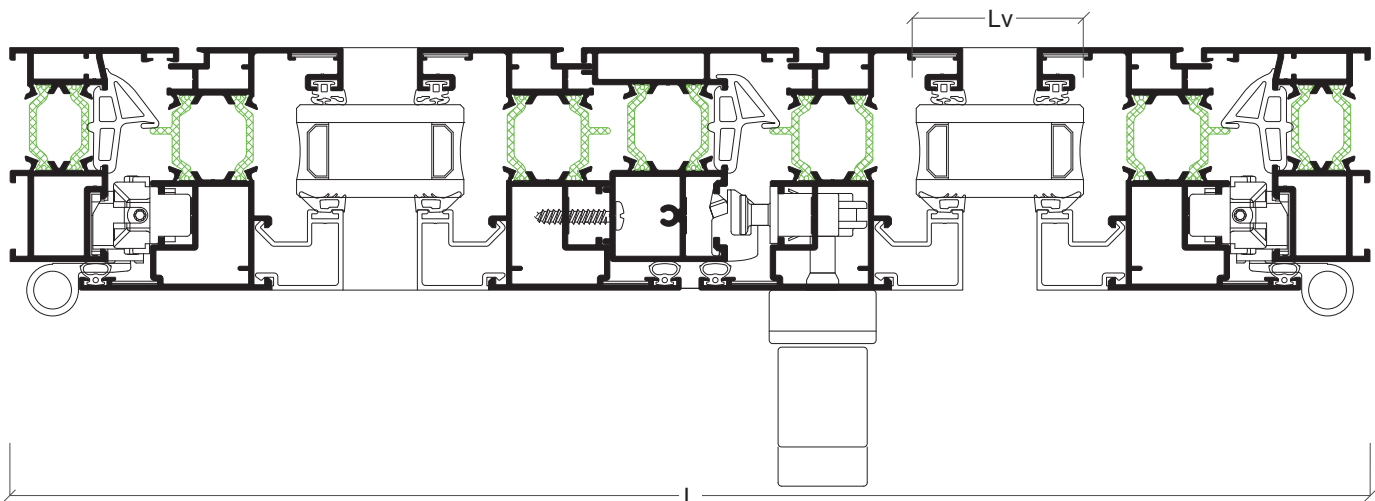



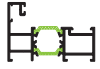

VIDRO • VIDRIO

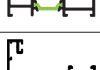
Hv = H-161 mm	Lv = L/2 - 144 mm
---------------	-------------------



Janela Rustica 1 folha abrir e oscilo-batente • Ventana Rustica 1 hoja practicable y oscilobatiente

PERFIS • PERFIS

DESENHO • DESEÑO	REF.	DESCRIÇÃO • DESCRIPCIÓN	CORTE • CORTE	QUANTIDADE CANTIDAD	MEDIDAS • MEDIDA
	ARi-108	Aro fixo • Marco ventana		2	L
				2	H
	ARi-161	Aro móvel • Hoja ventana		2	L- 39mm
				2	H- 39mm
	---	Bite • Junquillo		2	L- 147mm
				2	H- 187mm

ACESSÓRIOS E JUNTAS • ACCESORIOS Y JUNTAS

REF.	DESCRIÇÃO • DESCRIPTION	QUANTIDADE • CANTIDAD	
		ABRIR PRATICABLE	OSCILO-BATENTE OSCILOBATIENTE
30 60 16 01	Esquadro Interior • Escuadra Interior	8	
30 60 00 01	Esquadro exterior fixo • Escuadra exterior marco	4	
30 96 00 45	Esquadro exterior móvel • Escuadra exterior hoja	4	
30 96 00 22	Esquadro alinhamento móvel • Escuadra alineamiento hoja	12	
30 96 10 01	Calço para vidro • Calço para vidrio	4	6
30 60 16 41	Puxador • Manilla	1	
----	Ferragem Canal 16 • Herraje Canal 16	1	
30 92 01 02	Goteira • Tapa salida de aguas	2 ou mais	
30 93 01 20	Junta interior • Junta interior	2L + 2H	
30 60 16 30	Junta central • Junta central	2L + 2H	
30 60 16 31	Canto vulcanizado • Angulo vulcanizado	4	
---	Junta exterior vidro • Junta exterior vidrio	2L+2H	
---	Junta interior vidro • Junta interior vidrio	2L+2H	

VIDRO • VIDRIO

Hv = H-161 mm	Lv = L-161 mm
---------------	---------------

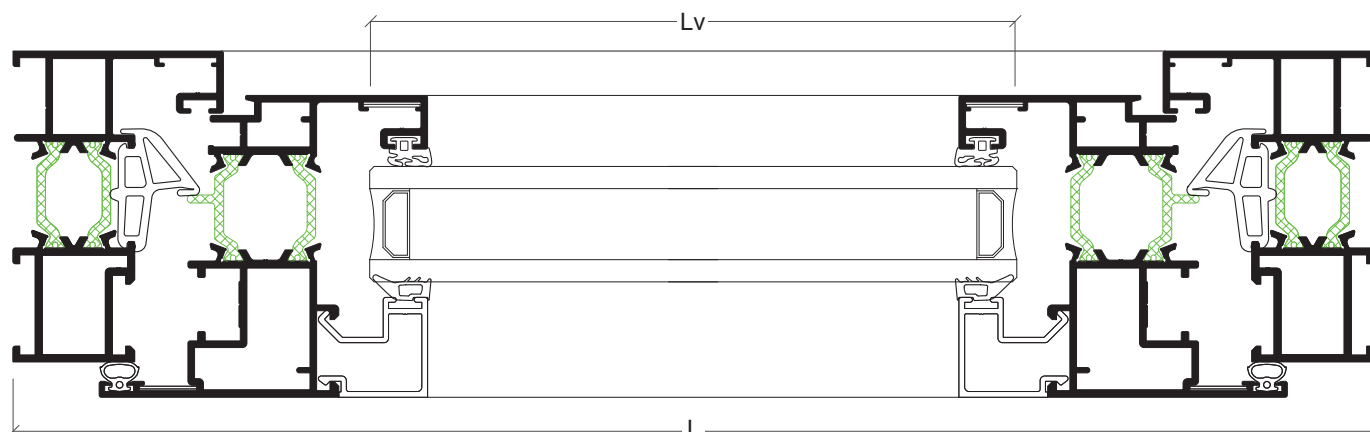
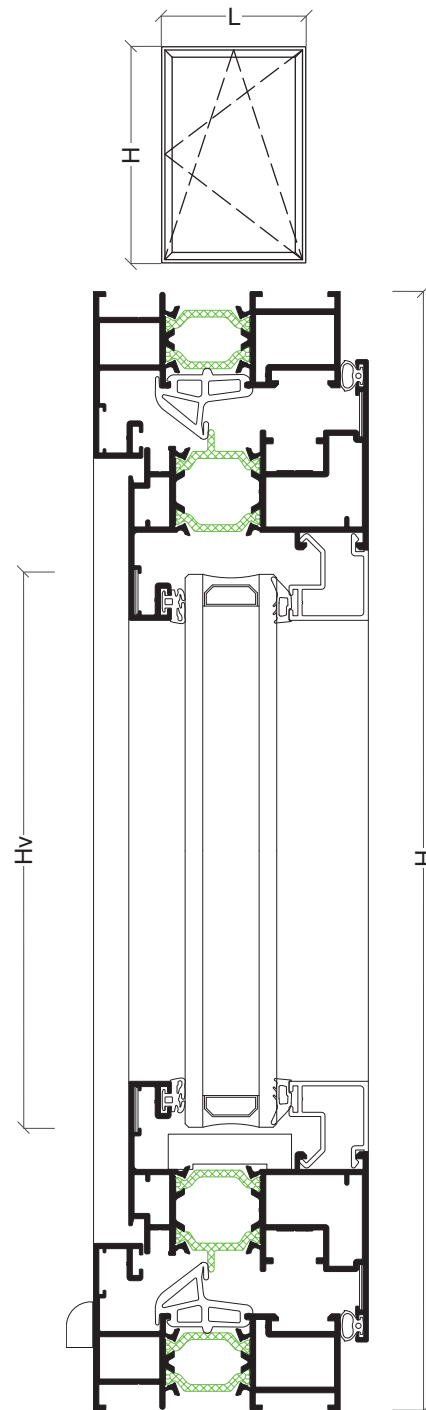

Sacada 1 folha abrir e oscilo-batente Julieta • Sacada 1 hoja practicable y oscilobatiente barandilla Julieta
PERFIS • PERFIS

DESENHO • DESEÑO	REF.	DESCRIÇÃO • DESCRIPCIÓN	CORTE • CORTE	QUANTIDADE CANTIDAD	MEDIDAS • MEDIDA
	ARI-03	Aro fixo • Marco ventana	 	2 2	L H
	ARI-161	Aro móvel • Hoja ventana	 	2 2	L- 39mm H- 39mm
	---	Bite • Junquillo	 	2 2	L- 147mm H- 187mm
	BL-27	Guarda Julieta • Guarda Julieta		2	1100mm
	FX-38	Perfil Tampa • Perfil Tapa		2	1100mm
	BL-24 ou BL-25	Passa-mão • Pasamano		1	L- 95mm

ACESSÓRIOS E JUNTAS • ACCESORIOS Y JUNTAS

REF.	DESCRIÇÃO • DESCRIPTION	QUANTIDADE • CANTIDAD	
		ABRIR PRATICABLE	OSCILO-BATENTE OSCILOBATIENTE
30 60 16 01	Esquadro Interior • Escuadra interior	8	
30 96 00 48	Esquadro exterior fixo • Escuadra exterior marco	4	
30 96 00 45	Esquadro exterior móvel • Escuadra exterior hoja	4	
30 96 00 22	Esquadro alinhamento móvel • Escuadra alineamiento hoja	8	
30 96 10 01	Calço para vidro • Calço para vidrio	4	6
30 60 16 41	Puxador • Manilla	1	
----	Ferragem Canal 16 • Herraje Canal 16	1	
30 92 01 02	Goteira • Tapa salida de aguas	2 ou mais	
30 93 01 20	Junta interior • Junta interior	2L + 2H	
30 60 16 30	Junta central • Junta central	2L + 2H	
30 60 16 31	Canto vulcanizado • Angulo vulcanizado	4	
31 90 85 47	Topo Julieta • Tope Julieta	4	
31 90 85 49	Tampa Julieta • Tapa Julieta	2	
---	Junta exterior vidro • Junta exterior vidrio	2L+2H	
---	Junta interior vidro • Junta interior vidrio	2L+2H	
---	Junta exterior Julieta vidro • Junta exterior Julieta vidrio	2.3mt	
---	Junta interior Julieta vidro • Junta interior Julieta vidrio	2.3mt	
30 90 85 75	Junta perfil passa-mão • Junta perfil pasamano	2L	
30 00 96 58	Parafuso auto-perfurante • Tornillo autoperforante	10	

VIDRO SACADA • VIDRIO BALCONERA

Hv = H-161 mm Lv = L-161 mm

VIDRO GUARDA • VIDRIO BARANDILLA

Hv = 1094 mm Lv = L-65 mm

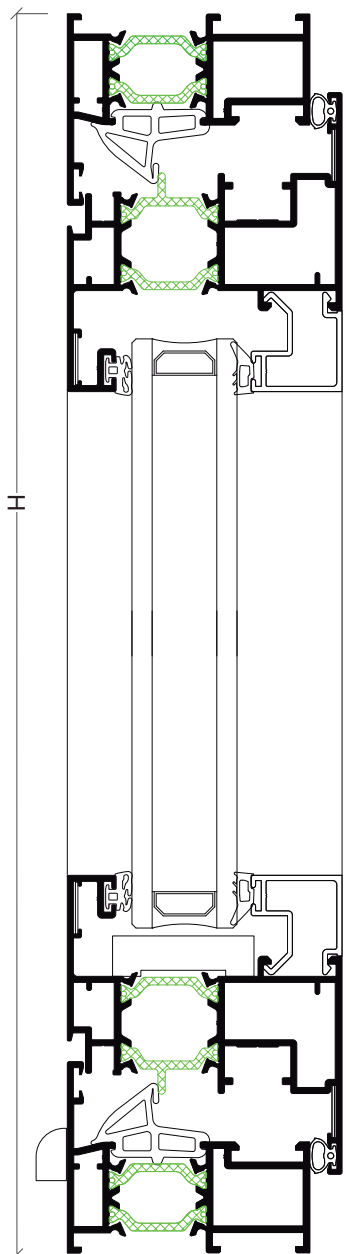
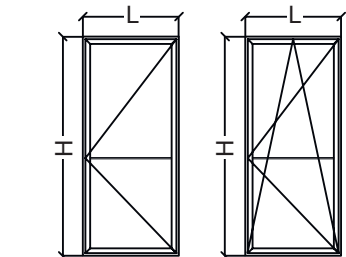

Hv Sacada

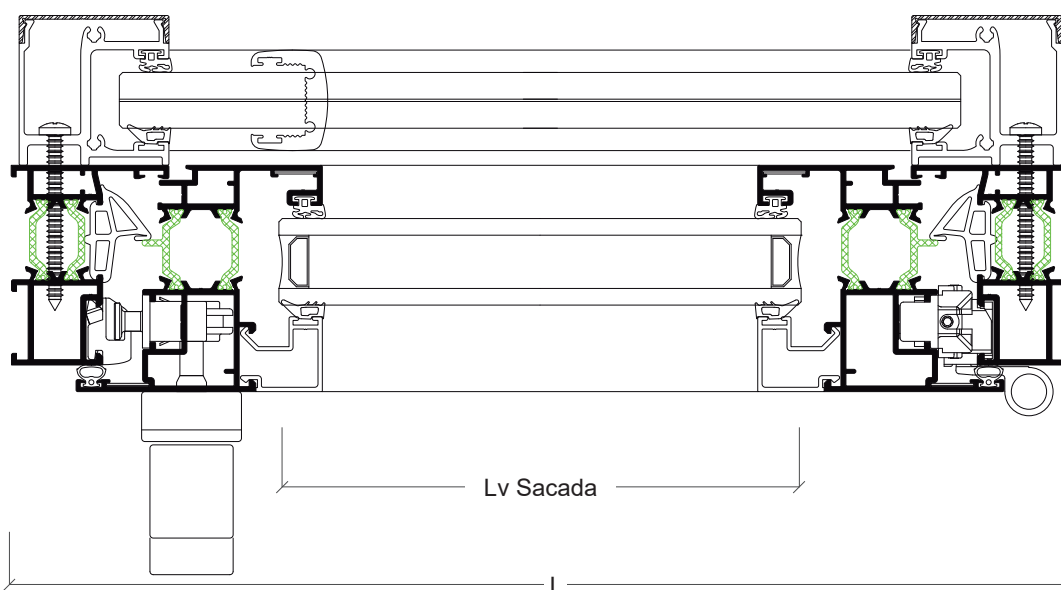

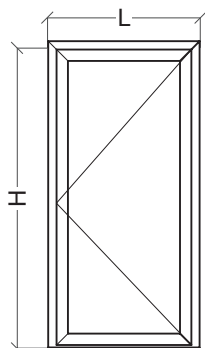
Porta de entrada 1 folha • Puerta 1 hoja

PERFIS • PERFIS

DESENHO • DISEÑO	REF.	DESCRIÇÃO • DESCRIPCIÓN	CORTE • CORTE	QUANTIDADE CANTIDAD	MEDIDAS • MEDIDA
	ARI-08	Aro fixo • Marco ventana		1	L
				2	H
	ARI-122/BI	Aro móvel • Hoja ventana		2	L- 73.5mm
				2	H- 46mm
	---	Bite • Junquillo		2	L- 233.5mm
				2	H- 246mm
	AJi-62	Pingadeira • Vierteaguas		1	L- 143mm
	ARI-99	Soleira • Acople		1	L- 80.5mm
	KL-04	Tampa • Tapa		1	L- 90mm

ACESSÓRIOS E JUNTAS • ACCESORIOS Y JUNTAS

REF.	DESCRIÇÃO • DESCRIPTION	QUANTIDADE CANTIDAD
30 60 16 02	Esquadro Interior Fixo • Escuadra interior marco	2
30 96 00 49	Esquadro exterior Fixo • Escuadra exterior marco	2
30 60 16 05	Esquadro interior móvel • Escuadra interior hoja	4
30 96 00 74	Esquadro exterior móvel • Escuadra exterior hoja	4
30 96 00 22	Esquadro alinhamento móvel • Escuadra alineamento hoja	8
30 60 16 39	Dobradiça 3 nós • Bisagra 3 nós	4
30 96 10 01	Calço para vidro • Calço para vidrio	6
30 60 16 51	Puxador duplo • Manilla doble	1
30 60 16 20	Fechadura 3 pontos • Cierre 3 puntos	1
30 60 16 21 ou 22	Conjunto chapa-testes para aro fixo • Conjunto chapa-testas para marco	1
30 60 16 56	Escudo para canhão • Escudo para bombillo	2
30 92 05 50	Canhão • Bombillo cierre	1
30 93 01 20	Junta interior • Junta interior	2L+2H
30 60 16 30	Junta central • Junta central	L+2H
30 60 16 31	Canto vulcanizado • Angulo Vulcanizado	2
30 60 00 13	Conjunto topos AJI-62 • Conjunto topes AJI-62	1
30 60 00 14	Pelúcia preta 18mm • Burlete Negro 18mm	2L
---	Junta exterior vidro • Junta exterior vidrio	2L+2H
---	Junta interior vidro • Junta interior vidrio	2L+2H

VIDRO • VIDRIO

Hv = H-220 mm	Lv = L-247 mm
---------------	---------------

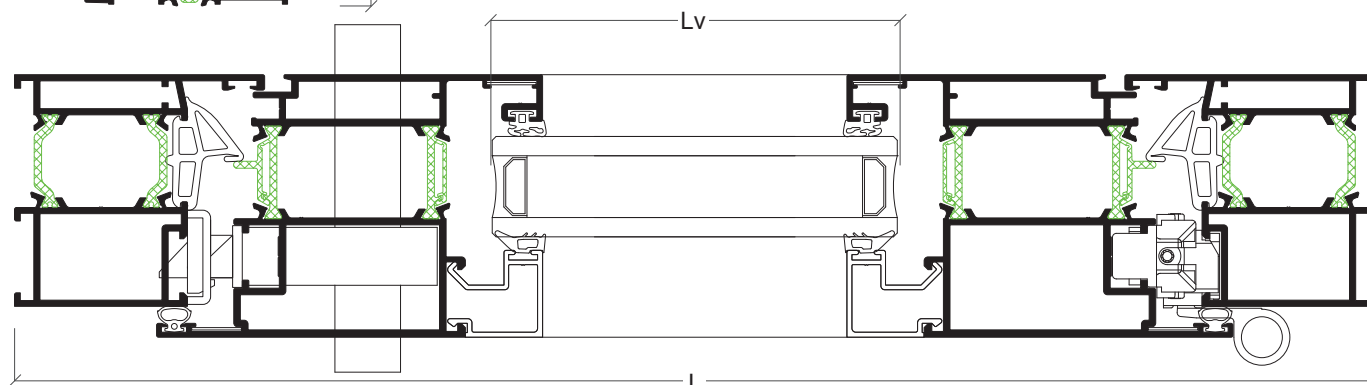
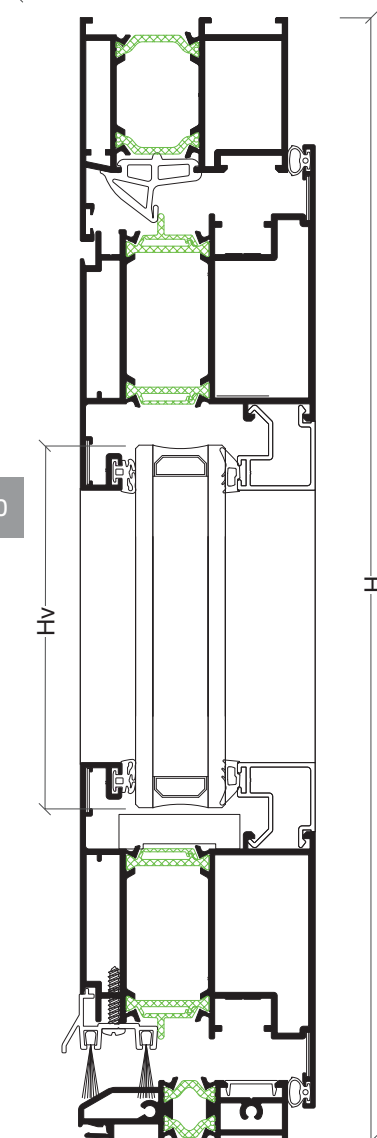

Porta de entrada oculta com painel • Puerta de entrada oculta con panel
PERFIS • PERFIS

DESENHO • DESEÑO	REF.	DESCRIÇÃO • DESCRIPCIÓN	CORTE • CORTE	QUANTIDADE CANTIDAD	MEDIDAS • MEDIDA
	ARi-08	Aro fixo • Marco ventana		1	L
	ARi-123/BI	Aro móvel • Hoja ventana		2	L- 73.5mm
	AX-82	Bite • Junquillo		2	L- 233.5mm
	APi-62	Pingadeira (com malhete) • Vierteaguas		1	L- 143mm
	ARi-99	Soleira • Acople		1	L- 80.5mm
	KL-04	Tampa • Tapa		1	L- 90mm

ACESSÓRIOS E JUNTAS • ACCESORIOS Y JUNTAS

REF.	DESCRIÇÃO • DESCRIPTION	QUANTIDADE CANTIDAD
30 60 16 02	Esquadro Interior Fixo • Escuadra interior marco	2
30 96 00 49	Esquadro exterior Fixo • Escuadra exterior marco	2
30 96 16 05	Esquadro interior móvel • Escuadra interior hoja	4
30 96 00 74	Esquadro exterior móvel • Escuadra exterior hoja	4
30 96 00 22	Esquadro alinhamento móvel • Escuadra alineamento hoja	8
30 60 16 39	Dobradiça 3 nós • Bisagra 3 nós	4
30 96 10 01	Calço para vidro • Calço para vidrio	6
30 60 16 51	Puxador duplo • Manilla doble	1
30 60 16 20	Fechadura 3 pontos • Cierre 3 puntos	1
30 60 16 21 ou 22	Conjunto chapa-testes para aro fixo • Conjunto chapa-testes para marco	1
30 92 05 50	Canhão • Bombillo cierre	1
30 93 01 20	Junta interior • Junta interior	2L+2H
30 60 16 30	Junta central • Junta central	L+2H
30 60 16 31	Canto vulcanizado • Angulo Vulcanizado	2
30 60 00 19	Conjunto topos API-62 • Conjunto topos API-62	1
30 60 00 14	Pelúcia preta 18mm • Buriete Negro 18mm	2L
30 60 00 17	Junta para painel (exterior) • Junta para panel (exterior)	2L+2H
30 94 64 83	Junta para painel (interior) • Junta para panel (interior)	2L+2H
-----	Sistema Magnitude • Sistema Magnitud	vários

PAINEL • PANEL

Hp = H-218 mm	Lp = L-246 mm
---------------	---------------

CHAPAS DE ALUMÍNIO 2.5mm • PLACAS DE ALUMINIO 2.5mm

Hch (exterior) = H-95mm Hch (interior) = H-46mm	Lch (exterior) = L-139mm Lch (interior) = L-74mm
--	---

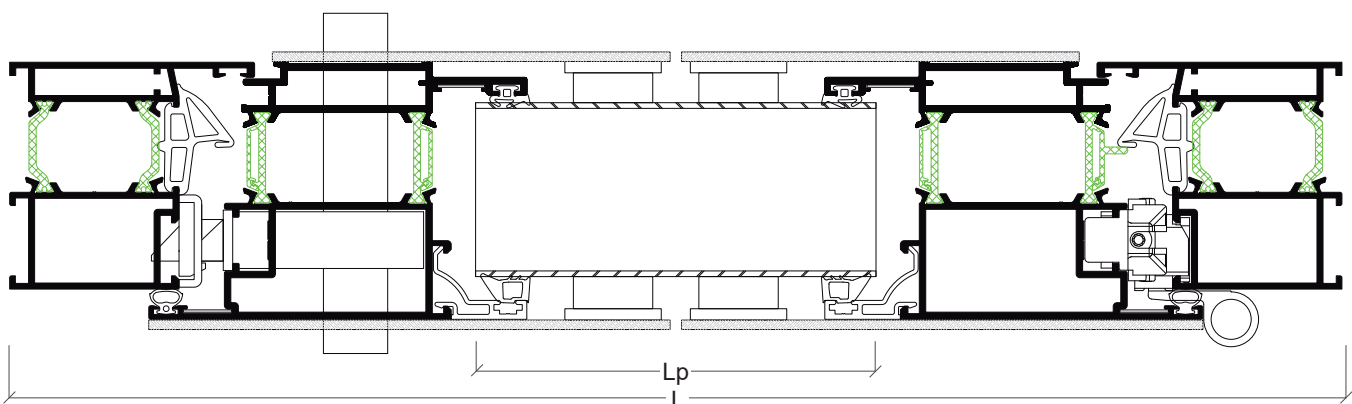
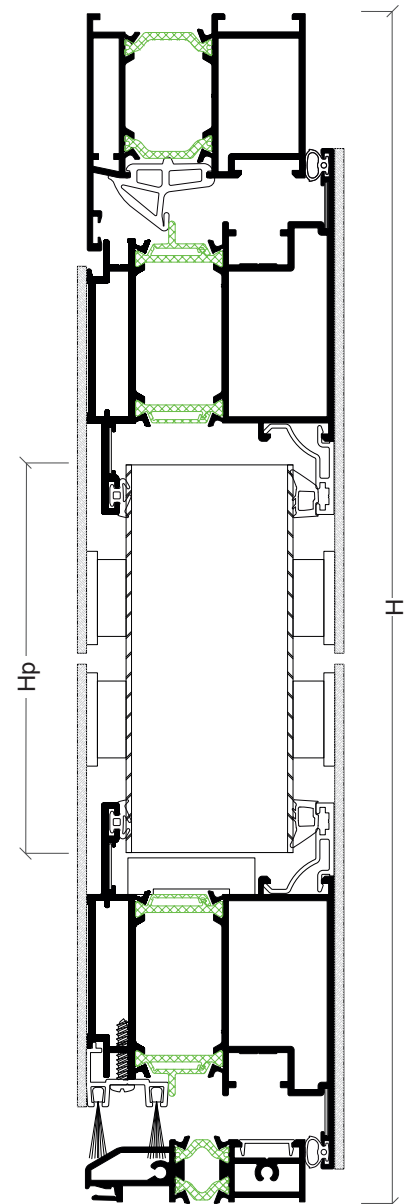
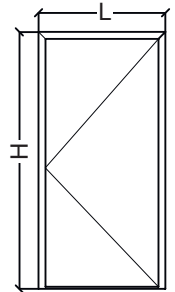

PORTUGAL

ALGARVE

AVEIRO

CASTELO BRANCO

CHAVES

COIMBRA

GUARDA

LEIRIA

LISBOA

MINHO

PORTO

S.J. DA MADEIRA

UISEU

ESPAÑHA

CÁDIS

CORDOBA

GRANADA

IBIZA

JAÉN

LEÓN

MADRID

MÁLAGA

MAIORCA

MÚRCIA

OURENSE

SEVILHA

VALÈNCIA

