

Índice

AXi	3 - 34
ATi	35 - 58
ARi	59 - 92
AJi	92 - 120
AKi	121 - 152
APi	153 - 180
AX	181 - 206
AZ	207 - 232
A1	233 - 246
XP	247 - 268
BE	269 - 280
CT	281 - 306
CW	307 - 322
CTe	323 - 336
Kristal	337 - 348
CL	349 - 370
CM	371 - 384
CP	385 - 394
CK	395 - 404
CS	405 - 422
SR	423 - 430
Fachadas	431 - 514
BL	515 - 526
Standard	527 - 550

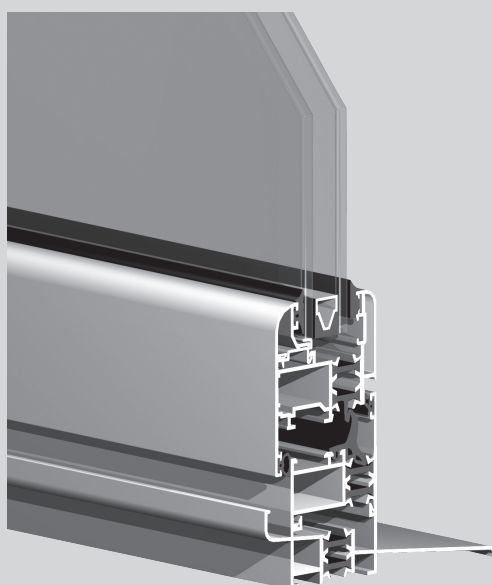

Sistema
AXi

Sistema AXi

Sistema de batente com RPT - 45 mm

Características do sistema

Sistema de batente com rotura térmica e de elevadas prestações térmicas e acústicas.

O sistema AXi possibilita a execução de 4 versões de caixilharia:

1. linha recta;
2. linha curva;
3. linha tradição;
4. linha oval.

O sistema AXi permite a aplicação de vidros duplos de alto rendimento de modo a responder às exigências de isolamento térmico e acústico.

Perfis de alumínio

Os perfis de alumínio são extrudidos na liga de alumínio 6060 para arquitectura de acordo com norma NP EN 12020-02.

Perfis com rotura térmica obtida por inserção de varetas isolantes de poliamida de 14.6 mm reforçadas com 25% de fibra de vidro.

Espessura média dos perfis de alumínio de 1.5 mm para janelas e de 1.7 mm para portas.

Aros fixos

Secção dos aros fixos de 45 mm ou 70 mm;

Aros fixos com esquadro para montagem a meia esquadria;

Aros fixos tradicionais para mercado interno;

Aros fixos com clip exterior e aba de remate direta de 25 mm ou 45 mm;

Aros fixos com clip exterior e interior para aplicação de remate de 30 mm.

Aros móveis

Secção dos aros móveis de 53 mm;

Enchimento para vidro simples ou duplo de 4 mm a 37 mm;

Aros móveis de linha recta, curva, tradição ou oval (sem bite);

Aros móveis com esquadro para montagem a meia esquadria;

Perfil inversor de linha recta.

Dimensionamento e manobralidade

Dimensões mínimas - máximas de folha: 400 mm - 1500 mm (L); 400 mm - 2700 mm (H);

Possibilidades de abertura: fixo, batente interior 1 ou 2 folhas com oscilo-batente, exterior, basculante, projectante, pivotante, harmónio e oscilo-paralela;

Estanquidade assegurada através de juntas triplas em EPDM;

Performances

Sistema certificado por laboratório notificado para Ensaio Tipo Inicial (ITT) de acordo com a norma de produto EN 14351-1 para efeitos de Marcação CE.

Categorias alcançadas na avaliação do sistema AXi tipologia janela:

1. Permeabilidade ao ar: Classe 4 (norma de ensaio EN 1026)
2. Estanquidade à água: Classe E900 (norma de ensaio EN 1027)
3. Resistência ao vento: Classe C5 (norma de ensaio EN 12211)

Categorias alcançadas na avaliação do sistema AX tipologia porta:

1. Permeabilidade ao ar: Classe 4 (norma de ensaio EN 1026)
2. Estanquidade à água: Classe 8A (norma de ensaio EN 1027)
3. Resistência ao vento: Classe C3 (norma de ensaio EN 12211)
4. Resistência à torção estática: Apto 350N (norma de ensaio EN 14609)

Coefficiente de transmissão térmica de vão de 2 folhas com 1.20 m x 1.50 m com vidro $U_g = 0.7 \text{ W/m}^2\text{K}$, com intercalar efeito "Warm Edge":

• $U_w = 1.72 \text{ W/m}^2\text{K}$

Coefficiente de atenuação acústica de vão de 2 folha com vidro 4/14/6:

• $R_w (C; C_{tr}) = 34 \text{ dB} (-1; -4)$

Zonas de aplicação segundo RCCTE (em função do valor U_g): I1, I2, I3, V1, V2, V3.

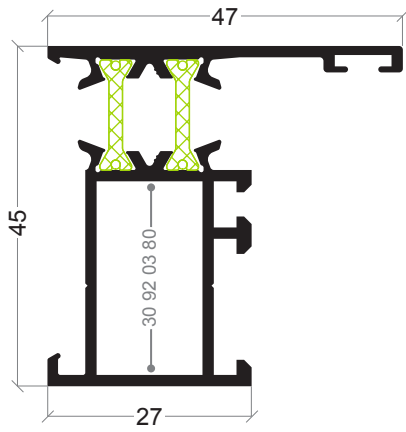

AXi-03
Aro fixo

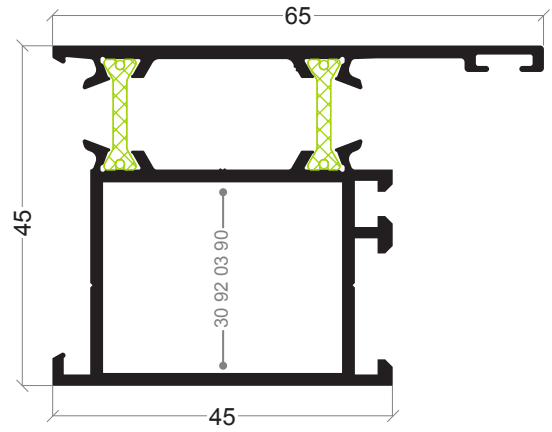

AXi-08
Aro fixo

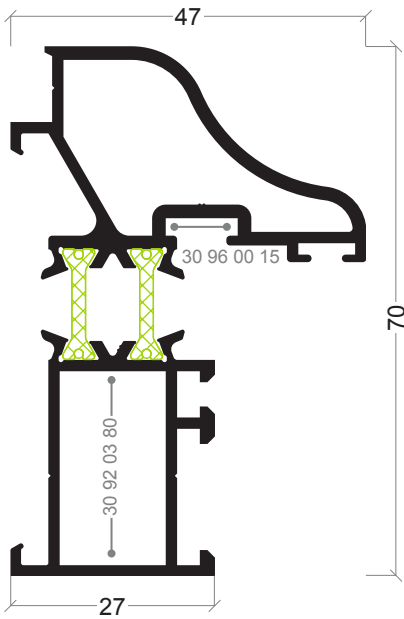

AXi-49
Aro fixo

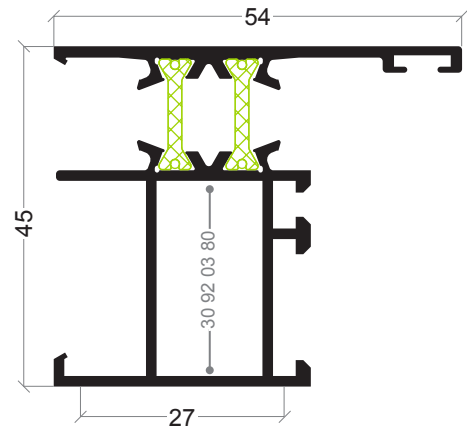

AXi-81
Aro fixo

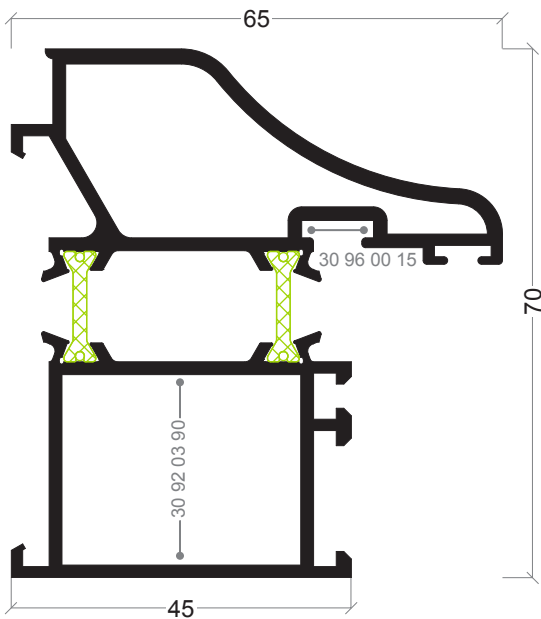

AXi-50
Aro fixo

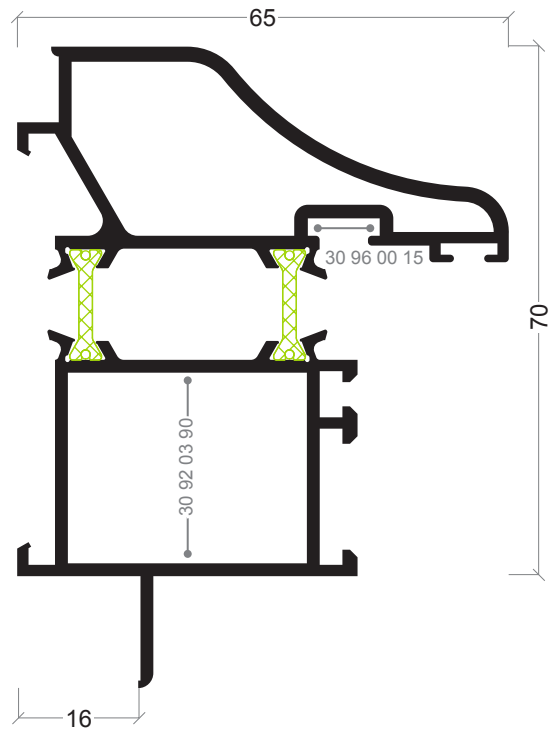

AXi-51
Aro fixo para apanelado

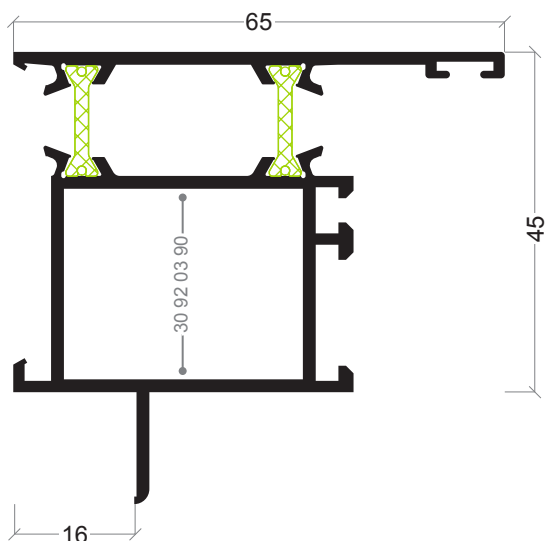

AXi-48
Aro fixo para apainelado

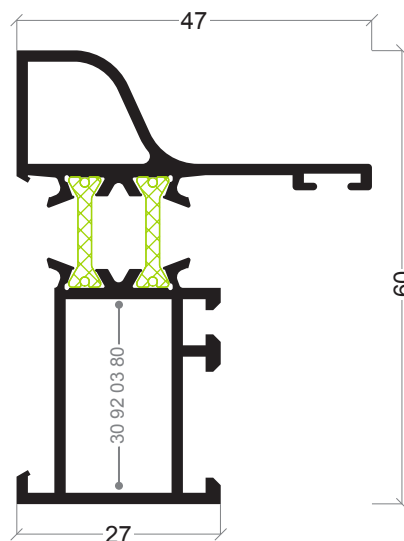

AXi-33
Aro fixo

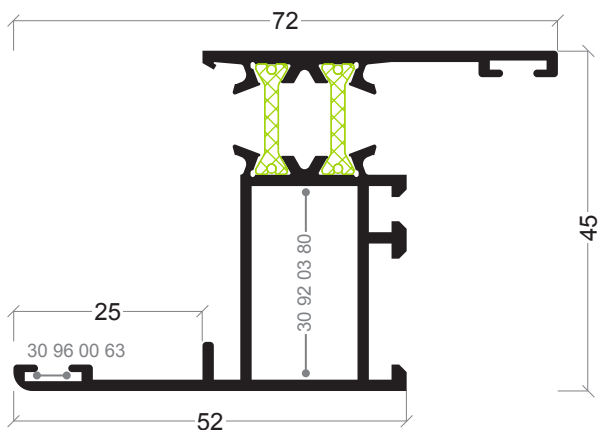

AXi-25
Aro fixo com remate

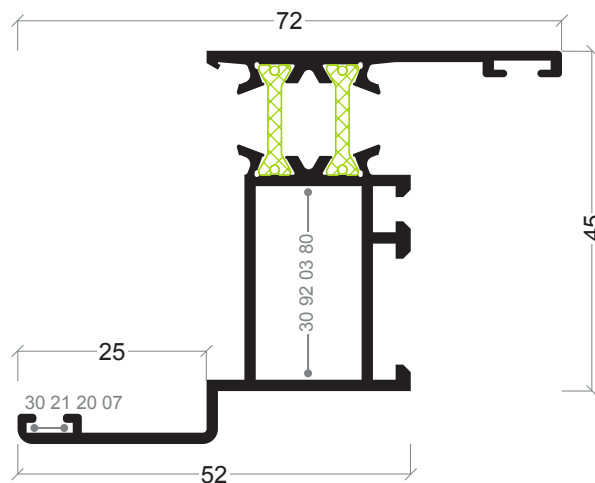

AXi-19
Aro fixo com remate

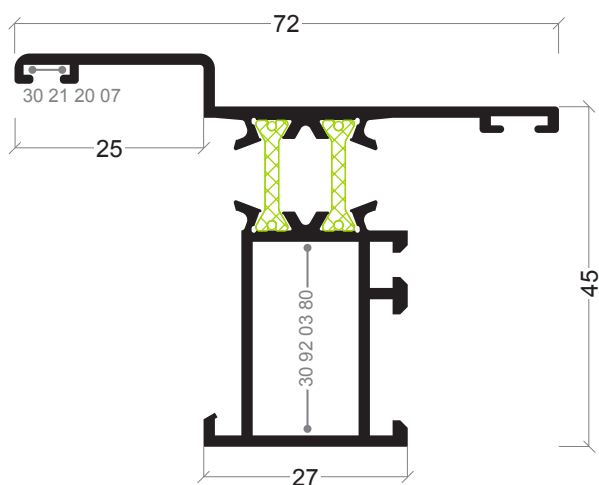

AXi-23
Aro fixo com remate

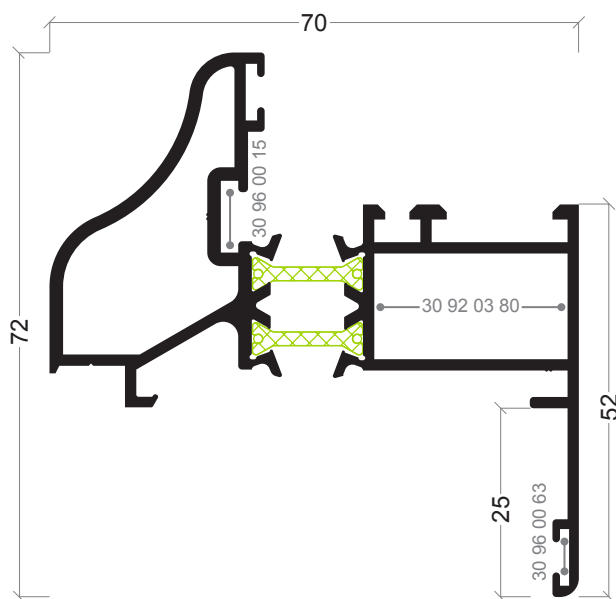

AXi-58
Aro fixo com remate

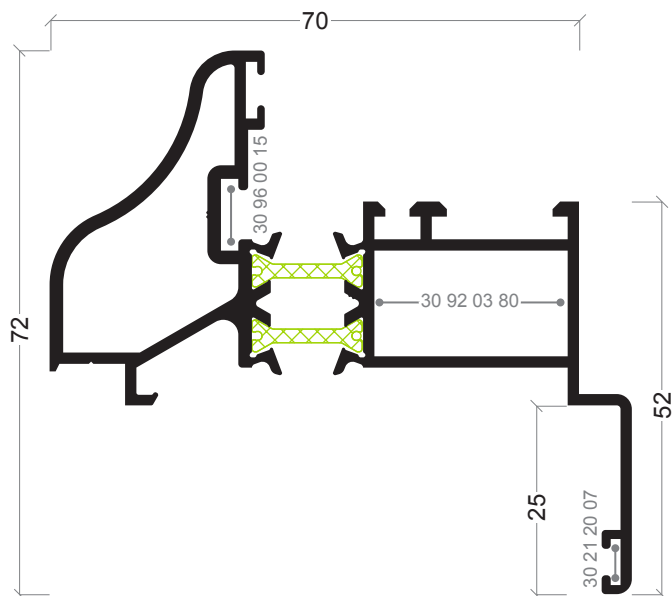

AXi-56
Aro fixo com remate

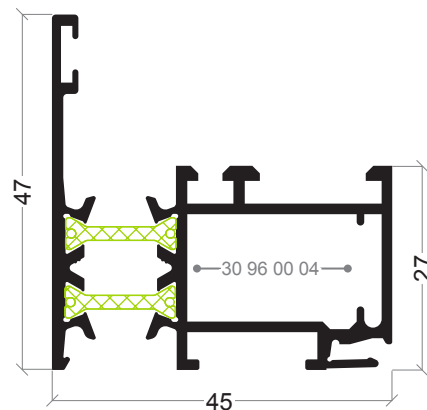

AXi-90
Aro fixo

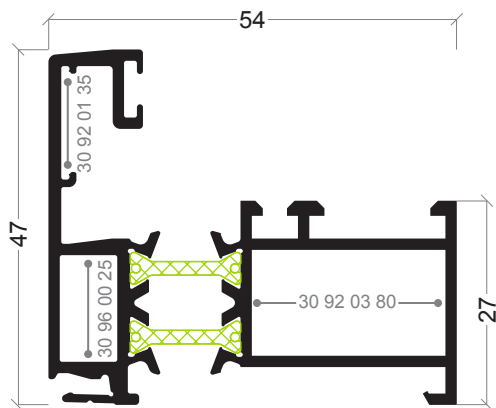

AXi-86
Aro fixo

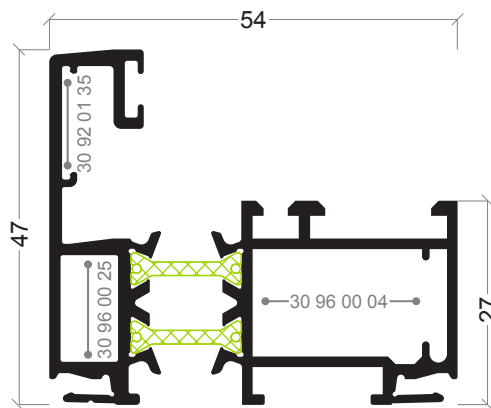

AXi-87
Aro fixo

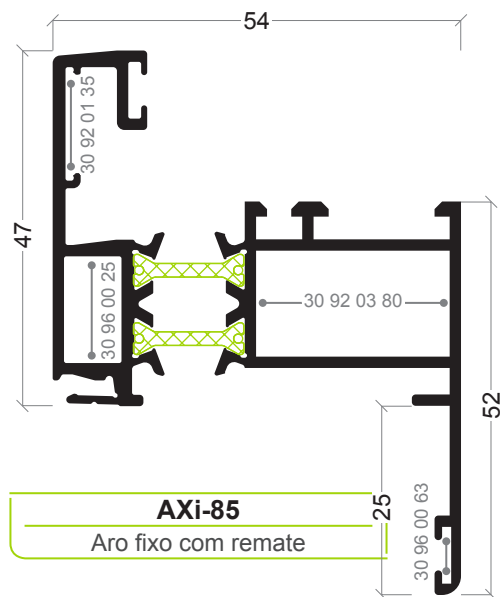

AXi-85
Aro fixo com remate

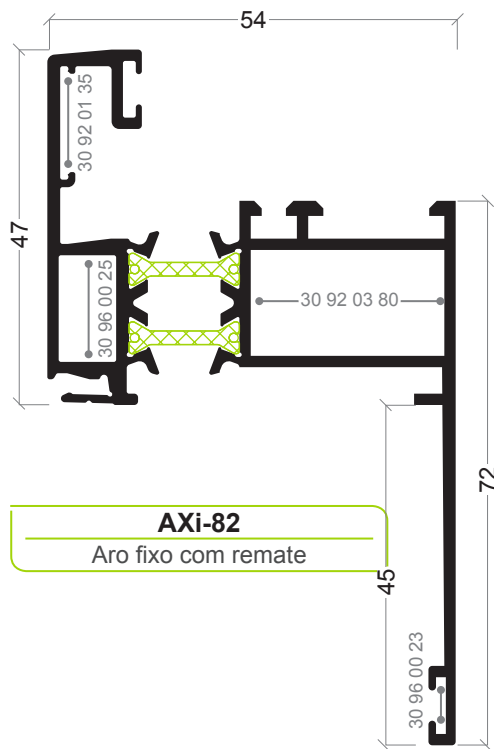

AXi-82
Aro fixo com remate

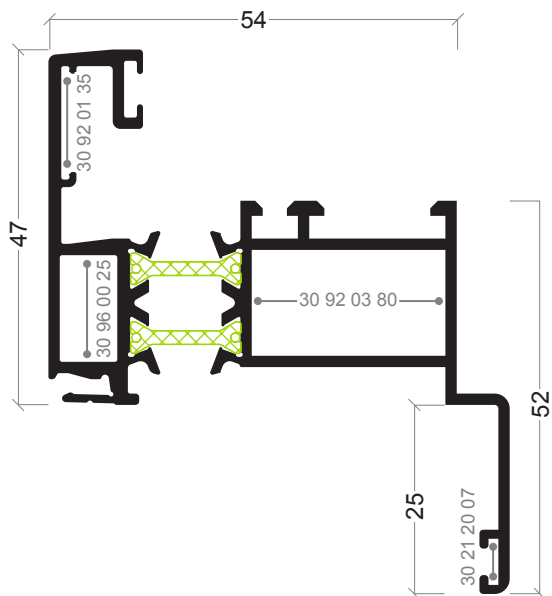

AXi-84
Aro fixo com remate

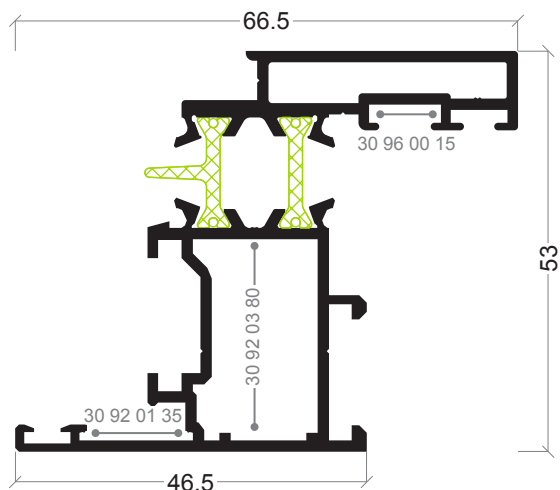

AXi-64
Aro móvel

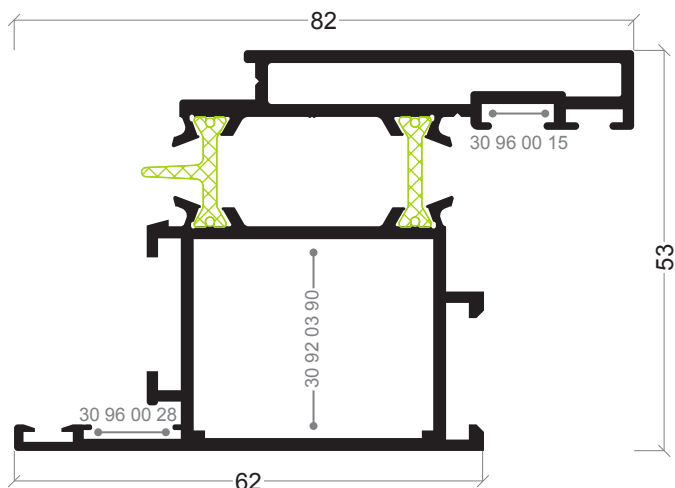

AXi-65
Aro móvel

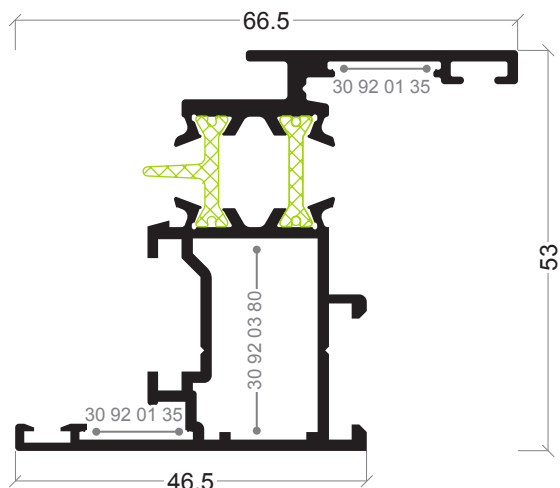

AXi-02
Aro móvel

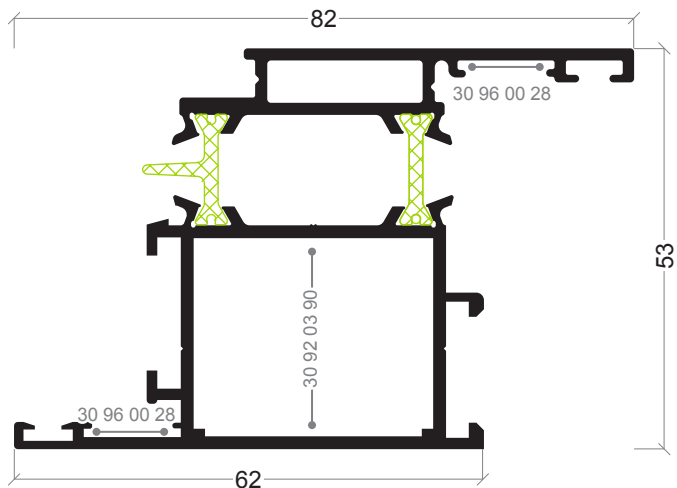

AXi-07
Aro móvel

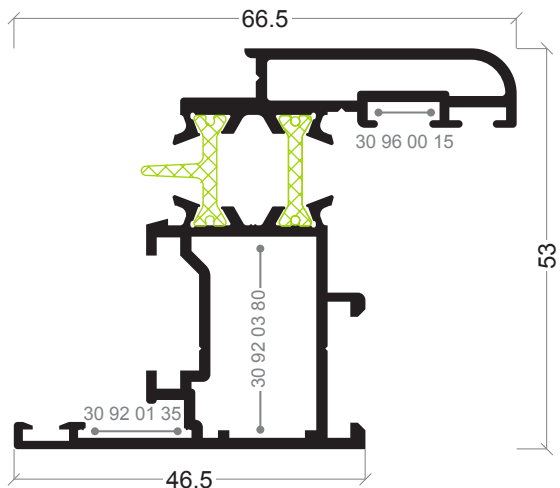

AXi-24
Aro móvel

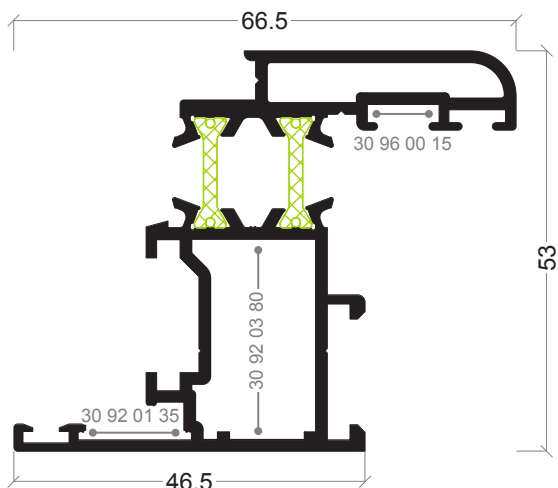

AXi-05
Aro móvil

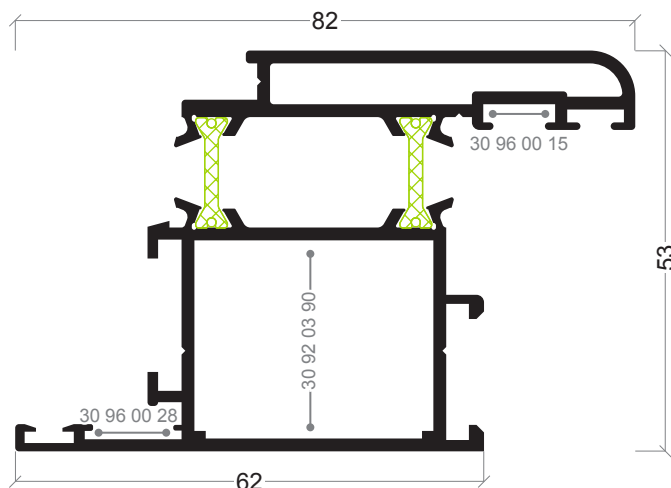

AXi-10
Aro móvil

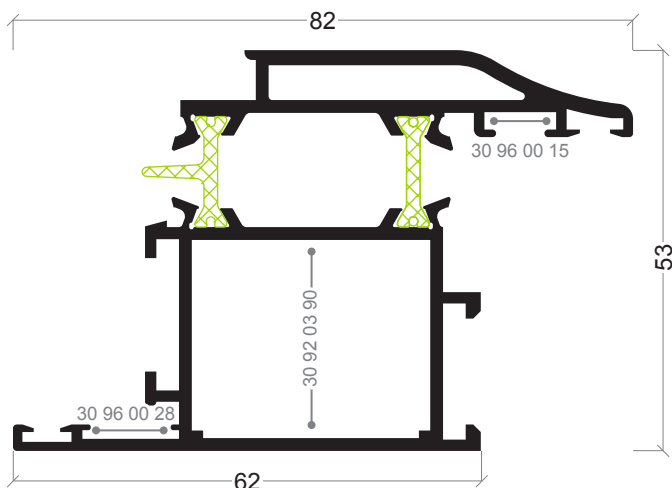

AXi-53
Aro móvil

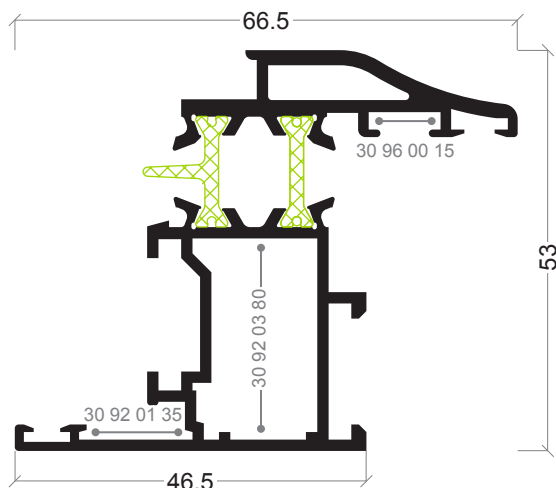

AXi-52
Aro móvil

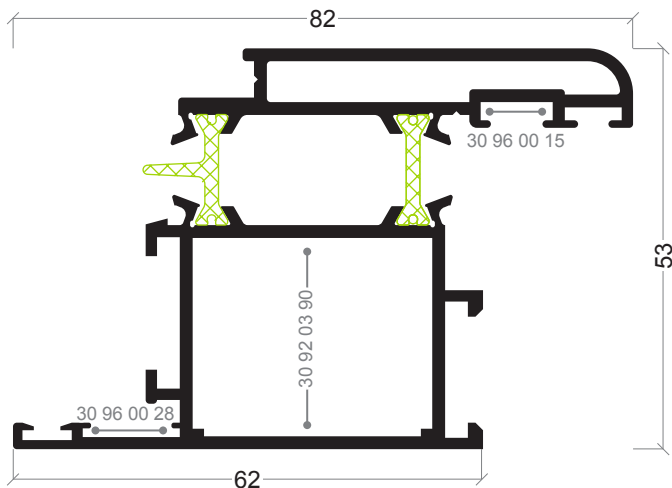

AXi-27
Aro móvil

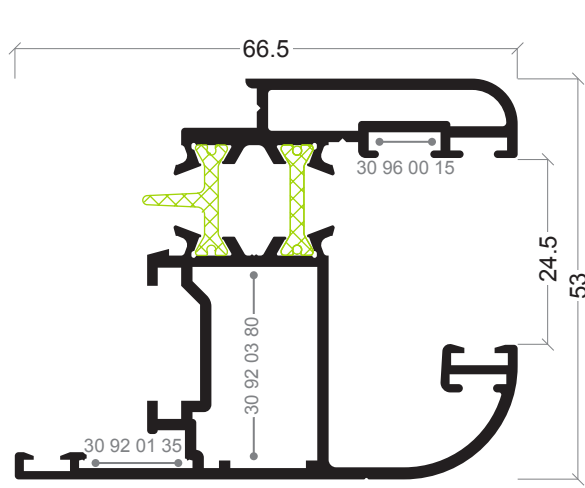

AXi-44
Aro móvil

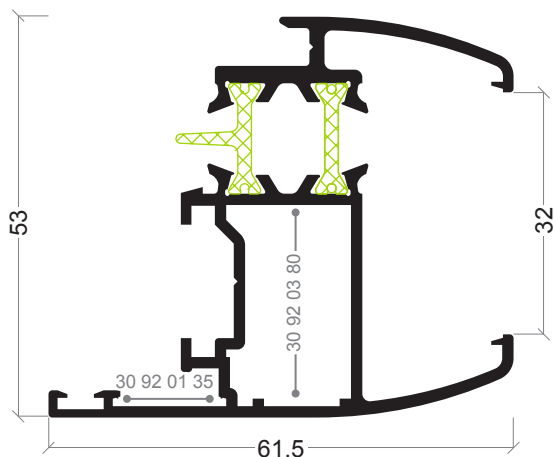

AXi-76
Aro móvel

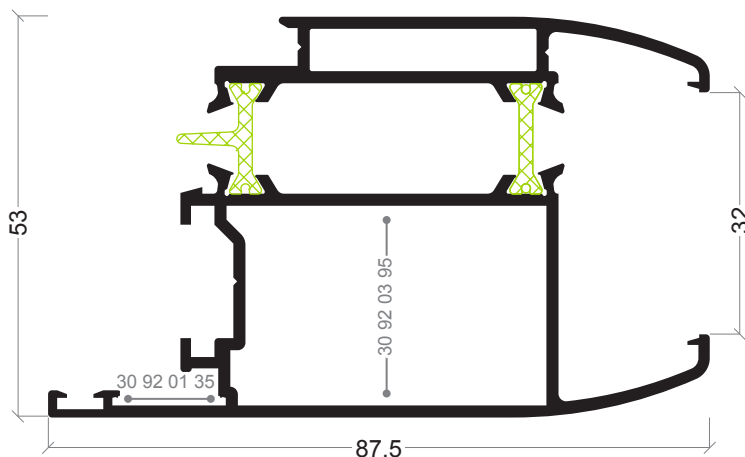

AXi-77
Aro móvel

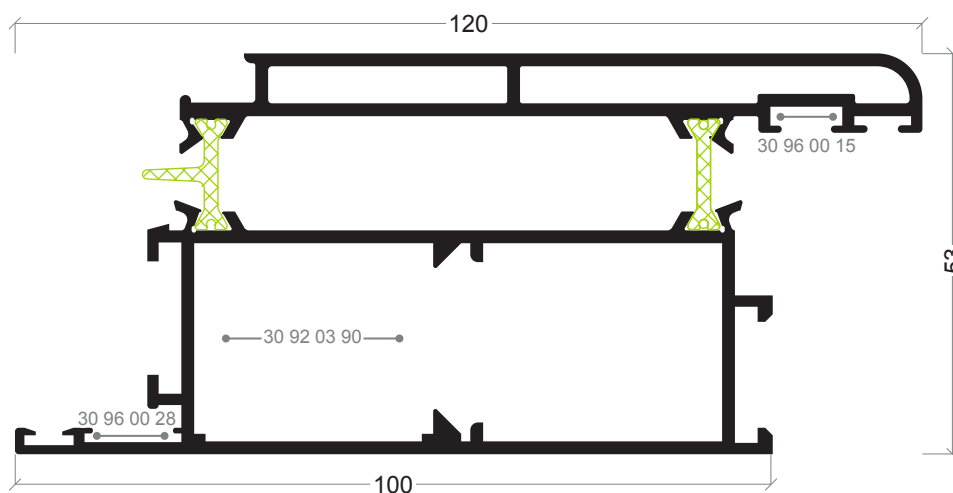

AXi-66
Aro móvel

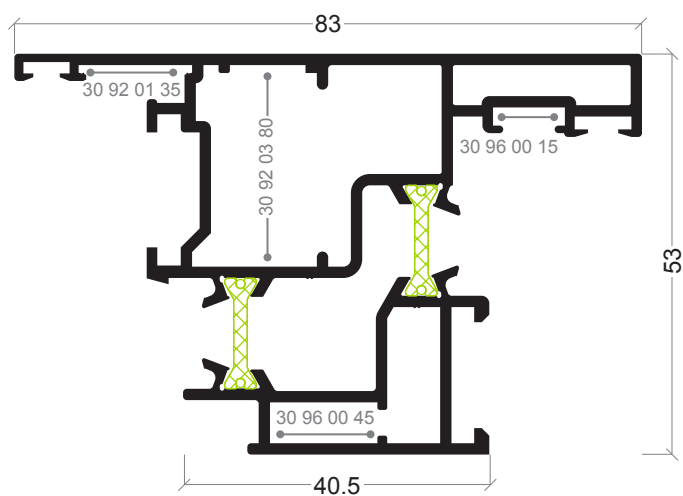

AXi-60
Aro móvel abertura exterior

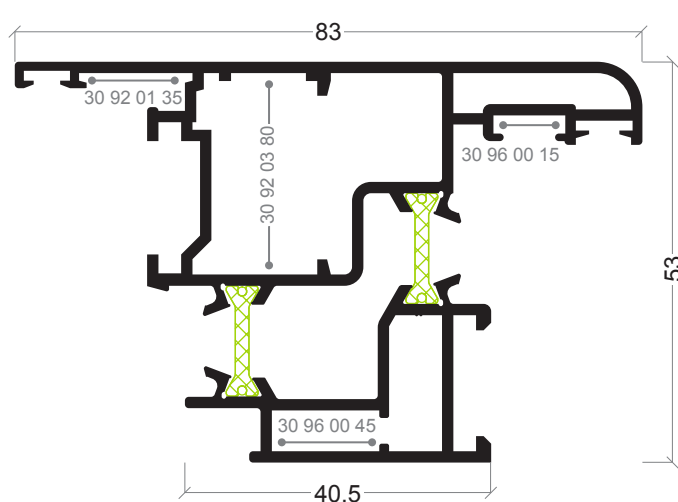

AXi-59
Aro móvel abertura exterior

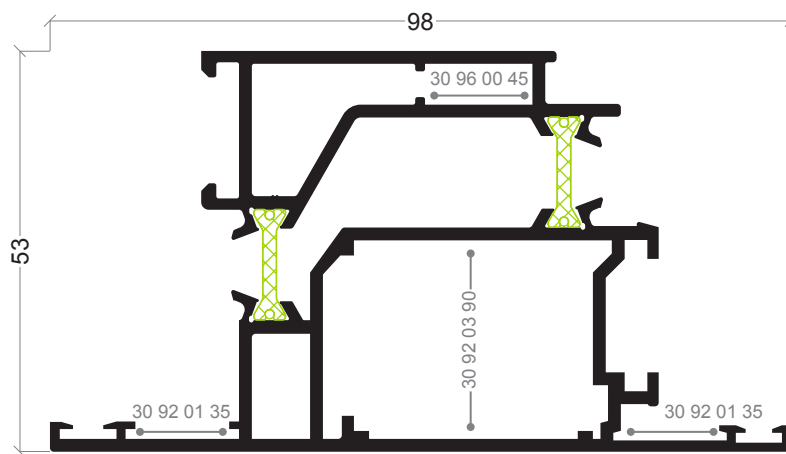

AXi-71
Aro móvel abertura exterior

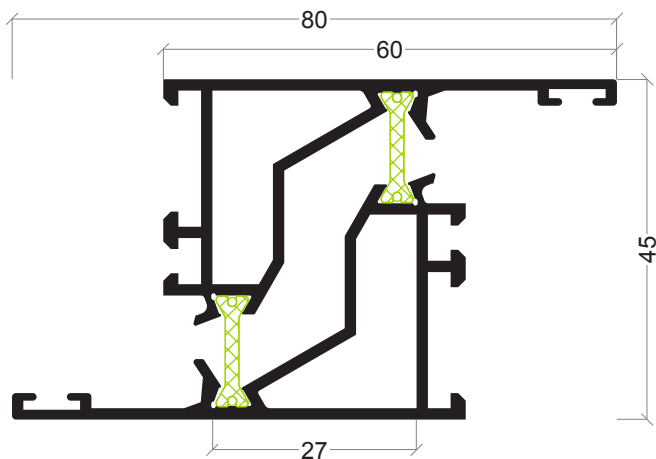

AXi-61
Aro fixo abertura exterior c/ fixo lateral

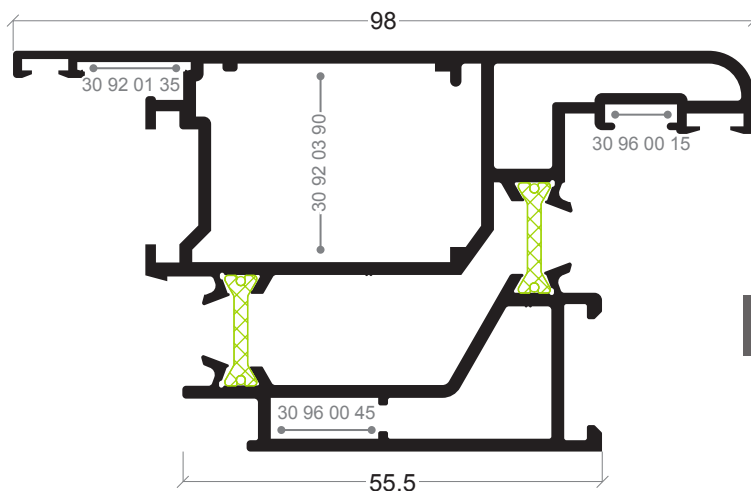

AXi-62
Aro móvel abertura exterior

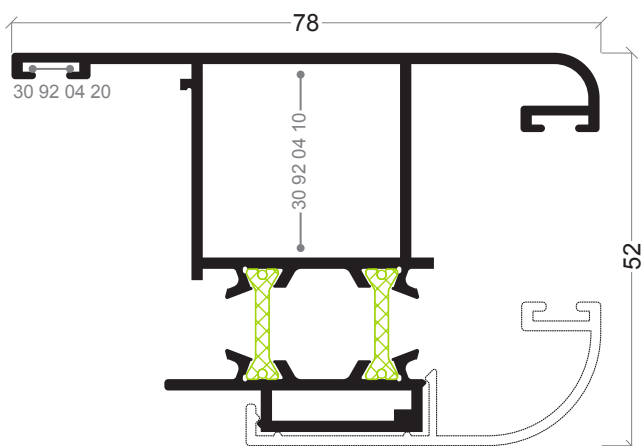

AXi-26
Aro móvel abertura exterior



AZ-29
Bite para AXi-26

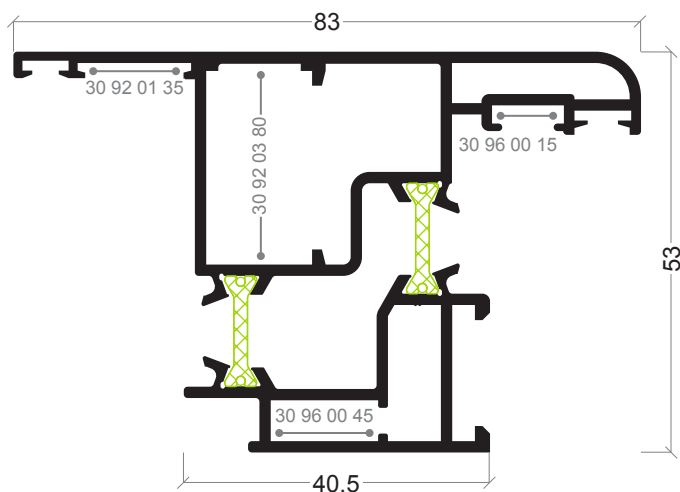

AXi-63
Aro móvel projectante



AXi-31
Guia abertura projectante

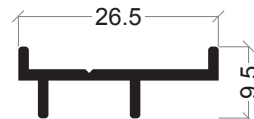

AXi-32
Complemento abertura projectante

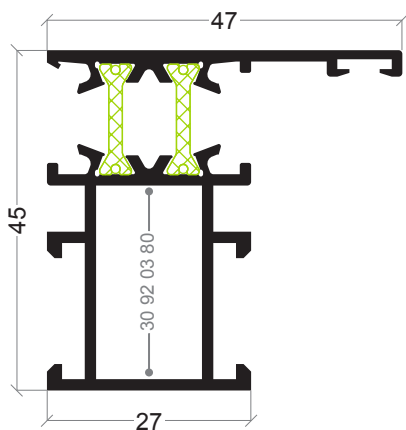

AXi-38
Aro fixo pivotante

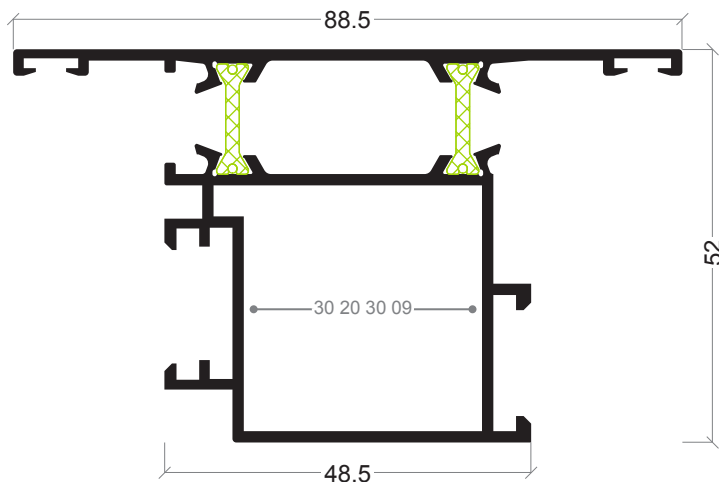

AXi-40
Aro móvel pivotante

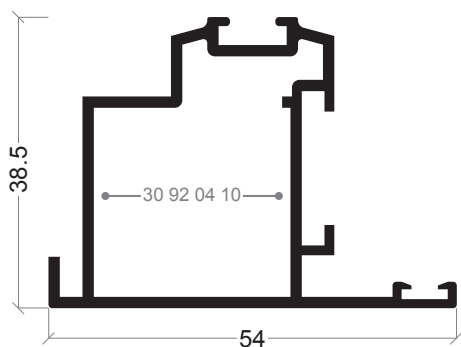

AXi-41
Inversor pivotante

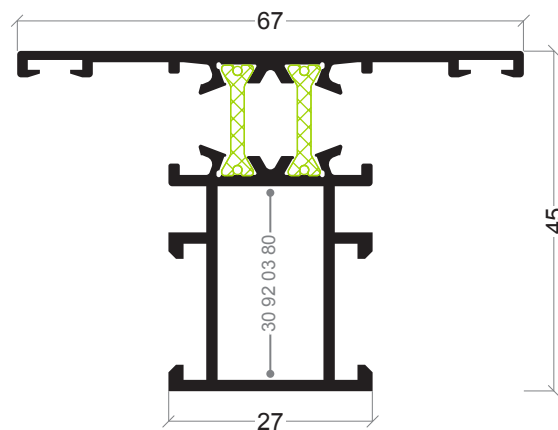

AXi-39
Travessa pivotante

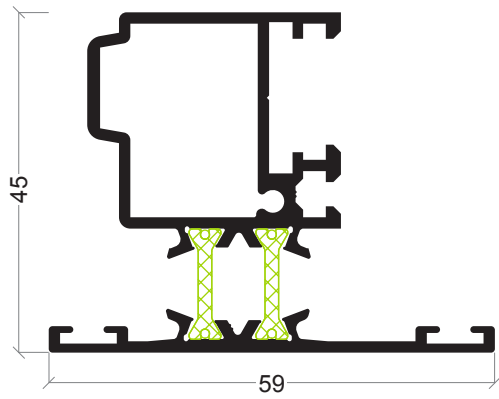

AXi-04
Inversor

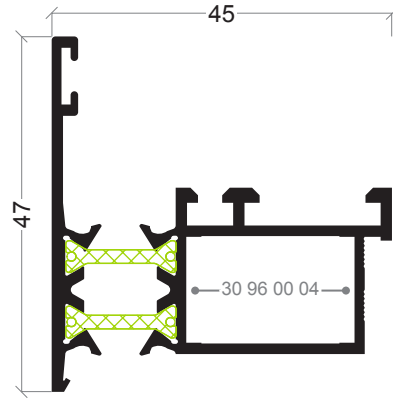

AXi-75
Inversor abertura exterior

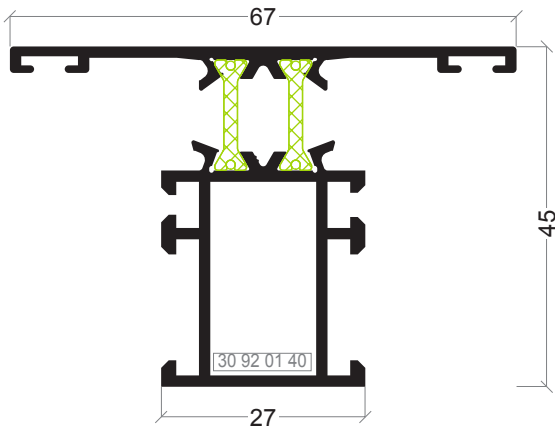

AXi-01
Travessa

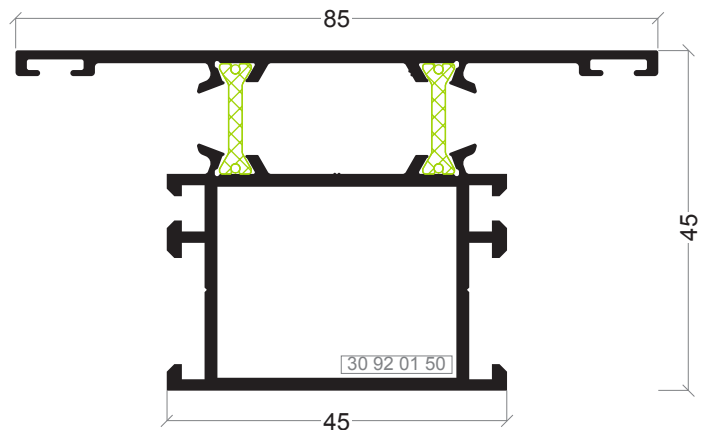

AXi-06
Travessa

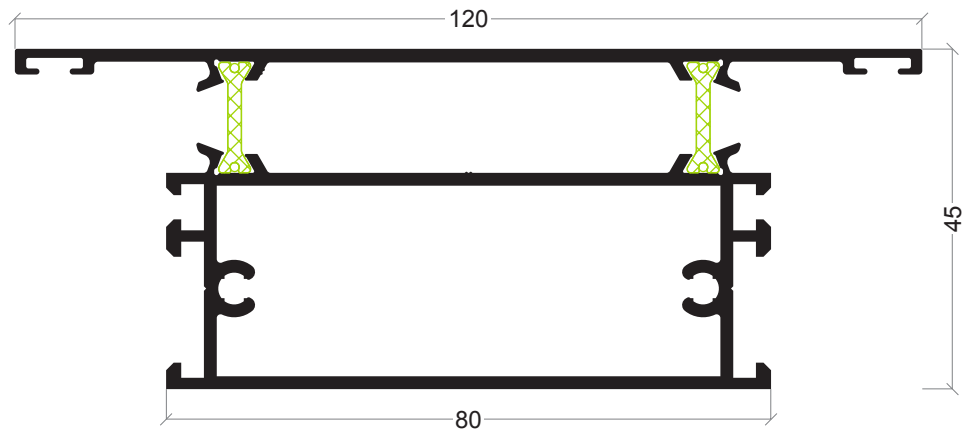

AXi-12
Travessa

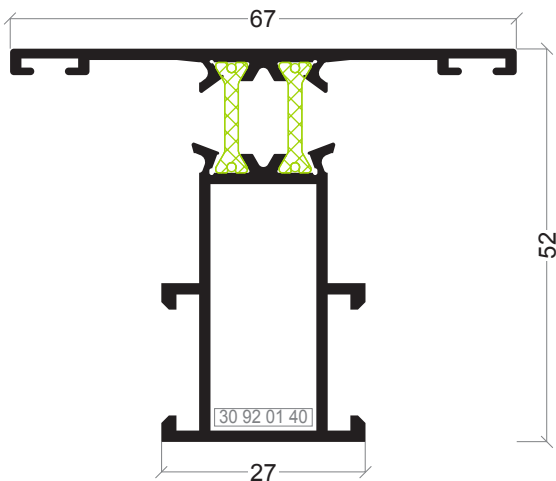

AXi-09
Travessa

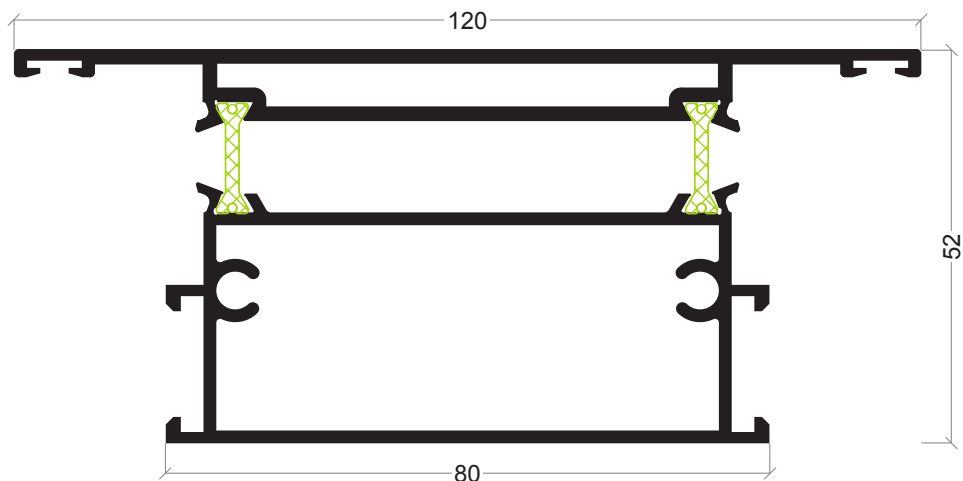

AXi-13
Travessa

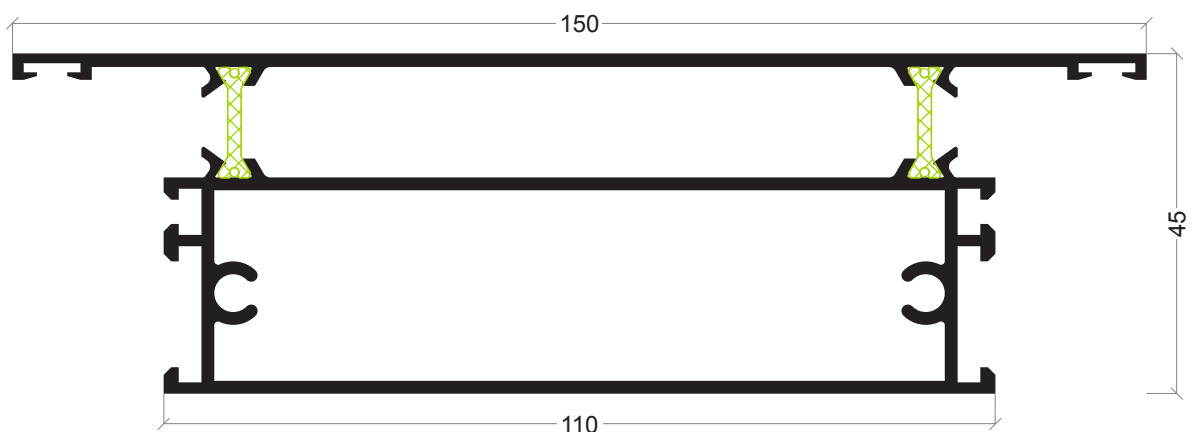

AXi-14
Travessa

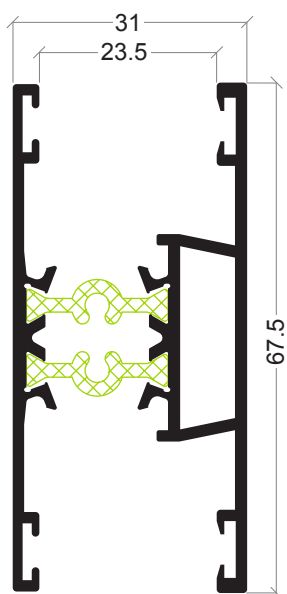

AXi-43
Travessa para AXi-44

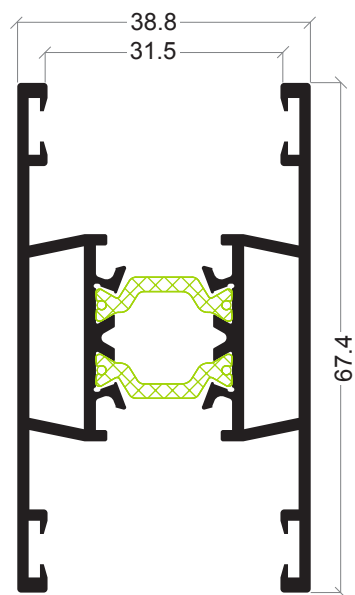

AXi-79
Travessa para AXi-77

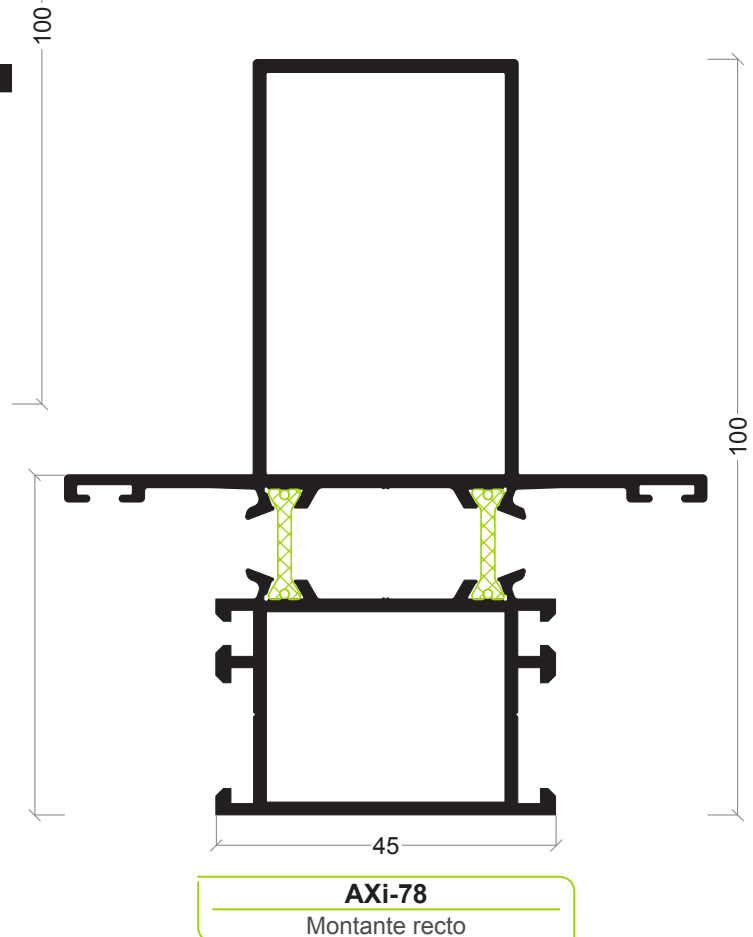
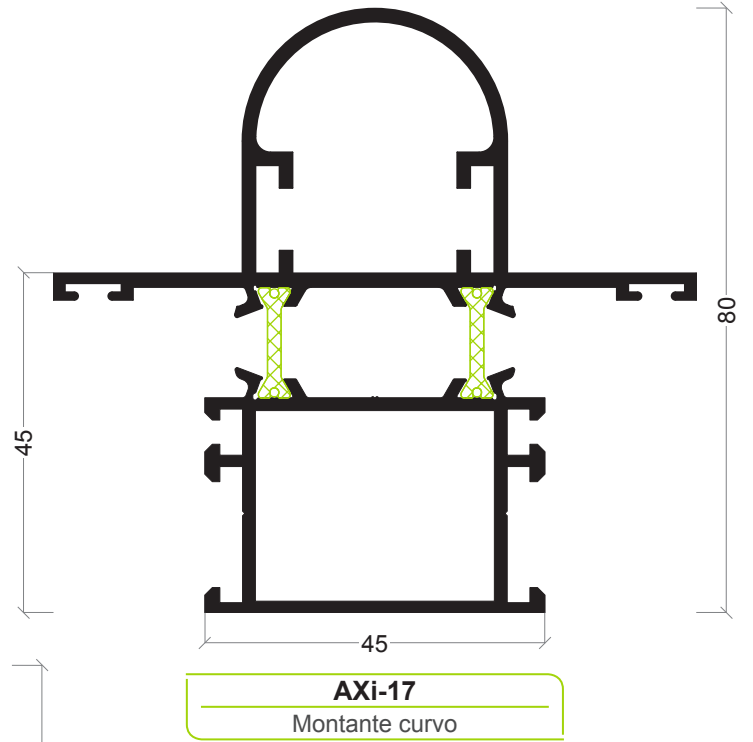
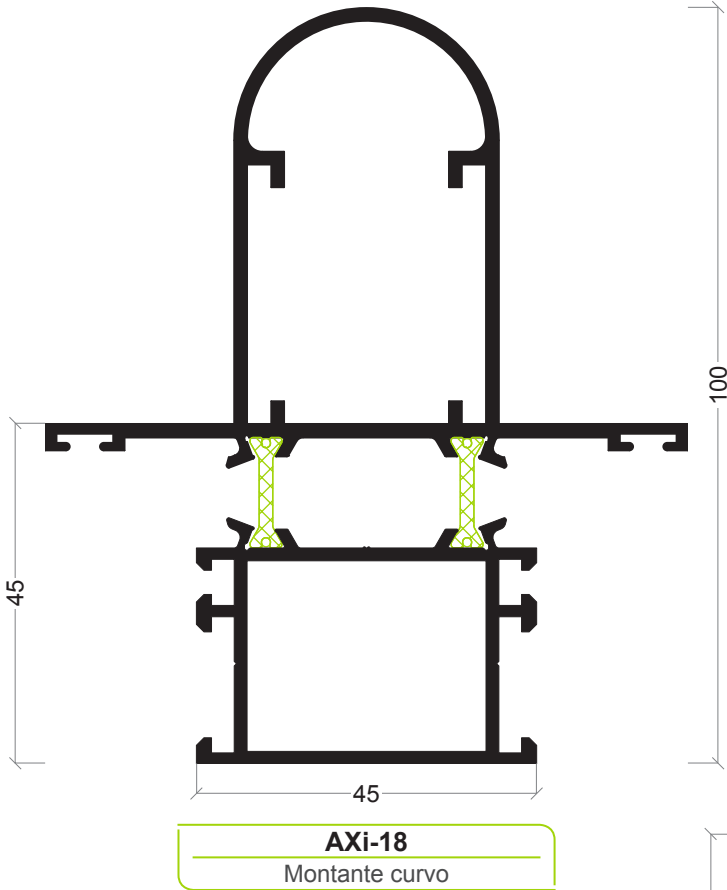

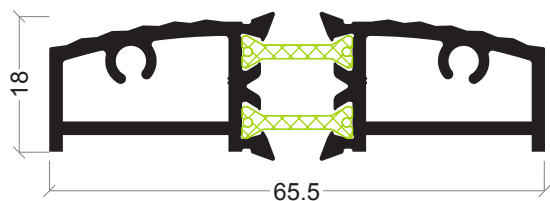

AXi-69
Remate inferior porta

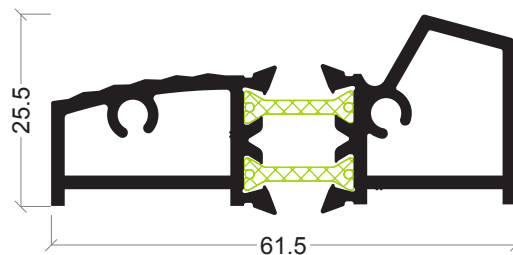

AXi-70
Remate inferior porta

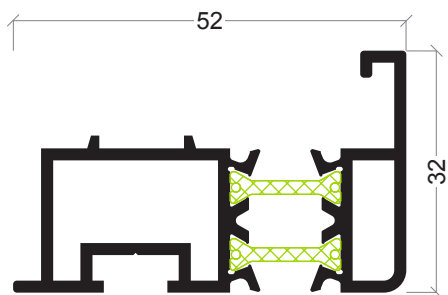

AXi-42
Remate almofada

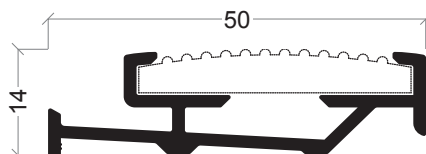

AZ-69
Remate inferior porta

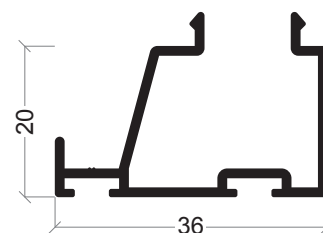

AX-15
Bite remate

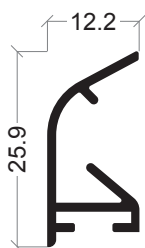

AZ-60
Pingadeira



AZ-61
Clip pingadeira

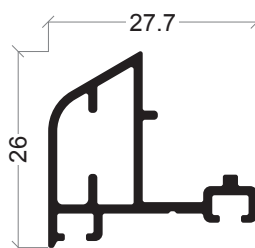

AZ-79
Pingadeira

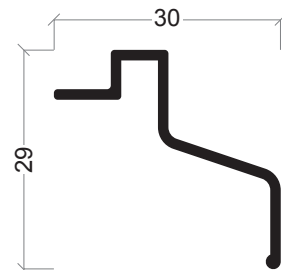

AXi-45
Pingadeira

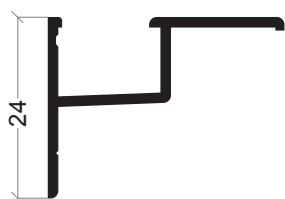

Y-20
Recolha de águas condensação

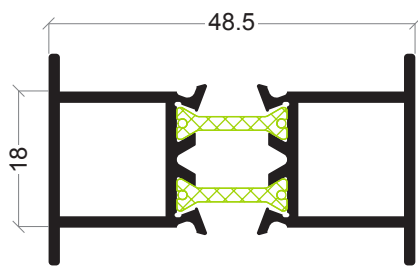

AXi-54
União de aros

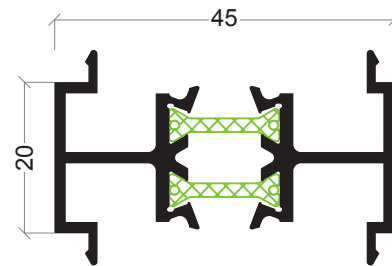

AXi-15
União de aros

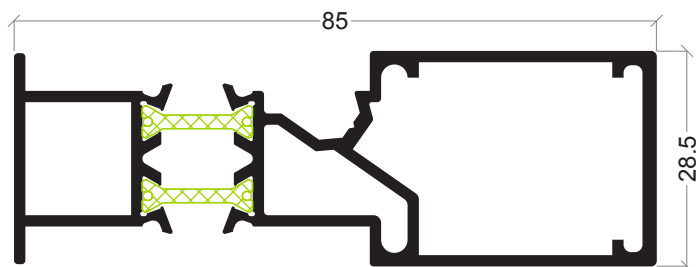

AXi-67
União de aros com reforço



AX-19
Vareta

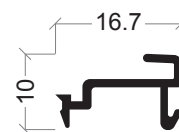

AX-33
Mola Bite

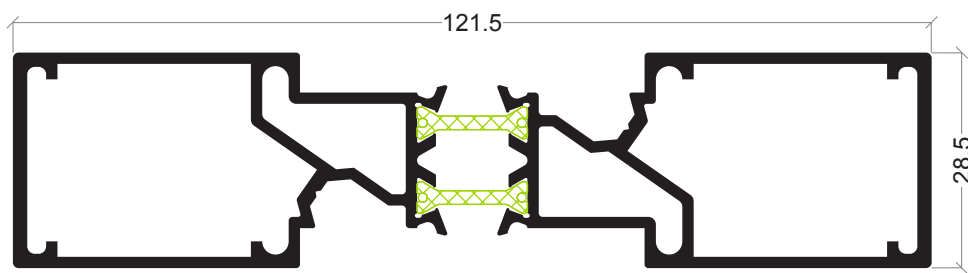

AXi-68
União de aros com reforço

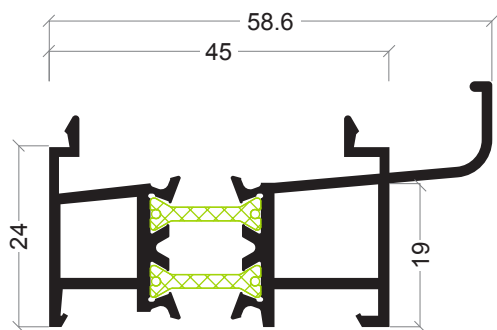

AXi-57
Soleira condensação

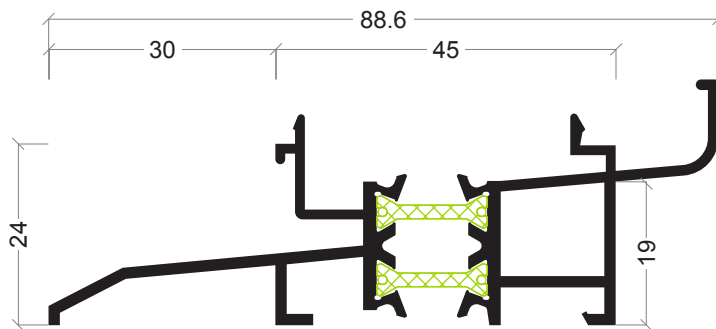

AXi-29
Soleira condensação

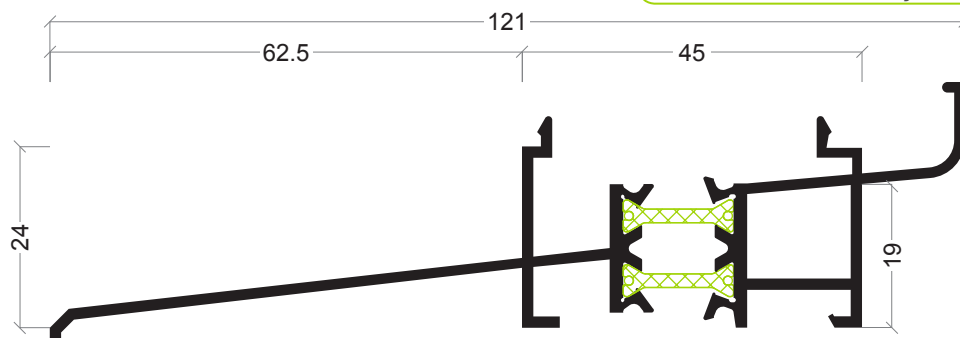

AXi-30
Soleira condensação

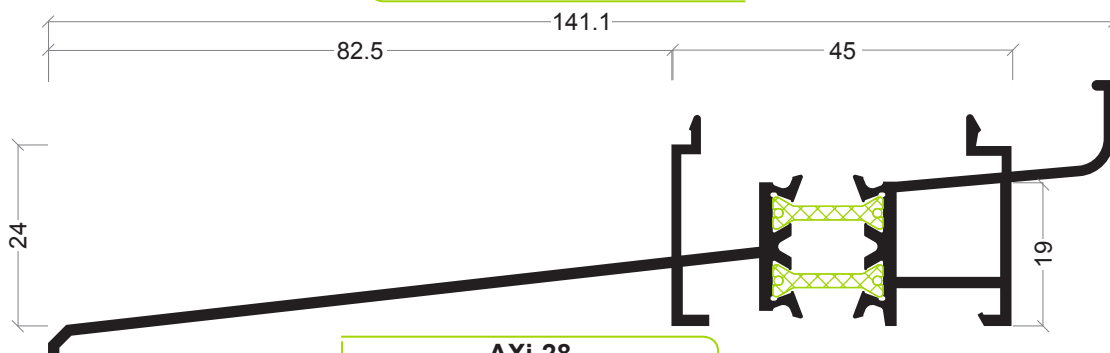

AXi-28
Soleira condensação

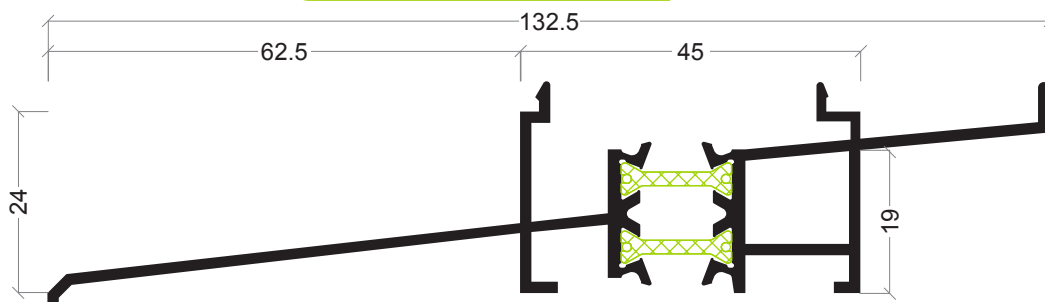

AXi-22
Soleira condensação

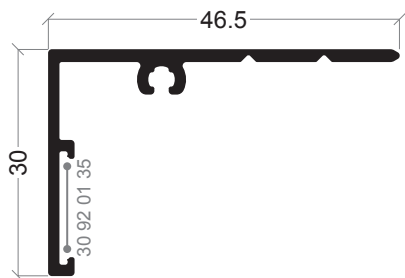

AXi-80
Remate

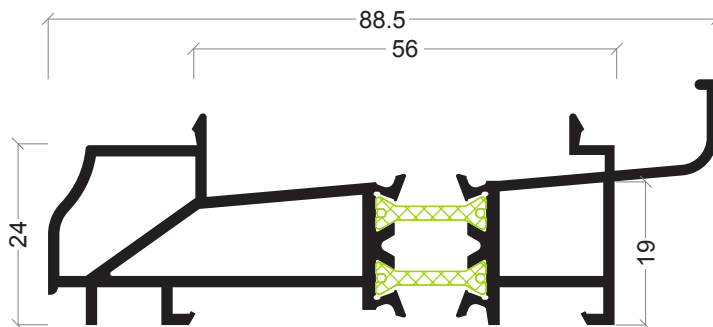

AXi-55
Soleira condensação

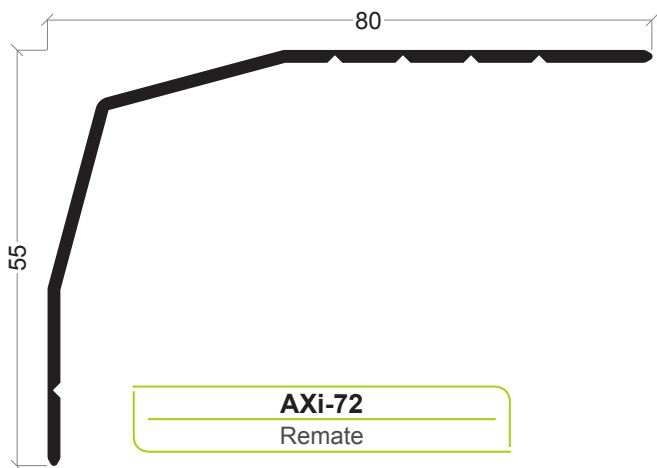

AXi-72
Remate



AXi-88
Complemento remate



AXi-91
Complemento remate

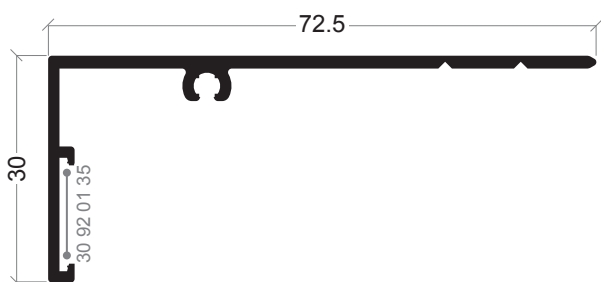

AXi-83
Remate

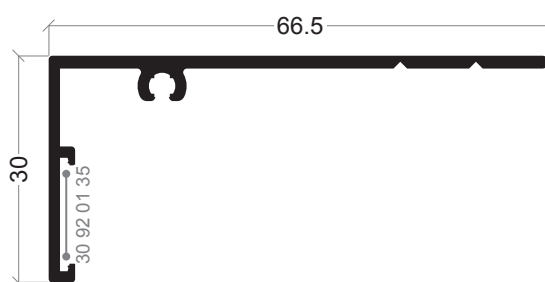

AXi-73
Remate

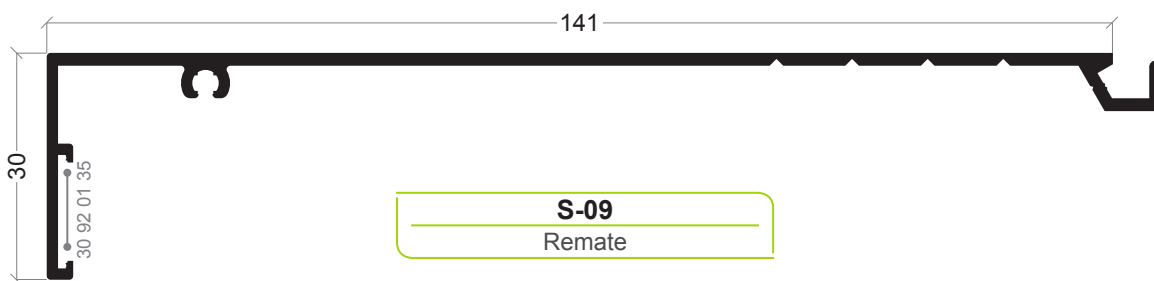

S-09
Remate

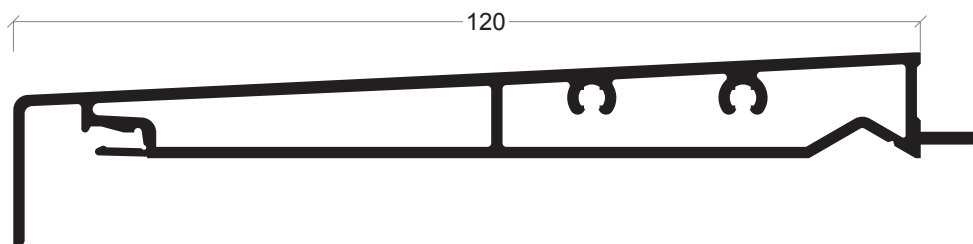

AXi-74
Remate soleira

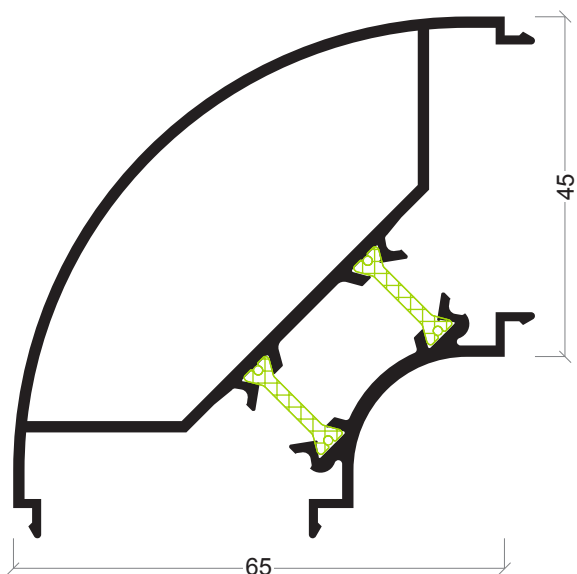

AXi-16
Esquina



AXi-34
Esquina

AXi-36
União de aros para ângulos

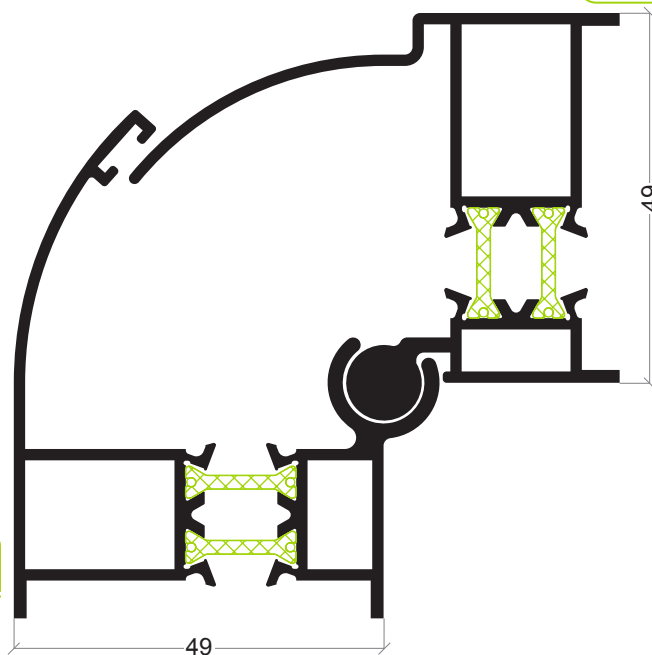

AXi-37
União de aros para ângulos

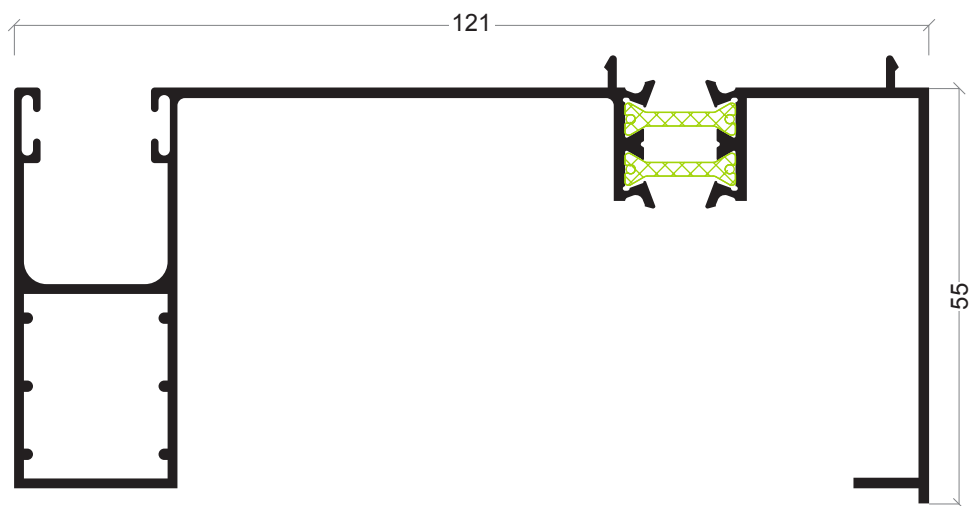

AXi-11
Pré-aro com calha estore

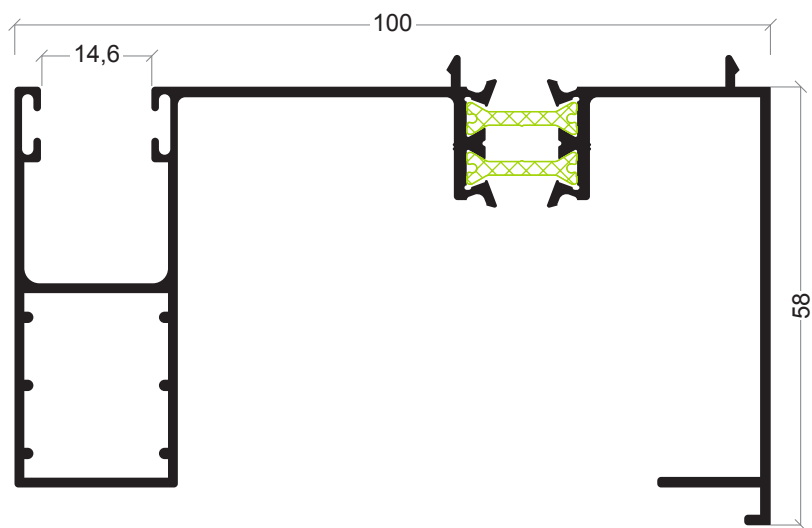

AXi-93
Pré-aro com calha estore

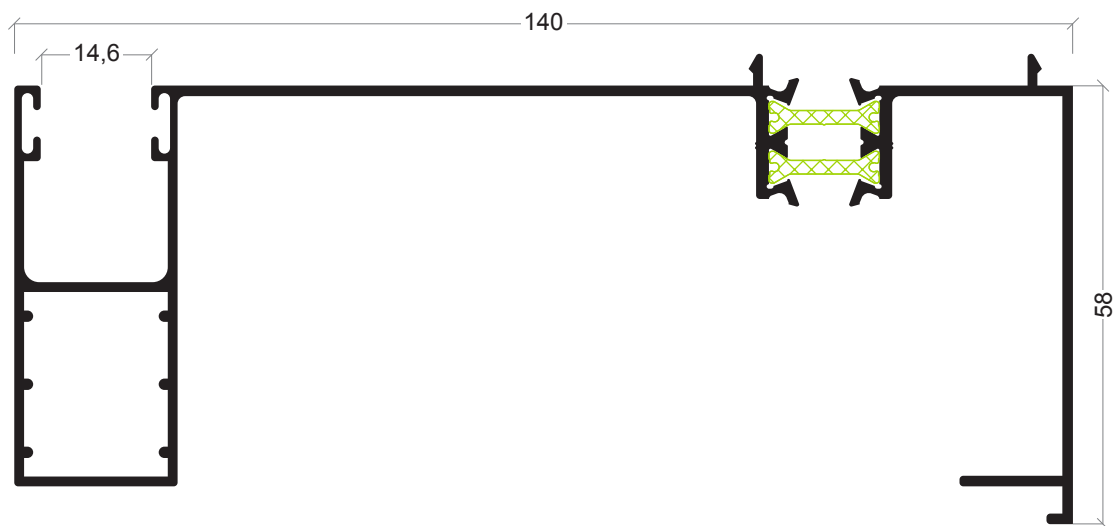

AXi-94
Pré-aro com calha estore

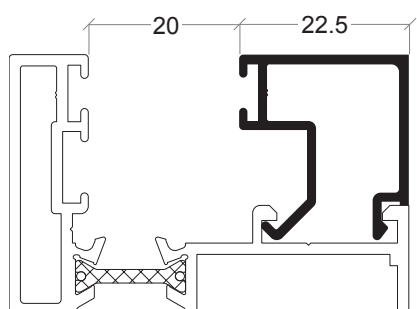
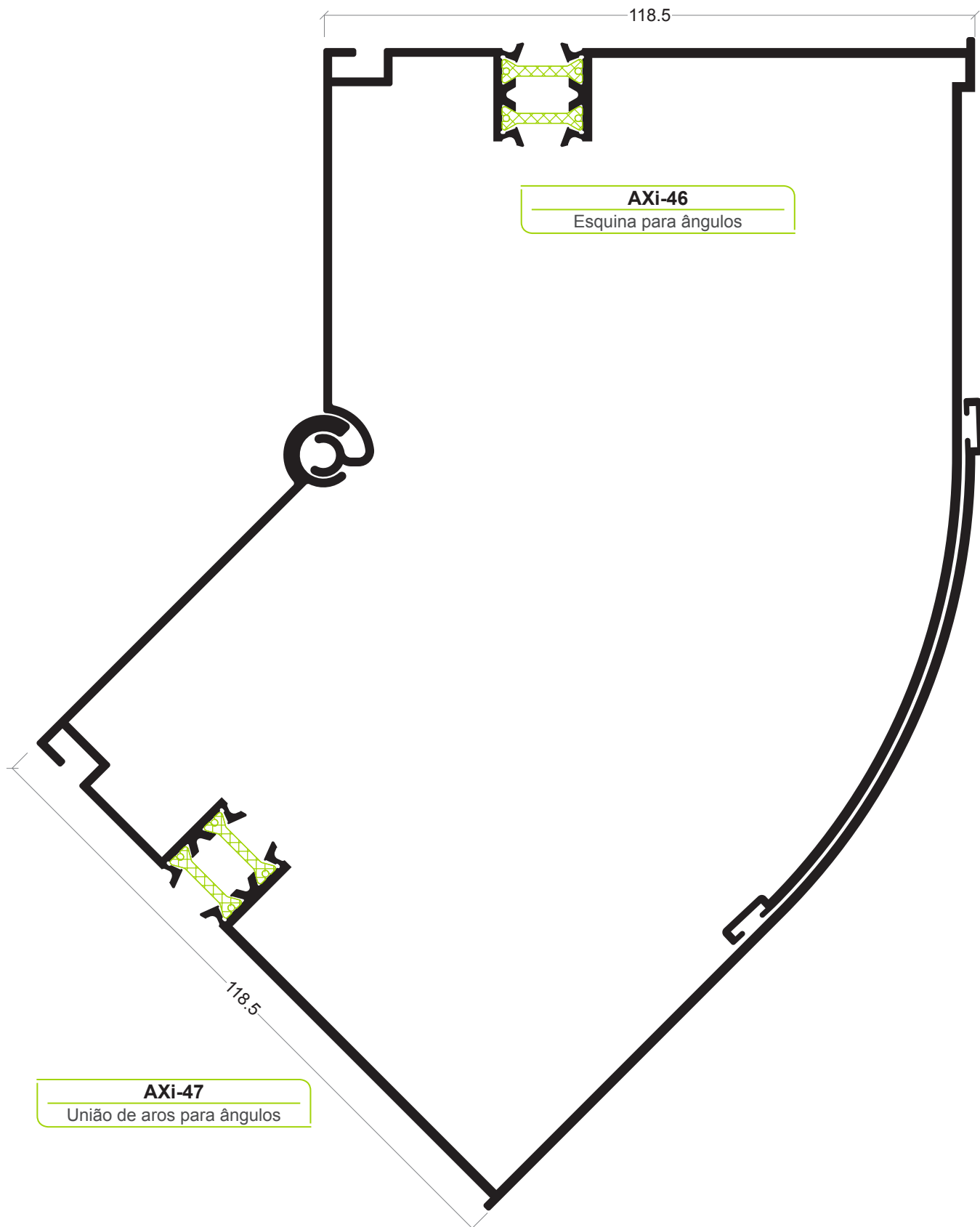

AX-78

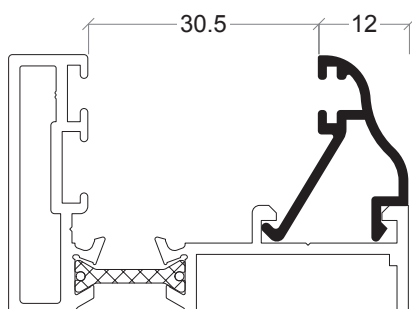

AX-73

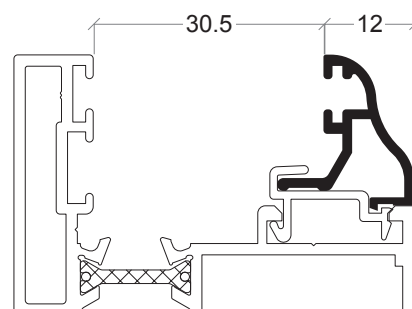

AX-72

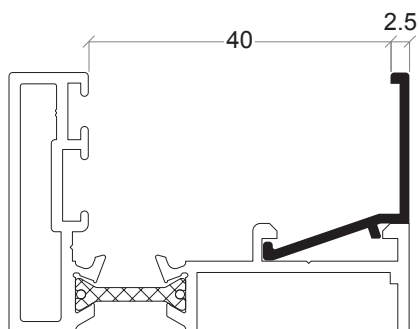

AX-69

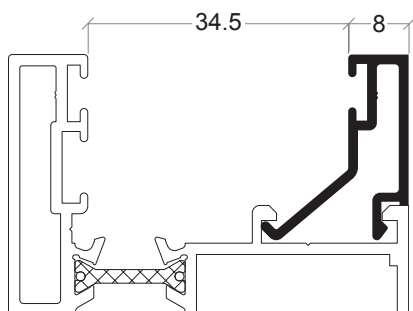

AX-74

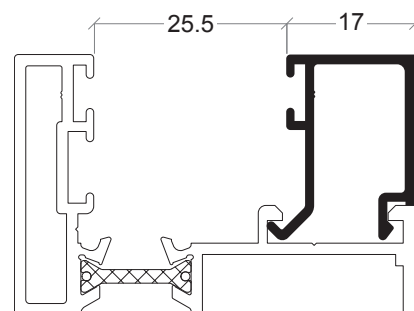

AX-46

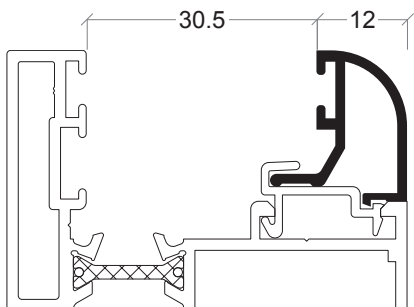

AX-37

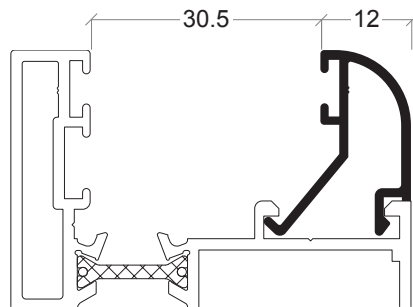

AZ-08

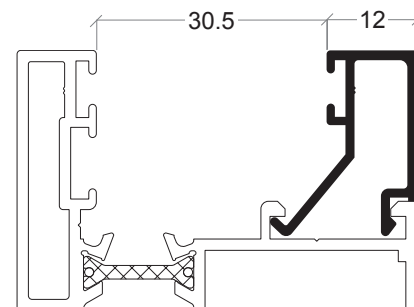

AX-36

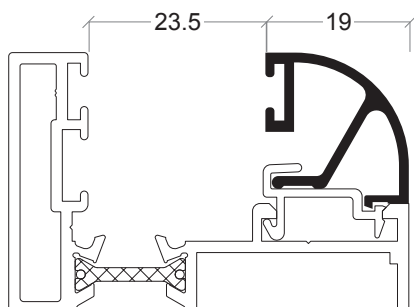

AX-30

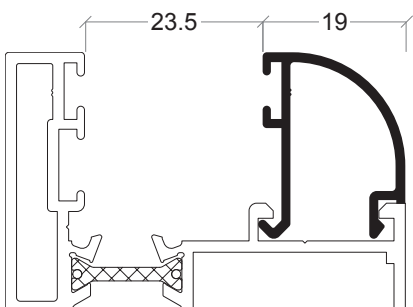

AZ-07

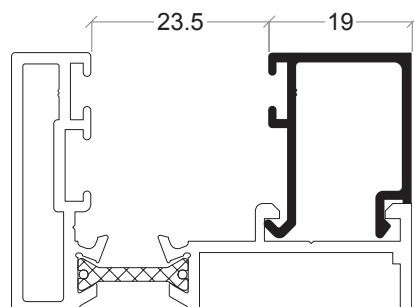

AX-35

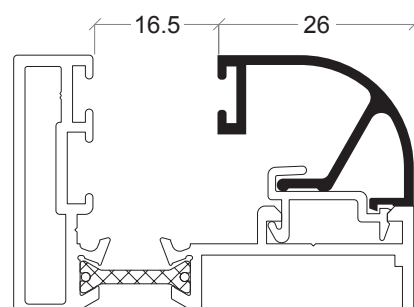

AX-29

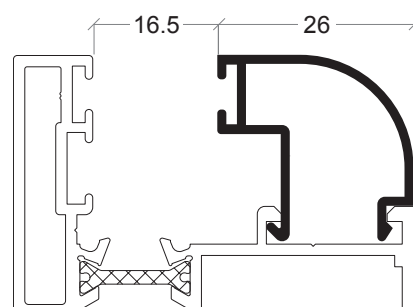

AZ-06

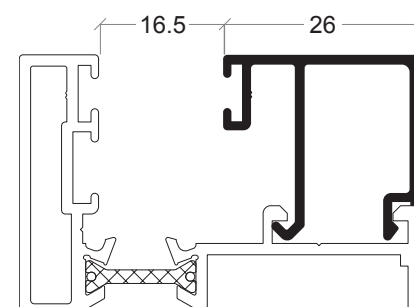

AX-31

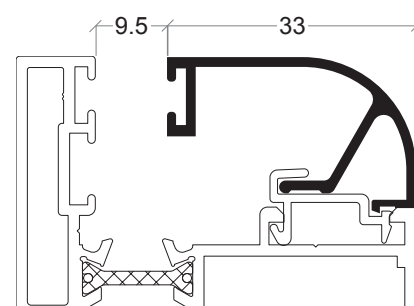

AX-39

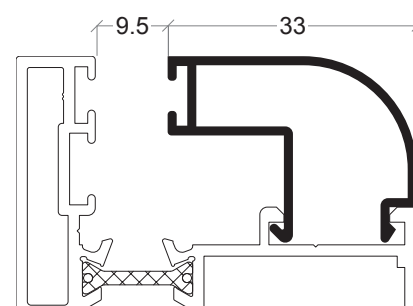

AZ-28

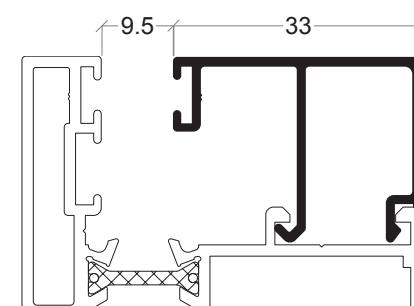

AX-34

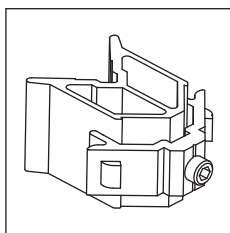

30 20 30 09

Esquadro móvel pivotante

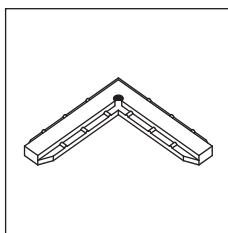

30 21 20 07

Esquadro de alinhamento

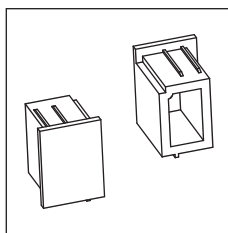

30 91 21 20

Jogo topos condensação Y-20

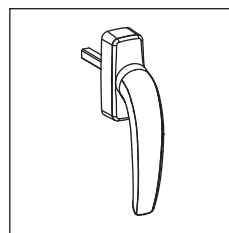

30 91 41 47/48

Cremone pivotante especial branco/preto

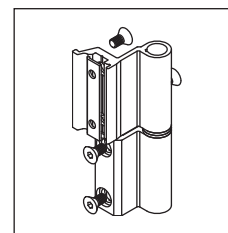

30 92 00 20/21

Dobradiça C.E. branco/preto

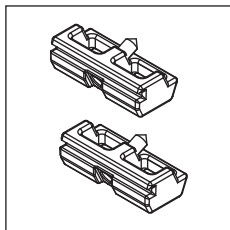

30 92 00 50

Complemento fecho

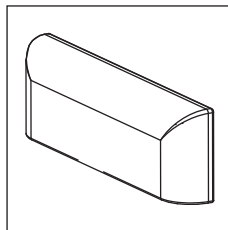

30 92 01 00/01

Goteiras branco/preto

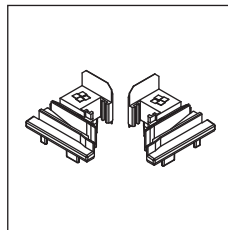

30 92 01 12

Jogo topos inversor poliamida em T AXi-04

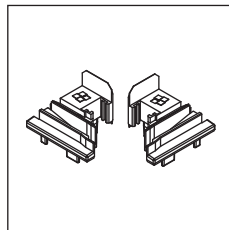

30 92 01 13

Jogo topos inversor AXi-04

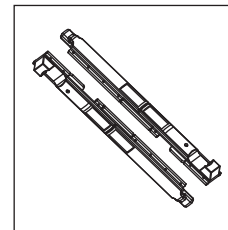

30 92 01 20

Jogo fecho C.E.

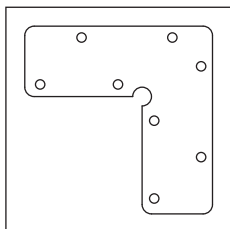

30 92 01 35

Esquadro alinhamento

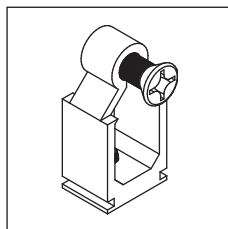

30 92 01 40

União topos janela

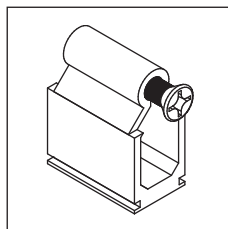

30 92 01 50

União topos porta

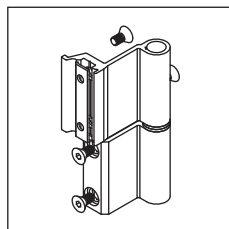

30 92 01 70/80

Dobradiça 3 folhas branco/preto

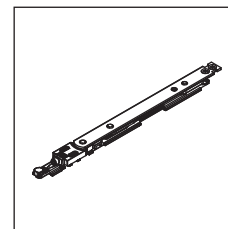

30 92 02 10/11/12

Compasso oscilo 300/400/500

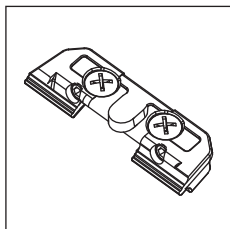

30 92 02 15

Fecho para micro-ventilação

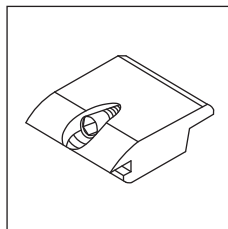

30 92 02 60

Apoio da folha

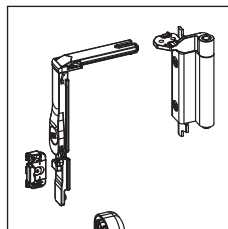

30 92 02 20/21

Kit oscilbatente branco/preto

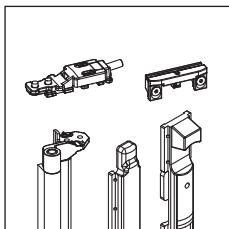

30 92 02 24/25

Kit 2ª folha oscilbatente branco/preto

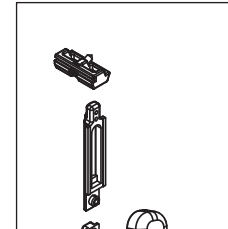

30 92 03 10/11

Kit cremone branco/preto

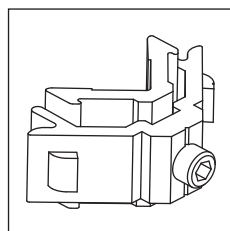

30 92 03 80

Esquadro janela

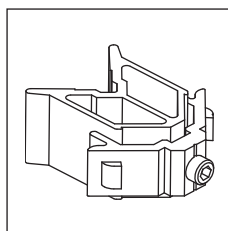

30 92 03 90

Esquadro porta

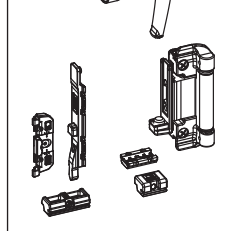

30 92 03 96

Canto vulcanizado

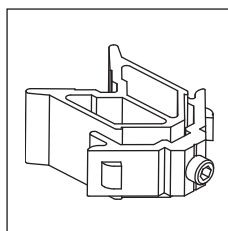

30 92 04 10

Esquadro janela abertura exterior

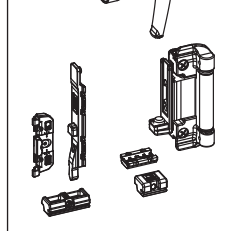

30 92 04 50

Cremone abertura exterior

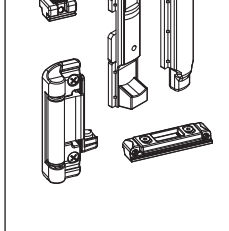

30 92 04 60

Jogo de transmissão abertura exterior

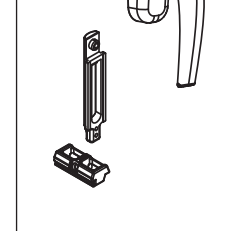

30 92 04 75

Jogo compasso basculante

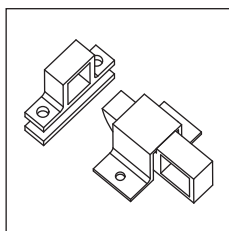

30 92 04 76/77

Fecho clack (branco/preto)

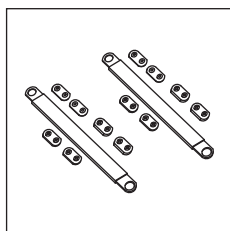

30 92 04 85

Jogo compasso

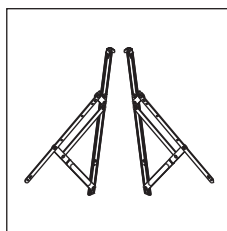

30 92 04 90

Compasso SEN-550 (até 70kg /folha)

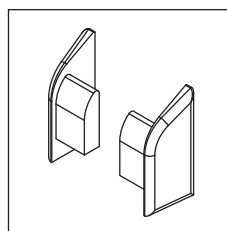

30 92 05 00

Jogo topos

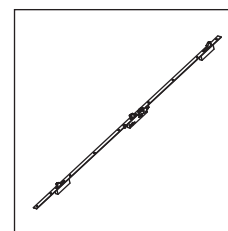

30 92 05 10

Fechadura 3 pontos 35 mm

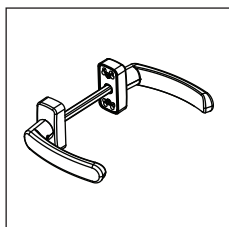

30 92 05 15

Fecho de alavanca com 5 pontos de fecho

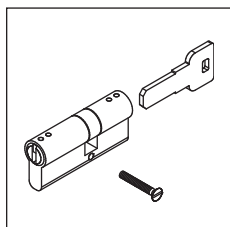

30 92 05 40

Canhão fechadura

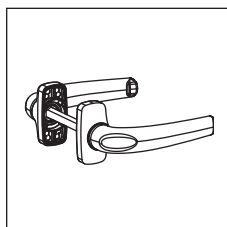

30 92 05 60/61

Puxador duplo branco/preto

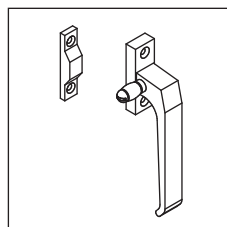

30 92 06 10/11

Cremone de lingueta branco/preto

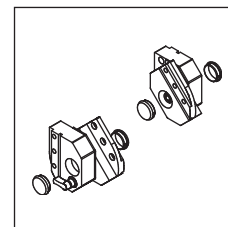

30 92 07 10/11

Jogo pivotante 60kg preto/branco

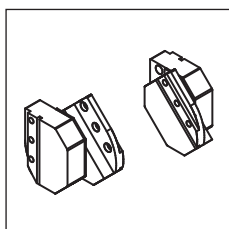

30 92 07 14/15

Jogo pivotante vertical/horizontal especial AXi (130 kg)

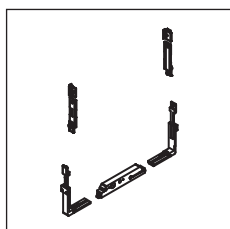

30 92 07 16

Fecho perimetral pivotante especial

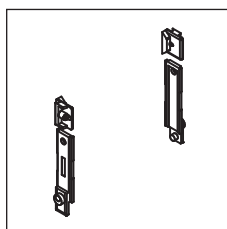

30 92 07 17

Fecho suplementar pivotante especial

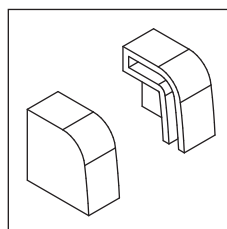

30 96 00 12

Jogo topos condensação

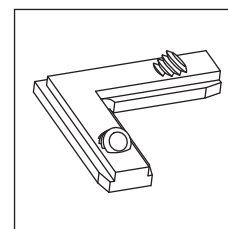

30 96 00 15

Esquadro de alinhamento

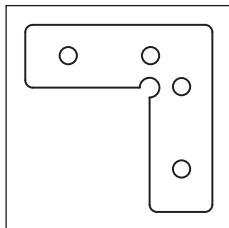

30 96 00 28

Esquadro alinhamento especial AXi-07/10/27/53/65/66

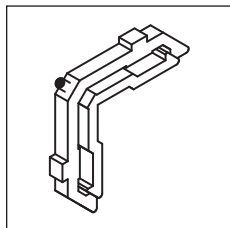

30 96 00 38

Esquadro alinhamento exterior

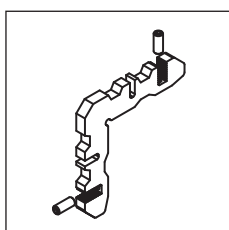

30 96 00 45

Esquadro alinhamento exterior com parafusos

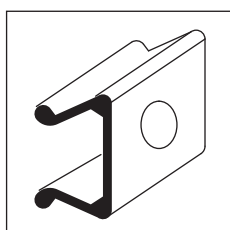

31 03 40 00

Mola para AZ-60

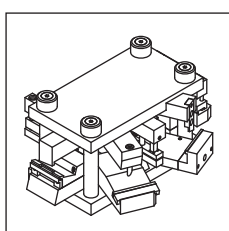

33 96 79 99

Cunho C.E.

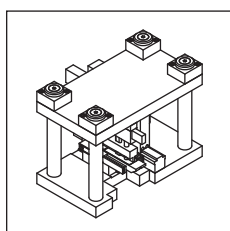

33 96 87 99







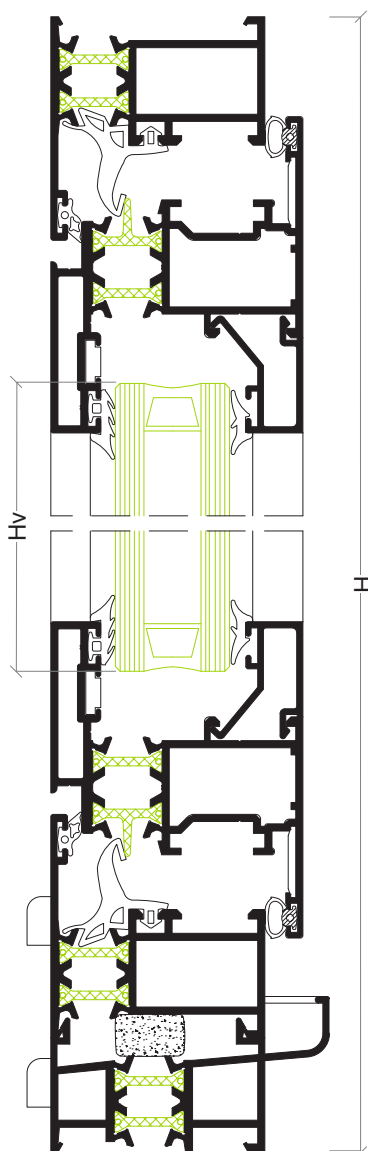
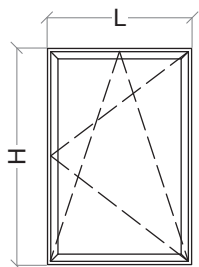

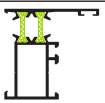

Cunho esquadros interior/exterior

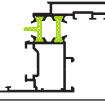
Referência	Desenho	Descrição
30 00 95 01		Junta exterior abertura pivotante
30 00 95 15		Junta vedação inferior curta
30 20 30 05		Junta isolante AXi
30 20 30 08		Junta central abertura pivotante
30 25 44 15		Junta tapa canal
30 60 00 17		Junta exterior vidro plana 2 mm preto
30 92 04 70		Espuma isolante
30 93 00 20		Junta de remate AZ-69
30 93 00 50		Junta central
30 93 00 60		Vedante exterior do vidro (opcional)
30 93 00 61		Junta de vedação exterior
30 93 00 62		Junta exterior plana
30 93 00 65		Junta interior para vidro (5 mm)
30 93 00 66		Junta interior para vidro (4 mm)
30 93 00 67		Junta interior para vidro (2 mm)
30 93 00 68		Junta interior para vidro (6/7 mm)
30 93 00 69		Junta interior para vidro (8/9 mm)
30 93 00 70		Vedante interior do vidro (opcional)
30 93 00 80		Junta de vedação inferior AXi-42
30 93 00 82		Junta de vedação inferior
30 93 00 90		Junta exterior
30 93 01 10		Junta central poliamida em T
30 93 01 20		Junta interior
30 93 01 30		Junta exterior (abertura exterior/projectante)
30 95 00 10		Pelúcia 7x9 mm
30 95 00 40		Pelúcia 7x5.5 mm

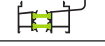
Janela 1 folha abrir e oscilo-batente



Perfis

Desenho	Ref	Descrição	Corte	Quant	Medida
	AXi-03	Aro fixo		2	L
				2	H-24 mm
	AXi-64	Aro móvel		2	L-42 mm
				2	H-66 mm
	AXi-57	Soleira condensação		1	L
	AX-19	Vareta		1+1	Apro. L+H
	---	Bite		2	L-135 mm
				2	H-199 mm

Acessórios e Juntas

Referência	Descrição	Quantidade	
		Abrir	Oscilo-batente
30 92 00 20	Dobradiças C.E.	2	---
30 92 01 00	Goteiras	4	4
30 92 01 35	Esquadro alinhamento aro móvel	4	4
30 92 02 (xx)	Compasso O.B.	---	1
30 92 02 20	Kit oscilo-batente	---	1
30 92 02 60	Apoio da folha	1	---
30 92 03 10	Kit cremone	1	---
30 92 03 80	Esquadro janela	8	8
30 96 00 12	Jogo topos condensação	1	1
30 96 00 15	Esquadro alinhamento móvel	4	4
30 92 03 96	Canto vulcanizado	4	4
30 92 04 70	Espuma isolante	L	L
30 93 00 90	Junta exterior	2L+2H	
30 93 01 10	Junta central	2L+2H	
30 93 01 20	Junta interior	2L+2H	
---	Junta exterior vidro	2L+2H	
---	Junta interior vidro	2L+2H	

25

Vidro

Hv = H-174 mm	Lv = L-149 mm
---------------	---------------

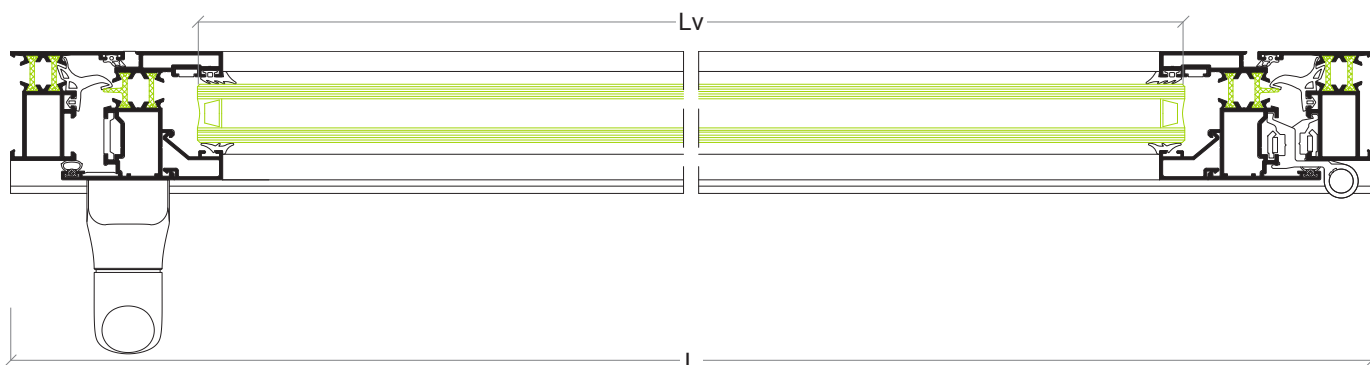

Janela 2 folhas abrir e oscilo-batente

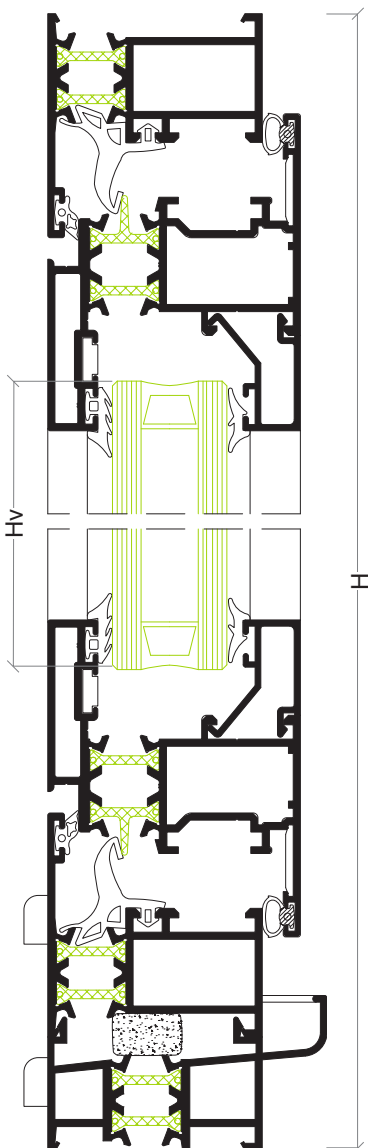
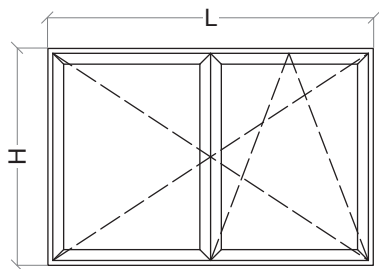

Perfis

Desenho	Ref	Descrição	Corte	Quant	Medida
	AXi-03	Aro fixo		2	L
				2	H-24 mm
	AXi-64	Aro móvel		4	L/2-24 mm
				4	H-66 mm
	AXi-57	Soleira condensação		1	L
	AX-19	Vareta		1+1	Apro. L+H
	---	Bite		4	L/2-117 mm
				4	H-199 mm
	AXi-04	Inversor		1	H-134 mm

Acessórios e Juntas

Referência	Descrição	Quantidade	
		Abriu	Oscilo-batente
30 92 00 20	Dobradiças C.E.	4	---
30 92 01 00	Goteiras	4	4
30 92 01 20	Jogo fecho C.E.	1	---
30 92 01 35	Esquadro alinhamento aro móvel	8	8
30 92 02 (xx)	Compasso O.B.	---	1
30 92 02 20	Kit oscilo-batente	---	1
30 92 02 24	Kit 2ª folha oscilo-batente	---	1
30 92 02 60	Apoio da folha	1	---
30 92 03 10	Kit cremone	1	---
30 92 03 80	Esquadro janela	12	12
30 92 01 12	Jogo topos inversor	1	1
30 96 00 12	Jogo topos condensação	1	1
30 96 00 15	Esquadro alinhamento móvel	8	8
30 92 03 96	Canto vulcanizado	4	4
30 92 04 70	Espuma isolante	L	L
30 93 00 90	Junta exterior	2L+4H	
30 93 01 10	Junta central	2L+3H	
30 93 01 20	Junta interior	2L+4H	
---	Junta exterior vidro	2L+4H	
---	Junta interior vidro	2L+4H	

Vidro

Hv = H-174 mm	Lv = L/2-131 mm
---------------	-----------------

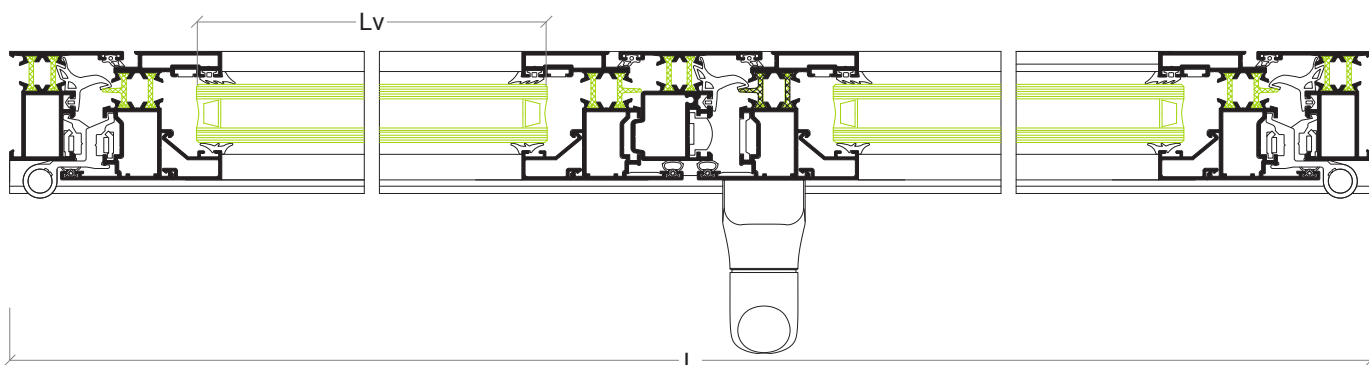

Janela 1 folha abertura exterior

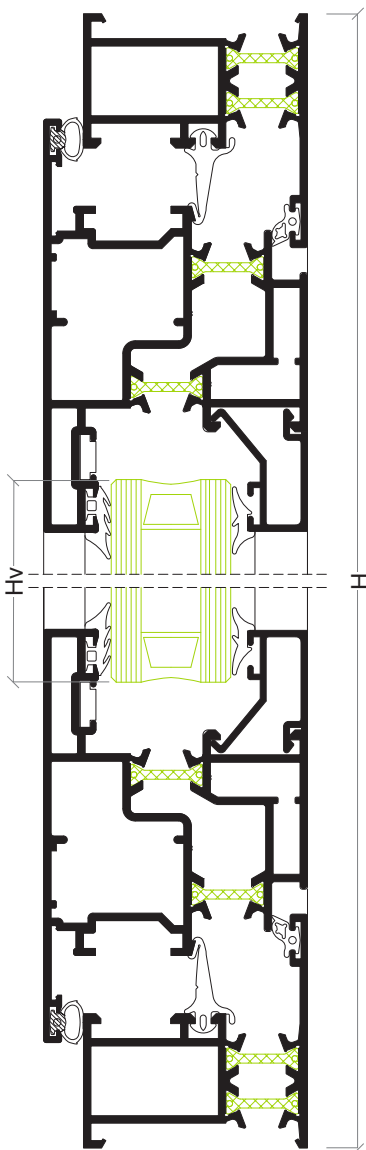
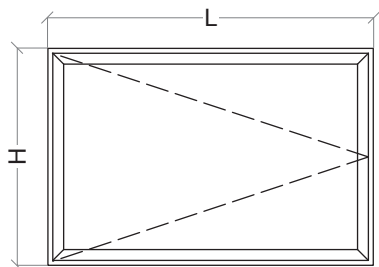

Perfis

Desenho	Ref	Descrição	Corte	Quant	Medida
	AXi-03	Aro fixo		2	L
				2	H
	AXi-60	Aro móvel abertura exterior		2	L-42 mm
				2	H-42 mm
	AX-19	Vareta		1	H
	---	Bite		2	L-168 mm
				2	H-208 mm

Acessórios e Juntas

Referência	Descrição	Quantidade
30 92 00 20	Dobradiças C.E.	2
30 92 02 60	Apoio da folha	1
30 92 04 50	Cremona abertura exterior	1
30 92 03 80	Esquadro janela	8
30 96 00 15	Esquadro alinhamento móvel	4
30 92 04 60	Jogo de transmissão abertura exterior	1
30 92 01 35	Esquadro alinhamento	4
30 96 00 38	Esquadro interno móvel	4
30 93 00 50	Junta central (opcional)	2L+2H
30 93 00 90	Junta exterior	2L+2H
30 93 01 20	Junta interior	2L+2H
---	Junta exterior vidro	2L+2H
---	Junta interior vidro	2L+2H

27

Vidro

Hv = H-182 mm	Lv = L-182 mm
---------------	---------------

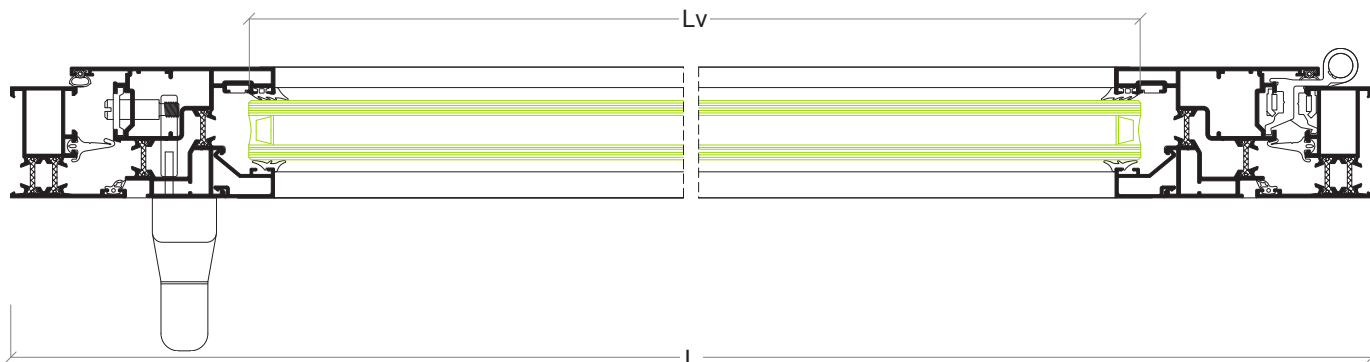

Janela 1 folha projectante

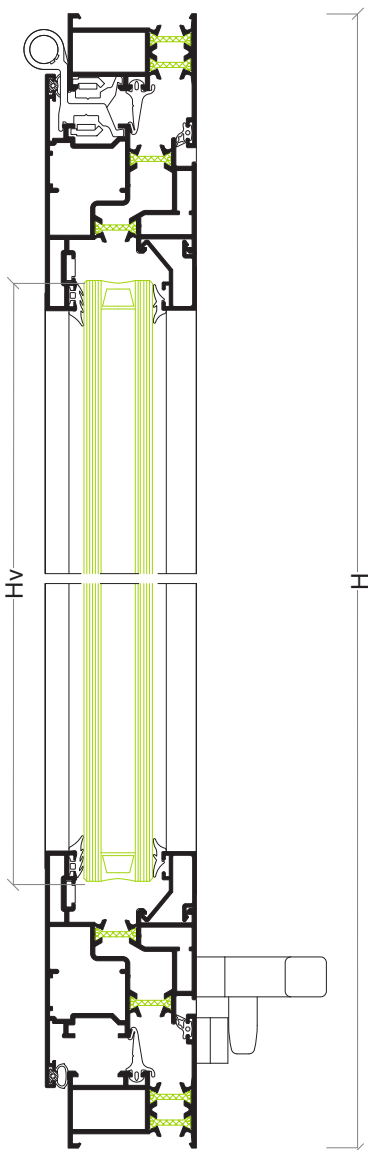
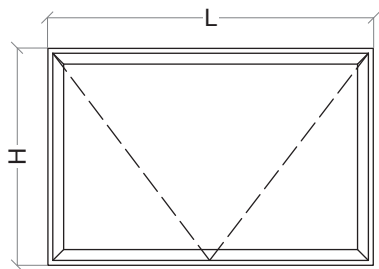

Perfis

Desenho	Ref	Descrição	Corte	Quant	Medida
	AXi-03	Aro fixo		2	L
				2	H
	AXi-60	Aro móvel abertura exterior		2	L-42 mm
				2	H-42 mm
	---	Bite		2	L-168 mm
				2	H-208 mm

Acessórios e Juntas

Referência	Descrição	Quantidade
30 92 03 80	Esquadro janela	8
30 92 04 85	Jogo compasso	1
30 92 06 10	Cremone de lingueta	2
30 96 00 15	Esquadro alinhamento móvel	4
30 92 01 35	Esquadro alinhamento	4
30 96 00 38	Esquadro interno móvel	4
30 93 00 50	Junta central (opcional)	2L+2H
30 93 00 90	Junta exterior	2L+2H
30 93 01 20	Junta interior	2L+2H
30 92 00 20	Dobradiças CE	2
---	Junta exterior vidro	2L+2H
---	Junta interior vidro	2L+2H

Vidro

Hv = H-182 mm	Lv = L-182 mm
---------------	---------------

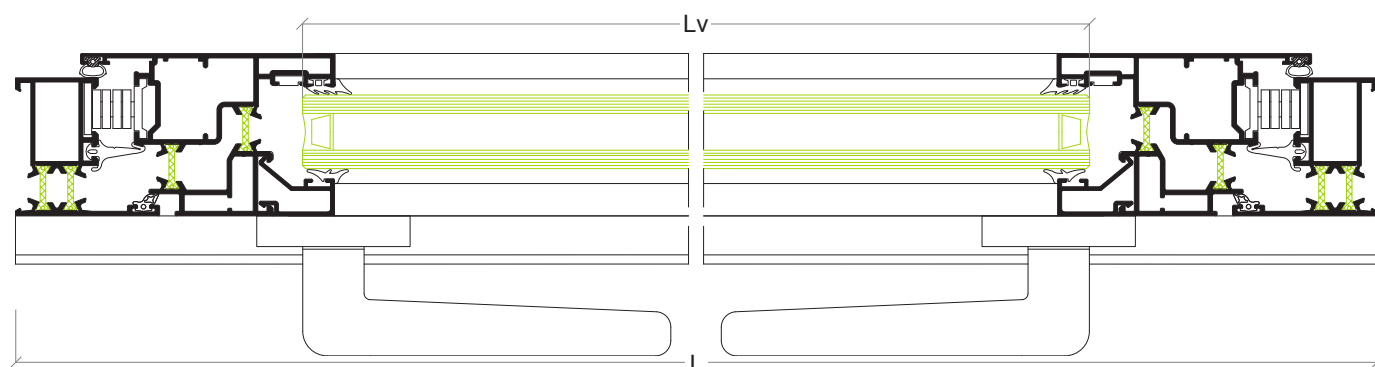

Janela pivotante horizontal

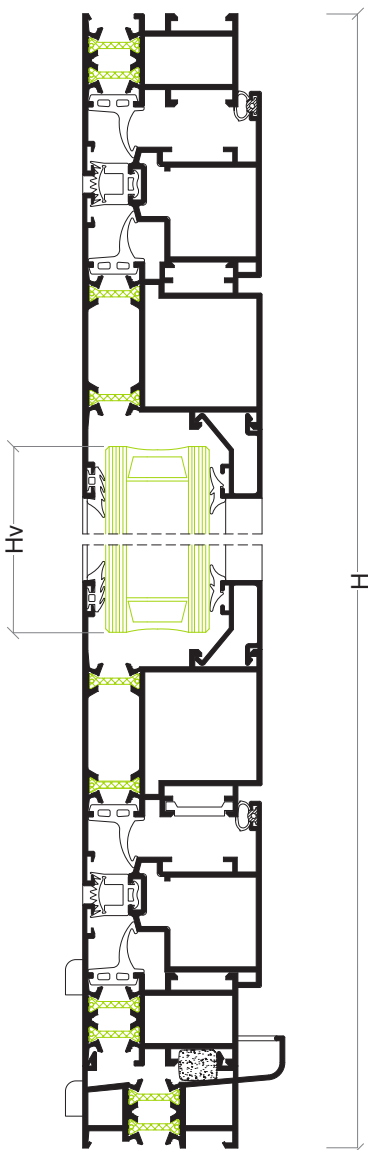
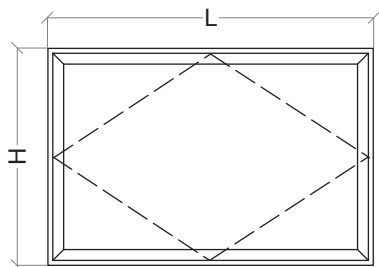

Perfis

Desenho	Ref	Descrição	Corte	Quant	Medida
	AXi-38	Aro fixo		2	L
				2	H-24 mm
	AXi-40	Aro móvel		2	L-104 mm
				2	H-128 mm
	AXi-41	Inversor		2	L-45 mm
				2	H/2-12 mm
	AXi-57	Soleira condensação		1	L
	---	Bite		2	L-241 mm
				2	H-305 mm

Acessórios e Juntas

Referência	Descrição	Quantidade
30 20 30 09	Esquadro móvel	4
30 92 01 00	Goteiras	4
30 92 03 80	Esquadro janela	4
30 92 04 10	Esquadro inversor pivotante	4
30 92 07 10	Jogo pivotante	1
30 92 06 11	Cremona de lingueta	2
30 96 00 12	Jogo topos condensação	1
30 92 04 70	Espuma isolante	L
30 00 95 01	Junta exterior	2L+2H
30 20 30 08	Junta central	4L+4H
30 93 01 20	Junta interior	2L+2H
---	Junta exterior vidro	2L+2H
---	Junta interior vidro	2L+2H

Vidro

Hv = H-279 mm	Lv = L-255 mm
---------------	---------------

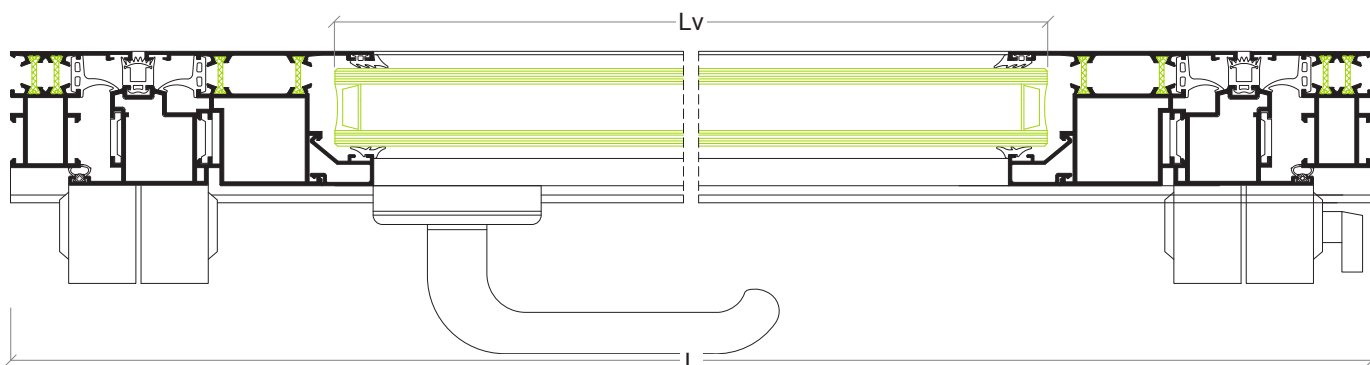

Porta 1 folha

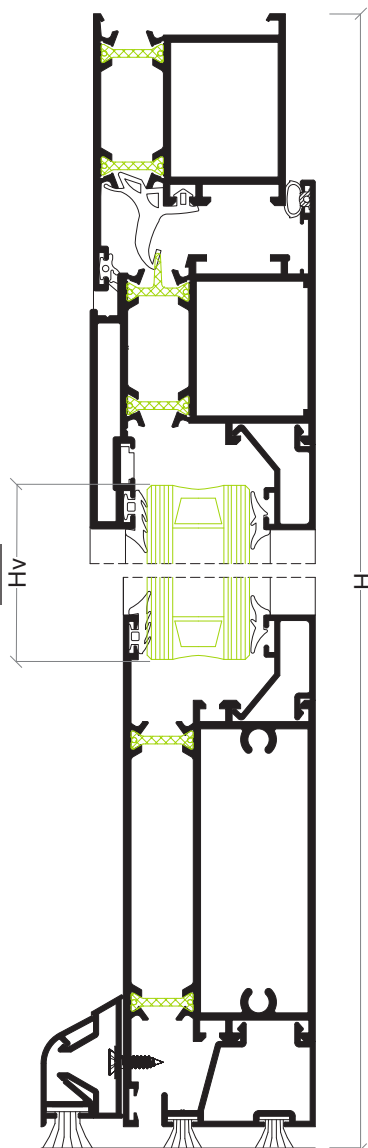
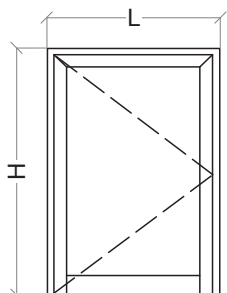

Perfis

Desenho	Ref	Descrição	Corte	Quant	Medida
	AXi-08	Aro fixo		1	L
				2	H
	AXi-65	Aro móvel		1	L-78 mm
				2	H-44 mm
	AXi-12	Travessa		1	L-193 mm
	AX-15	Bite remate		1	L-202 mm
	---	Bite		2	L-202 mm
				2	H-246 mm
	AZ-60	Pingadeira		1	L-145 mm
	AZ-61	Clip pingadeira		1	L-242 mm

Acessórios e Juntas

Referência	Descrição	Quantidade
30 92 00 20	Dobradiças C.E.	3
30 92 03 90	Esquadro porta	4
30 92 05 10	Fechadura 3 pontos	1
30 92 05 40	Canhão fechadura	1
30 92 05 60	Puxador duplo	1
30 96 00 15	Esquadro alinhamento móvel	2
30 92 05 00	Jogo topos	1
30 92 03 96	Canto vulcanizado	2
30 96 00 28	Esquadro alinhamento	2
30 93 00 90	Junta exterior	1L+2H
30 93 01 10	Junta central	1L+2H
30 93 01 20	Junta interior	1L+2H
30 95 00 10	Pelúcia 7x9 mm	2L
---	Junta exterior vidro	2L+2H
---	Junta interior vidro	2L+2H

Vidro

Hv = H-220 mm	Lv = L-216 mm
---------------	---------------

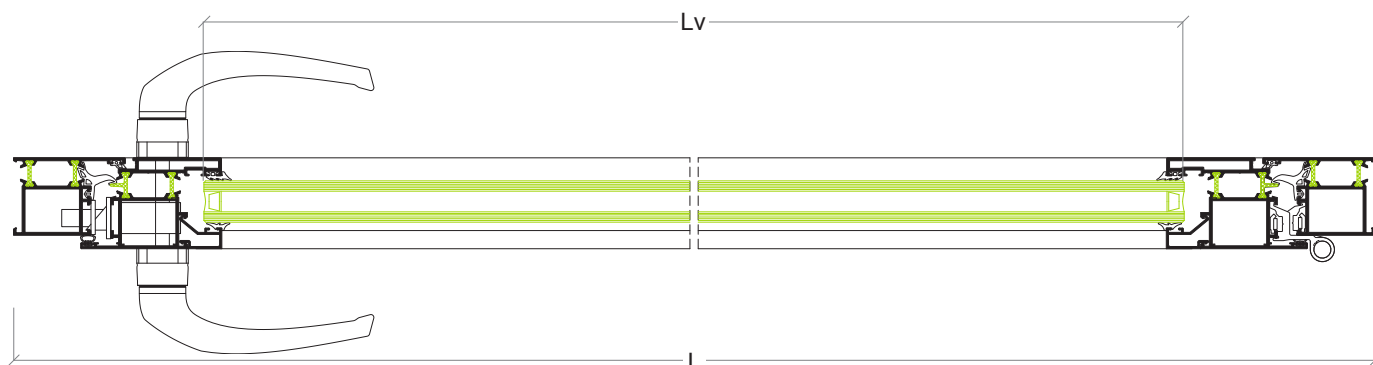

Porta 2 folhas

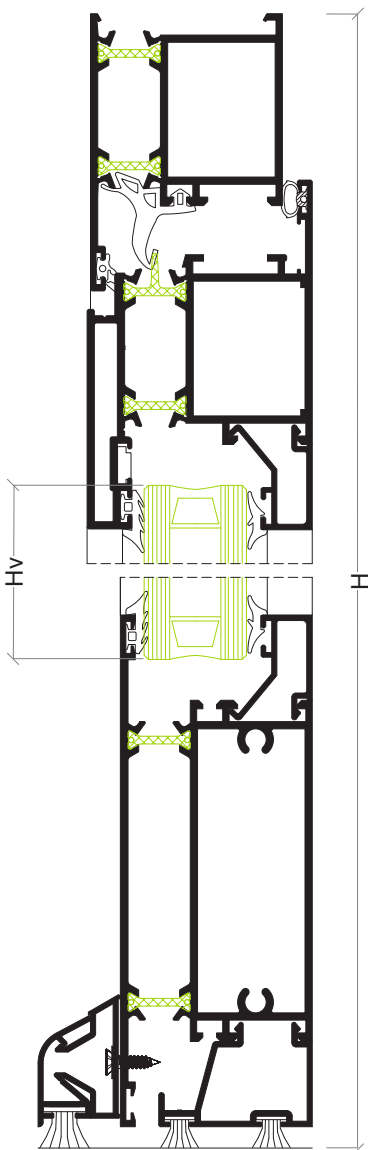
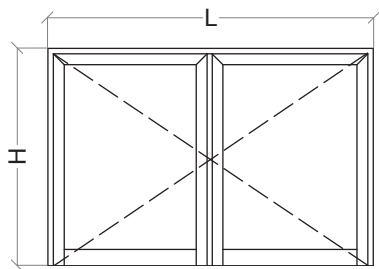

Perfis

Desenho	Ref	Descrição	Corte	Quant	Medida
	AXi-08	Aro fixo		1	L
				4	H
	AXi-65	Aro móvel		2	L/2-42 mm
				4	H-44 mm
	AXi-04	Inversor		1	H-78 mm
	AXi-12	Travessa		2	L/2-157 mm
	AX-15	Bite remate		2	L/2-166 mm
	---	Bite		4	L/2-166 mm
				4	H-246 mm
	AZ-60	Pingadeira		1	Aprox. L/2
				1	Aprox. L/2
	AZ-61	Clip pingadeira		2	L/2-206 mm

Acessórios e Juntas

Referência	Descrição	Quantidade
30 92 00 20	Dobradiças C.E.	6
30 92 01 12	Jogo topos inversor	1
30 92 01 20	Jogo fecho C.E.	1
30 92 03 90	Esquadro porta	6
30 92 05 10	Fechadura 3 pontos	1
30 92 05 40	Canhão fechadura	1
30 92 05 60	Puxador duplo	1
30 96 00 15	Esquadro alinhamento móvel	4
30 92 05 00	Jogo topos	1
30 92 03 96	Canto vulcanizado	2
30 96 00 28	Esquadro alinhamento	2
30 93 00 90	Junta exterior	1L+4H
30 93 01 10	Junta central	1L+3H
30 93 01 20	Junta interior	L+4H
30 95 00 10	Pelúcia 7x9 mm	2L
---	Junta exterior vidro	2L+2H
---	Junta interior vidro	2L+2H

Vidro

Hv = H-220 mm	Lv = L-180 mm
---------------	---------------

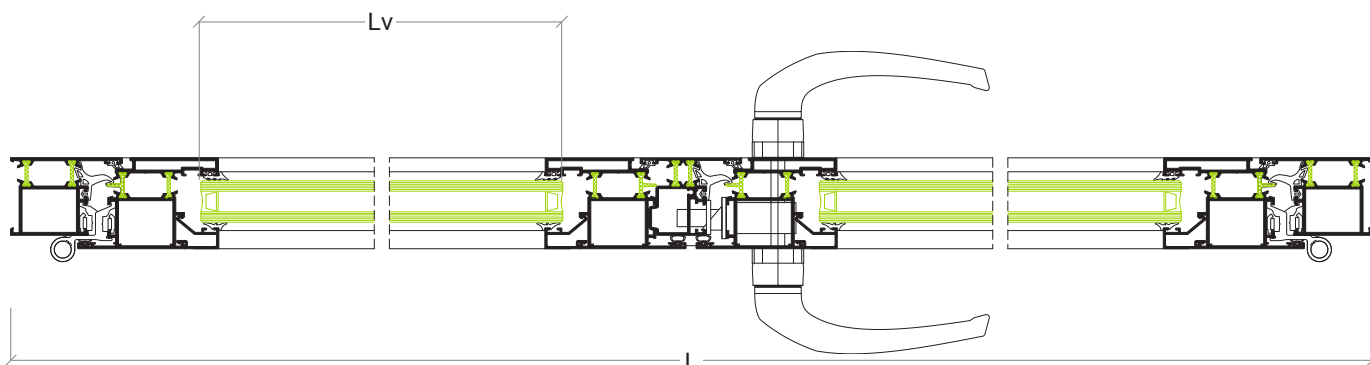

Porta oscilo-paralela com fixo lateral

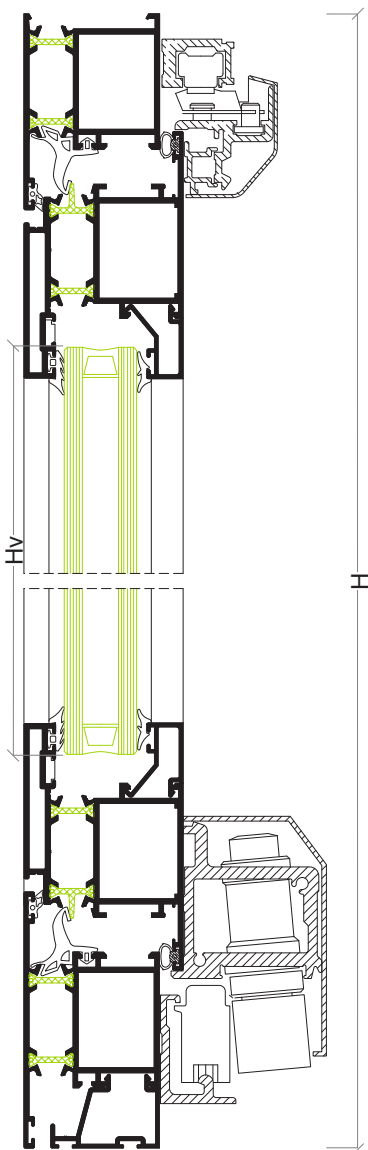
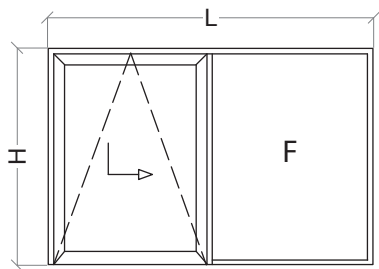

Perfis

Desenho	Ref	Descrição	Corte	Quant	Medida
	AXi-08	Aro fixo		1	L
				2	H
	AXi-65	Aro móvel		2	L1-56 mm
				2	H-98 mm
	AXi-06	Travessa		1	L-81 mm
				1	H-101mm
	AX-15	Bite remate		1	L-90 mm
	AX-19	Vareta		1+1	Apro. L+H
	---	Bite (folha)		2	L1-180 mm
				2	H-262 mm
	---	Bite (fixo)		2	L2-67.5 mm
				2	H-150 mm

Acessórios e Juntas

Referência	Descrição	Quantidade
30 92 01 00	Goteiras	4
30 92 01 50	União topos porta	2
30 92 03 90	Esquadro porta	6
30 96 00 15	Esquadro alinhamento móvel	4
---	Kit oscilo-paralela	1
30 92 03 96	Canto vulcanizado	4
30 96 00 28	Esquadro alinhamento	4
30 93 00 90	Junta exterior	2L1+2H
30 93 01 10	Junta central	2L1+2H
30 93 01 20	Junta interior	2L1+2H
---	Junta exterior vidro	2L+2H
---	Junta interior vidro	2L+2H

	Mínimo	Máximo
Largura da folha	700 mm	1650 mm
Altura da folha	850 mm	2400 mm
Peso máximo por folha 150 kg		

Vidro

Hv folha = H-236 mm	Lv folha = L1-193 mm
Hv fixo = H-124 mm	Lv fixo = L2-81 mm

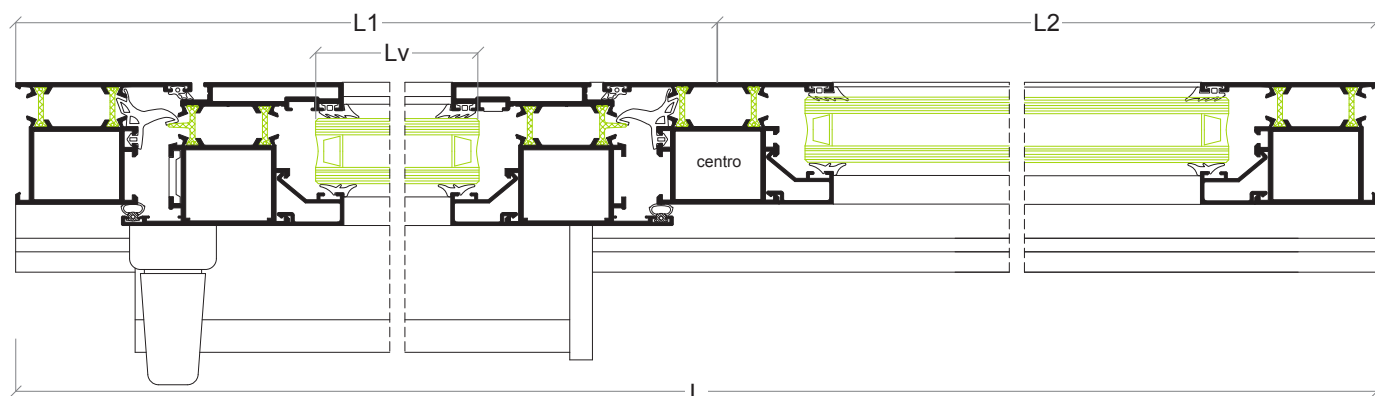

Porta 3 folhas harmónio

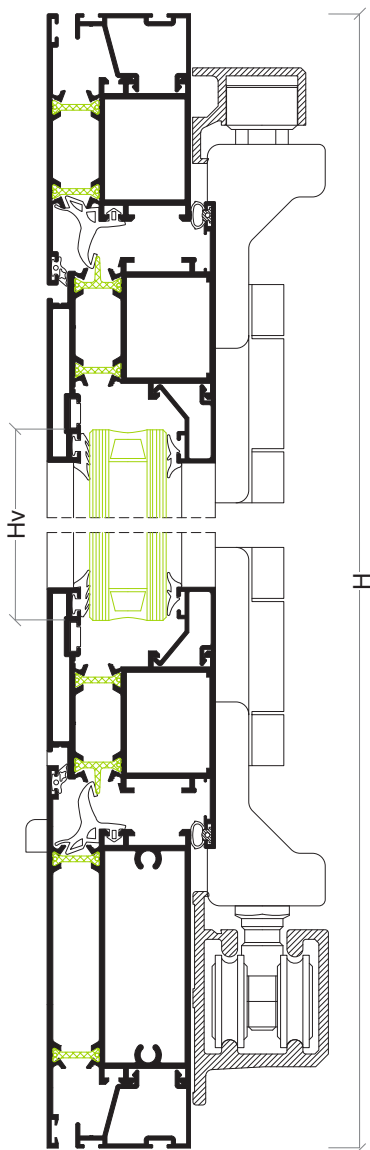
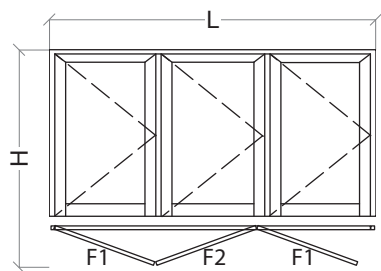

Perfis

Desenho	Ref	Descrição	Corte	Quant	Medida
	AXi-08	Aro fixo		2	H
	AXi-06	Travessa		1	L-81 mm
	AX-12	Travessa		1	L-81 mm
	AXi-65	Aro móvel		6	(consultar)
				6	(consultar)
	AXi-04	Inversor		2	(consultar)
	AX-15	Bite remate		2	L-90 mm
	AX-19	Vareta		2	2H
	---	Bite		6	(consultar)
				6	(consultar)

Acessórios e Juntas

Referência	Descrição	Quantidade
30 92 01 50	União topo porta	2
30 92 01 00	Goteiras	6
30 92 01 12	Jogo topos inversor	2
30 92 03 90	Esquadro porta	12
---	Kit harmónio (3+0)	1
30 92 01 20	Jogo fecho C.E.	1
30 92 03 96	Canto vulcanizado	4
30 96 00 28	Esquadro alinhamento	12
30 96 00 15	Esquadro móvel exterior	12
30 93 00 90	Junta exterior	2L+6H
30 93 01 10	Junta central	2L+4H
30 93 01 20	Junta interior	2L+6H
---	Junta exterior vidro	2L+6H
---	Junta interior vidro	2L+6H

	Mínimo	Máximo
Largura da folha	600 mm	900 mm
Altura da folha	850 mm	2400 mm
Peso máximo por folha 80 kg		

Vidro

Hv = consultar	Lv F1 = consultar
	Lv F2 = consultar

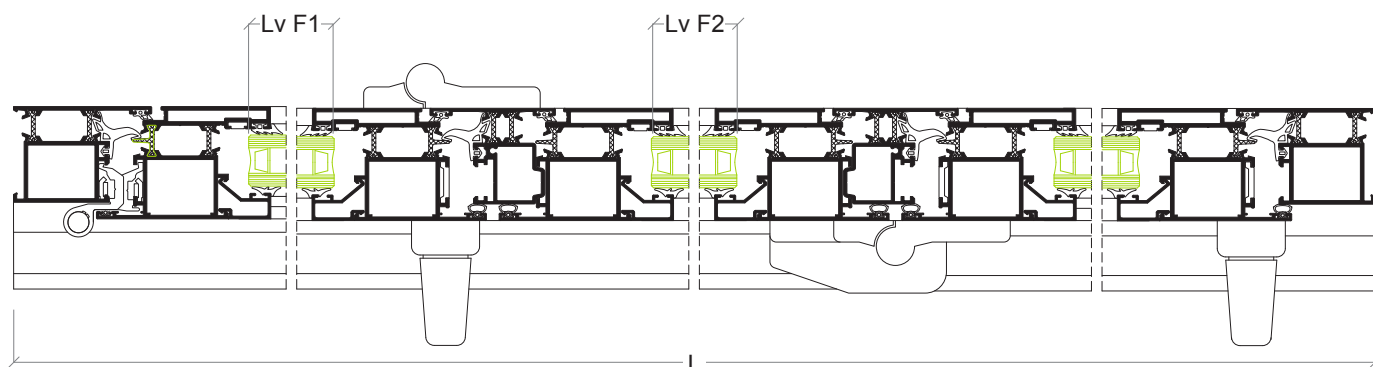

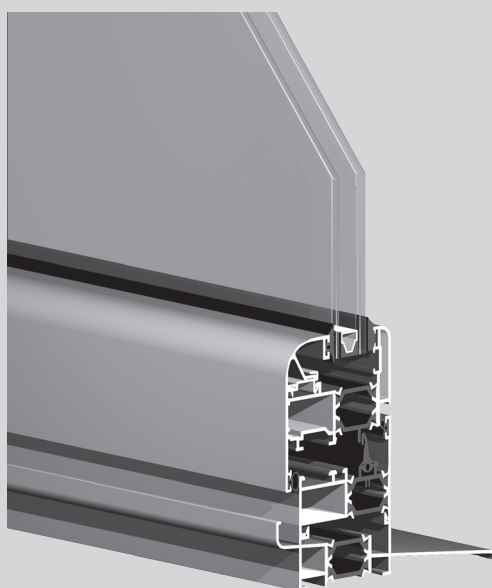

Sistema

ATi

Sistema ATi

Sistema de batente com RPT - 55 mm

Características do sistema

Sistema de batente com rotura térmica e de elevadas prestações térmicas e acústicas.

O sistema ATi possibilita a execução de 4 versões de caixilharia:

1. linha recta;
2. linha curva;
3. linha tradição;
4. linha oval.

O sistema ATi permite a aplicação de vidros duplos de alto rendimento de modo a responder às exigências de isolamento térmico e acústico.

Perfis de alumínio

Os perfis de alumínio são extrudidos na liga de alumínio 6060 para arquitectura de acordo com norma NP EN 12020-02.

Perfis com rotura térmica obtida por inserção de varetas isolantes de poliamida tipo ómega de 24 mm reforçadas com 25% de fibra de vidro.

Espessura média dos perfis de alumínio de 1.5 mm para janelas e de 1.7 mm para portas;

Aros fixos

Secção dos aros fixos de 55 mm ou 80 mm;

Aros fixos com esquadro para montagem a meia esquadria;

Aros fixos tradicionais para mercado interno;

Aros fixos com clip exterior e aba de remate directa de 25 mm ou 45 mm para o mercado francês;

Aros fixos com clip exterior e interior para aplicação de remate de 30 mm para o mercado francês.

Aros móveis

Secção dos aros móveis de 63 mm;

Enchimento para vidro simples ou duplo de 4 mm a 47 mm;

Aros móveis de linha recta, curva, tradição ou oval (sem bite);

Aros móveis com esquadro para montagem a meia esquadria;

Perfil inversor de linha recta.

Dimensionamento e manobralidade

Dimensões mínimas - máximas de folha: 400 mm - 1500 mm (L); 400 mm - 2700 mm (H);

Possibilidades de abertura: fixo, batente interior 1 ou 2 folhas com oscilo-batente, exterior, basculante, projectante, harmónio e oscilo-paralela;

Estanquidade assegurada através de juntas triplas em EPDM.

Performances

Sistema certificado por laboratório notificado para Ensaios Tipo Inicial (ITT) de acordo com a norma de produto EN 14351-1 para efeitos de Marcação CE.

Categorias alcançadas na avaliação do sistema AXi tipologia janela:

1. Permeabilidade ao ar: Classe 4 (norma de ensaio EN 1026)
2. Estanquidade à água: Classe 9A (norma de ensaio EN 1027)
3. Resistência ao vento: Classe C5 (norma de ensaio EN 12211)

Categorias alcançadas na avaliação do sistema ATi tipologia porta:

1. Permeabilidade ao ar: Classe 4 (norma de ensaio EN 1026)
2. Estanquidade à água: Classe E750 (norma de ensaio EN 1027)
3. Resistência ao vento: Classe C2 (norma de ensaio EN 12211)
4. Resistência à torção estática: Apto 350N (norma de ensaio EN 14609)

Coefficiente de transmissão térmica de vão de 2 folhas com 1.20 m x 1.50 m com vidro $U_g = 0.7 \text{ W/m}^2\text{K}$, com intercalar efeito "Warm Edge":

• $U_w = 1.57 \text{ W/m}^2\text{K}$

Coefficiente de atenuação acústica de vão de 2 folhas com vidro 4/14 (gás árgon)/6:

• $R_w (C; C_{tr}) = 34 \text{ dB} (-1; -4)$

Zonas de aplicação segundo RCCTE (em função do valor U_g): I1, I2, I3, V1, V2, V3.

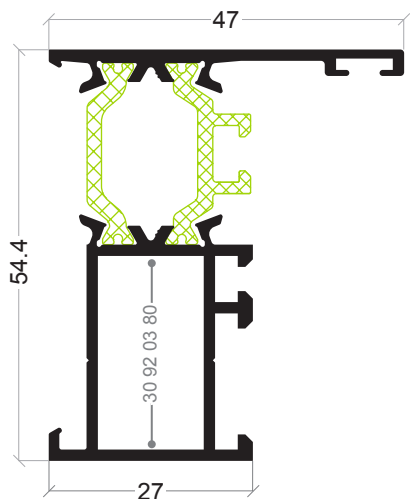

ATi-03
Aro fixo

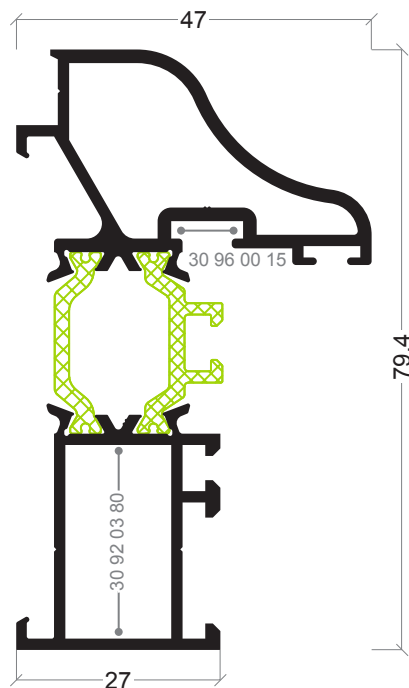

ATi-49
Aro fixo

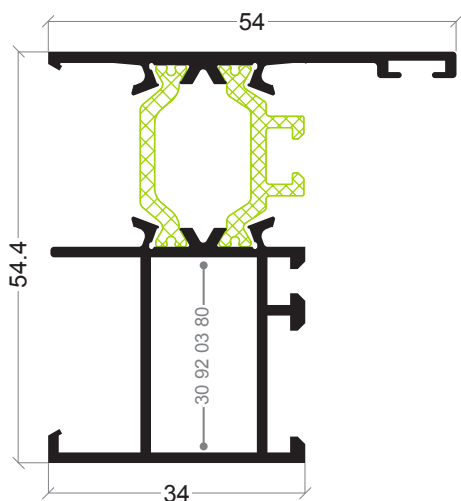

ATi-81
Aro fixo

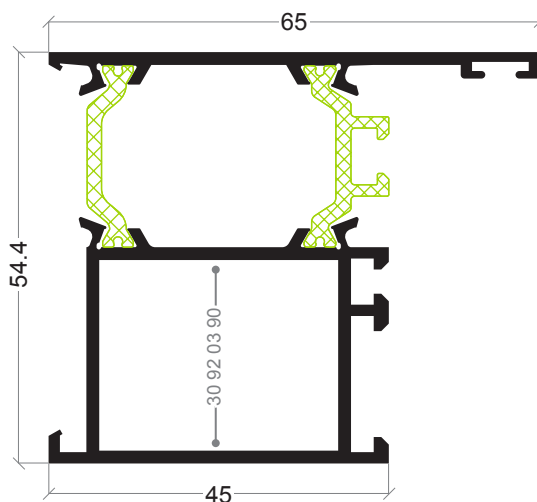

ATi-08
Aro fixo

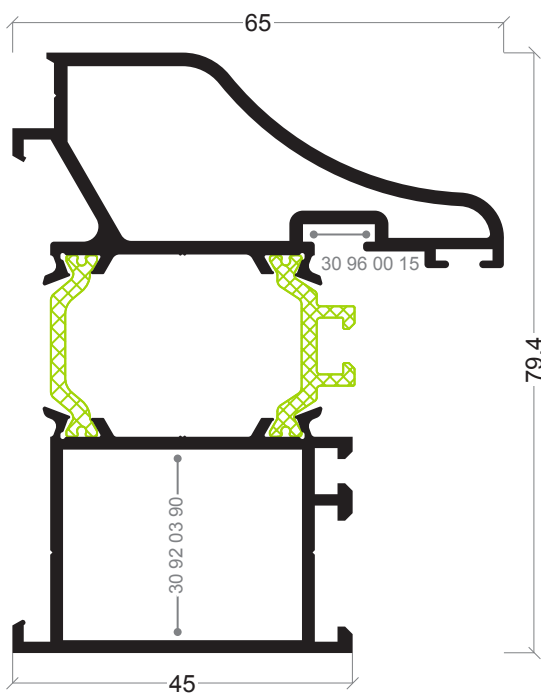

ATi-50
Aro fixo

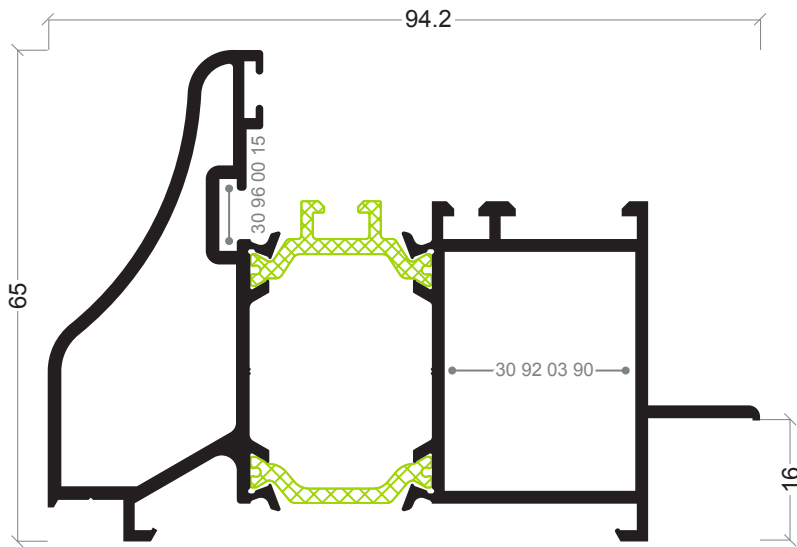

ATi-51
Aro fixo para apanelado

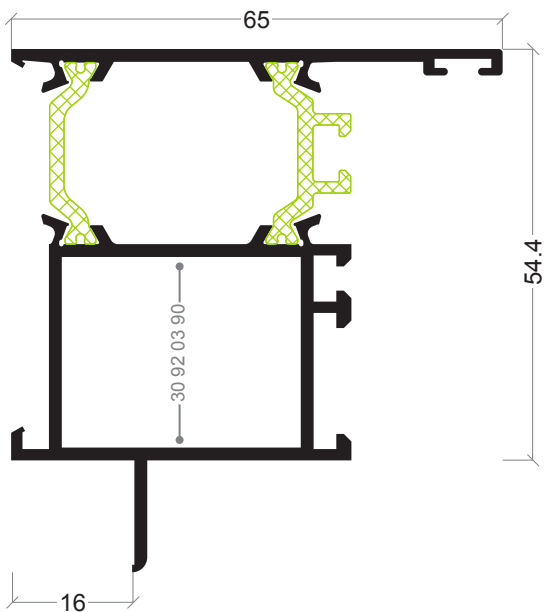

ATi-48
Aro fixo para apanelado

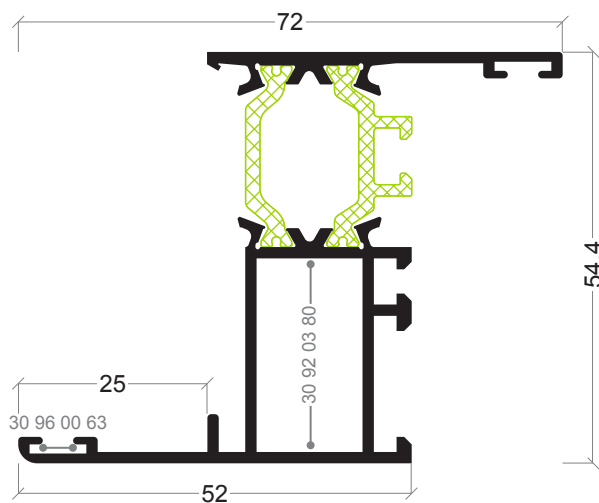

ATi-25
Aro fixo com remate

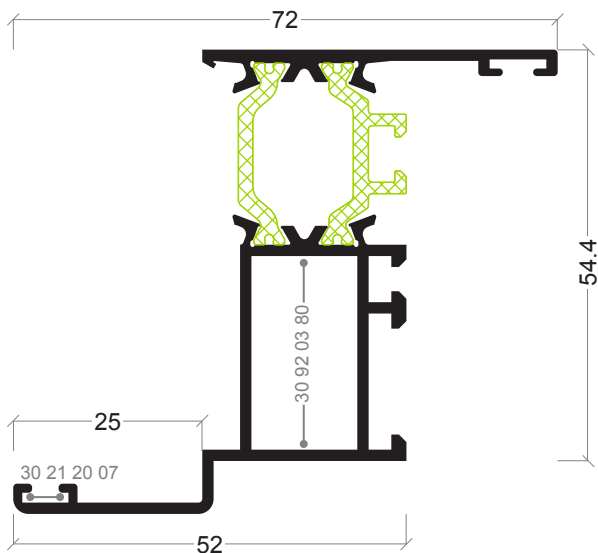

ATi-19
Aro fixo com remate

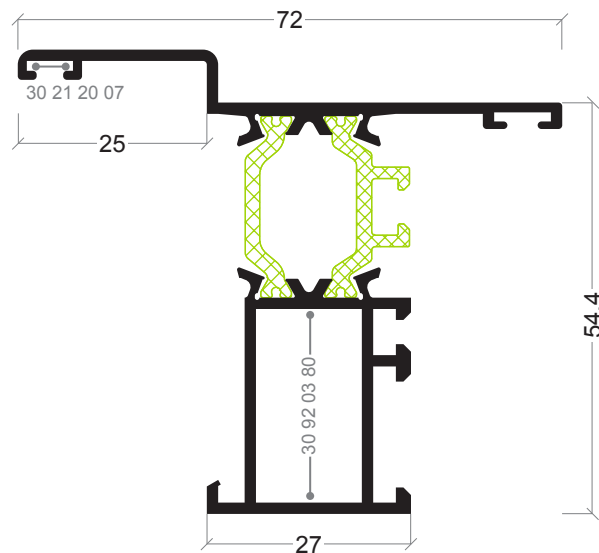

ATi-23
Aro fixo com remate

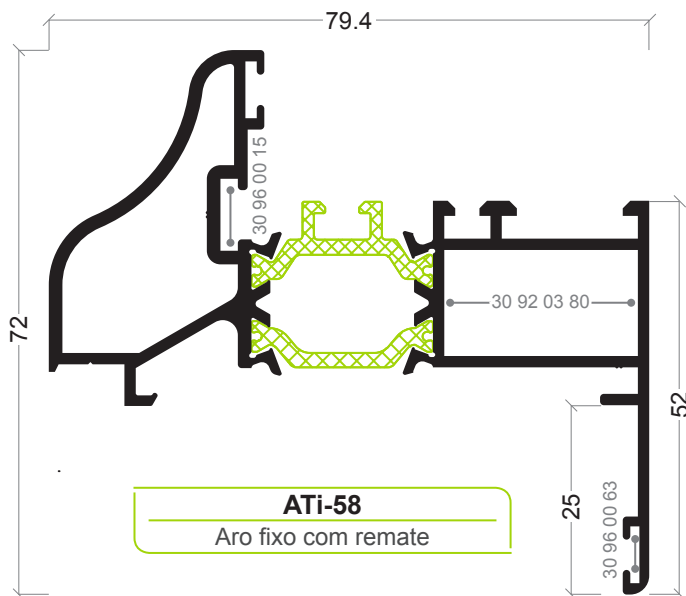

ATi-58
Aro fixo com remate

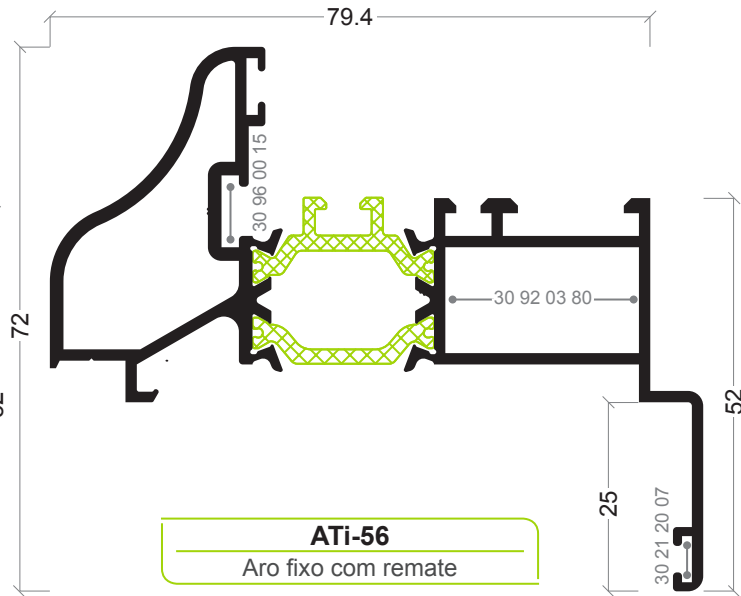

ATi-56
Aro fixo com remate

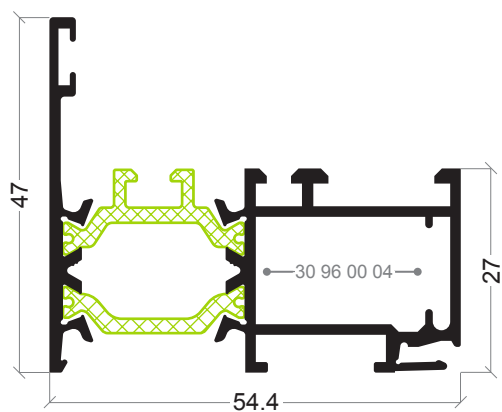

ATi-90
Aro fixo

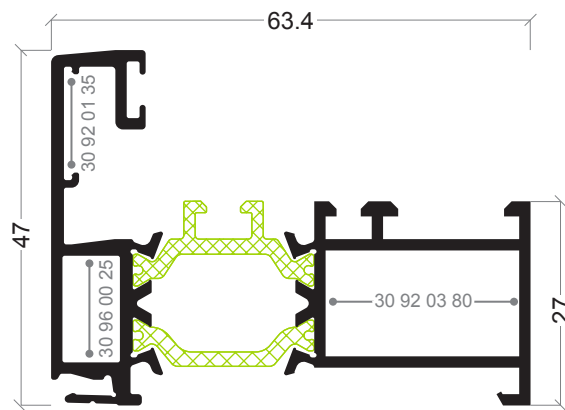

ATi-86
Aro fixo

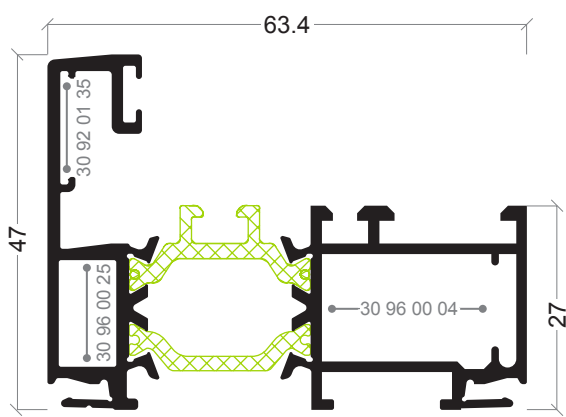

ATi-87
Aro fixo

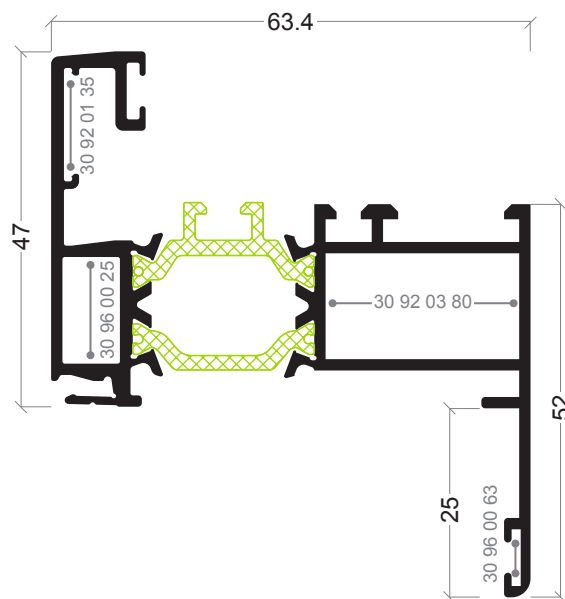

ATi-85
Aro fixo com remate

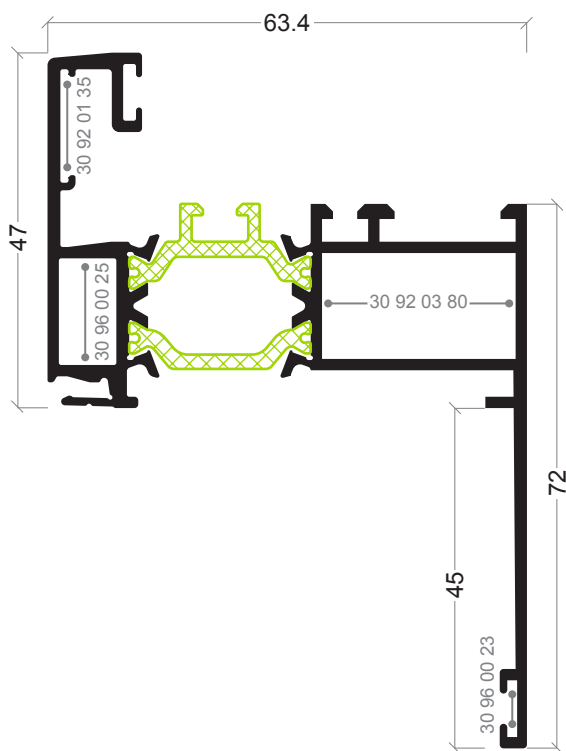

ATi-82
Aro fixo com remate

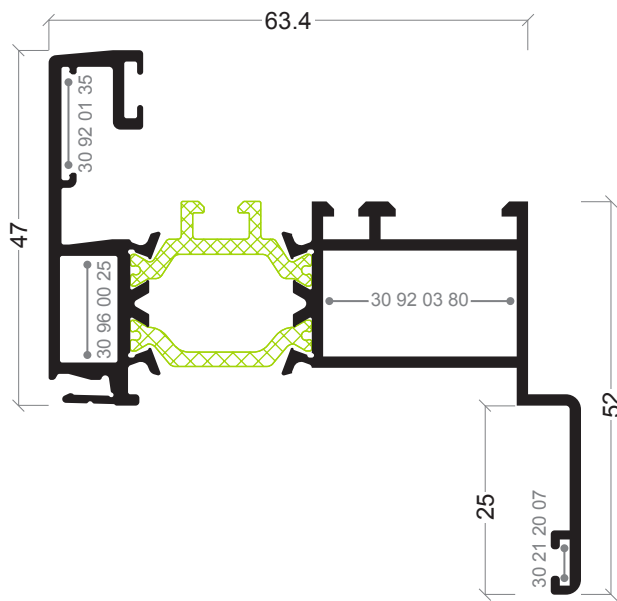

ATi-84
Aro fixo com remate

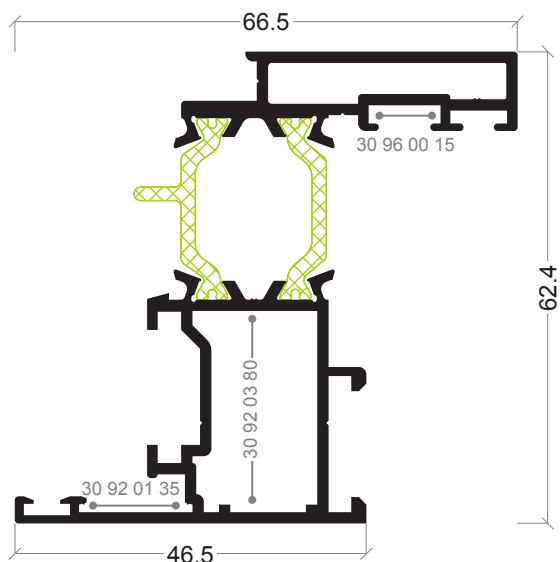

ATi-64
Aro móvel

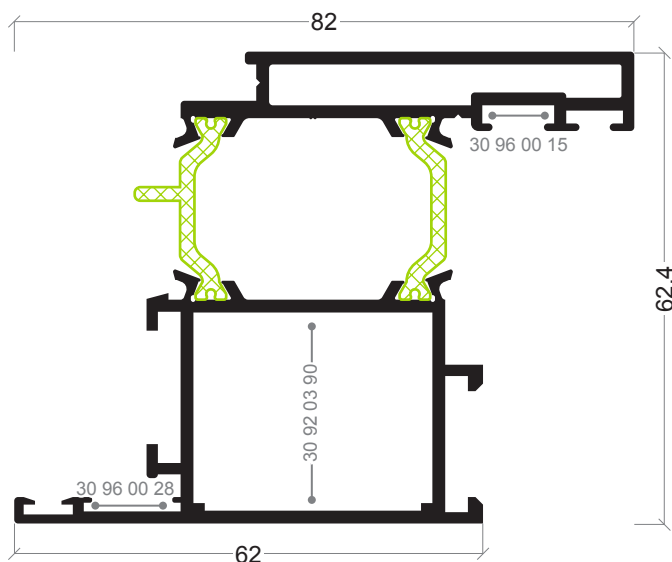

ATi-65
Aro móvel

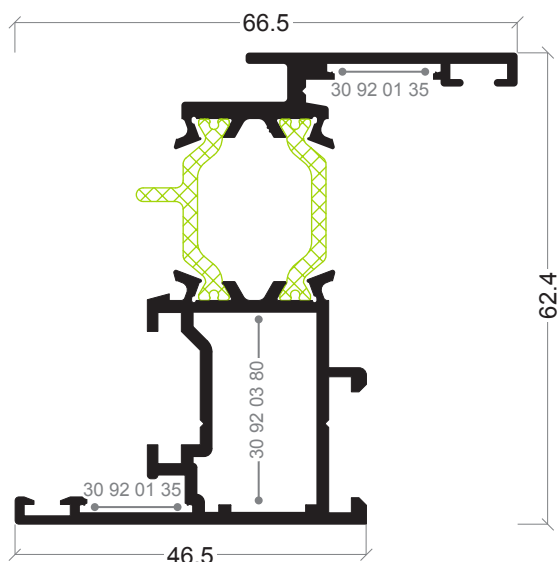

ATi-02
Aro móvel

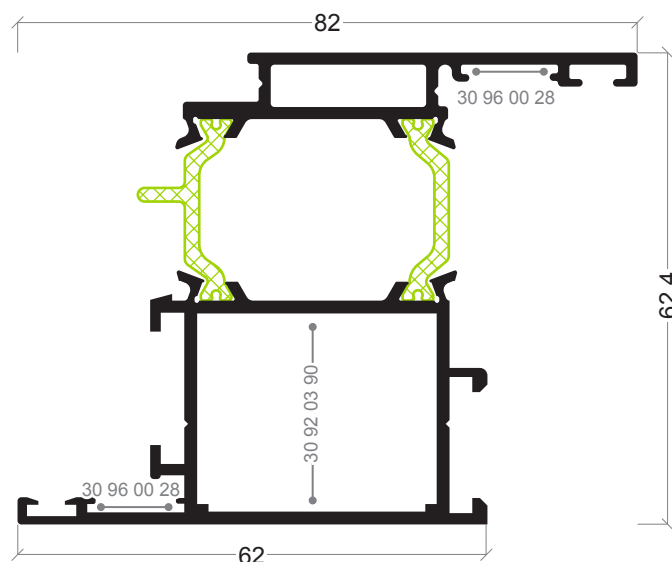

ATi-07
Aro móvel

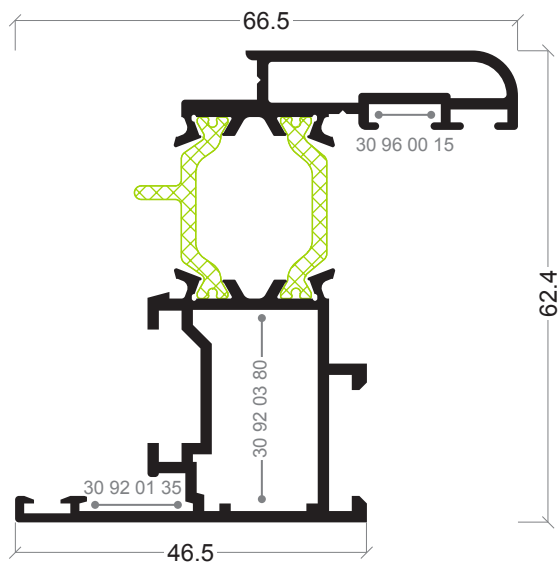

ATi-05
Aro móvel

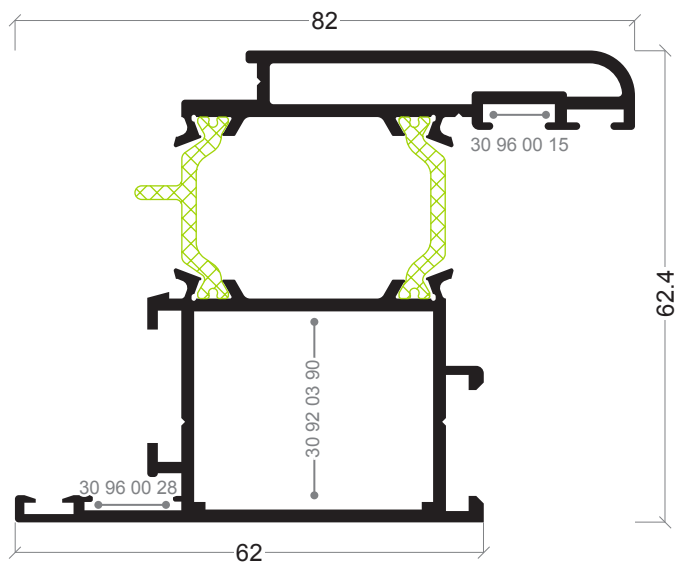

ATi-10
Aro móvel

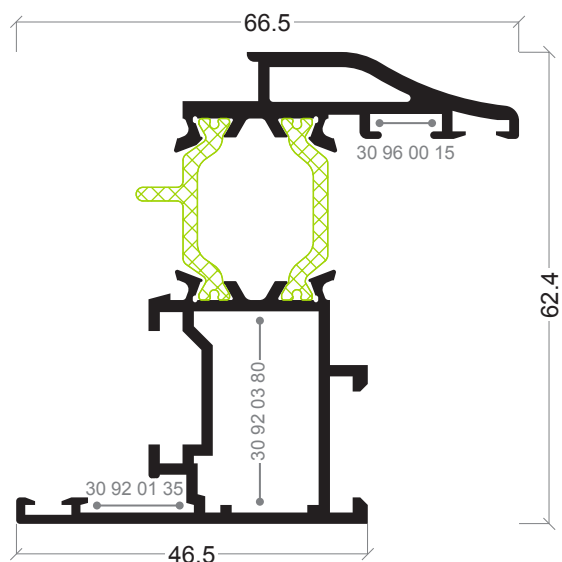

ATi-52
Aro móvel

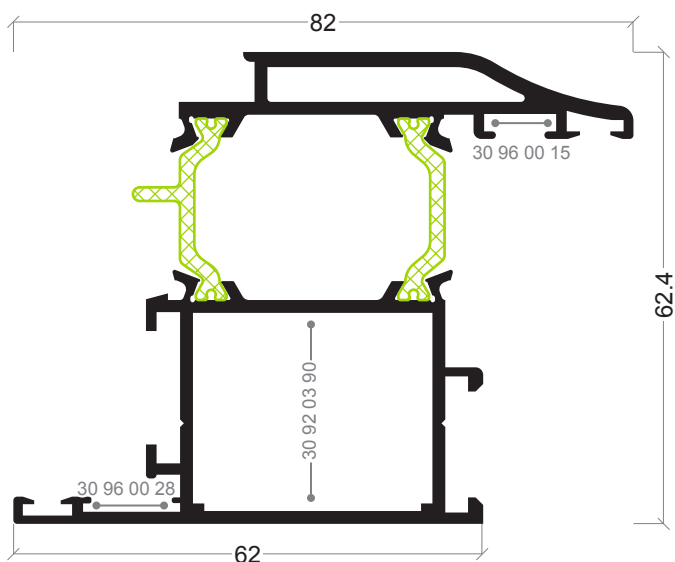

ATi-53
Aro móvel

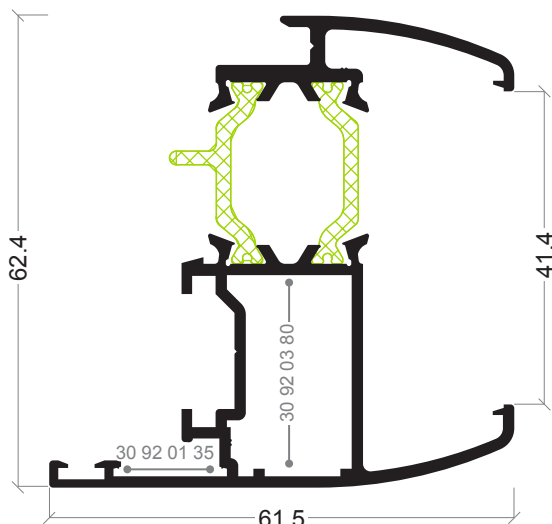

ATi-76
Aro móvel

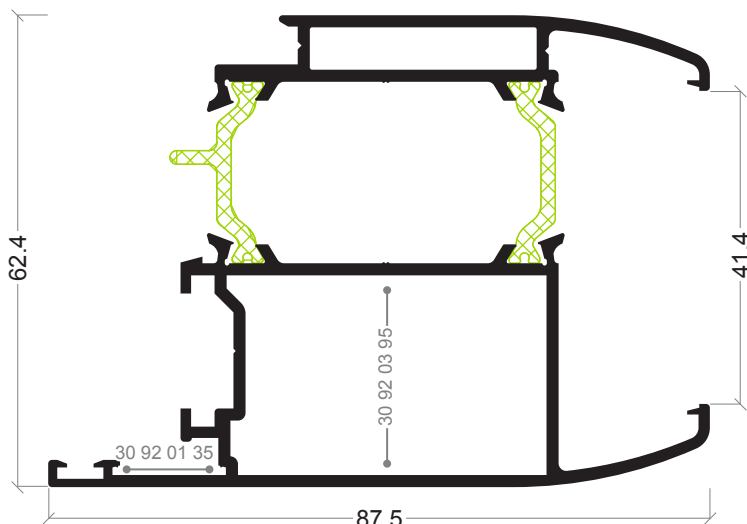

ATi-77
Aro móvel

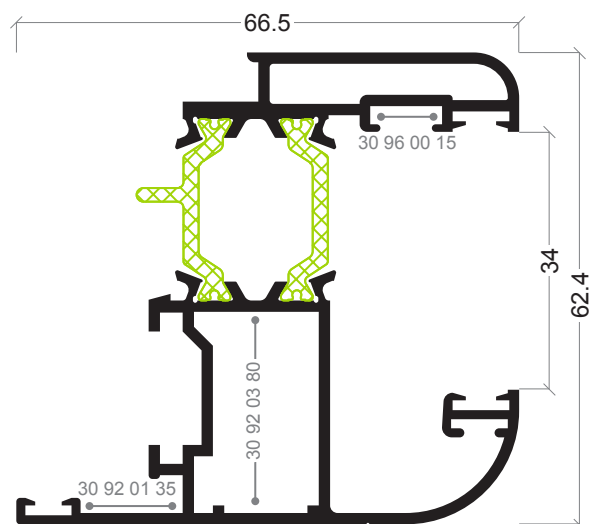

ATi-44
Aro móvel

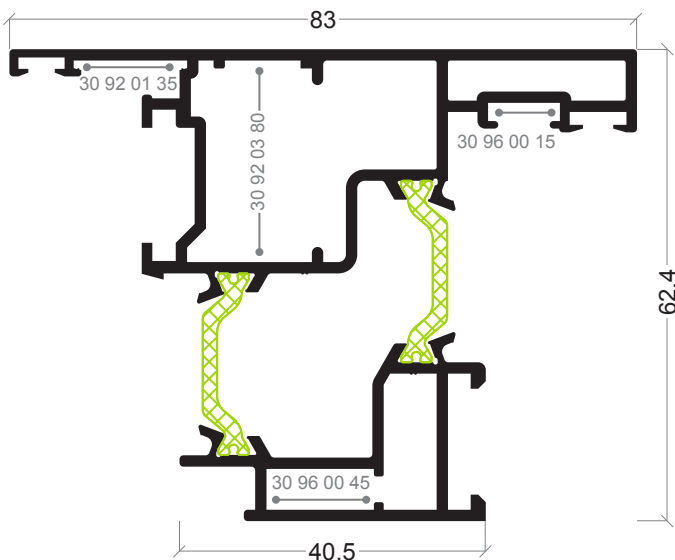

ATi-60
Aro móvel abertura exterior

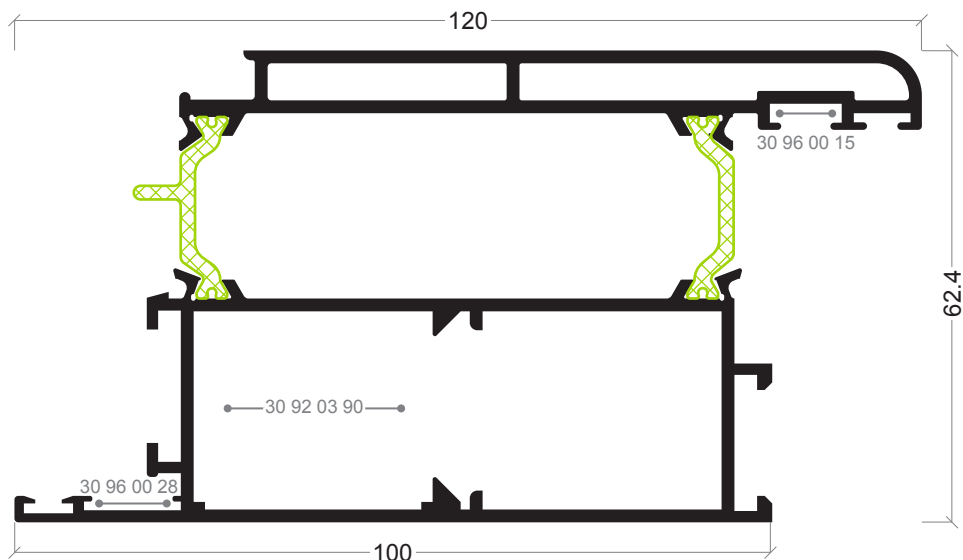

ATi-66
Aro móvel

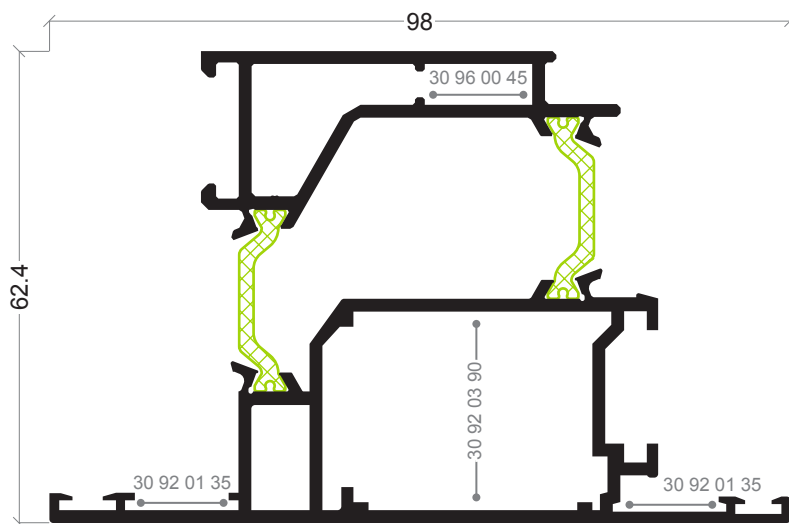

ATi-71
Aro móvel abertura exterior

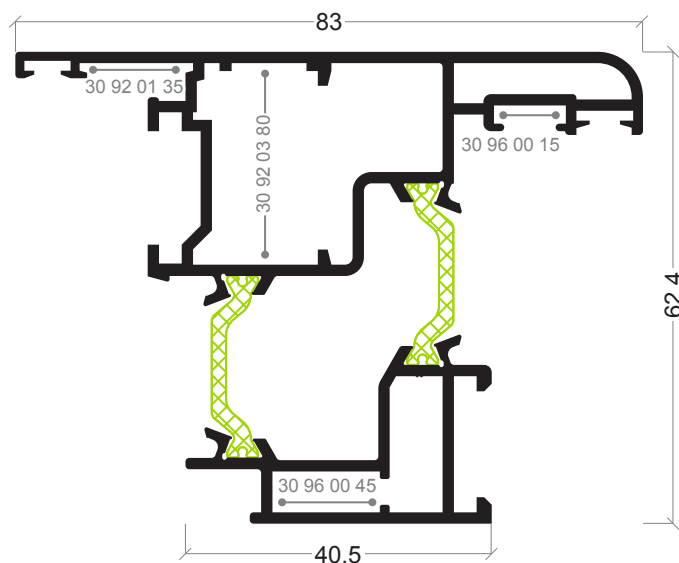

ATi-59
Aro móvel abertura exterior

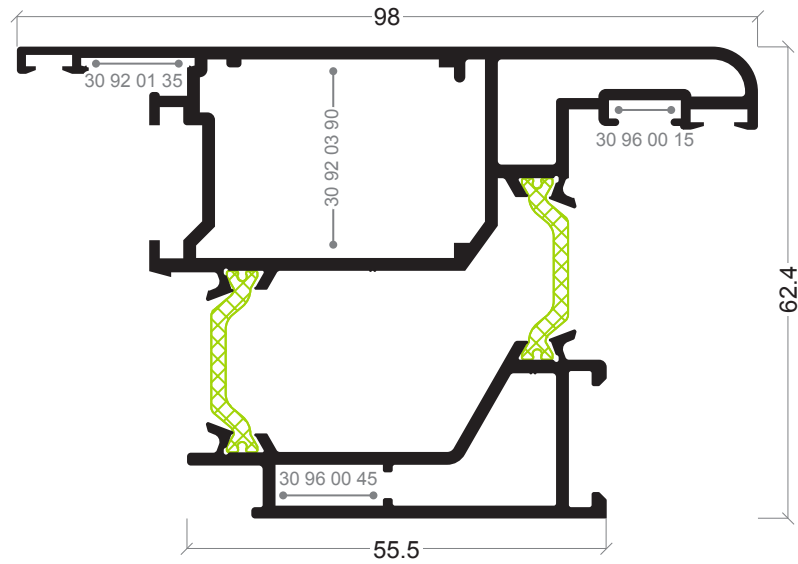

ATi-62
Aro móvel abertura exterior

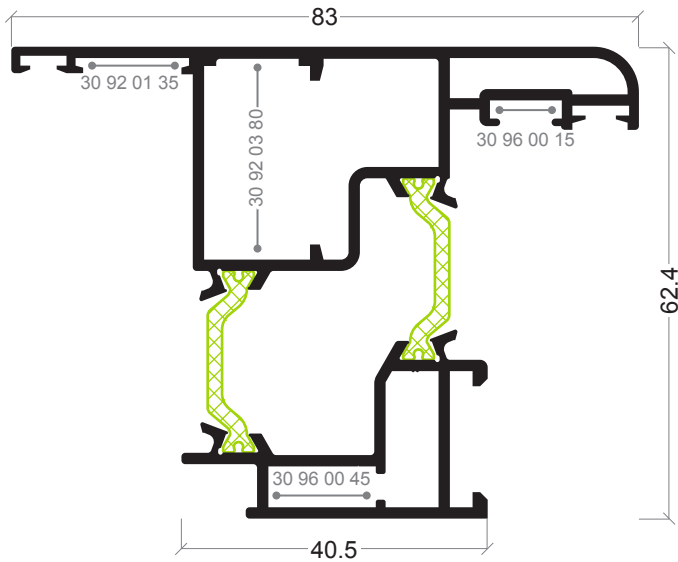

ATi-63
Aro móvel projectante

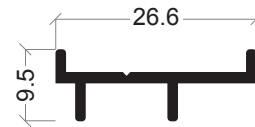

AXi-32
Complemento abertura projectante

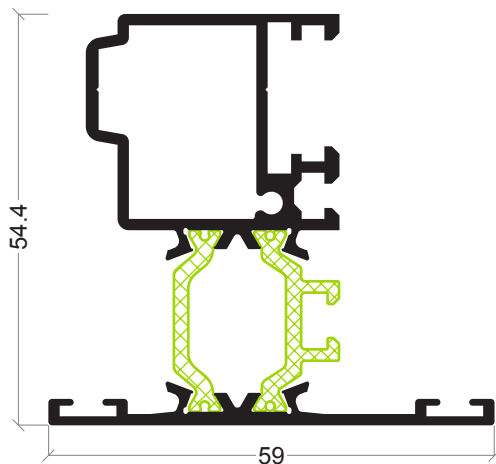

ATi-04
Inversor

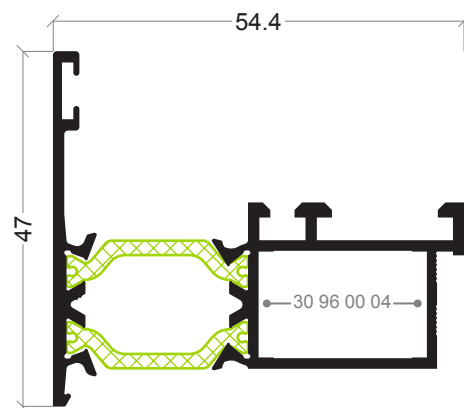

ATi-75
Inversor abertura exterior

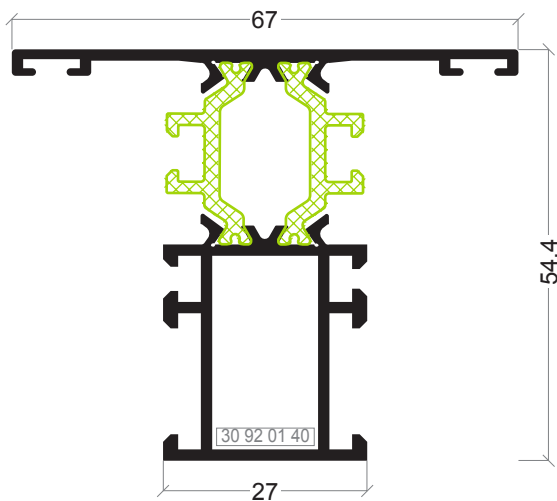

ATi-01
Travessa

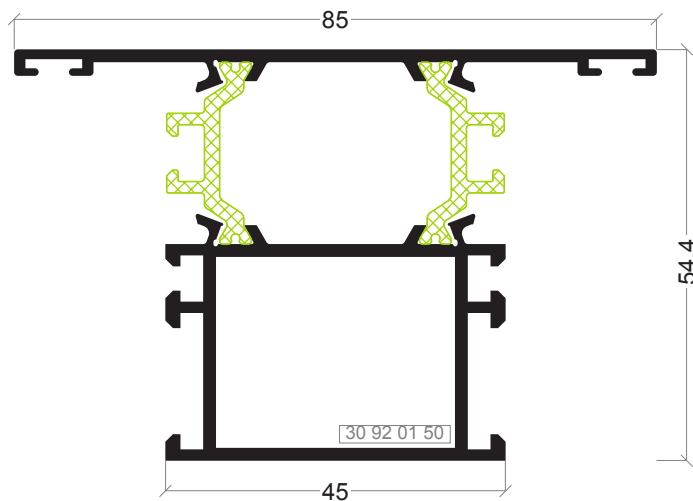

ATi-06
Travessa

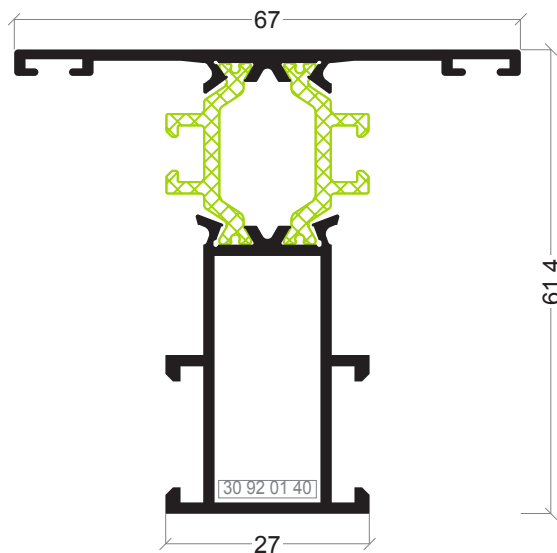

ATi-09
Travessa

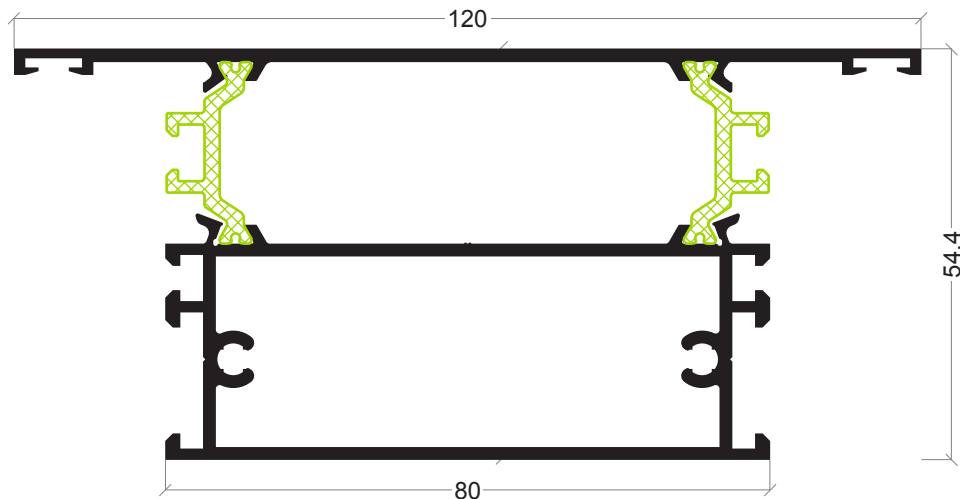

ATi-12
Travessa

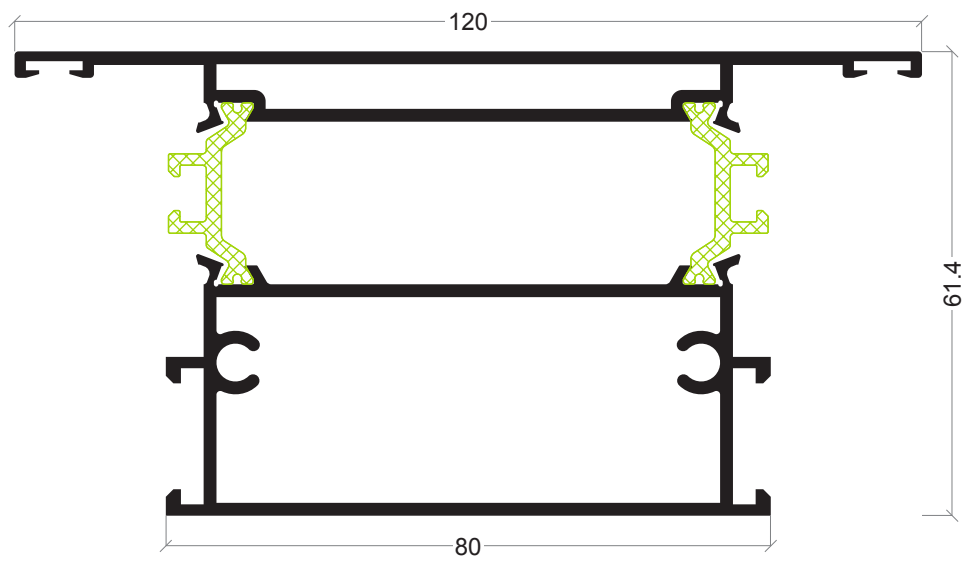

ATi-14
Travessa

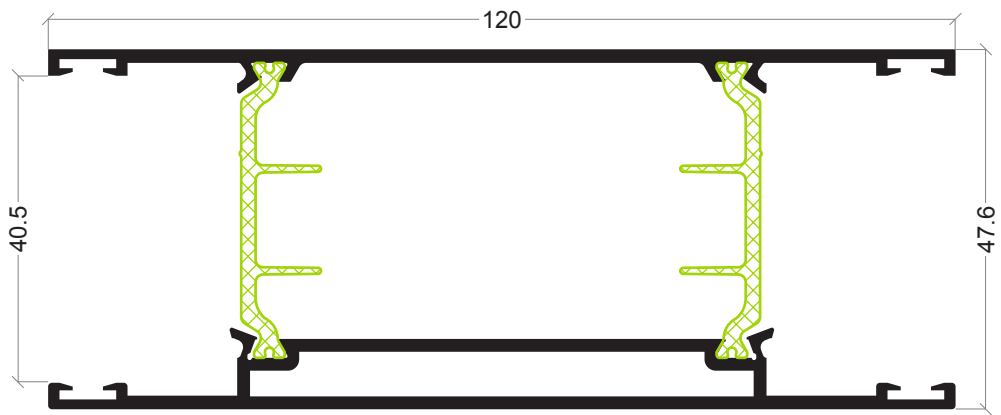

ATi-79
Travessa para ATi-77

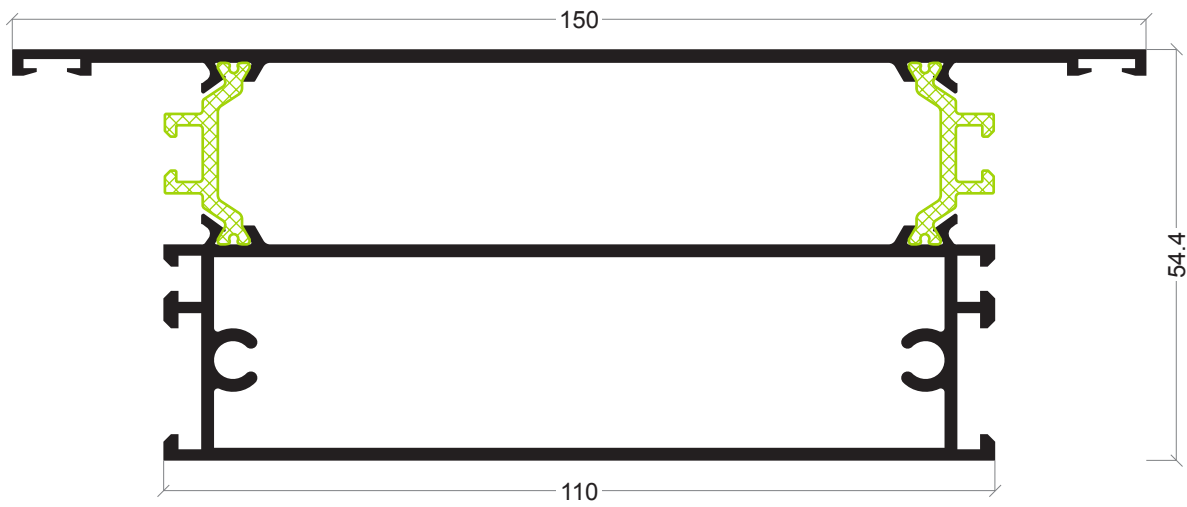

ATi-13
Travessa

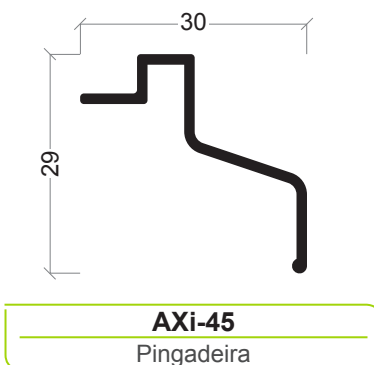
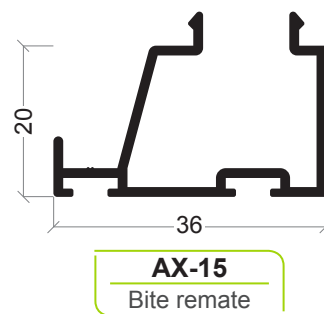
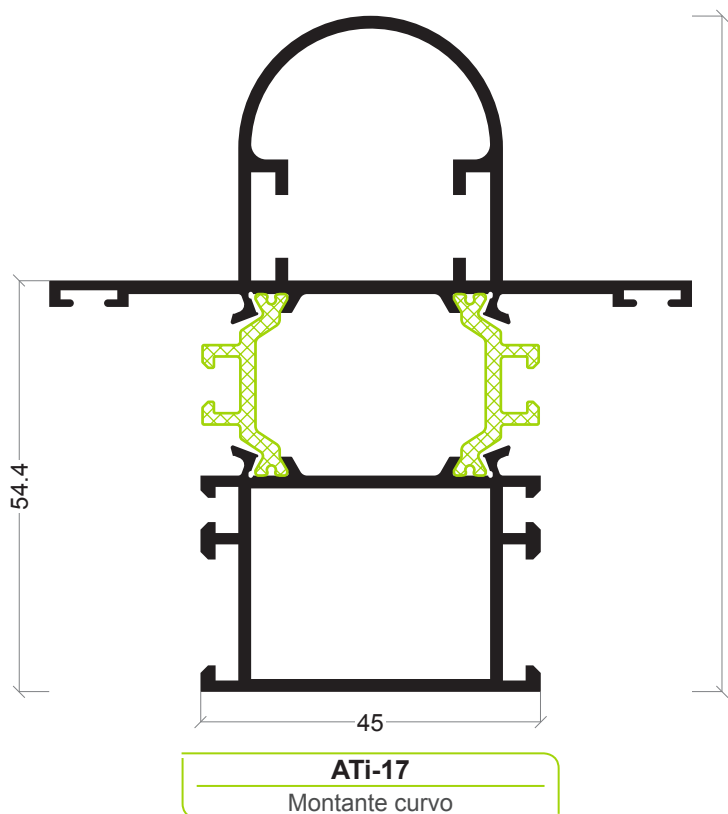

46

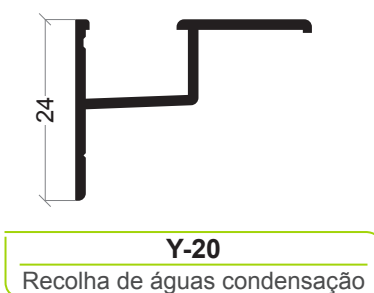
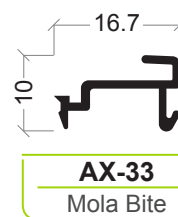
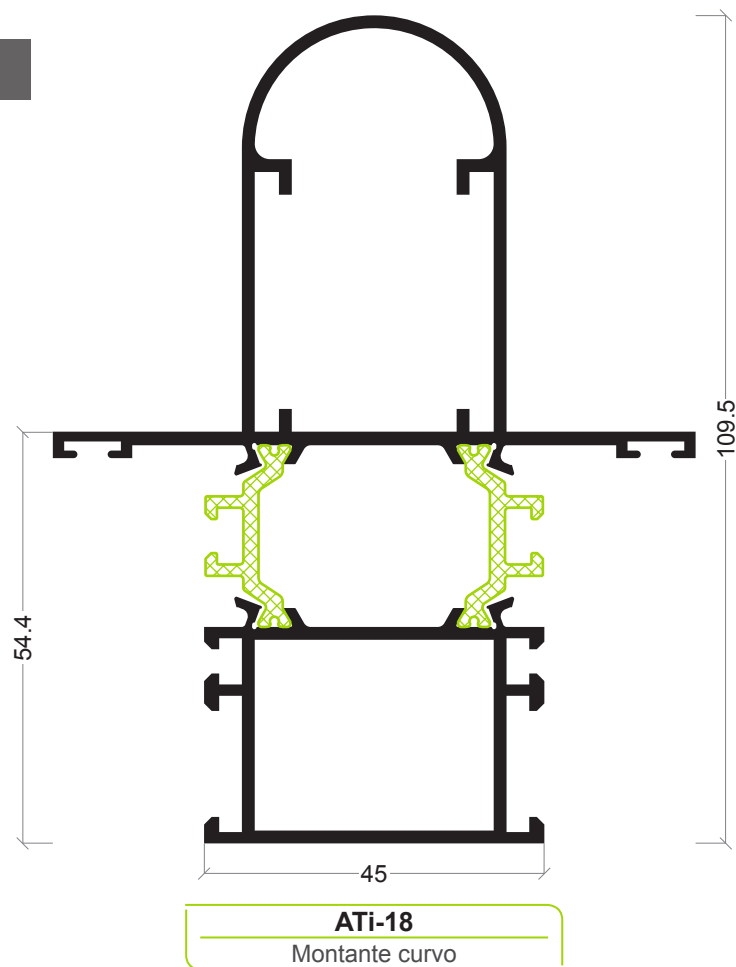

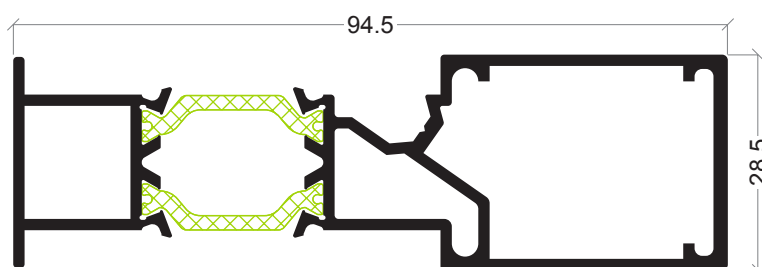
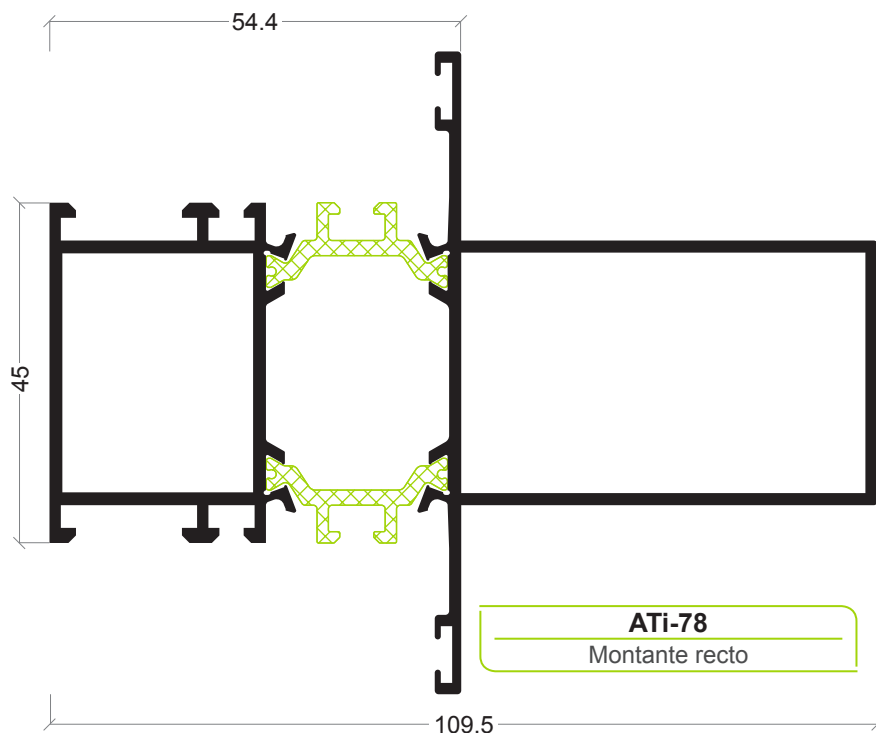

ATi-67
União de aros com reforço

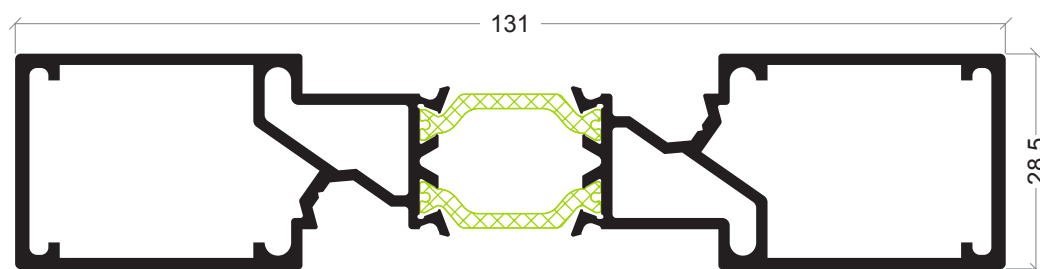

ATi-68
União de aros com reforço

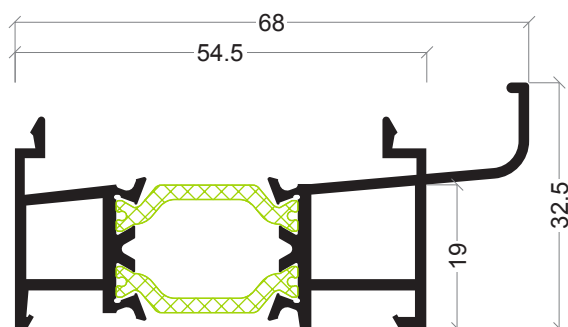

ATi-57
Soleira condensação

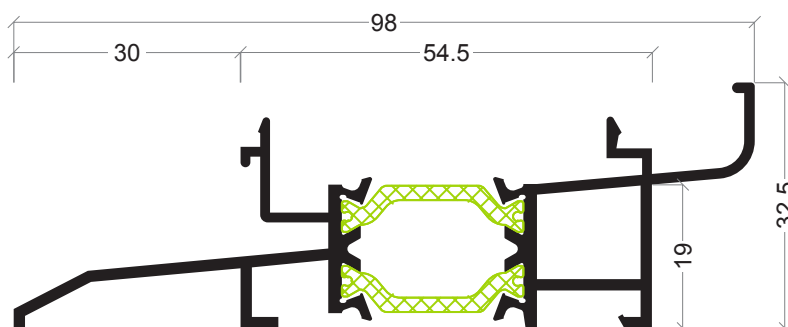

ATi-29
Soleira condensação

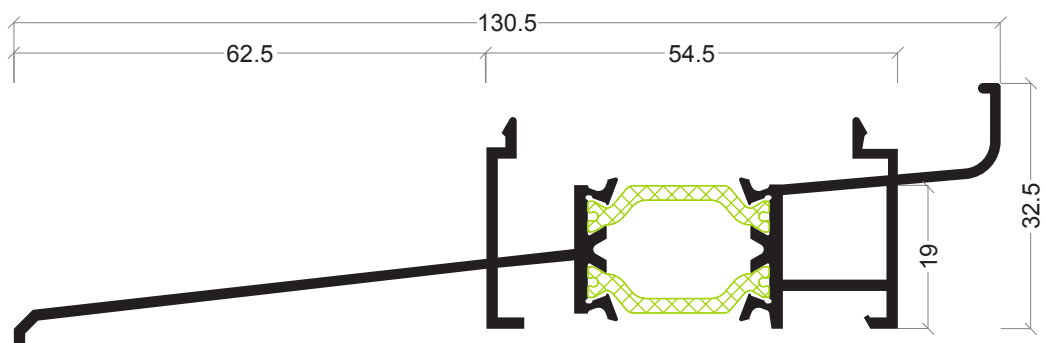

ATi-30
Soleira condensação

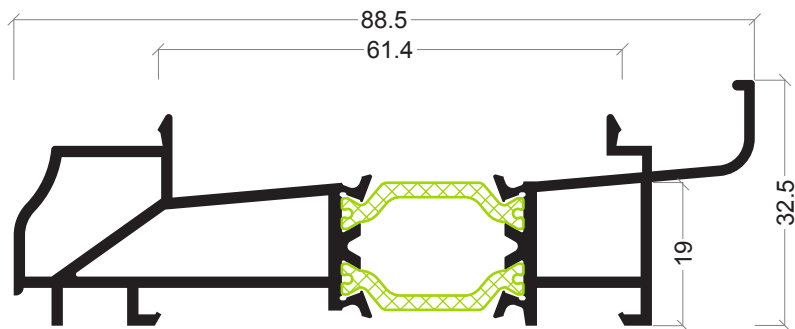

ATi-55
Soleira condensação

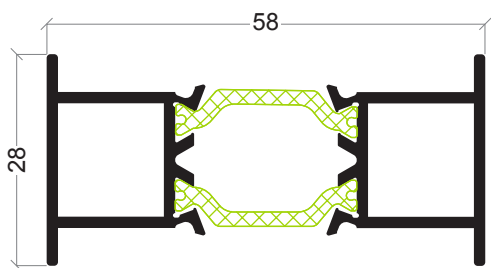

ATi-54
União de aros

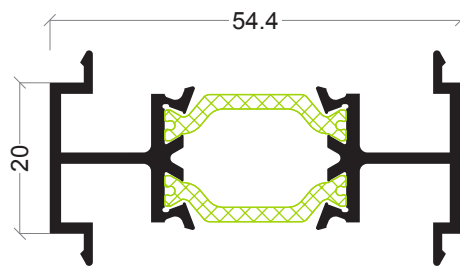

ATi-15
União de aros

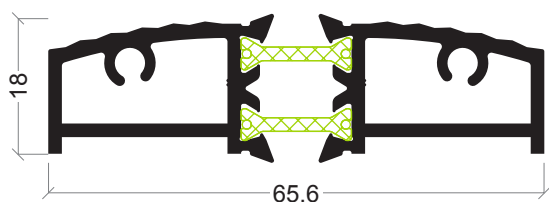

AXi-69
Remate inferior porta

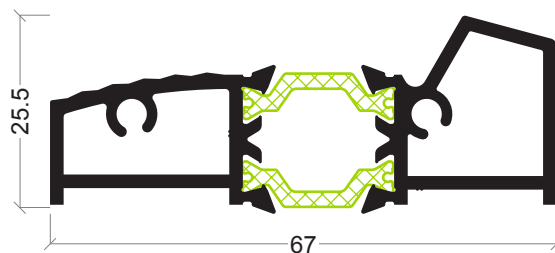

ATi-70
Remate inferior porta

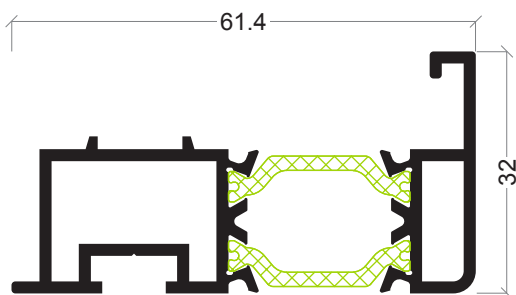

ATi-42
Remate almofada

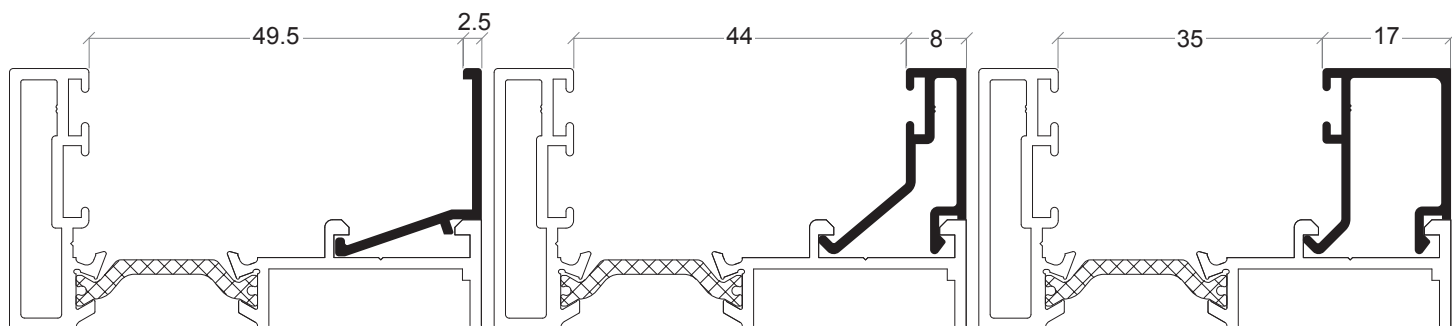

AX-69

AX-74

AX-46

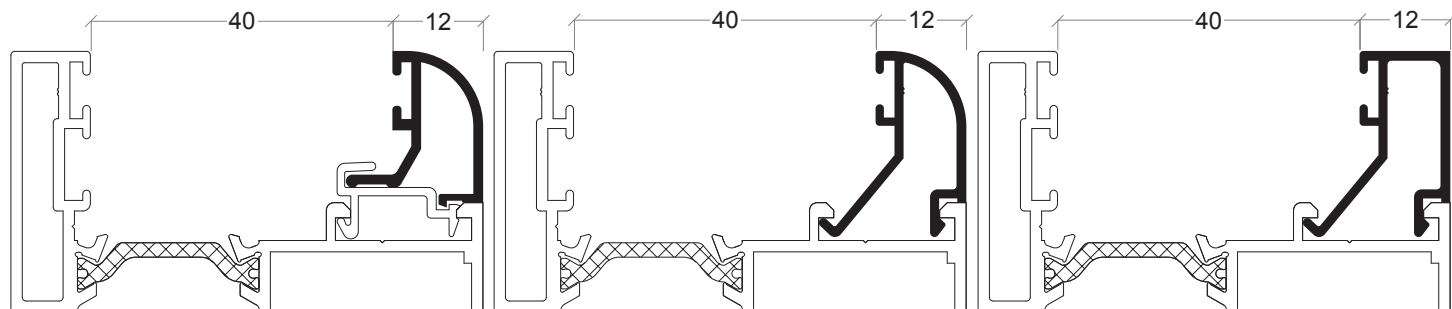

AX-37

AZ-08

AX-36

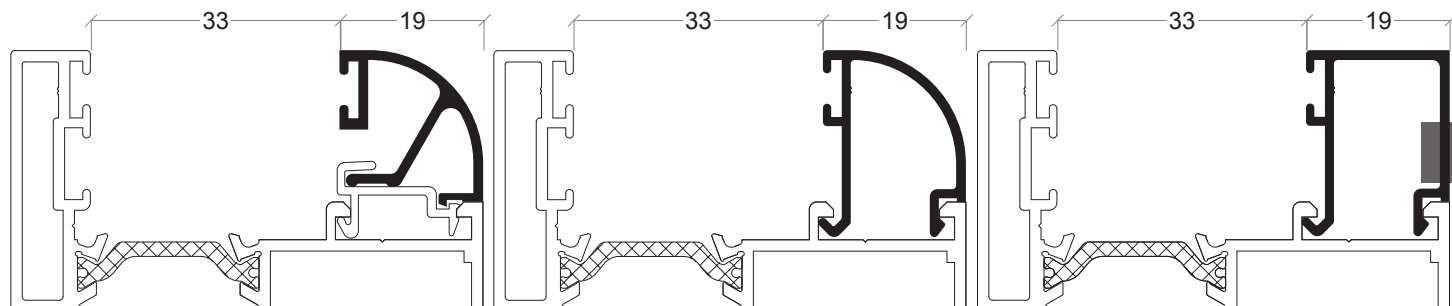

AX-30

AZ-07

AX-35

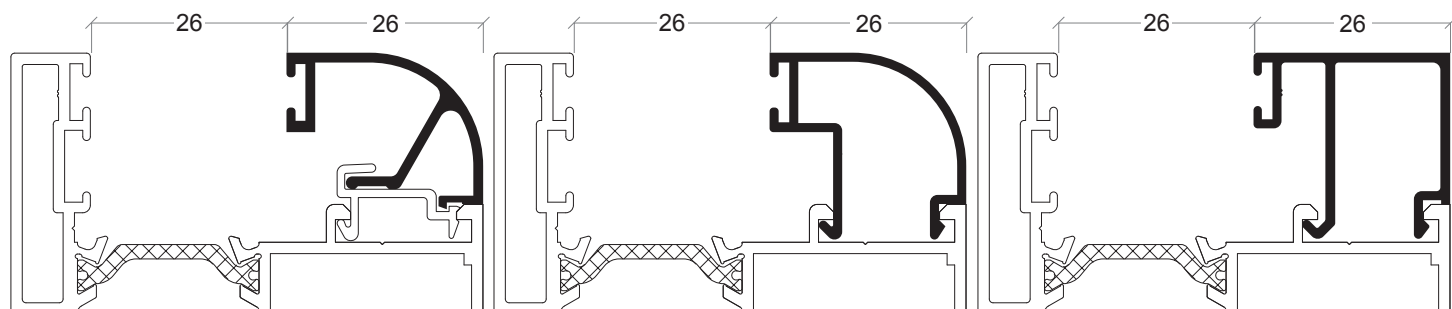

AX-29

AZ-06

AX-31

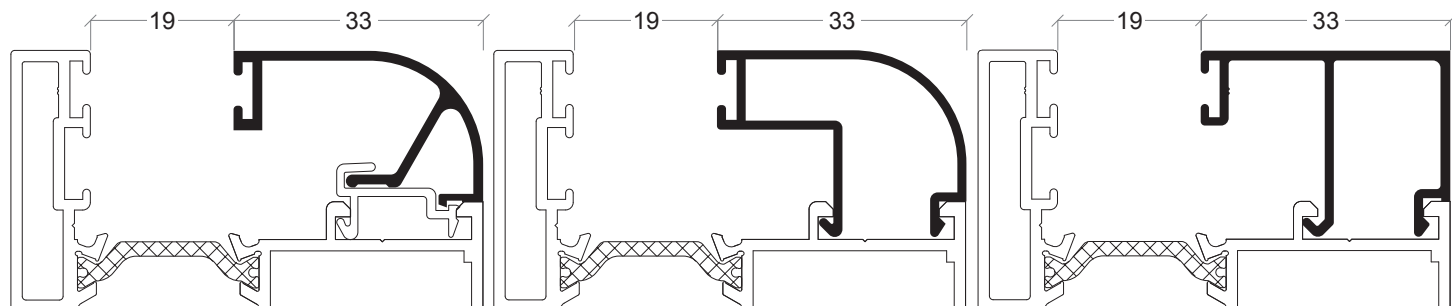

AX-39

AZ-28

AX-34

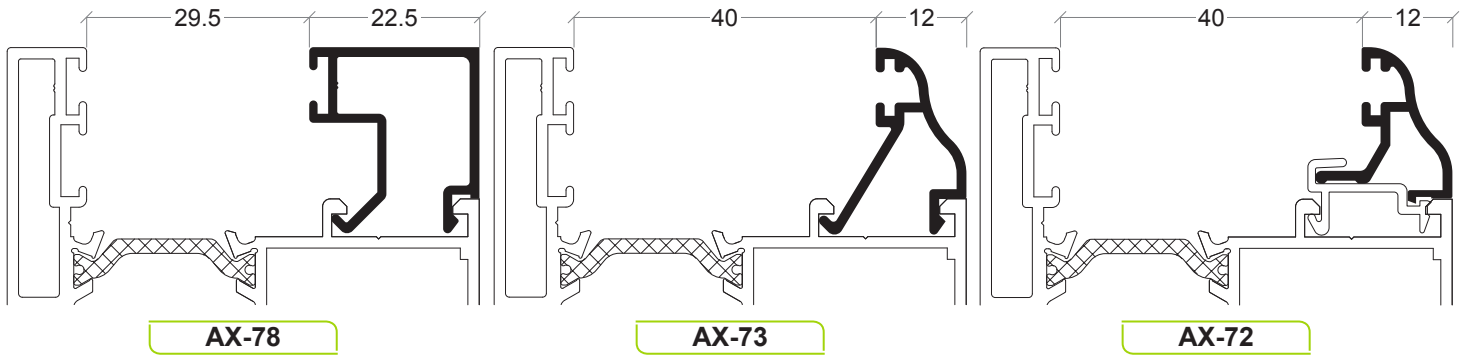

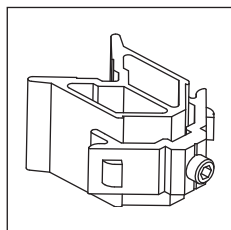

30 20 30 09

Esquadro móvel pivotante

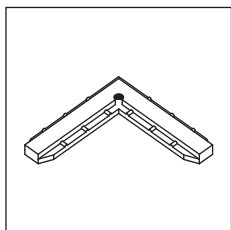

30 21 20 07

Esquadro de alinhamento

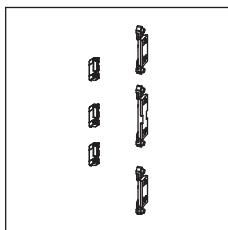

30 90 20 40

Transmissão abertura exterior

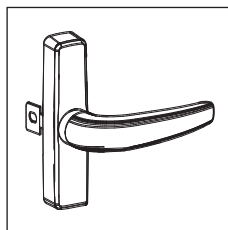

30 90 20 50/51

Cremona para abertura exterior

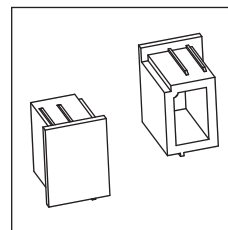

30 91 21 20

Jogo topos condensação Y-20

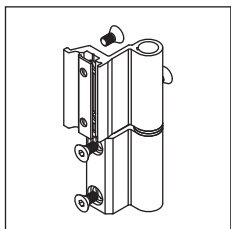

30 92 00 20/21

Dobradiça C.E. branco/preto

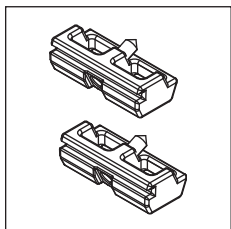

30 92 00 50

Complemento fecho

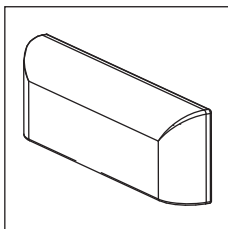

30 92 01 00/01

Goteiras branco/preto

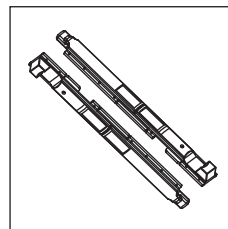

30 92 01 20

Jogo fecho C.E.

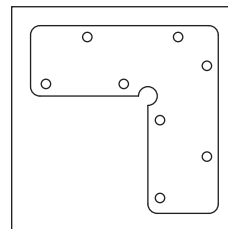

30 92 01 35

Esquadro alinhamento

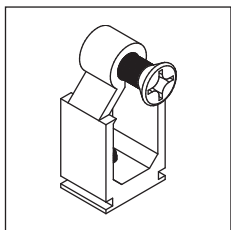

30 92 01 40

União topos janela

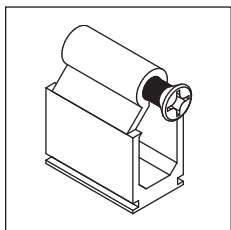

30 92 01 50

União topos porta

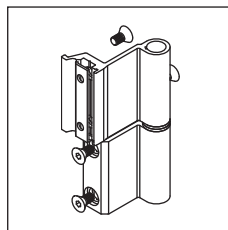

30 92 01 70/80

Dobradiça 3 folhas branco/preto

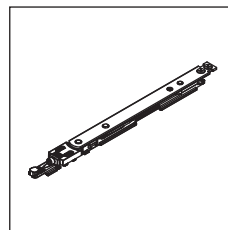

30 92 02 10/11/12

Compasso oscilo 300/400/500

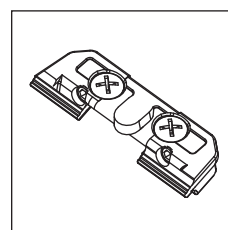

30 92 02 15

Fecho para micro-ventilação

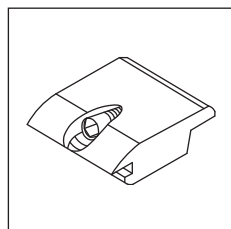

30 92 02 60

Apoio da folha

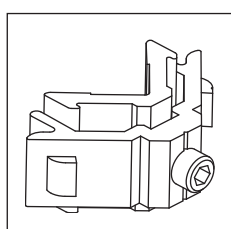

30 92 03 80

Esquadro janela

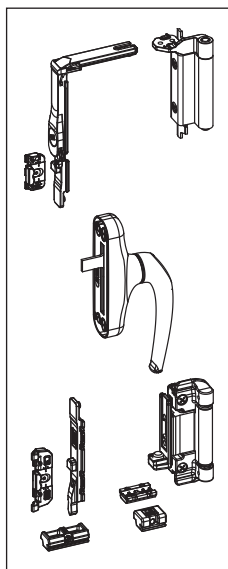

30 92 02 20/21

Kit oscilobatente branco/preto

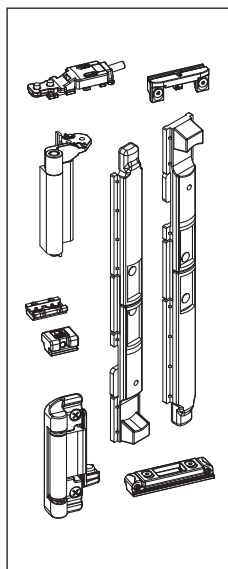

30 92 02 24/25

Kit 2ª folha oscilobatente branco/preto

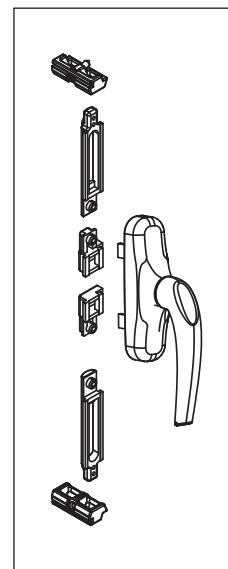

30 92 03 10/11

Kit cremone branco/preto

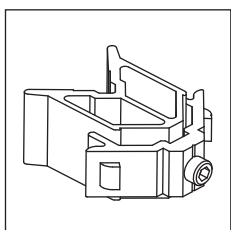

30 92 03 90

Esquadro porta

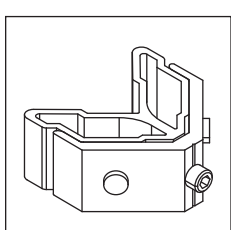

30 92 04 10

Esquadro janela abertura exterior

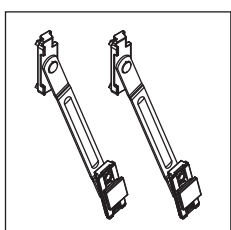

30 92 04 75

Jogo compasso basculante

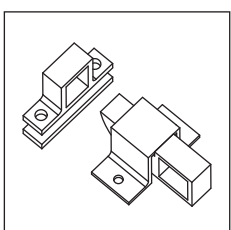

30 92 04 76/77

Fecho clack (branco/preto)

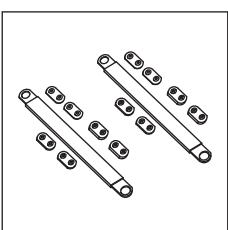

30 92 04 85

Jogo compasso

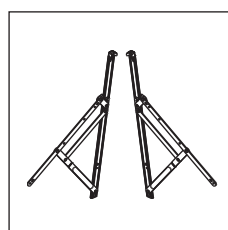

30 92 04 90

Compasso SEN-550 (até 70kg /folha)

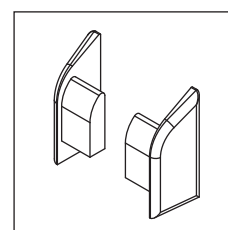

30 92 05 00

Jogo topos

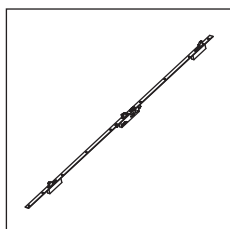

30 92 05 10

Fechadura 3 pontos
35 mm

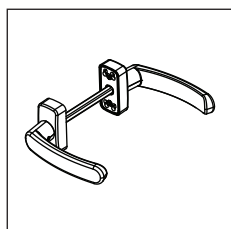

30 92 05 15

Fecho de alavanca com
5 pontos de fecho

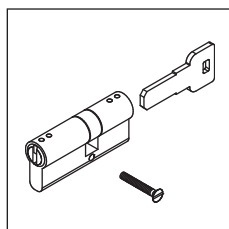

30 92 05 52

Canhão de segurança

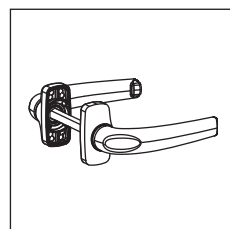

30 92 05 60/61

Puxador duplo branco/
preto

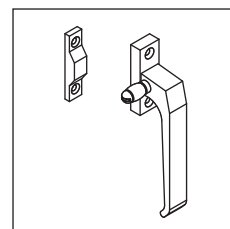

30 92 06 10/11

Cremona de lingueta
branco/preto

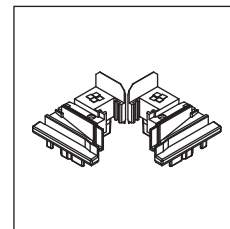

30 93 50 21

Conjunto topos
inversores com furo ATi

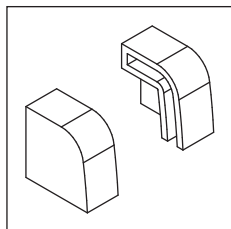

30 96 00 12

Jogo topos condensação

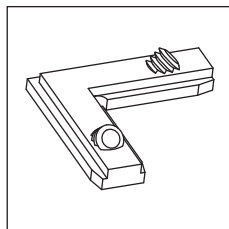

30 96 00 15

Esquadro de
alinhamento

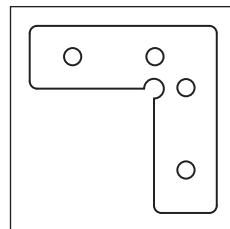

30 96 00 28

Esquadro alinhamento especial
ATi-07/10/53/65/66

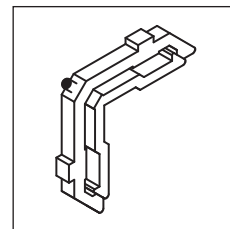

30 96 00 38

Esquadro alinhamento
exterior

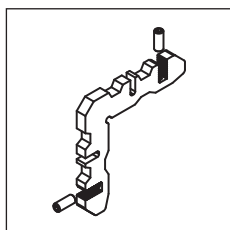

30 96 00 45

Esquadro alinhamento
exterior com parafusos

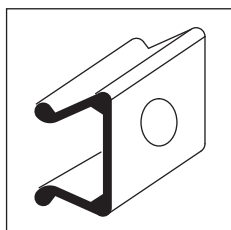

31 03 40 00

Mola para AZ-60

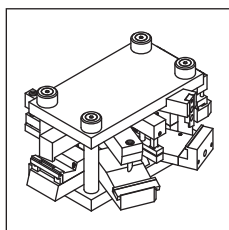

33 96 79 99

Cunho C.E.

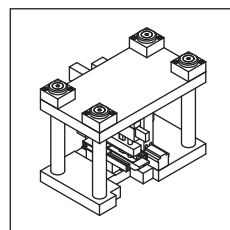

33 96 87 99

Cunho esquadros
interior/exterior

Referência	Desenho	Descrição
30 00 95 15		Junta vedação inferior curta
30 60 00 17		Junta exterior vidro plana 2 mm preto
30 92 04 70		Espuma isolante
30 93 00 60		Vedante exterior do vidro (opcional)
30 93 00 61		Junta de vedação exterior
30 93 00 62		Junta exterior plana
30 93 00 65		Junta interior para vidro (5 mm)
30 93 00 66		Junta interior para vidro (4 mm)
30 93 00 67		Junta interior para vidro (2 mm)
30 93 00 68		Junta interior para vidro (6/7 mm)
30 93 00 69		Junta interior para vidro (8/9 mm)
30 93 00 70		Vedante interior do vidro (opcional)
30 93 00 80		Junta de vedação inferior ATi-42
30 93 00 82		Junta de vedação inferior
30 93 00 90		Junta exterior
30 93 01 20		Junta interior
30 93 01 30		Junta exterior (abertura exterior/projectante)
30 93 50 10		Junta central ATi
30 95 00 10		Pelúcia 7x9 mm
30 95 00 40		Pelúcia 7x5.5 mm

Janela 1 folha abrir e oscilo-batente

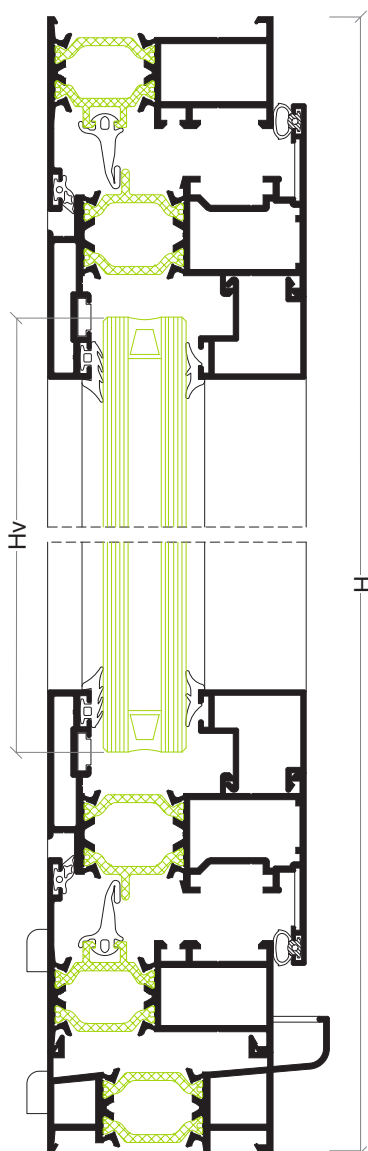
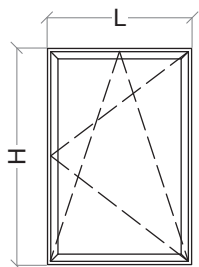

Perfis

Desenho	Ref	Descrição	Corte	Quant	Medida
	ATi-03	Aro fixo		2	L
				2	H-24 mm
	ATi-64	Aro móvel		2	L-42 mm
				2	H-66 mm
	ATi-57	Soleira condensação		1	L
	AX-19	Vareta		1+1	Apro. L+H
	---	Bite		2	L-135 mm
				2	H-199 mm

Acessórios e Juntas

Referência	Descrição	Quantidade	
		Abrir	Oscilo-batente
30 92 00 20	Dobradiças C.E.	2	---
30 92 01 00	Goteiras	4	4
30 92 01 35	Esquadro alinhamento aro móvel	4	4
30 92 02 (xx)	Compasso O.B.	---	1
30 92 02 20	Kit oscilo-batente	---	1
30 92 02 60	Apoio da folha	1	---
30 92 03 10	Kit cremone	1	---
30 92 03 80	Esquadro janela	8	8
30 96 00 12	Jogo topos condensação	1	1
30 96 00 15	Esquadro alinhamento móvel	4	4
30 92 04 70	Espuma isolante	L	L
30 93 00 90	Junta exterior	2L+2H	
30 93 50 10	Junta central	2L+2H	
30 93 01 20	Junta interior	2L+2H	
---	Junta exterior vidro	2L+2H	
---	Junta interior vidro	2L+2H	

53

Vidro

Hv = H-174 mm	Lv = L-149 mm
---------------	---------------

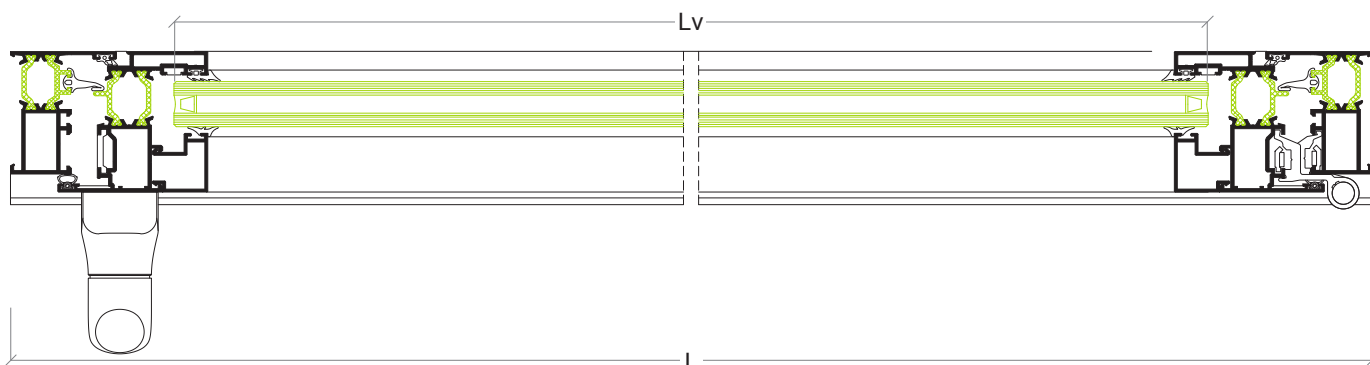

Janela 2 folhas abrir e oscilo-batente

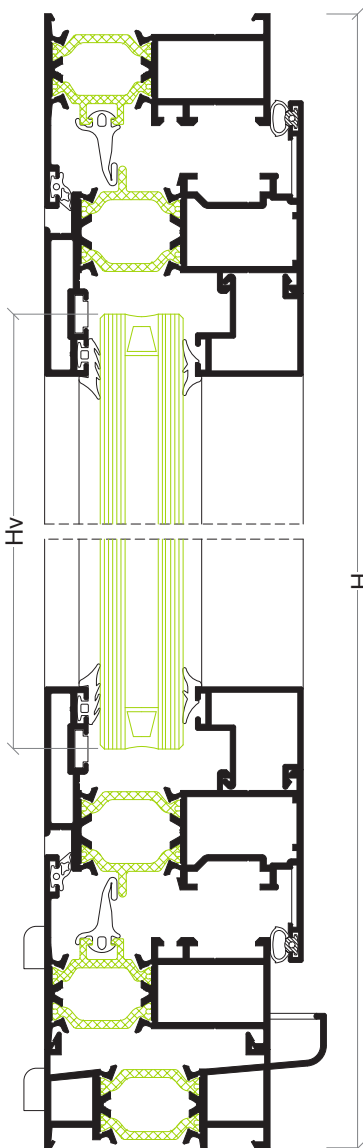
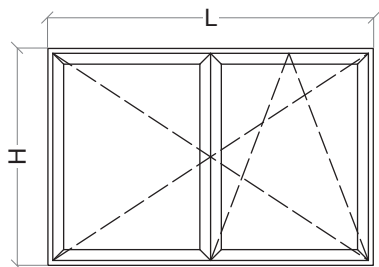

Perfis

Desenho	Ref	Descrição	Corte	Quant	Medida
	ATi-03	Aro fixo		2	L
				2	H-24 mm
	ATi-64	Aro móvel		4	L/2-24 mm
				4	H-66 mm
	ATi-57	Soleira condensação		1	L
	AX-19	Vareta		1+1	Apro. L+H
	---	Bite		4	L/2-117 mm
				4	H-199 mm
	ATi-04	Inversor		1	H-134 mm

Acessórios e Juntas

Referência	Descrição	Quantidade	
		Abrir	Oscilo-batente
30 92 00 20	Dobradiças C.E.	4	---
30 92 01 00	Goteiras	4	4
30 92 01 20	Jogo fecho C.E.	1	---
30 92 01 35	Esquadro alinhamento aro móvel	8	8
30 92 02 (xx)	Compasso O.B.	---	1
30 92 02 20	Kit oscilo-batente	---	1
30 92 02 24	Kit 2ª folha oscilo-batente	---	1
30 92 02 60	Apoio da folha	1	---
30 92 03 10	Kit cremone	1	---
30 92 03 80	Esquadro janela	12	12
30 93 50 21	Jogo topos inversor	1	1
30 96 00 12	Jogo topos condensação	1	1
30 96 00 15	Esquadro alinhamento móvel	8	8
30 92 04 70	Espuma isolante	L	L
30 93 00 90	Junta exterior	2L+4H	
30 93 05 10	Junta central	2L+3H	
30 93 01 20	Junta interior	2L+4H	
---	Junta exterior vidro	2L+4H	
---	Junta interior vidro	2L+4H	

Vidro

Hv = H-174 mm	Lv = L/2-131 mm
---------------	-----------------

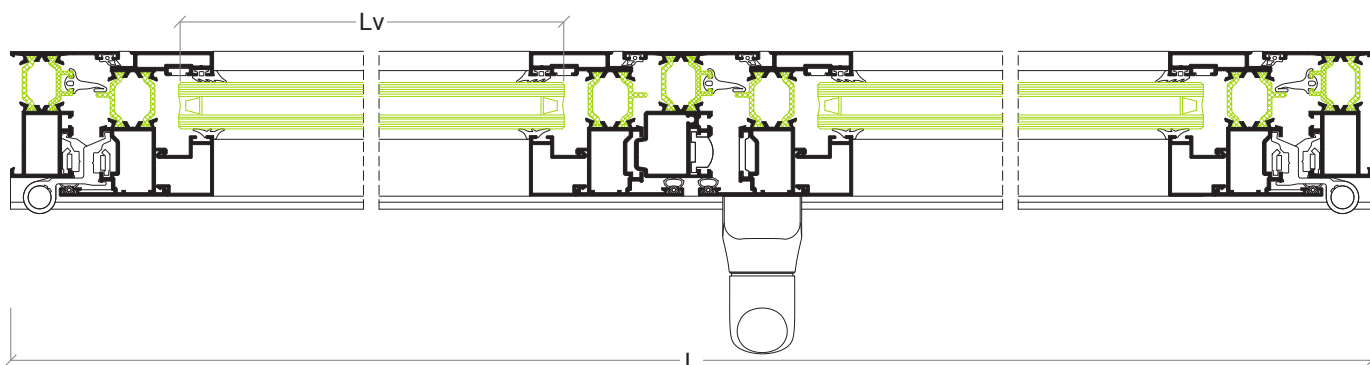

Porta 1 folha

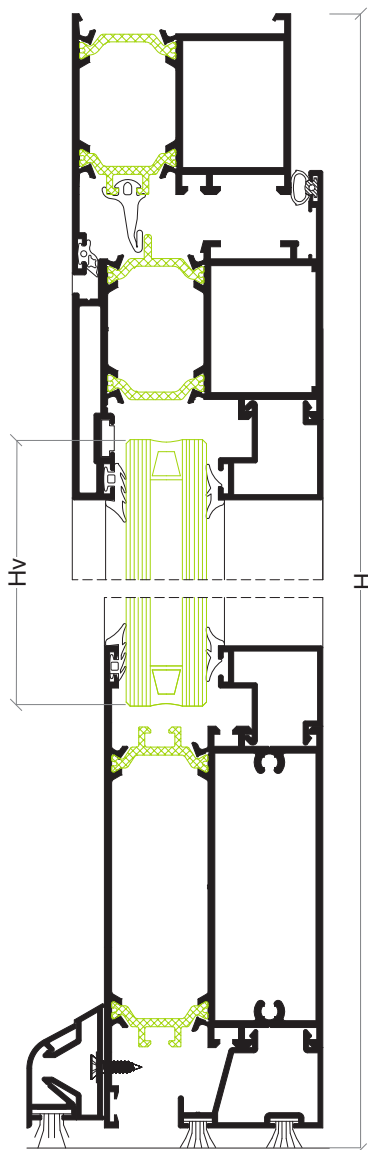
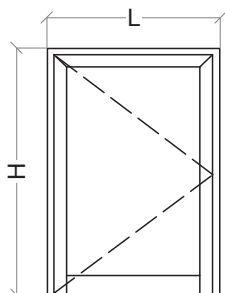

Perfis

Desenho	Ref	Descrição	Corte	Quant	Medida
	ATi-08	Aro fixo		1	L
				2	H
	ATi-65	Aro móvel		1	L-78 mm
				2	H-44 mm
	ATi-12	Travessa		1	L-193 mm
	AX-15	Bite remate		1	L-202 mm
	---	Bite		2	L-202 mm
				2	H-246 mm
	AZ-60	Pingadeira		1	L-145 mm
	AZ-61	Clip pingadeira		1	L-242 mm

Acessórios e Juntas

Referência	Descrição	Quantidade
30 92 00 20	Dobradiças C.E.	3
30 92 03 90	Esquadro porta	4
30 92 05 10	Fechadura 3 pontos	1
30 92 05 52	Canhão fechadura	1
30 92 05 60	Puxador duplo	1
30 96 00 15	Esquadro alinhamento móvel	2
30 92 05 00	Jogo topos	1
30 96 00 28	Esquadro alinhamento	2
30 93 00 90	Junta exterior	1L+2H
30 93 05 10	Junta central	1L+2H
30 93 01 20	Junta interior	1L+2H
30 95 00 10	Pelúcia 7x9 mm	2L
---	Junta exterior vidro	2L+2H
---	Junta interior vidro	2L+2H

55

Vidro

Hv = H-220 mm	Lv = L-216 mm
---------------	---------------

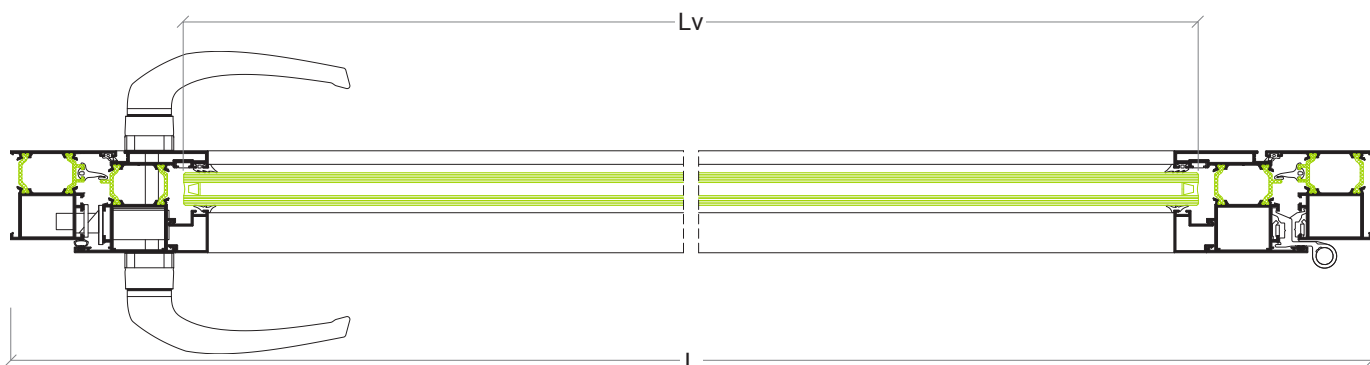

Porta 2 folhas

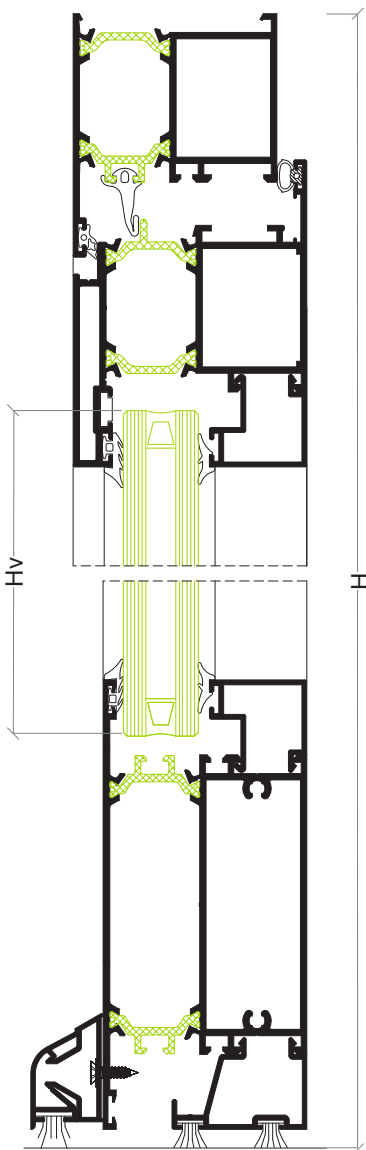
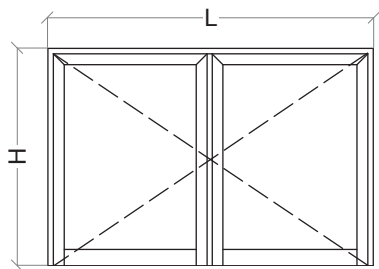

Perfis

Desenho	Ref	Descrição	Corte	Quant	Medida
	ATi-08	Aro fixo		1	L
				4	H
	ATi-65	Aro móvel		2	L/2-42 mm
				4	H-44 mm
	ATi-04	Inversor		1	H-78 mm
	ATi-12	Travessa		2	L/2-157 mm
	AX-15	Bite remate		2	L/2-166 mm
	---	Bite		4	L/2-166 mm
				4	H-246 mm
	AZ-60	Pingadeira		1	Aprox. L/2
				1	Aprox. L/2
	AZ-61	Clip pingadeira		2	L/2-206 mm

Acessórios e Juntas

Referência	Descrição	Quantidade
30 92 00 20	Dobradiças C.E.	6
30 92 01 12	Jogo topos inversor	1
30 92 01 20	Jogo fecho C.E.	1
30 92 03 90	Esquadro porta	6
30 92 05 10	Fechadura 3 pontos	1
30 92 05 52	Canhão fechadura	1
30 92 05 60	Puxador duplo	1
30 96 00 15	Esquadro alinhamento móvel	4
30 92 05 00	Jogo topos	1
30 96 00 28	Esquadro alinhamento	2
30 93 00 90	Junta exterior	1L+4H
30 93 05 10	Junta central	1L+3H
30 93 01 20	Junta interior	L+4H
30 95 00 10	Pelúcia 7x9 mm	2L
---	Junta exterior vidro	2L+2H
---	Junta interior vidro	2L+2H

Vidro

Hv = H-220 mm	Lv = L-180 mm
---------------	---------------

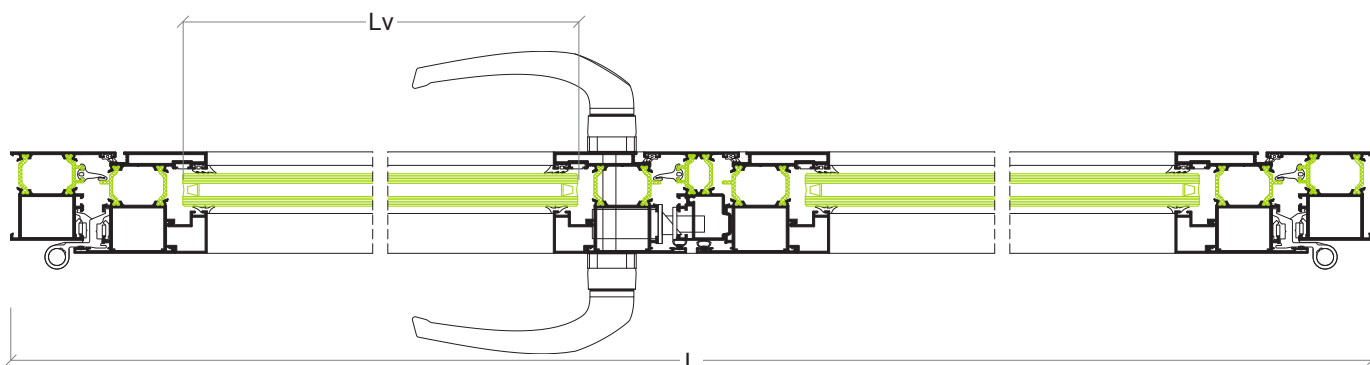

Porta oscilo-paralela com fixo lateral

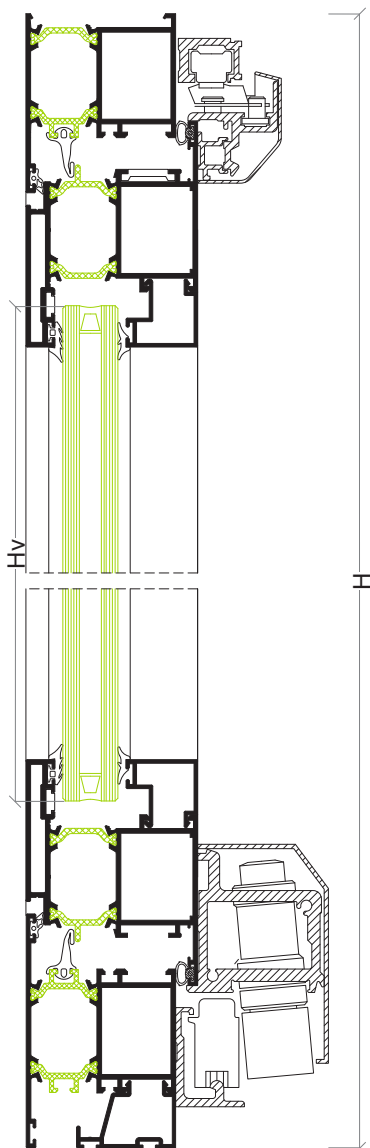
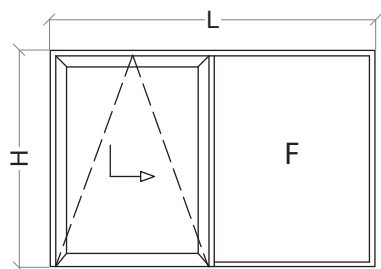

Perfis

Desenho	Ref	Descrição	Corte	Quant	Medida
	ATi-08	Aro fixo		1	L
				2	H
	ATi-65	Aro móvel		2	L1-56 mm
				2	H-98 mm
	ATi-06	Travessa		1	L-81 mm
				1	H-101mm
	AX-15	Bite remate		1	L-90 mm
	AX-19	Vareta		1+1	Apro. L+H
	---	Bite (folha)		2	L1-180 mm
				2	H-262 mm
	---	Bite (fixo)		2	L2-67.5 mm
				2	H-150 mm

Acessórios e Juntas

Referência	Descrição	Quantidade
30 92 01 00	Goteiras	4
30 92 01 50	União topos porta	2
30 92 03 90	Esquadro porta	6
30 96 00 15	Esquadro alinhamento móvel	4
---	Kit oscilo-paralela	1
30 96 00 28	Esquadro alinhamento	4
30 93 00 90	Junta exterior	2L1+2H
30 93 05 10	Junta central	2L1+2H
30 93 01 20	Junta interior	2L1+2H
---	Junta exterior vidro	2L+2H
---	Junta interior vidro	2L+2H

	Mínimo	Máximo
Largura da folha	700 mm	1650 mm
Altura da folha	850 mm	2400 mm
Peso máximo por folha 150 kg		

Vidro

Hv folha = H-236 mm	Lv folha = L1-193 mm
Hv fixo = H-124 mm	Lv fixo = L2-81 mm

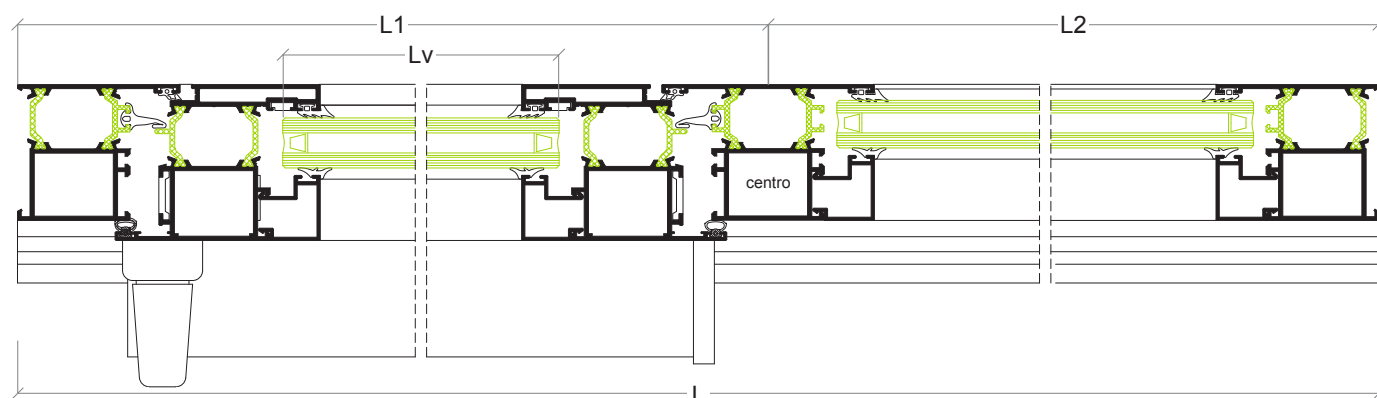

Porta 3 folhas harmónio

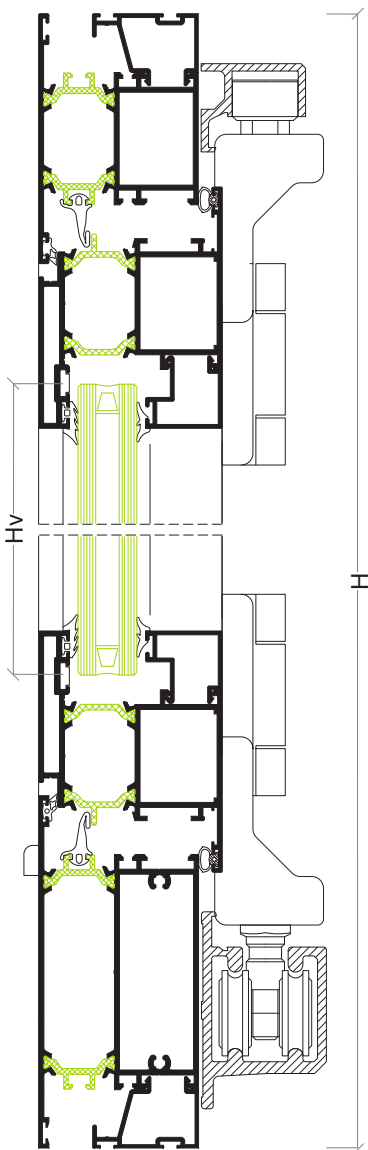
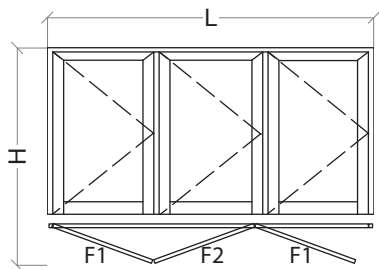

Perfis

Desenho	Ref	Descrição	Corte	Quant	Medida
	ATi-08	Aro fixo		2	H
	ATi-06	Travessa		1	L-81 mm
	AXi-12	Travessa		1	L-81
	ATi-65	Aro móvel		6	(consultar)
	ATi-65	Aro móvel		6	(consultar)
	ATi-04	Inversor		2	(consultar)
	AX-15	Bite remate		2	L-90 mm
	AX-19	Vareta		2	2H
	---	Bite		6	(consultar)
	---	Bite		6	(consultar)

Acessórios e Juntas

Referência	Descrição	Quantidade
30 92 01 50	União topo porta	2
30 92 01 00	Goteiras	6
30 93 50 21	Jogo topos inversor	2
30 92 03 90	Esquadro porta	12
---	Kit harmónio (3+0)	1
30 92 01 20	Jogo fecho C.E.	1
30 96 00 28	Esquadro alinhamento	12
30 96 00 15	Esquadro móvel exterior	12
30 93 00 90	Junta exterior	2L+6H
30 93 05 10	Junta central	2L+4H
30 93 01 20	Junta interior	2L+6H
---	Junta exterior vidro	2L+6H
---	Junta interior vidro	2L+6H

	Mínimo	Máximo
Largura da folha	600 mm	900 mm
Altura da folha	850 mm	2400 mm
Peso máximo por folha 80 kg		

Vidro

Hv = consultar	Lv F1 = consultar
	Lv F2 = consultar

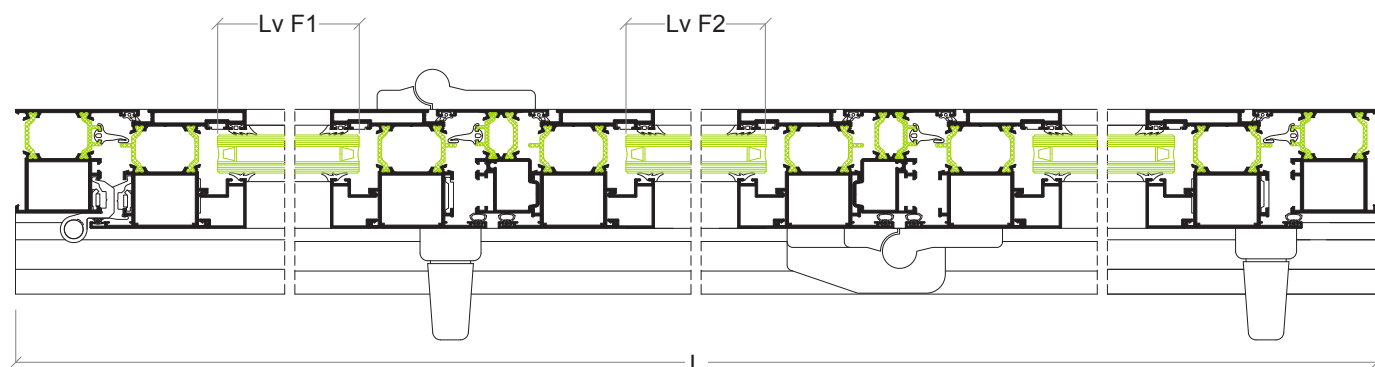

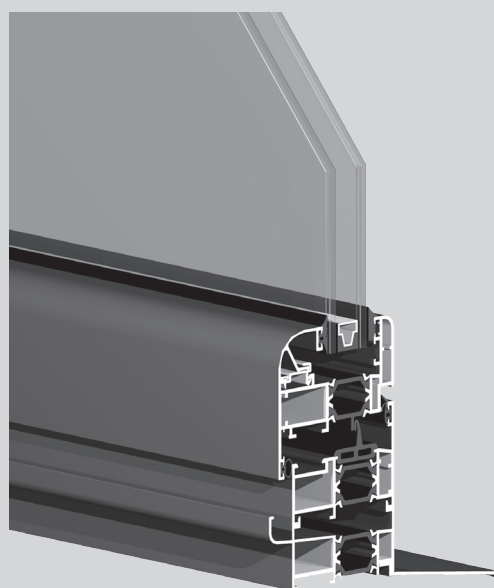
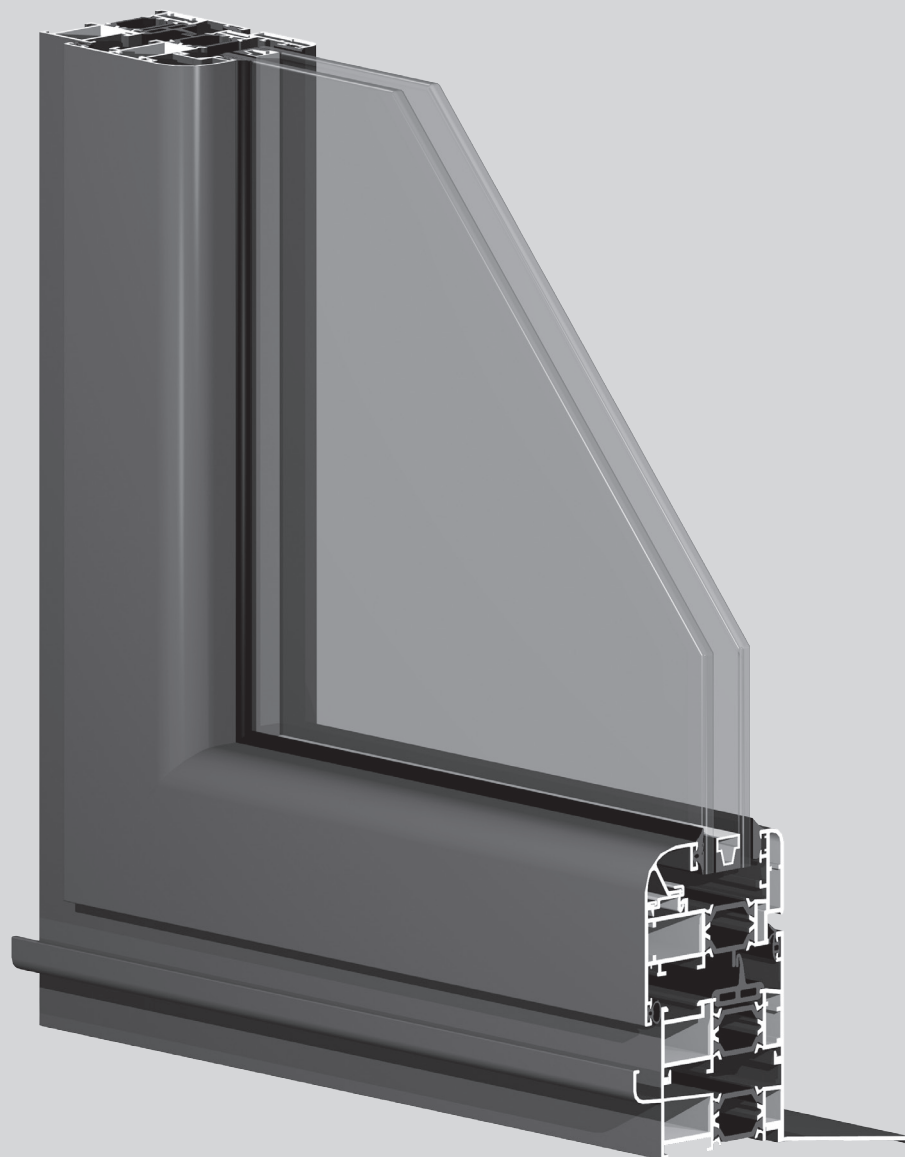

Sistema

ARi

Sistema ARi

Sistema de batente com RPT - 60 mm

Características do sistema

Sistema de batente com rotura térmica e de elevadas prestações térmicas e acústicas.

O sistema ARi possibilita a execução de 5 versões de caixilharia:

1. linha recta;
2. linha curva;
3. linha tradição;
4. linha oval;
5. Folha Oculta.

O sistema ARi permite a aplicação de vidros duplos ou triplos de alto rendimento de modo a responder às exigências de isolamento térmico e acústico.

A versão ARi Folha Oculta permite a ocultação do aro móvel.

Perfis de alumínio

Os perfis de alumínio são extrudidos na liga de alumínio 6060 para arquitectura de acordo com norma NP EN 12020-02.

Rotura térmica obtida por inserção de varetas isolantes de poliamida tipo ómega de 24 mm, reforçadas com 25% de fibra de vidro.

Espessura média dos perfis de alumínio de 1.5 mm para janelas e de 1.7 mm para portas.

Aros fixos

Secção dos aros fixos de 60 mm ou 84.5 mm com tripla câmara;

Aros fixos com esquadros duplos para montagem a meia esquadria;

Aros fixos tradicionais para mercado interno;

Aros fixos com clip exterior e aba de remate direta de 25 mm ou 45 mm;

Aros fixos com clip exterior e interior para aplicação de remate de 30 mm.

Aros móveis

Secção dos aros móveis de 68 mm com tripla câmara;

Enchimento para vidro duplo ou triplo de 10 mm a 45 mm para o sistema ARi;

Enchimento para vidro duplo até 23 mm para o sistema ARi Folha Oculta;

Aros móveis de linha recta, curva, tradição ou oval (sem bite);

Aros móveis com esquadros duplos para montagem a meia esquadria;

Perfil inversor de linha recta.

Dimensionamento e manobralidade

Dimensões mínimas - máximas de folha: 400 mm - 1500 mm (L); 400 mm - 2700 mm (H);

Possibilidades de abertura: fixo, batente interior 1 ou 2 folhas com oscilo-batente, exterior, basculante, projectante, pivotante, harmónio e oscilo-paralela;

Estanquidade assegurada através de juntas triplas em EPDM.

Performances

Sistema certificado por laboratório notificado para Ensaio Tipo Inicial (ITT) de acordo com a norma de produto EN 14351-1 para efeitos de Marcação CE.

Categorias alcançadas na avaliação do sistema ARi tipologia janela:

1. Permeabilidade ao ar: Classe 4 (norma de ensaio EN 1026)
2. Estanquidade à água: Classe E750 (norma de ensaio EN 1027)
3. Resistência ao vento: Classe C5 (norma de ensaio EN 12211)

Categorias alcançadas na avaliação do sistema ARi tipologia porta:

1. Permeabilidade ao ar: Classe 4 (norma de ensaio EN 1026)
2. Estanquidade à água: Classe 9A (norma de ensaio EN 1027)
3. Resistência ao vento: Classe C3 (norma de ensaio EN 12211)
4. Resistência à torção estática: Apto 350N (norma de ensaio EN 14609)

Categorias alcançadas na avaliação do sistema ARi-Folha Oculta tipologia janela:

1. Permeabilidade ao ar: Classe 3 (norma de ensaio EN 1026)
2. Estanquidade à água: Classe 7A (norma de ensaio EN 1027)
3. Resistência ao vento: Classe C5 (norma de ensaio EN 12211)

Coefficiente de transmissão térmica de vão de 2 folhas, sistema Ari, com 1.20 m x 1.50 m com vidro $U_g = 0.7 \text{ W/m}^2\text{K}$, com intercalar efeito "Warm Edge":

• $U_w = 1.54 \text{ W/m}^2\text{K}$

Coefficiente de transmissão térmica de vão de 2 folhas, sistema ARi Folha Oculta com 1.80 m x 2.20 m com vidro $U_g = 1.1 \text{ W/m}^2\text{K}$, com intercalar efeito "Warm Edge":

• $U_w = 1.70 \text{ W/m}^2\text{K}$

Coefficiente de atenuação acústica de vão de 2 folhas com vidro 4/16 (gás Argon)/6:

• $R_w (C; C_{tr}) = 34 \text{ dB} (-1; -4)$

Zonas de aplicação segundo RCCTE (em função do valor U_g): I1, I2, I3, V1, V2, V3.

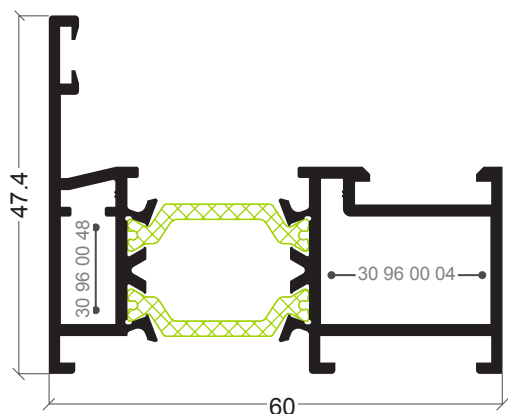

ARi-03
Aro fixo

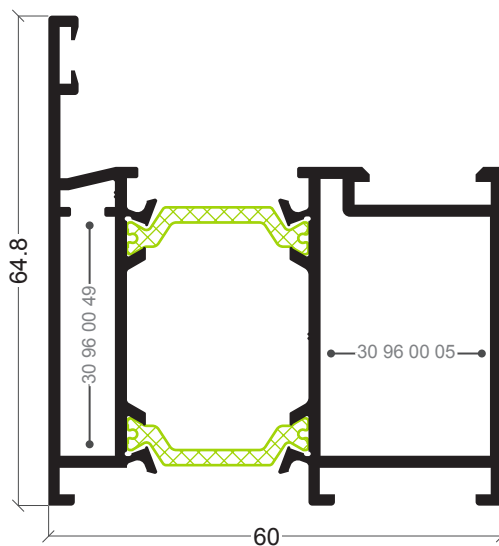

ARi-08
Aro fixo

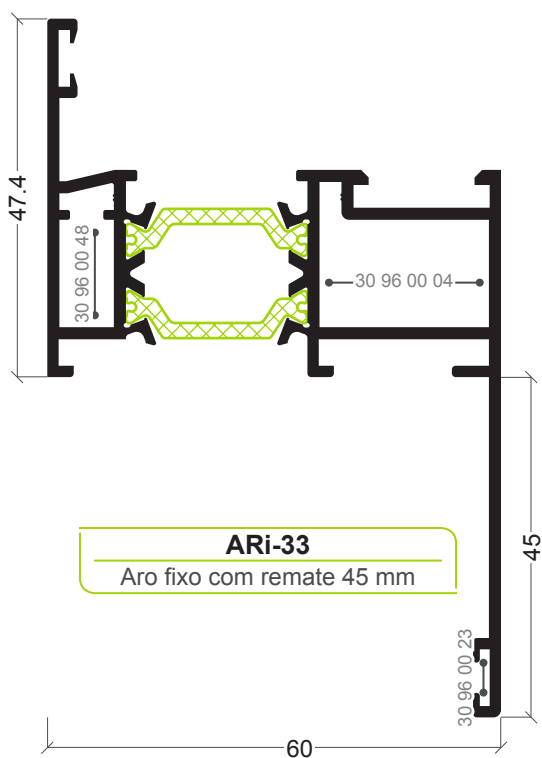

ARi-33
Aro fixo com remate 45 mm

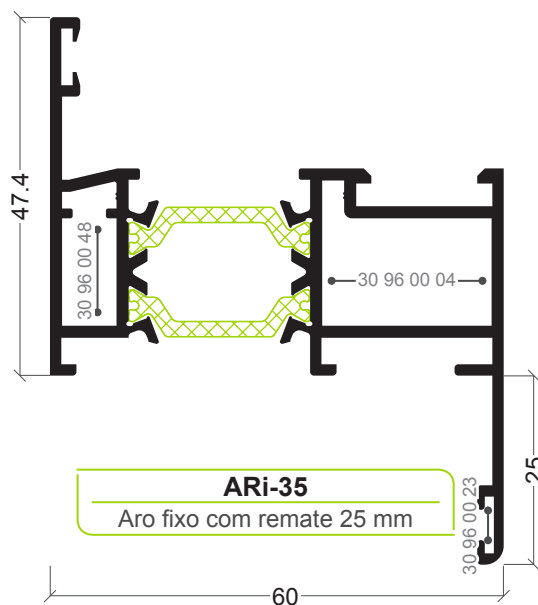

ARi-35
Aro fixo com remate 25 mm

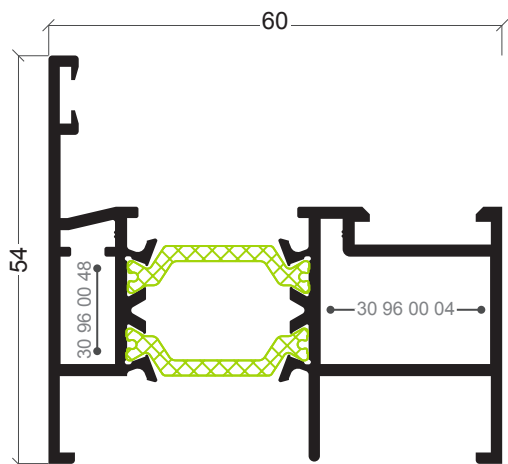

ARi-81
Aro fixo

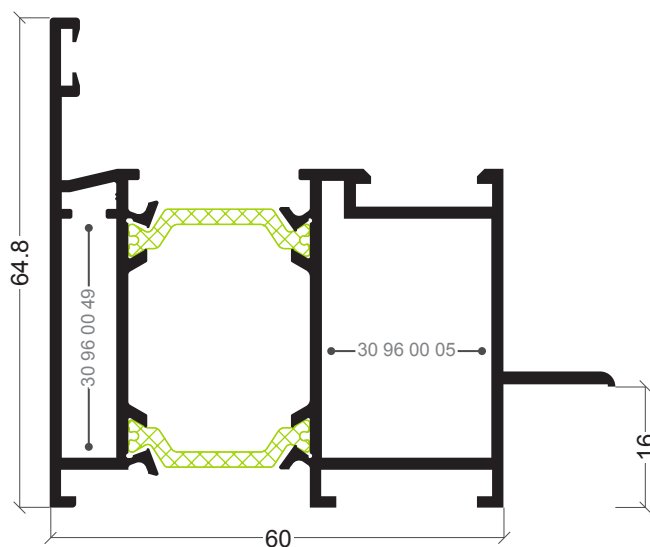

ARi-68
Aro fixo para apainelado

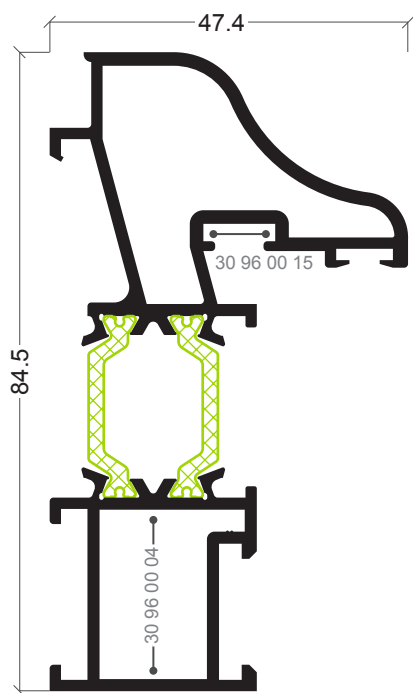

ARi-57
Aro fixo tradição

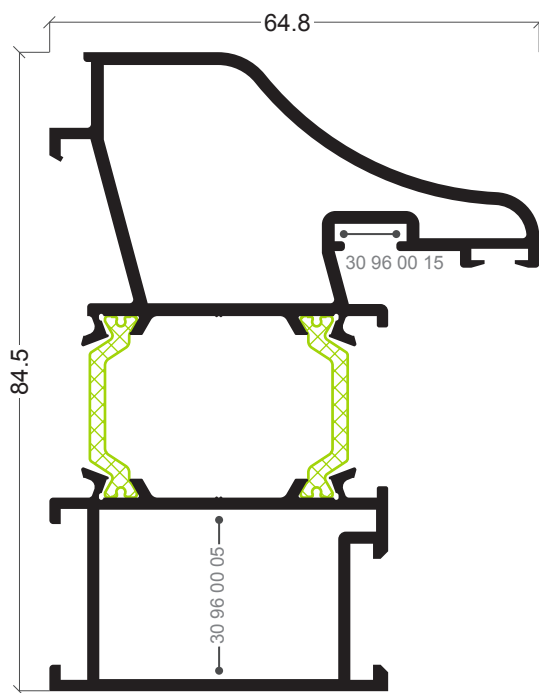

ARi-59
Aro fixo tradição

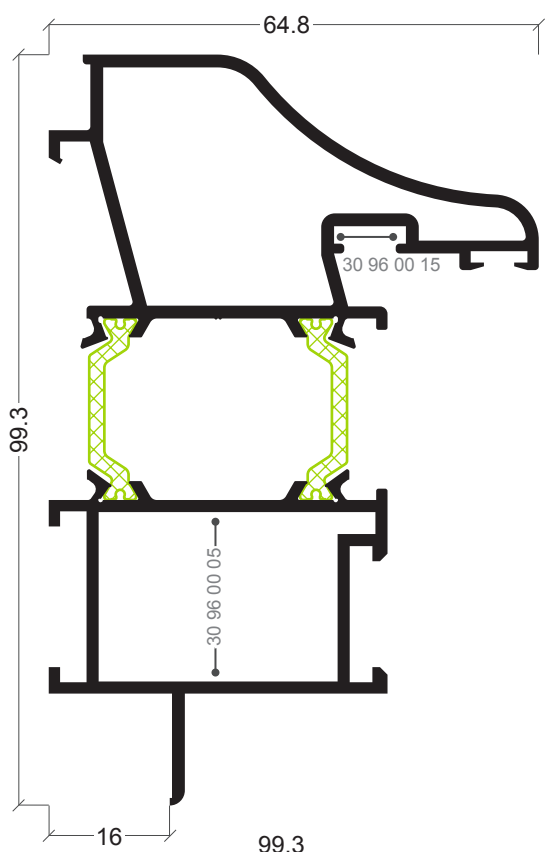

ARi-69
Aro fixo para apainelado

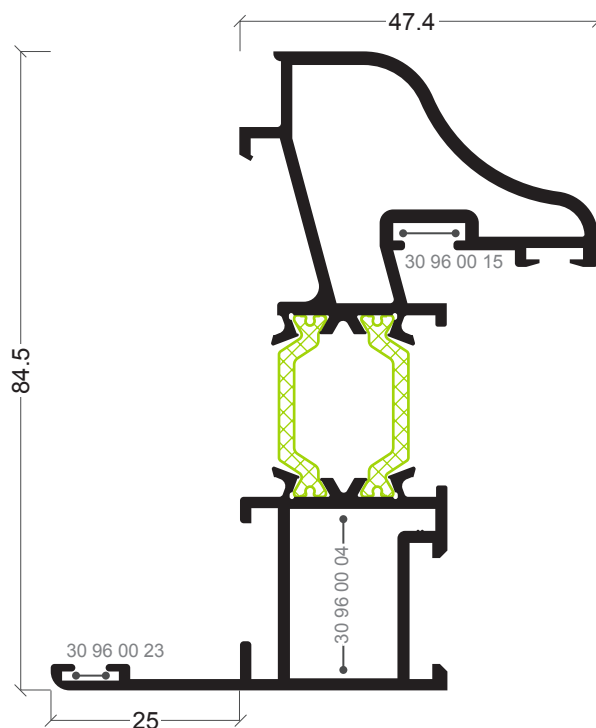

ARi-77
Aro fixo com remate

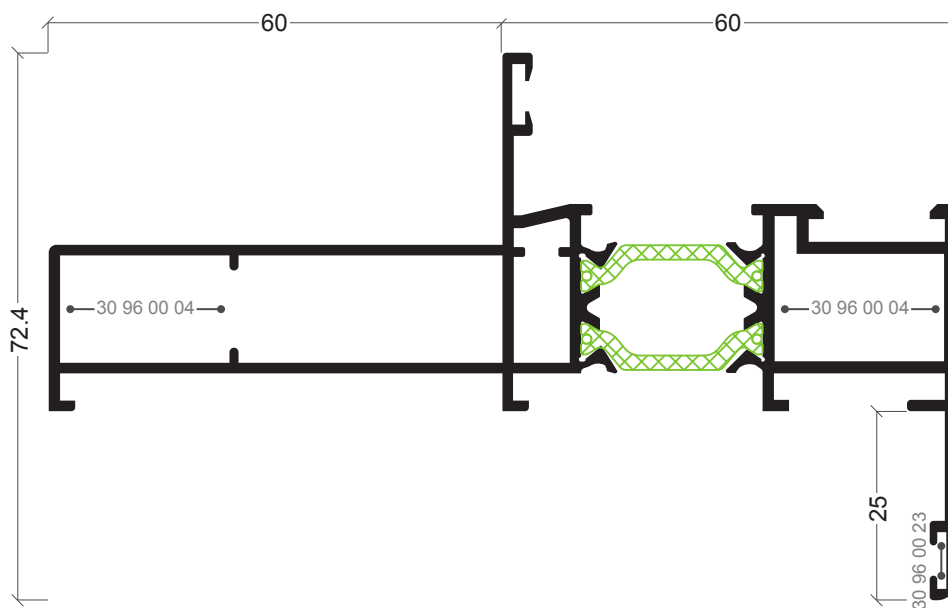

ARi-86
Aro fixo com remate

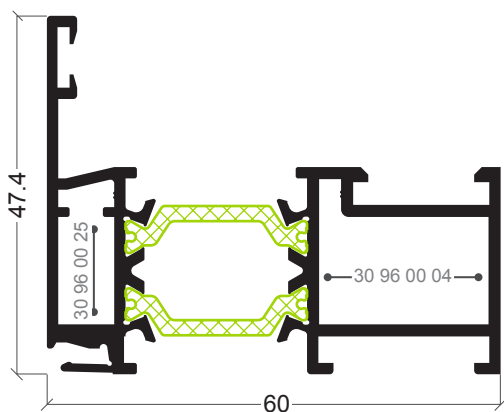

ARi-76
Aro fixo

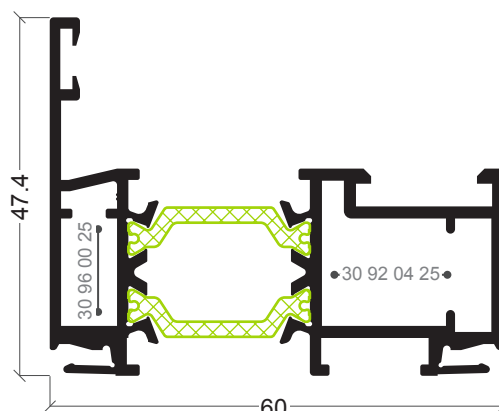

ARi-80
Aro fixo com clip interior/exterior

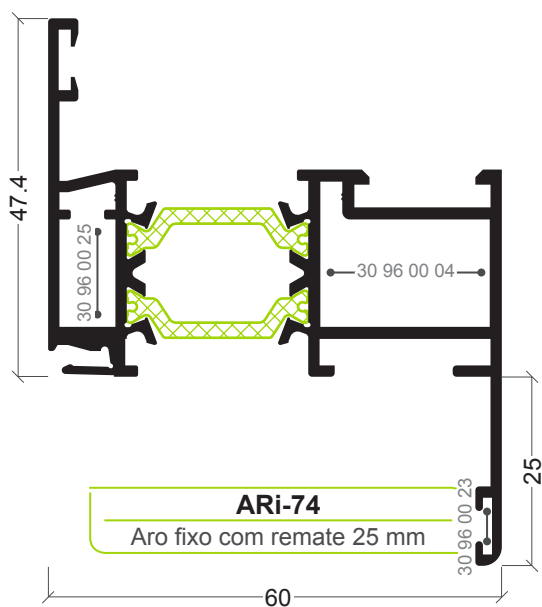

ARi-74
Aro fixo com remate 25 mm

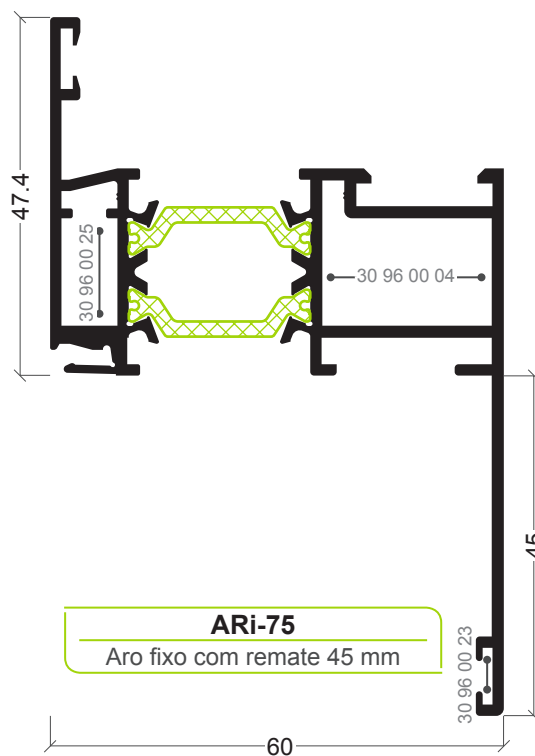

ARi-75
Aro fixo com remate 45 mm

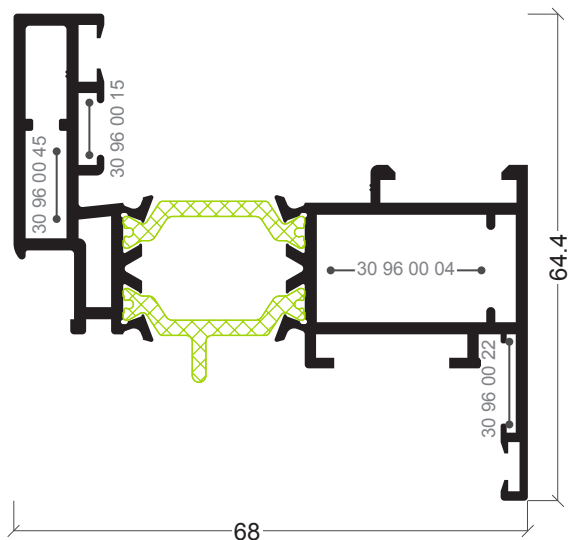

ARi-61
Aro móvel

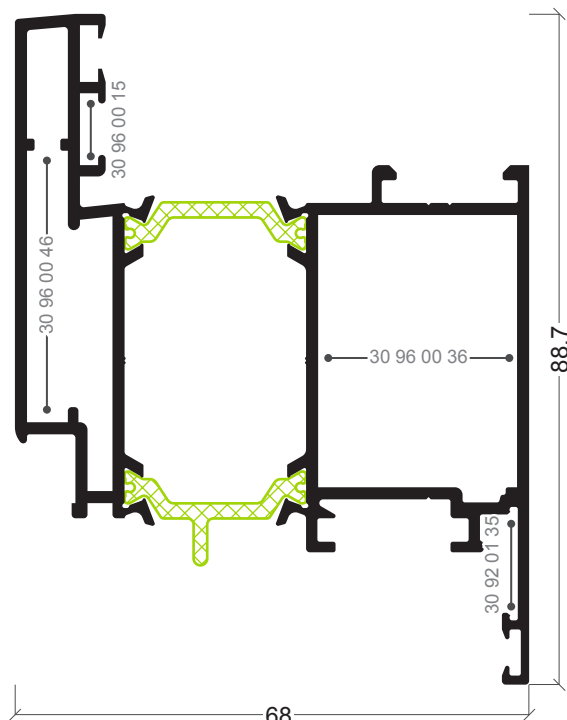

ARi-36
Aro móvel

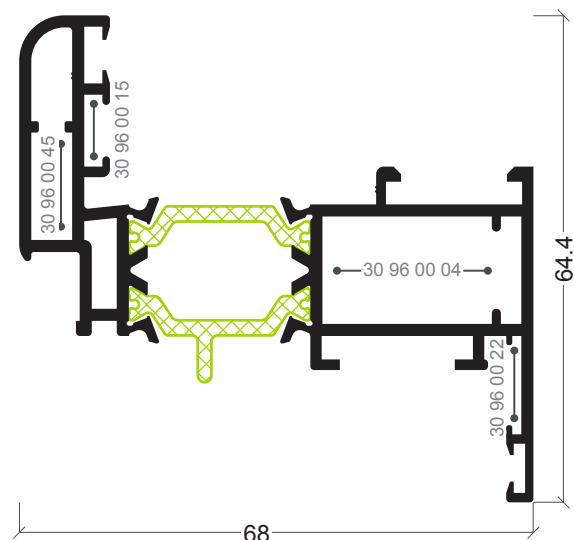

ARi-05
Aro móvel

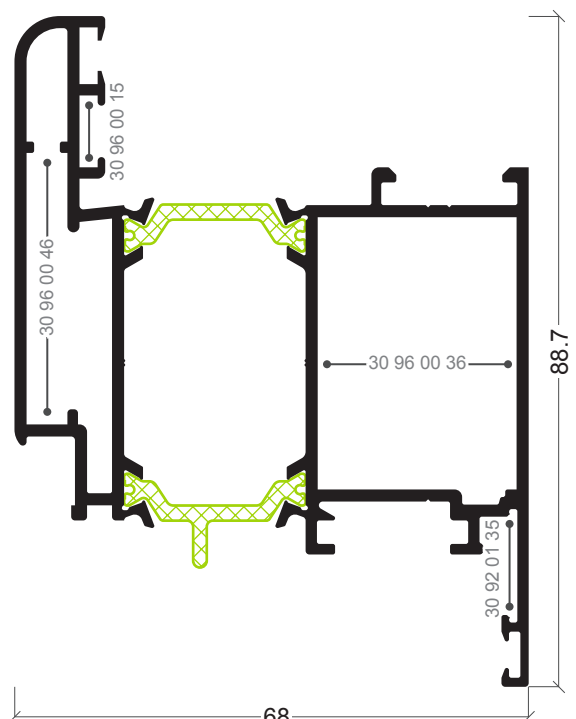

ARi-10
Aro móvel

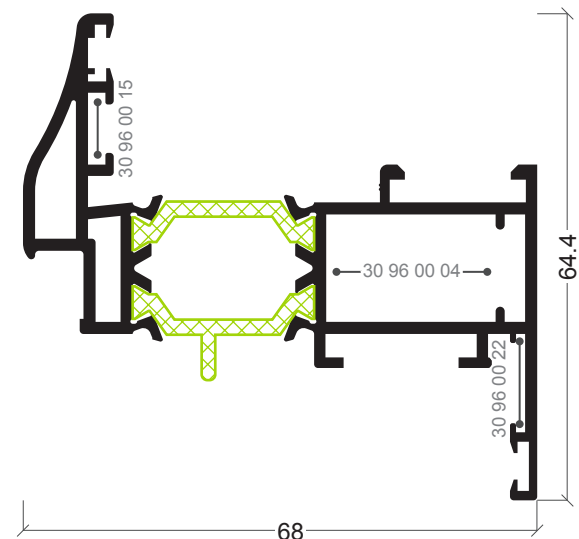

ARi-58
Aro móvel tradição

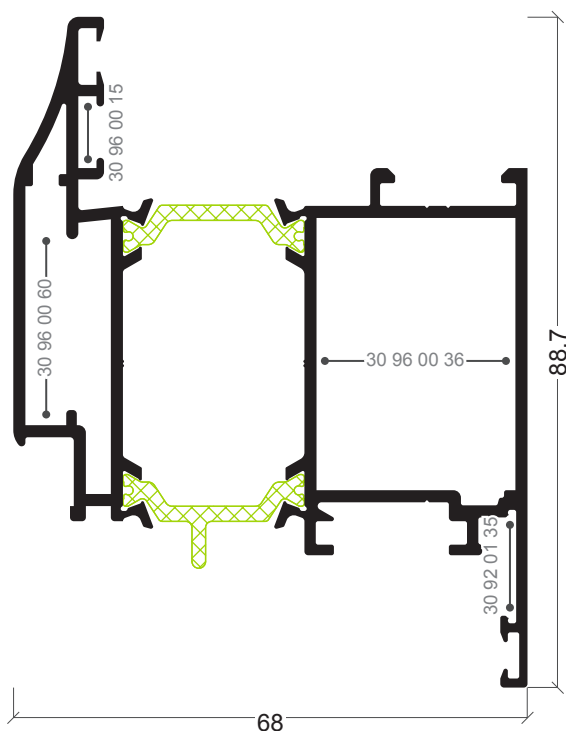

ARi-60
Aro móvel tradição

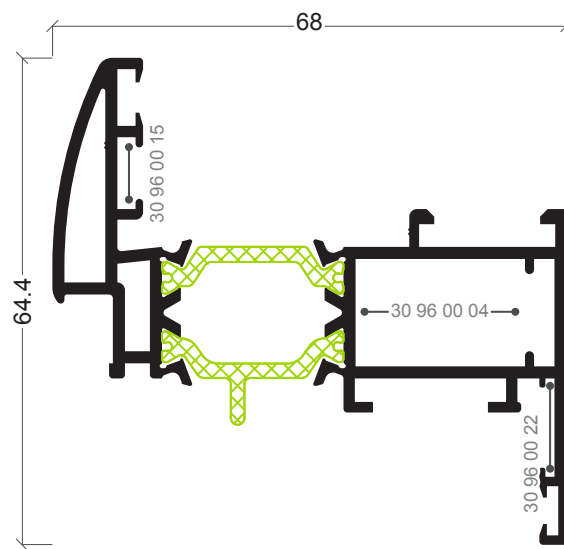

ARi-83
Aro móvel

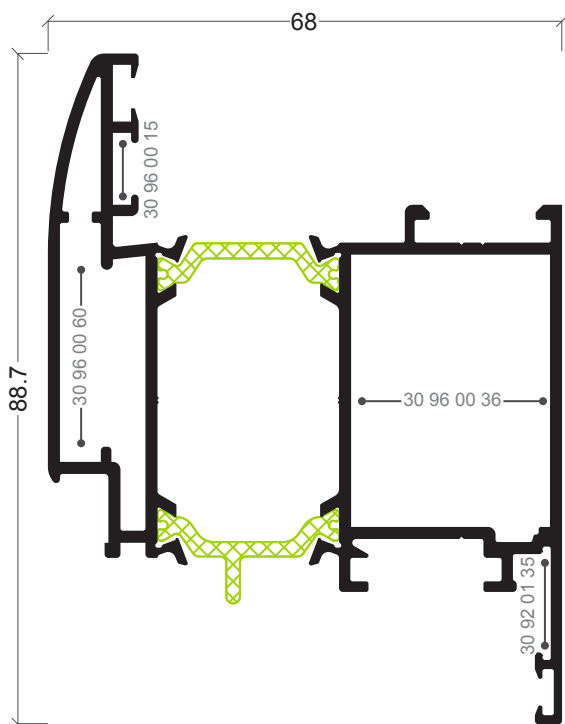

ARi-84
Aro móvel

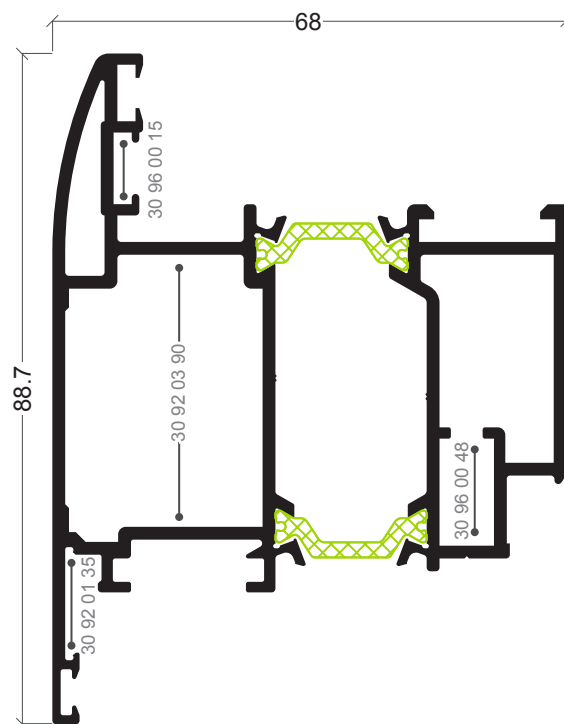

ARi-85
Aro móvel

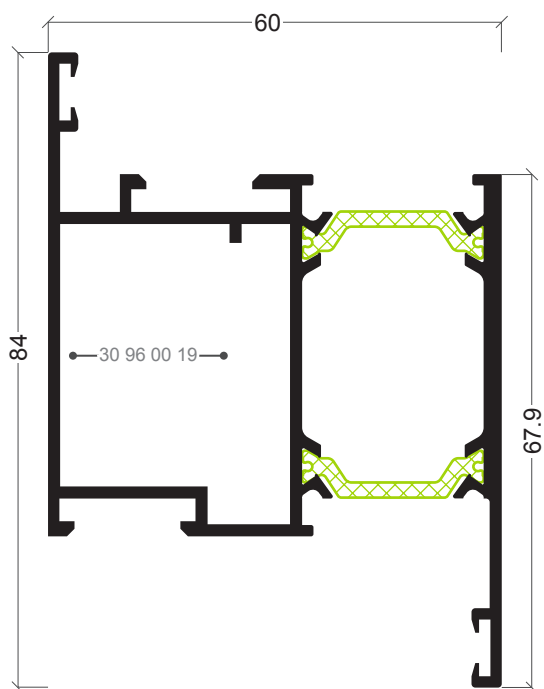

ARi-11
Aro fixo abertura exterior com fixo lateral

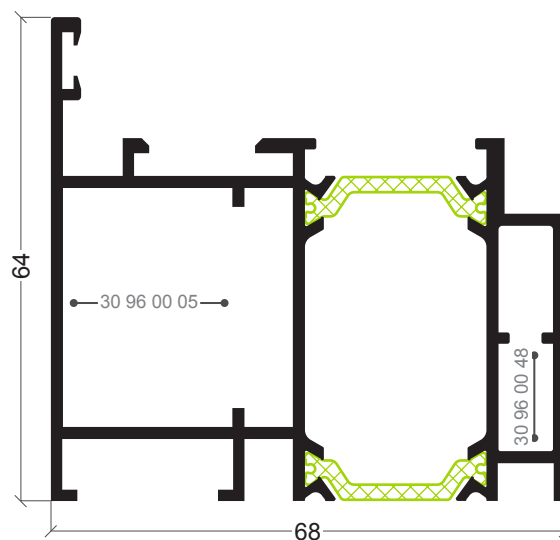

ARi-09
Aro fixo abertura exterior ARi-25

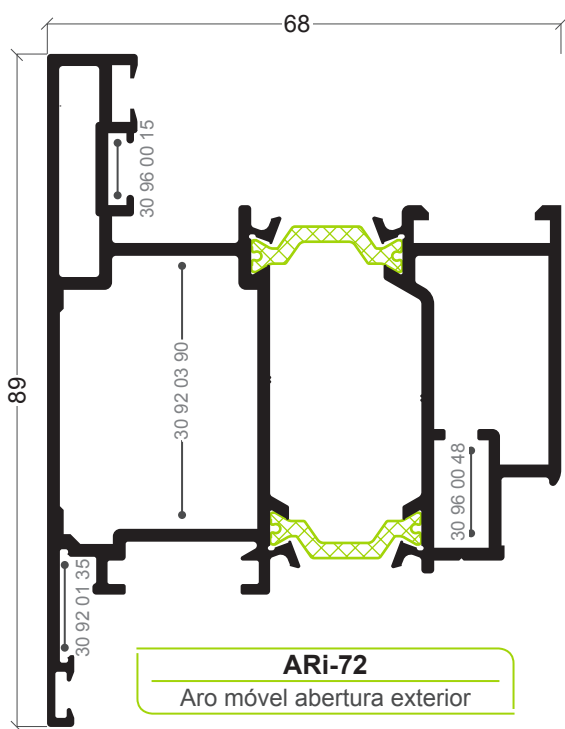

ARi-72
Aro móvel abertura exterior

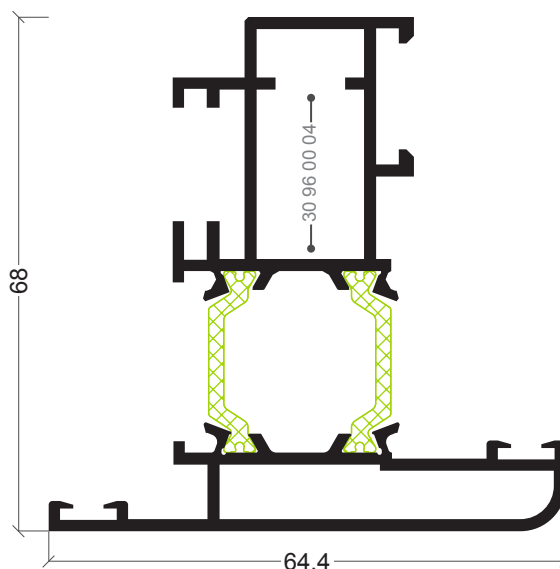

ARi-02
Aro móvel pivotante

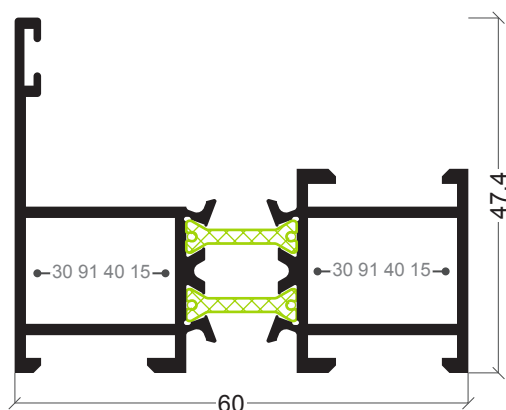

ARi-38
Aro fixo projectante

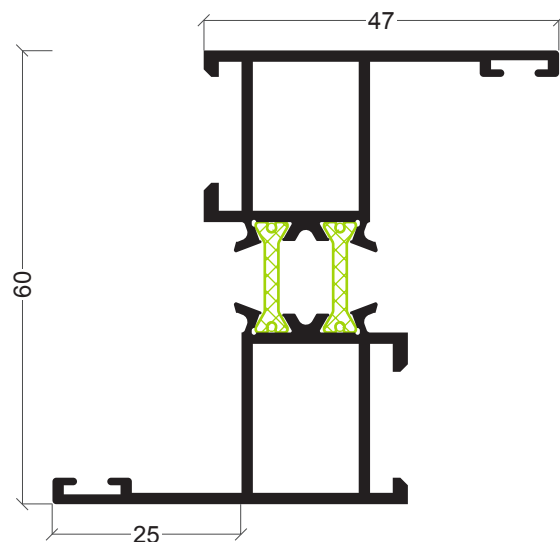

ARi-39
Aro fixo projectante com fixo

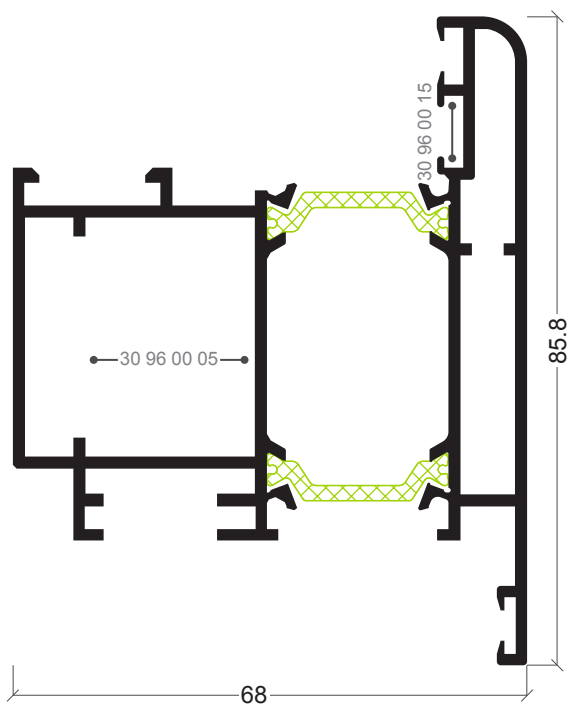

ARi-25
Aro móvel abertura exterior ou pivotante

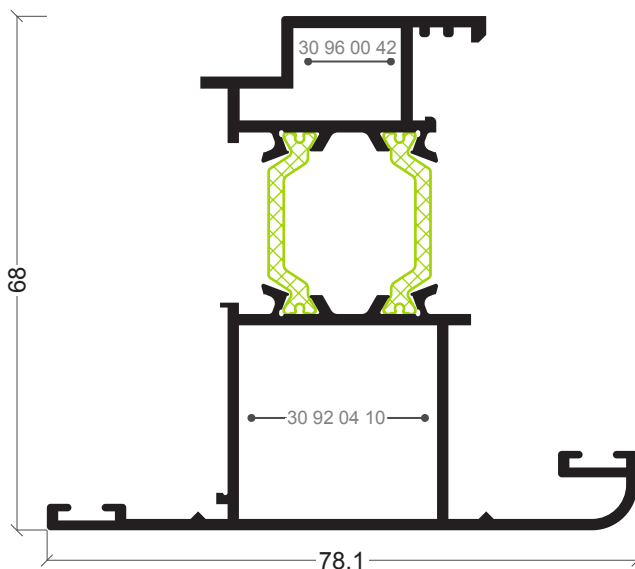

ARi-07
Aro móvel projectante

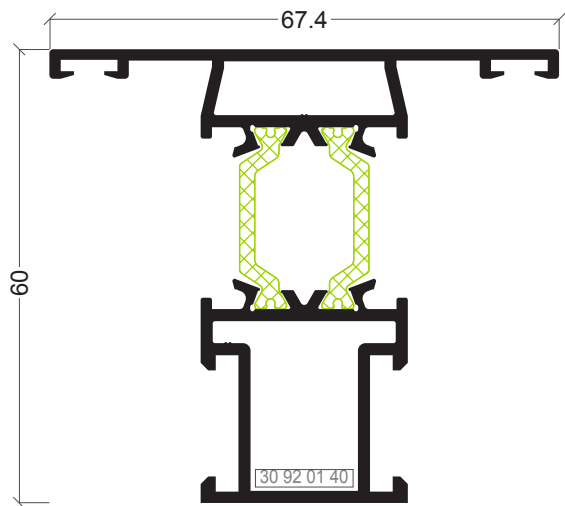

ARi-01
Travessa

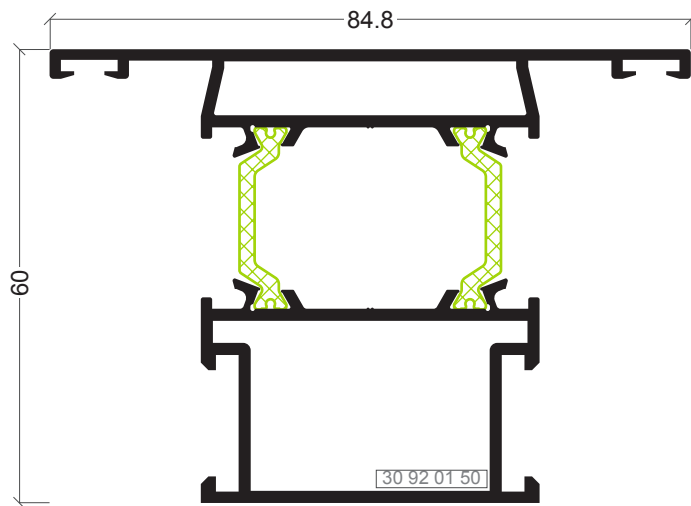

ARi-06
Travessa

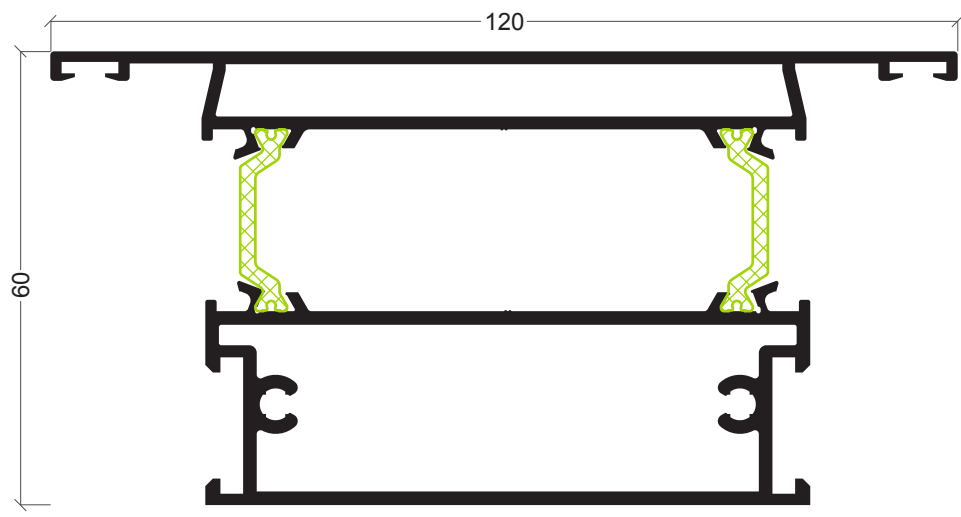

ARi-12
Travessa

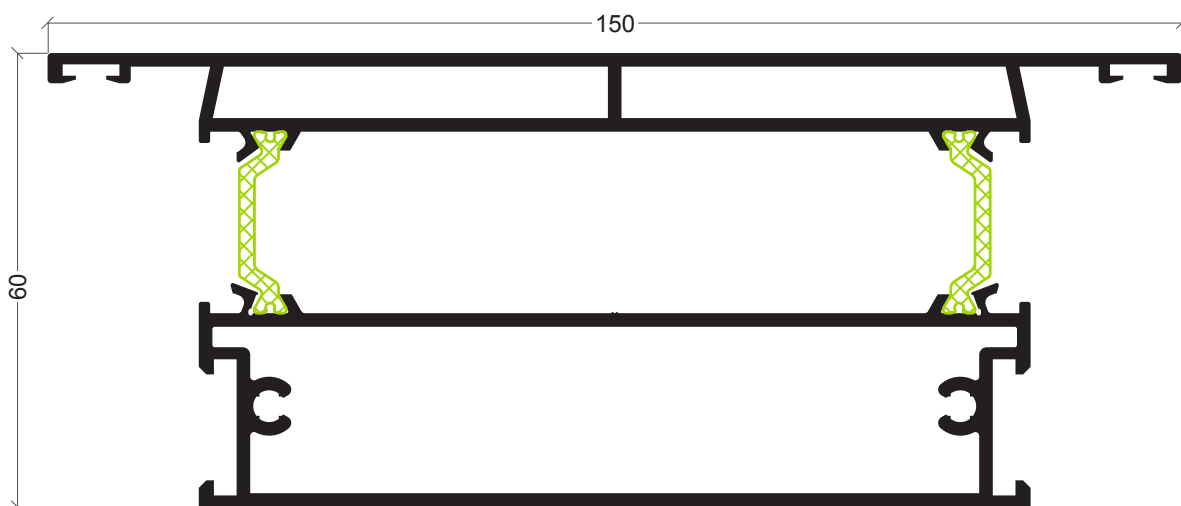

ARi-13
Travessa

68

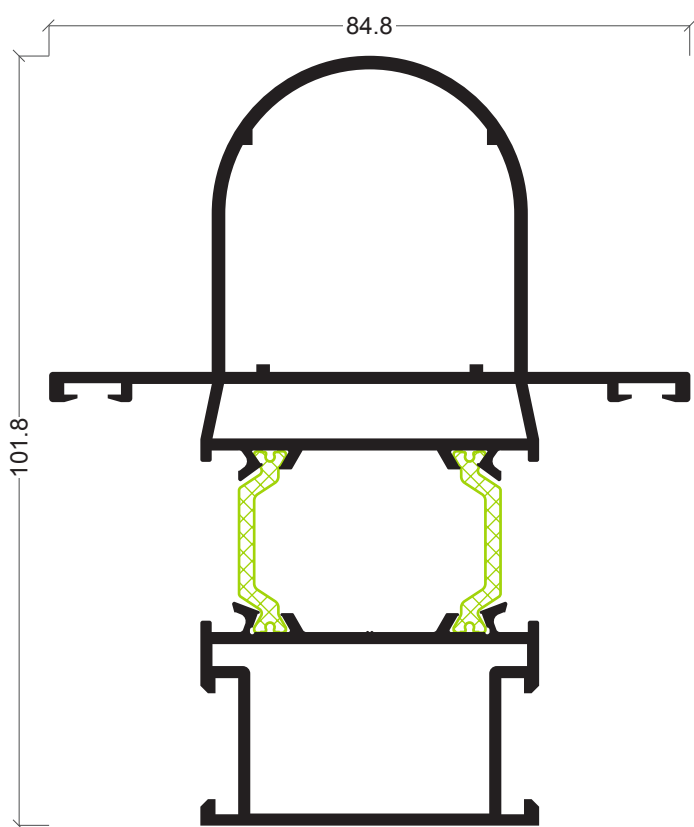

ARi-17
Montante curvo

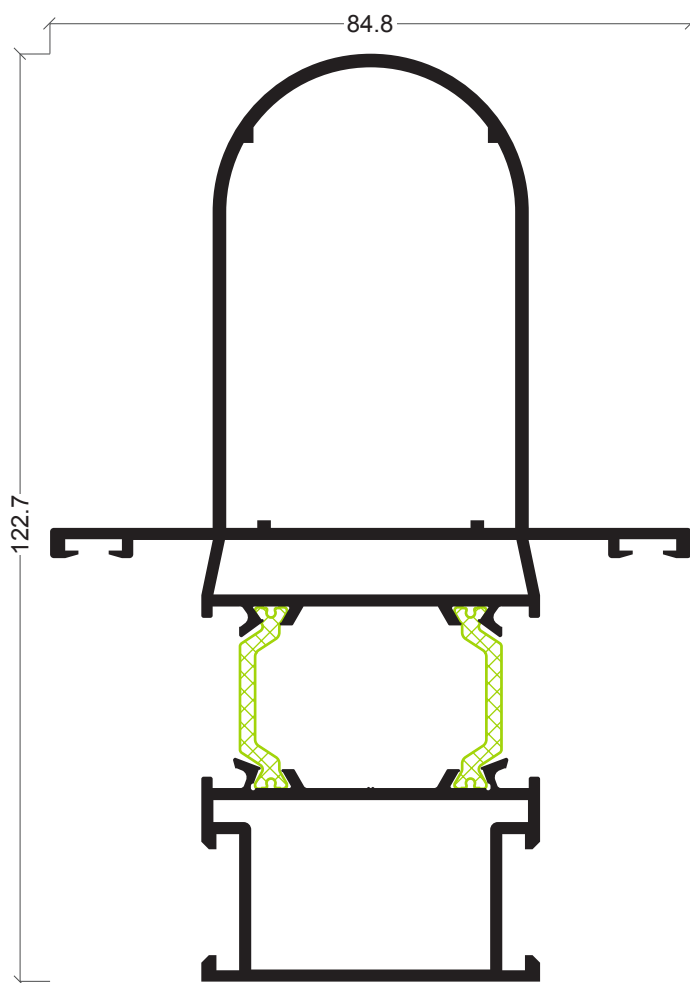

ARi-18
Montante curvo

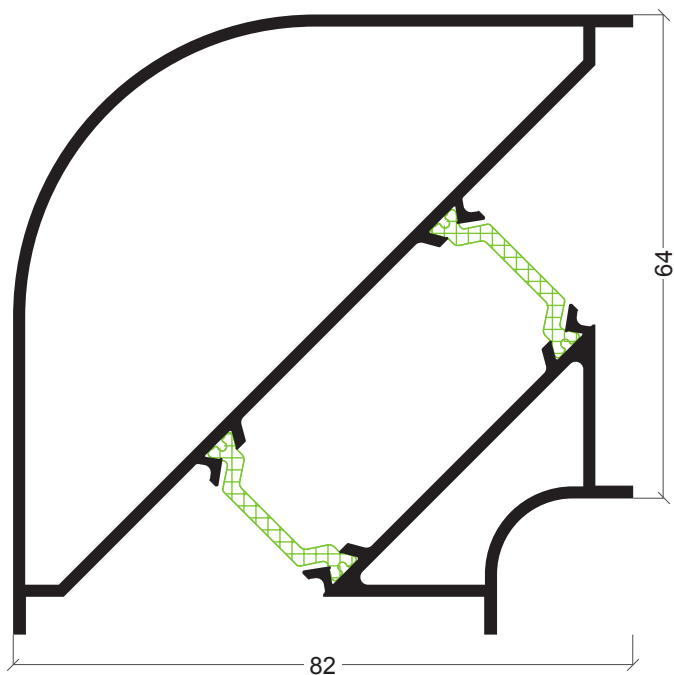

ARi-16
Esquina 90°

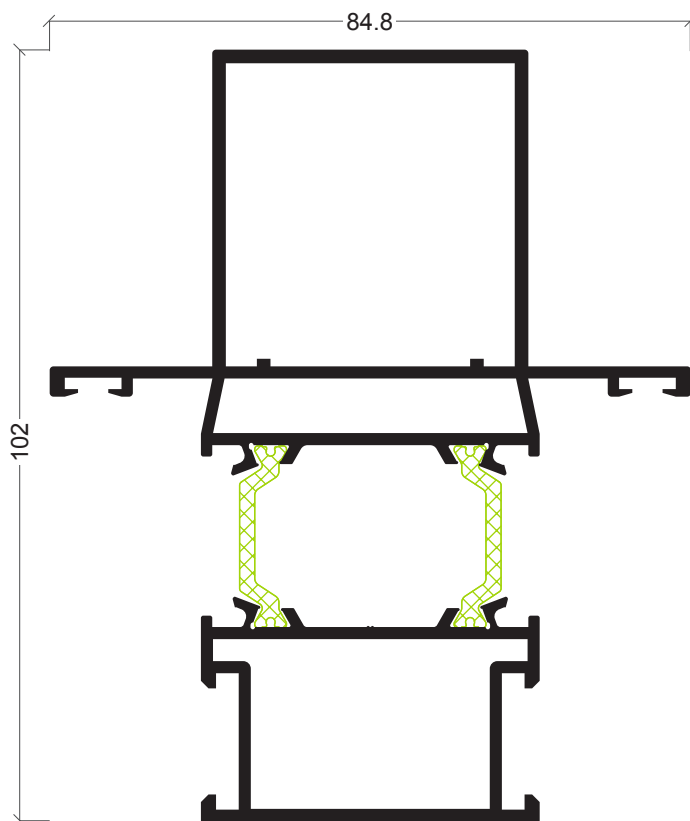

ARi-79
Montante recto

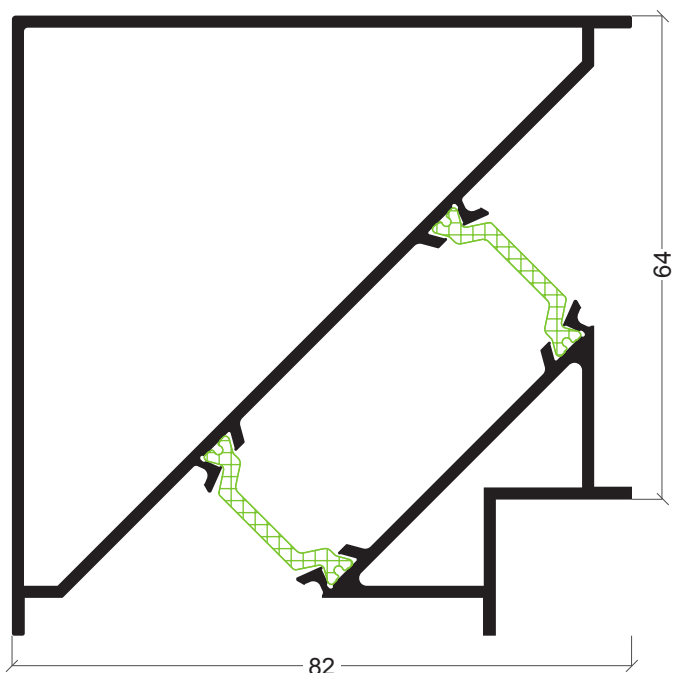

ARi-64
Esquina 90°

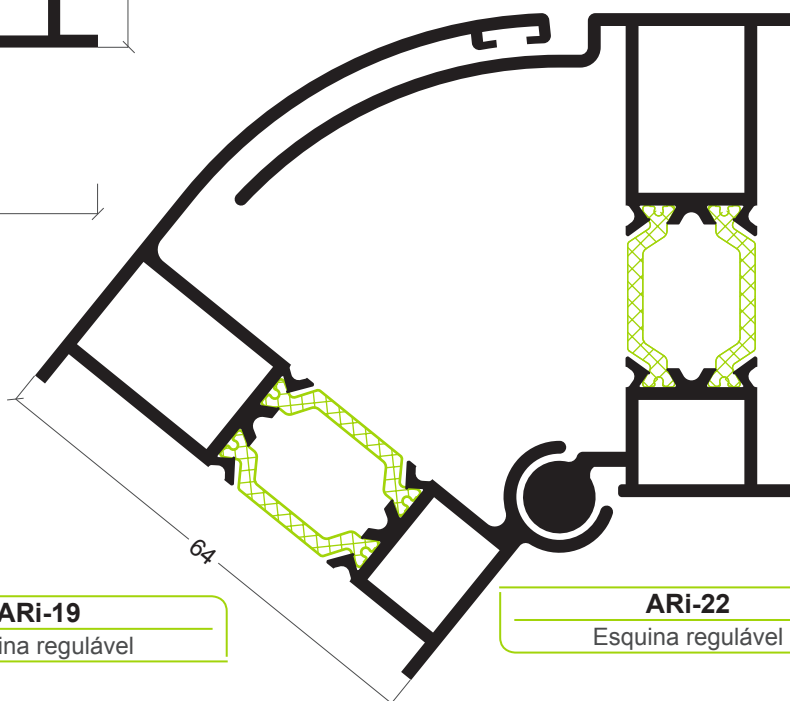

ARi-19
Esquina regulável

ARi-22
Esquina regulável

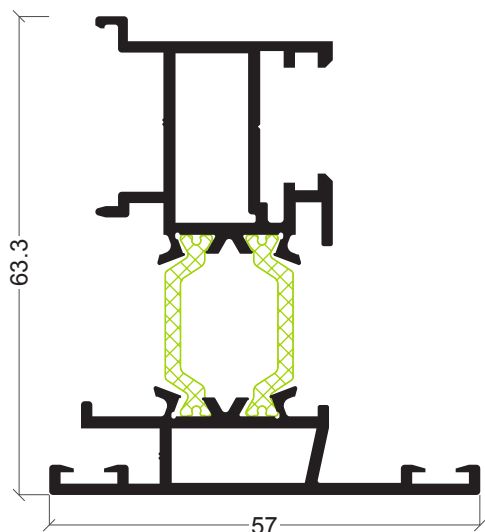

ARi-04
Inversor

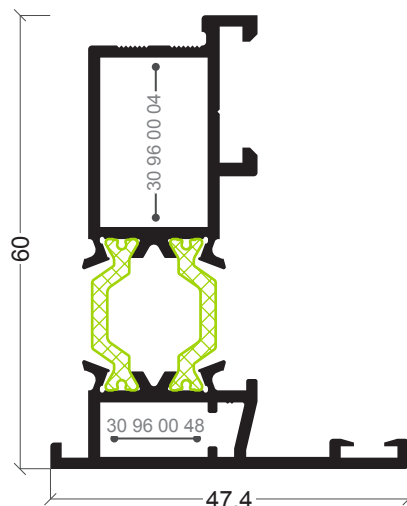

ARi-73
Inversor de sentido de abertura

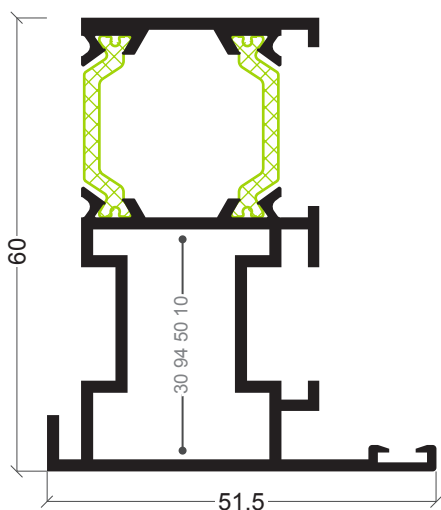

ARi-14
Inversor pivotante

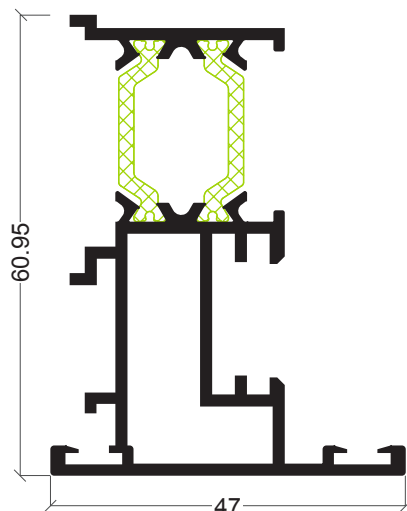

ARi-15
Inversor para ARi-25

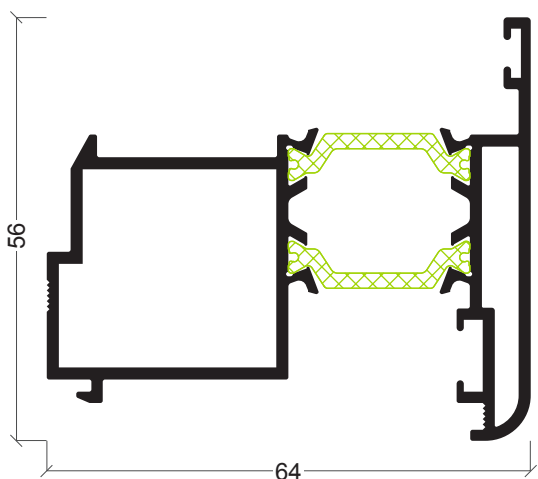

ARi-51
Inversor projectante

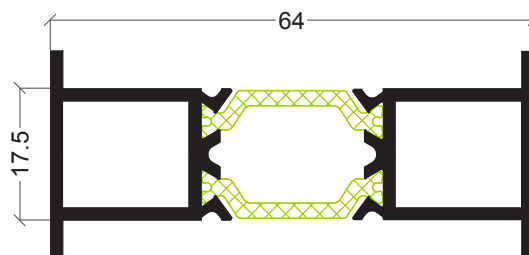

ARi-21
União de aros

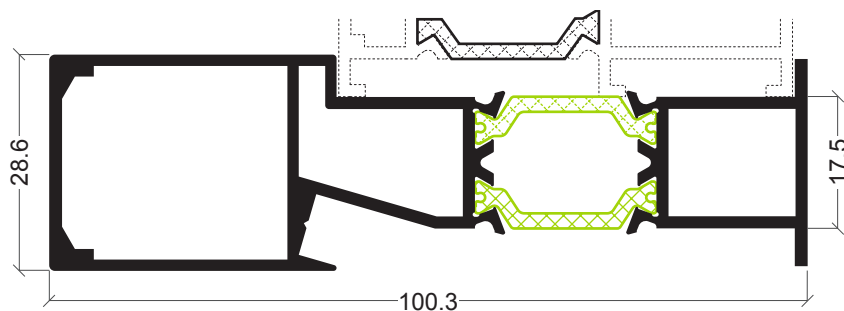

ARi-65
União de aros com reforço

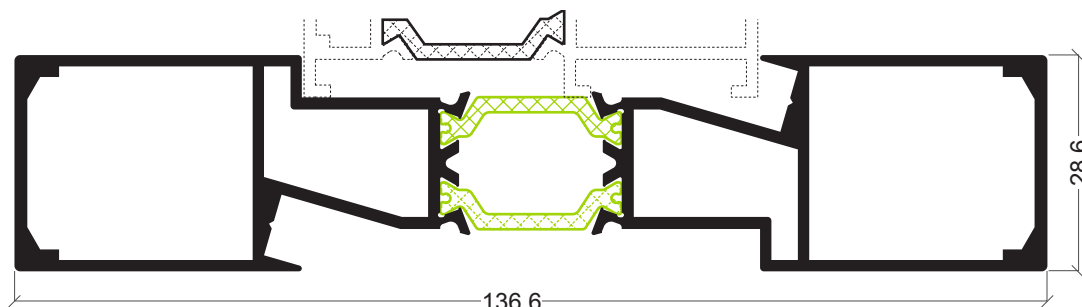

ARi-67
União de aros com reforço

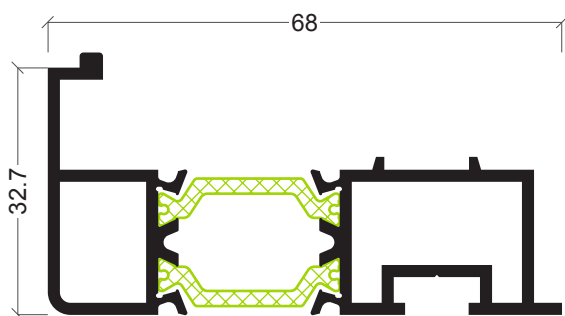

ARi-23
Remate almofada

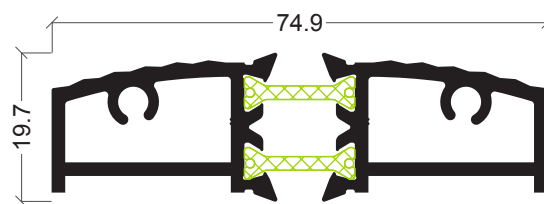

AXi-69
Remate inferior porta

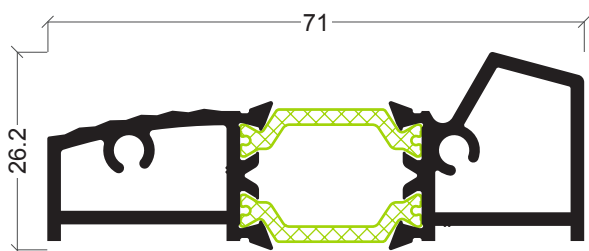

ARi-63
Remate inferior porta

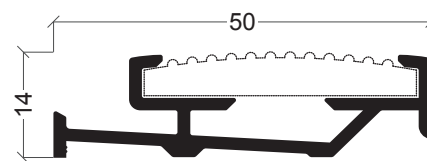

AZ-69
Remate inferior porta

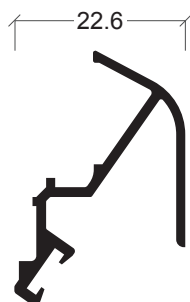

ARi-62
Pingadeira inferior porta

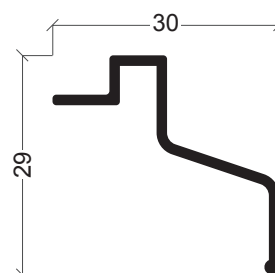

AXi-45
Pingadeira

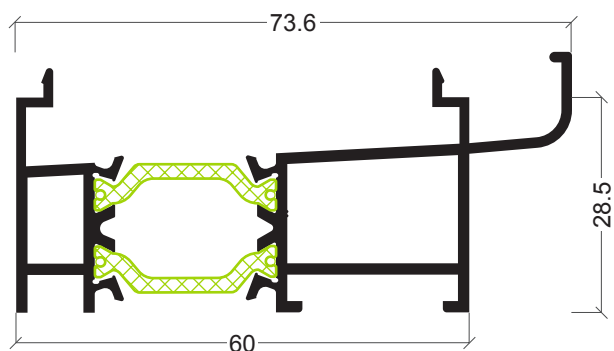

CT-11
Soleira condensação

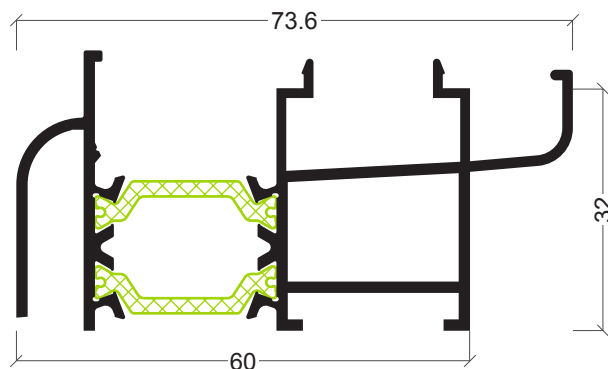

ARi-49
Soleira condensação

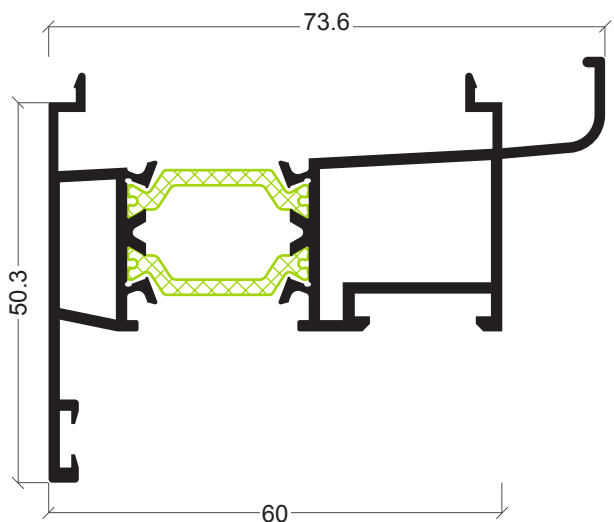

ARi-20
Soleira condensação com fixo inferior

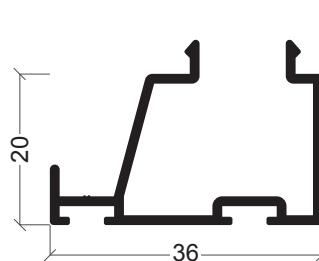

AX-15
Bite remate

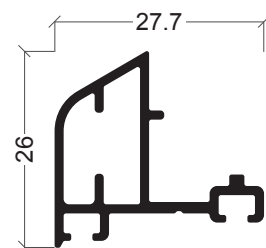

AZ-79
Pingadeira

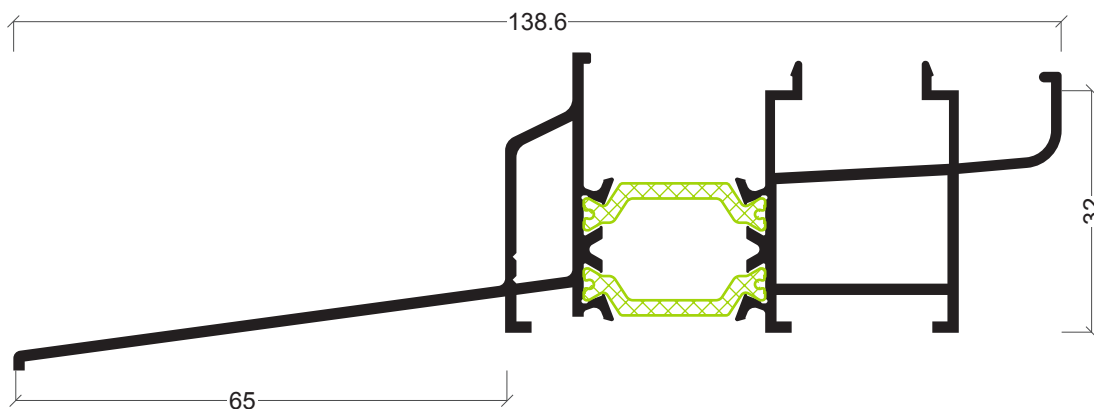

ARi-50
Soleira condensação com pingadeira

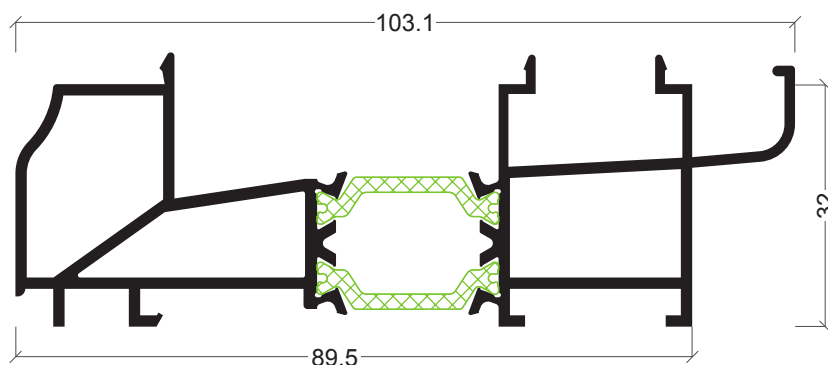

ARi-56
Soleira condensação tradição



AXi-91
Complemento remate

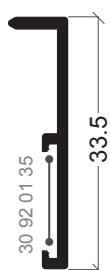

AXi-88
Complemento remate

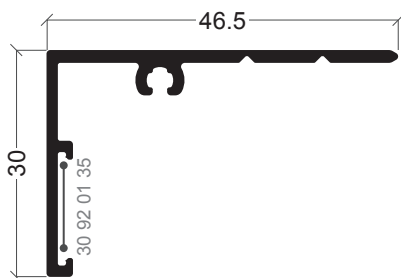

AXi-80
Remate

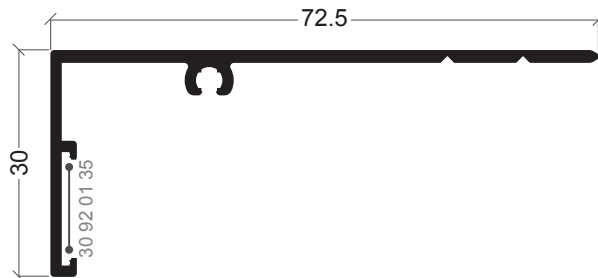

AXi-83
Remate

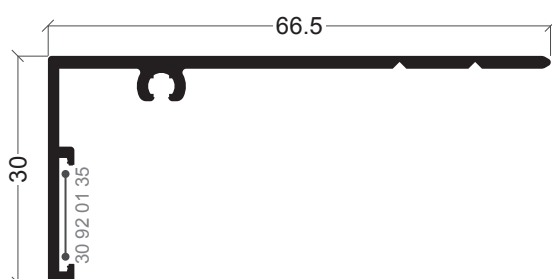

AXi-73
Remate

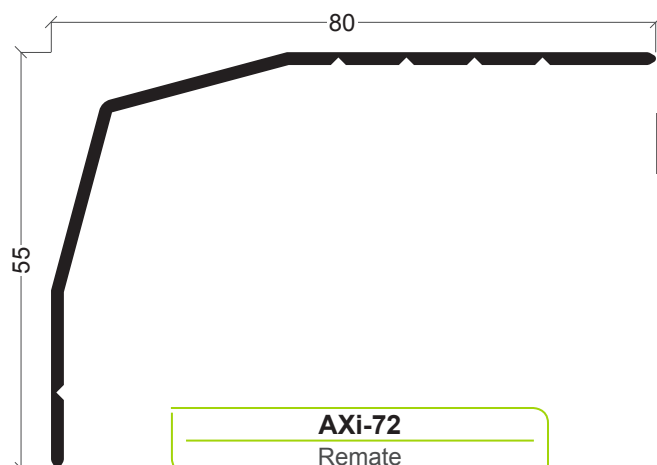

AXi-72
Remate

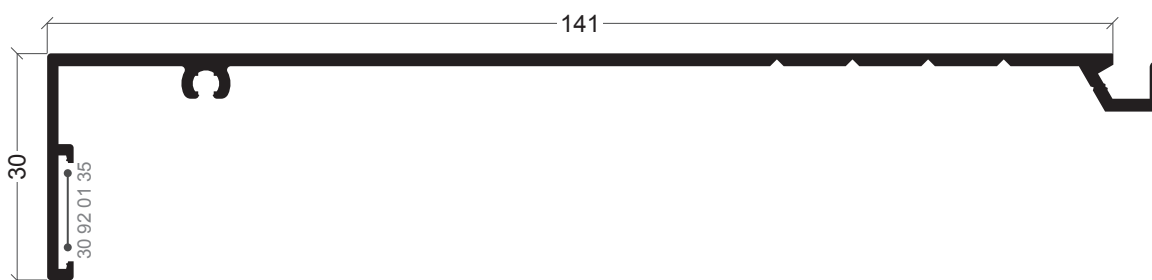

S-09
Remate

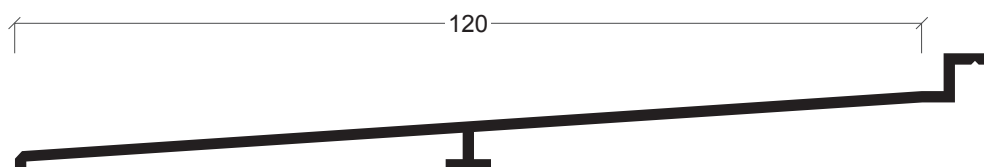

AZ-24
Pingadeira 120 mm

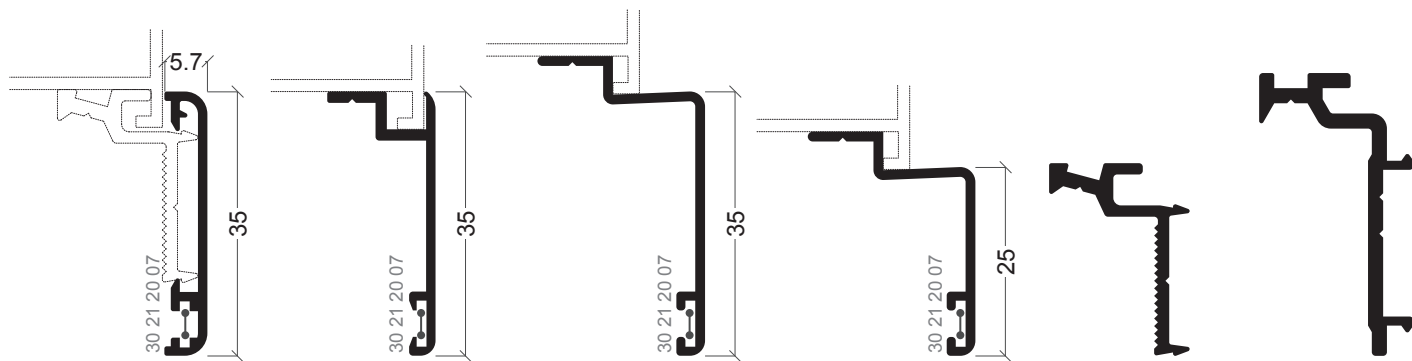

ARi-30
Tapa juntas

ARi-31
Tapa juntas

ARi-37
Tapa juntas

ARi-66
Tapa juntas

ARi-24
Mola tapa juntas

ARi-26
Mola tapa juntas

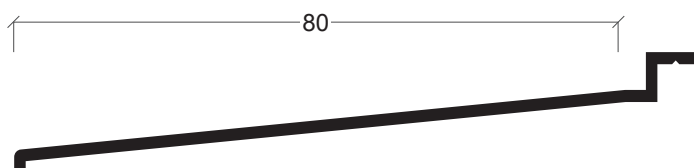

AZ-30
Pingadeira 80 mm

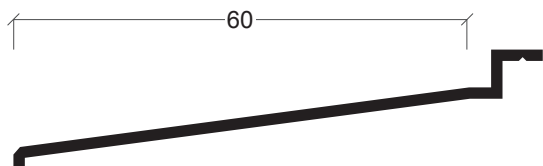

AZ-23
Pingadeira 60 mm

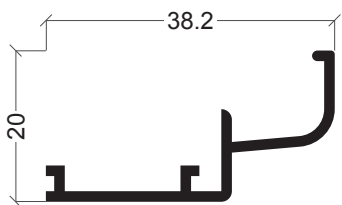

ARi-32
Complemento condensação



AXi-32
Complemento abertura projectante

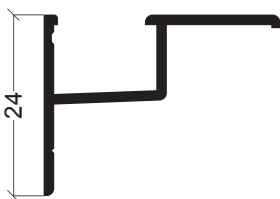

Y-20
Recolha de águas condensação

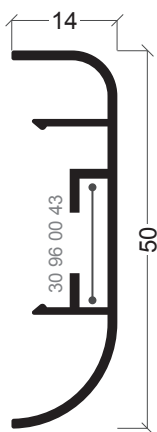

ARi-27
Tapa juntas

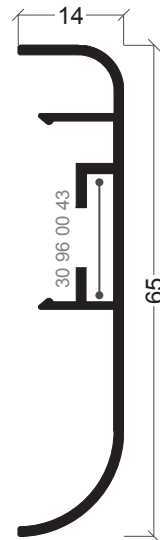

ARi-34
Tapa juntas



ARi-28
Tapa juntas



AX-19
Vareta



AX-33
Mola Bite

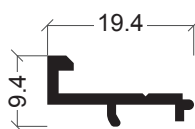

ARi-29
Apoio bite ARi-07

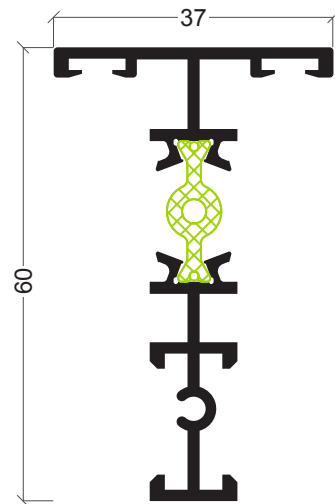

ARi-40
Divisor de vidro

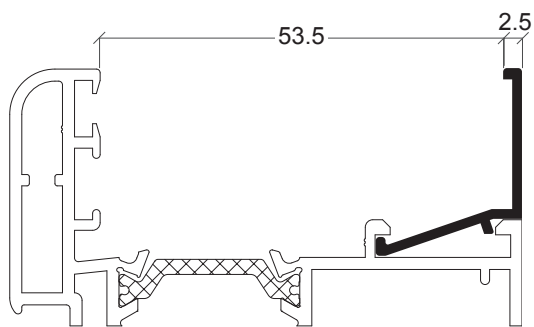

AX-69

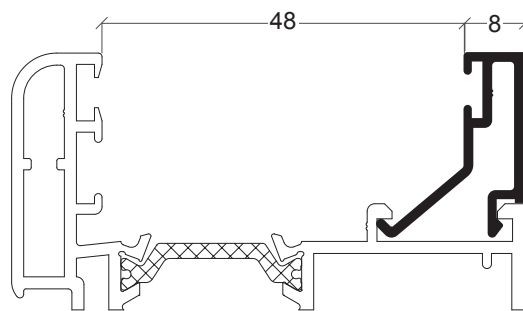

AX-74

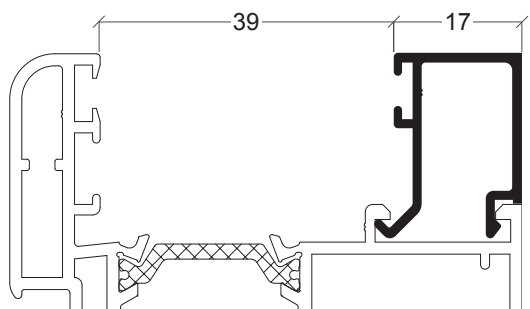

AX-46

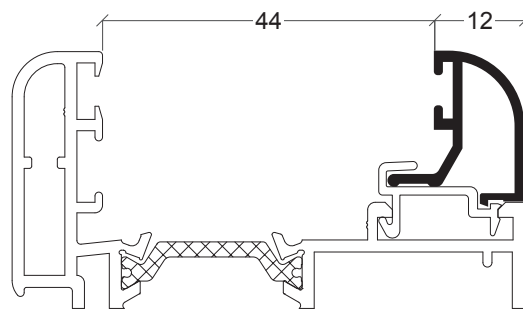

AX-37

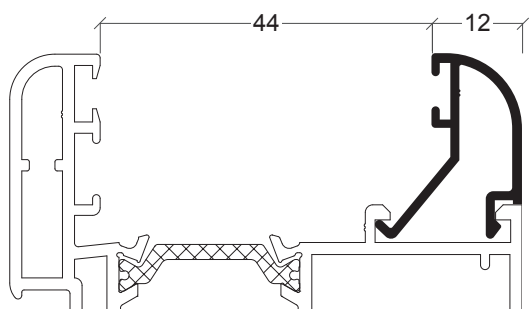

AZ-08

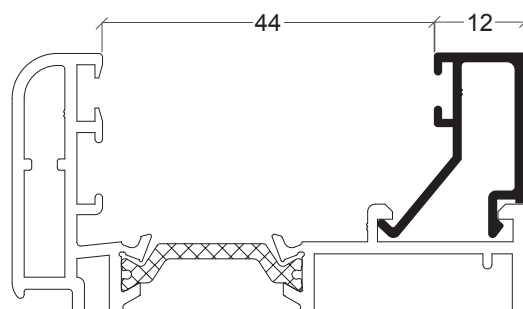

AX-36

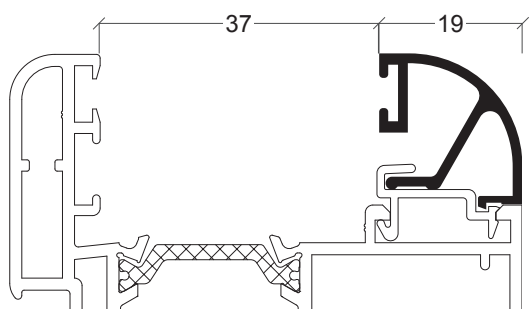

AX-30

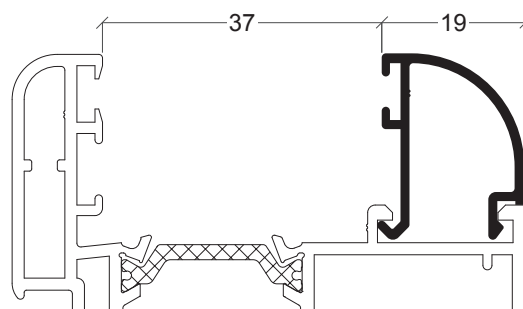

AZ-07

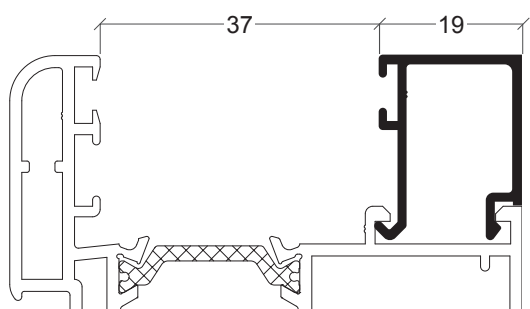

AX-35

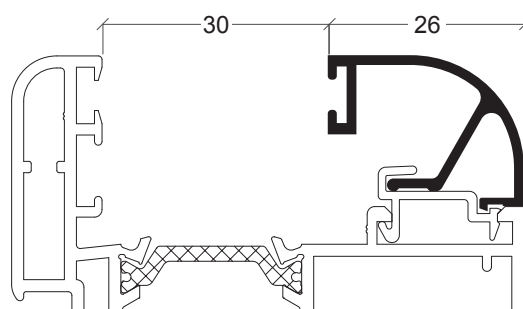

AX-29

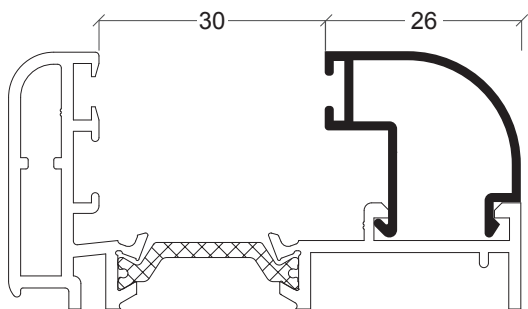

AZ-06

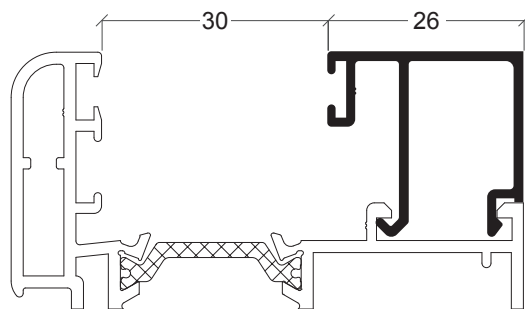

AX-31

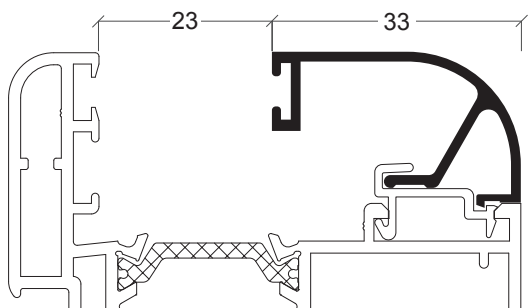

AX-39

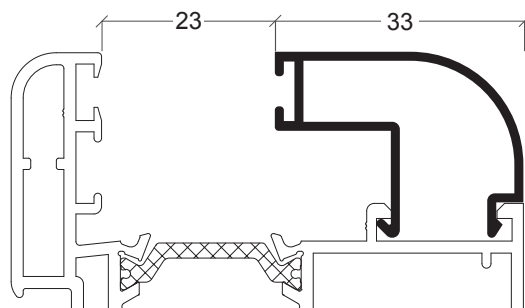

AZ-28

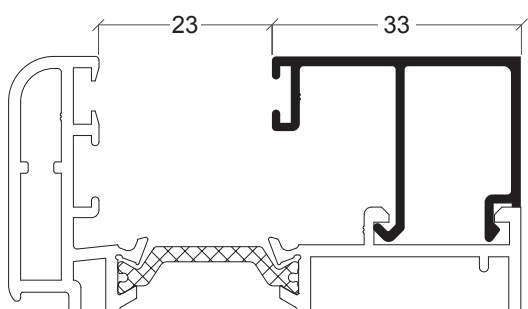

AX-34

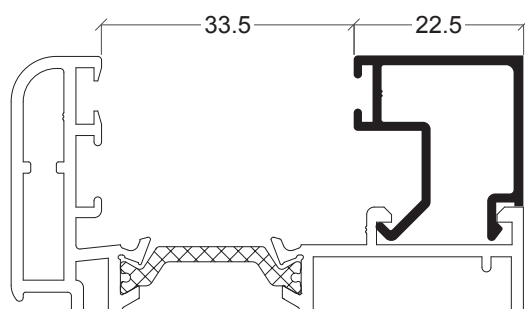

AX-78

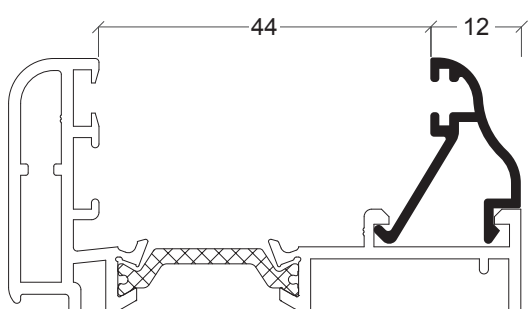

AX-73

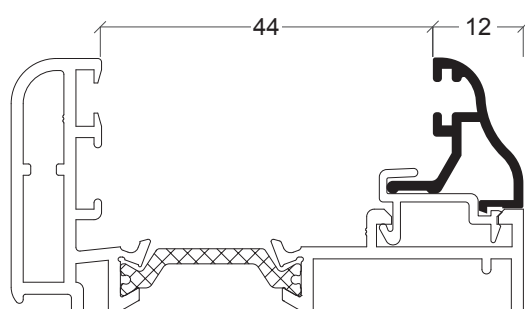

AX-72

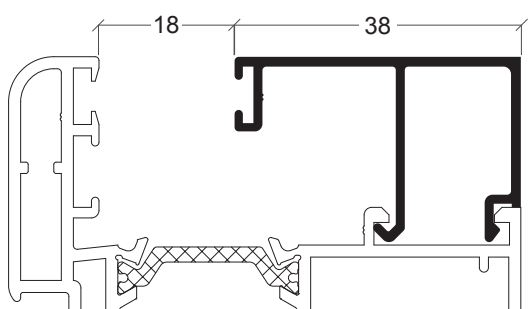

AX-32

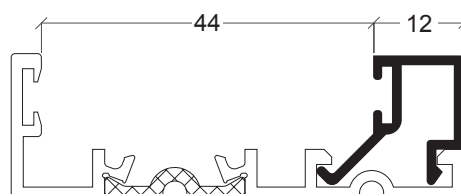

AX-70

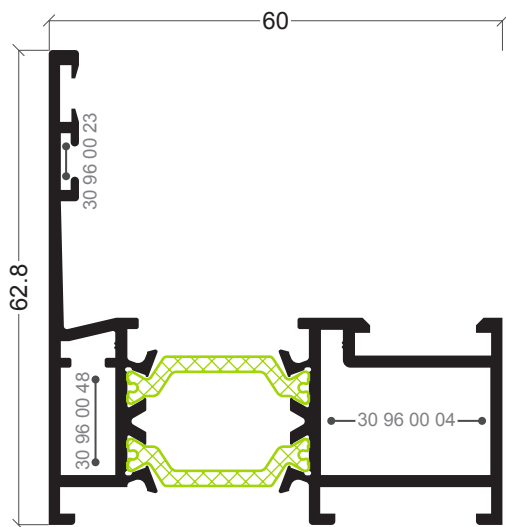

ARi-43
Aro fixo folha oculta

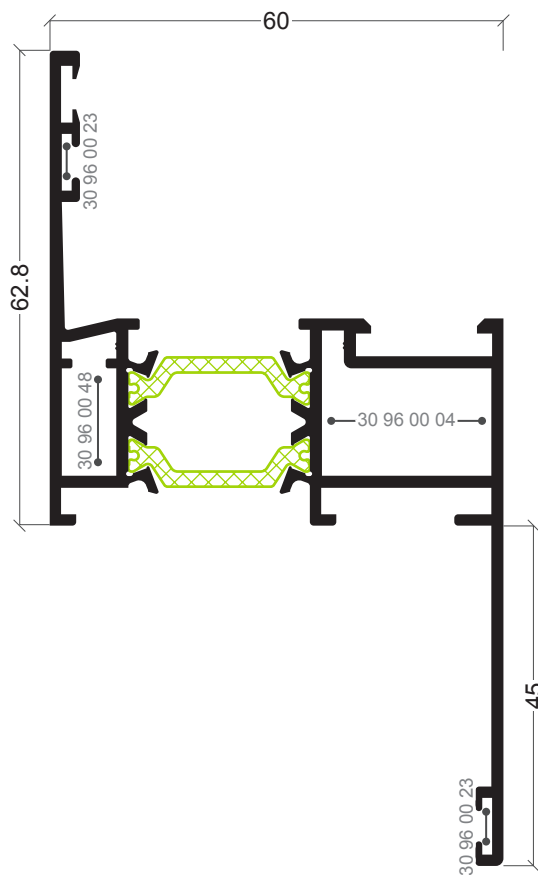

ARi-42
Aro fixo com remate folha oculta

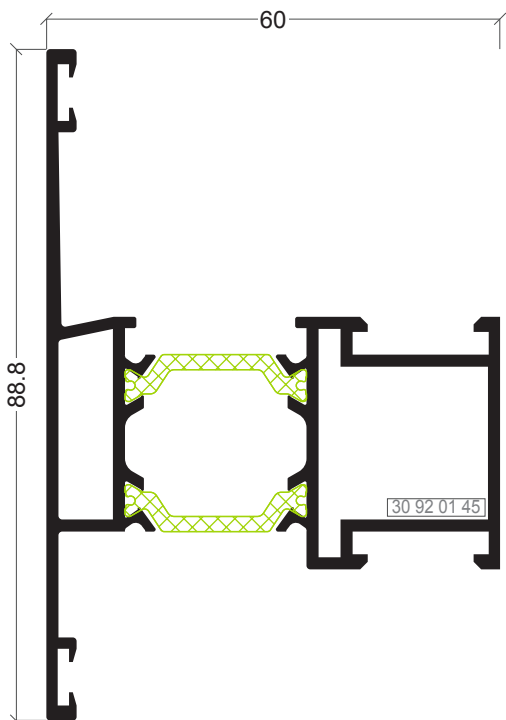

ARi-41
Travessa folha oculta

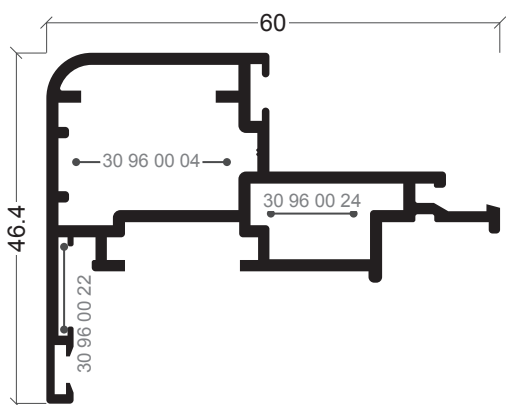

ARi-45
Aro móvel folha oculta

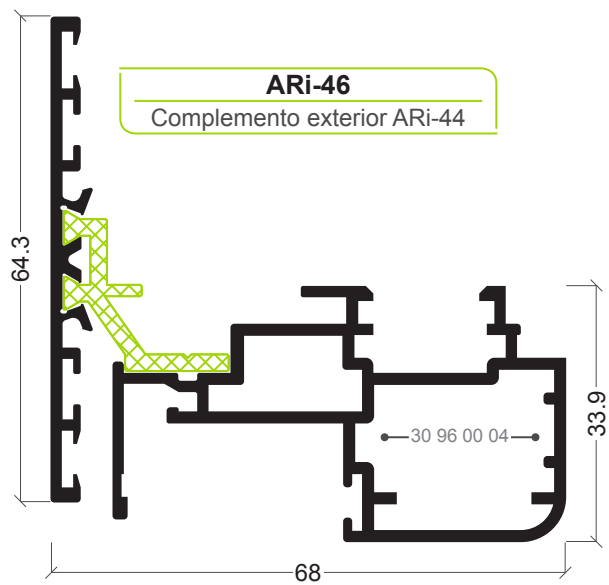

ARi-46
Complemento exterior ARI-44

ARi-44
Aro móvel inversor folha oculta

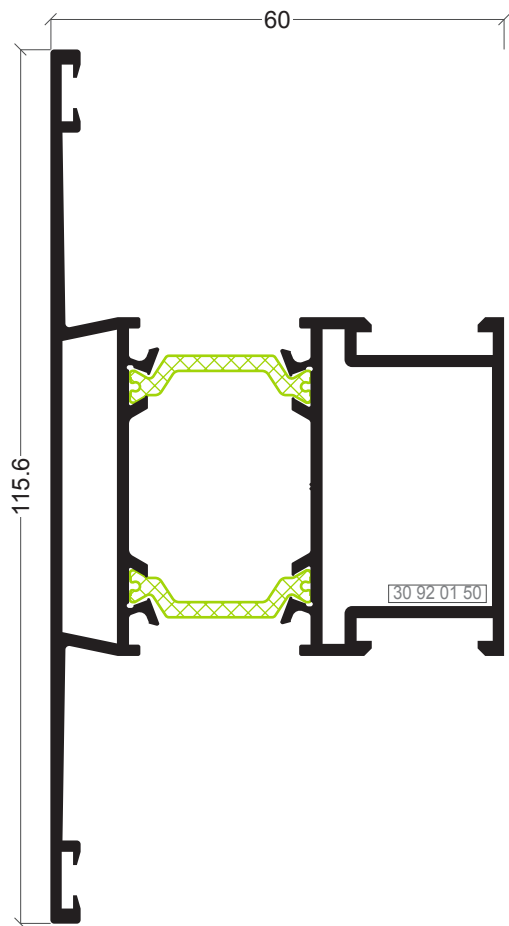

ARi-70
Travessa

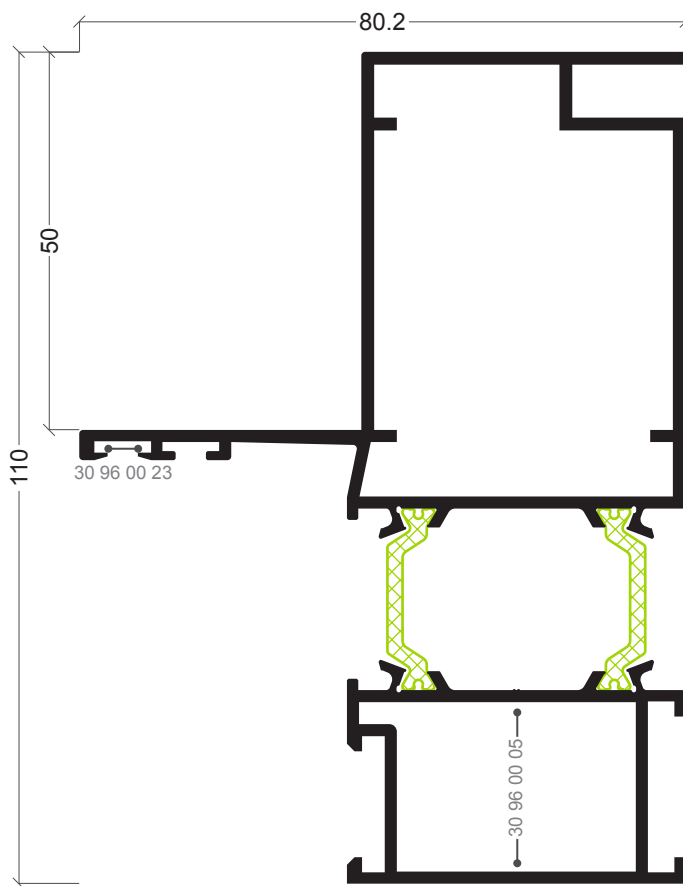

ARi-55
Aro fixo montante

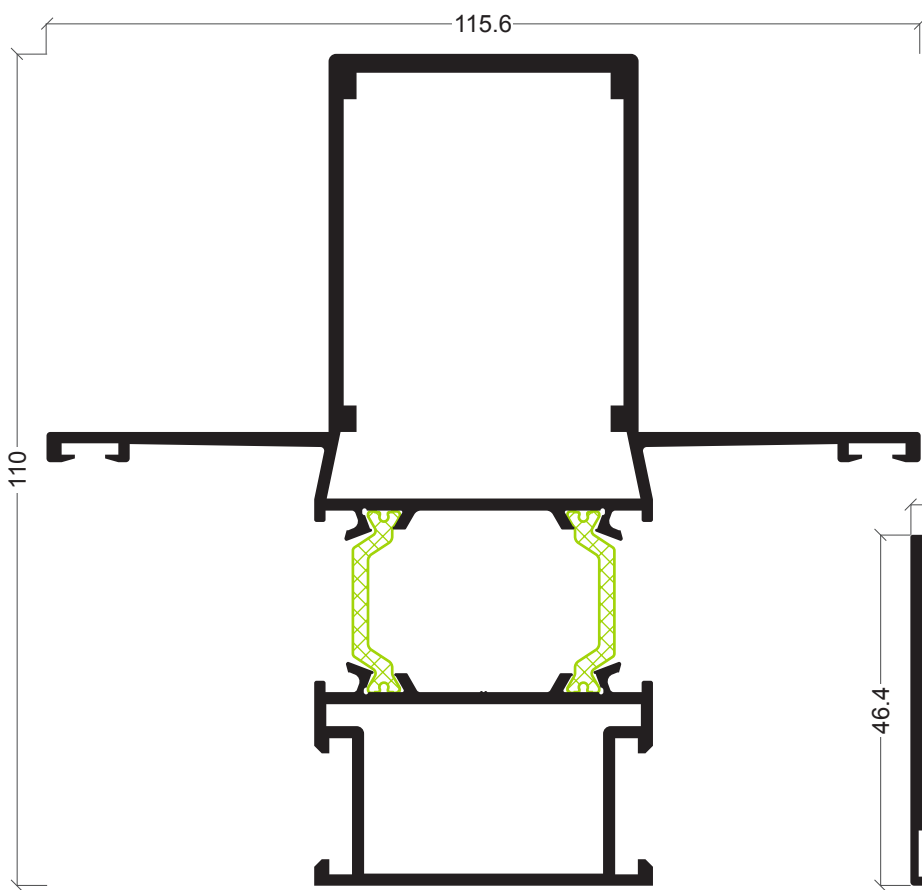

ARi-54
Montante

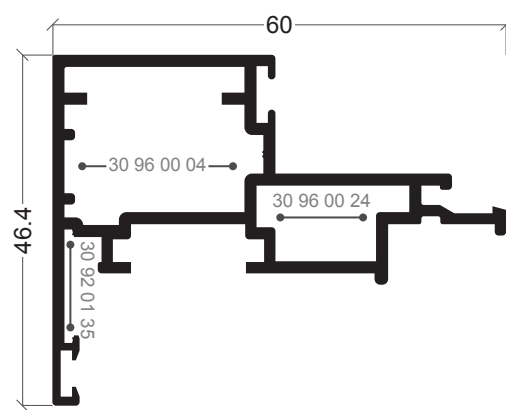

ARi-71
Móvel para vãos de 1 folha ou 1 folha + fixo

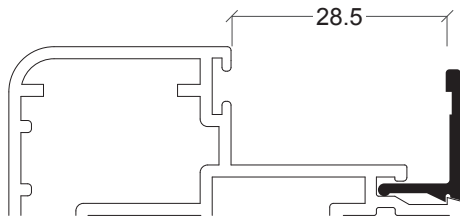

ARi-47

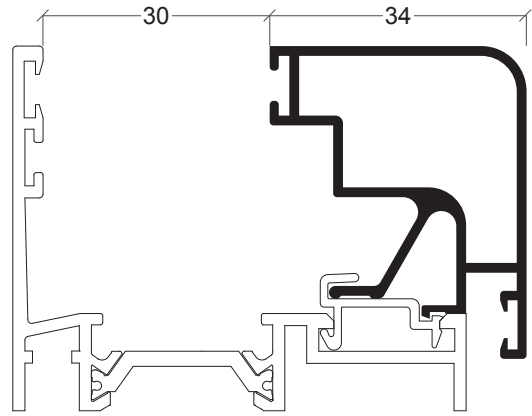

ARi-53

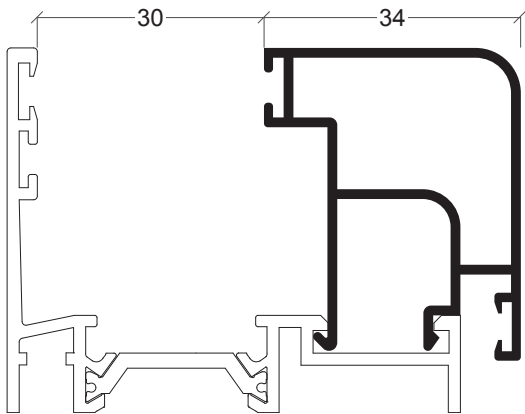

ARi-52

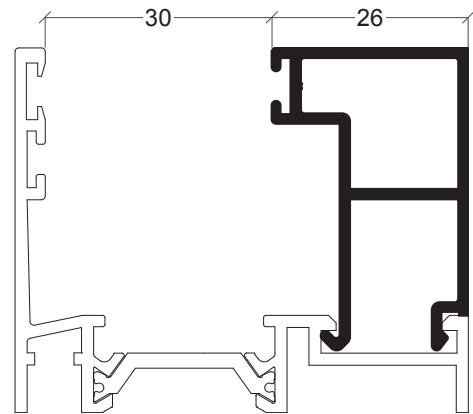

ARi-48

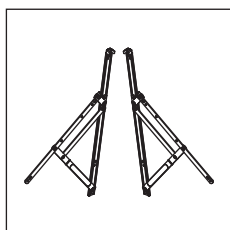

30 00 95 71

Compasso projectante
deslizante até 100 kg/folha

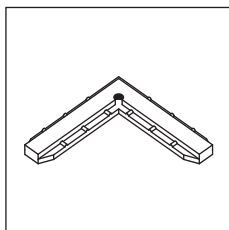

30 21 20 07

Esquadro de
alinhamento

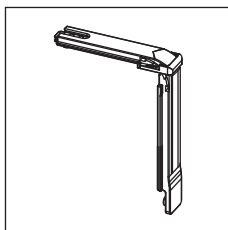

30 90 20 42

Ângulo de reenvio

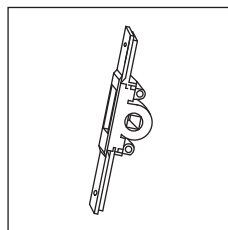

30 90 20 44

Transmissão para
abertura exterior

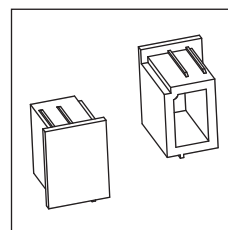

30 91 21 20

Jogo topos condensação
para Y-20

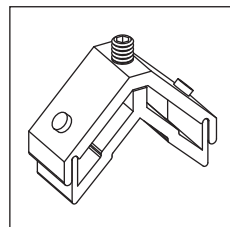

30 91 40 15

Esquadro aro fixo ARi-38

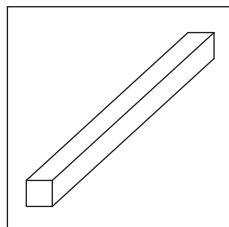

30 91 41 23

Perno 7x131 mm

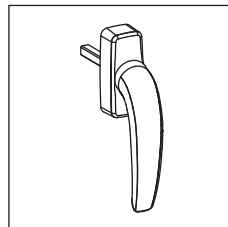

30 91 41 47/48

Cremona pivotante especial
branco/preto

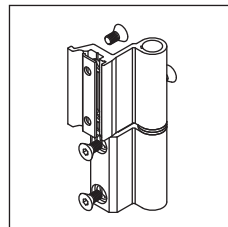

30 92 00 20/21

Dobradiça C.E. branco/
preto

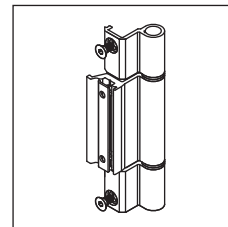

30 92 00 26/27/28

Dobradiça três nós
(bruto/branco/preto)

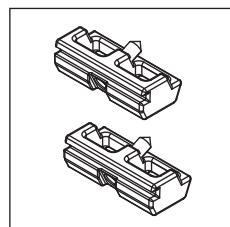

30 92 00 50

Contra-fecho

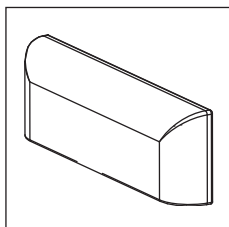

30 92 01 00/01

Goteiras preto/branco

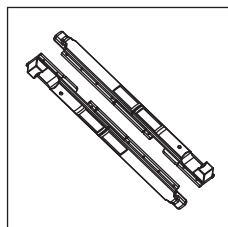

30 92 01 20

Jogo fecho C.E.

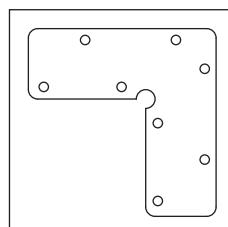

30 92 01 35

Esquadro alinhamento
móvel

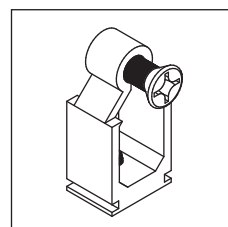

30 92 01 40

União topos janela

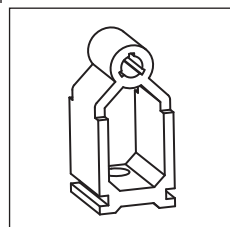

30 92 01 45

União topos janela folha
oculta

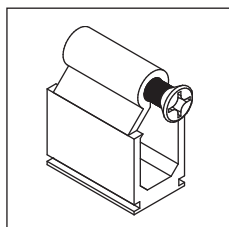

30 92 01 50

União topos porta

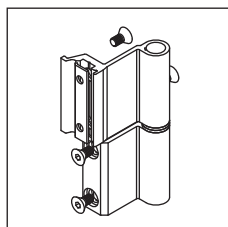

30 92 01 70/80

Dobradiça 3 folhas
branco/preto

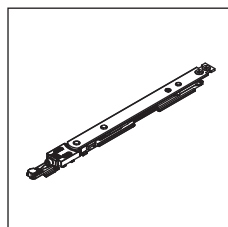

30 92 02 10/11/12

Compasso oscilo
300/400/500

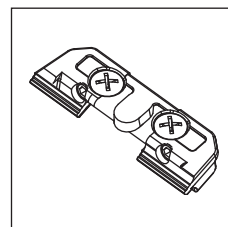

30 92 02 15

Fecho para micro-
ventilação

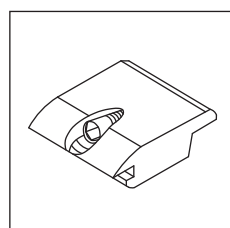

30 92 02 60

Apoio da folha

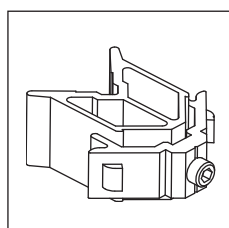

30 92 03 90

Esquadro porta

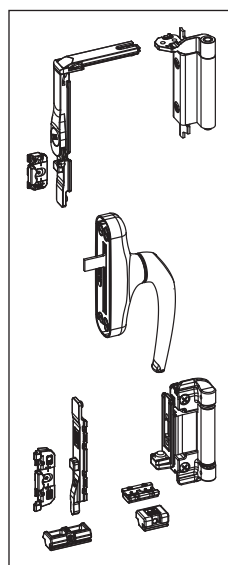

30 92 02 20/21

Kit oscilobatente branco/
preto

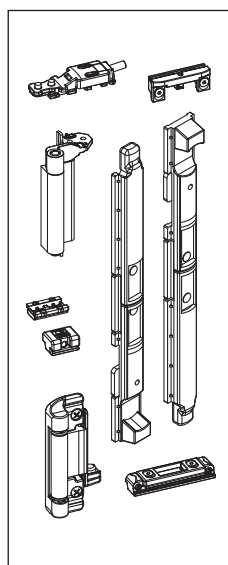

30 92 02 24/25

Kit 2ª folha OB branco/
preto

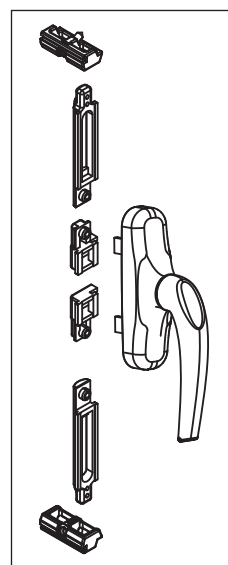

30 92 03 10/11

Kit cremone branco/preto

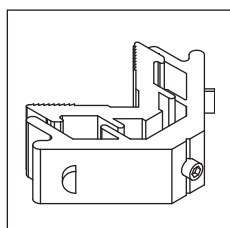

30 92 04 25

Esquadro ARi-80

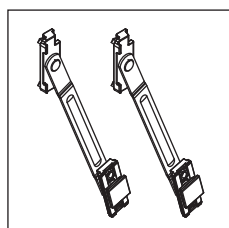

30 92 04 75

Jogo compasso
basculante

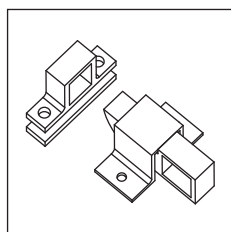

30 92 04 76/77

Fecho clack (branco/preto)

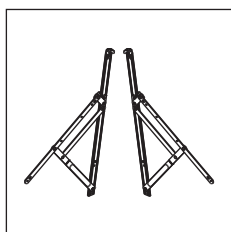

30 92 04 80

Compasso projectante deslizante até 50 kg/folha

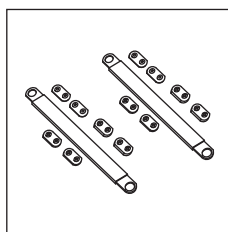

30 92 04 85

Jogo compasso

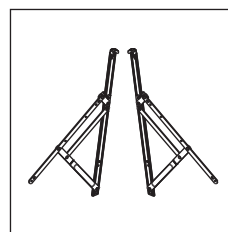

30 92 04 90

Compasso projectante deslizante até 70 kg/folha

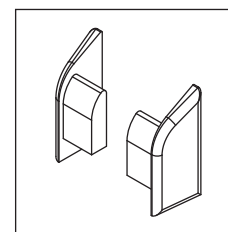

30 92 05 00

Jogo topos

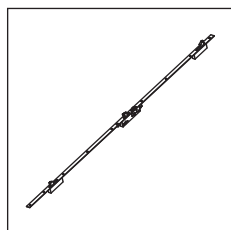

30 92 05 10

Fechadura 3 pontos (35 mm)

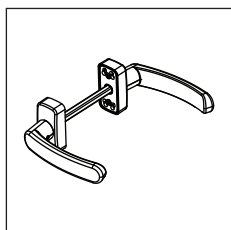

30 92 05 15

Fecho de alavanca com 5 pontos de fecho

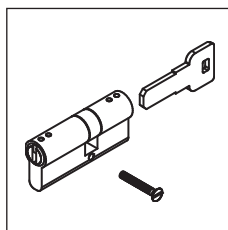

30 92 05 50

Canhão fechadura

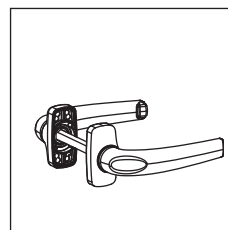

30 92 05 60/61

Puxador duplo branco/preto

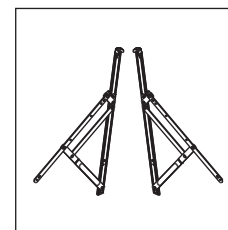

30 92 06 00

Compasso projectante deslizante até 20 kg/folha

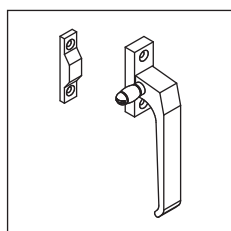

30 92 06 10/11

Cremona de lingueta branco/preto

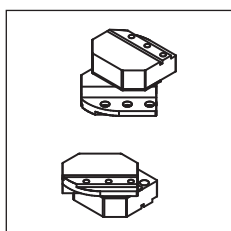

30 92 07 12

Jogo pivotante vertical especial ARi preto (130 kg)

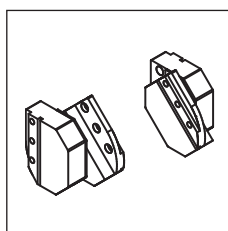

30 92 07 13

Jogo pivotante horizontal especial ARi preto (130 kg)

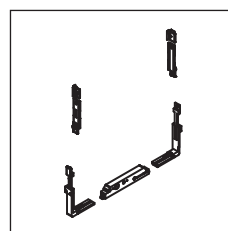

30 92 07 16

Fecho perimetral pivotante especial

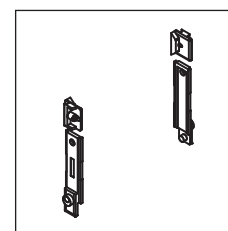

30 92 07 17

Fecho suplementar pivotante especial

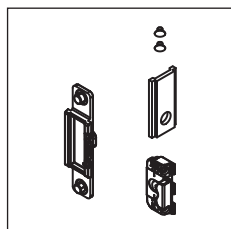

30 92 22 43

Ponto fecho suplementar

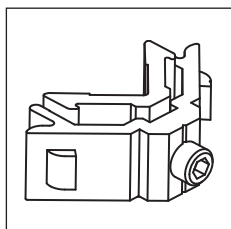

30 96 00 04

Esquadro janela

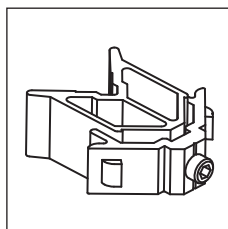

30 96 00 05

Esquadro aro fixo porta

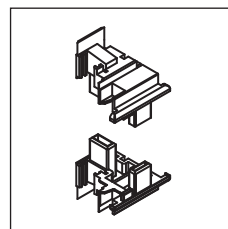

30 96 00 08

Jogo topos inversor ARi

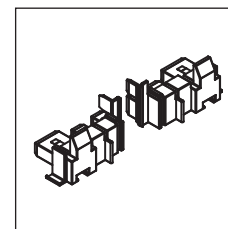

30 96 00 10

Jogo topos ARi-23

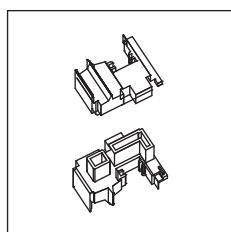

30 96 00 11

Jogo topos inversor abertura exterior ARi-15

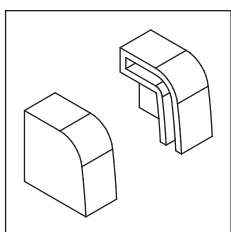

30 96 00 12

Jogo topos condensação

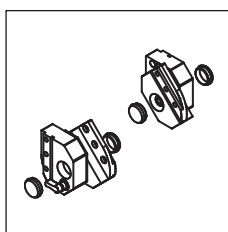

30 96 00 13

Jogo pivotante (60 kg)

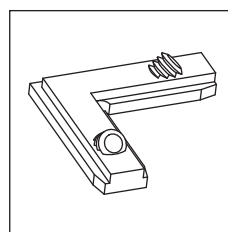

30 96 00 15

Esquadro alinhamento móvel

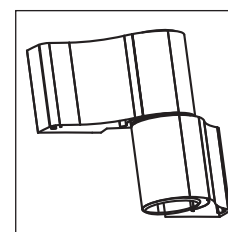

30 96 00 16/20

Dobradiça lisa (branco/preto)

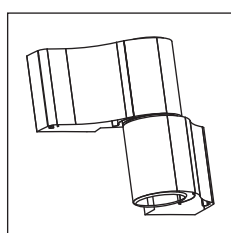

30 96 00 17/21

Dobradiça com ressalto (branco/preto)

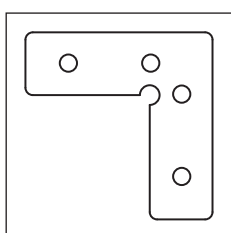

30 96 00 22

Esquadro alinhamento especial

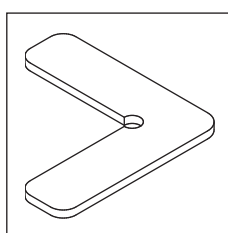

30 96 00 23

Esquadro alinhamento aro fixo

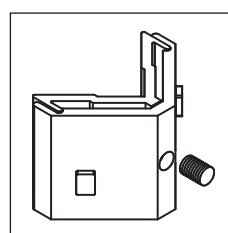

30 96 00 24

Esquadro exterior móvel folha oculta

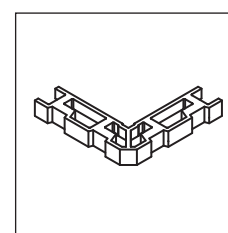

30 96 00 25

Esquadro exterior aro fixo

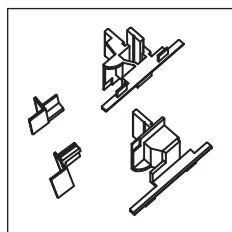

30 96 00 26
Jogo topos inversor folha oculta

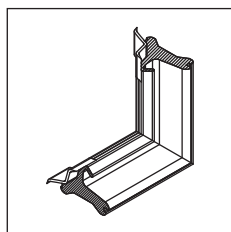

30 96 00 35
Canto vulcanizado

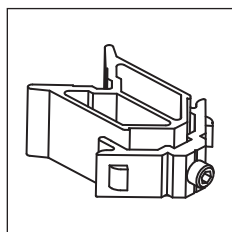

30 96 00 36
Esquadro aro móvel porta

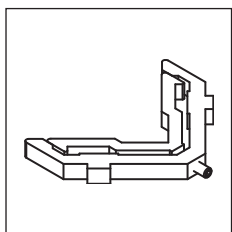

30 96 00 38
Esquadro alinhamento móvel janela

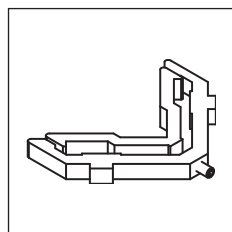

30 96 00 39
Esquadro para alinhamento fixo janela

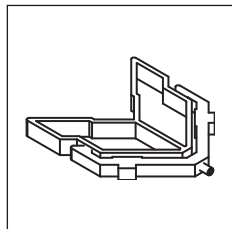

30 96 00 40
Esquadro alinhamento aro fixo porta

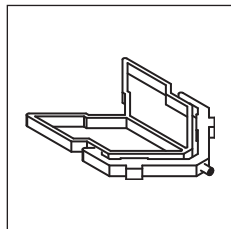

30 96 00 41
Esquadro alinhamento aro móvel porta

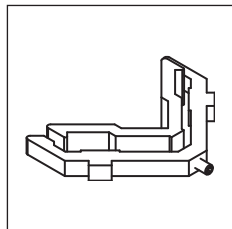

30 96 00 42
Esquadro perfil ARi-07

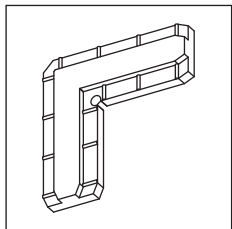

30 96 00 43
Esquadro alinhamento

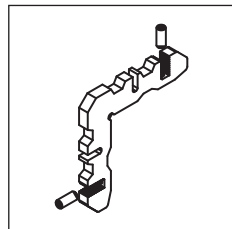

30 96 00 45
Esquadro de alinhamento 5.2x14 com parafusos

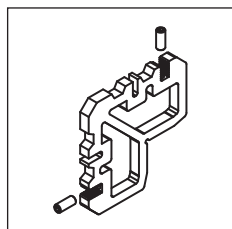

30 96 00 46
Esquadro de alinhamento 5.2x36 com parafusos

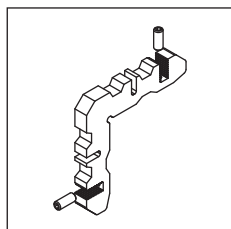

30 96 00 48
Esquadro de alinhamento 7x14 c/ parafusos

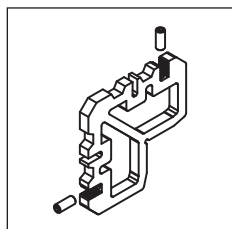

30 96 00 49
Esquadro de alinhamento aro fixo com parafusos

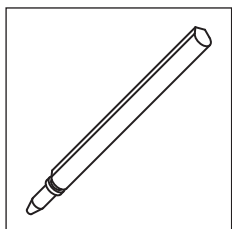

30 96 00 55
Perno alternativo para fixação de esquadro

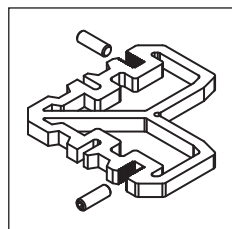

30 96 00 60
Esquadro de alinhamento 5.2x31.6 com parafusos

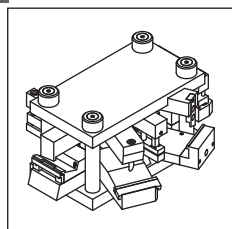

33 96 79 99
Cunho C.E.

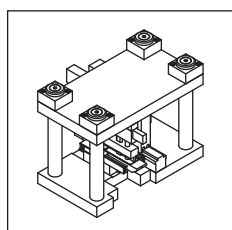



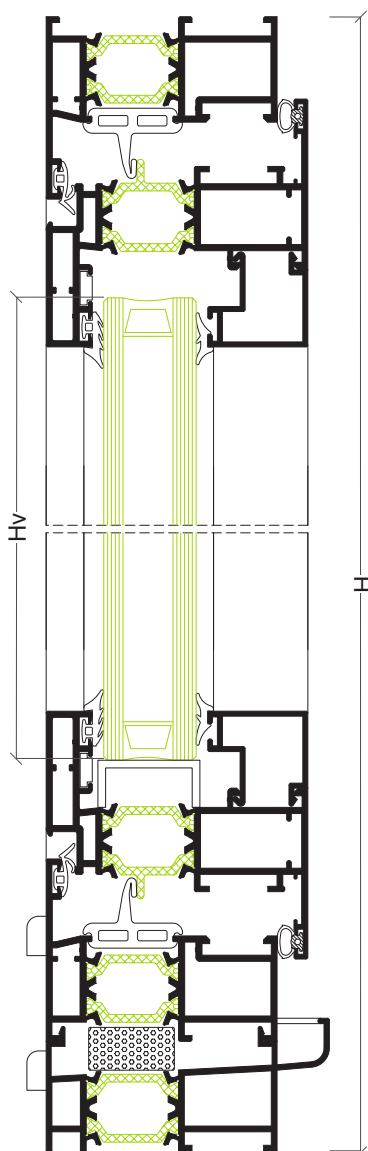
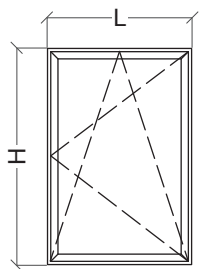

33 96 87 99
Cunho esquadro interior e exterior ARi/AKi

Referência	Desenho	Descrição
30 00 95 15		Junta vedação interior curta
30 20 30 03		Junta isolante
30 20 70 03		Pelúcia remate porta 11x12 mm
30 60 00 17		Junta exterior vidro plana 2 mm preto
30 92 04 70		Espuma isolante
30 93 00 60		Vedante exterior de vidro (opcional)
30 93 00 61		Junta vedação exterior vidro 2 mm
30 93 00 62		Junta plana para vidro
30 93 00 65		Junta interior para vidro (5 mm)
30 93 00 66		Junta interior para vidro (4 mm)
30 93 00 67		Junta interior para vidro (2 mm)
30 93 00 68		Junta interior para vidro (6/7 mm)
30 93 00 69		Junta interior para vidro (8/9 mm)
30 93 00 70		Vedante interior de vidro (opcional)
30 93 00 80		Junta de vedação inferior ARi-42
30 93 00 82		Junta vedação inferior
30 93 01 20		Junta interior
30 93 01 30		Junta exterior (abertura exterior/projectante)
30 95 00 10		Pelúcia 7x9 mm
30 96 00 02		Junta exterior
30 96 00 03		Junta central
30 96 00 09		Junta central abertura exterior (ARi-25) ou tapa-canal
30 96 00 18		Junta interior (abertura projectante/deslizante)
30 96 00 27		Junta exterior folha oculta

Janela 1 folha abrir e oscilo-batente



Perfis

Desenho	Ref	Descrição	Corte	Quant	Medida
	ARI-03	Aro fixo		2	L
				2	H-28.5 mm
	ARI-61	Aro móvel		2	L-43 mm
				2	H-71.5 mm
	---	Bite		2	L-132 mm
				2	H-200.5 mm
	CT-11	Soleira condensação		1	L
	AZ-23	Pingadeira 60 mm		1	L
	AX-19	Vareta		1+1	Apro. H+L

Acessórios e Juntas

Referência	Descrição	Quantidade	
		Abrir	Oscilo-batente
30 92 00 20	Dobradiças C.E.	2	---
30 92 01 00	Goteiras	4	4
30 92 02 XX	Compasso O.B.	---	1
30 92 02 20	Kit oscilo-batente	---	1
30 92 02 60	Apoio da folha	1	---
30 92 03 10	Kit cremone	1	---
30 96 00 04	Esquadro janela	8	8
30 96 00 48	Esquadro alinhamento aro fixo	4	4
30 96 00 12	Jogo topos condensação	1	1
30 96 00 15	Esquadro alinhamento móvel	4	4
30 96 00 22	Esquadro alinhamento móvel	4	4
30 96 00 45	Esquadro alinhamento exterior móvel	4	4
30 96 00 35	Canto vulcanizado	4	4
30 92 04 70	Espuma isolante	L	
30 96 00 02	Junta exterior	2L+2H	
30 96 00 03	Junta central	2L+2H	
30 93 01 20	Junta interior	2L+2H	
---	Junta exterior vidro	2L+2H	
---	Junta interior vidro	2L+2H	

83

Vidro

Hv = H-174 mm	Lv = L-146 mm
---------------	---------------

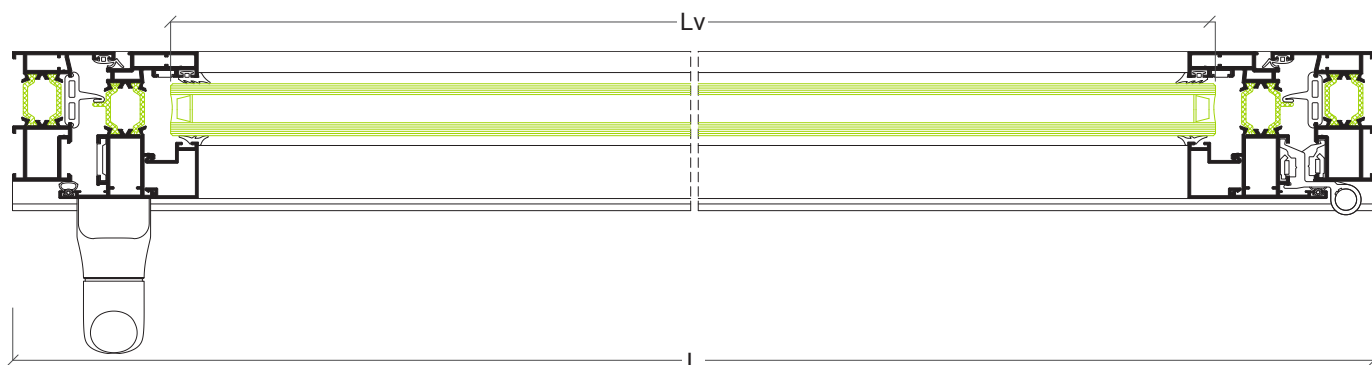

Janela 2 folhas abrir e oscilo-batente

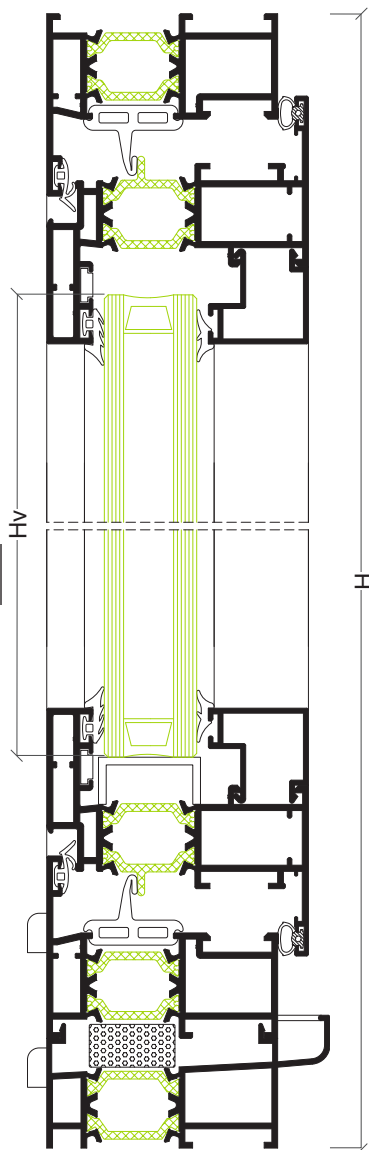
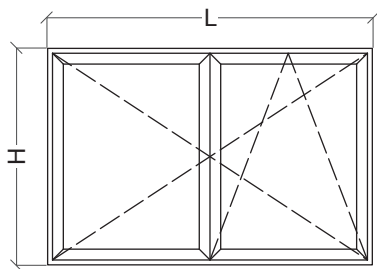

Perfis

Desenho	Ref	Descrição	Corte	Quant	Medida
	ARi-03	Aro fixo		2	L
				2	H-28.5 mm
	ARi-61	Aro móvel		2	L/2-24 mm
				2	H-71.5 mm
	ARi-04	Inversor		1	H-139.5 mm
	---	Bite		4	L/2-113 mm
				4	H-200.5 mm
	CT-11	Soleira condensação		1	L
	AX-19	Vareta		1+1	Apro. H+L

Acessórios e Juntas

Referência	Descrição	Quantidade	
		Abrir	Oscilo-batente
30 92 00 20	Dobradiças C.E.	4	---
30 92 01 00	Goteiras	4	4
30 92 01 20	Jogo fecho C.E.	1	---
30 92 02 XX	Compasso O.B.	---	1
30 92 02 20	Kit oscilo-batente	---	1
30 92 02 24	Kit 2ª folha oscilo-batente	---	1
30 92 02 60	Apoio da folha	1	---
30 92 03 10	Kit cremone	1	---
30 96 00 04	Esquadro janela	12	12
30 96 00 48	Esquadro alinhamento aro fixo	8	8
30 96 00 08	Jogo topos inversor	1	1
30 96 00 12	Jogo topos condensação	1	1
30 96 00 15	Esquadro alinhamento móvel	8	8
30 96 00 22	Esquadro alinhamento móvel	8	8
30 96 00 45	Esquadro alinhamento exterior móvel	4	4
30 96 00 35	Canto vulcanizado	4	4
30 92 04 70	Espuma isolante	L	
30 96 00 02	Junta exterior	2L+4H	
30 96 00 03	Junta central	2L+3H	
30 93 01 20	Junta interior	2L+4H	
---	Junta exterior vidro	2L+2H	
---	Junta interior vidro	2L+2H	

Vidro

Hv = H-174 mm	Lv = L/2-127 mm
---------------	-----------------

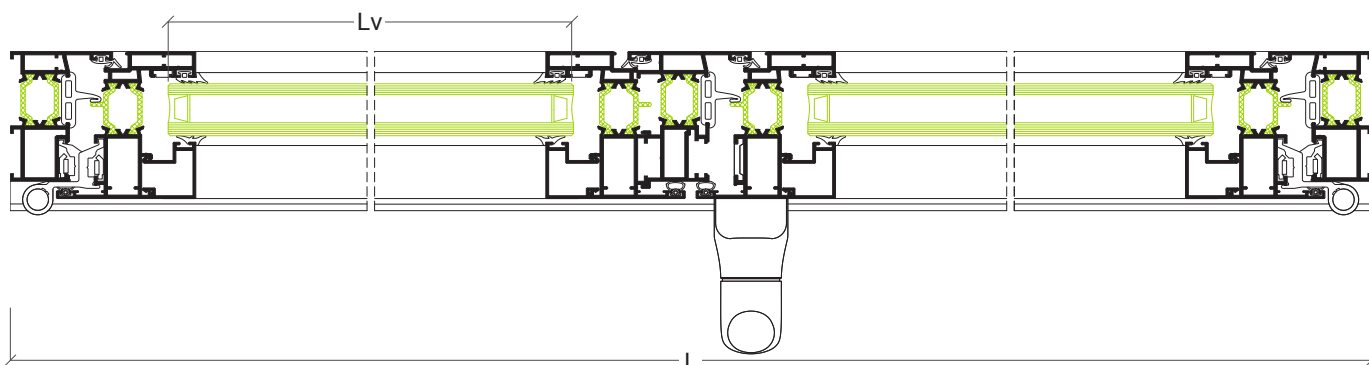

Janela projectante deslizante

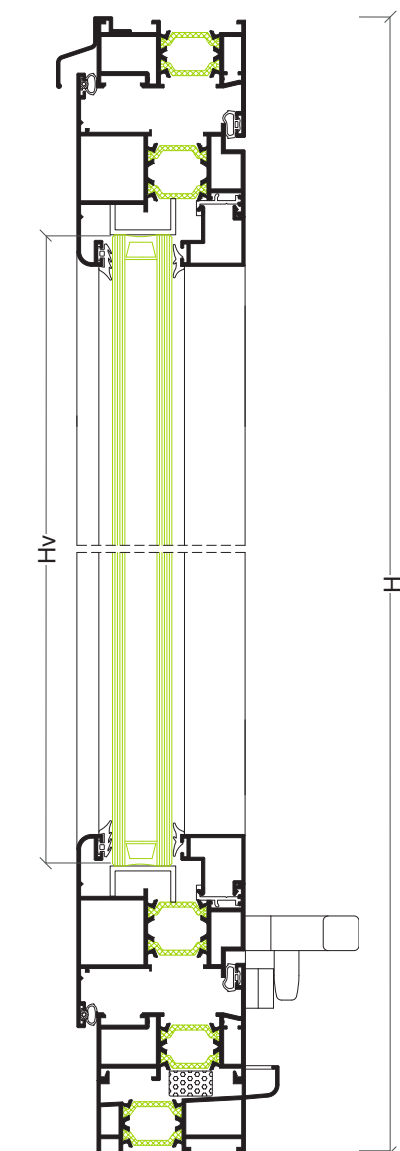
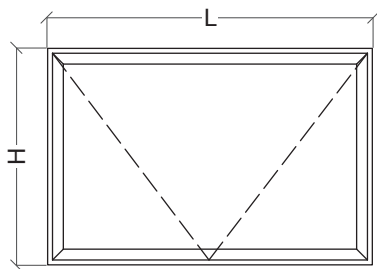

Perfis

Desenho	Ref	Descrição	Corte	Quant	Medida
	ARi-03	Aro fixo		2	L
				2	H-28.5 mm
	ARi-07	Aro móvel abertura projectante deslizante		2	L-43 mm
				2	H-71.5 mm
	---	Bite		4	L-159 mm
				4	H-227.5 mm
	AXi-45	Pingadeira superior		1	L
	AXi-32	Complemento abertura projectante		2	segundo medida compasso
	ARi-29	Apoio bite		2	L-140 mm
				2	H-168.5 mm
	CT-11	Soleira condensação		1	L

Acessórios e Juntas

Referência	Descrição	Quantidade
30 92 01 00	Goteiras	2
30 92 04 10	Esquadro janela	4
30 92 04 90	Jogo compasso projectante deslizante 550	1
30 92 06 10	Cremona de lingueta	2
30 92 04 10	Esquadro janela abertura exterior	4
30 96 00 12	Jogo topos condensação	1
30 96 00 48	Esquadro alinhamento aro fixo	4
30 96 00 42	Esquadro alinhamento interno móvel	4
30 92 04 70	Espuma isolante	L
30 93 01 20	Junta exterior	2L+2H
30 96 00 18	Junta interior projectante deslizante	2L+2H
---	Junta exterior vidro	2L+2H
---	Junta interior vidro	2L+2H

85

Vidro

Hv = H-201 mm	Lv = L-173 mm
---------------	---------------

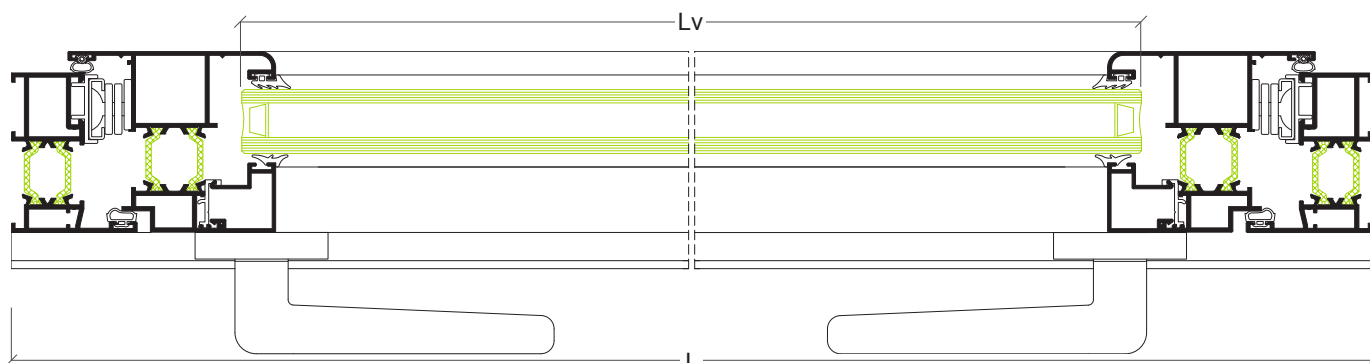

Janela pivotante horizontal

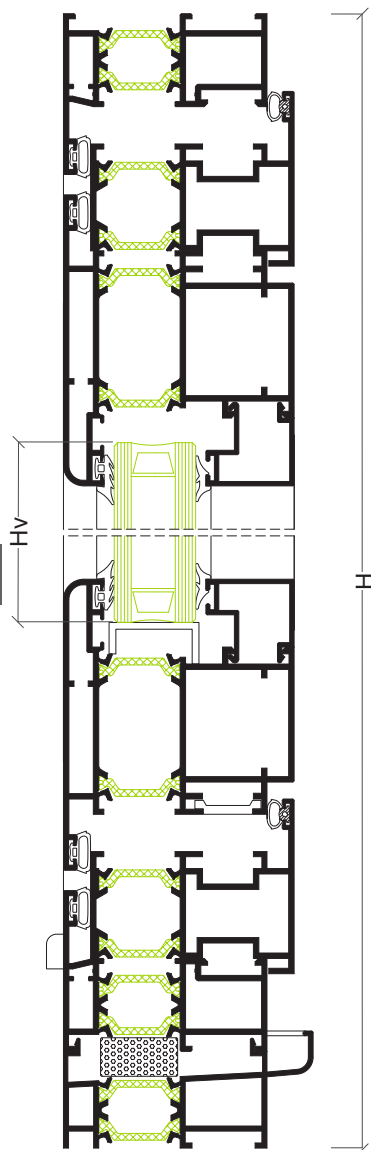
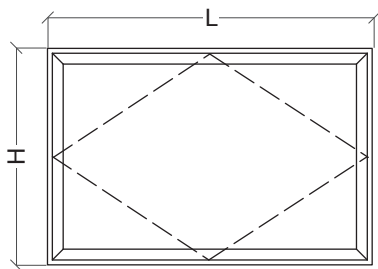

Perfis

Desenho	Ref	Descrição	Corte	Quant	Medida
	ARi-03	Aro fixo		2	L
				2	H-28.5 mm
	ARi-25	Aro móvel abertura exterior		2	L-107 mm
				2	H-135.5 mm
	ARi-14	Inversor pivotante superior		1	L-46 mm
				2	H/2-23 mm
	ARi-14	Inversor pivotante inferior		1	L-46 mm
				2	H/2-51.5 mm
	---	Bite		2	L-239 mm
				2	H-307.5 mm
	CT-11	Soleira condensação		1	L
	AX-19	Vareta		1+1	L+H
				1+1	L+H

Acessórios e Juntas

Referência	Descrição	Quantidade
30 92 01 00	Goteiras	4
30 94 50 10	Esquadro inversor	4
30 96 00 04	Esquadro janela	4
30 96 00 05	Esquadro móvel	4
30 96 00 48	Esquadro alinhamento exterior janela	4
30 96 00 12	Jogo topos condensação	1
30 92 07 13	Jogo pivotante horizontal	1
30 92 07 16	Fecho perimetral pivotante	1
30 96 00 15	Esquadro alinhamento móvel	4
30 96 00 49	Esquadro alinhamento móvel	4
30 91 41 48	Cremones	1
30 92 04 70	Espuma isolante	L
30 96 00 18	Junta exterior	4L+4H
30 93 01 20	Junta interior	2L+2H
---	Junta exterior vidro	2L+2H
---	Junta interior vidro	2L+2H

Vidro

Hv = H-281 mm	Lv = L-253 mm
---------------	---------------

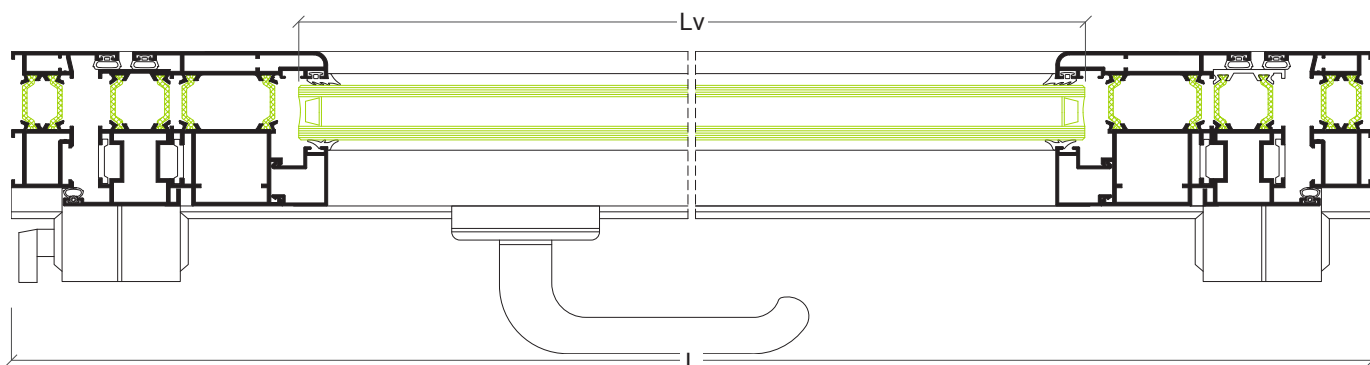

Porta 1 folha

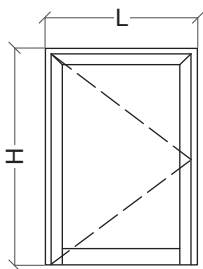

Perfis

Desenho	Ref	Descrição	Corte	Quant	Medida
	ARI-08	Aro fixo		1	L
				2	H
	ARI-36	Aro móvel		2	L-78 mm
				2	H-46 mm
	ARI-23	Almofada		1	L-147 mm
	---	Bite		4	L-216 mm
				4	H-226 mm
	AZ-60	Pingadeira		1	L-148 mm

Acessórios e Juntas

Referência	Descrição	Quantidade
30 92 00 20	Dobradiças C.E.	3
30 92 01 35	Esquadro alinhamento móvel	4
30 92 05 10	Fechadura 3 pontos	1
30 92 05 50	Canhão fechadura	1
30 92 05 60	Puxador duplo	1
30 96 00 05	Esquadro aro porta	2
30 96 00 15	Esquadro alinhamento móvel	4
30 96 00 36	Esquadro móvel porta	4
30 96 00 46	Esquadro alinhamento aro móvel porta	4
30 96 00 49	Esquadro alinhamento aro fixo	2
30 96 00 10	Jogo topos ARi-23	1
31 03 40 00	Mola para pingadeira	A cada 200 mm
30 96 00 35	Canto vulcanizado	2
30 92 05 00	Jogo topos AZ-60	1
30 93 00 80	Junta inferior	L
30 96 00 02	Junta exterior	L+2H
30 96 00 03	Junta central	L+2H
30 93 01 20	Junta interior	L+2H
---	Junta exterior vidro	2L+2H
---	Junta interior vidro	2L+2H

87

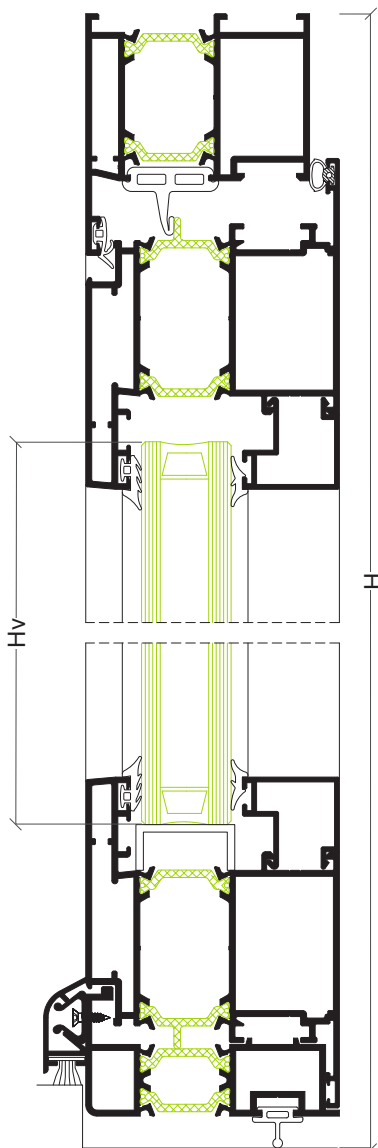

Vidro

Hv = H-200 mm	Lv = L-230 mm
---------------	---------------

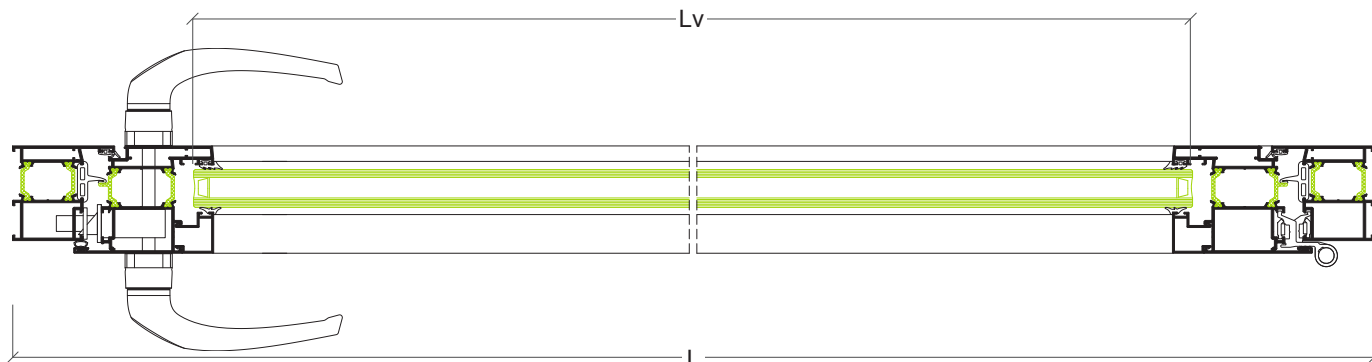

Porta 2 folhas abertura exterior

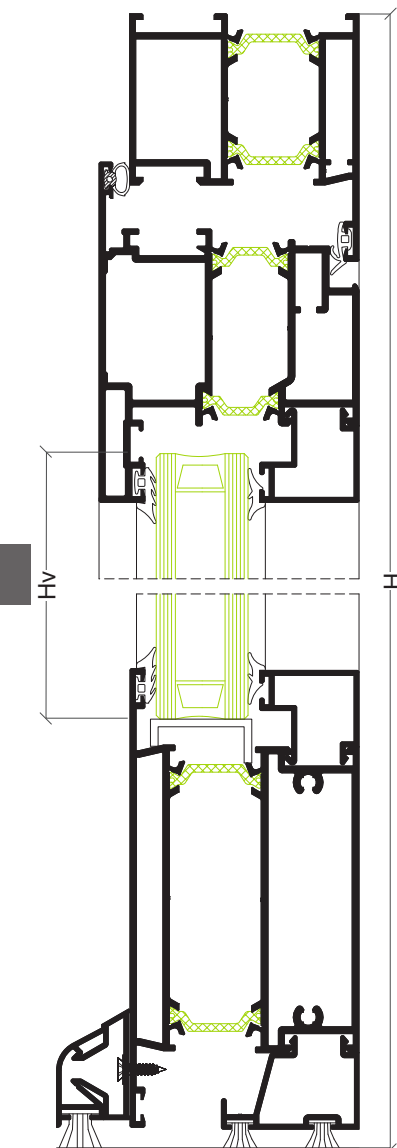
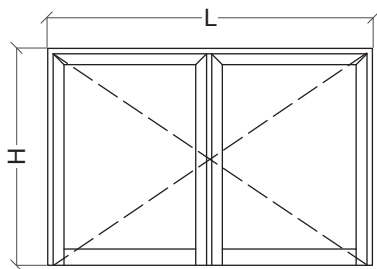

Perfis

Desenho	Ref	Descrição	Corte	Quant	Medida
	ARi-08	Aro fixo		1	L
				2	H
	ARi-72	Aro móvel abertura exterior		2	L/2-41.5 mm
				4	H-44 mm
	ARi-04	Inversor		1	H-78 mm
	ARi-12	Travessa		1	L/2-169.5 mm
	AX-15	Bite remate		2	L/2-160.5 mm
	---	Bite		4	L/2-179 mm
				4	H-253 mm
	AZ-60	Pingadeira		1	L/2-112.5 mm
				1	L/2-43 mm
	AZ-61	Suplemento para pingadeira		2	L/2-219.5 mm

Acessórios e Juntas

Referência	Descrição	Quantidade
30 92 01 20	Jogo fecho C.E.	1
30 92 05 10	Fechadura 3 pontos	1
30 92 05 50	Canhão fechadura	1
30 92 05 60	Puxador duplo	1
30 96 00 05	Esquadro porta	2
30 96 00 08	Jogo topos inversor	1
30 92 00 20	Dobradiça C.E.	6
30 95 00 10	Pelúcia 7x9 mm	2L
30 95 05 00	Jogo topos AZ-60	1
30 92 03 90	Esquadro móvel exterior	4
30 92 01 35	Esquadro alinhamento móvel	4
30 96 00 15	Esquadro alinhamento móvel exterior	4
30 96 00 45	Esquadro móvel interior	4
30 96 00 49	Esquadro móvel exterior	2
30 93 01 20	Junta exterior	2L
30 96 00 02	Junta interior	L+4H
---	Junta exterior vidro	2L+4H
---	Junta interior vidro	2L+4H

Vidro

Hv = H-228 mm	Lv = L/2-194 mm
---------------	-----------------

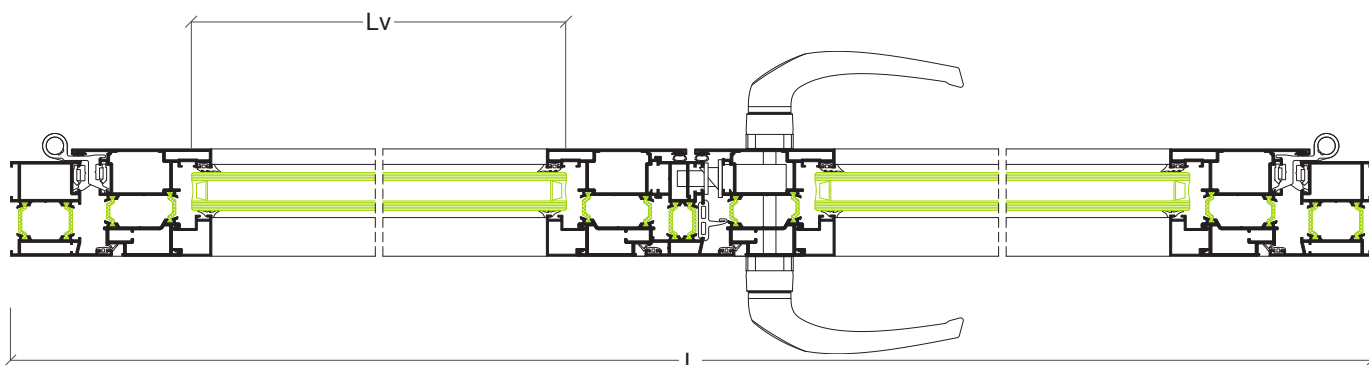

Porta oscilo-paralela com fixo lateral

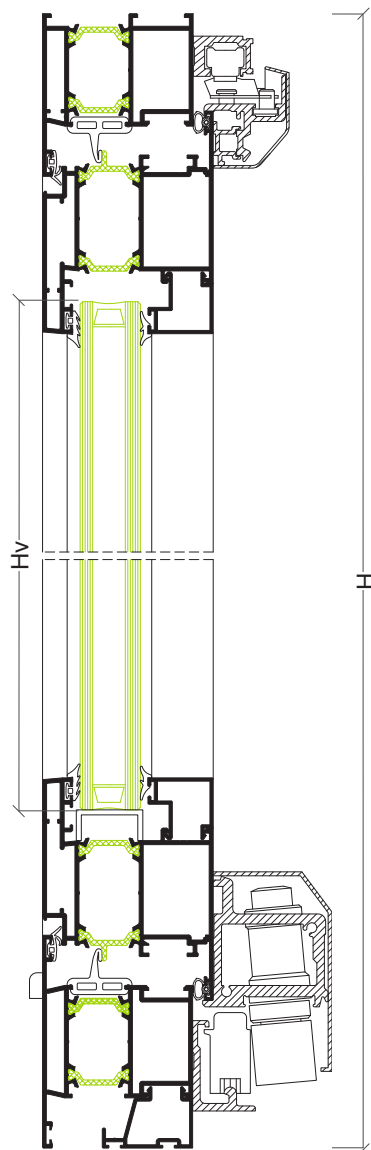
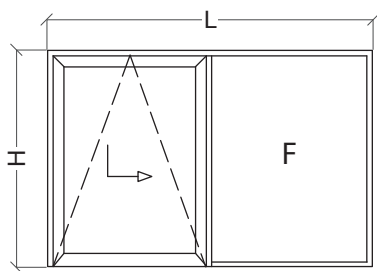

Perfis

Desenho	Ref	Descrição	Corte	Quant	Medida
	ARi-08	Aro fixo		1	L
				2	H
	ARi-06	Travessa		1	L-80.5 mm
				1	H-100.5 mm
	ARi-36	Aro móvel		2	L1-55.5 mm
				4	H-98 mm
	---	Bite (folha)		2	L1-193 mm
				2	H-275.5 mm
	---	Bite (fixo)		2	L2-67.5 mm
				2	H-150 mm
	AX-15	Bite remate		1	L-90 mm
	AX-19	Vareta		1+1	Aprox. L+H

Acessórios e Juntas

Referência	Descrição	Quantidade
30 92 01 00	Goteiras	4
30 92 01 35	Esquadro alinhamento móvel	4
30 92 01 50	União topos porta	4
30 96 00 05	Esquadro aro fixo	2
30 96 00 15	Esquadro alinhamento móvel	4
30 96 00 36	Esquadro aro móvel	4
30 96 00 46	Esquadro alinhamento exterior aro móvel	4
30 96 00 49	Esquadro alinhamento aro fixo	2
---	Kit oscilo-paralela	1
30 96 00 35	Canto vulcanizado	4
30 96 00 02	Junta exterior	2L1+2H
30 96 00 03	Junta central	2L1+2H
30 93 01 20	Junta interior	2L1+2H
---	Junta exterior vidro	2L+2H
---	Junta interior vidro	2L+2H

Vidro

Hv folha = H-249 mm	Lv folha = L1-206 mm	
Hv fixo = H-124 mm	Lv fixo = L2-81 mm	
	Mínimo	Máximo
Largura da folha	700 mm	1650 mm
Altura da folha	850 mm	2400 mm
Peso máximo por folha 150 kg		

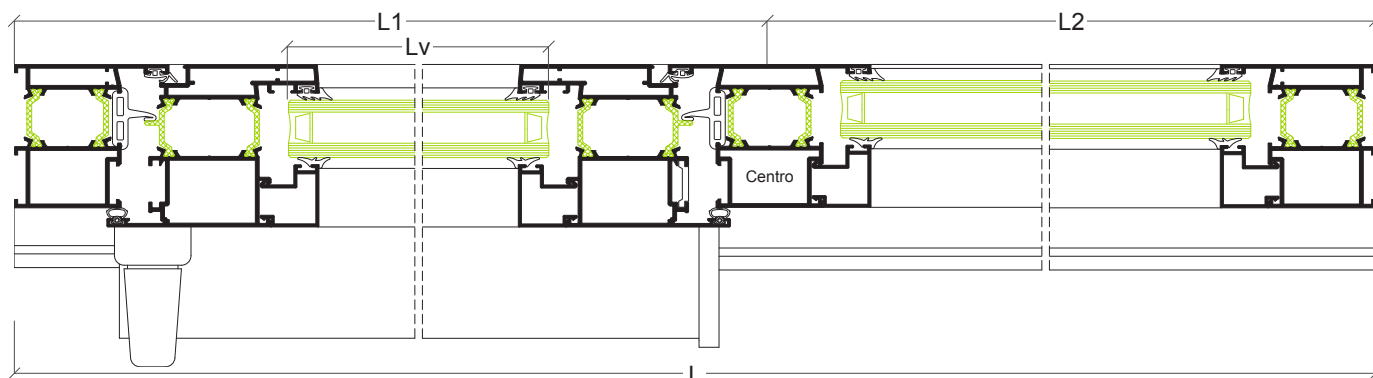

Porta 3 folhas harmónio

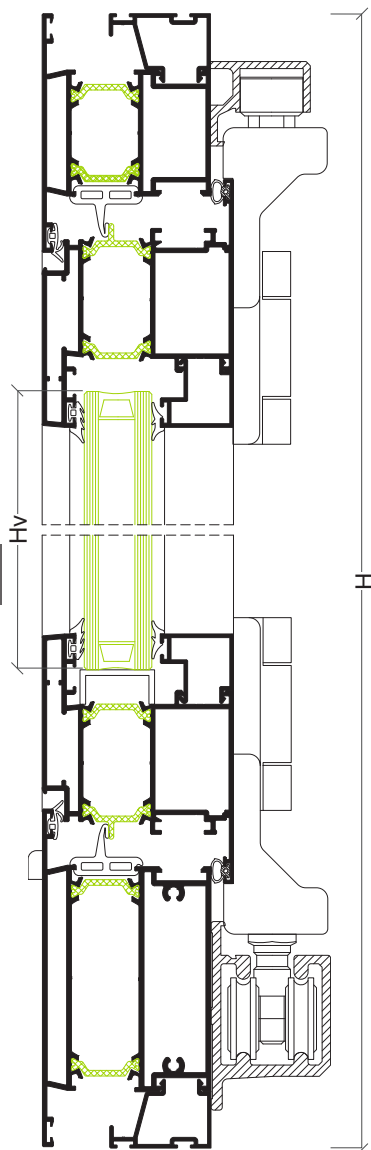
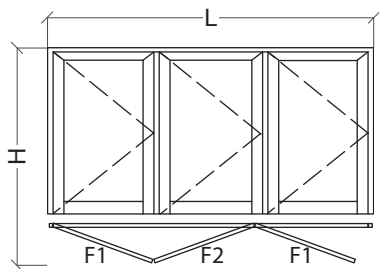

Perfis

Desenho	Ref	Descrição	Corte	Quant	Medida
	ARi-08	Aro fixo		2	H
	ARi-06	Travessa		1	L-80.5 mm
	ARi-12	Travessa		1	L-80.5 mm
	ARi-36	Aro móvel		6	consultar
				6	consultar
	ARi-04	Inversor		2	consultar
	---	Bite (folha)		6	consultar
				6	consultar
	AX-15	Bite remate		2	L-90 mm
	AX-19	Vareta		2	2H

Acessórios e Juntas

Referência	Descrição	Quantidade
30 92 01 00	Goteiras	6
30 92 01 35	Esquadro alinhamento aro móvel	12
30 96 00 08	Jogo topos inversor	2
30 96 00 15	Esquadro alinhamento aro móvel	12
30 96 00 36	Esquadro aro móvel porta	12
30 96 00 46	Esquadro alinhamento exterior aro porta	12
---	Kit harmónio (3+0)	1
30 92 01 50	União topo porta	2
30 92 01 20	Jogo fecho C.E.	1
30 96 00 35	Canto vulcanizado	4
30 96 00 02	Junta exterior	2L+6H
30 96 00 03	Junta central	2L+4H
30 93 01 20	Junta interior	2L+6H
---	Junta exterior vidro	2L+2H
---	Junta interior vidro	2L+2H

Vidro

Hv = consultar	Lv Folha 1 = consultar	
	Lv Folha 2 = consultar	
	Mínimo	Máximo
Largura da folha	600 mm	900 mm
Altura da folha	850 mm	2400 mm
Peso máximo por folha 80 kg		

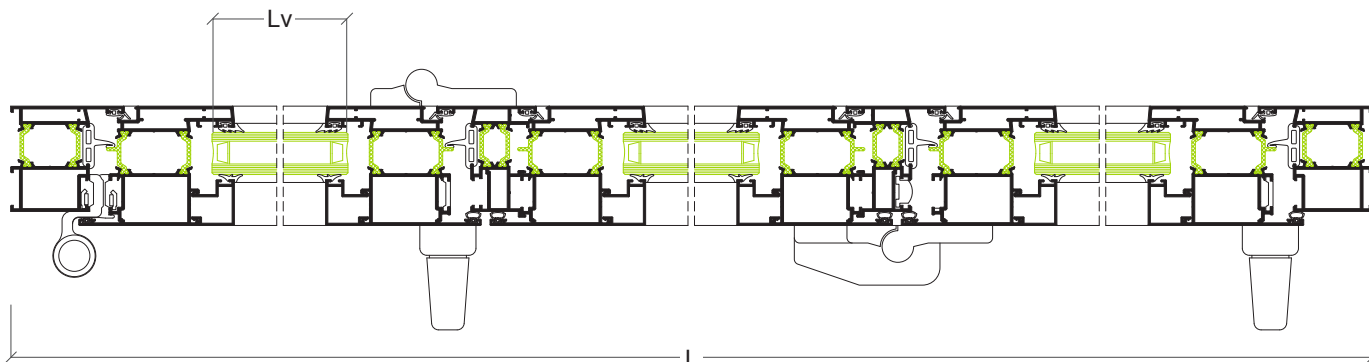

Janela 1 folha abrir e oscilo-batente

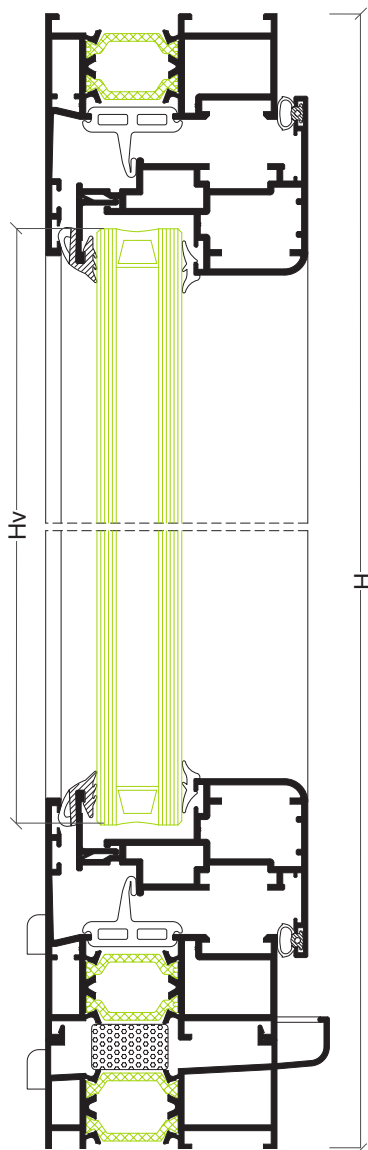
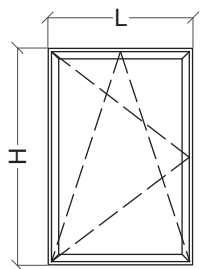

Perfis

Desenho	Ref	Descrição	Corte	Quant	Medida
	ARi-43	Aro fixo folha oculta		2	L
				2	H-28.5 mm
	ARi-45	Aro móvel folha oculta		2	L-43 mm
				2	H-71.5 mm
	ARi-47	Bite folha oculta		2	L-94 mm
				2	H-122.5 mm
	CT-11	Soleira condensação		1	L
	AX-19	Vareta		1+1	L+H

Acessórios e Juntas

Referência	Descrição	Quantidade	
		Abrir	Oscilo-batente
30 92 00 20	Dobradiças C.E.	2	---
30 92 01 00	Goteiras	4	4
30 92 02 XX	Compasso O.B.	---	1
30 92 02 20	Kit oscilo-batente	---	1
30 92 02 60	Apoio da folha	1	---
30 92 03 10	Kit cremone	1	---
30 96 00 04	Esquadro janela	8	8
30 96 00 48	Esquadro alinhamento aro fixo	4	4
30 96 00 12	Jogo topos condensação	1	1
30 96 00 23	Esquadro alinhamento aro fixo	4	4
30 96 00 24	Esquadro alinhamento aro móvel	4	4
30 96 00 22	Esquadro alinhamento interior móvel	4	4
30 96 00 35	Canto vulcanizado	4	4
30 92 04 70	Espuma isolante	L	
30 96 00 27	Junta exterior folha oculta	2L+2H	
30 96 00 03	Junta central	2L+2H	
30 93 01 20	Junta interior	2L+2H	
---	Junta interior vidro	2L+2H	

91

Vidro

Hv = H-139 mm	Lv = L-110 mm
---------------	---------------

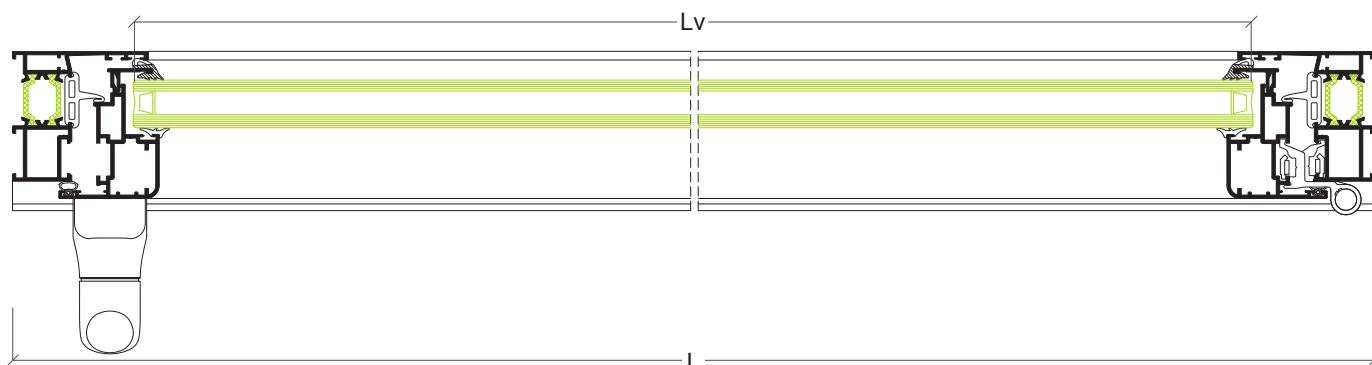

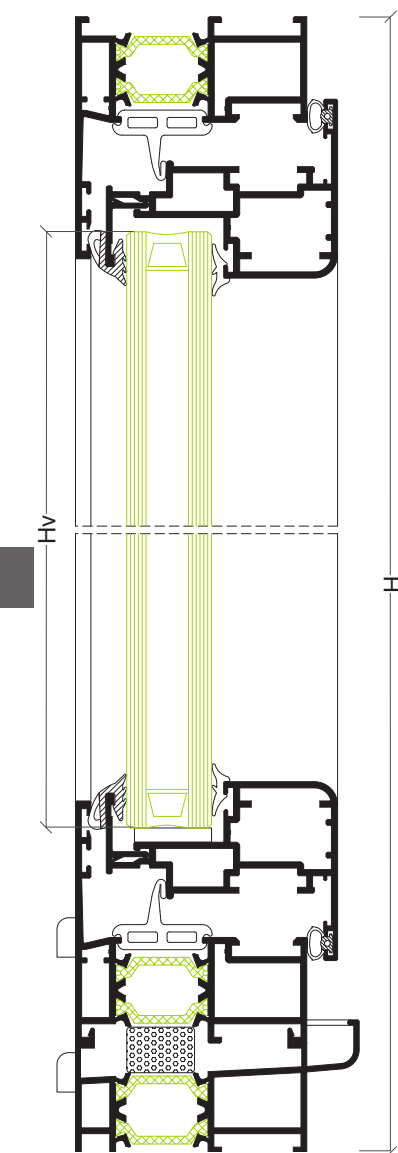
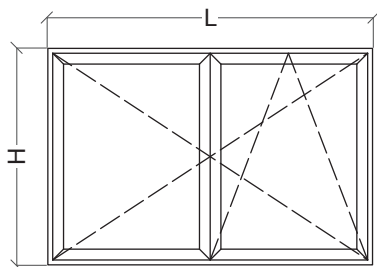
Janela 2 folhas abrir e oscilo-batente

Perfis

Desenho	Ref	Descrição	Corte	Quant	Medida
	ARi-43	Aro fixo folha oculta		2	L
				2	H-28.5 mm
	ARi-45	Aro móvel folha oculta		4	L/2-12 mm
				3	H-71.5 mm
	ARi-46	Complemento aro móvel inversor		1	H-159.5 mm
	ARi-44	Aro móvel		1	H-95.5 mm
	ARi-47	Bite folha oculta		4	L/2-63.5 mm
				3	H-122.5 mm
	CT-11	Soleira condensação		1	L
	AX-19	Vareta		1+1	L+H

Acessórios e Juntas

Referência	Descrição	Quantidade	
		Abrir	Oscilo-batente
30 92 00 20	Dobradiças C.E.	4	---
30 92 01 00	Goteiras	4	4
30 92 01 20	Jogo fecho C.E.	1	---
30 92 02 XX	Compasso O.B.	---	1
30 92 02 20	Kit oscilo-batente	---	1
30 92 02 24	Kit 2ª folha oscilo-batente	---	1
30 92 02 60	Apoio da folha	1	---
30 92 03 10	Kit cremone	1	---
30 96 00 04	Esquadro janela	12	12
30 96 00 48	Esquadro alinhamento aro fixo	4	4
30 96 00 12	Jogo topos condensação	1	1
30 96 00 23	Esquadro alinhamento aro fixo	4	4
30 96 00 24	Esquadro alinhamento aro móvel	8	8
30 96 00 22	Esquadro alinhamento interior móvel	4	4
30 96 00 26	Jogo topos inversor	1	1
30 96 00 35	Canto vulcanizado	4	4
30 92 04 70	Espuma isolante	L	
30 96 00 27	Junta exterior folha oculta	2L+4H	
30 96 00 03	Junta central	2L+3H	
30 93 01 20	Junta interior	2L+3H	
---	Junta interior vidro	2L+4H	

Vidro

Hv = H-139 mm	Lv = L/2-79 mm
---------------	----------------

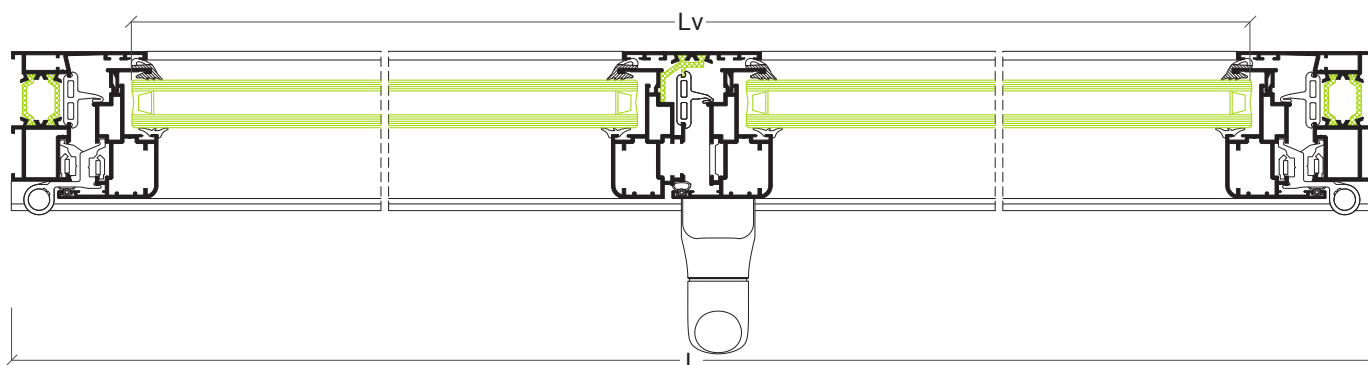

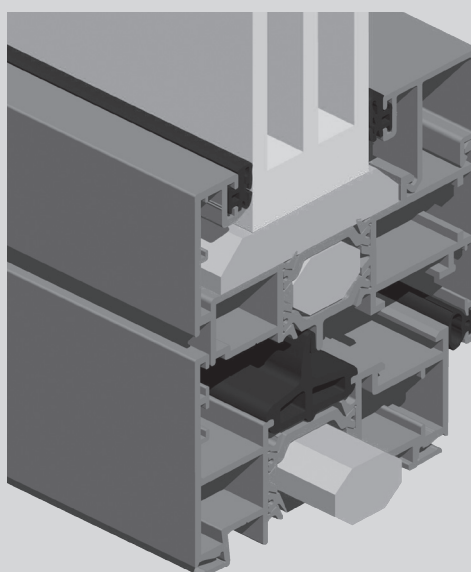
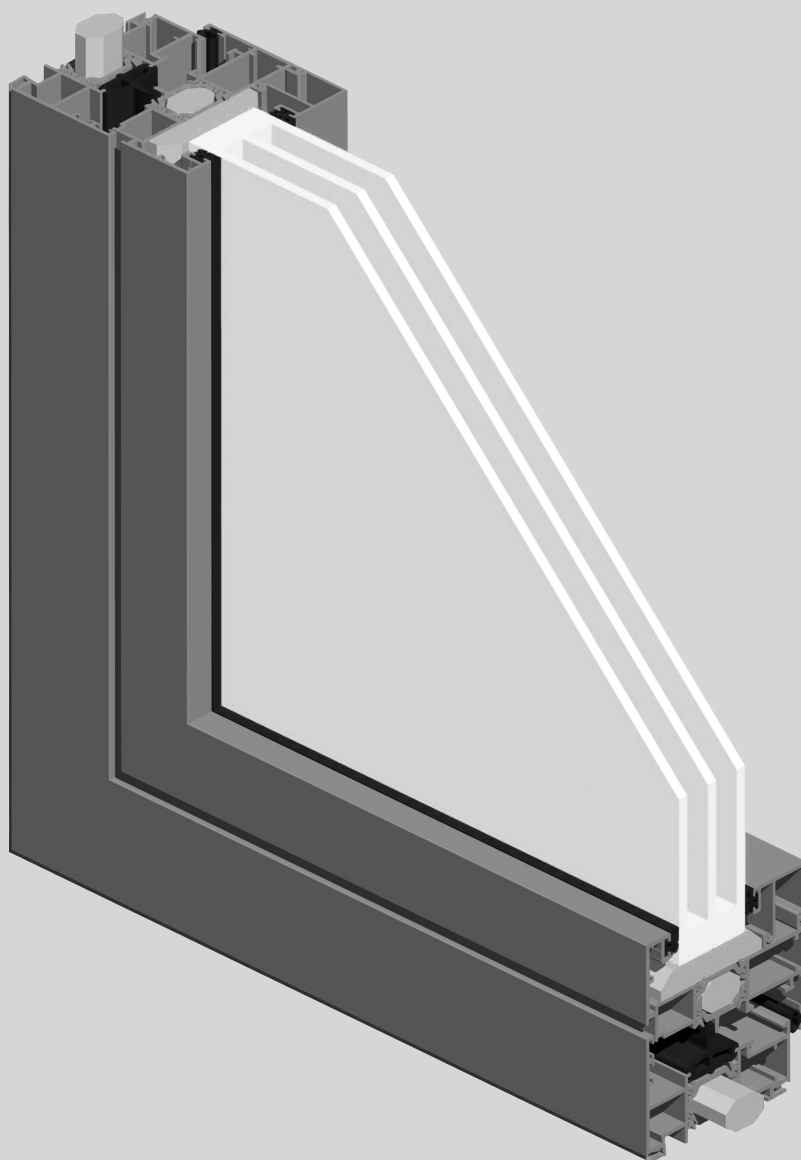

Sistema
AJi

Sistema AJi

Sistema de batente com RPT - 70 mm

Características do sistema

Sistema de batente com rotura térmica de elevadas prestações térmicas e acústicas.

O sistema AJi possibilita a execução de 3 versões de caixilharia:

1. Linha recta;
2. Linha curva;
3. Linha oval.

O sistema AJi permite a aplicação de vidros duplos ou triplos de alto rendimento de modo a responder às exigências de isolamento térmico e acústico.

Com um óptimo isolamento térmico aliado à aplicação de um inovador produto designado por bagueete ThermoProfile, o Sistema AJi proporciona elevadas prestações de conforto e de economia energética.

Perfis de alumínio

Os perfis de alumínio são extrudidos na liga de alumínio 6060 para arquitectura de acordo com norma NP EN 12020-02.

Rotura térmica obtida por inserção de varetas isolantes de poliamida tipo ómega de 24 mm reforçadas com 25% de fibra de vidro. Espessura média dos perfis de alumínio de 1.7 mm.

Aros fixos

Secção dos aros fixos de 70 mm com tripla câmara;

Perfis com rotura térmica com varetas de poliamida tipo ómega de 24 mm;

Aros fixos com duplo esquadro de aperto rápido e esquadros de alinhamento para montagem a meia esquadria;

Travessas com dupla união para um aperto mais eficaz;

Aros fixos tradicionais para o mercado interno;

Aros fixos com clip exterior e aba de remate directa de 25 mm ou 45 mm para o mercado francês;

Aro fixo com clip exterior e interior para aplicação de remate de 30, 50 ou 80 mm para o mercado francês;

Aro fixo de ligação ao sistema de correr com rotura térmica CW.

Aros móveis

Secção dos aros móveis de 78 mm com tripla câmara;

Aros móveis com rotura térmica através de varetas de poliamidas tipo ómega de 24 mm;

Aros móveis com duplo esquadro de aperto rápido e esquadros de alinhamento para montagem a meia esquadria;

Perfil inversor com olhal para uma melhor aplicação do topo inversor.

Dimensionamento e manobralidade

Dimensões mínimas - máximas de folha: 340 mm - 1700 mm (L); 340 mm - 3000 mm (H);

Peso máximo para janelas ou portas de sacada com oscilo-batente até 170 Kg;

Peso máximo para portas de entrada até 160 Kg/folha;

Possibilidades de abertura: fixo, batente interior 1 ou 2 folhas com ou sem oscilo-batente, batente exterior, basculante, projectante, hármonio e oscilo-paralela;

Solução de perfil para portas pedonais ou de sacada de abertura interior ou exterior segundo norma PMR (pessoas com mobilidade reduzida);

Enchimento para vidro duplo ou triplo desde 20 mm até 55 mm;

Estanquidade assegurada através de juntas duplas em EPDM (interior e central).

Performances

Sistema certificado por laboratório notificado para Ensaios Tipo Inicial (ITT) de acordo com a norma de produto EN 14351-1 para efeitos de Marcação CE.

Categorias alcançadas na avaliação do sistema AJi:

1. Permeabilidade ao ar: Classe 4 (norma de ensaio EN 1026)
2. Estanquidade à água: Classe E900 (norma de ensaio EN 1027)
3. Resistência ao vento: Classe C5 (norma de ensaio EN 12211)

Coefficiente de transmissão térmica de vão de 2 folhas com 1.20 m x 1.50 m com vidro $U_g = 0.5 \text{ W/m}^2\text{K}$ com intercalar efeito "Warm Edge":

• $U_w = 1.26 \text{ W/m}^2\text{K}$

Coefficiente de atenuação acústica de vão de 2 folhas:

• $R_w (C ; C_{tr}) = 42 \text{ dB} (-1 ; -4)$

Zonas de aplicação segundo RCCTE (em função do valor U_g) : I1, I2, I3, V1, V2, V3

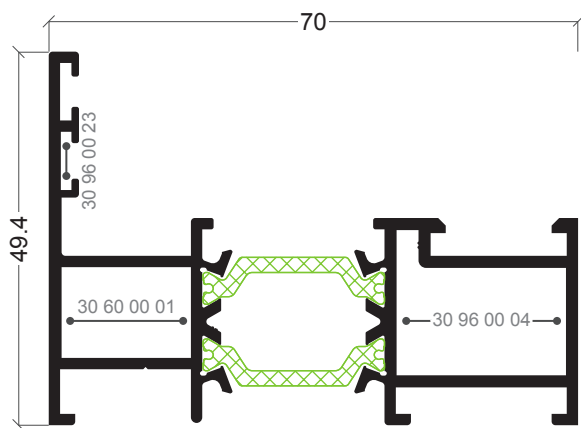

AJi-03
Aro fixo

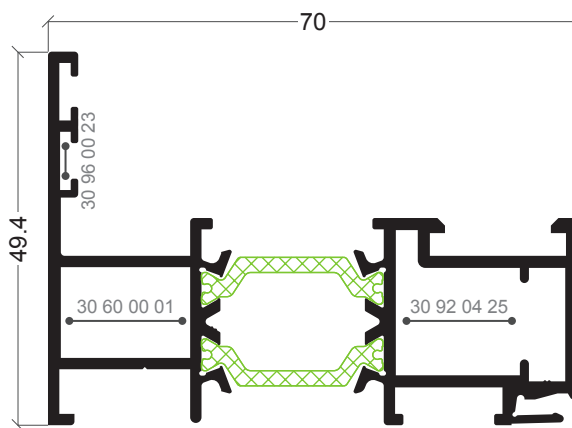

AJi-91
Aro fixo

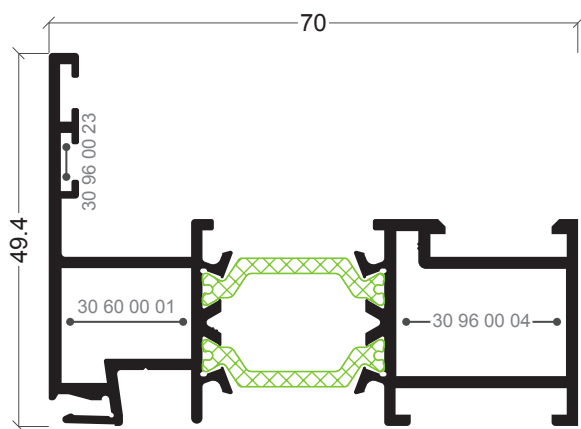

AJi-76
Aro fixo

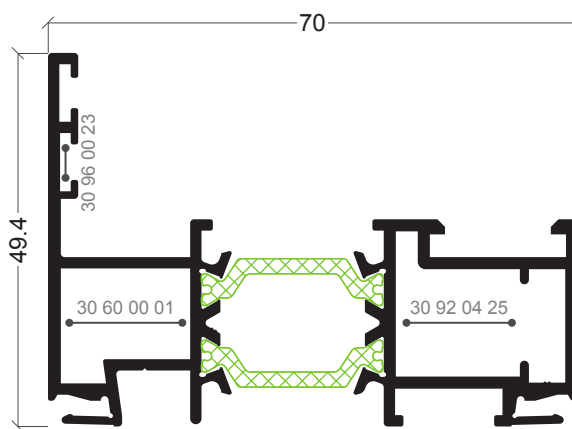

AJi-80
Aro fixo

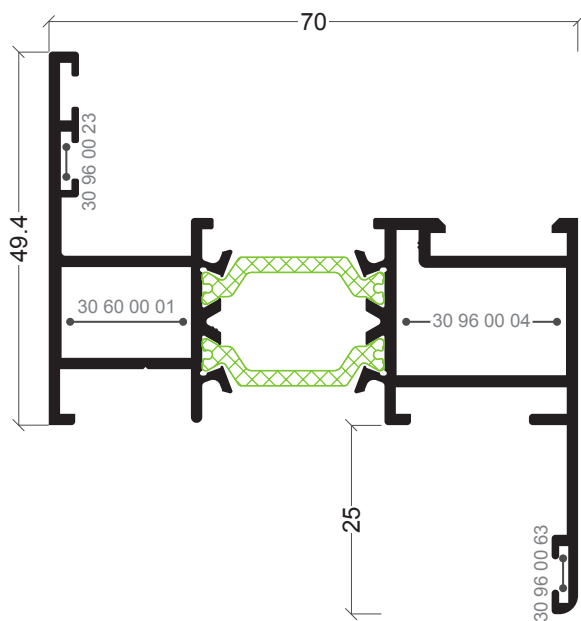

AJi-35
Aro fixo com remate 25 mm

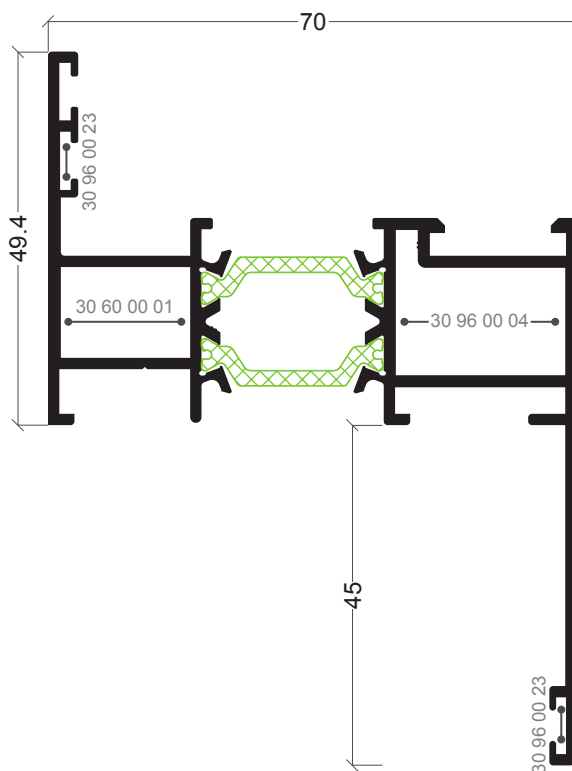

AJi-33
Aro fixo com remate 45 mm

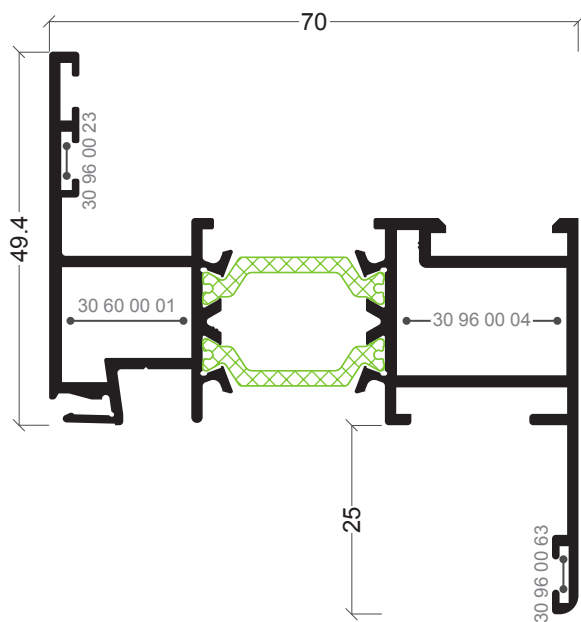

AJi-74
Aro fixo com remate 25 mm

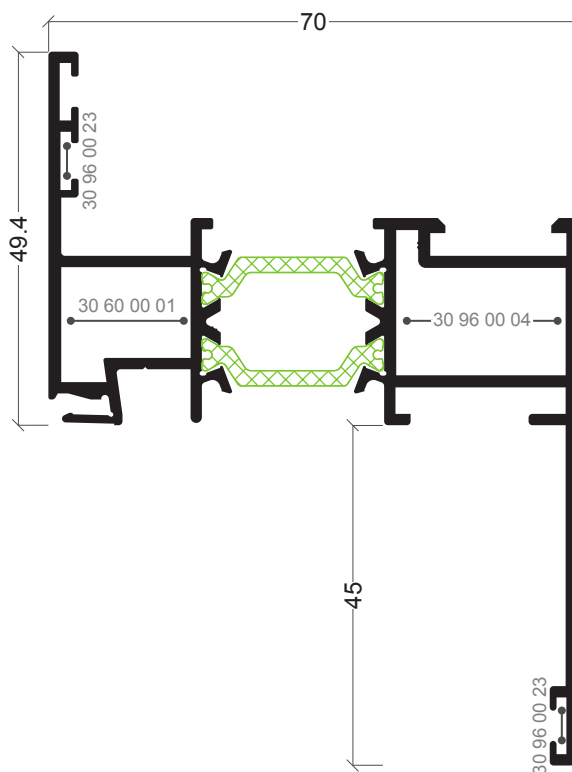

AJi-75
Aro fixo com remate 45 mm

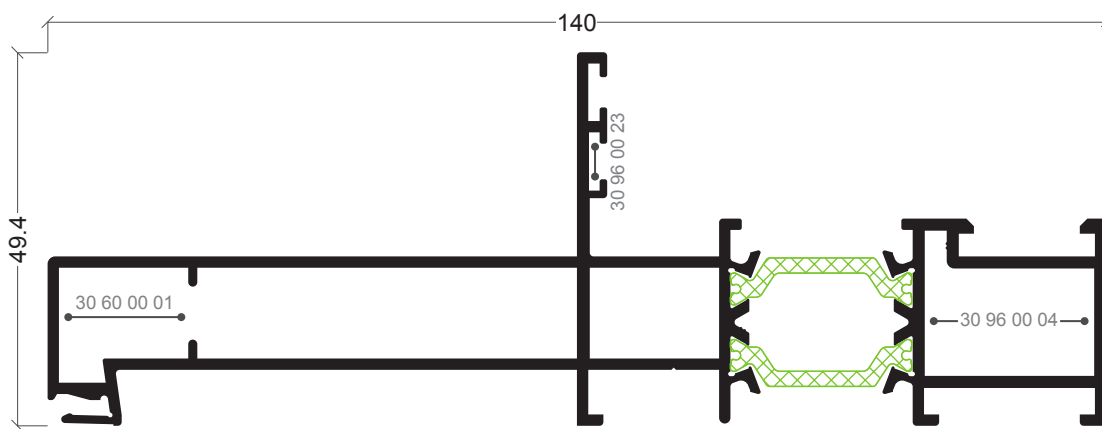

AJi-89
Aro fixo

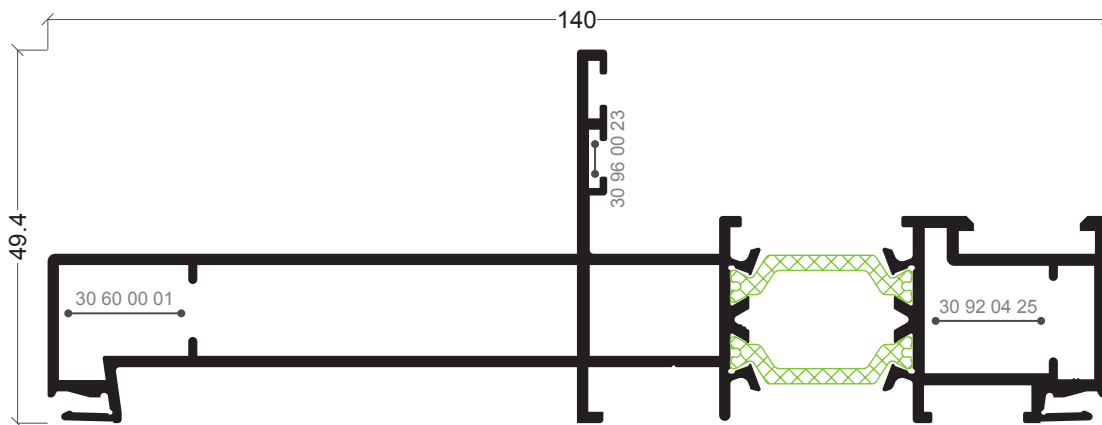

AJi-88
Aro fixo

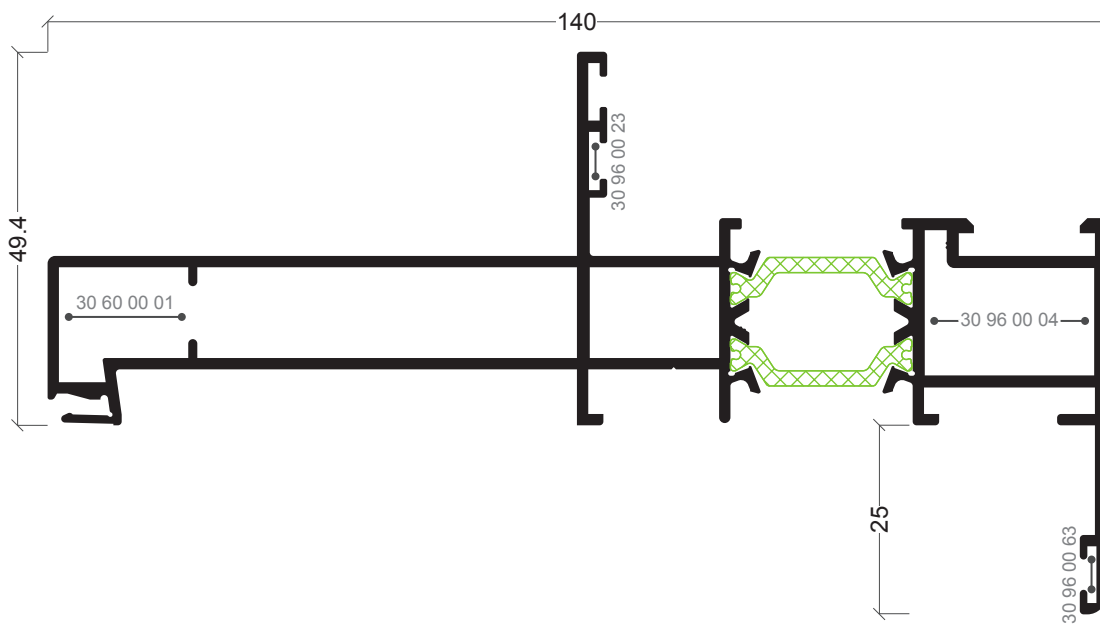

AJi-86
Aro fixo com remate 25 mm

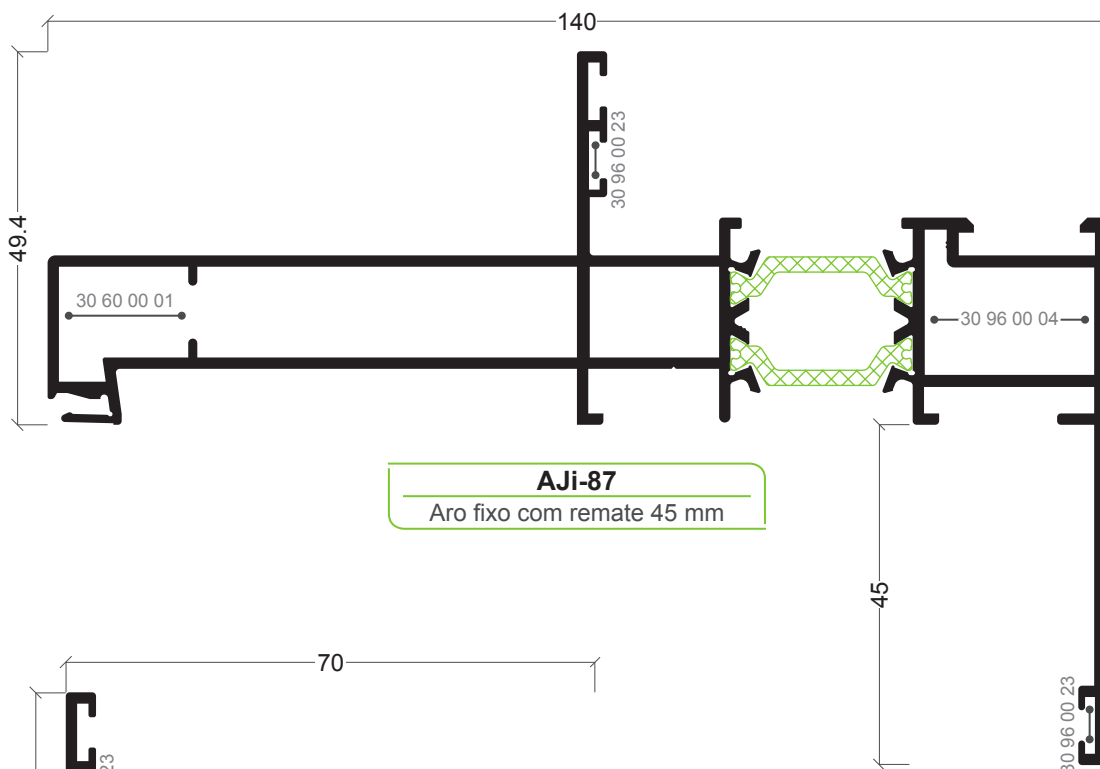

AJi-87
Aro fixo com remate 45 mm

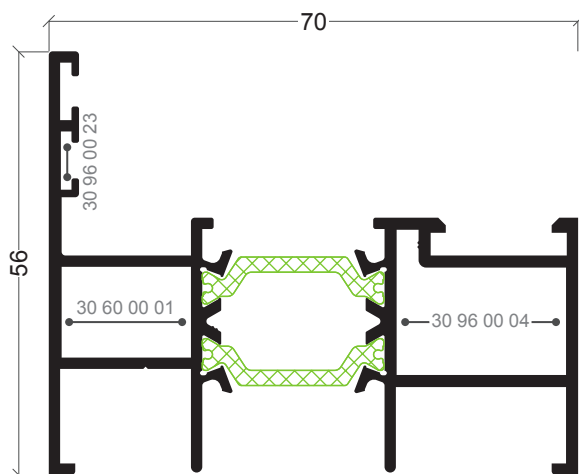

AJi-81
Aro fixo

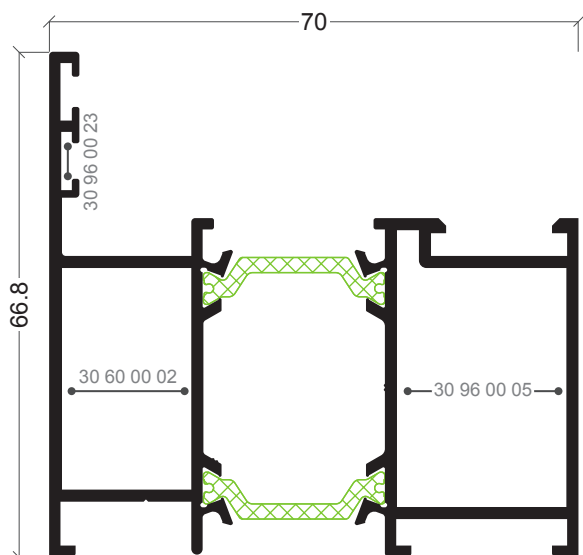

AJi-08
Aro fixo

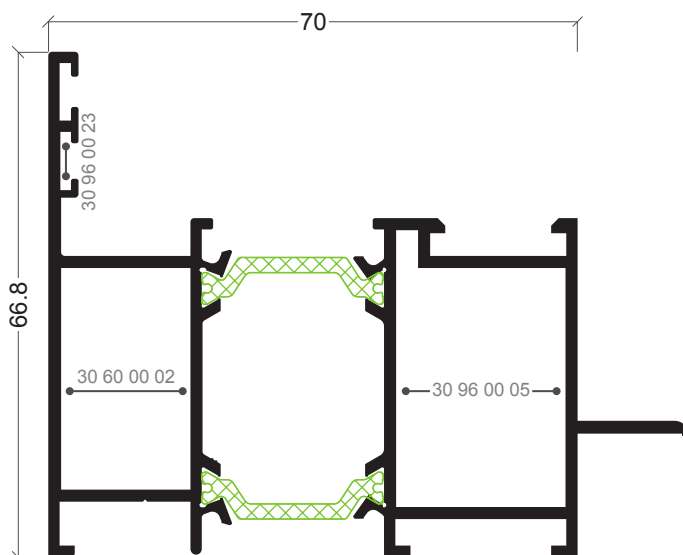

AJi-68
Aro fixo

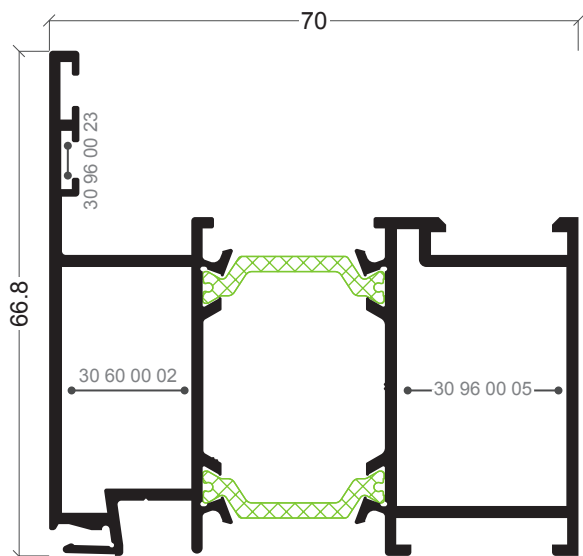

AJi-92
Aro fixo

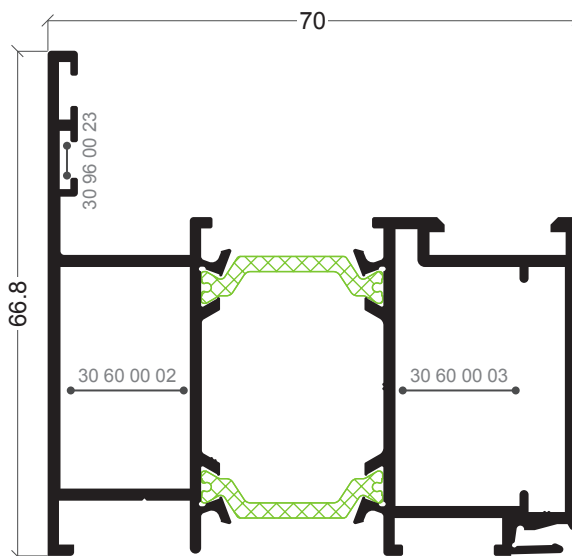

AJi-93
Aro fixo

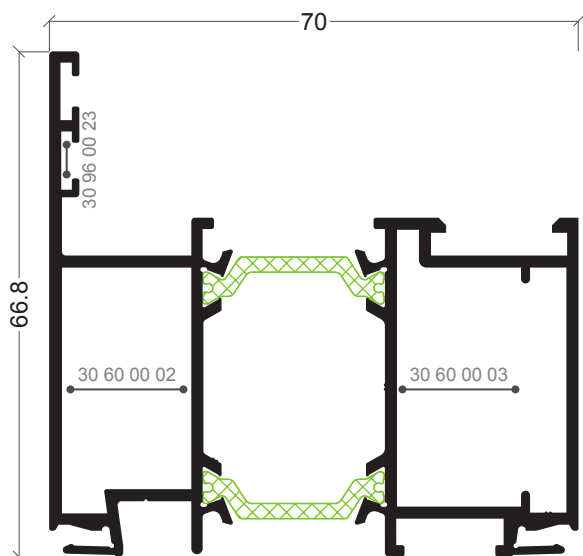

AJi-94
Aro fixo

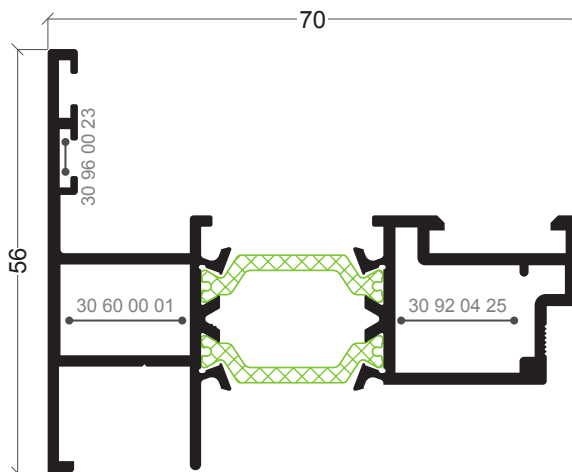

AJi-73
Inversor de sentido de abertura

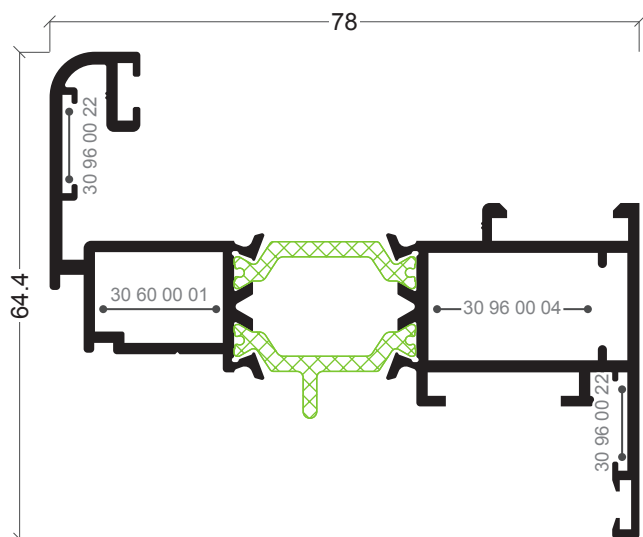

AJi-05
Aro móvil

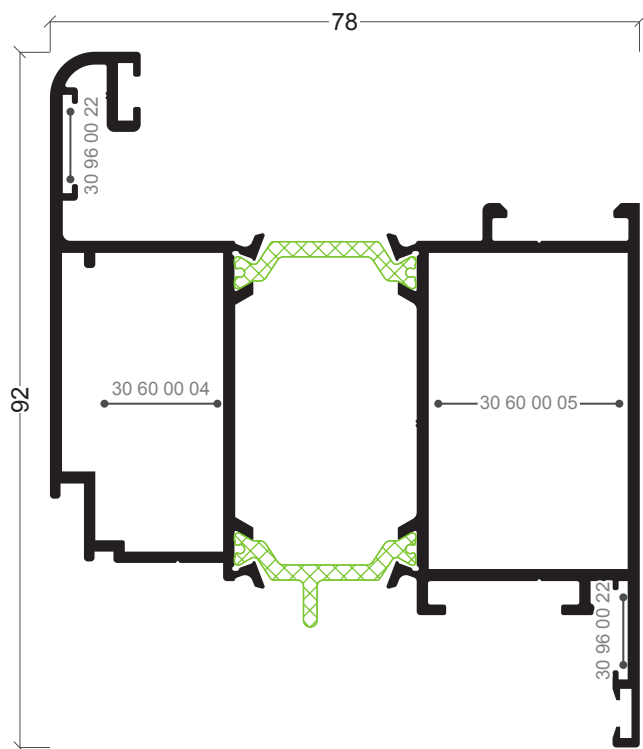

AJi-10
Aro móvil

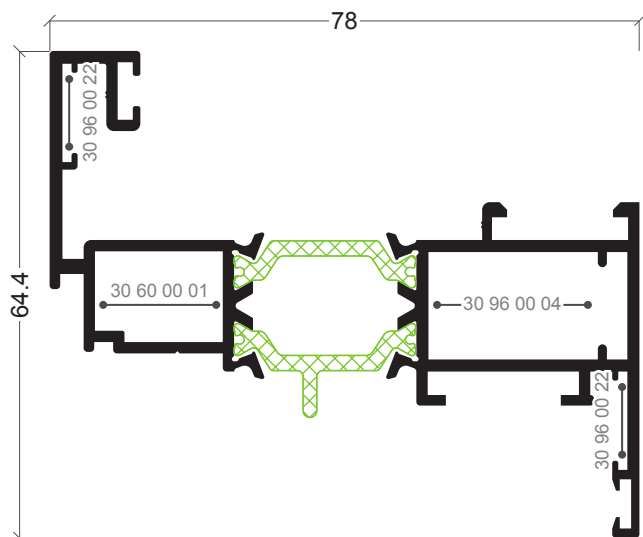

AJi-61
Aro móvil

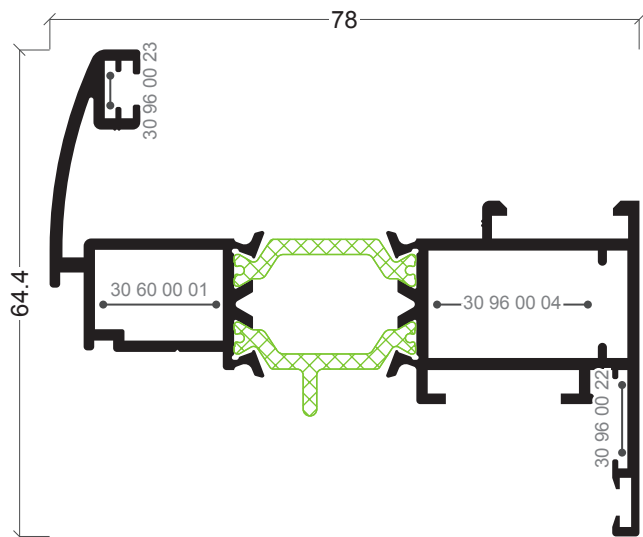

AJi-83
Aro móvil

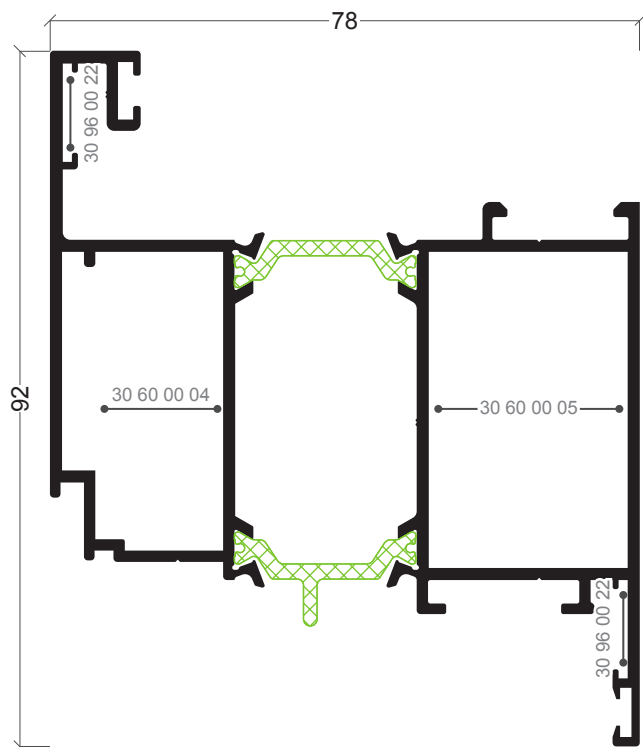

AJi-36
Aro móvil

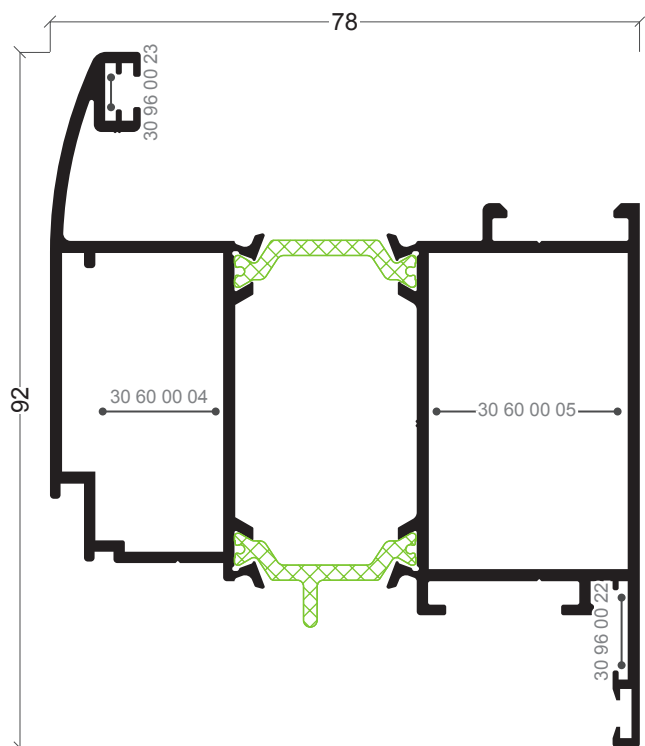

Aji-84
Aro móvel

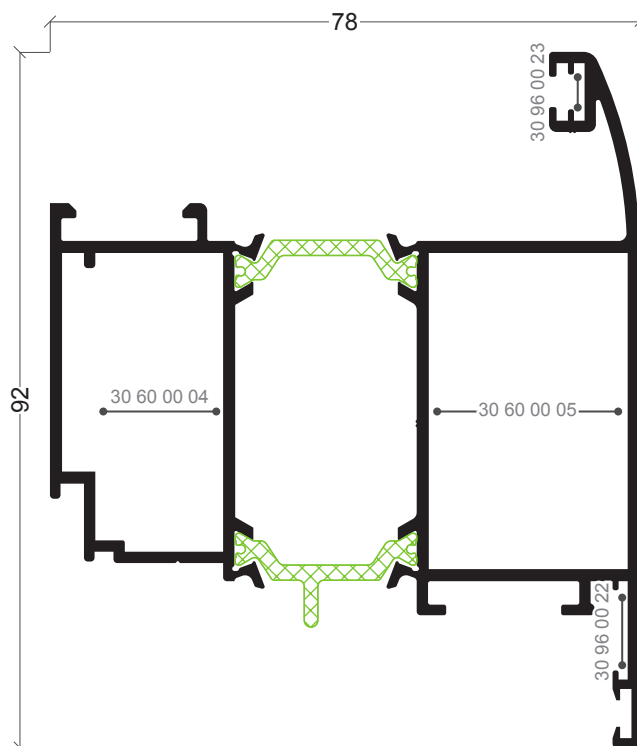

Aji-85
Aro móvel

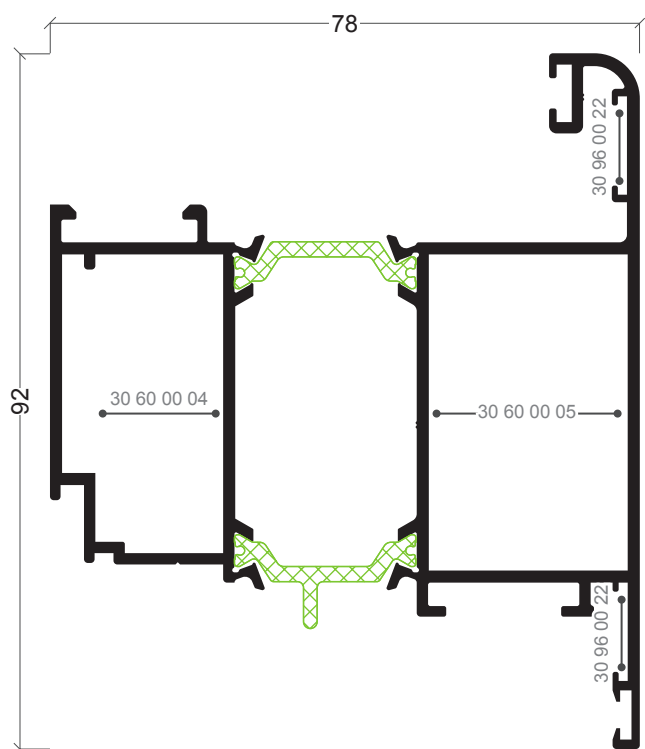

Aji-90
Aro móvel

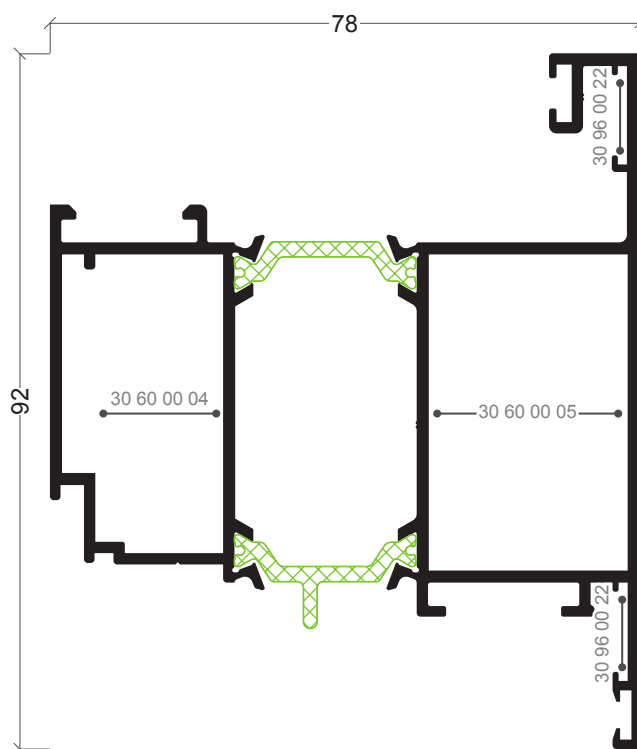

Aji-72
Aro móvel

100

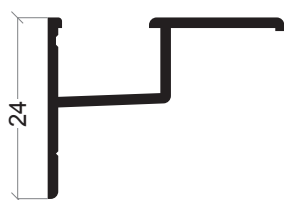

Y-20
Recolha de águas condensação

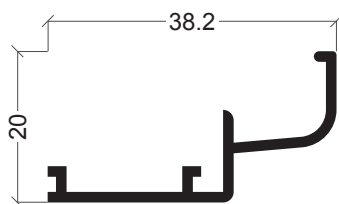

ARi-32
Complemento condensação

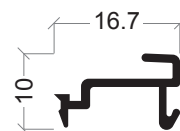

AX-33
Mola Bite

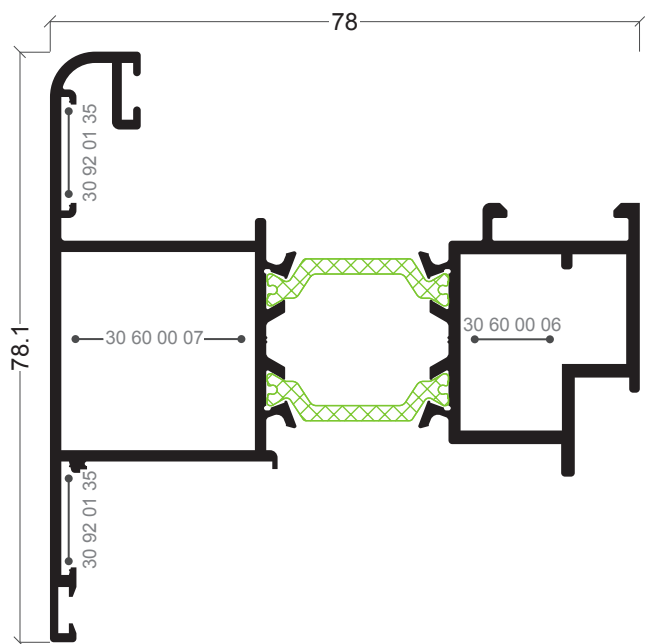

AJi-07
Aro móvel projectante

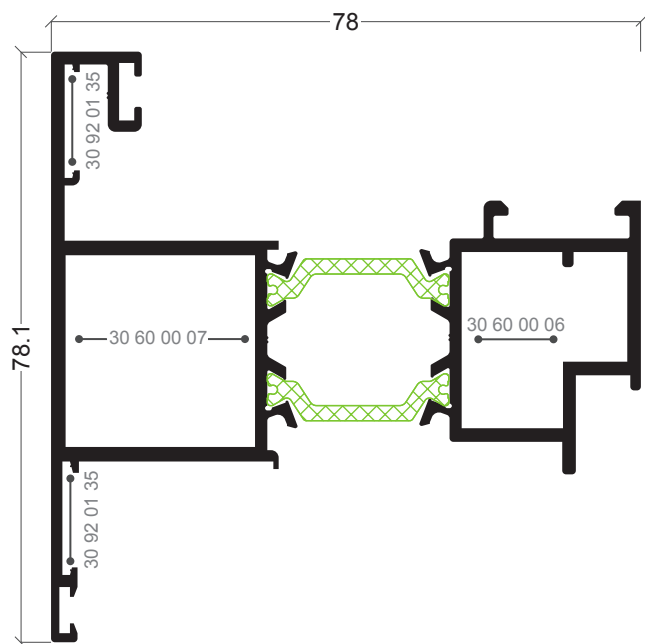

AJi-95
Aro móvel projectante

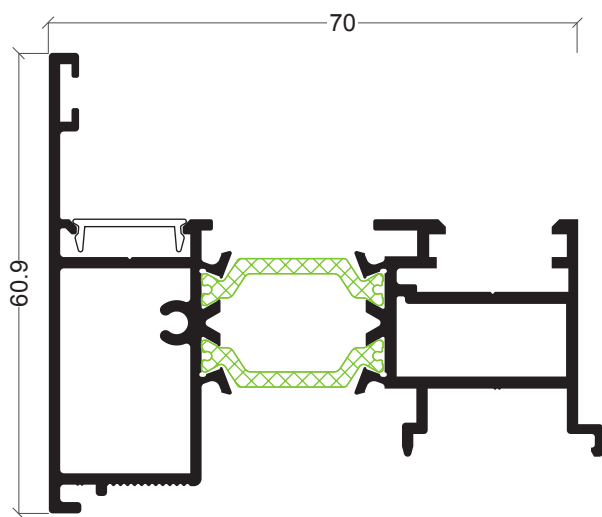

AJi-04
Inversor

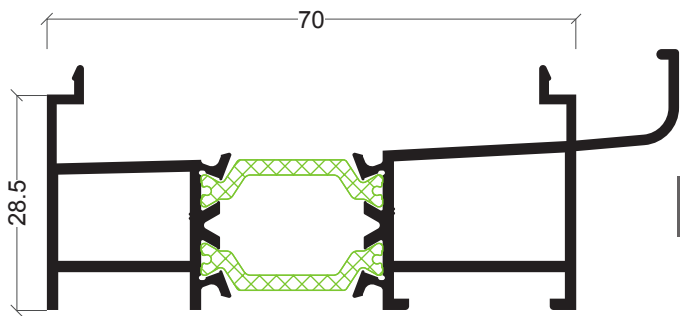

AJi-71
Soleira condensação

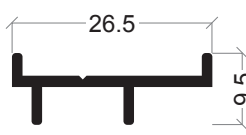

AXi-32
Complemento projectante

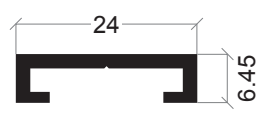

AXi-31
Guia projectante

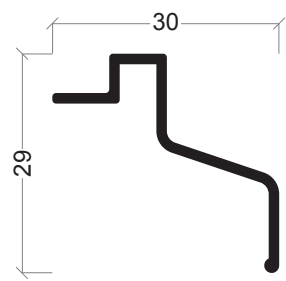

AXi-45
Pingadeira projectante

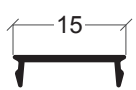

KL-04
Tampa



AX-19
Vareta

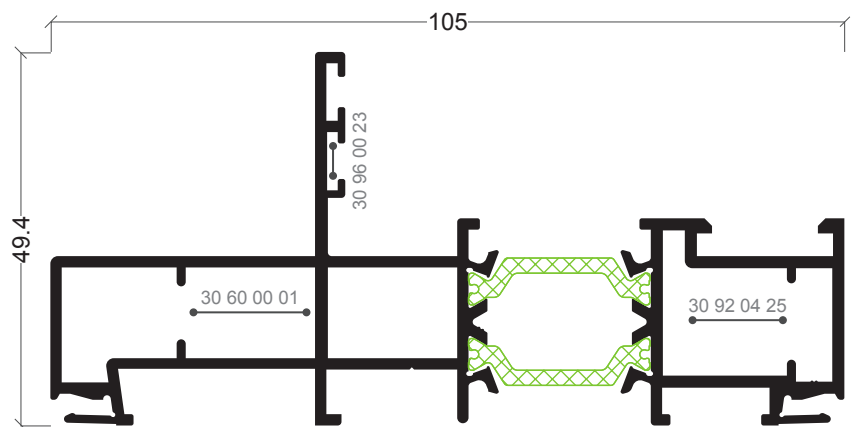

AJi-20
Perfil ligação CW

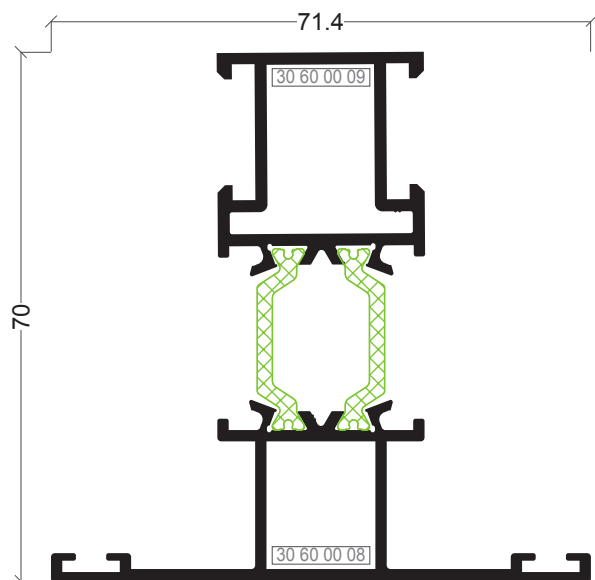

AJi-01
Travessa

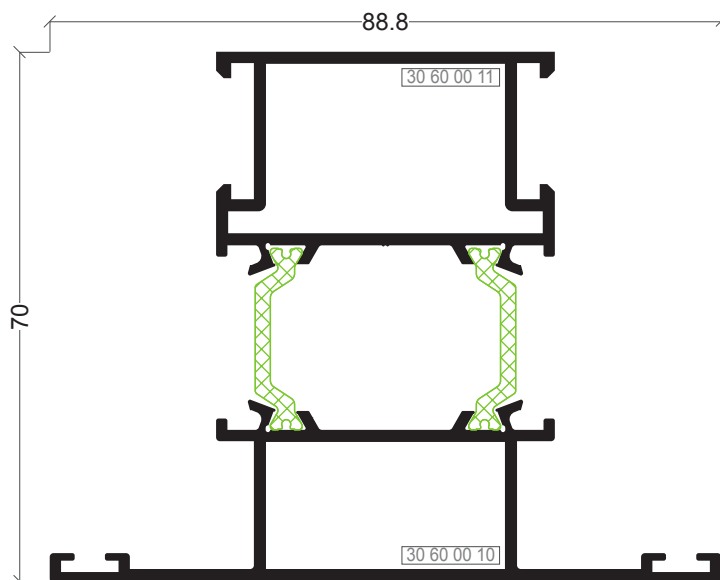

AJi-06
Travessa

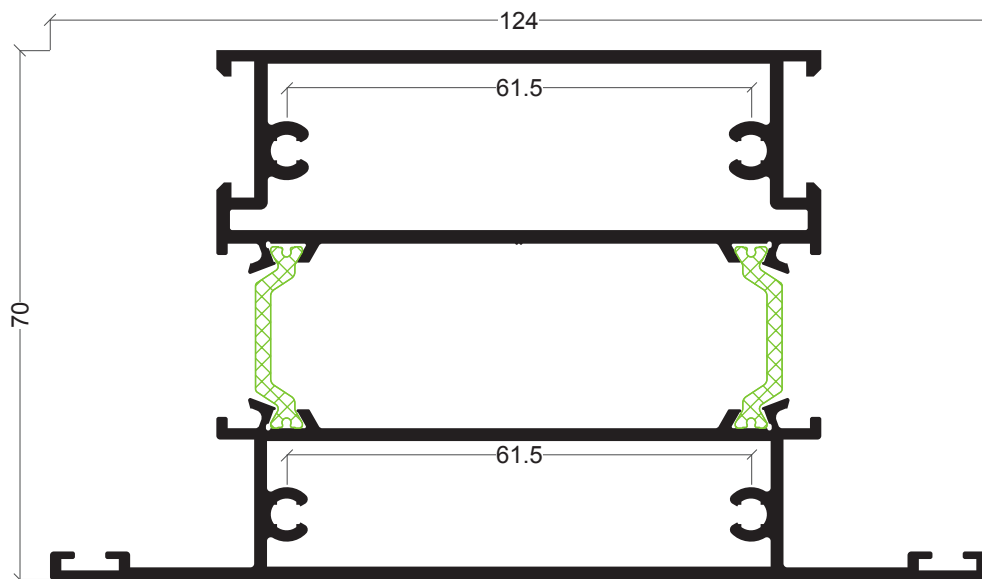

AJi-12
Travessa

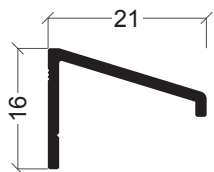

A1-46
Pingadeira janela

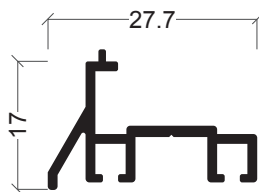

AJi-62
Pingadeira inferior porta sacada

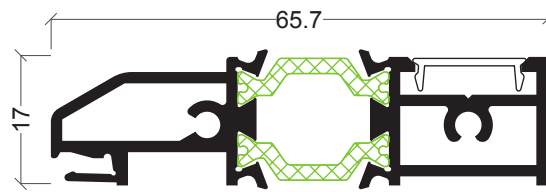

AJi-63
Remate inferior porta

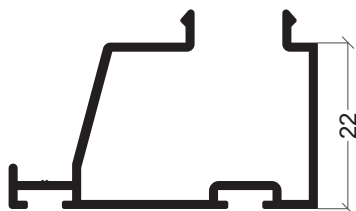

AJi-82
Bite remate

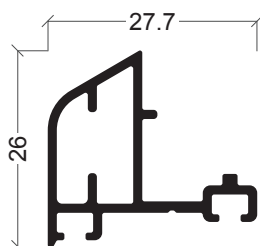

AZ-79
Pingadeira inferior de porta

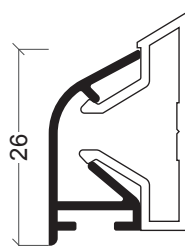

AZ-60
Pingadeira

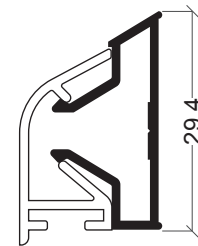

AZ-61
Clip pingadeira

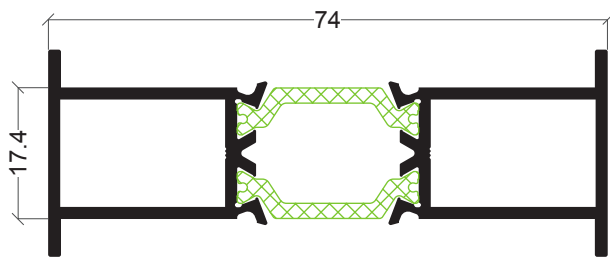

AJi-21
União de aros

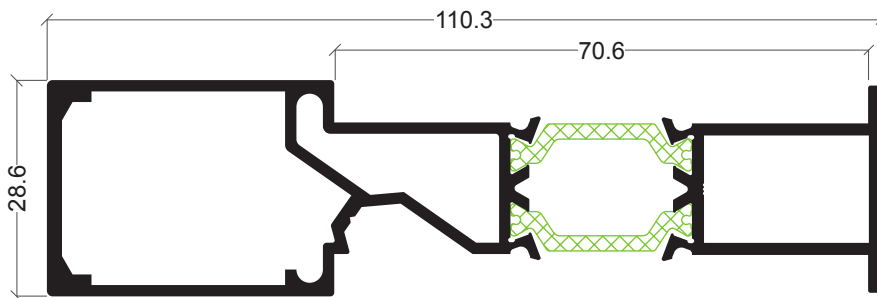

AJi-65
União de aros

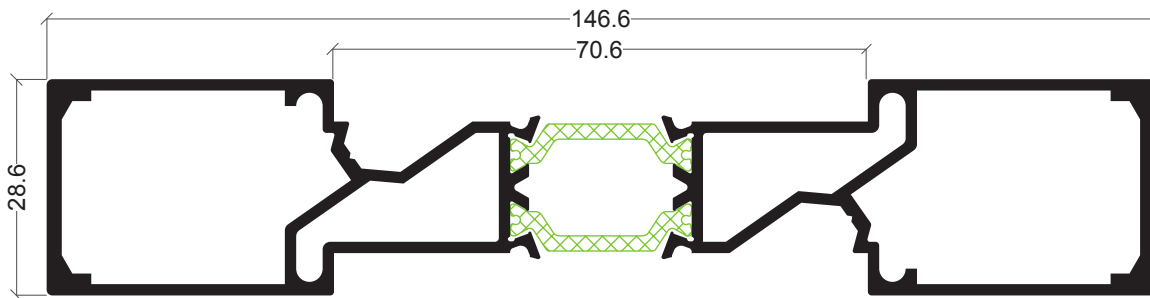

AJi-67
União de aros

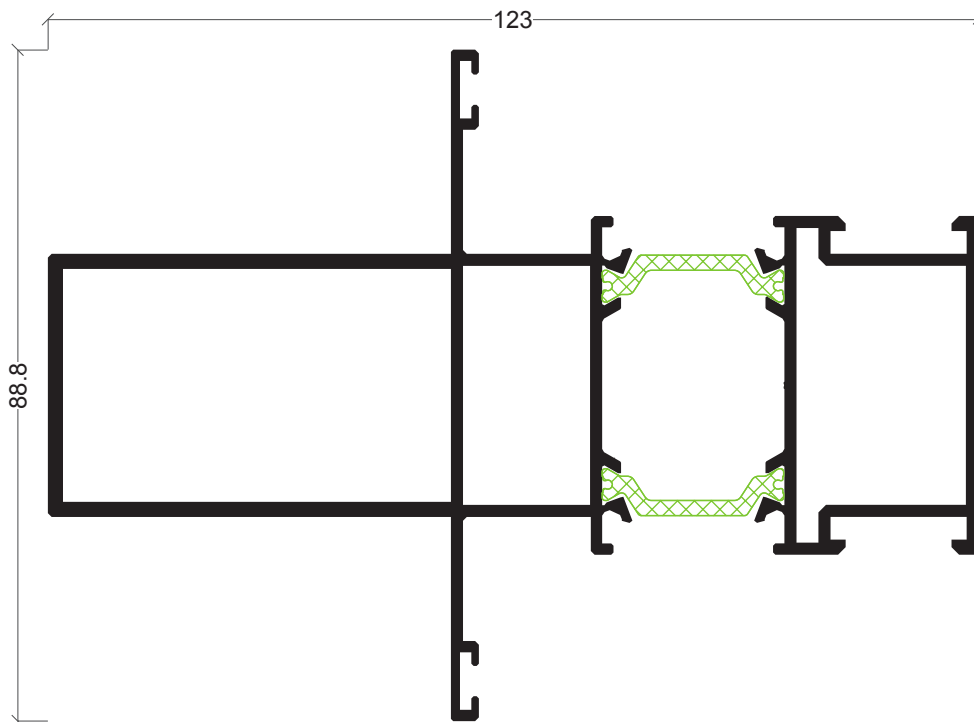

AJi-79
Montante recto

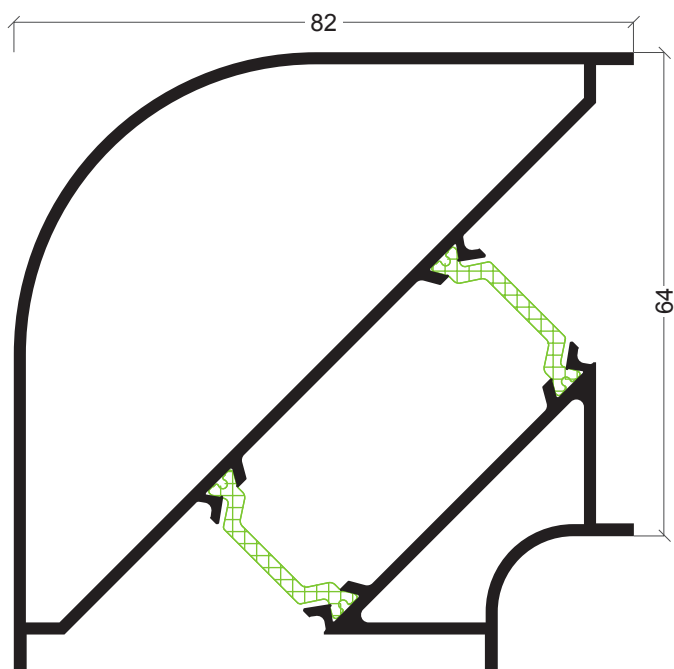

ARI-16
Esquina 90°

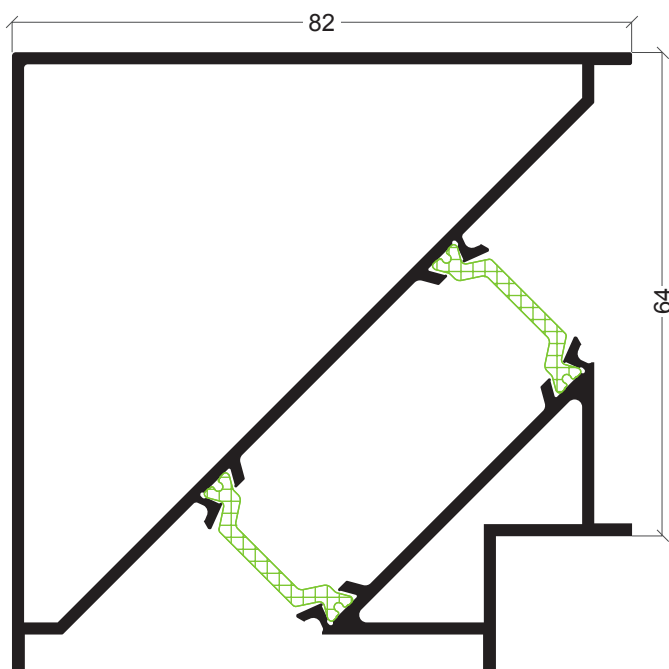

ARI-64
Esquina 90°

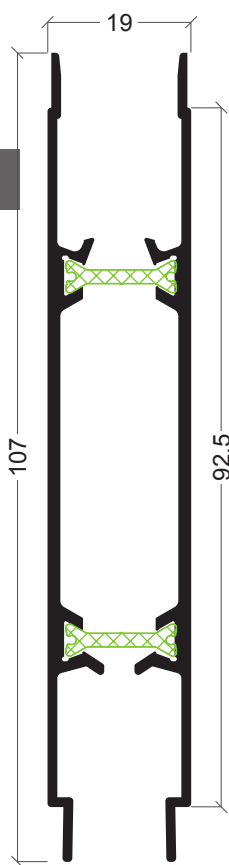

W-15

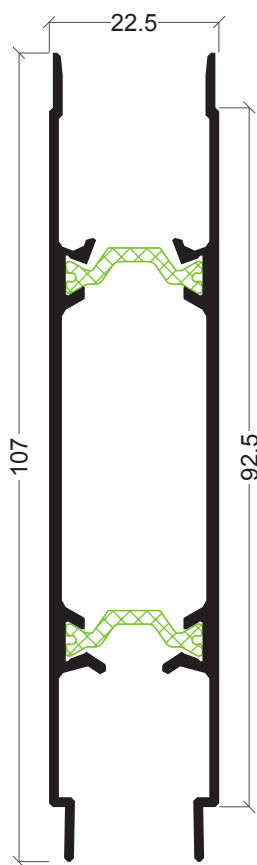

W-18

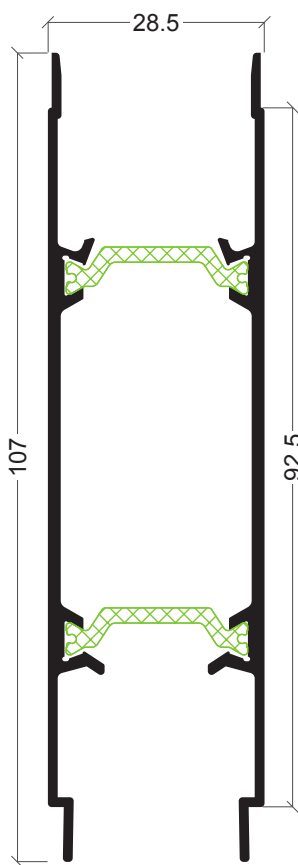

W-20

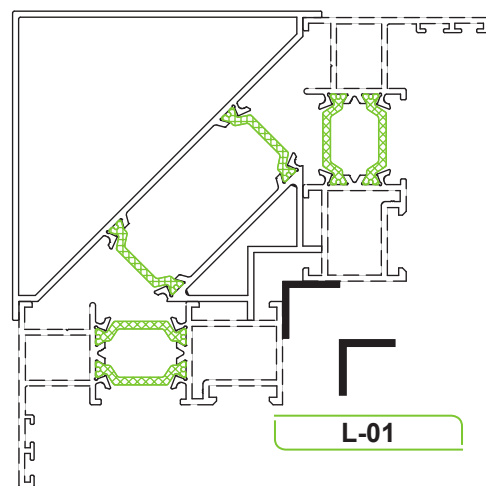

L-01

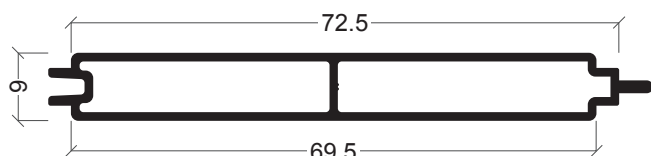

W-23
Régua tapa-luz

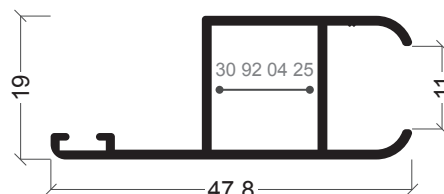

AZ-22
Tapa-luz

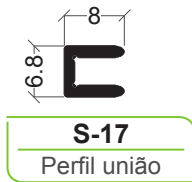
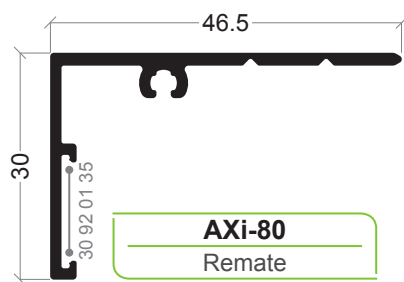
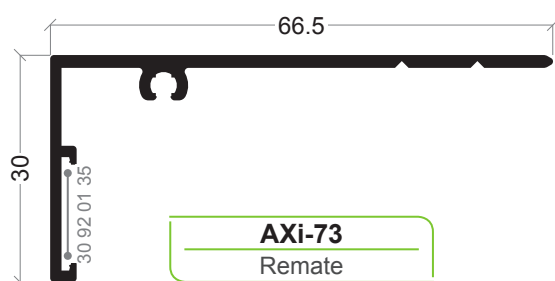
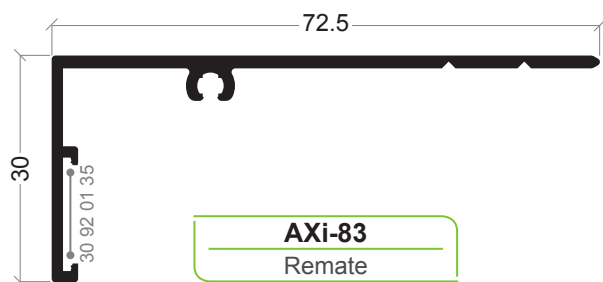
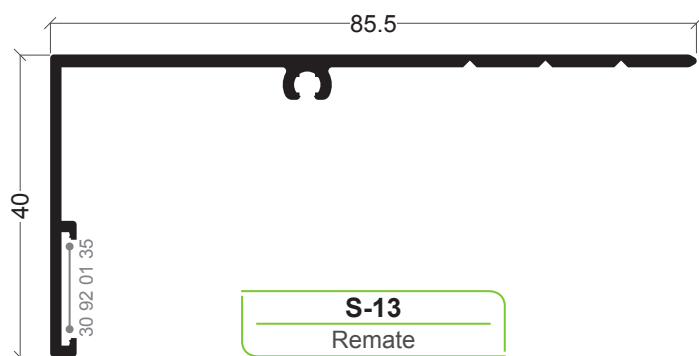
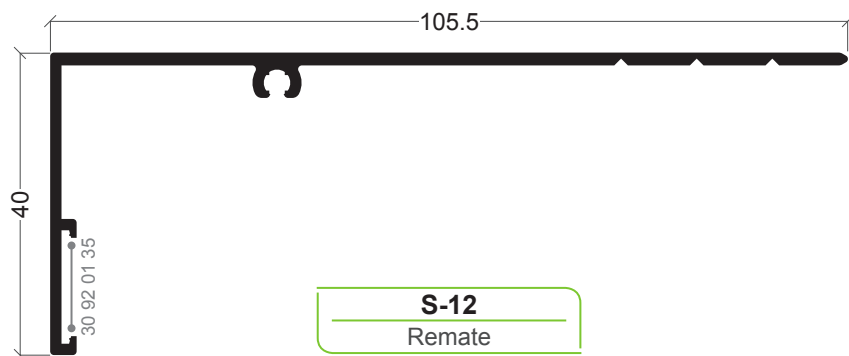
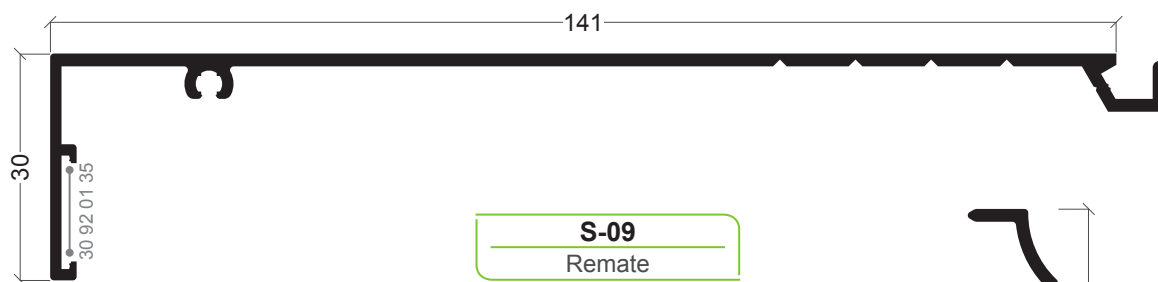

S-18
Remate

S-14
Remate

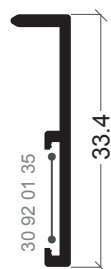

AXi-88
Complemento remate

AXi-91
Complemento remate

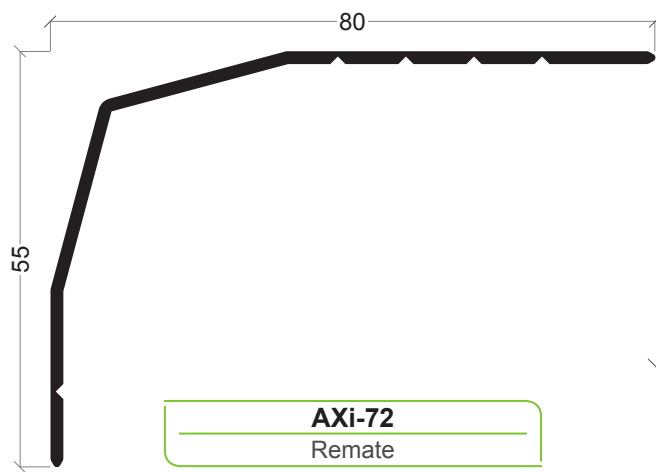

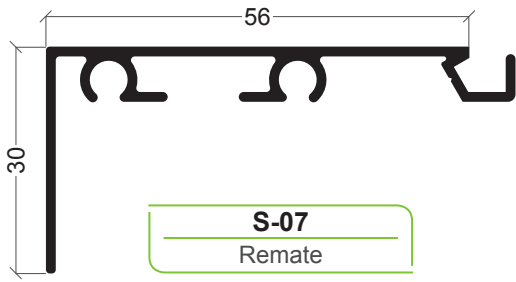

S-07
Remate

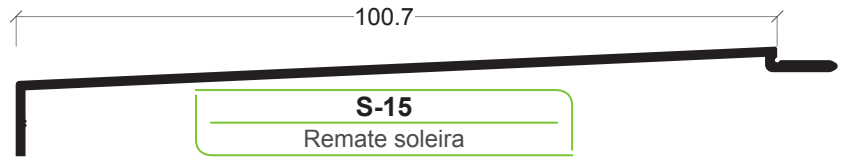

S-15
Remate soleira

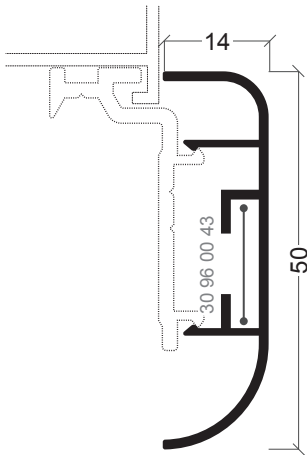

ARi-27
Tapa juntas

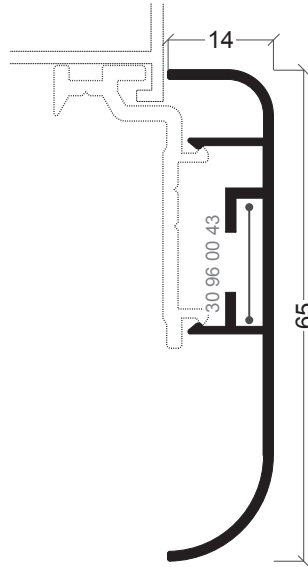

ARi-34
Tapa juntas

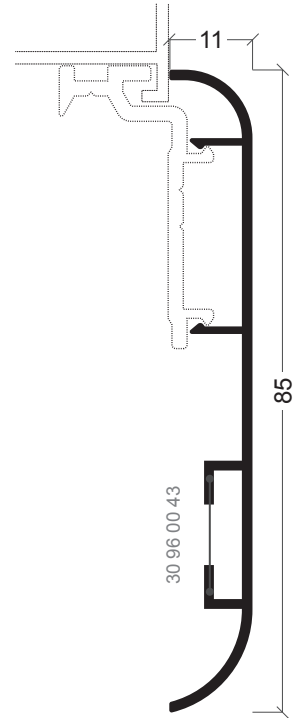

ARi-28
Tapa juntas

106

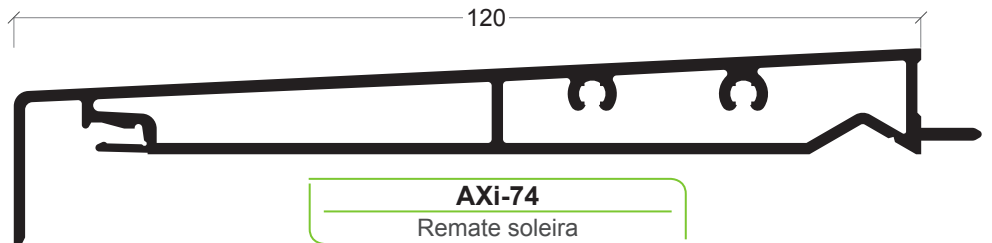

AXi-74
Remate soleira

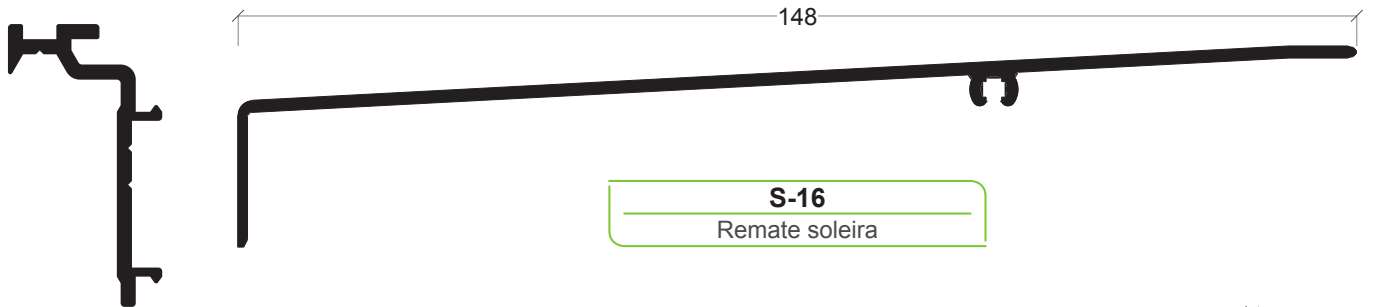

S-16
Remate soleira

ARi-26
Mola tapa juntas



ARi-24
Mola tapa juntas

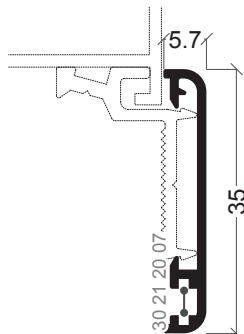

ARi-30
Tapa juntas

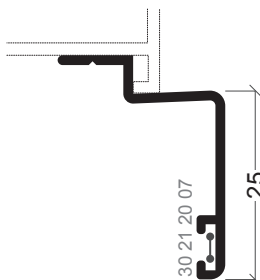

ARi-66
Tapa juntas

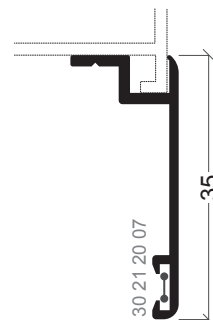

ARi-31
Tapa juntas

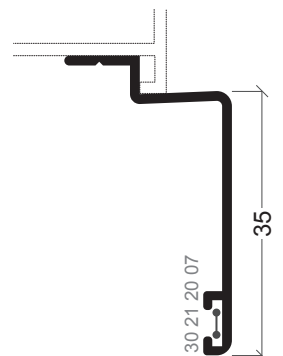

ARi-37
Tapa juntas

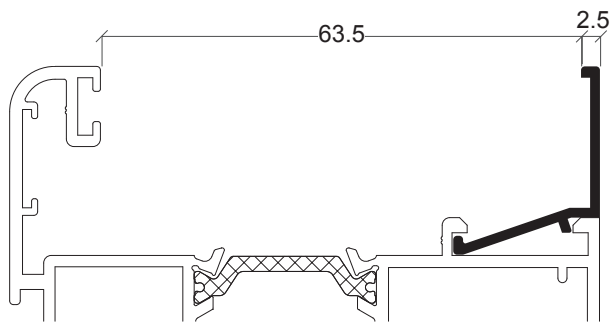

AX-69

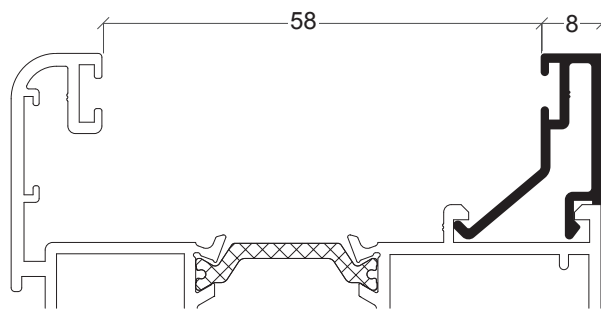

AX-74

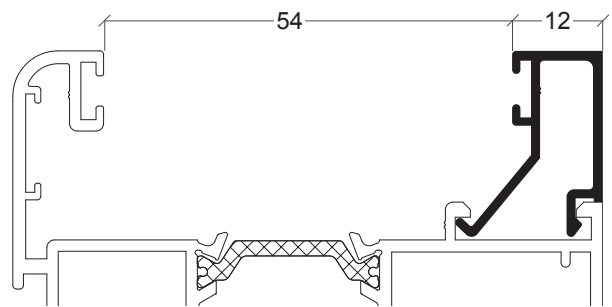

AX-36

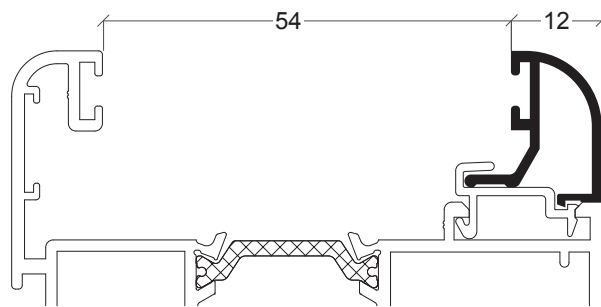

AX-37

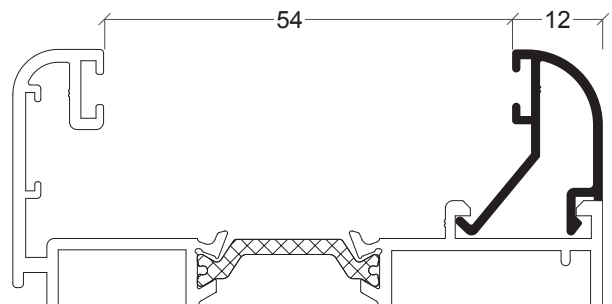

AZ-08

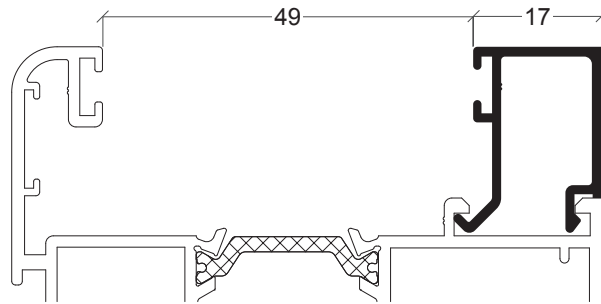

AX-46

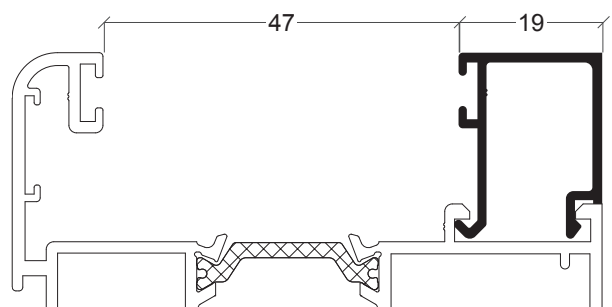

AX-35

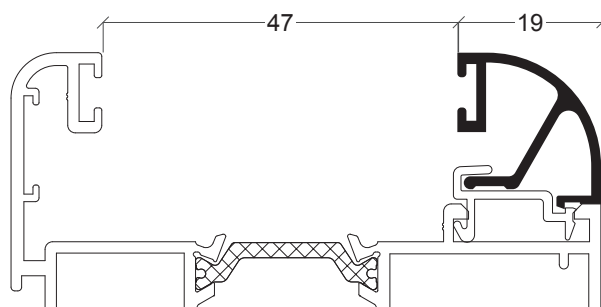

AX-30

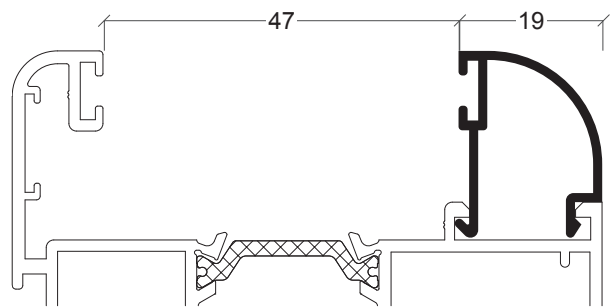

AZ-07

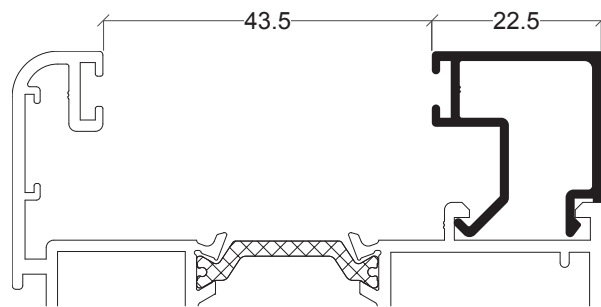

AX-78

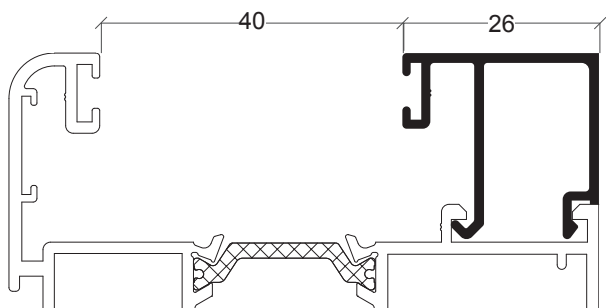

AX-31

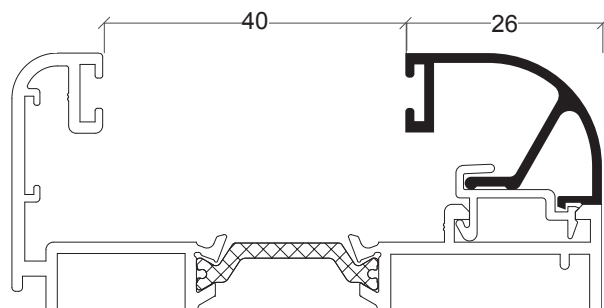

AX-29

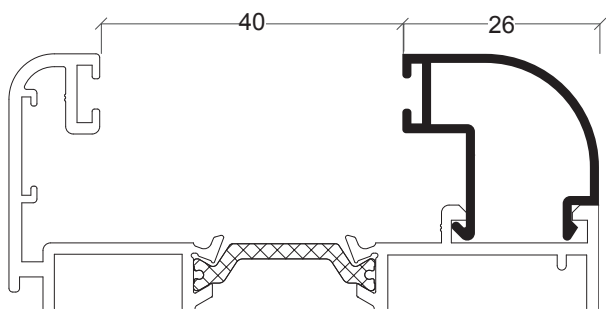

AZ-06

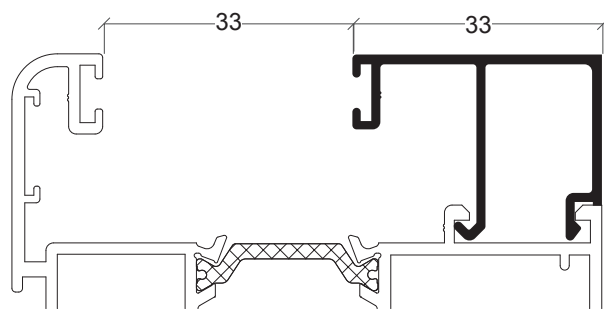

AX-34

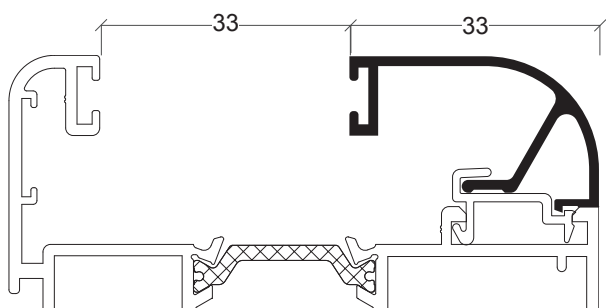

AX-39

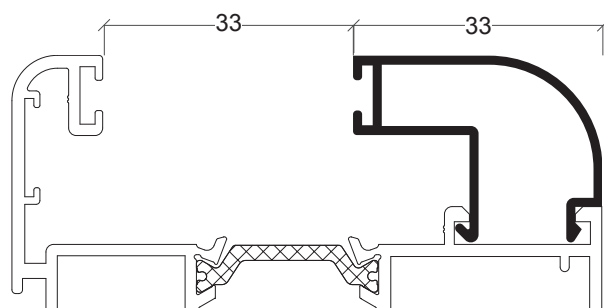

AZ-28

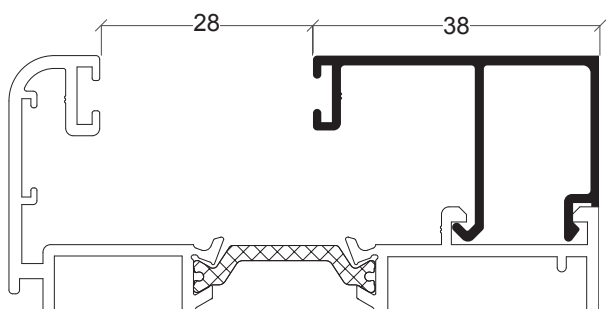

AX-32

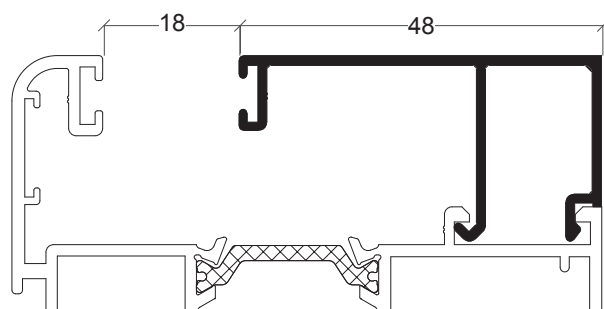

AX-80

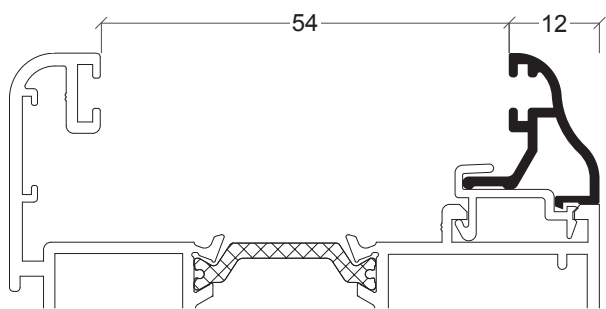

AX-72

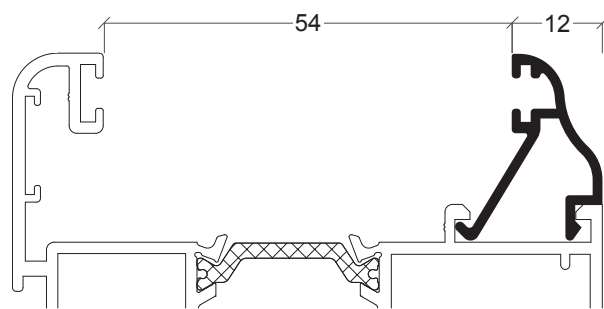

AX-73

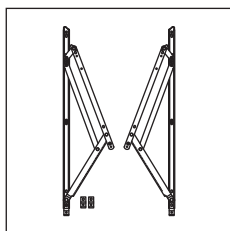

30 00 95 21
Jogo compasso (180 kg)

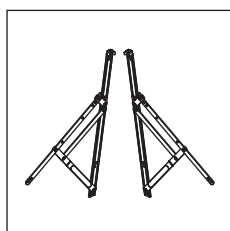

30 00 95 71
Jogo compasso (60 kg)

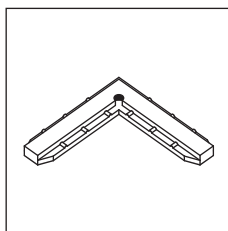

30 21 20 07
Esquadro de alinhamento

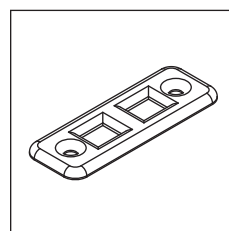

30 24 30 75
Contra-fecho inox

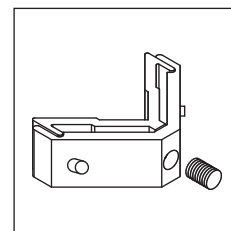

30 60 00 01
Esquadro exterior janela

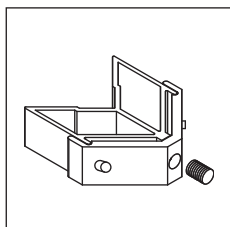

30 60 00 02
Esquadro exterior porta

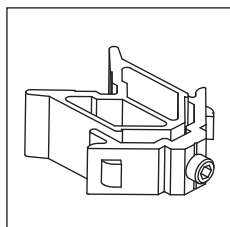

30 60 00 03
Esquadro interior porta com clip

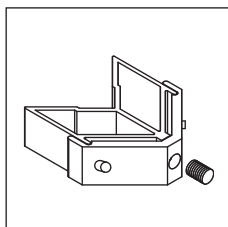

30 60 00 04
Esquadro exterior porta

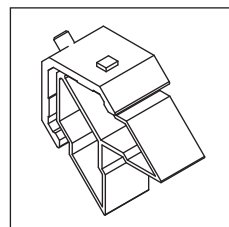

30 60 00 05
Esquadro interior porta

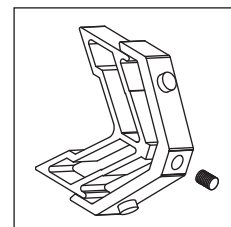

30 60 00 06
Esquadro interior projectante

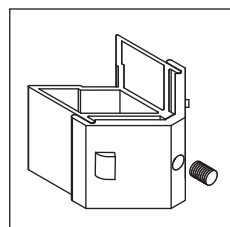

30 60 00 07
Esquadro exterior projectante

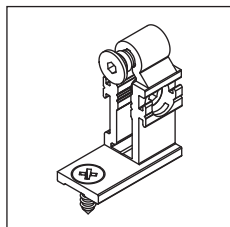

30 60 00 08
União travessa exterior pequena fixo

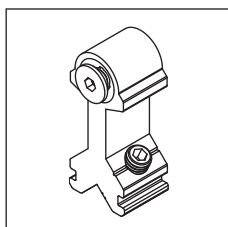

30 60 00 09
União travessa interior pequena

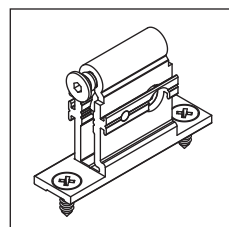

30 60 00 10
União travessa exterior grande fixo/móvel

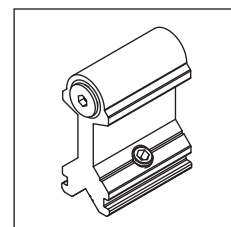

30 60 00 11
União travessa interior grande

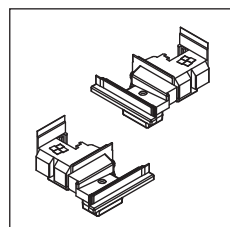

30 60 00 12
Conjunto topos inversor AJi

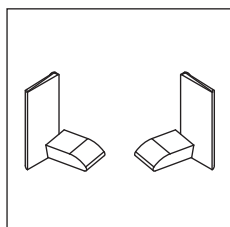

30 60 00 13
Conjunto topos AJi-62

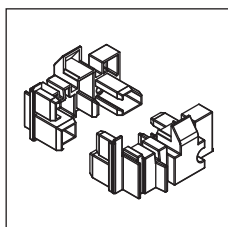

30 60 00 15
Conjunto topos AJi-63

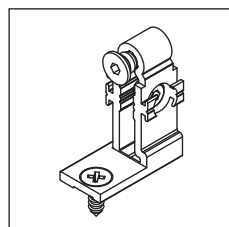

30 60 00 16
União travessa exterior pequena móvel

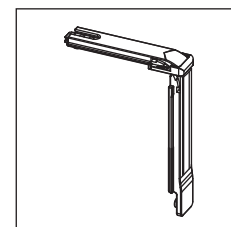

30 90 20 42
Ângulo de reenvio

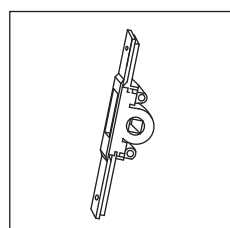

30 90 20 44
Transmissão para abertura exterior

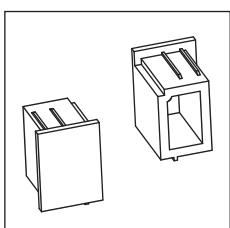

30 91 21 20
Jogo topos condensação Y-20

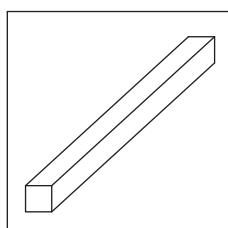

30 91 41 23
Perno 7 x 131 mm

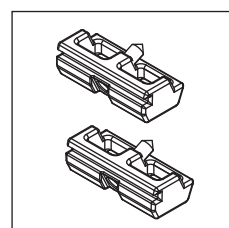

30 92 00 50
Complemento fecho

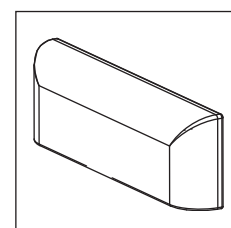

30 92 01 00/01
Goteira preto/branco

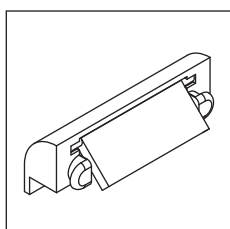

30 92 01 02/03
Goteira com válvula preto /branco

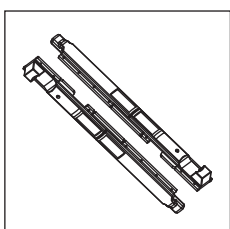

30 92 01 20
Jogo fecho C.E.



30 92 01 23
Jogo de passadores bidireccional C.E.

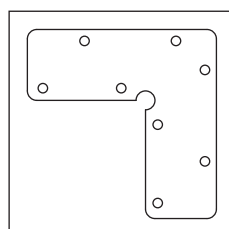

30 92 01 35
Esquadro de alinhamento

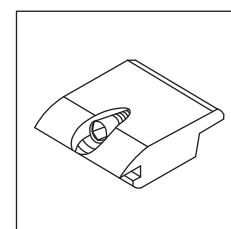

30 92 02 60
Apoio da folha

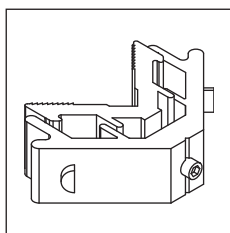

30 92 04 25
Esquadro interior janela fixo com clip

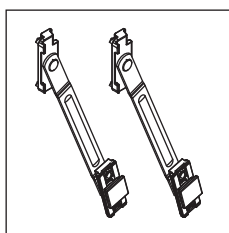

30 92 04 75
Jogo compassos basculante

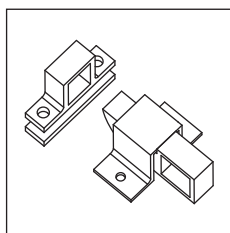

30 92 04 76/77
Fecho clack branco/preto

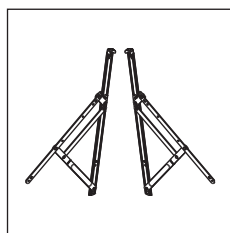

30 92 04 80
Compasso projectante deslizante até 50 kg / folha

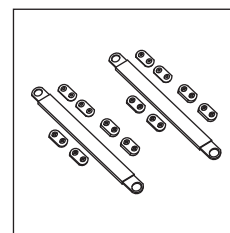

30 92 04 85
Jogo compassos

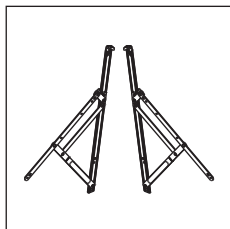

30 92 04 90
Compasso projectante deslizante até 70 kg / folha

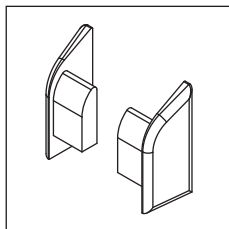

30 92 05 00
Jogo topos

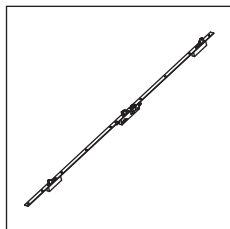

30 92 05 10
Fechadura 3 pontos (35 mm)

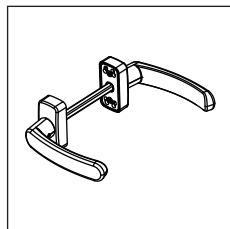

30 92 05 15
Fecho de alavanca com 5 pontos de fecho

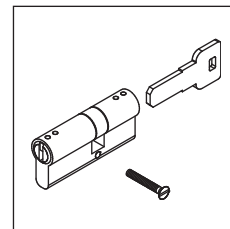

30 92 05 55
Canhão fechadura

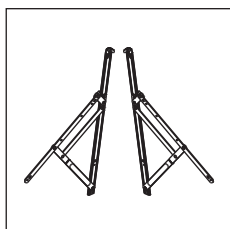

30 92 06 00
Compasso projectante deslizante até 20 kg / folha

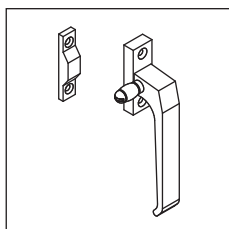

30 92 06 10/11
Cremone de lingueta branco/preto

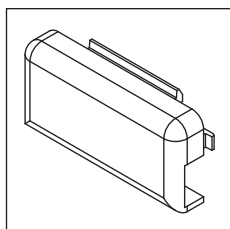

30 92 13 04
Goteira preta

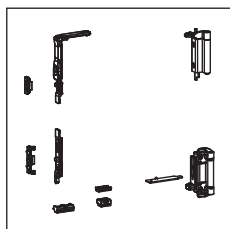

30 92 22 46/47
Kit OB sem cremone branco/preto

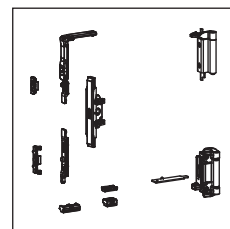

30 92 22 48/49
Kit OB com transmissão branco/preto sem puxador

110

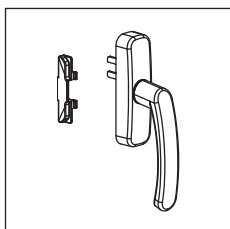

30 92 22 50/51
Cremone branco/preto

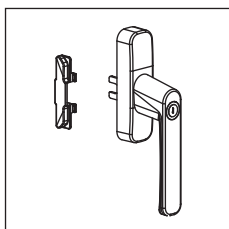

30 92 22 52/53
Cremone com chave branco/preto

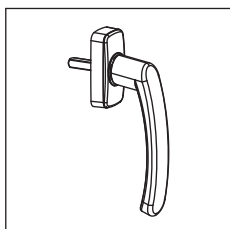

30 92 22 54/55
Puxador branco/preto

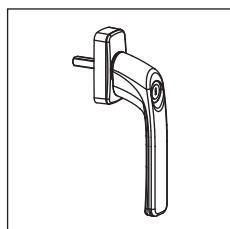

30 92 22 56/57
Puxador com chave branco/preto

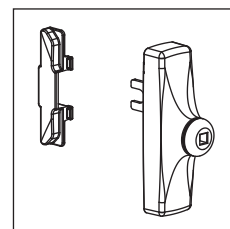

30 92 22 58/59
Cremone extraível branco/preto

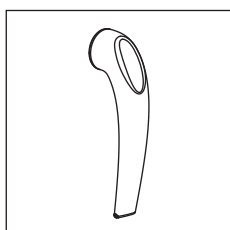

30 92 22 60/61
Punho extraível branco/preto

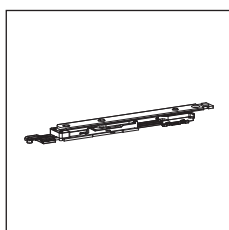

30 92 22 62
Compasso OB pequeno 340 - 441

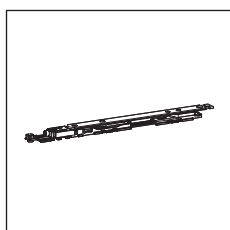

30 92 22 63
Compasso OB médio 442 - 750

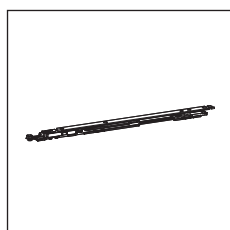

30 92 22 64
Compasso OB grande 751 - 1500

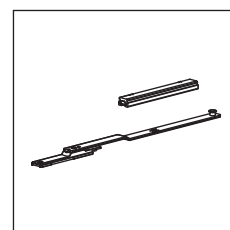

30 92 22 65
Compasso OB suplementar 1001 - 1500

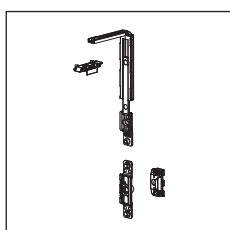

30 92 22 66
Kit 3º ponto OB

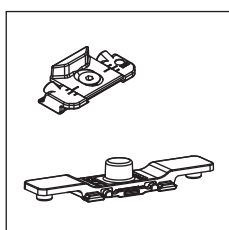

30 92 22 67
Ponto de fecho suplementar

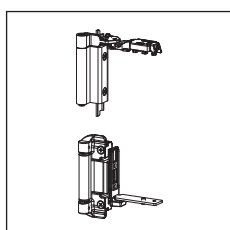

30 92 22 68/69
Kit dobradiça 2ª folha OB branco/preto

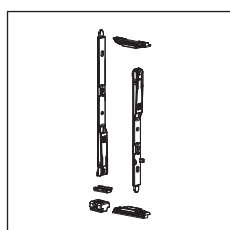

30 92 22 70
Kit fechos 2ª folha OB

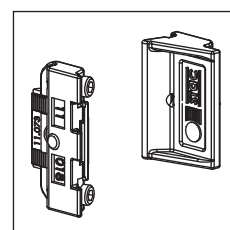

30 92 22 71
Conjunto ponto fecho suplementar folha passiva

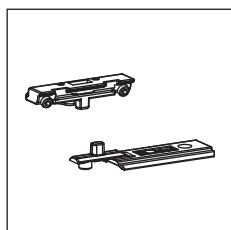

30 92 22 72

Conjunto micro-ventilação

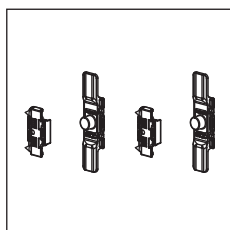

30 92 22 73

Kit batente 1 folha Anírius S/ cremone

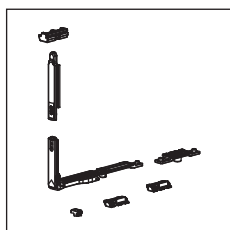

30 92 22 74

Kit batente 2 folhas Anírius S/ cremone

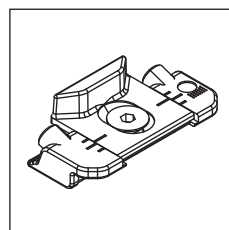

30 92 22 75

Ponto de fecho regulável (H > 1100 mm)

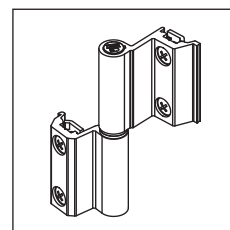

30 92 22 76/77

Dobradiça com afinação branco/preto

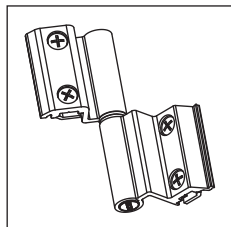

30 92 22 78/79

Dobradiça com afinação 3ª folha branco/preto

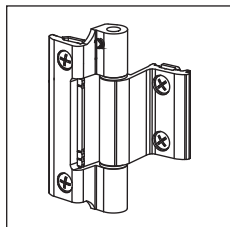

30 92 22 80/81

Dobradiça 3 nós reversível branco/preto

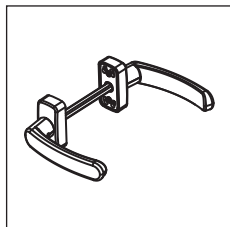

30 92 22 82/83

Puxador duplo branco/preto

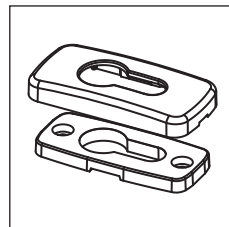

30 92 22 85/86

Escudo para canhão branco/preto

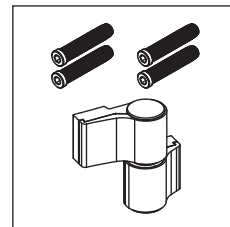

30 92 22 88/89

Dobradiça 2 abas porta c/ ressalto fixação directa branco/preto

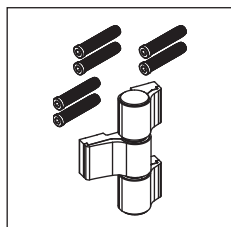

30 92 22 90/91

Dobradiça 3 abas porta c/ ressalto fixação directa branco/preto

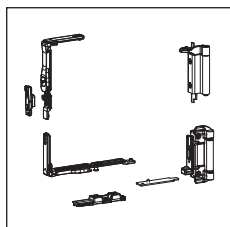

30 92 23 00/01

Kit oscilo-batente sem cremone branco/preto

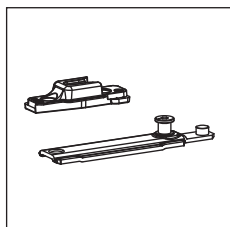

30 92 23 02

Conjunto ponto de fecho terminal

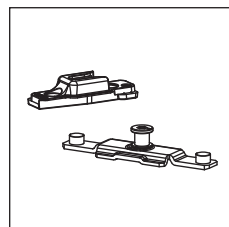

30 92 23 03

Conjunto ponto de fecho intermédio

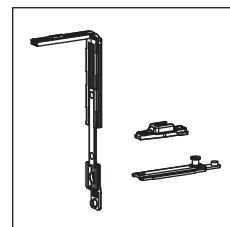

30 92 23 04

Kit ângulo de reenvio



30 92 23 05

Jogo passadores OB bidirecional

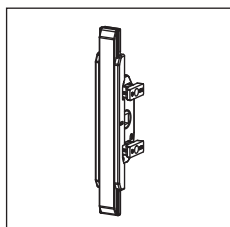

30 92 23 06

Transmissão

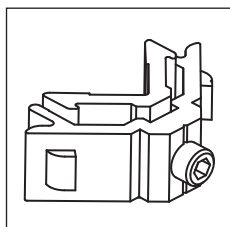

30 96 00 04

Esquadro interior janela

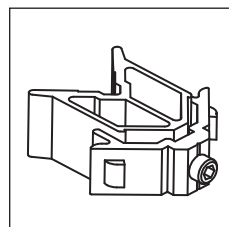

30 96 00 05

Esquadro interior aro fixo porta

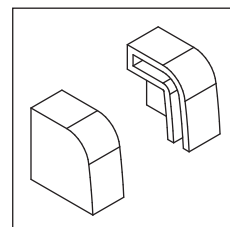

30 96 00 12

Jogo topos condensação

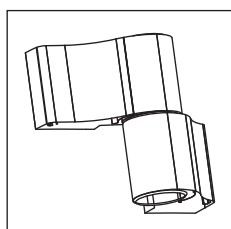

30 96 00 17/21

Dobradiça com ressalto branco/preto

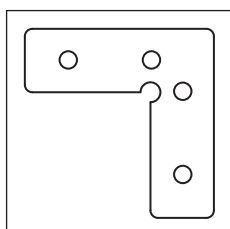

30 96 00 22

Esquadro alinhamento

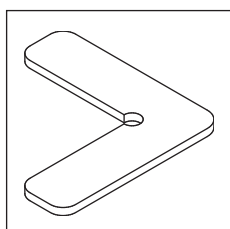

30 96 00 23

Esquadro alinhamento aro fixo

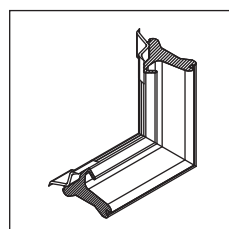

30 96 00 35

Canto vulcanizado

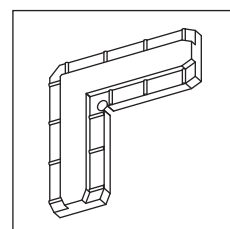

30 96 00 43

Esquadro alinhamento

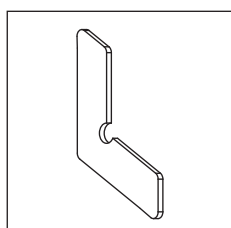

30 96 00 63

Esquadro alinhamento

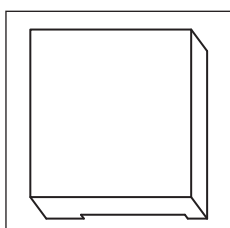

30 96 10 01

Calço para vidro aro móvel

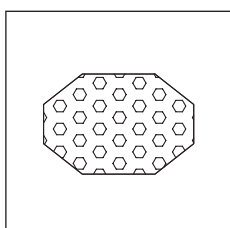

30 99 00 03

ThermoProfile ISO-03

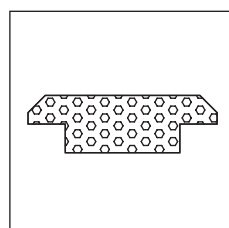

30 99 00 04



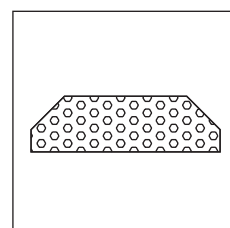





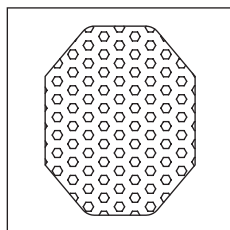
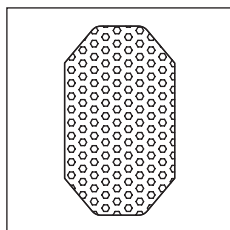
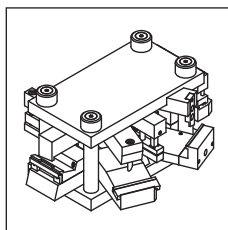
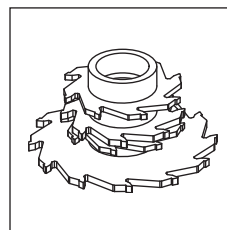
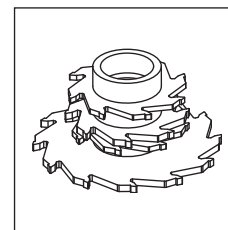











ThermoProfile ISO-04







30 99 00 05

ThermoProfile ISO-05

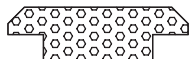
30 99 00 08
 ThermoProfile ISO-08

30 99 00 12
 ThermoProfile ISO-12

33 98 11 99
 Cunho AJi

33 98 31 99
 Conjunto de frezas fixo

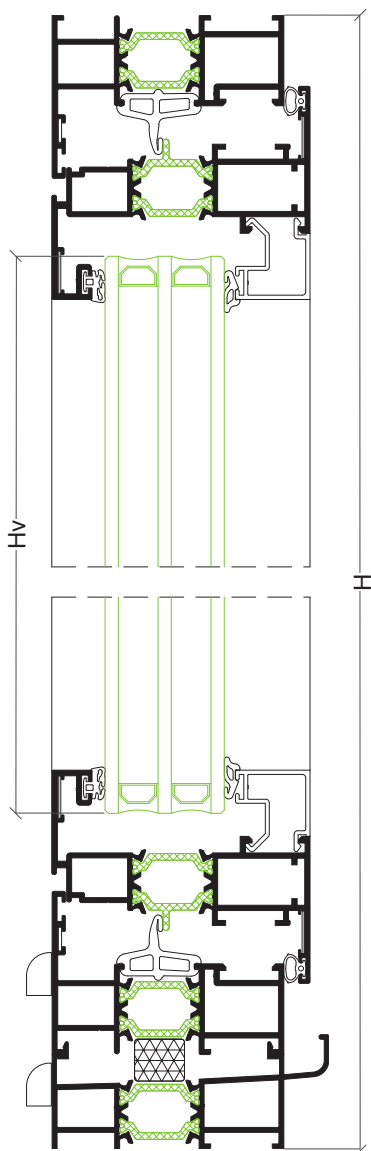
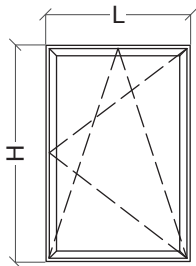
33 98 32 99
 Conjunto de frezas móvel

Referência	Desenho	Descrição
30 00 95 15		Junta de vedação curta AZ-79
30 60 00 14		Perfil pelúcia metálica 18 mm preto
30 60 00 17		Junta exterior vidro plana 2 mm preto
30 60 00 18		Junta Isolante
30 92 04 70		Espuma isolante
30 93 00 60		Junta exterior do vidro (4 mm) preto
30 93 00 61		Junta de vedação exterior (2 mm) preto
30 93 00 62		Junta exterior plana para vidro (4 mm) preto
30 93 00 65		Junta interior para vidro (5 mm) preto
30 93 00 66		Junta interior para vidro (4 mm) preto
30 93 00 67		Junta interior para vidro (2 mm) preto
30 93 00 68		Junta interior para vidro (6/7 mm) preto
30 93 00 69		Junta interior para vidro (8/9 mm) preto
30 93 00 82		Junta vedação inferior AZ-79
30 93 01 20		Junta interior
30 94 01 46		Junta para veda-luz AZ-22
30 95 00 10		Pelúcia 7x9 mm
30 96 00 03		Junta central
30 96 00 09		Junta tapa-canal aro fixo
30 96 00 18		Junta interior (abertura projectante/deslizante)

Referência	ThermoProfile (Baguetes de 70 cm)	Aplicação
30 99 00 03		AJi-01; AJi-03; AJi-04; AJi-05; AJi-07; AJi-20; AJi-21; AJi-33; AJi-35; AJi-61; AJi-65; AJi-67; AJi-71; AJi-73; AJi-74; AJi-75; AJi-76; AJi-80; AJi-81; AJi-83; AJi-86; AJi-87; AJi-88; AJi-89; AJi-91; AJi-95
30 99 00 04		AJi-01; AJi-03; AJi-06; AJi-08; AJi-12; AJi-20; AJi-33; AJi-35; AJi-68; AJi-73; AJi-74; AJi-75; AJi-76; AJi-79; AJi-80; AJi-81; AJi-86; AJi-87; AJi-88; AJi-89; AJi-91; AJi-92; AJi-93; AJi-94
30 99 00 05		AJi-05; AJi-07; AJi-10; AJi-36; AJi-61; AJi-72; AJi-83; AJi-84; AJi-85; AJi-90; AJi-95
30 99 00 08		AJi-06; AJi-08; AJi-68; AJi-79; AJi-92; AJi-93; AJi-94
30 99 00 12		AJi-10; AJi-16; AJi-36; AJi-64; AJi-72; AJi-84; AJi-85; AJi-90

Janela 1 folha abrir e oscilo-batente



Perfis

Desenho	Ref	Descrição	Corte	Quant	Medida
	AJi-03	Aro fixo		2	L
				2	H-28.5 mm
	AJi-61	Aro móvel		2	L-43 mm
				2	H-71.5 mm
	---	Bite		2	L-132 mm
				2	H-200.5 mm
	AX-19	Vareta		várias	---
	AJi-71	Soleira		1	L

Acessórios e Juntas

Referência	Descrição	Quantidade	
		Abrir	Oscilo-batente
30 96 00 04	Esquadro interior	8	
30 60 00 01	Esquadro exterior	8	
30 96 00 23	Esquadro alinhamento fixo	4	
30 96 00 22	Esquadro alinhamento móvel	8	
30 96 10 01	Calço para vidro	4	6
30 92 22 (XX)	Cremones	1	
---	Ferragem oscilo-batente (ver páginas 27/28)	---	1
30 92 22 73	Kit batente 1 folha sem cremone	1	---
30 92 22 76/77	Dobradiça com afinação branco/preto	2 ou mais	---
30 92 22 75	Ponto de fecho regulável (H > 1100 mm)	1	---
30 92 02 60	Apoio da folha	1	---
30 92 01 02	Goteira com válvula preto	4 ou mais	
30 96 00 12	Jogo topos condensação	1	
30 92 04 70	Espuma isolante	L	
30 93 01 20	Junta interior	2L+2H	
30 96 00 03	Junta central	2L+2H	
30 96 00 35	Canto vulcanizado	4	
---	Junta para vidro (exterior)	2L+2H	
---	Junta para vidro (interior)	2L+2H	

113

Vidro

Hv = H-174 mm	Lv = L-146 mm
---------------	---------------

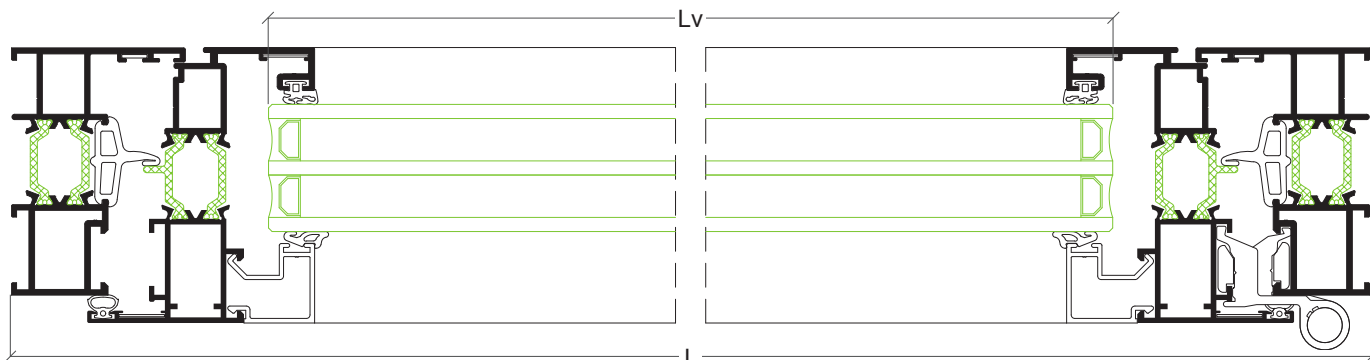

Janela 2 folhas abrir e oscilo-batente

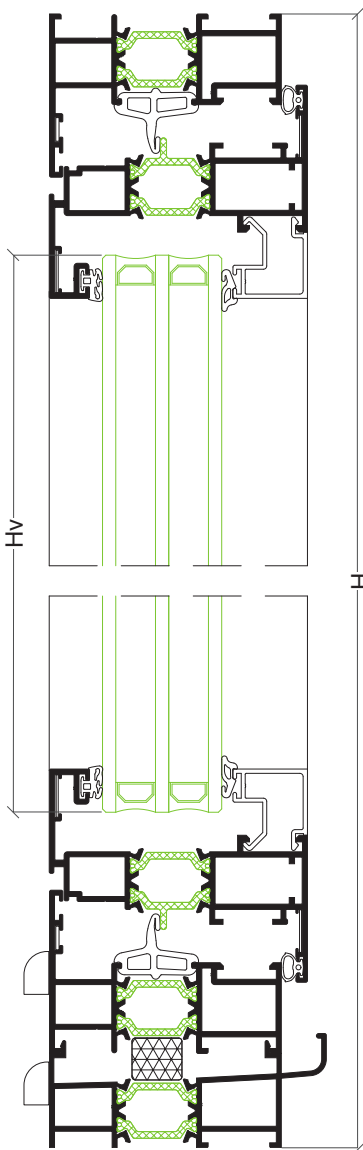
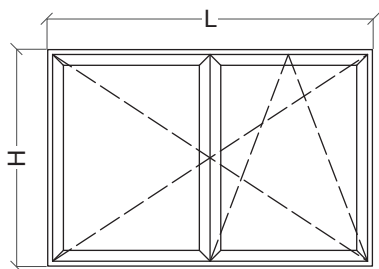

Perfis

Desenho	Ref	Descrição	Corte	Quant	Medida
	AJi-03	Aro fixo		2	L
				2	H-28.5 mm
	AJi-61	Aro móvel		2	L/2-24 mm
				2	H-71.5 mm
	---	Bite		4	L/2-113 mm
				4	H-200.5 mm
	AX-19	Vareta		várias	---
	AJi-04	Inversor		1	H-139.5 mm
	KL-04	Perfil tampa		1	H-139.5 mm
	AJi-71	Soleira		1	L

Acessórios e Juntas

Referência	Descrição	Quantidade	
		Abrir	Oscilo-batente
30 96 00 04	Esquadro interior		12
30 60 00 01	Esquadro exterior		12
30 96 00 23	Esquadro alinhamento fixo		4
30 96 00 22	Esquadro alinhamento móvel		16
30 96 10 01	Calço para vidro	8	12
30 92 22 (XX)	Cremona		1
---	Ferragem oscilo-batente (ver páginas 27/28)	---	1
30 92 22 74	Kit batente 2 folhas sem cremone	1	---
30 92 01 23	Jogo de passadores bidireccional C.E.	1	---
30 92 22 76/77	Dobradiça com afinação branco/preto	4 ou mais	---
30 92 22 75	Ponto de fecho regulável (H > 1100 mm)	1	---
30 92 02 60	Apoio da folha	1	---
30 92 01 02	Goteira com válvula preto		4 ou mais
30 60 00 12	Jogo topos inversor		1
30 96 00 12	Jogo topos condensação		1
30 92 04 70	Espuma isolante		L
30 93 01 20	Junta interior		2L+4H
30 96 00 03	Junta central		2L+3H
30 96 00 35	Canto vulcanizado		4
---	Junta para vidro (exterior)		2L+4H
---	Junta para vidro (interior)		2L+4H

Vidro

Hv = H-174 mm	Lv = L-127 mm
---------------	---------------

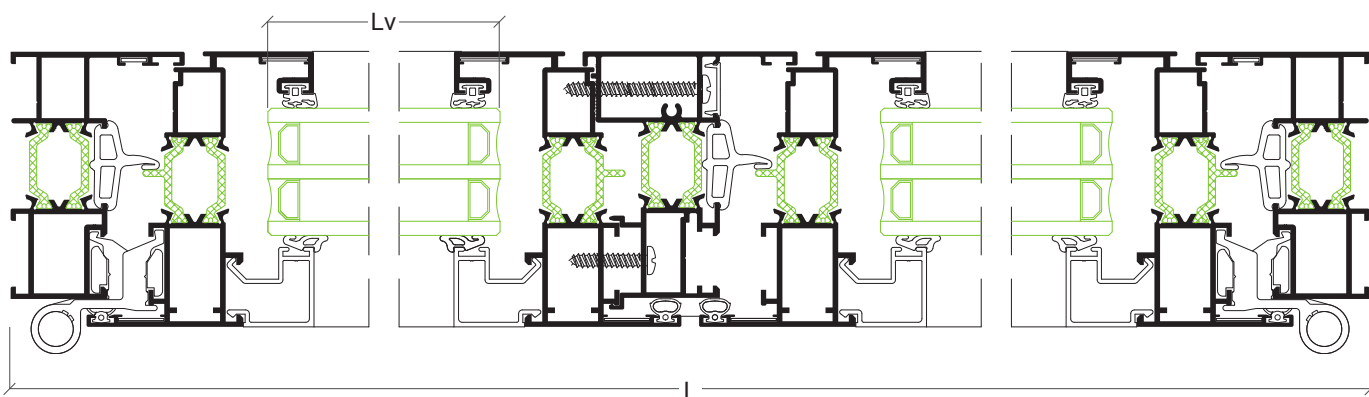

Janela projectante

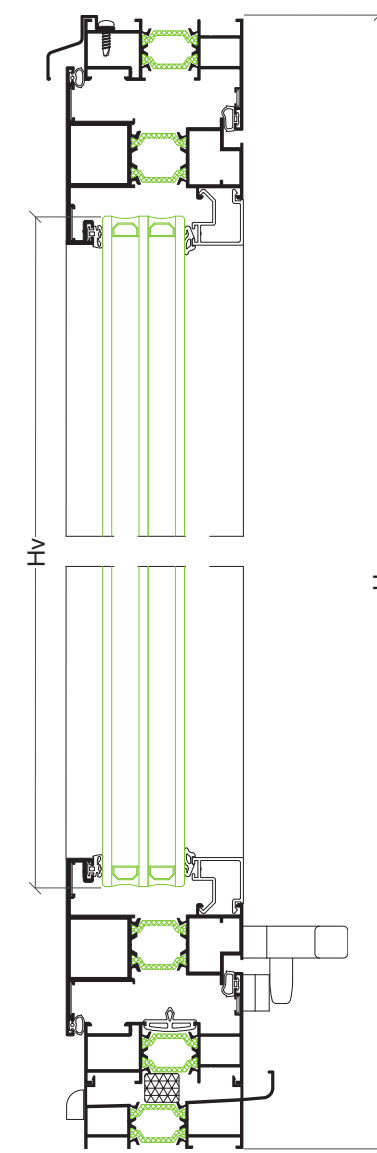
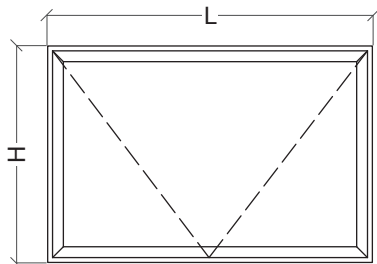

Perfis

Desenho	Ref	Descrição	Corte	Quant	Medida
	AJi-03	Aro fixo		2	L
				2	H-28.5 mm
	AJi-95	Aro móvel		2	L-43 mm
				2	H-71.5 mm
	---	Bite		2	L-159.5 mm
				2	H-228 mm
	AJi-71	Soleira		1	L
	AXi-45	Pingadeira		1	L
	AXi-32	Complemento		1	segundo medida do compasso

Acessórios e Juntas

Referência	Descrição	Quantidade
30 96 00 04	Esquadro interior	4
30 60 00 01	Esquadro exterior	4
30 96 00 23	Esquadro alinhamento fixo	4
30 92 01 35	Esquadro alinhamento móvel	8
30 96 00 06	Esquadro interior	4
30 96 00 07	Esquadro exterior	4
30 96 10 01	Calço para vidro	4
30 96 06 10 ou 11	Cremona de lingueta	2
---	Jogo compasso projectante	1
30 92 01 02	Goteira com válvula preto	2 ou mais
30 96 00 12	Jogo topos condensação	1
30 92 04 70	Espuma isolante	L
30 93 01 20	Junta exterior	2L+2H
30 96 00 18	Junta interior projectante deslizante	2L+2H
30 96 00 09	Junta tapa-canal	L
---	Junta para vidro (exterior)	2L+2H
---	Junta para vidro (interior)	2L+2H

115

Vidro

Hv = H-202 mm	Lv = L-173 mm
---------------	---------------

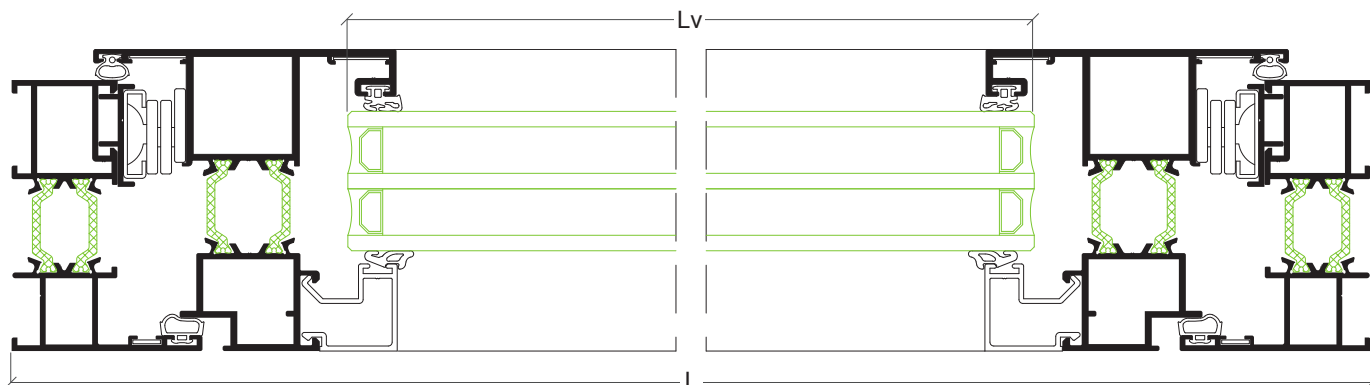

Porta 1 folha

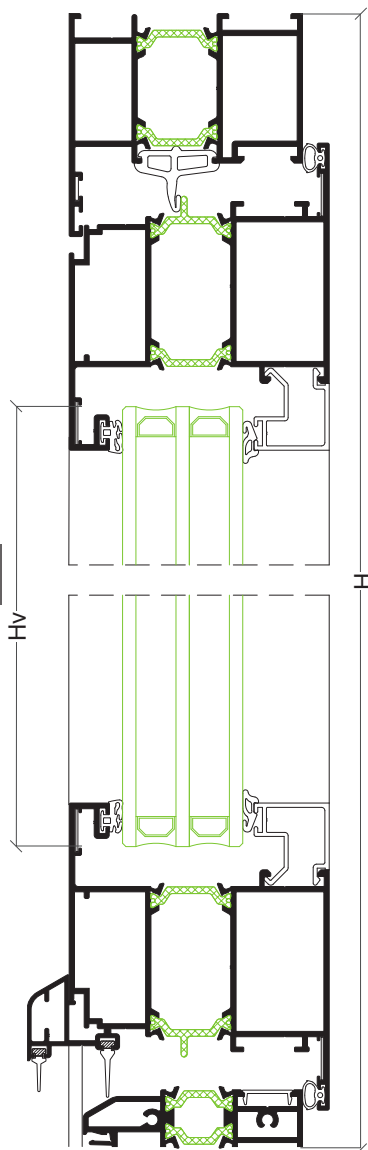
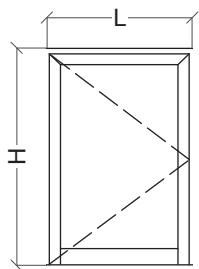

Perfis

Desenho	Ref	Descrição	Corte	Quant	Medida
	AJi-08	Aro fixo		1	L
				2	H
	AJi-36	Aro móvel		2	L-78 mm
				2	H-50 mm
	---	Bite		2	L-222 mm
				2	H-234 mm
	AJi-63	Remate inferior porta		1	L-80.5 mm
	AZ-79	Pingadeira		1	L-135 mm
	KL-04	Perfil tampa		1	L-90 mm

Acessórios e Juntas

Referência	Descrição	Quantidade
30 96 00 05	Esquadro interior	2
30 60 00 02	Esquadro exterior	2
30 60 00 05	Esquadro interior móvel	4
30 60 00 04	Esquadro exterior móvel	4
30 96 00 23	Esquadro alinhamento fixo	2
30 96 00 22	Esquadro alinhamento móvel	8
30 96 10 01	Calço para vidro	4
30 92 22 88 ou 89	Dobradiça 2 abas porta	2
30 92 05 10	Fechadura 3 pontos	1
30 92 22 82 ou 83	Puxador duplo	1
30 92 22 85 ou 86	Escudo para canhão	2
30 92 05 55	Canhão fechadura	1
30 93 01 20	Junta interior	2L+2H
30 96 00 03	Junta central	L+2H
30 96 00 35	Canto vulcanizado	2
30 92 05 00	Conjunto topos pingadeira	1
30 00 95 15	Junta inferior curta	L
30 93 00 82	Junta inferior	L
---	Junta para vidro (exterior)	2L+2H
---	Junta para vidro (interior)	2L+2H

Vidro

Hv = H-208 mm	Lv = L-236 mm
---------------	---------------

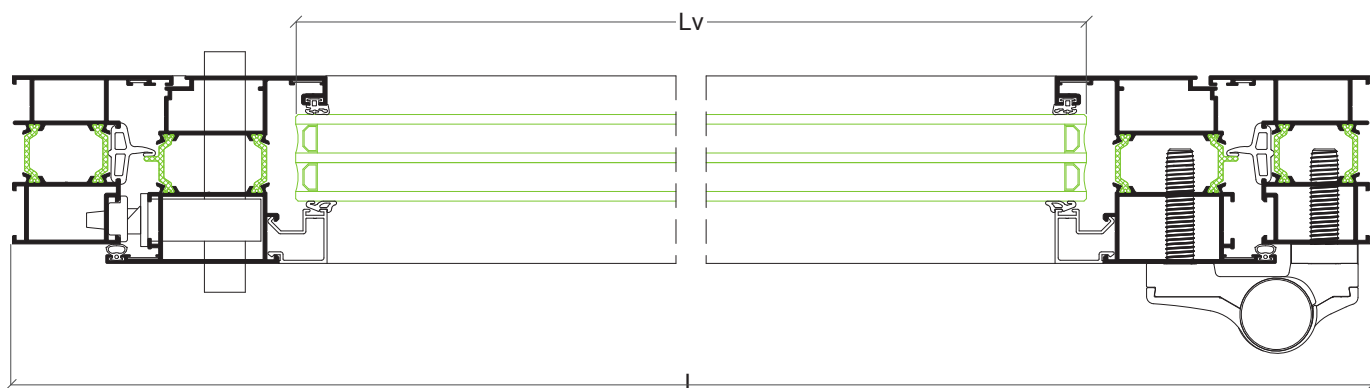

Porta 2 folhas

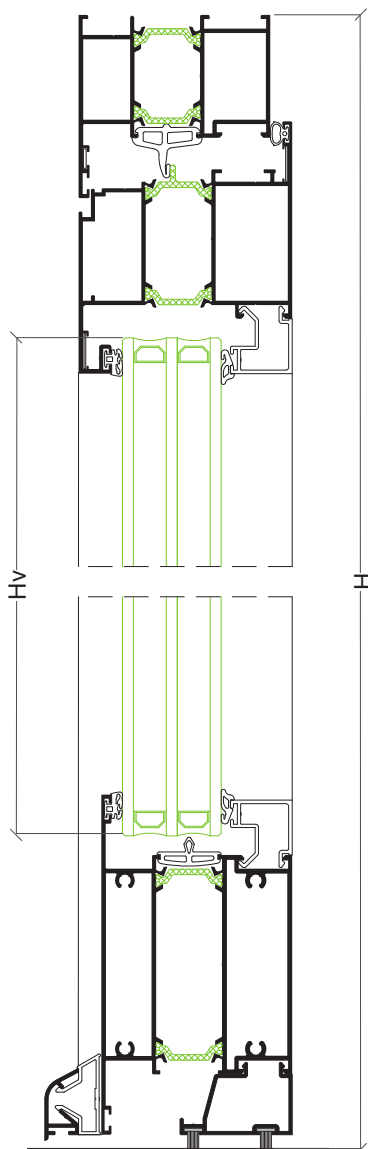
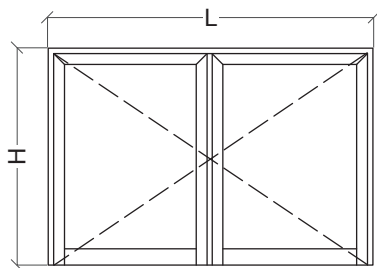

Perfis

Desenho	Ref	Descrição	Corte	Quant	Medida
	AJi-08	Aro fixo		1	L
				2	H
	AJi-36	Aro móvel		2	L/2-41.5 mm
				4	H-44 mm
	---	Bíte		4	L/2-185.5 mm
				4	H-258 mm
	AJi-04	Inversor		1	H-78 mm
	KL-04	Perfil tampa		1	H-78 mm
	AJi-12	Travessa		2	L/2-176.5 mm
	AJi-82	Bíte remate		2	L/2-185.5 mm
	AZ-60	Pingadeira		1	L/2-103 mm
				1	L/2-39 mm
	AZ-61	Suplemento pingadeira		2	L/2-226 mm

Acessórios e Juntas

Referência	Descrição	Quantidade
30 96 00 05	Esquadro interior	2
30 60 00 02	Esquadro exterior	2
30 60 00 05	Esquadro interior móvel	4
30 60 00 04	Esquadro exterior móvel	4
30 96 00 23	Esquadro alinhamento fixo	2
30 96 00 22	Esquadro alinhamento móvel	8
30 60 00 12	Jogo topos inversor	1
30 92 22 88 ou 89	Dobradiça 2 abas porta	4
30 92 05 10	Fechadura 3 pontos	1
30 92 22 82 ou 83	Puxador duplo	1
30 92 22 85 ou 86	Escudo para canhão	2
30 92 05 55	Canhão fechadura	1
30 92 00 50	Contra-fecho	1
30 24 30 75	Contra-fecho inferior	1
30 92 01 20	Jogo fecho C.E.	1
30 93 01 20	Junta interior	L+4H
30 96 00 03	Junta central	L+3H
30 96 00 35	Canto vulcanizado	2
30 92 05 00	Conjunto topos pingadeira	1
30 95 00 10	Pelúcia	2L
---	Junta para vidro (exterior)	2L+4H
---	Junta para vidro (interior)	2L+4H
30 96 00 09	Junta tapa-canal	2L

117

Vidro

Hv = H-232 mm	Lv = L/2-200 mm
---------------	-----------------

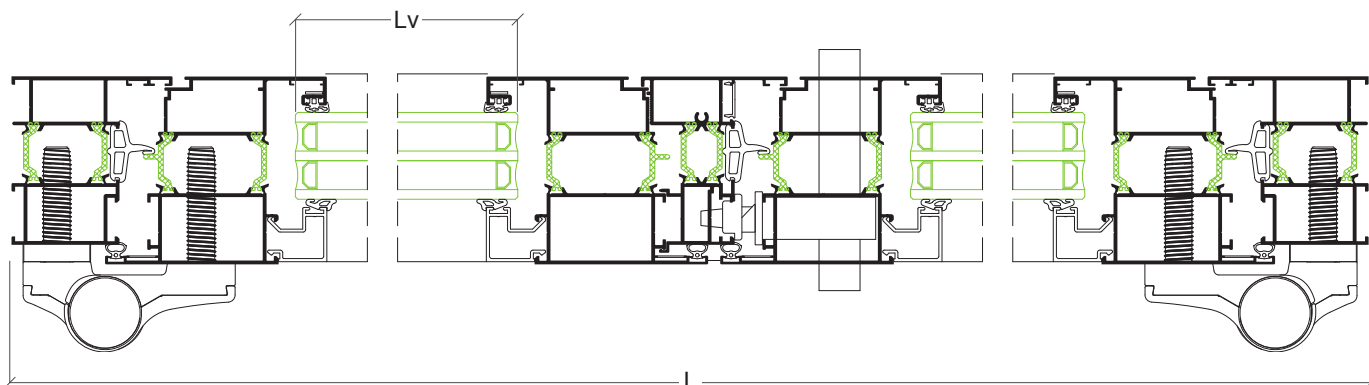

Porta 1 folha abertura exterior

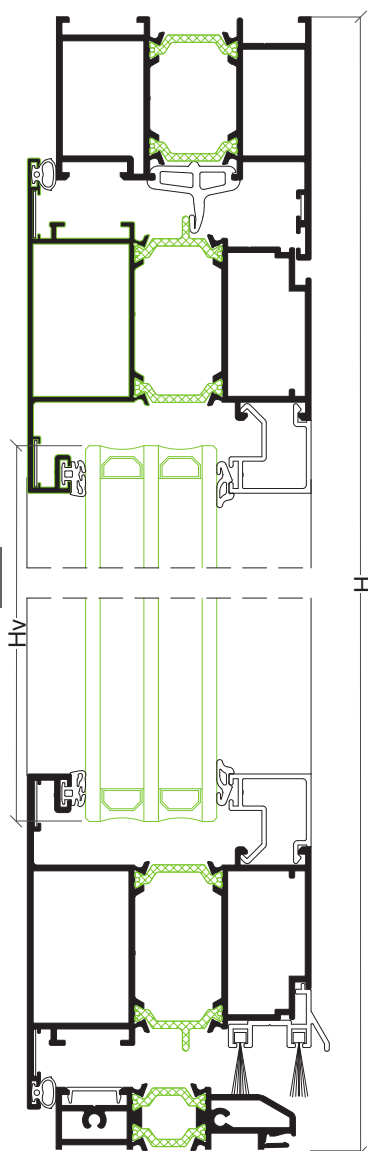
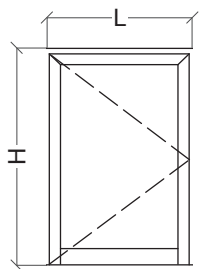

Perfis

Desenho	Ref	Descrição	Corte	Quant	Medida
	AJi-08	Aro fixo		1	L
				2	H
	AJi-72	Aro móvel		2	L-78 mm
				2	H-50 mm
	---	Bite		2	L-222 mm
				2	H-234 mm
	AJi-63	Remate inferior porta		1	L-80.5 mm
	AJi-62	Pingadeira		1	---
	KL-04	Perfil tampa		1	L-90 mm

Acessórios e Juntas

Referência	Descrição	Quantidade
30 96 00 05	Esquadro interior	2
30 60 00 02	Esquadro exterior	2
30 60 00 05	Esquadro interior móvel	4
30 60 00 04	Esquadro exterior móvel	4
30 96 00 23	Esquadro alinhamento fixo	2
30 96 00 22	Esquadro alinhamento móvel	8
30 96 10 01	Calço para vidro	4
30 92 22 88 ou 89	Dobradiça 2 abas porta	2
30 92 05 10	Fechadura 3 pontos	1
30 92 22 82 ou 83	Puxador duplo	1
30 92 22 85 ou 86	Escudo para canhão	2
30 92 05 55	Canhão fechadura	1
30 93 01 20	Junta interior	2L+2H
30 96 00 03	Junta central	L+2H
30 96 00 35	Canto vulcanizado	2
30 60 00 13	Conjunto topos AJi-62	1
30 60 00 14	Pelúcia preta 18 mm	2L
---	Junta para vidro (exterior)	2L+2H
---	Junta para vidro (interior)	2L+2H

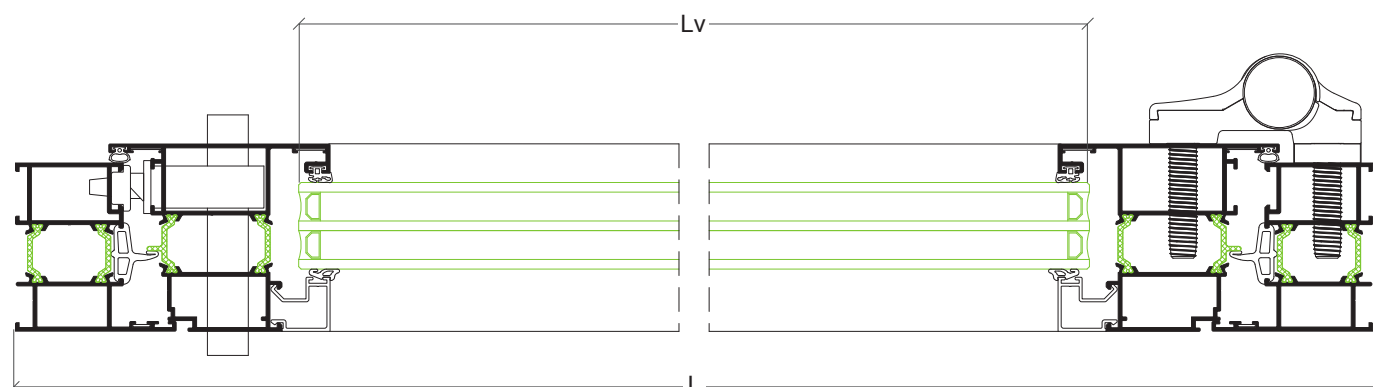

Vidro

Hv = H-208 mm	Lv = L-236 mm
---------------	---------------

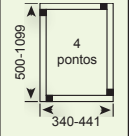
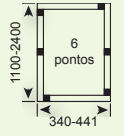

Ferragens para oscilo-batente

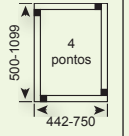
Designação	Referência		
Kit oscilo-batente	30 92 22 46 (branco) 30 92 22 47 (preto)	1	
Cremones	30 92 22 50 ou 51 ou 30 92 22 52 ou 53 ou 30 92 22 58 + 30 92 22 60 ou 30 92 22 59 + 30 92 22 61	1	
Compasso pequeno	30 92 22 62	1	
Kit fecho 3º ponto	30 92 22 66		1

Designação	Referência		
Kit oscilo-batente	30 92 22 46 (branco) 30 92 22 47 (preto)	1	
Cremones	30 92 22 50 ou 51 ou 30 92 22 52 ou 53 ou 30 92 22 58 + 30 92 22 60 ou 30 92 22 59 + 30 92 22 61	1	
Compasso médio	30 92 22 63	1	
Kit fecho 3º ponto	30 92 22 66		1

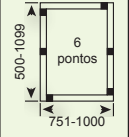
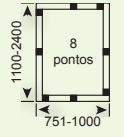
Designação	Referência		
Kit oscilo-batente	30 92 22 46 (branco) 30 92 22 47 (preto)	1	
Cremones	30 92 22 50 ou 51 ou 30 92 22 52 ou 53 ou 30 92 22 58 + 30 92 22 60 ou 30 92 22 59 + 30 92 22 61	1	
Compasso grande	30 92 22 64	1	
Kit fecho 3º ponto	30 92 22 66	1	2

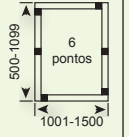
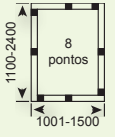
Designação	Referência		
Kit oscilo-batente	30 92 22 46 (branco) 30 92 22 47 (preto)	1	
Cremones	30 92 22 50 ou 51 ou 30 92 22 52 ou 53 ou 30 92 22 58 + 30 92 22 60 ou 30 92 22 59 + 30 92 22 61	1	
Compasso grande	30 92 22 64	1	
Compasso suplementar	30 92 22 65	1	
Kit fecho 3º ponto	30 92 22 66	1	2

119

Ferragens para a 2ª folha

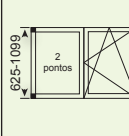
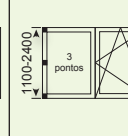
Designação	Referência		
Kit dobradiça 2ª folha	30 92 22 68 (branco) 30 92 22 69 (preto)	1	
Kit fechos para 2ª folha	30 92 22 70	1	
Conjunto ponto fecho suplementar	30 92 22 71		1



Peso máximo da folha: 120 kg (alumínio + vidro)

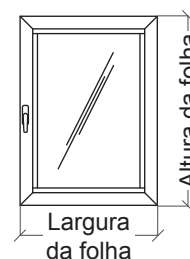
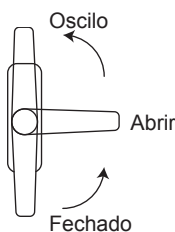

(confirmar com o quadro de dimensão/aplicação do mapa de montagem da ferragem O-B)

Largura mínima: 340 mm / Largura máxima: 1500 mm
 Altura mínima: 500 mm / Altura máxima: 2400 mm (vão de 1 folha)
 Altura mínima: 625 mm / Altura máxima: 2400 mm (vão de 2 folhas)

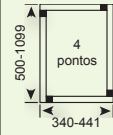

Ferragens para oscilo-batente com transmissão

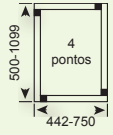
Designação	Referência		
Kit oscilo-batente com transmissão	30 92 22 48 (branco) 30 92 22 49 (preto)	1	
Puxador	30 92 22 54 ou 55 ou 30 92 22 56 ou 57	1	
Compasso pequeno	30 92 22 62	1	
Kit fecho 3º ponto	30 92 22 66		1

Designação	Referência		
Kit oscilo-batente com transmissão	30 92 22 48 (branco) 30 92 22 49 (preto)	1	
Puxador	30 92 22 54 ou 55 ou 30 92 22 56 ou 57	1	
Compasso médio	30 92 22 63	1	
Kit fecho 3º ponto	30 92 22 66		1

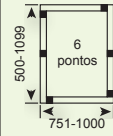
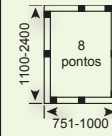
Designação	Referência		
Kit oscilo-batente	30 92 22 48 (branco) 30 92 22 49 (preto)	1	
Puxador	30 92 22 54 ou 55 ou 30 92 22 56 ou 57	1	
Compasso grande	30 92 22 64	1	
Kit fecho 3º ponto	30 92 22 66	1	2

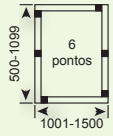
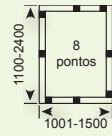
Designação	Referência		
Kit oscilo-batente	30 92 22 48 (branco) 30 92 22 49 (preto)	1	
Puxador	30 92 22 54 ou 55 ou 30 92 22 56 ou 57	1	
Compasso grande	30 92 22 64	1	
Compasso suplementar	30 92 22 65	1	
Kit fecho 3º ponto	30 92 22 66	1	2

Ferragens para a 2ª folha

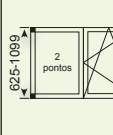
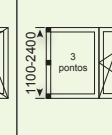
Designação	Referência		
Kit dobradiça 2ª folha	30 92 22 68 (branco) 30 92 22 69 (preto)	1	
Kit fechos para 2ª folha	30 92 22 70	1	
Conjunto ponto fecho suplementar	30 92 22 71		1

Peso máximo da folha: 120 kg (alumínio + vidro)

(confirmar com o quadro de dimensão/aplicação do mapa de montagem da ferragem O-B)

Largura mínima: 340 mm / Largura máxima: 1500 mm
 Altura mínima: 500 mm / Altura máxima: 2400 mm (vão de 1 folha)
 Altura mínima: 625 mm / Altura máxima: 2400 mm (vão de 2 folhas)

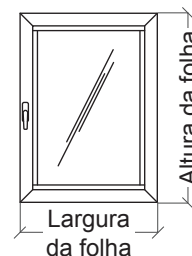
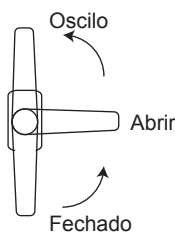

As medidas indicadas reportam-se às dimensões da folha móvel do vão

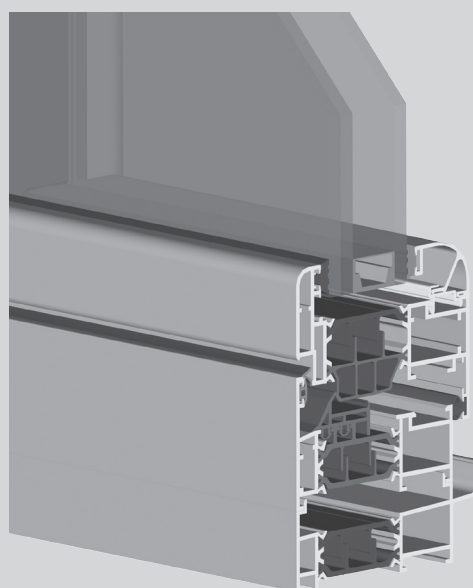
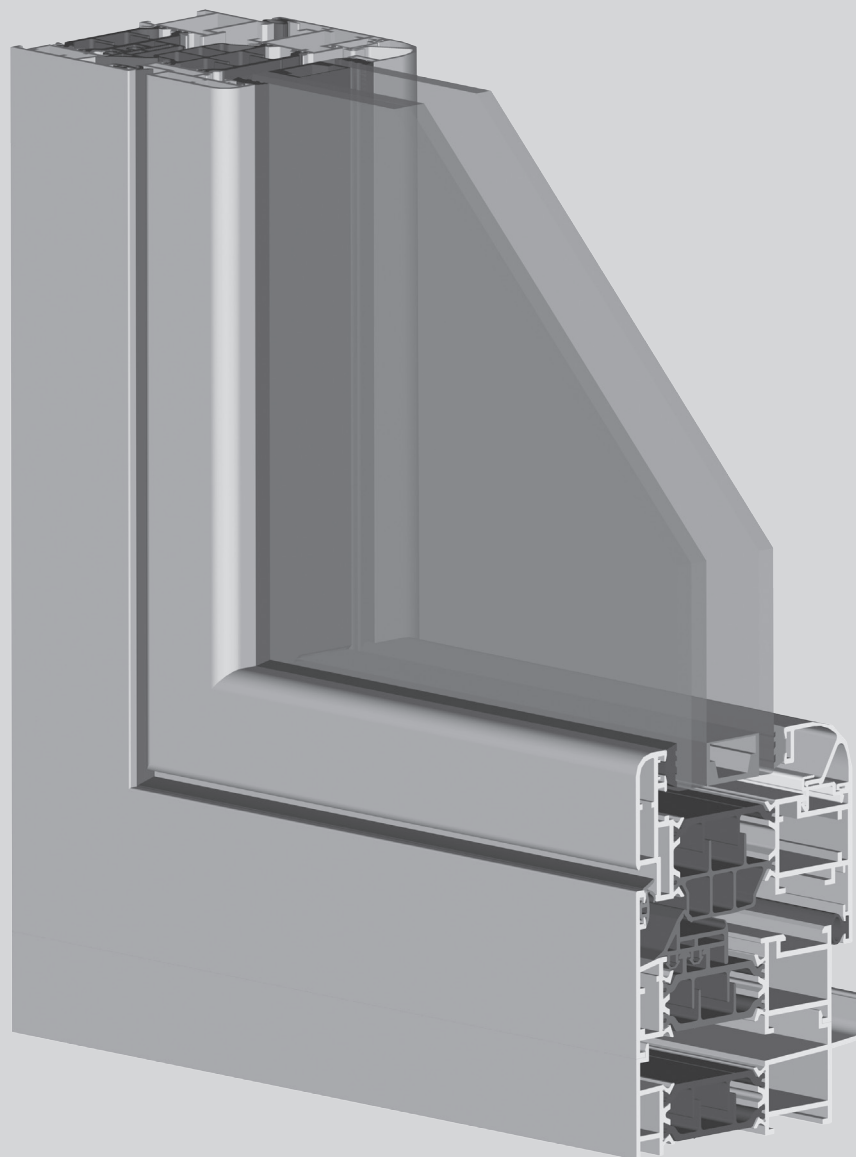

Sistema

AKi

Sistema AKi

Sistema de batente com RPT - 75 mm

Características do sistema

Sistema de batente com rotura térmica de elevadas prestações térmicas e acústicas.

O sistema AKi possibilita a execução de 5 versões de caixilharia:

1. Linha recta;
2. Linha curva;
3. Linha tradição;
4. Linha oval;
5. Folha Oculta 3D.

O sistema AKi permite a aplicação de vidros duplos ou triplos de alto rendimento de modo a responder às exigências de isolamento térmico e acústico.

A versão AKi Folha Oculta permite a ocultação do aro móvel.

Perfis de alumínio

Os perfis de alumínio são extrudidos na liga de alumínio 6060 para arquitectura de acordo com norma NP EN 12020-02;

Rotura térmica obtida por inserção de varetas isolantes de poliamida tipo ómega de 39 mm, reforçadas com 25% de fibra de vidro;

Espessura média dos perfis de alumínio de 1.5 mm para janelas e de 1.7 mm para portas.

Aros fixos

Secção dos aros fixos de 75 mm ou 99.5 mm com tripla câmara;

Aros fixos com esquadros duplos para montagem a meia esquadria;

Aros fixos tradicionais para mercado interno;

Aros fixos com clip exterior e aba de remate direta de 25 mm ou 45 mm;

Aros fixos com clip exterior e interior para aplicação de remate de 30 mm.

Aros móveis

Secção dos aros móveis de 83 mm com tripla câmara;

Enchimento para vidro duplo ou triplo de 24 mm a 60 mm no sistema AKi;

Enchimento para vidro duplo ou triplo até 34 mm no sistema AKi Folha Oculta 3D;

Aros móveis de linha recta, curva ou tradição;

Aros móveis com esquadros duplos para montagem a meia esquadria;

Perfil inversor de linha recta.

Dimensionamento e manobralidade

Dimensões mínimas - máximas de folha: 457 mm - 1700 mm (L); 600 mm - 2700 mm (H);

Possibilidades de abertura: fixo, batente interior 1 ou 2 folhas com oscilo-batente, exterior, basculante, projectante, pivotante, harmónio e oscilo-paralela;

Estanquidade assegurada através de juntas triplas em EPDM.

Performances

Sistema certificado por laboratório notificado para Ensaio Tipo Inicial (ITT) de acordo com a norma de produto EN 14351-1 para efeitos de Marcação CE.

Categorias alcançadas na avaliação do sistema AKi tipologia janela:

1. Permeabilidade ao ar: Classe 4 (norma de ensaio EN 1026)
2. Estanquidade à água: Classe E750 (norma de ensaio EN 1027)
3. Resistência ao vento: Classe C5 (norma de ensaio EN 12211)

Categorias alcançadas na avaliação do sistema AKi tipologia porta:

1. Permeabilidade ao ar: Classe 4 (norma de ensaio EN 1026)
2. Estanquidade à água: Classe E1200 (norma de ensaio EN 1027)
3. Resistência ao vento: Classe C2 (norma de ensaio EN 12211)
4. Resistência à torção estática: Apto 350N (norma de ensaio EN 14609)

Categorias alcançadas na avaliação do sistema AKi - Folha Oculta 3D tipologia janela:

1. Permeabilidade ao ar: Classe 4 (norma de ensaio EN 1026)
2. Estanquidade à água: Classe 8A (norma de ensaio EN 1027)
3. Resistência ao vento: Classe C5 (norma de ensaio EN 12211)

Coefficiente de transmissão térmica de vão de 2 folhas, sistema AKi, com 1.20 m x 1.50 m com vidro $U_g = 0.5 \text{ W/m}^2\text{K}$, com intercalar efeito "Warm Edge":

• $U_w = 1.00 \text{ W/m}^2\text{K}$

Coefficiente de transmissão térmica de vão de 2 folhas, sistema AKi - Folha Oculta 3D, com 1.80m x 2.20m com vidro $U_g = 0.7 \text{ W/m}^2\text{K}$, com intercalar efeito "Warm Edge":

• $U_w = 1.11 \text{ W/m}^2\text{K}$

Coefficiente de atenuação acústica de vão de 2 folhas com vidro 5/16/5:

• $R_w \text{ (C; Ctr)} = 35 \text{ dB (-2; -4)}$

Zonas de aplicação segundo RCCTE (em função do valor U_g): I1, I2, I3, V1, V2, V3.

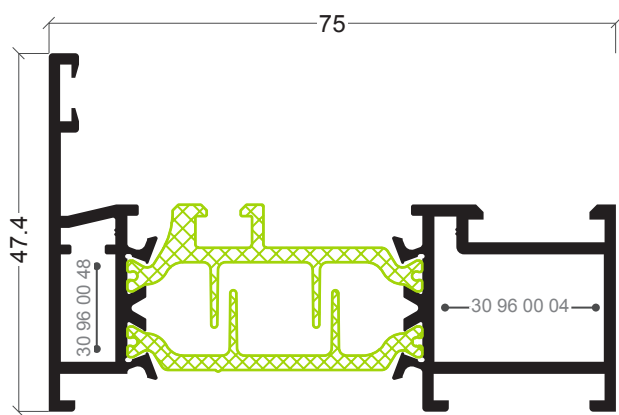

AKi-03
Aro fixo

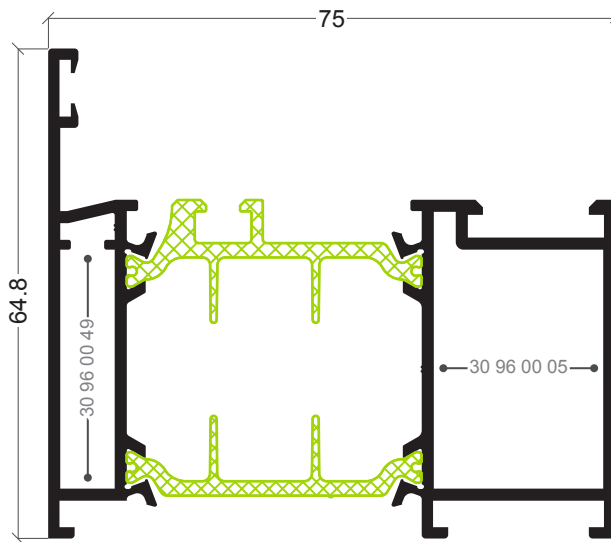

AKi-08
Aro fixo

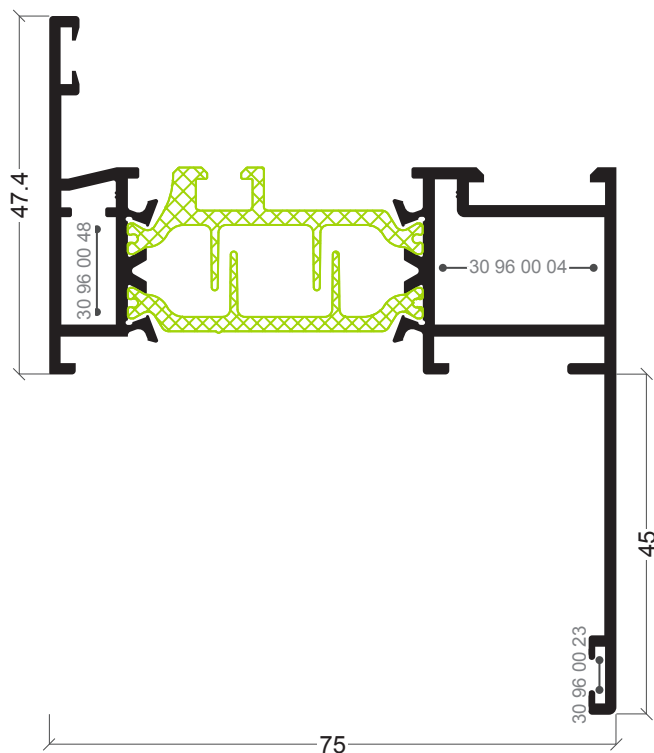

AKi-33
Aro fixo com remate 45 mm

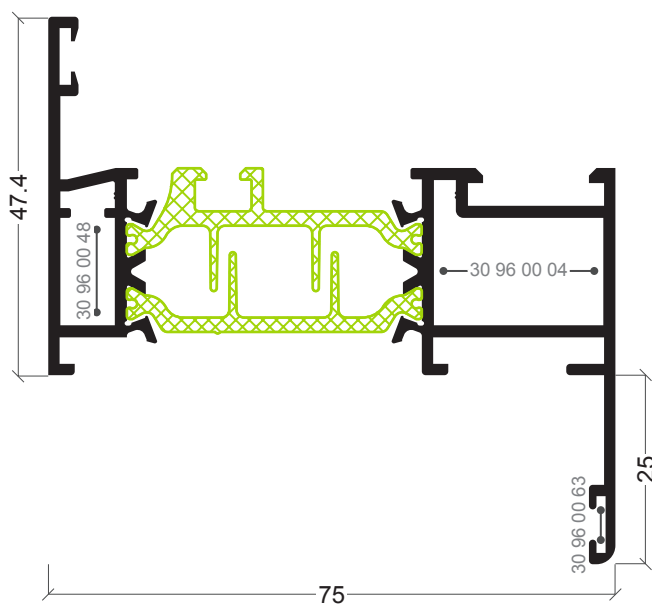

AKi-35
Aro fixo com remate 25 mm

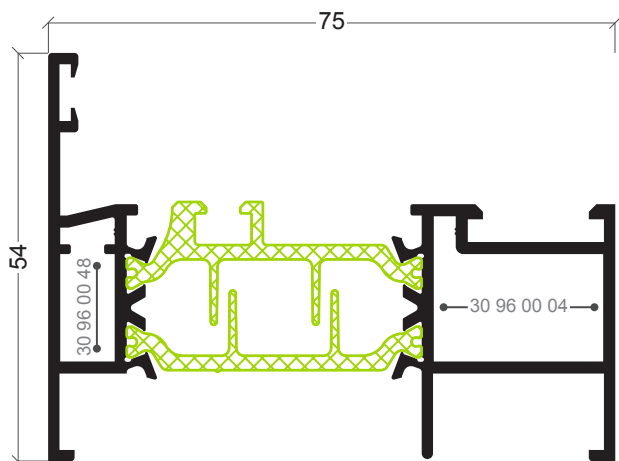

AKi-81
Aro fixo

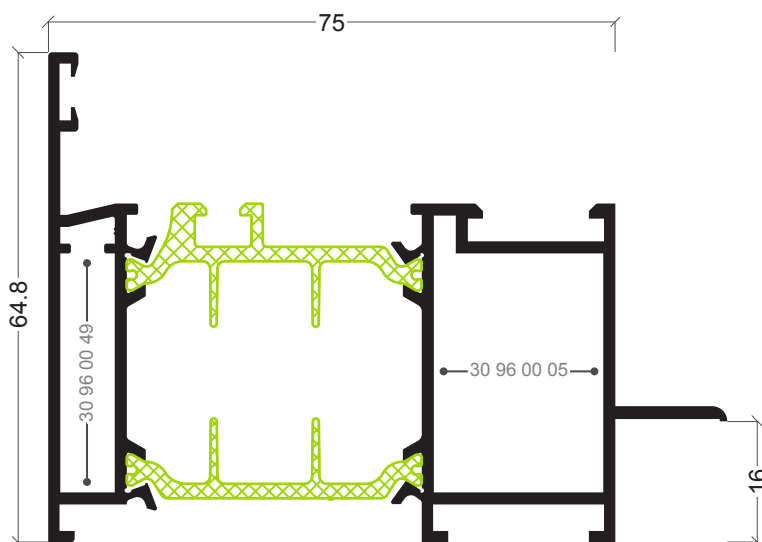

AKi-68
Aro fixo para apanelado

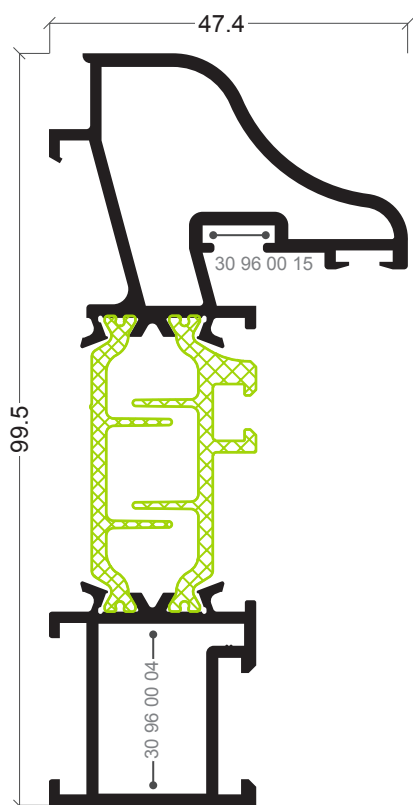

AKi-57
Aro fixo

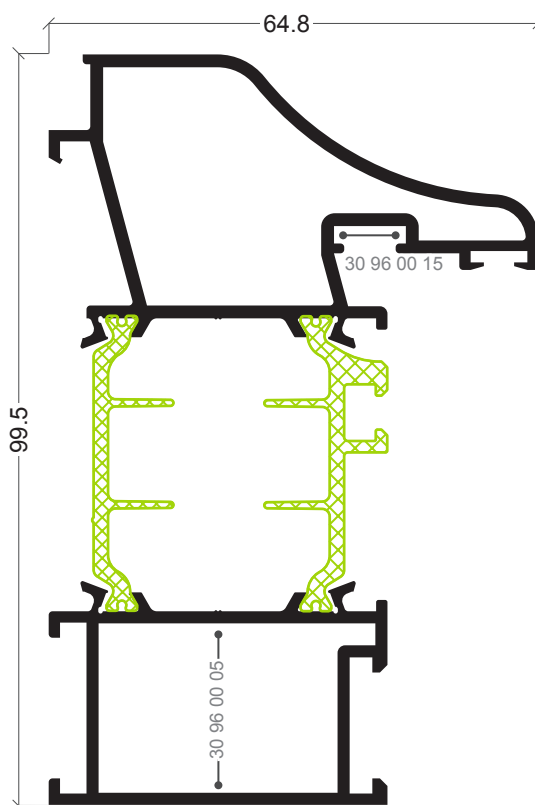

AKi-59
Aro fixo

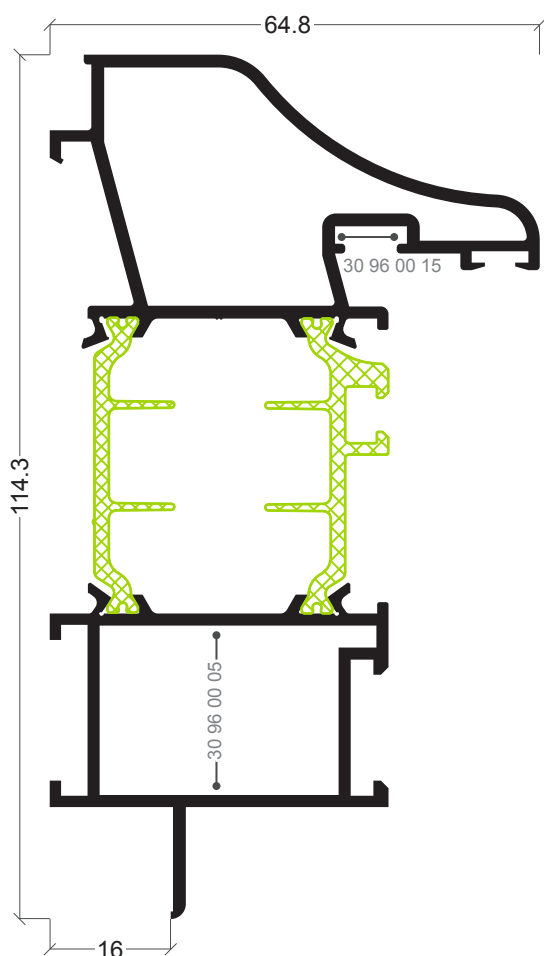

AKi-69
Aro fixo para apanelado

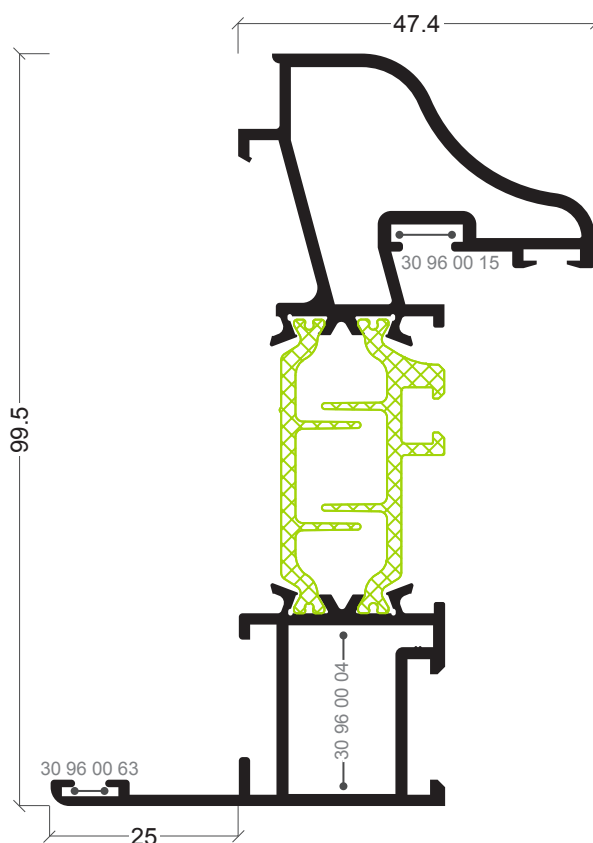

AKi-77
Aro fixo com remate

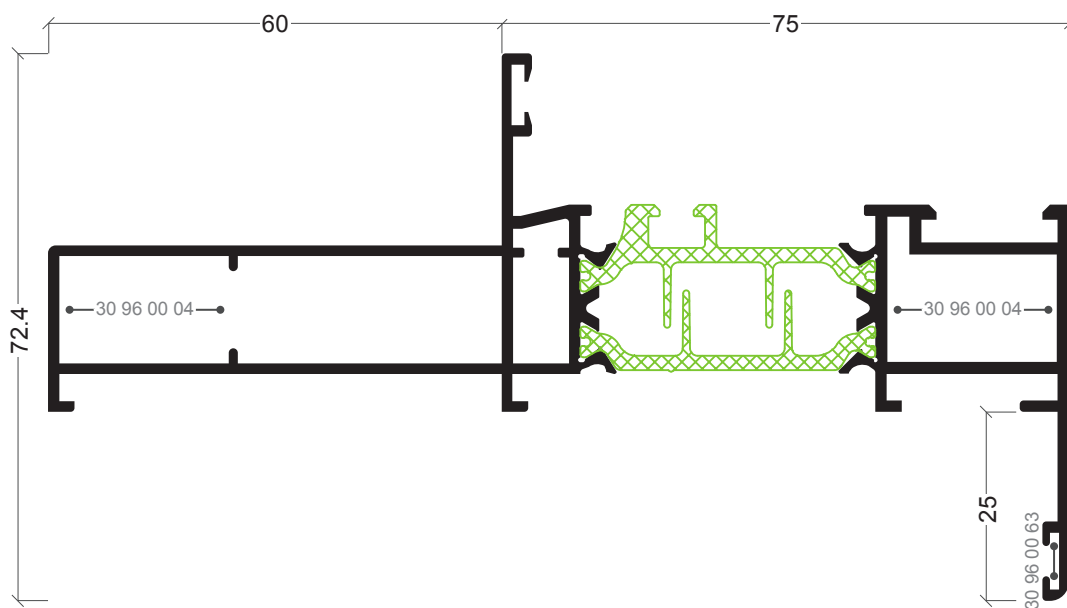

AKi-86
Aro fixo com remate

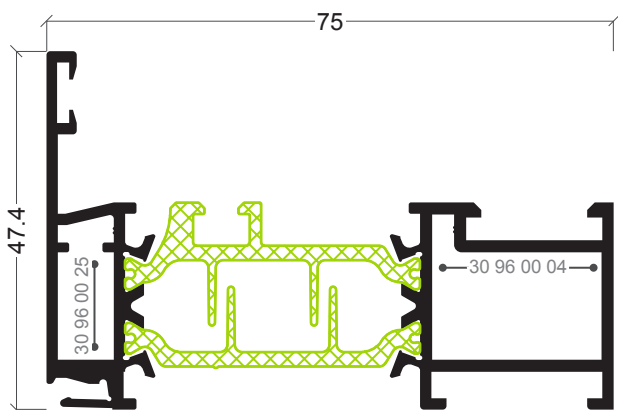

AKi-76
Aro fixo

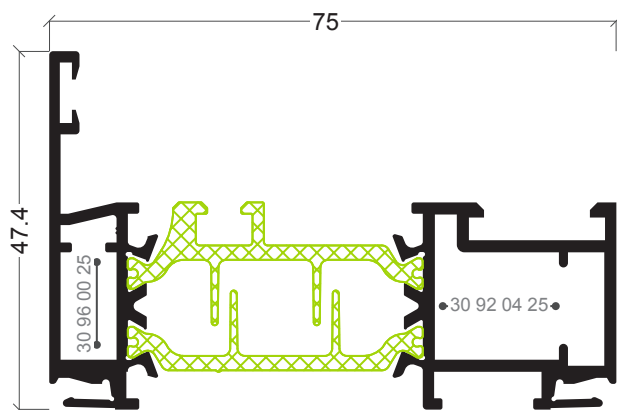

AKi-80
Aro fixo com clip interior/exterior

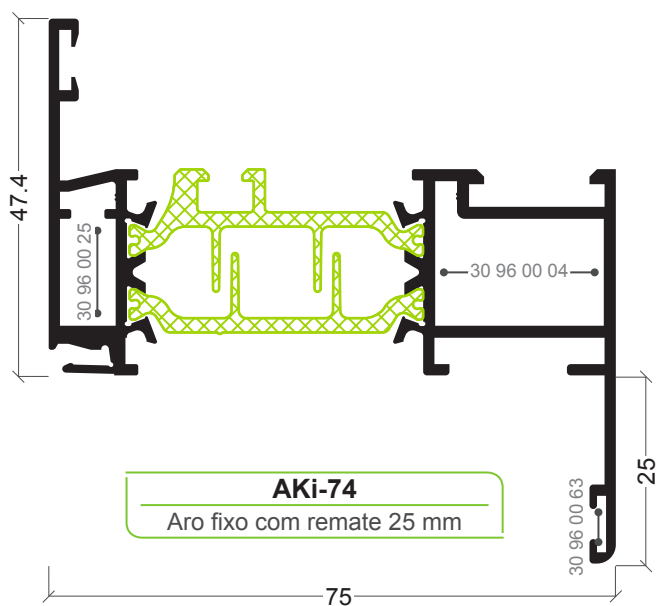

AKi-74
Aro fixo com remate 25 mm

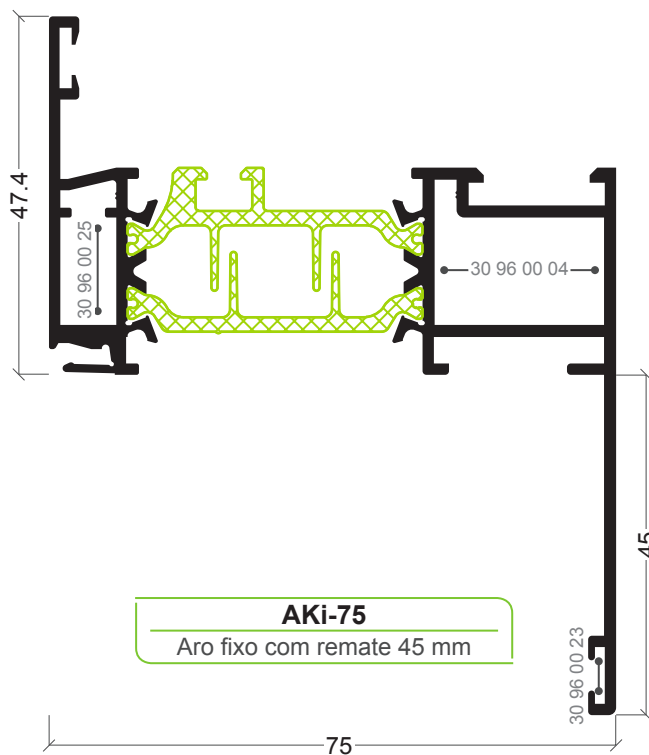

AKi-75
Aro fixo com remate 45 mm

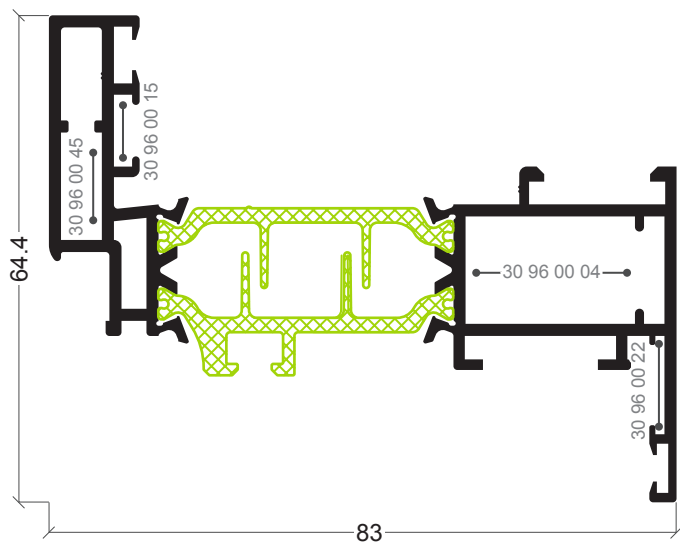

AKi-61
Aro móvel

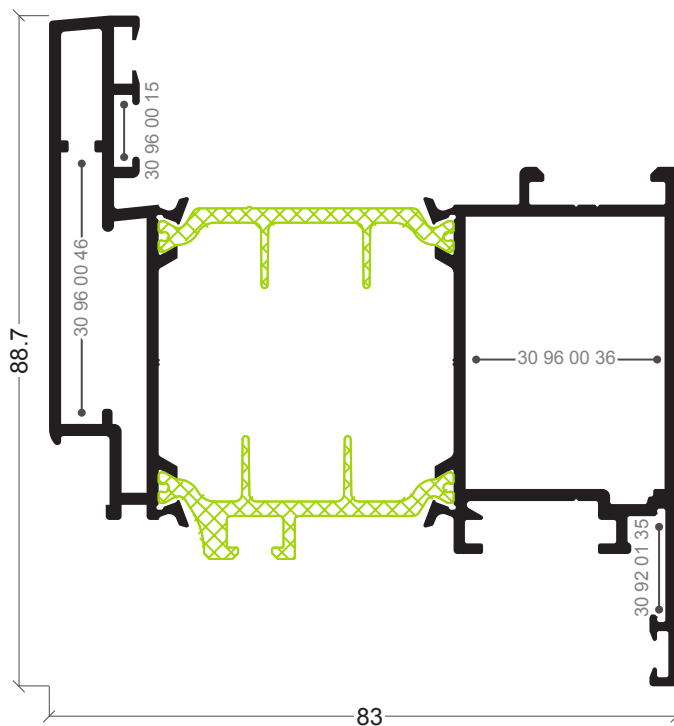

AKi-36
Aro móvel

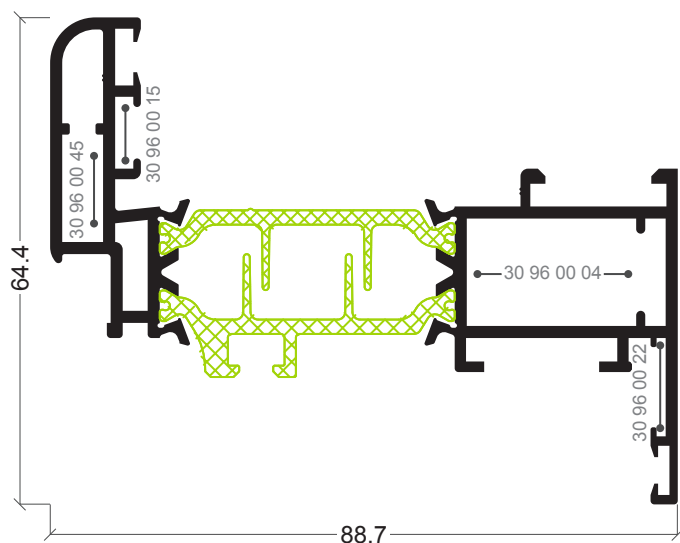

AKi-05
Aro móvel

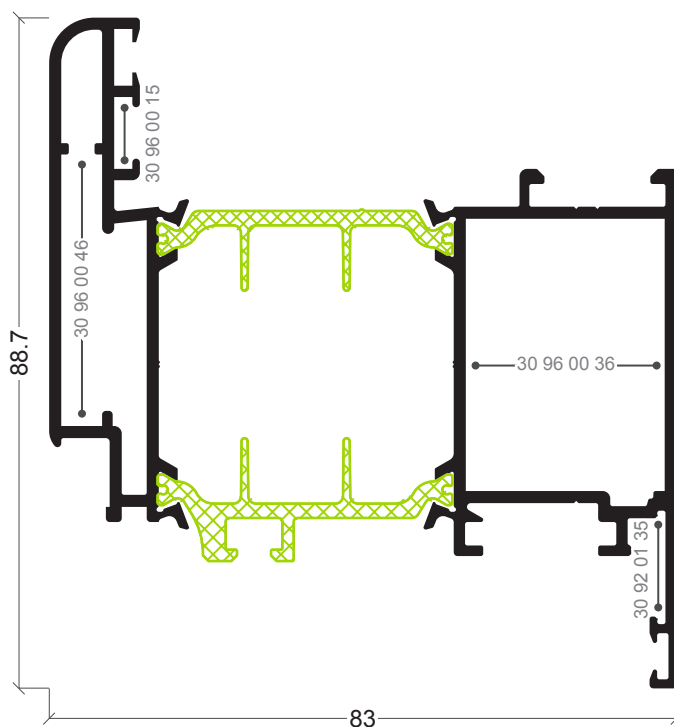

AKi-10
Aro móvel

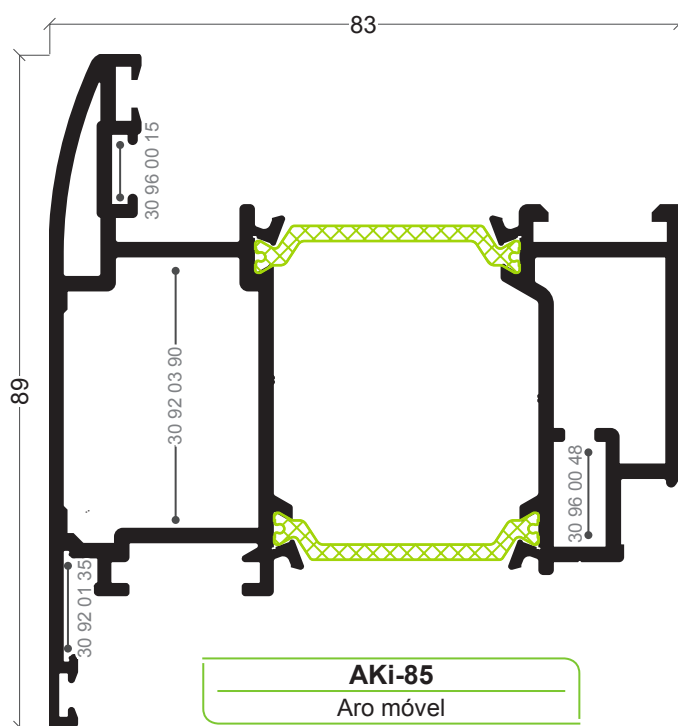
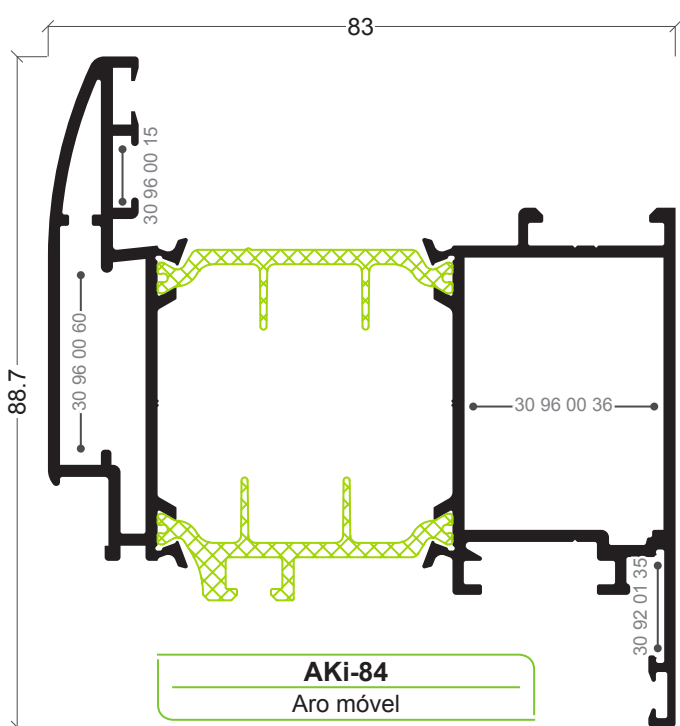
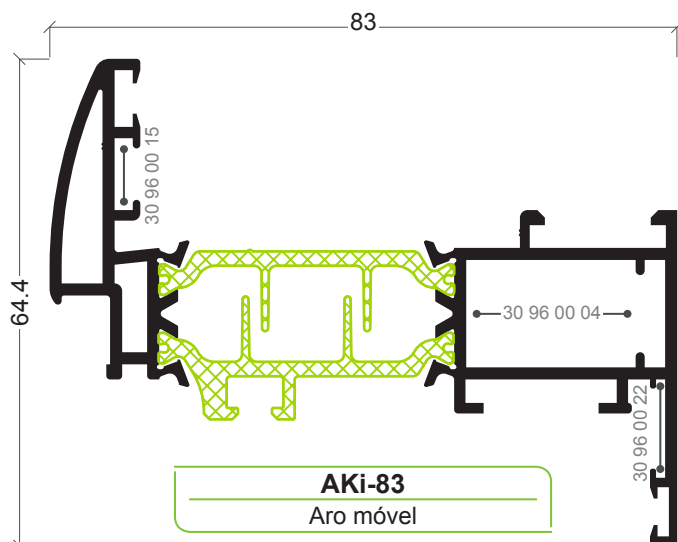
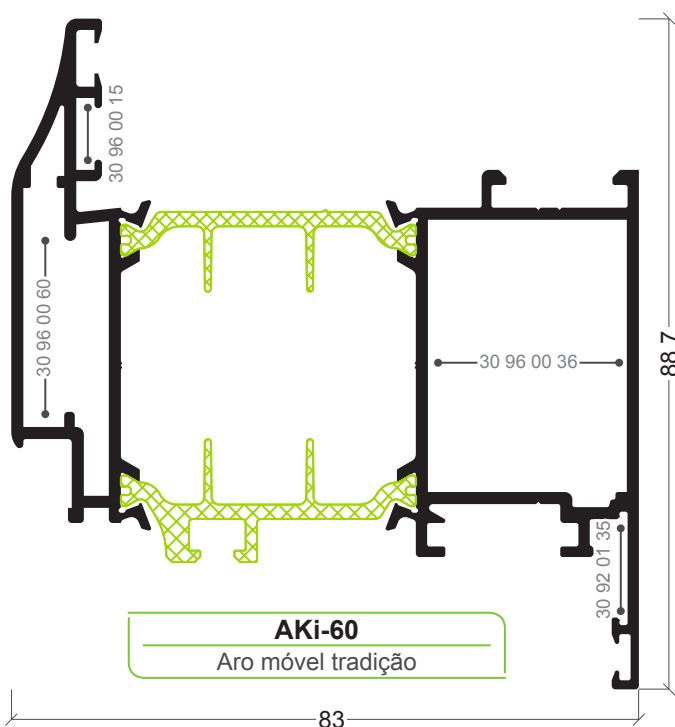
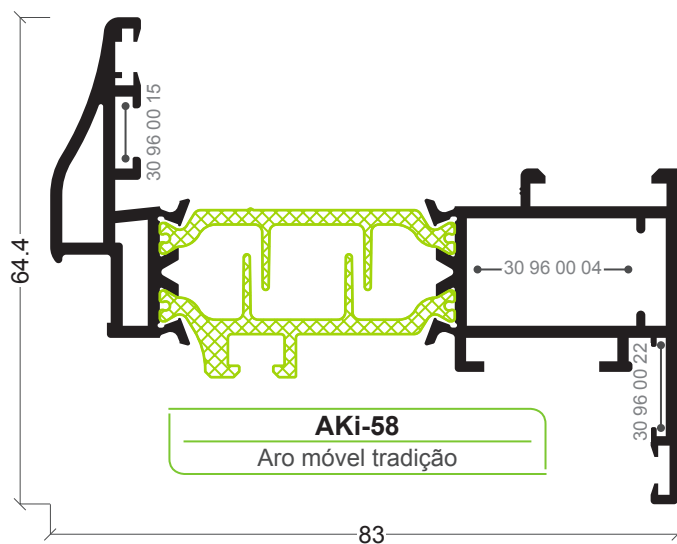

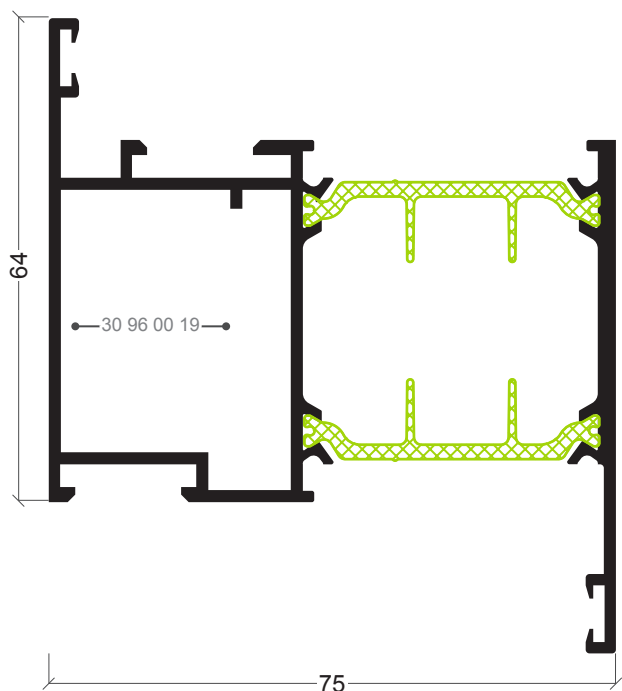

AKi-11
Aro fixo ab.exterior c/ fixo lateral

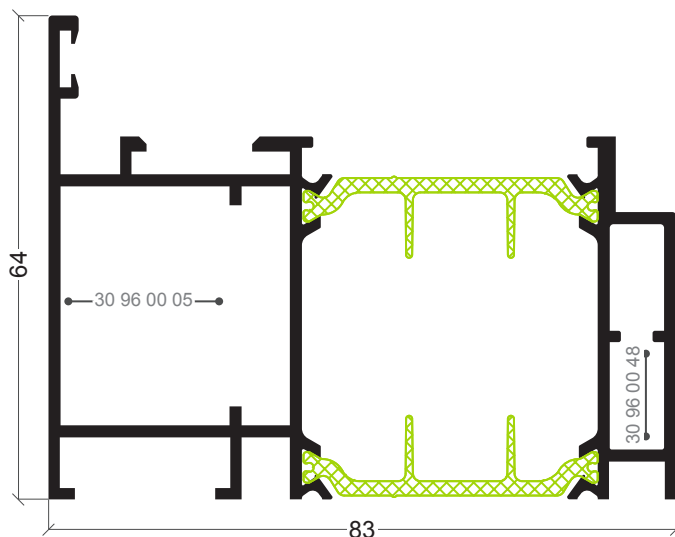

AKi-09
Aro fixo abertura exterior AKi-25

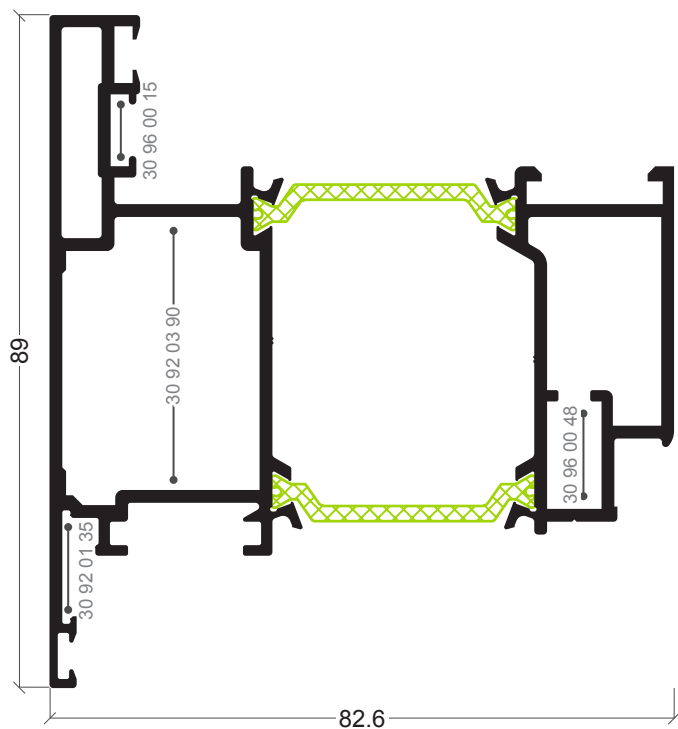

AKi-72
Aro móvel abertura exterior

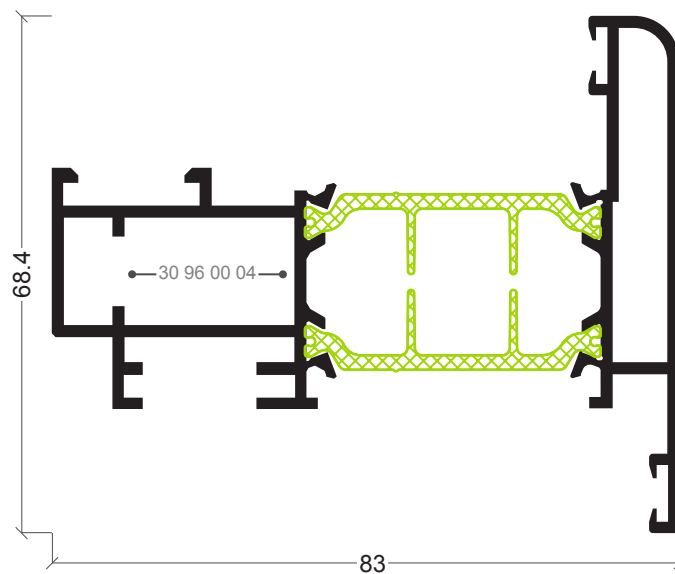

AKi-02
Aro móvel pivotante

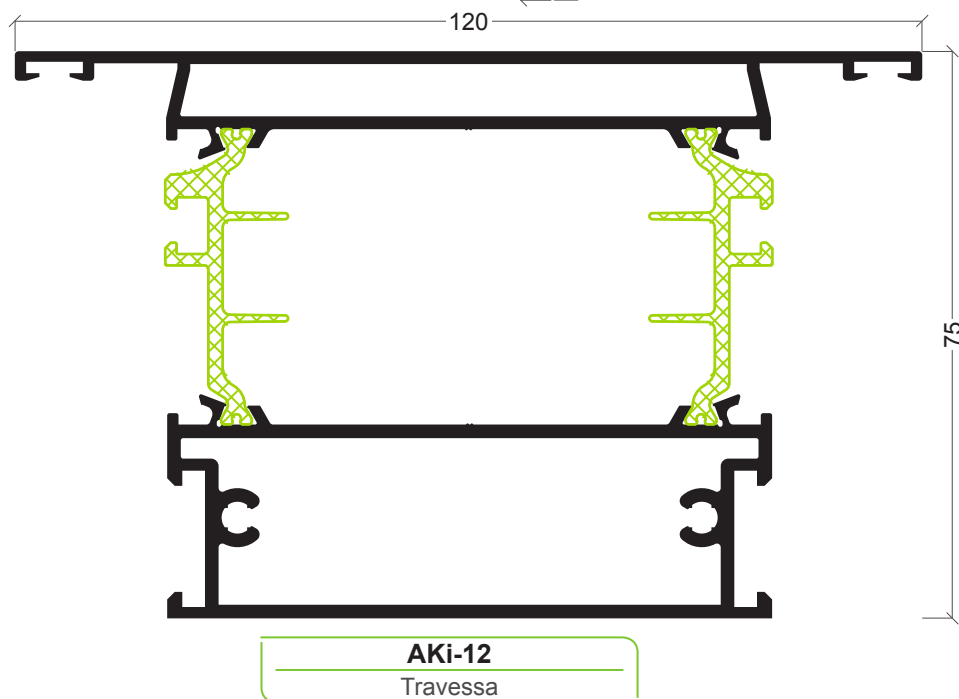
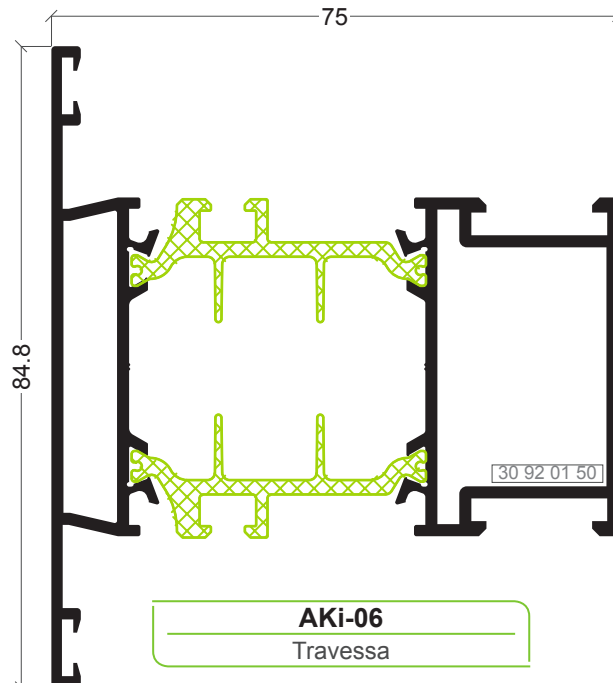
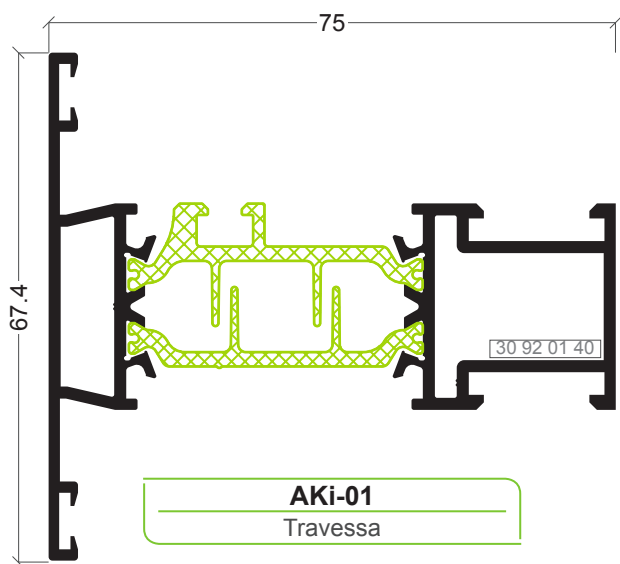
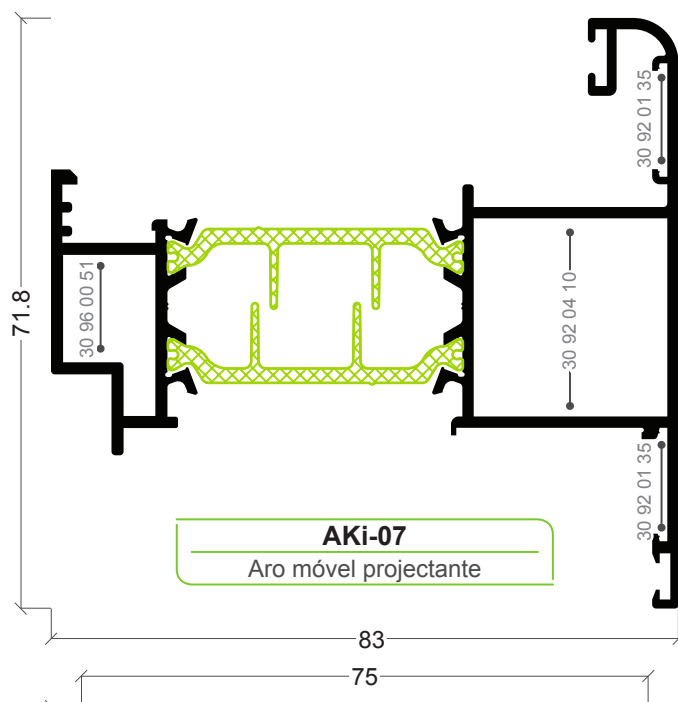
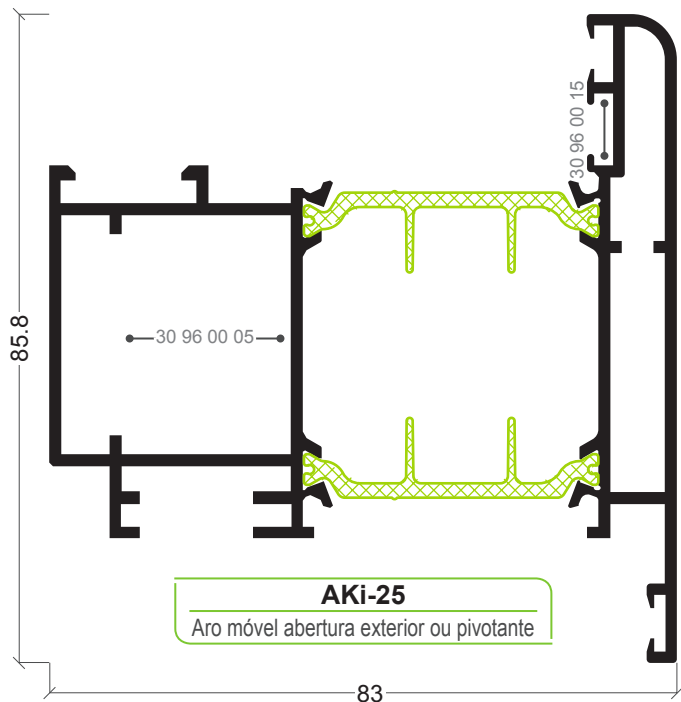

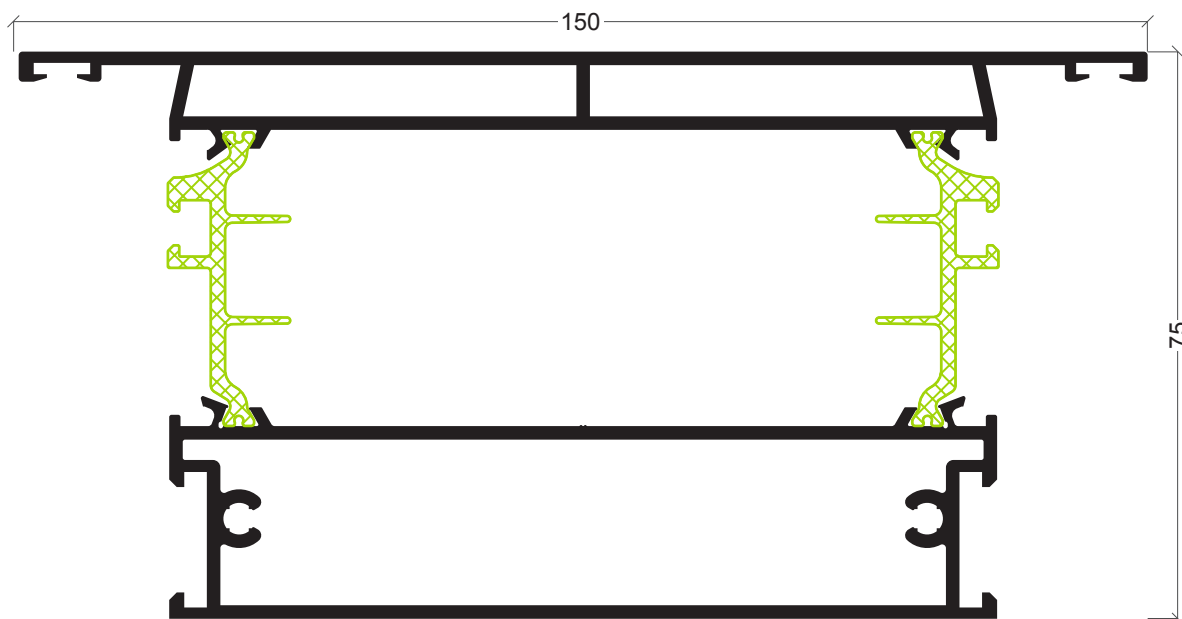

AKi-13
Travessa

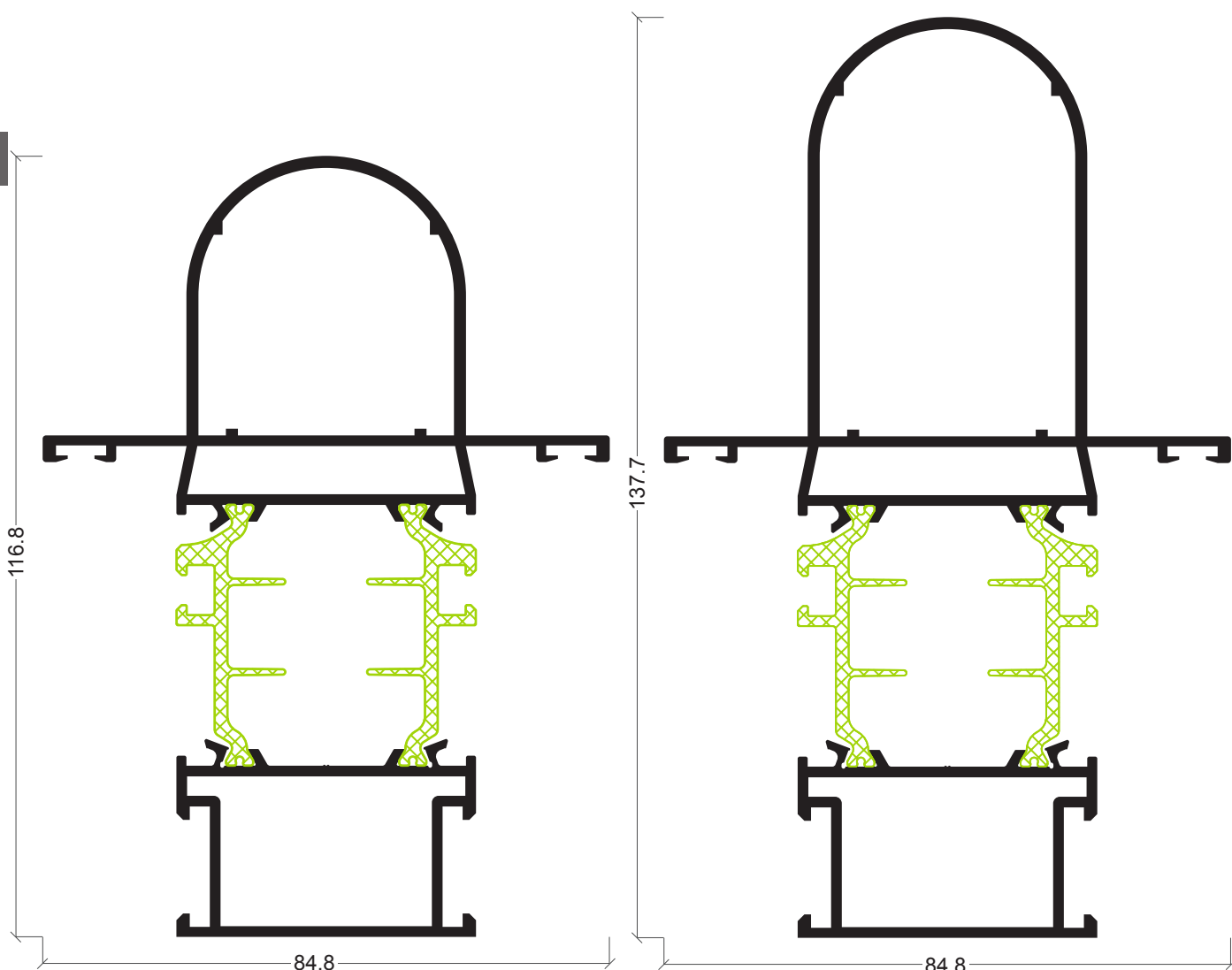

AKi-17
Montante

AKi-18
Montante

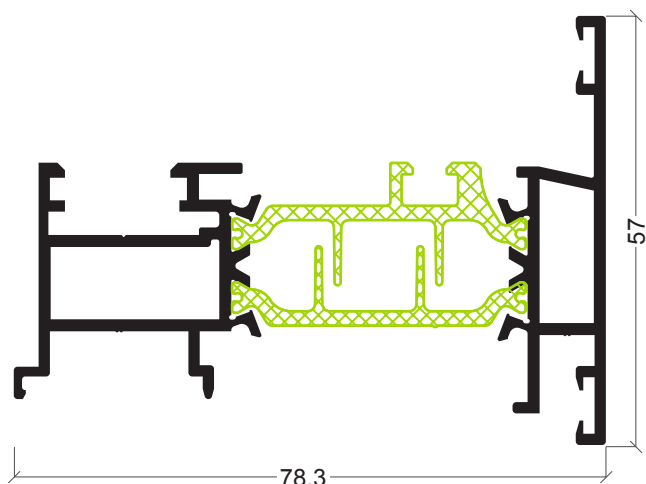

AKi-04
Inversor

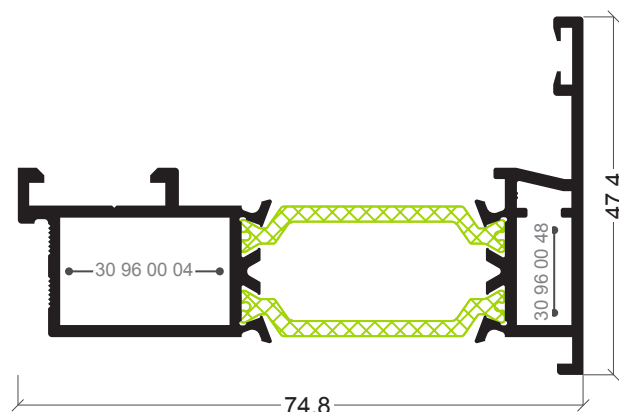

AKi-73
Inversor de sentido de abertura

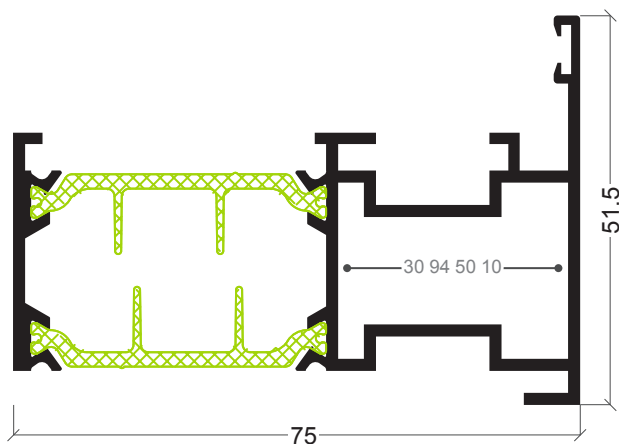

AKi-14
Inversor pivotante

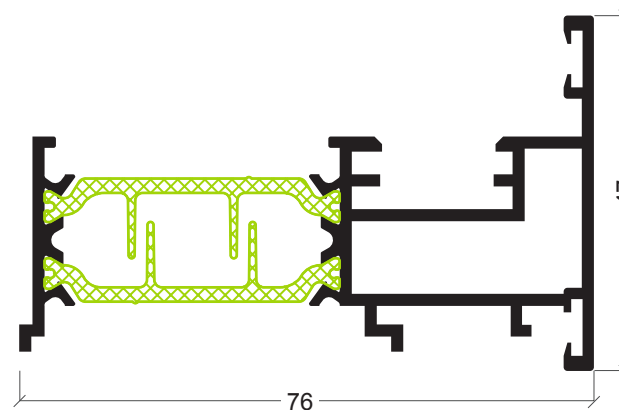

AKi-15
Inversor para AKi-25

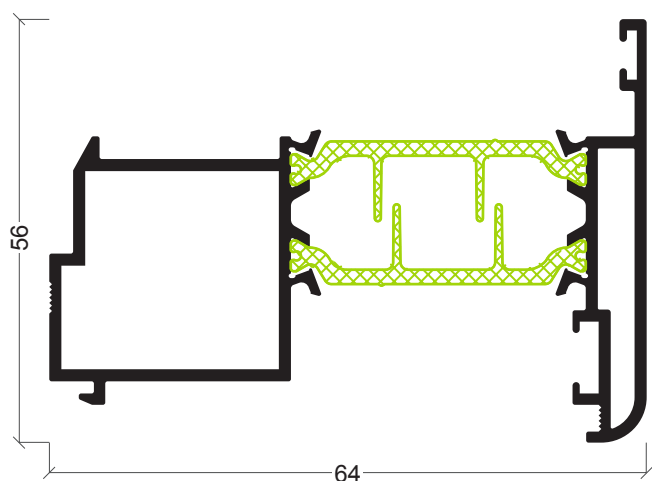

AKi-51
Inversor projectante

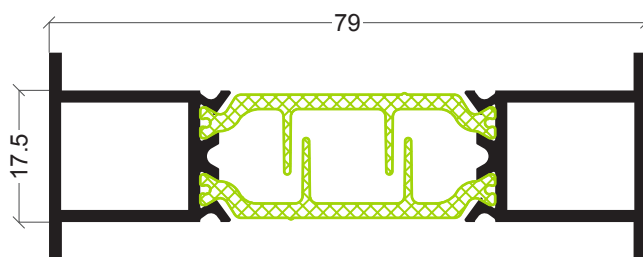

AKi-21
União de aros

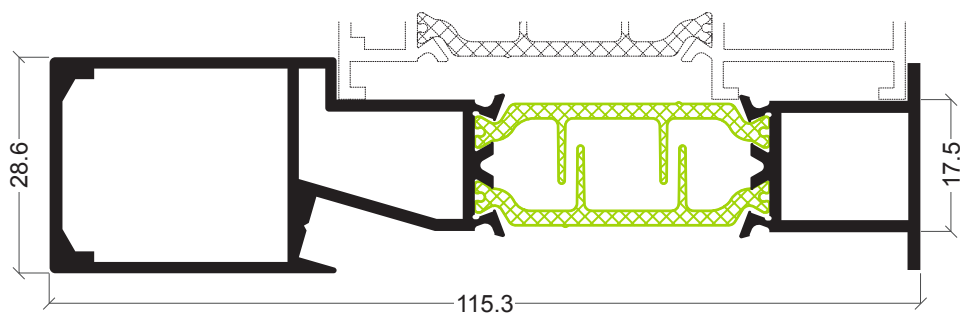

AKi-65
União de aros com reforço

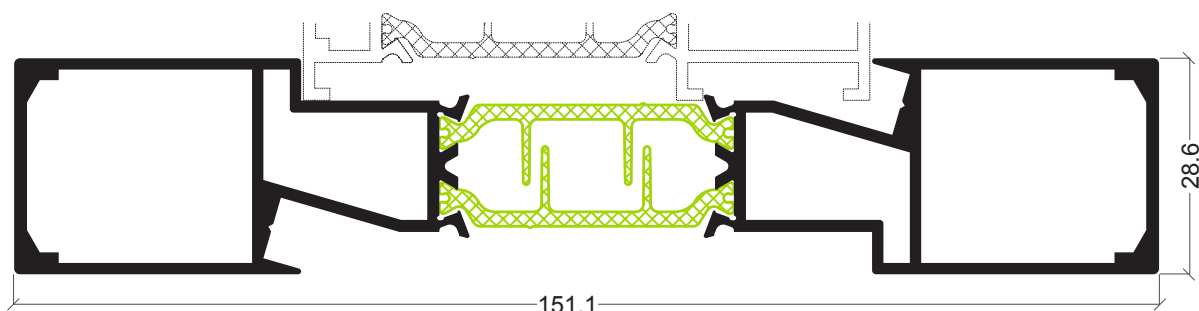

AKi-67
União de aros com reforço

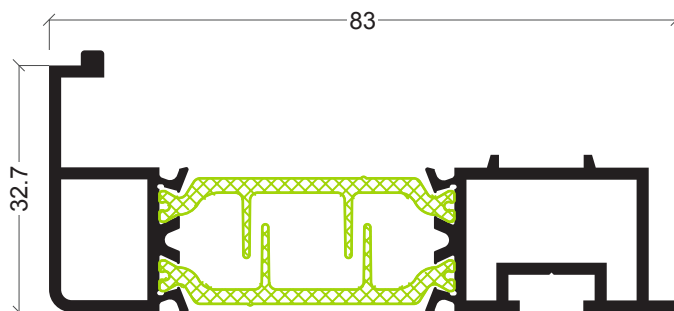

AKi-23
Remate almofada

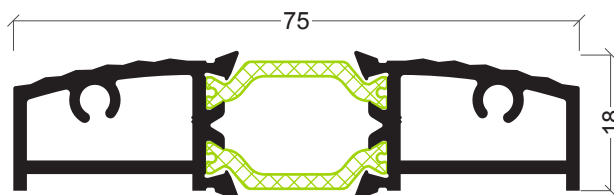

ATi-69
Remate inferior porta

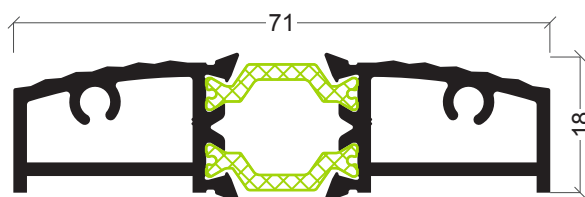

AKi-82
Remate inferior porta

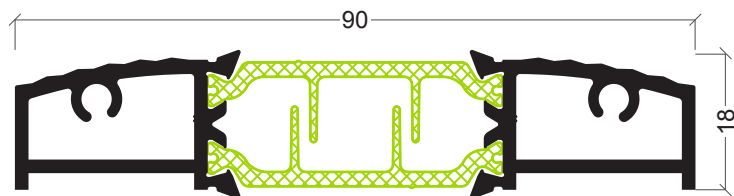

AKi-70
Remate inferior porta

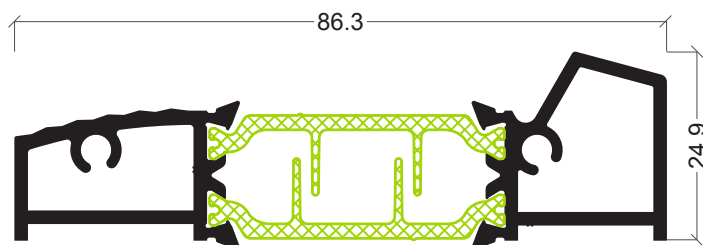

AKi-63
Remate inferior porta

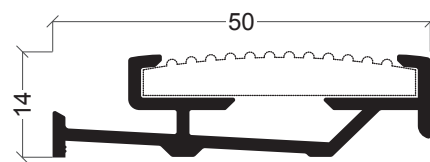

AZ-69
Remate inferior porta

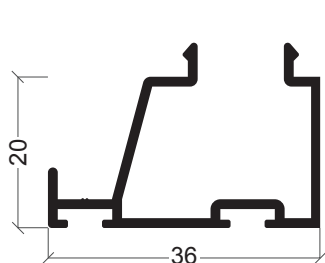

AX-15
Bite remate

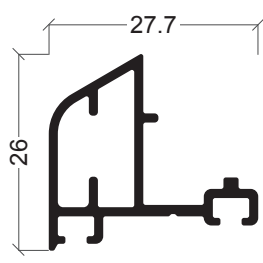

AZ-79
Pingadeira

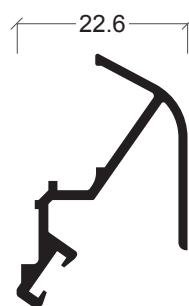

ARi-62
Pingadeira inferior porta

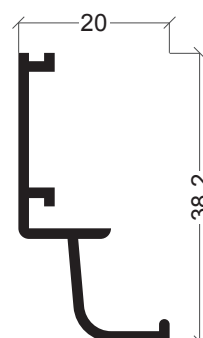

ARi-32
Complemento condensação

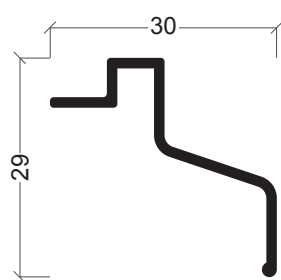

AXi-45
Pingadeira

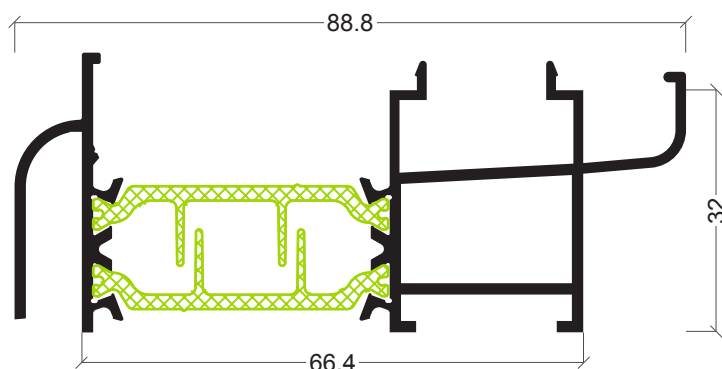

AKi-49
Soleira condensação

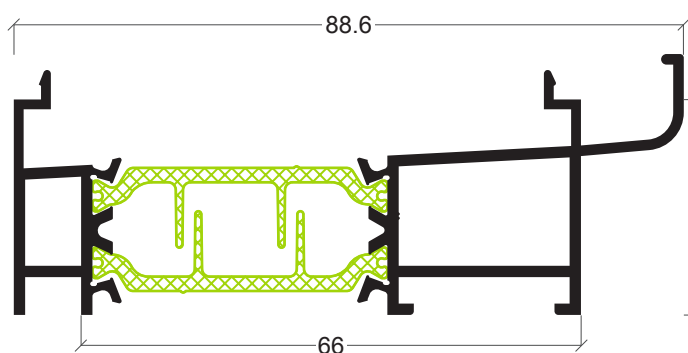

AKi-71
Soleira condensação

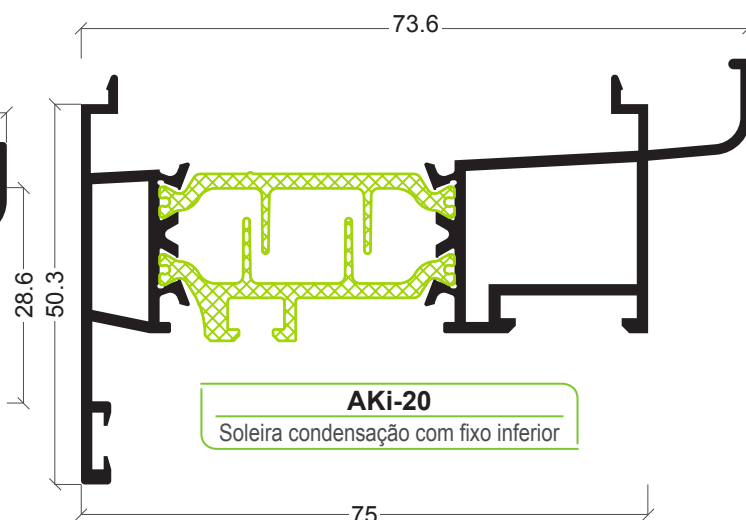

AKi-20
Soleira condensação com fixo inferior

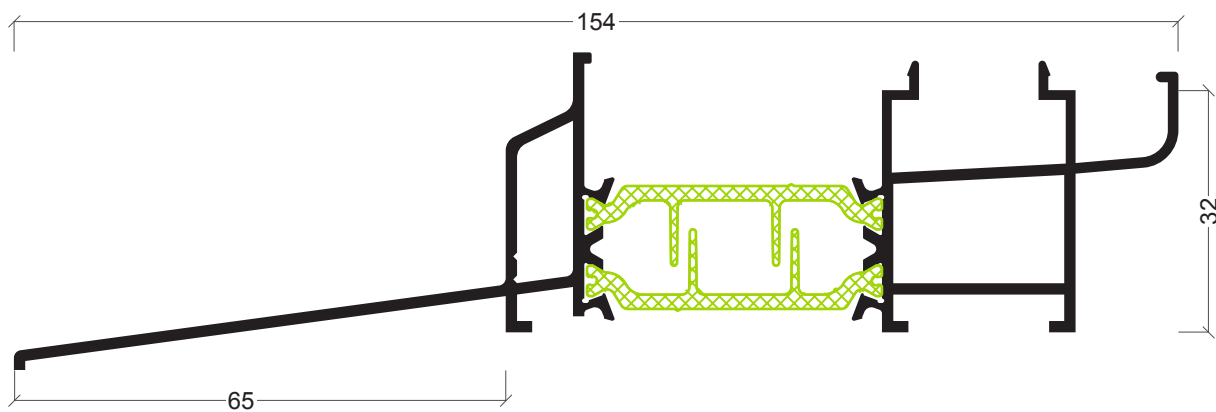

AKi-50
Soleira condensação com pingadeira

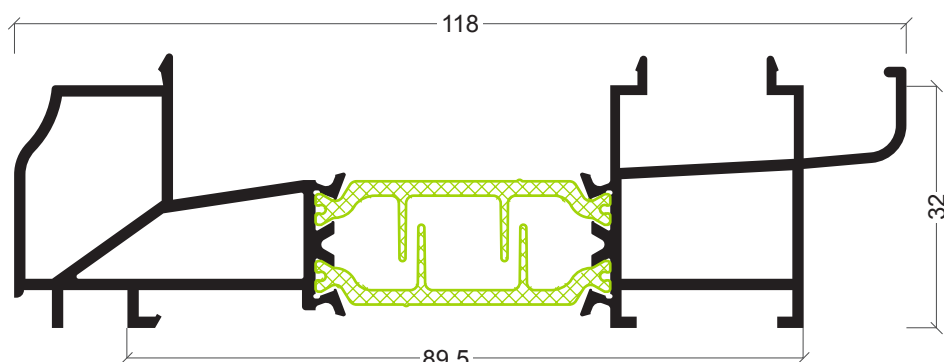

AKi-56
Soleira condensação tradição



AXi-91
Complemento remate

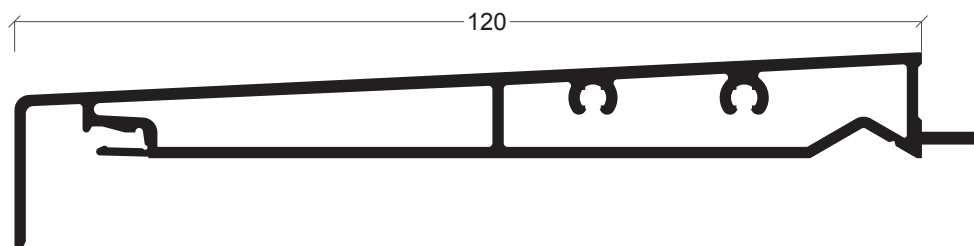

AXi-74
Remate soleira

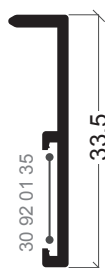

AXi-88
Complemento remate

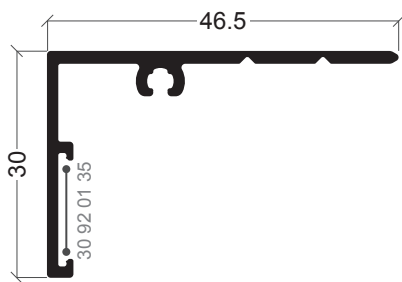

AXi-80
Remate

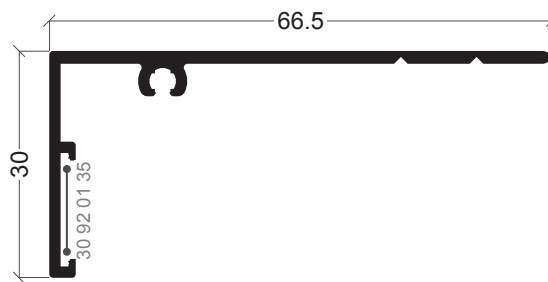

AXi-73
Remate

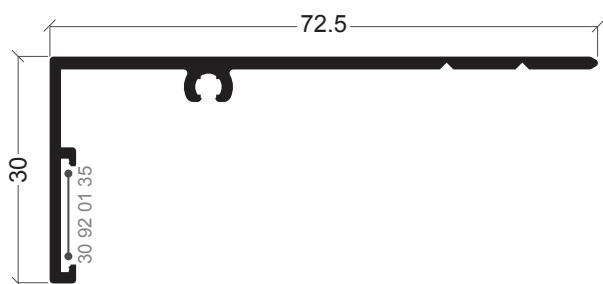

AXi-83
Remate

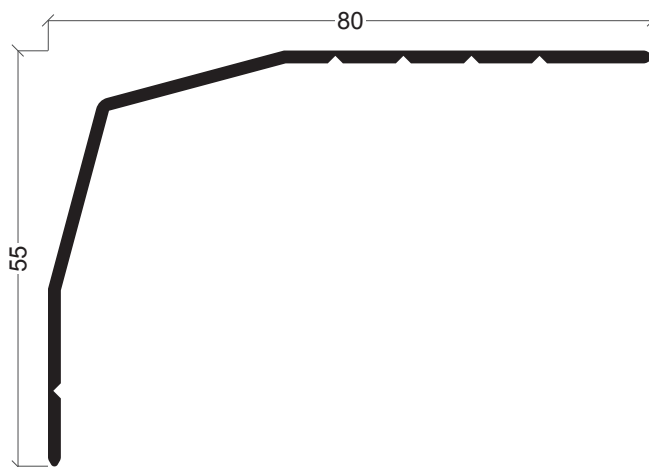

AXi-72
Remate

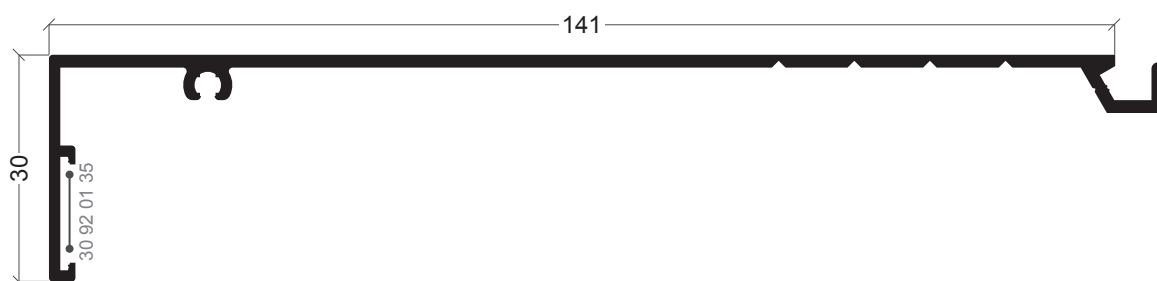

S-09
Remate

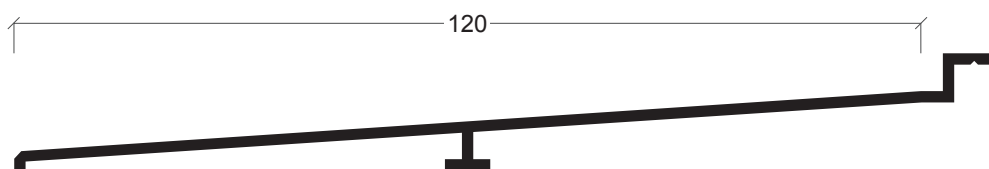

AZ-24
Pingadeira 120 mm

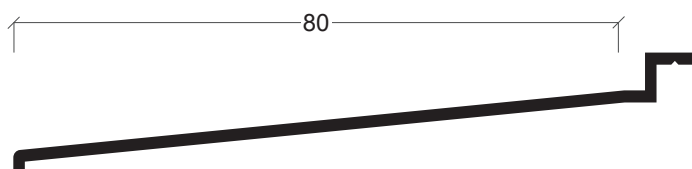

AZ-30
Pingadeira 80 mm

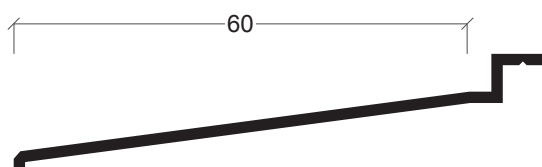

AZ-23
Pingadeira 60 mm

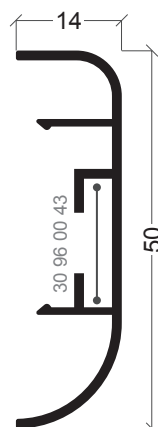

ARi-27
Tapa juntas

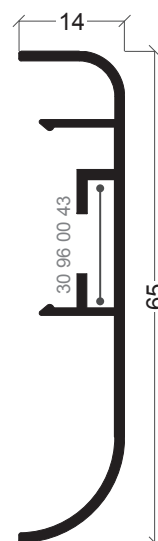

ARi-34
Tapa juntas



ARi-28
Tapa juntas

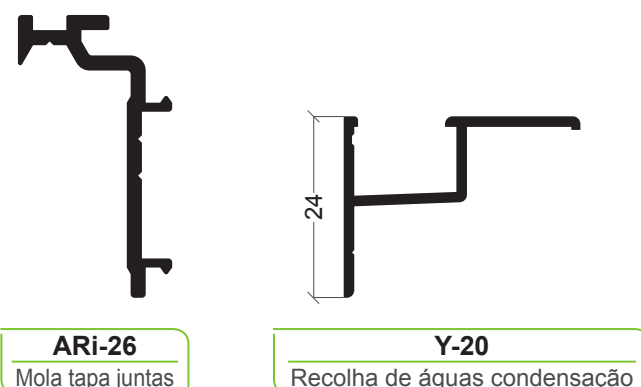
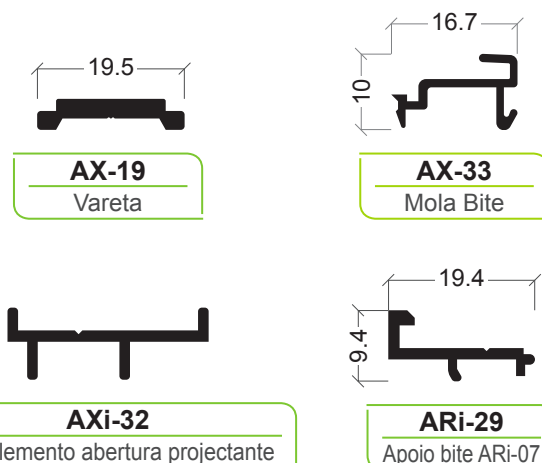
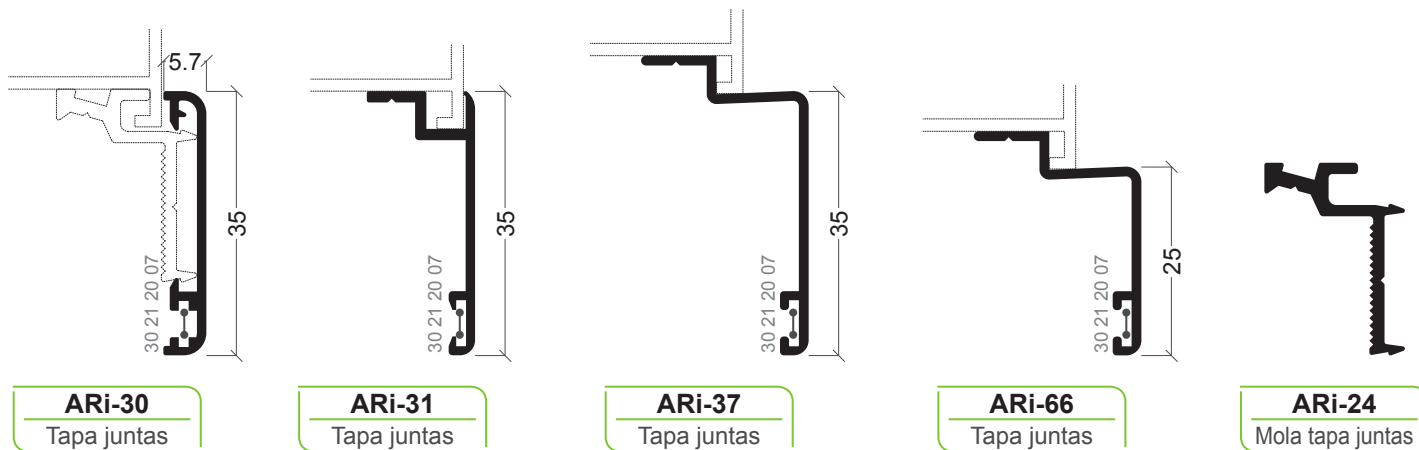

136

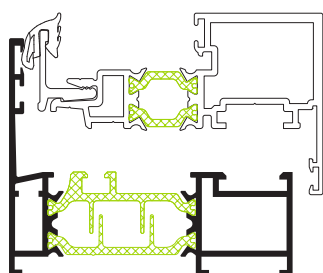
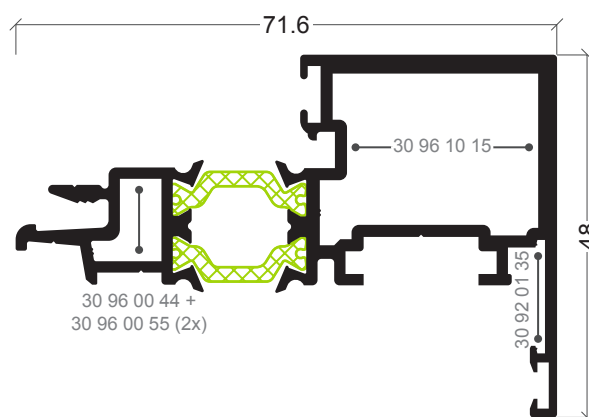
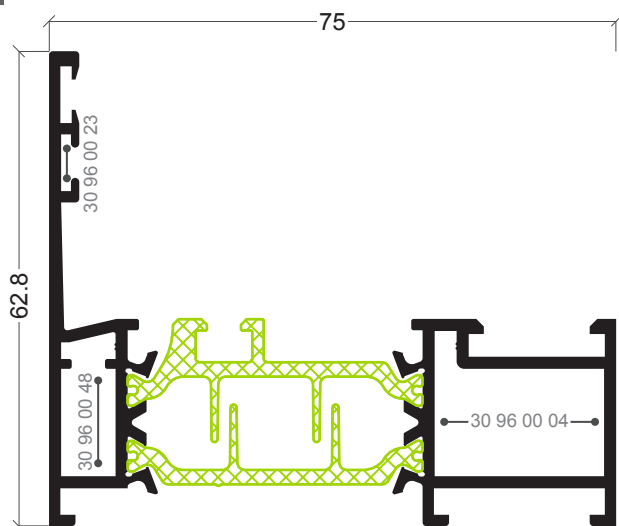

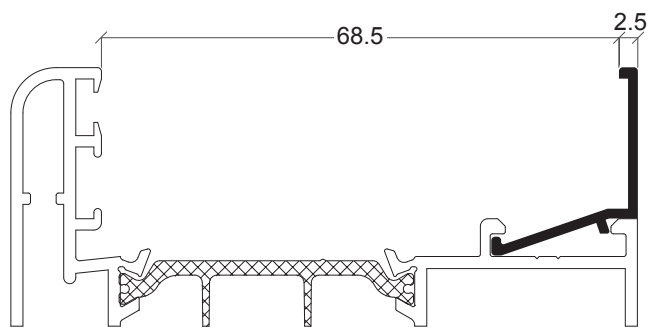

AX-69

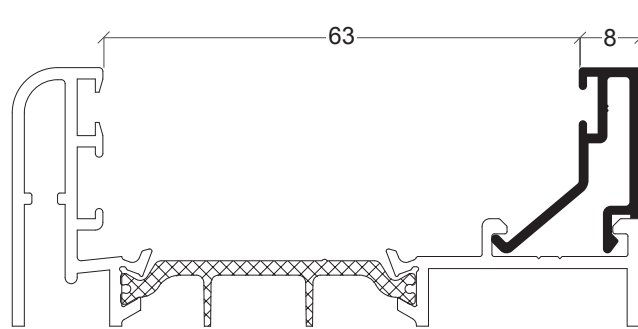

AX-74

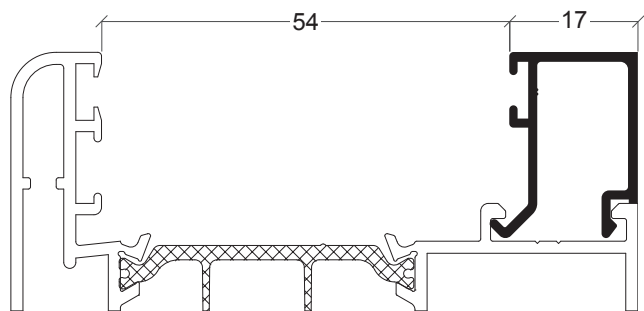

AX-46

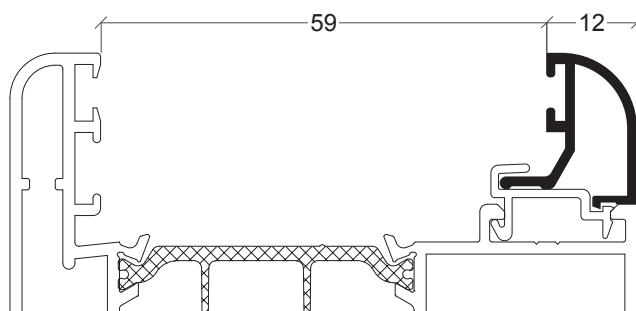

AX-37

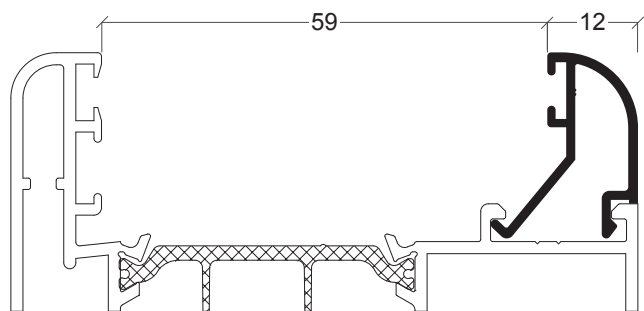

AZ-08

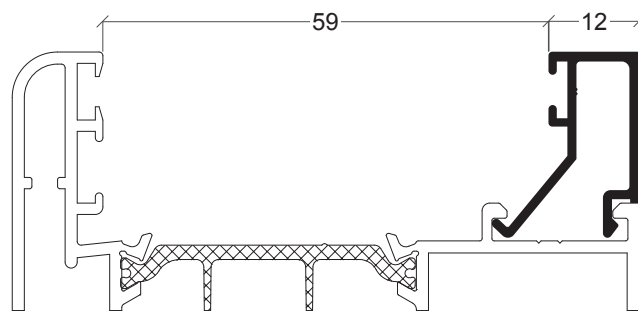

AX-36

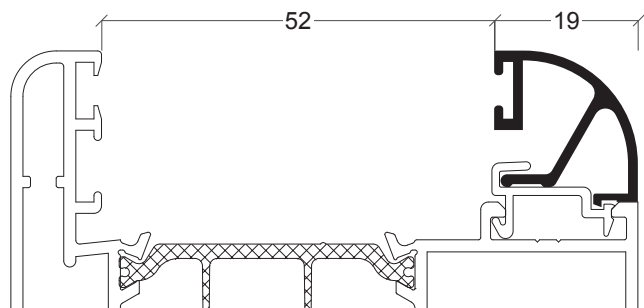

AX-30

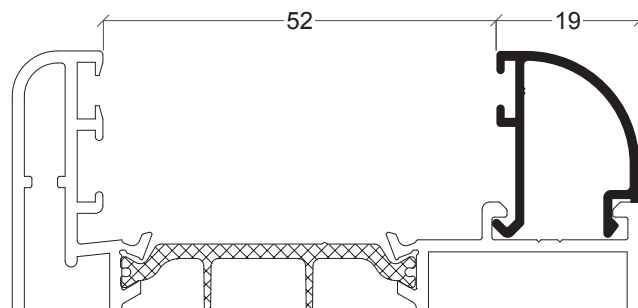

AZ-07

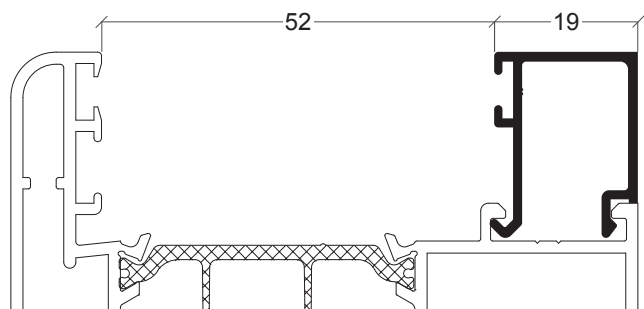

AX-35

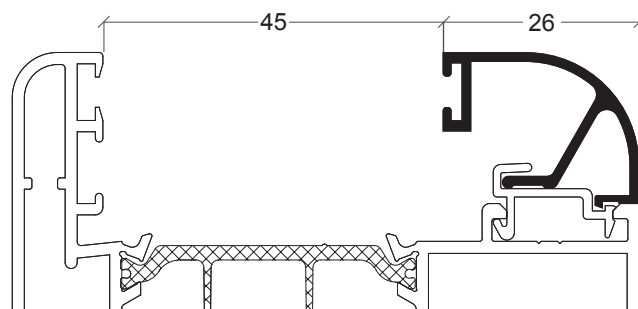

AX-29

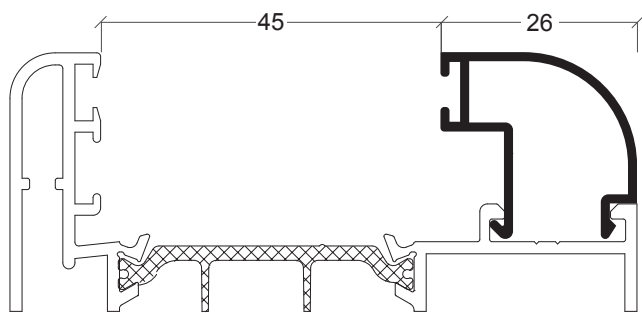

AZ-06

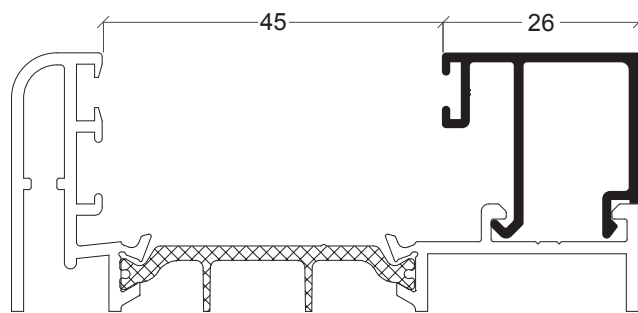

AX-31

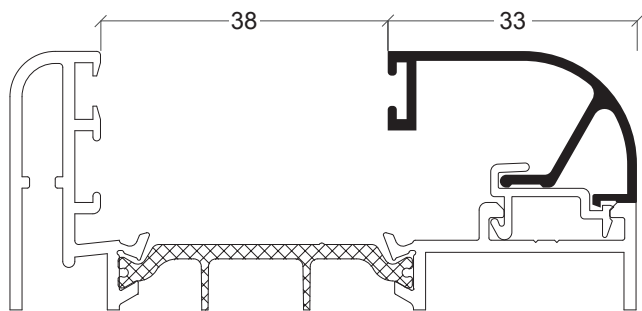

AX-39

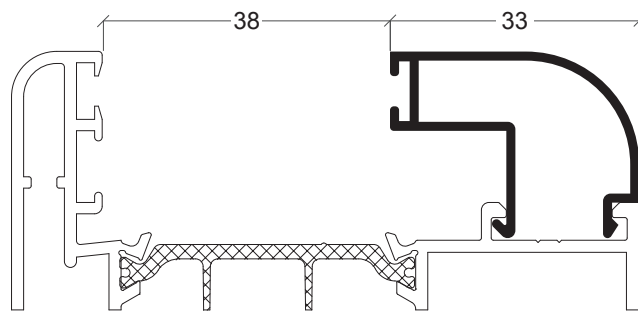

AZ-28

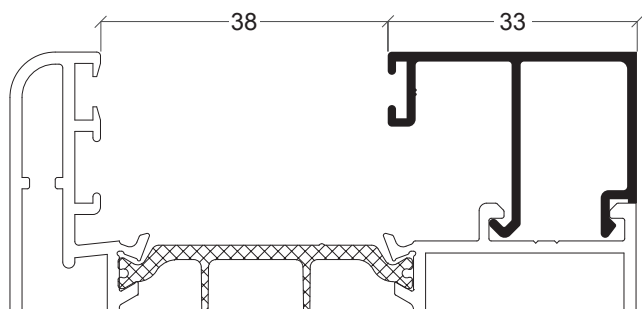

AX-34

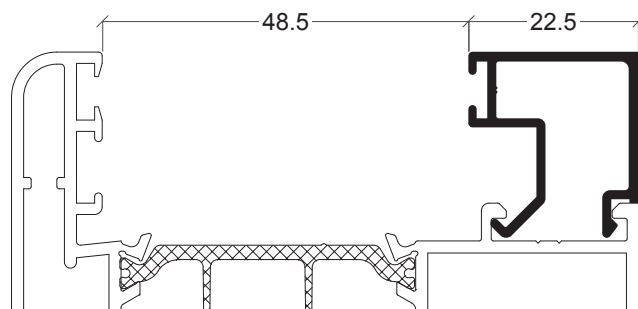

AX-78

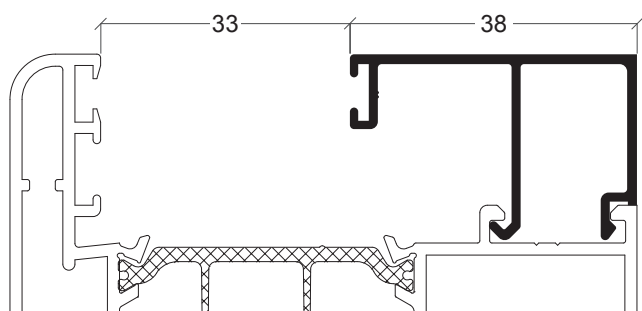

AX-32

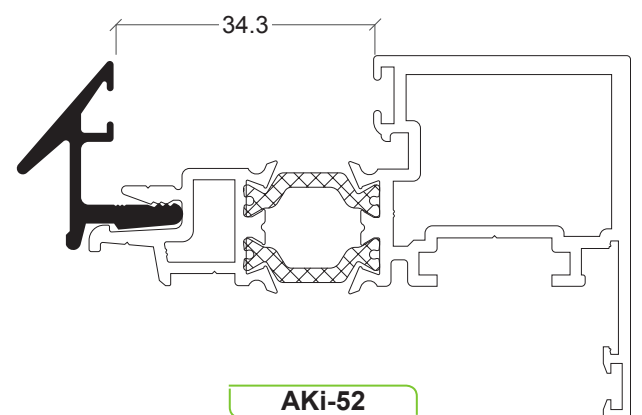

AKi-52

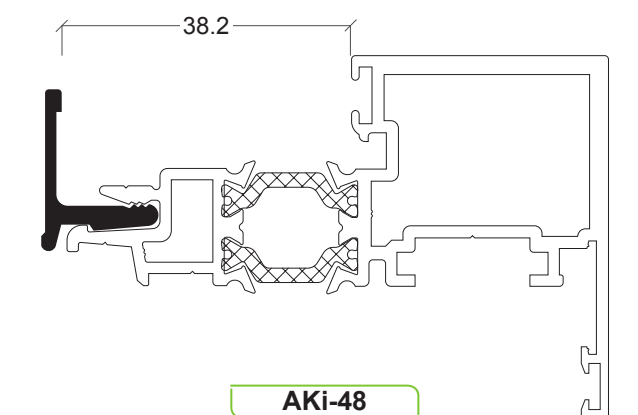

AKi-48

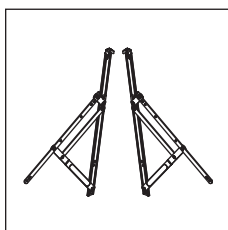

30 00 95 71

Compasso projectante
deslizante até 100 kg/folha

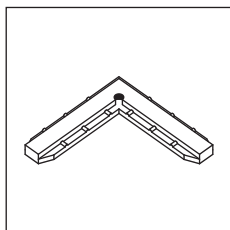

30 21 20 07

Esquadro de
alinhamento

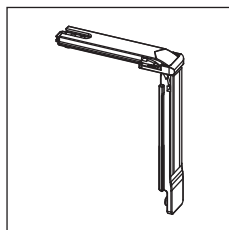

30 90 20 42

Ângulo de reenvio

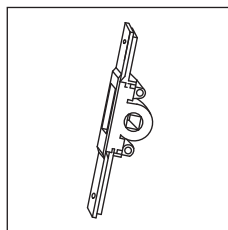

30 90 20 44

Transmissão para
abertura exterior

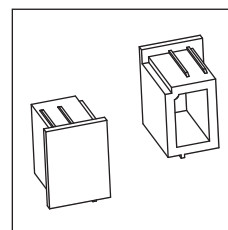

30 91 21 20

Jogo topos condensação
para Y-20

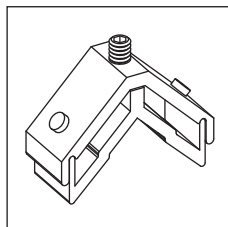

30 91 40 15

Esquadro aro fixo AKi-38

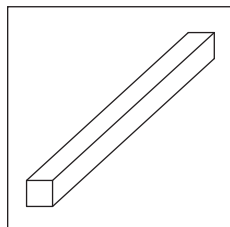

30 91 41 23

Perno 7x131 mm

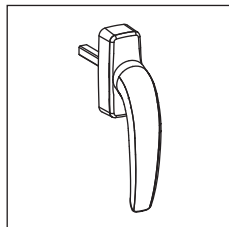

30 91 41 47/48

Cremone pivotante especial
branco/preto

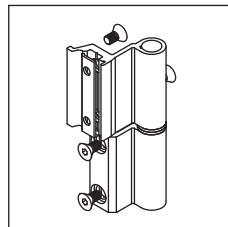

30 92 00 20/21

Dobradiça C.E. branco/
preto

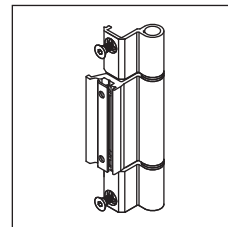

30 92 00 26/27/28

Dobradiça três nós
(bruto/branco/preto)

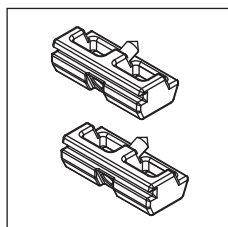

30 92 00 50

Contra-fecho

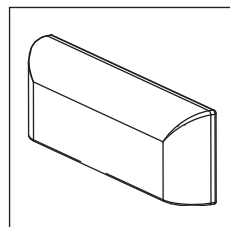

30 92 01 00/01

Goteiras preto/branco

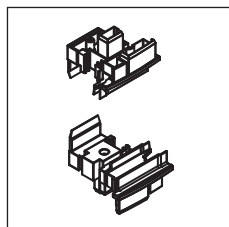

30 92 01 14

Conjunto topos inversor
com furo AKi folha oculta

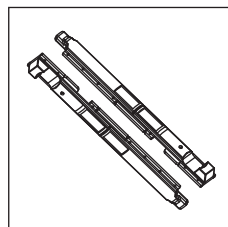

30 92 01 20

Jogo fecho C.E.

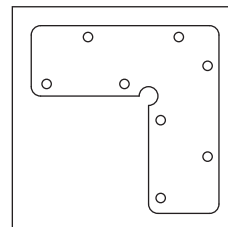

30 92 01 35

Esquadro alinhamento
móvel

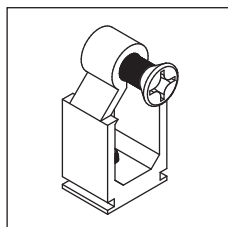

30 92 01 40

União topos janela

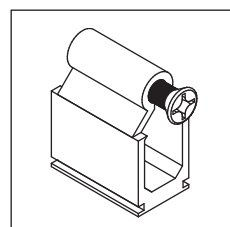

30 92 01 50

União topos porta

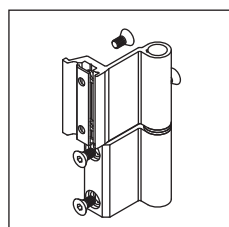

30 92 01 70/80

Dobradiça 3 folhas
branco/preto

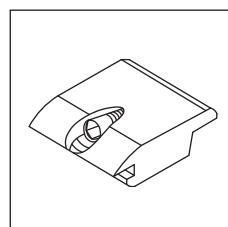

30 92 02 60

Apoio da folha

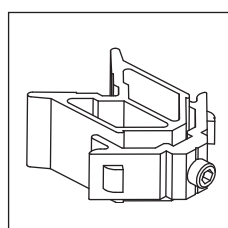

30 92 03 90

Esquadro porta

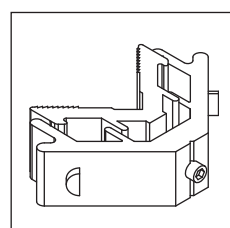

30 92 04 25

Esquadro AKi-80

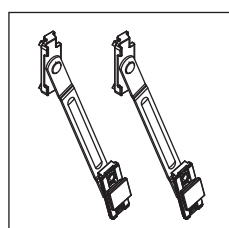

30 92 04 75

Jogo compasso
basculante

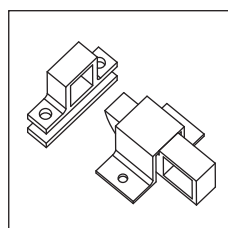

30 92 04 76/77

Fecho clack (branco/
preto)

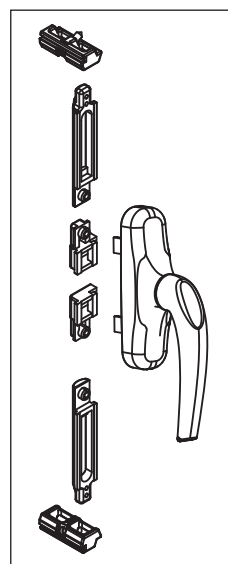

30 92 03 10/11

Kit cremone branco/preto

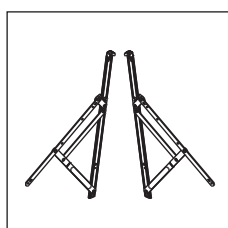

30 92 04 80

Compasso projectante
deslizante até 50 kg/folha

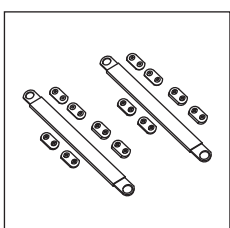

30 92 04 85

Jogo compasso

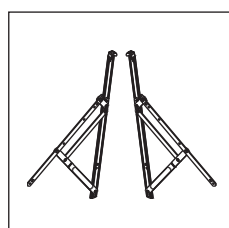

30 92 04 90

Compasso projectante
deslizante até 70 kg/folha

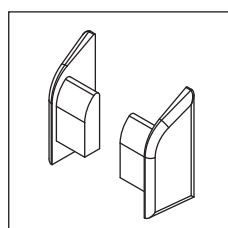

30 92 05 00

Jogo topos AZ-60

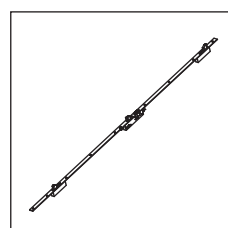

30 92 05 10

Fechadura 3 pontos
(35 mm)

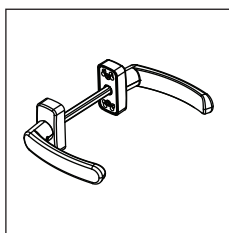

30 92 05 15

Fecho de alavanca com 5 pontos de fecho

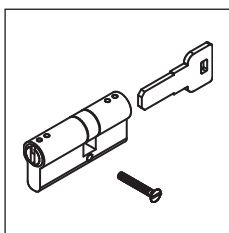

30 92 05 55

Canhão fechadura

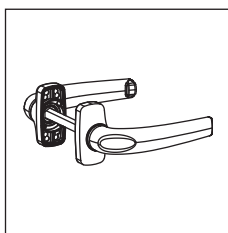

30 92 05 60/61

Puxador duplo branco/preto

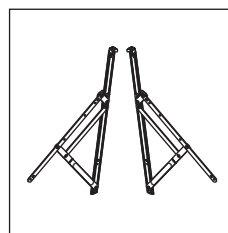

30 92 06 00

Compasso projectante deslizando até 20 kg/folha

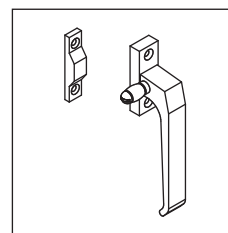

30 92 06 10/11

Cremona de lingueta branco/preto

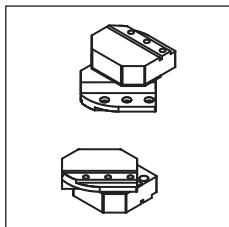

30 92 07 12

Jogo pivotante vertical especial AKi preto (130Kg)

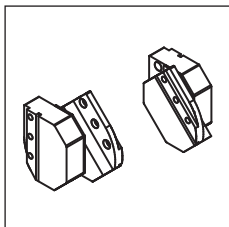

30 92 07 13

Jogo pivotante horizontal especial AKi preto (130Kg)

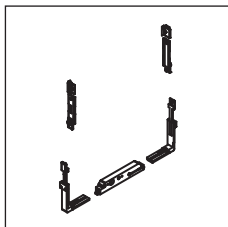

30 92 07 16

Fecho perimetral pivotante especial

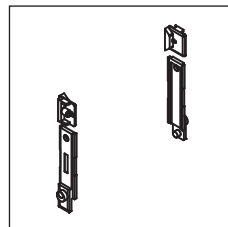

30 92 07 17

Fecho suplementar pivotante especial

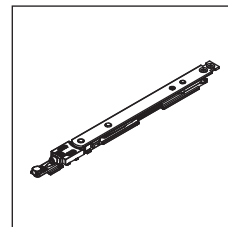

30 92 12 11/12

Compasso oscilo 400/500



30 92 12 13

Compasso suplementar AKi

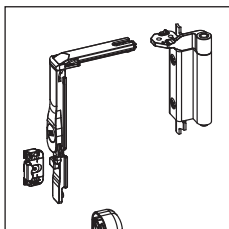

30 92 12 20/21

Kit oscilobatente branco/preto

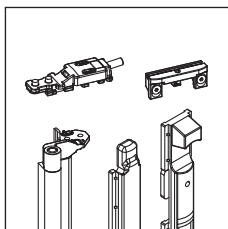

30 92 12 24/25

Kit 2ª folha OB branco/preto

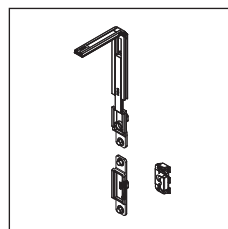

30 92 12 45

Kit fecho 3º ponto AKi

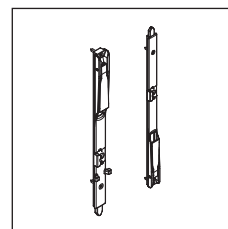

30 92 12 50

Jogo passadores AKi (Zamack)

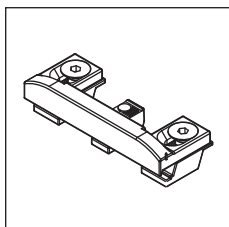

30 92 12 55

Ponto de fecho regulável

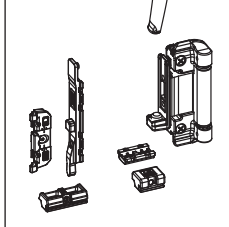

30 95 52 15

Ponto de fecho suplementar

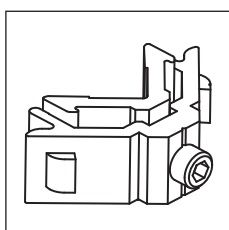

30 96 00 04

Esquadro janela

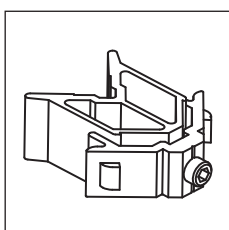

30 96 00 05

Esquadro aro fixo porta

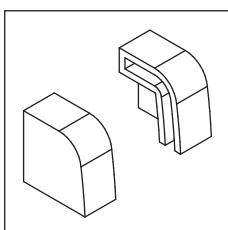

30 96 00 12

Jogo topos condensação

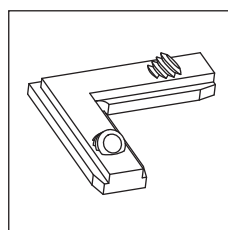

30 96 00 15

Esquadro alinhamento móvel

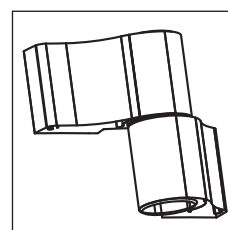

30 96 00 16/20

Dobradiça lisa branco/preto

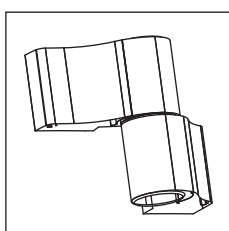

30 96 00 17/21

Dobradiça com ressalto branco/preto

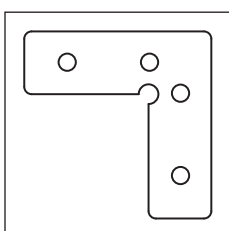

30 96 00 22

Esquadro alinhamento especial

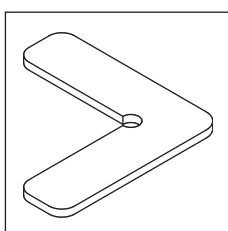

30 96 00 23

Esquadro alinhamento aro fixo

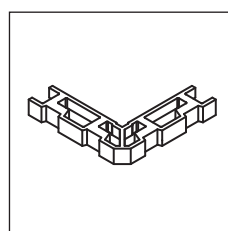

30 96 00 25

Esquadro exterior aro fixo

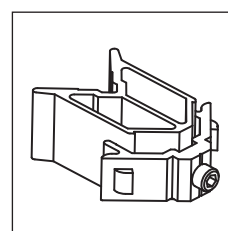

30 96 00 36

Esquadro aro móvel porta

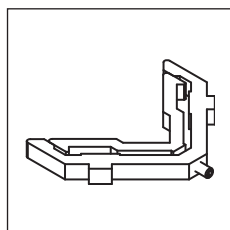

30 96 00 38

Esquadro alinhamento móvel janela

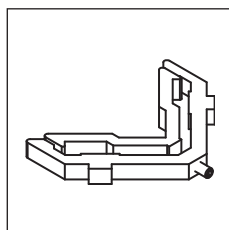

30 96 00 39

Esquadro alinhamento aro fixo janela

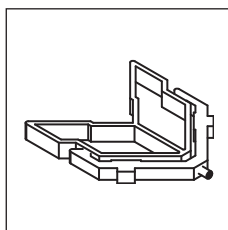

30 96 00 40

Esquadro alinhamento aro fixo porta

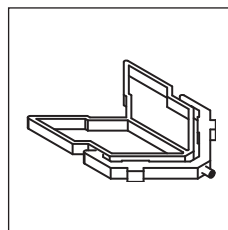

30 96 00 41

Esquadro alinhamento aro móvel porta

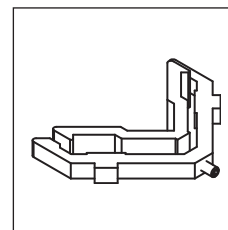

30 96 00 42

Esquadro perfil AKi-07

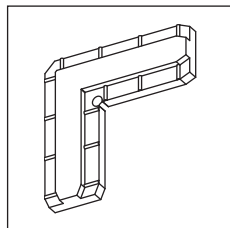

30 96 00 43

Esquadro alinhamento

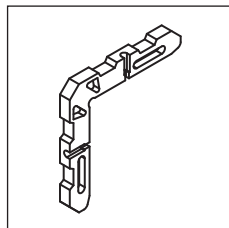

30 96 00 44

Esquadro exterior AKi-78

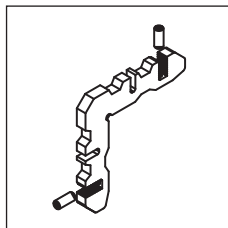

30 96 00 45

Esquadro de alinhamento 5.2x14 com parafusos

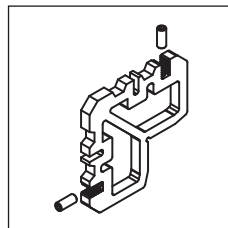

30 96 00 46

Esquadro de alinhamento 5.2x36 com parafusos

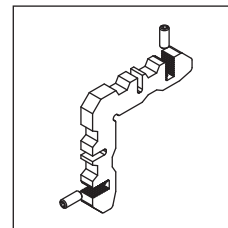

30 96 00 48

Esquadro de alinhamento 7x14 c/ parafusos

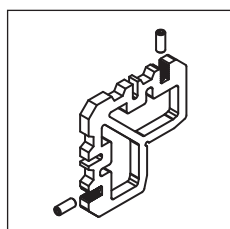

30 96 00 49

Esquadro de alinhamento aro fixo com parafusos

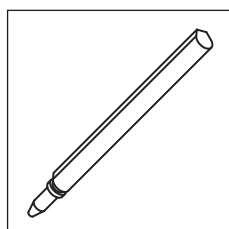

30 96 00 55

Perno alternativo para fixação de esquadro

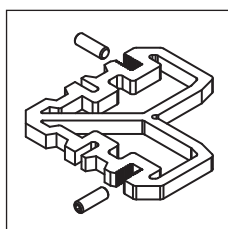

30 96 00 60

Esquadro de alinhamento 5.2x31.6 com parafusos

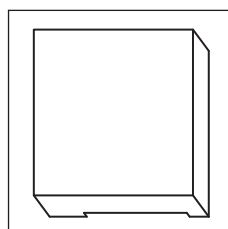

30 96 10 01

Calço para vidro

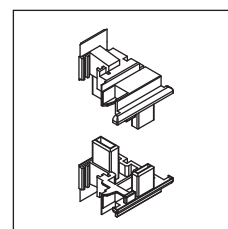

30 96 10 08

Jogo topos inversor AKi-04

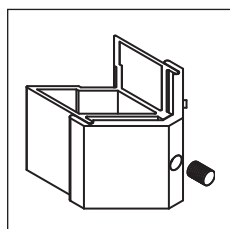

30 96 10 15

Esquadro interior AKi-78

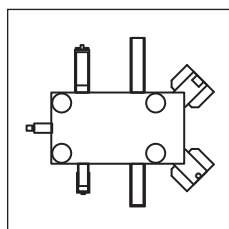

33 20 70 03

Cunho AKi folha oculta 3D

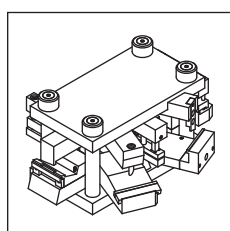

33 96 79 99

Cunho C.E.

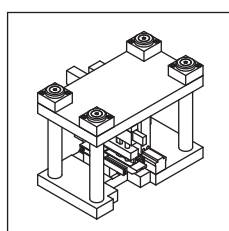

33 96 87 99



Cunho esquadro interior e exterior ARI/AKi

Referência	Desenho	Descrição
30 00 95 15		Junta vedação interior curta
30 20 26 03		Junta vedação vidro
30 20 70 03		Pelúcia remate porta 11x12 mm
30 60 00 17		Junta exterior vidro plana 2 mm preto
30 92 04 70		Espuma isolante
30 93 00 60		Vedante exterior de vidro (opcional)
30 93 00 61		Junta vedação exterior vidro 2 mm
30 93 00 62		Junta plana para vidro
30 93 00 65		Junta interior para vidro (5 mm)
30 93 00 66		Junta interior para vidro (4 mm)
30 93 00 67		Junta interior para vidro (2 mm)
30 93 00 68		Junta interior para vidro (6/7 mm)
30 93 00 69		Junta interior para vidro (8/9 mm)
30 93 00 70		Vedante interior de vidro (opcional)
30 93 00 80		Junta de vedação inferior AKi-42
30 93 00 82		Junta vedação inferior
30 93 01 20		Junta interior
30 93 01 30		Junta exterior (abertura exterior/projectante)
30 95 00 10		Pelúcia 7x9 mm
30 96 00 02		Junta exterior
30 96 00 18		Junta interior (abertura projectante/deslizante)
30 96 00 27		Junta exterior folha oculta 1D
30 96 10 04		Junta central
30 96 10 05		Junta vedação AKi - folha oculta 3D
30 96 10 09		Junta central AKi-09/AKi-25
30 96 10 12		Junta isolante

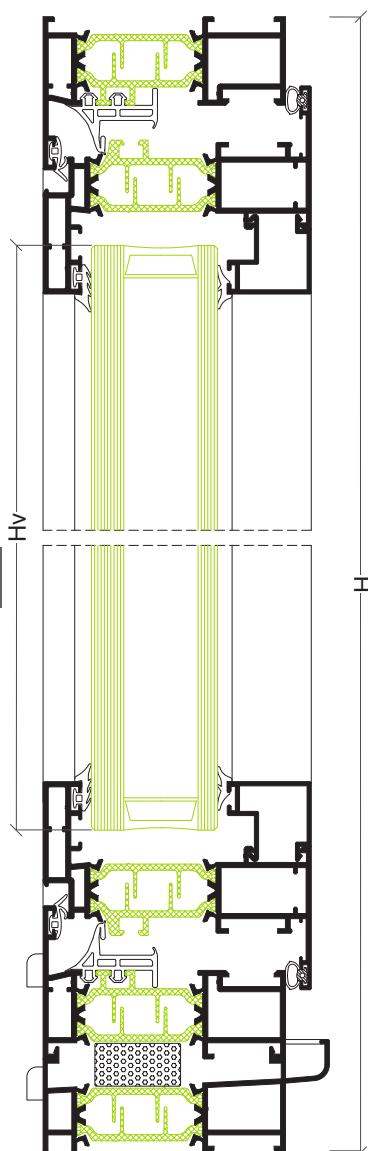
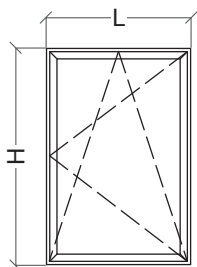
Janela 1 folha abrir e oscilo-batente

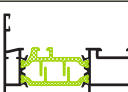

Perfis

Desenho	Ref	Descrição	Corte	Quant	Medida
	AKi-03	Aro fixo		2	L
				2	H-28.5 mm
	AKi-61	Aro móvel		2	L-43 mm
				2	H-71.5 mm
	---	Bite		2	L-132 mm
				2	H-200.5 mm
	AKi-71	Soleira condensação		1	L
	AX-19	Vareta		1+1	Apro. H+L

Acessórios e Juntas

Referência	Descrição	Quantidade	
		Abrir	Oscilo-batente
30 92 00 20	Dobradiças C.E.	2	---
30 92 01 00	Goteiras	4	4
30 92 12 XX	Compasso O.B.	---	1
30 92 12 20	Kit oscilo-batente	---	1
30 92 02 60	Apoio da folha	1	---
30 92 03 10	Kit cremone	1	---
30 96 00 04	Esquadro janela	8	8
30 96 00 48	Esquadro alinhamento aro fixo	4	4
30 96 00 12	Jogo topos condensação	1	1
30 96 00 15	Esquadro alinhamento móvel	4	4
30 96 00 22	Esquadro alinhamento móvel	4	4
30 96 00 45	Esquadro alinhamento exterior móvel	4	4
30 96 10 01	Calço para vidro	4	4
30 92 04 70	Espuma isolante	L	
30 96 00 02	Junta exterior	2L+2H	
30 96 10 04	Junta central	2L+2H	
30 93 01 20	Junta interior	2L+2H	
---	Junta exterior vidro	2L+2H	
---	Junta interior vidro	2L+2H	

Vidro

Hv = H-174 mm	Lv = L-146 mm
---------------	---------------

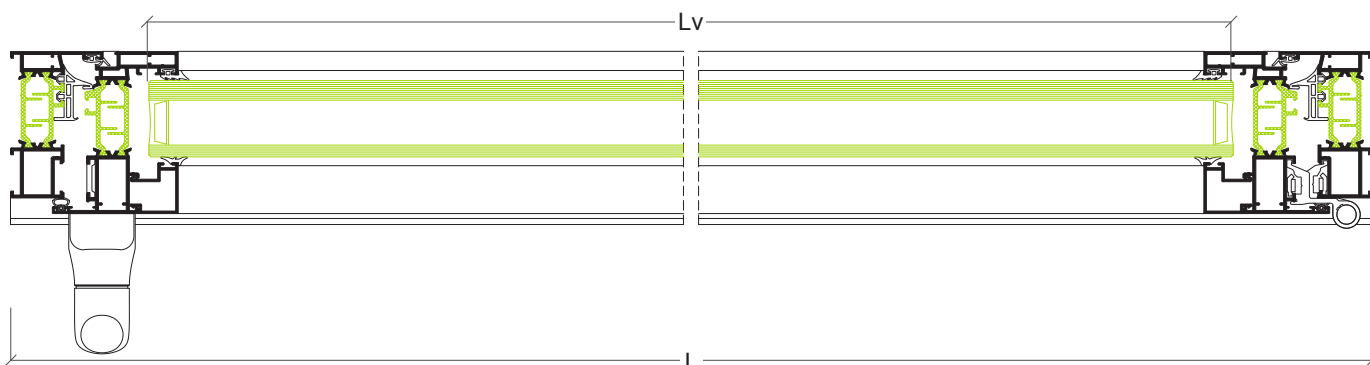

Janela 2 folhas abrir e oscilo-batente

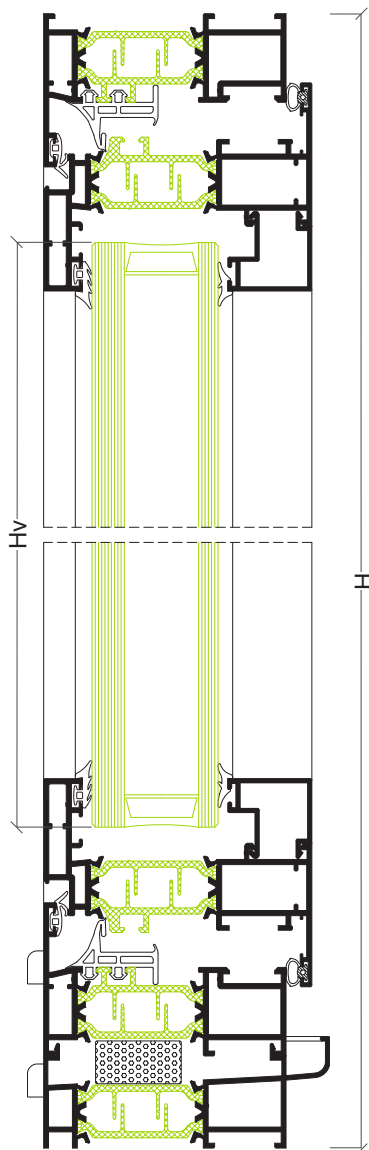
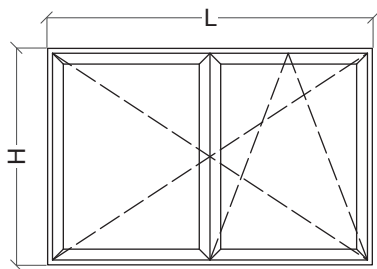

Perfis

Desenho	Ref	Descrição	Corte	Quant	Medida
	AKi-03	Aro fixo		2	L
				2	H-28.5 mm
	AKi-61	Aro móvel		2	L/2-24 mm
				2	H-71.5 mm
	AKi-04	Inversor		1	H-139.5 mm
	---	Bite		4	L/2-113 mm
				4	H-200.5 mm
	AKi-71	Soleira condensação		1	L
	AX-19	Vareta		1+1	Apro. H+L

Acessórios e Juntas

Referência	Descrição	Quantidade	
		Abrir	Oscilo-batente
30 92 00 20	Dobradiças C.E.	4	---
30 92 01 00	Goteiras	4	4
30 92 01 20	Jogo fecho C.E.	1	---
30 92 12 XX	Compasso O.B.	---	1
30 92 12 20	Kit oscilo-batente	---	1
30 92 12 24	Kit 2ª folha oscilo-batente	---	1
30 92 02 60	Apoio da folha	1	---
30 92 03 10	Kit cremone	1	---
30 96 00 04	Esquadro janela	12	12
30 96 00 48	Esquadro alinhamento aro fixo	8	8
30 96 10 08	Jogo topos inversor	1	1
30 96 00 12	Jogo topos condensação	1	1
30 96 00 15	Esquadro alinhamento móvel	8	8
30 96 00 22	Esquadro alinhamento móvel	8	8
30 96 00 45	Esquadro alinhamento exterior móvel	4	4
30 96 10 01	Calço para vidro	4	4
30 92 04 70	Espuma isolante	L	
30 96 00 02	Junta exterior	2L+4H	
30 96 10 04	Junta central	2L+3H	
30 93 01 20	Junta interior	2L+4H	
---	Junta exterior vidro	2L+2H	
---	Junta interior vidro	2L+2H	

143

Vidro

Hv = H-174 mm	Lv = L/2-127 mm
---------------	-----------------

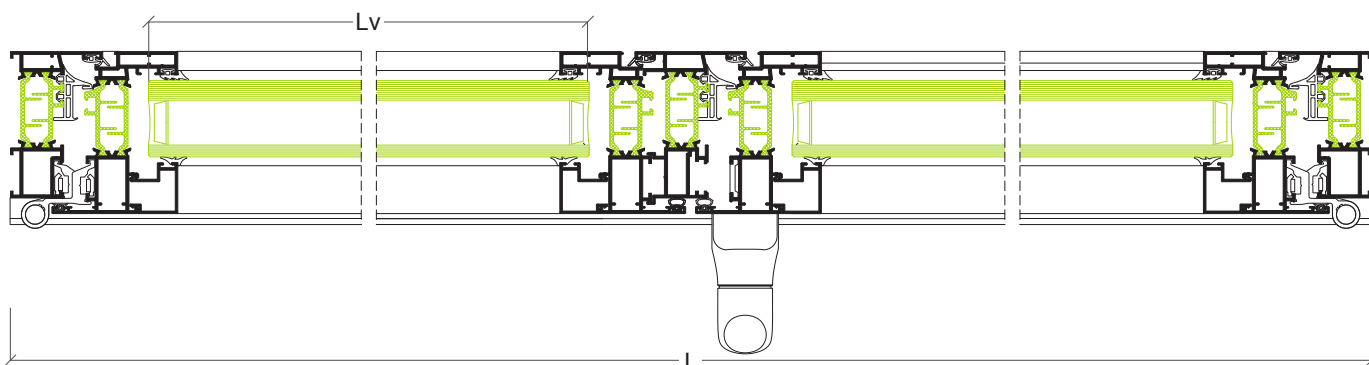

Janela 1 folha projectante deslizante

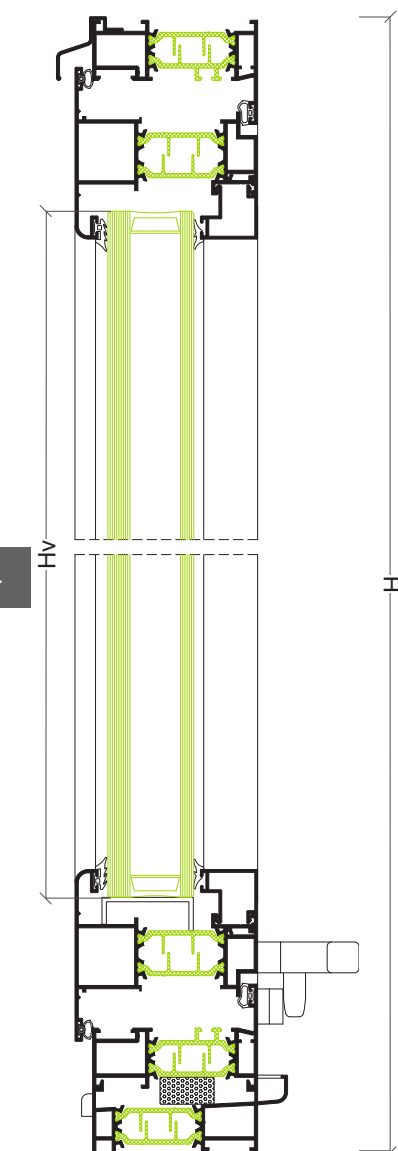
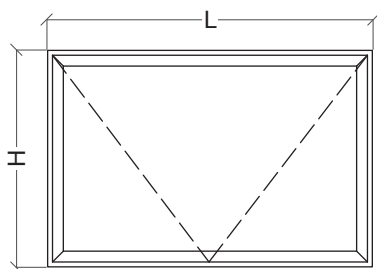

Perfis

Desenho	Ref	Descrição	Corte	Quant	Medida
	AKi-03	Aro fixo		2	L
				2	H-28.5 mm
	AKi-07	Aro móvel abertura projectante deslizante		2	L-43 mm
				2	H-71.5 mm
	---	Bite		4	L-159 mm
				4	H-227.5 mm
	AXi-45	Pingadeira superior		1	L
	AXi-32	Complemento abertura projectante		2	segundo medida compasso
	ARi-29	Apoio bite		2	L-140 mm
				2	H-168.5 mm
	AKi-71	Soleira condensação		1	L

Acessórios e Juntas

Referência	Descrição	Quantidade
30 92 01 00	Goteiras	2
30 92 04 10	Esquadro janela	4
30 92 04 90	Jogo compasso projectante deslizante 550	1
30 92 06 10	Cremona de lingueta	2
30 92 04 10	Esquadro janela abertura exterior	4
30 96 00 12	Jogo topos condensação	1
30 96 00 48	Esquadro alinhamento aro fixo	4
30 96 00 42	Esquadro alinhamento interno móvel	4
30 92 04 70	Espuma isolante	L
30 93 01 20	Junta exterior	2L+2H
30 96 00 18	Junta interior projectante deslizante	2L+2H
---	Junta exterior vidro	2L+2H
---	Junta interior vidro	2L+2H

Vidro

Hv = H-201 mm	Lv = L-173 mm
---------------	---------------

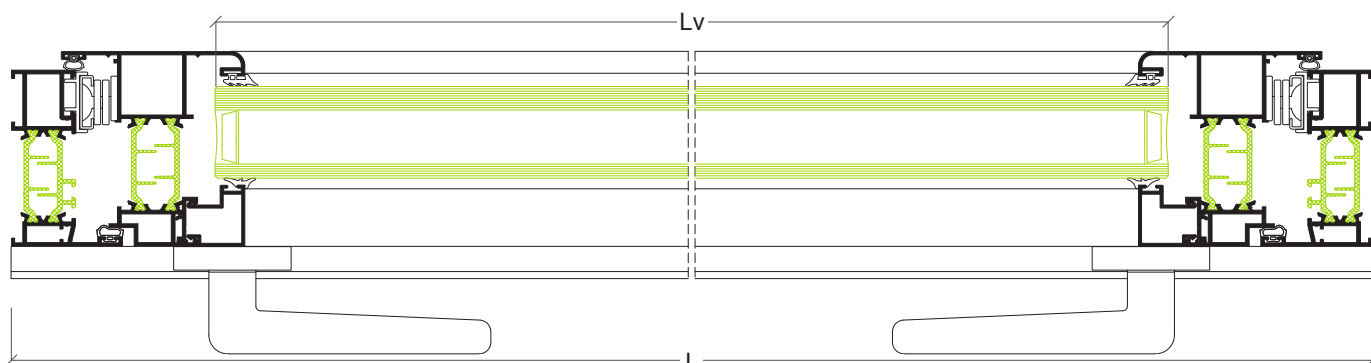

Janela pivotante horizontal

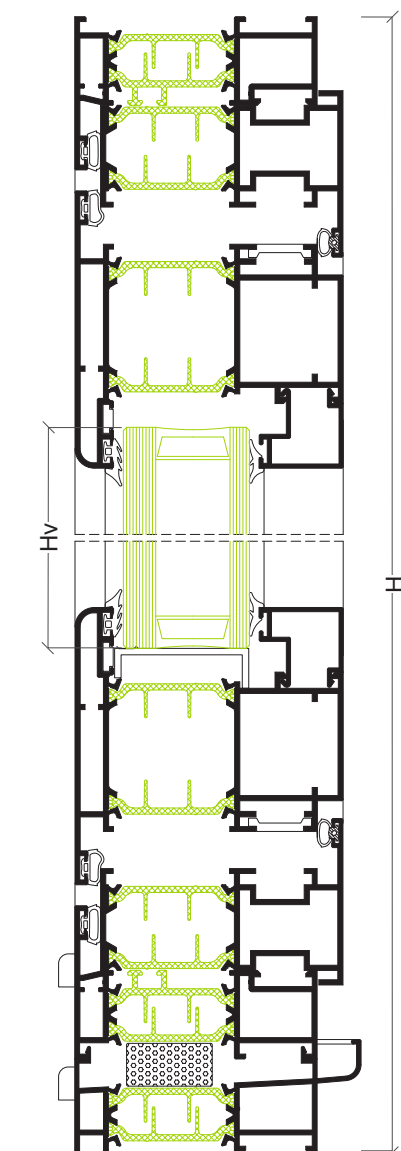
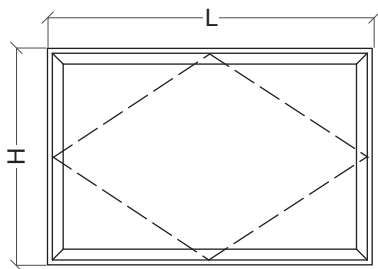

Perfis

Desenho	Ref	Descrição	Corte	Quant	Medida
	AKi-03	Aro fixo		2	L
				2	H-28.5 mm
	AKi-25	Aro móvel abertura exterior		2	L-107 mm
				2	H-135.5 mm
	AKi-14	Inversor pivotante superior		1	L-46 mm
				2	H/2-23 mm
	AKi-14	Inversor pivotante inferior		1	L-46 mm
				2	H/2-51.5 mm
	---	Bite		2	L-239 mm
				2	H-307.5 mm
	AKi-71	Soleira condensação		1	L
	AX-19	Vareta		1+1	L+H
				1+1	L+H

Acessórios e Juntas

Referência	Descrição	Quantidade
30 92 01 00	Goteiras	4
30 94 50 10	Esquadro inversor	4
30 96 00 04	Esquadro janela	4
30 96 00 05	Esquadro móvel	4
30 96 00 48	Esquadro alinhamento exterior janela	4
30 96 00 12	Jogo topos condensação	1
30 92 07 13	Jogo pivotante horizontal	1
30 92 07 16	Fecho perimetral pivotante	1
30 96 00 15	Esquadro alinhamento móvel	4
30 91 41 48	Cremone	1
30 92 04 70	Espuma isolante	L
30 96 00 18	Junta exterior	4L+4H
30 93 01 20	Junta interior	2L+2H
---	Junta exterior vidro	2L+2H
---	Junta interior vidro	2L+2H

145

Vidro

Hv = H-281 mm	Lv = L-253 mm
---------------	---------------

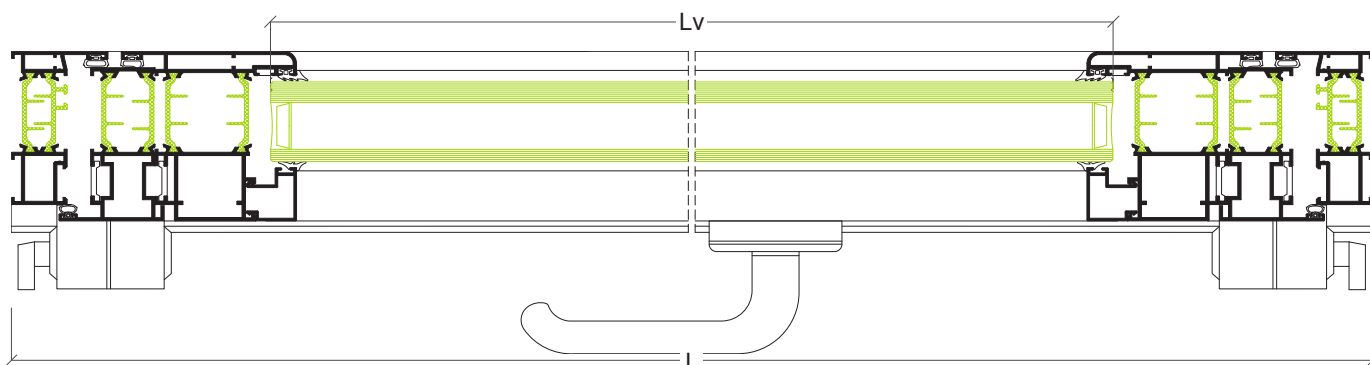

Porta 1 folha

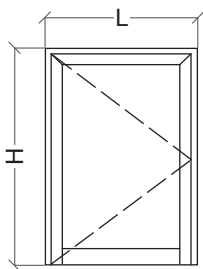

Perfis

Desenho	Ref	Descrição	Corte	Quant	Medida
	AKi-08	Aro fixo		1	L
				2	H
	AKi-36	Aro móvel		2	L-78 mm
				2	H-46 mm
	AKi-23	Almofada		1	L-147 mm
	---	Bite		4	L-216 mm
				4	H-226 mm
	AZ-60	Pingadeira		1	L-148 mm

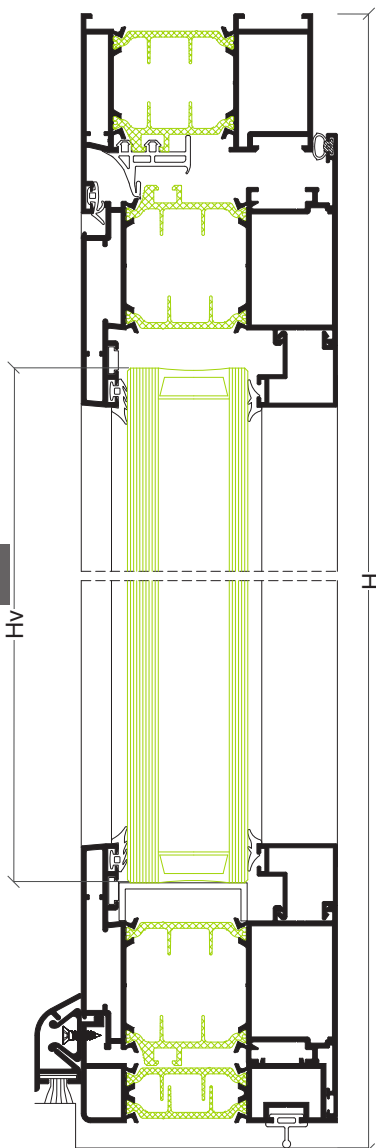

Acessórios e Juntas

Referência	Descrição	Quantidade
30 92 00 20	Dobradiças C.E.	3
30 92 01 35	Esquadro alinhamento móvel	4
30 92 05 10	Fechadura 3 pontos	1
30 92 05 55	Canhão fechadura	1
30 92 05 60	Puxador duplo	1
30 96 00 05	Esquadro aro porta	2
30 96 00 15	Esquadro alinhamento móvel	4
30 96 00 36	Esquadro móvel porta	4
30 96 00 46	Esquadro alinhamento aro móvel porta	4
30 96 00 49	Esquadro alinhamento aro fixo	2
31 03 40 00	Mola para pingadeira	A cada 200 mm
30 92 05 00	Jogo topos AZ-60	1
30 96 10 01	Calço para vidro	4
30 93 00 80	Junta inferior	L
30 96 00 02	Junta exterior	L+2H
30 96 10 04	Junta central	L+2H
30 93 01 20	Junta interior	L+2H
---	Junta exterior vidro	2L+2H
---	Junta interior vidro	2L+2H

Vidro

Hv = H-200 mm	Lv = L-230 mm
---------------	---------------

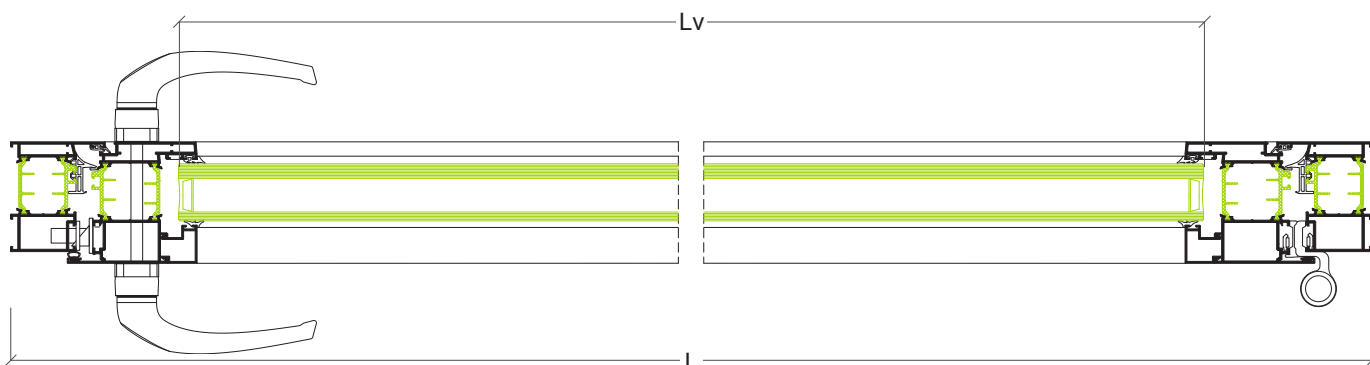

Porta 2 folhas

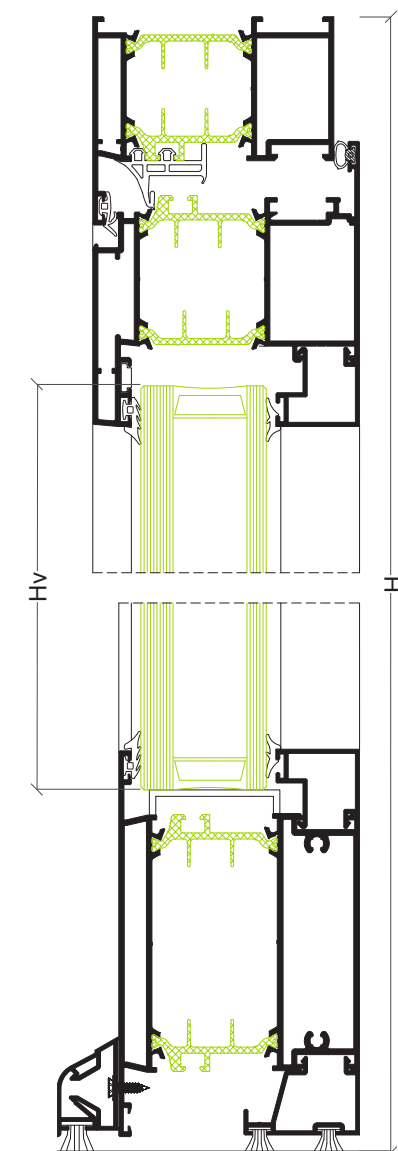
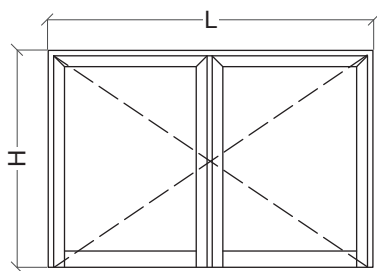

Perfis

Desenho	Ref	Descrição	Corte	Quant	Medida
	AKi-08	Aro fixo		1	L
				2	H
	AKi-10	Aro móvel		2	L/2-41.5 mm
				4	H-44 mm
	AKi-04	Inversor		1	H-78 mm
	AKi-12	Travessa		1	L/2-169.5 mm
	---	Bite		8	L-179 mm
				4	H-253 mm
	AZ-60	Pingadeira		1	L/2-112.5 mm
				1	L/2-43 mm
	AZ-61	Suplemento para pingadeira		2	L/2-219.5 mm
	AX-15	Bite remate		2	L/2-160.5 mm

Acessórios e Juntas

Referência	Descrição	Quantidade
30 92 00 20	Dobradiças C.E.	6
30 92 01 20	Jogo fecho C.E.	1
30 92 01 35	Esquadro alinhamento móvel	8
30 92 05 10	Fechadura 3 pontos	1
30 92 05 55	Canhão fechadura	1
30 92 05 60	Puxador duplo	1
30 96 00 05	Esquadro aro porta	2
30 96 10 08	Jogo topos inversor	1
30 96 00 15	Esquadro alinhamento móvel	8
30 96 00 36	Esquadro móvel porta	4
30 96 00 46	Esquadro alinhamento aro móvel porta	8
30 96 00 49	Esquadro alinhamento aro fixo	2
30 95 00 10	Pelúcia 7x9 mm	2L
30 95 05 00	Jogo topos AZ-60	1
30 96 10 01	Calço para vidro	8
30 96 00 02	Junta exterior	L+4H
30 96 10 04	Junta central	L+3H
30 93 01 20	Junta interior	L+4H
---	Junta exterior vidro	2L+4H
---	Junta interior vidro	2L+4H

Vidro

Hv = H-227 mm	Lv = L/2-193 mm
---------------	-----------------

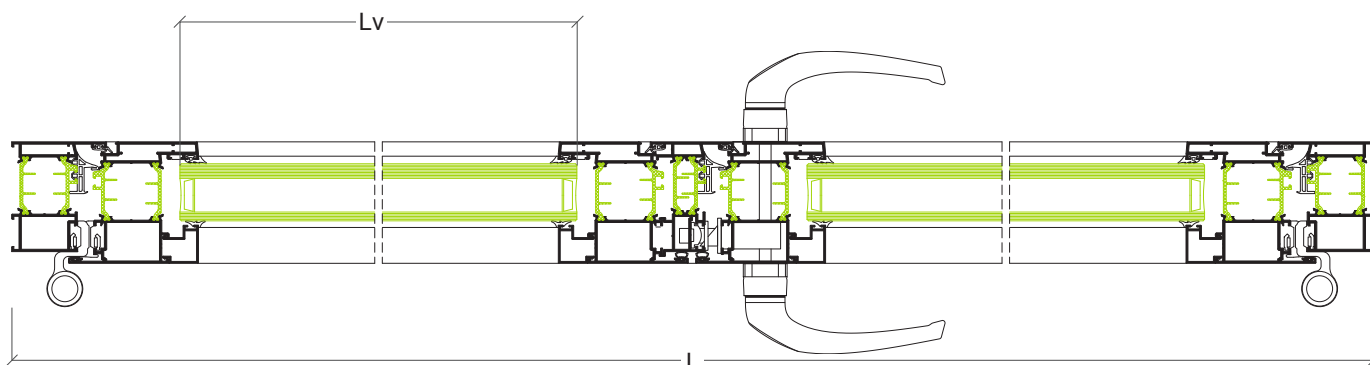

Porta 2 folhas abertura exterior

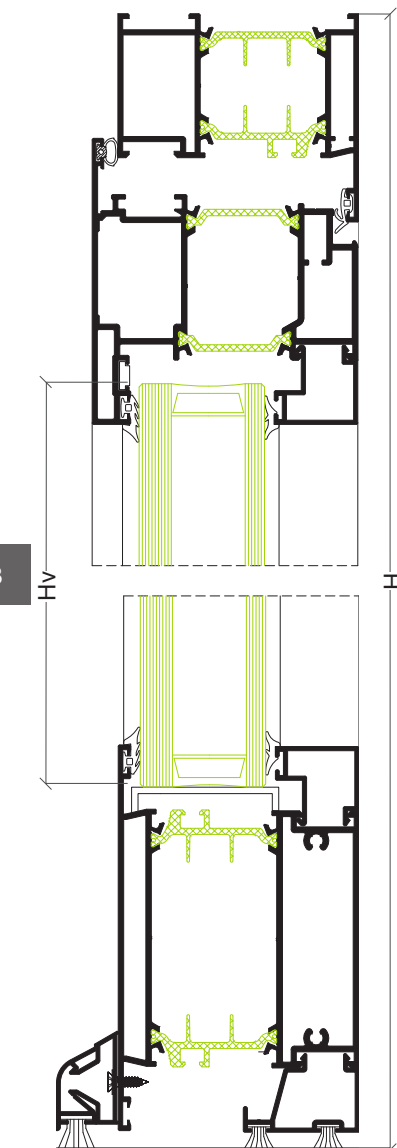
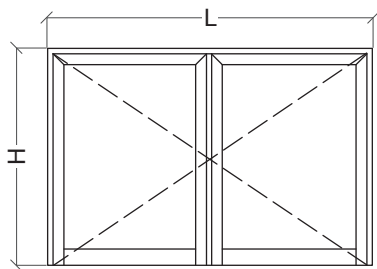

Perfis

Desenho	Ref	Descrição	Corte	Quant	Medida
	AKi-08	Aro fixo		1	L
				2	H
	AKi-72	Aro móvel abertura exterior		2	L/2-41.5 mm
				4	H-44 mm
	AKi-04	Inversor		1	H-78 mm
	AKi-12	Travessa		1	L/2-169.5 mm
	AX-15	Bite remate		2	L/2-160.5 mm
	---	Bite		4	L/2-179 mm
				4	H-253 mm
	AZ-60	Pingadeira		1	L/2-112.5 mm
				1	L/2-43 mm
	AZ-61	Suplemento para pingadeira		2	L/2-219.5 mm

Acessórios e Juntas

Referência	Descrição	Quantidade
30 92 01 20	Jogo fecho C.E.	1
30 92 05 10	Fechadura 3 pontos	1
30 92 05 55	Canhão fechadura	1
30 92 05 60	Puxador duplo	1
30 96 00 05	Esquadro porta	2
30 96 10 08	Jogo topos inversor	1
30 92 00 20	Dobradiça C.E.	6
30 95 00 10	Pelúcia 7x9 mm	2L
30 95 05 00	Jogo topos AZ-60	1
30 92 03 90	Esquadro móvel exterior	4
30 92 01 35	Esquadro alinhamento móvel	4
30 96 00 15	Esquadro alinhamento móvel exterior	4
30 96 00 45	Esquadro móvel interior	4
30 96 00 49	Esquadro alinhamento aro fixo	2
30 93 01 20	Junta exterior	2L
30 96 00 02	Junta interior	L+4H
---	Junta exterior vidro	2L+4H
---	Junta interior vidro	2L+4H

Vidro

Hv = H-228 mm	Lv = L/2-194 mm
---------------	-----------------

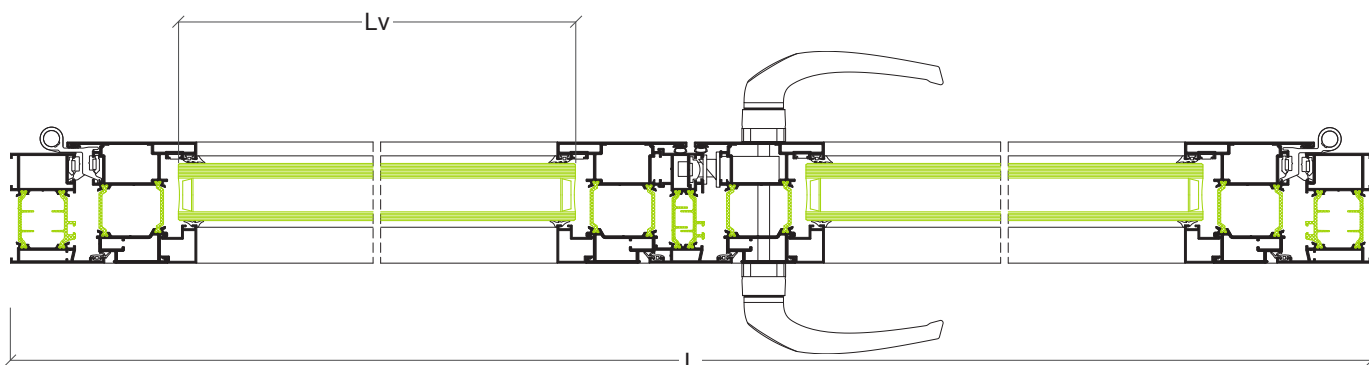

Porta oscilo-paralela com fixo lateral

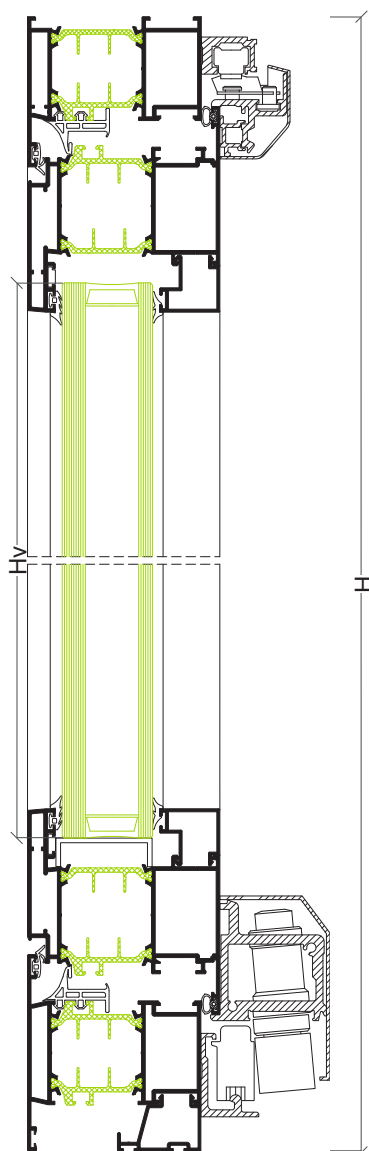
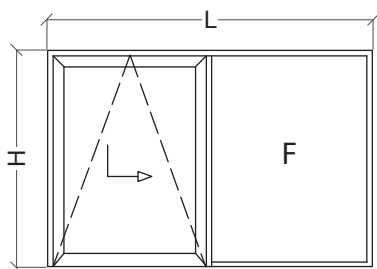

Perfis

Desenho	Ref	Descrição	Corte	Quant	Medida
	AKi-08	Aro fixo		1	L
				2	H
	AKi-06	Travessa		1	L-80.5 mm
				1	H-100.5 mm
	AKi-36	Aro móvel		2	L1-55.5 mm
				4	H-98 mm
	---	Bite (folha)		2	L1-193 mm
				2	H-275.5 mm
	---	Bite (fixo)		2	L2-67.5 mm
				2	H-150 mm
	AX-15	Bite remate		1	L-90 mm
	AX-19	Vareta		1+1	Aprox. L+H

Acessórios e Juntas

Referência	Descrição	Quantidade
30 92 01 00	Goteiras	4
30 92 01 35	Esquadro alinhamento móvel	4
30 92 01 50	União topos porta	4
30 96 00 05	Esquadro aro fixo	2
30 96 00 15	Esquadro alinhamento móvel	4
30 96 00 36	Esquadro aro móvel	4
30 96 00 46	Esquadro alinhamento exterior aro móvel	4
30 96 00 49	Esquadro alinhamento aro fixo	2
---	Kit oscilo-paralela	1
30 96 10 01	Calço para vidro	4
30 96 00 02	Junta exterior	2L1+2H
30 96 10 04	Junta central	2L1+2H
30 93 01 20	Junta interior	2L1+2H
---	Junta exterior vidro	2L+2H
---	Junta interior vidro	2L+2H

Vidro

Hv folha = H-249 mm	Lv folha = L1-206 mm	
Hv fixo = H-124 mm	Lv fixo = L2-81 mm	
	Mínimo	Máximo
Largura da folha	700 mm	1650 mm
Altura da folha	850 mm	2400 mm
Peso máximo por folha 150 kg		

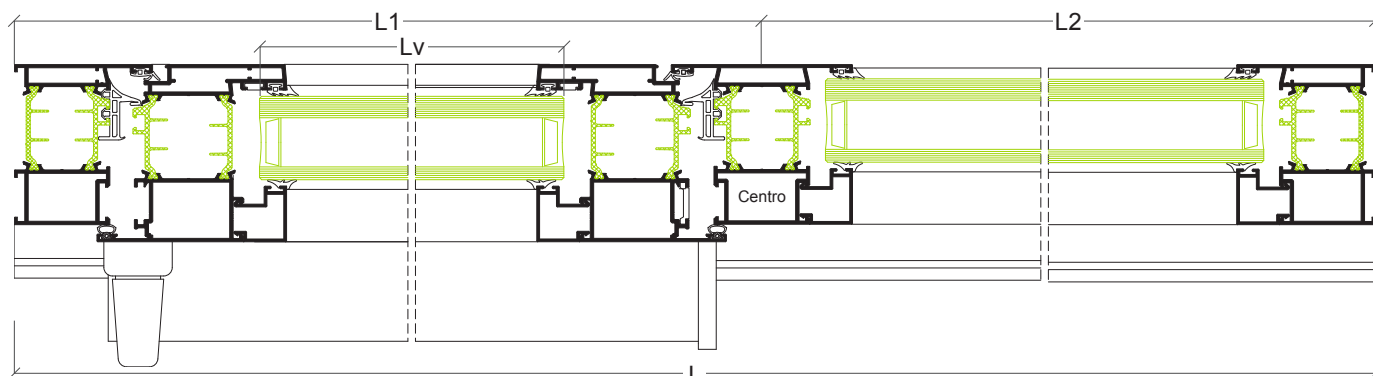

Porta 3 folhas harmónio

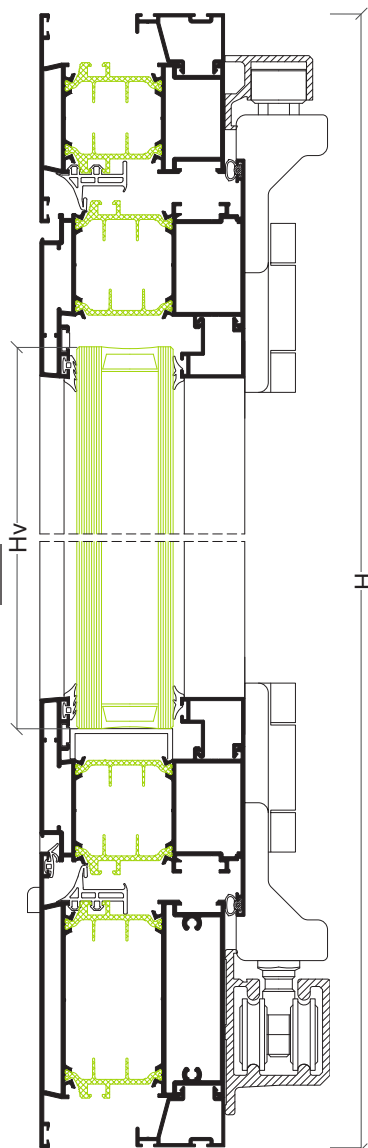
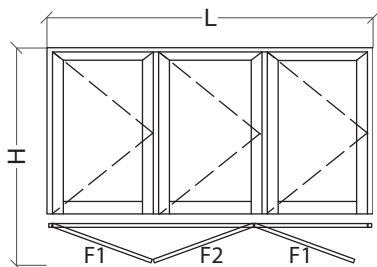

Perfis

Desenho	Ref	Descrição	Corte	Quant	Medida
	AKi-08	Aro fixo		2	H
	AKi-06	Travessa		1	L-80.5 mm
	AKi-12	Travessa		1	L-80.5 mm
	AKi-36	Aro móvel		6	consultar
				6	consultar
	AKi-04	Inversor		2	consultar
	---	Bite (folha)		6	consultar
				6	consultar
	AX-15	Bite remate		2	L-90 mm
	AX-19	Vareta		2	2H

Acessórios e Juntas

Referência	Descrição	Quantidade
30 92 01 00	Goteiras	6
30 92 01 35	Esquadro alinhamento móvel	12
30 96 10 08	Jogo topos inversor	2
30 96 00 15	Esquadro alinhamento aro móvel	12
30 96 00 36	Esquadro aro móvel porta	12
30 96 00 46	Esquadro alinhamento exterior porta	12
---	Kit harmónio (3+0)	1
30 92 01 50	União topo porta	2
30 92 01 20	Jogo fecho C.E.	1
30 96 10 01	Calço para vidro	12
30 96 00 02	Junta exterior	2L+6H
30 96 10 04	Junta central	2L+4H
30 93 01 20	Junta interior	2L+6H
---	Junta exterior vidro	2L+2H
---	Junta interior vidro	2L+2H

Vidro

Hv = consultar	Lv Folha 1 = consultar	
	Lv Folha 2 = consultar	
	Mínimo	Máximo
Largura da folha	600 mm	900 mm
Altura da folha	850 mm	2400 mm
Peso máximo por folha 80 kg		

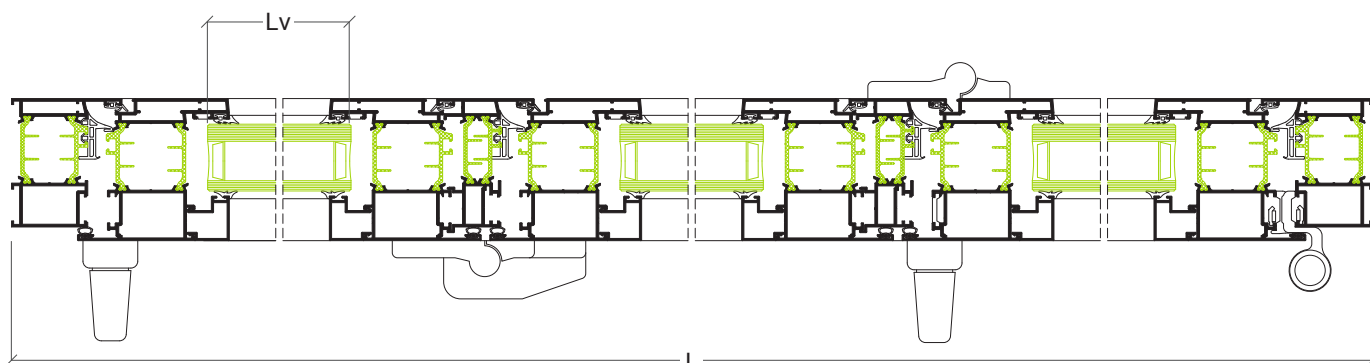

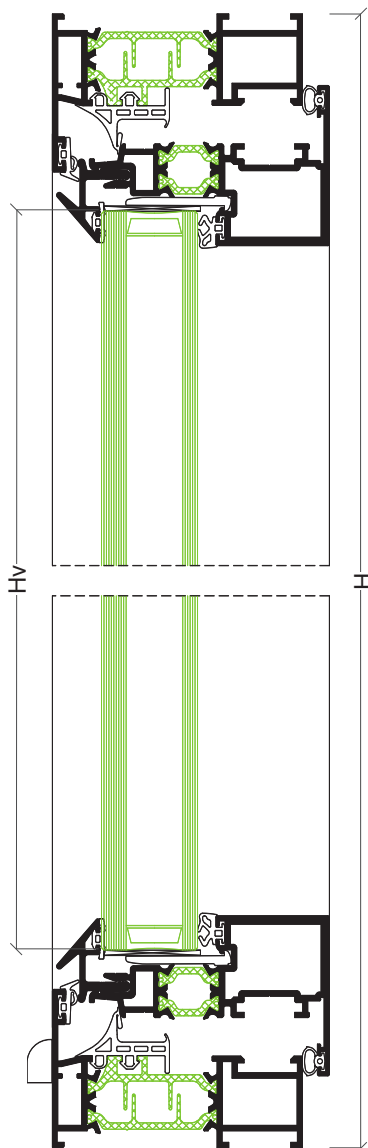
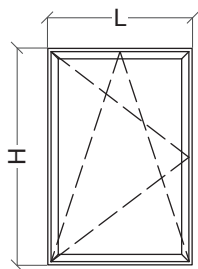
Janela 1 folha oscilo-batente (3D)

Perfis

Desenho	Ref	Descrição	Corte	Quant	Medida
	AKi-03	Aro fixo		2	L
				2	H
	AKi-78	Aro móvel		2	L-43 mm
				2	H-43 mm
	AKi-52	Bite		2	L-87 mm
				2	H-87 mm
	AX-19	Vareta		várias	---

* Preferencialmente cortar juntamente com o perfil AKi-78

Acessórios e Juntas

Referência	Descrição	Quantidade
30 96 00 04	Esquadro interior aro fixo	4
30 96 00 39 ou 48	Esquadro exterior aro fixo	4
30 96 10 15	Esquadro interior aro móvel	4
30 96 00 44	Esquadro exterior aro móvel	4
30 96 00 55	Pino para esquadro	8
30 92 01 35	Esquadro de alinhamento	4
30 92 01 02	Goteira com válvula (cor preto)	2 ou mais
30 96 10 05	Junta vedação AKi - folha oculta 3D	2L+2H
30 96 00 02	Junta exterior	L+2H
30 96 10 04	Junta central	2L+2H
30 93 01 20	Junta interior	2L+2H
---	Junta interior vidro	2L+2H
---	Ferragem oscilo-batente	---

151

Vidro

Hv = H-115 mm	Lv = L-115 mm
---------------	---------------

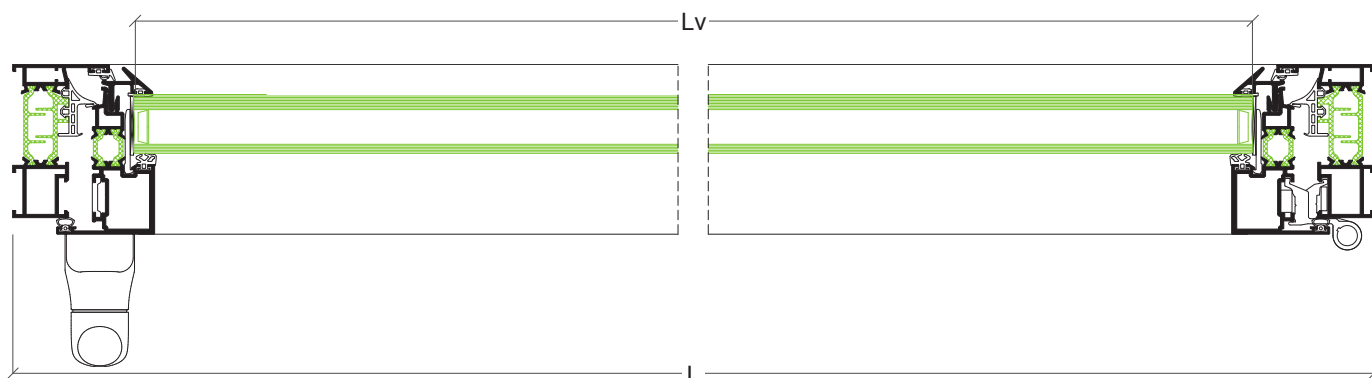

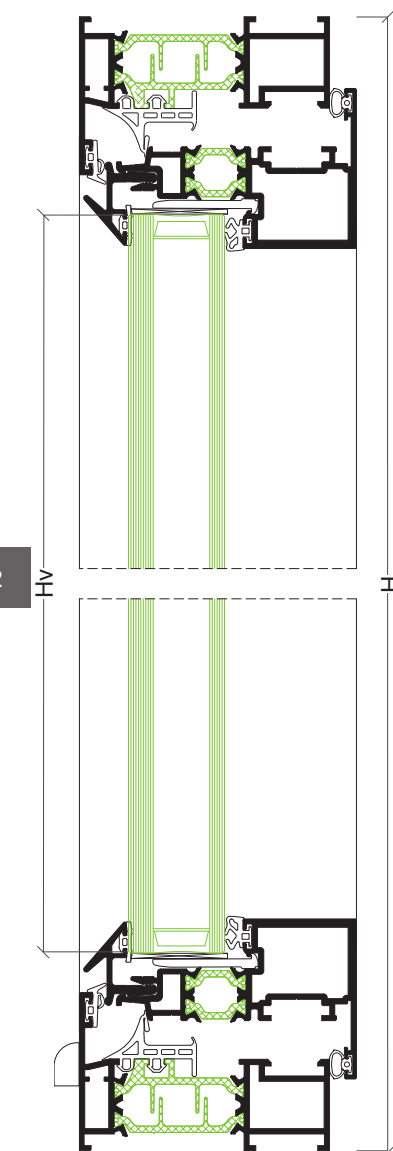
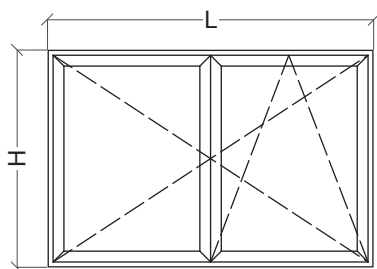
Janela 2 folhas oscilo-batente (3D)

Perfis

Desenho	Ref	Descrição	Corte	Quant	Medida
	AKi-03	Aro fixo		2	L
				2	H
	AKi-78	Aro móvel		4	(L/2)-24 mm
				4	H-43 mm
	AKi-52	Bite		4	(L/2)-68 mm
				4	H-87 mm
	AKi-04	Inversor		1	H-119 mm
	AX-19	Vareta		várias	---

* Preferencialmente cortar juntamente com o perfil AKi-78

Acessórios e Juntas

Referência	Descrição	Quantidade
30 96 00 04	Esquadro interior aro fixo	4
30 96 00 39 ou 48	Esquadro exterior aro fixo	4
30 96 10 15	Esquadro interior aro móvel	8
30 96 00 44	Esquadro exterior aro móvel	8
30 96 00 55	Pino para esquadro 30 96 00 44	16
30 92 01 35	Esquadro de alinhamento	8
30 92 01 02	Goteira com válvula (cor preto)	2 ou mais
30 92 01 14	Conjunto topo inversor	1
30 92 02 60	Calço de apoio da folha passiva	1
30 96 10 05	Junta vedação AKi - folha oculta 3D	2L+4H
30 96 00 02	Junta exterior	L+4H
30 96 10 04	Junta central	2L+3H
30 93 01 20	Junta interior	2L+4H
---	Junta interior vidro	2L+4H
---	Ferragem oscilo-batente	---

Vidro

Hv = H-115 mm	Lv = (L/2)-96 mm
---------------	------------------

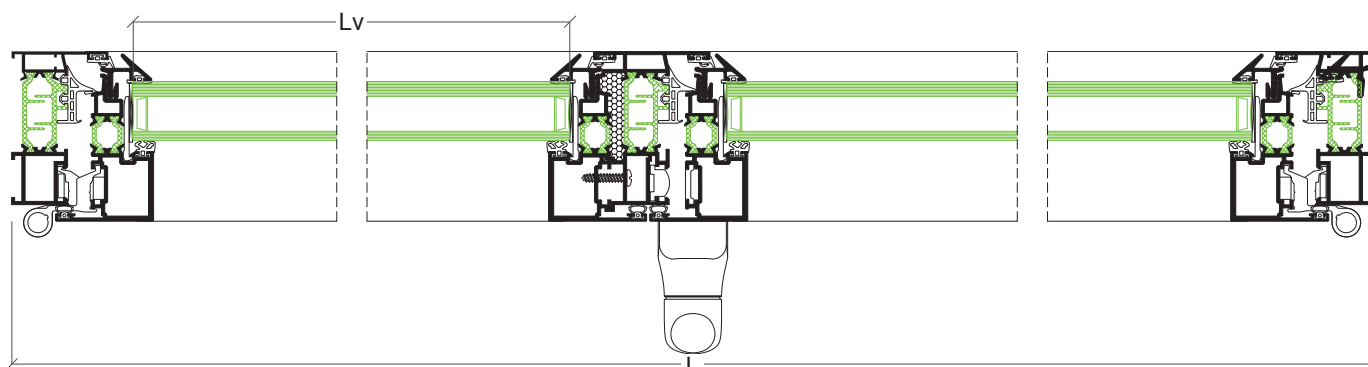

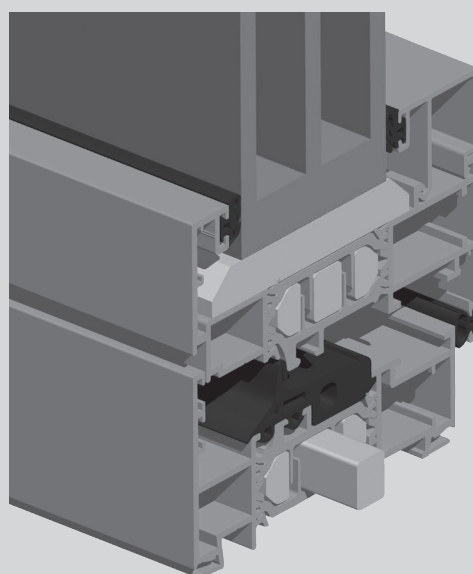
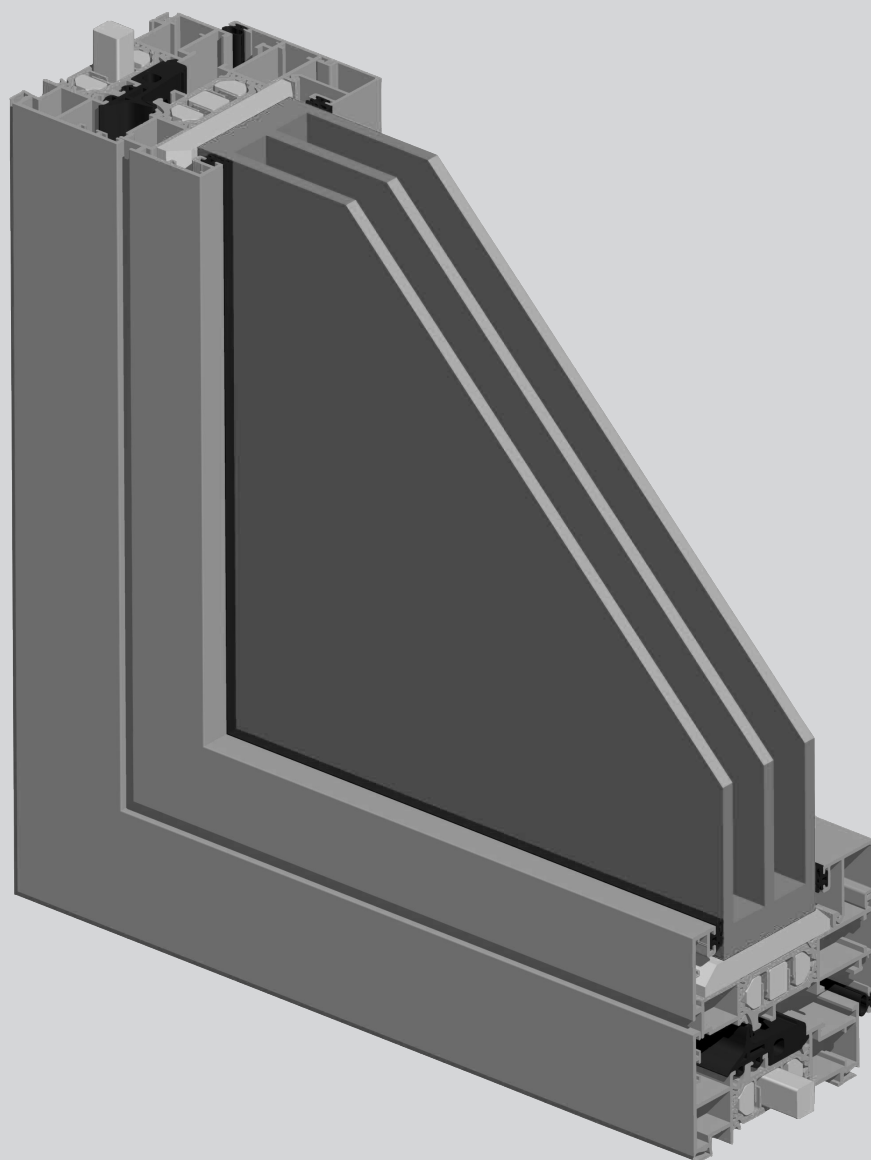

Sistema
APi

Sistema API

Sistema de batente com RPT - 85 mm

Características do sistema

Sistema de batente com rotura térmica de elevadas prestações térmicas e acústicas.

O sistema API possibilita a execução de 3 versões de caixilharia:

1. Linha recta;
2. Linha curva;
3. Linha oval.

O sistema API permite a aplicação de vidros duplos ou triplos de alto rendimento de modo a responder às exigências de isolamento térmico e acústico.

Com um óptimo isolamento térmico aliado à aplicação de um inovador produto designado por bagueete ThermoProfile, o Sistema API proporciona elevadas prestações de conforto e de economia energética.

Perfis de alumínio

Os perfis de alumínio são extrudidos na liga de alumínio 6060 para arquitectura de acordo com norma NP EN 12020-02.

Rotura térmica obtida por inserção de varetas isolantes de poliamida tipo ómega de 39 mm reforçadas com 25% de fibra de vidro. Espessura média dos perfis de alumínio de 1.7 mm.

Aros fixos

Secção dos aros fixos de 85 mm com tripla câmara;

Perfis com rotura térmica com varetas de poliamida tipo ómega de 39 mm;

Aros fixos com duplo esquadro de aperto rápido e esquadros de alinhamento para montagem a meia esquadria;

Travessas com dupla união para um aperto mais eficaz;

Aros fixos tradicionais para o mercado interno;

Aros fixos com clip exterior e aba de remate directa de 25 mm ou 45 mm para o mercado francês;

Aro fixo com clip exterior e interior para aplicação de remate de 30, 50 ou 80 mm para o mercado francês;

Aros móveis

Secção dos aros móveis de 93 mm com tripla câmara;

Aros móveis com rotura térmica através de varetas de poliamidas tipo ómega de 39 mm;

Aros móveis com duplo esquadro de aperto rápido e esquadros de alinhamento para montagem a meia esquadria;

Perfil inversor com olhal para uma melhor aplicação do topo inversor.

Dimensionamento e manobralidade

Dimensões mínimas - máximas de folha: 457 mm - 1700 mm (L); 457 mm - 3000 mm (H);

Peso máximo para janelas ou portas de sacada com oscilo-batente até 170 Kg;

Peso máximo para portas de entrada até 160 Kg/folha;

Possibilidades de abertura: fixo, batente interior 1 ou 2 folhas com ou sem oscilo-batente, batente exterior, basculante, projectante, hármónio e oscilo-paralela;

Solução de perfil para portas pedonais ou de sacada de abertura interior ou exterior segundo norma PMR (pessoas com mobilidade reduzida);

Enchimento para vidro duplo ou triplo desde 24 mm até 70 mm;

Estanquidade assegurada através de juntas duplas em EPDM (interior e central), com junta central termo-isolante de bi-material.

Performances

Sistema certificado por laboratório notificado para Ensaio Tipo Inicial (ITT) de acordo com a norma de produto EN 14351-1 para efeitos de Marcação CE.

Categorias alcançadas na avaliação do sistema API:

1. Permeabilidade ao ar: Classe 4 (norma de ensaio EN 1026)
2. Estanquidade à água: Classe E1500 (norma de ensaio EN 1027)
3. Resistência ao vento: Classe C5 (norma de ensaio EN 12211)

Coefficiente de transmissão térmica de vão de 2 folhas com 1.20 m x 1.50 m com vidro $U_g = 0.5 \text{ W/m}^2\text{K}$ com intercalar efeito "Warm Edge":

• $U_w = 1.09 \text{ W/m}^2\text{K}$

Coefficiente de atenuação acústica de vão de 2 folhas:

• $R_w (C ; C_{tr}) = 41 \text{ dB} (-2 ; -5)$

Zonas de aplicação segundo RCCTE (em função do valor U_g) : I1, I2, I3, V1, V2, V3

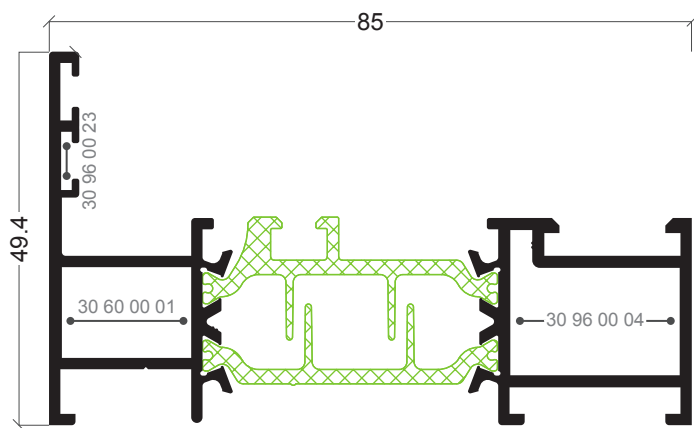

API-03
Aro fixo

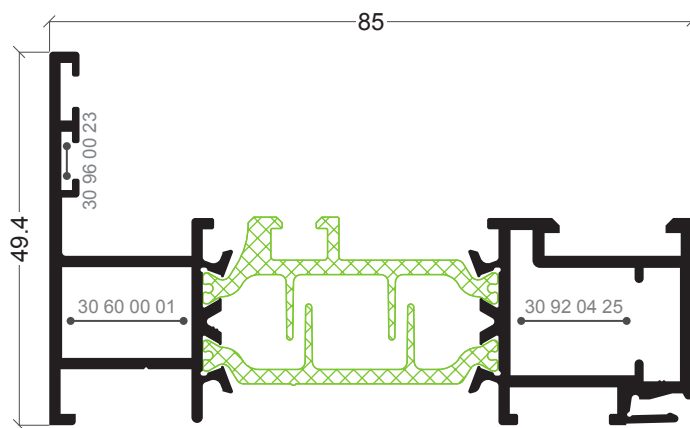

API-91
Aro fixo

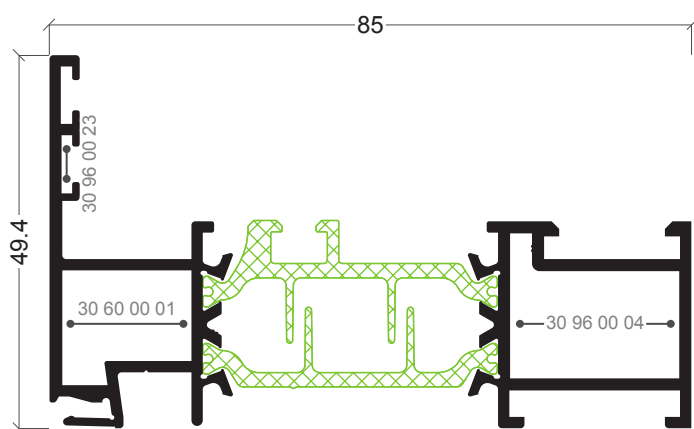

API-76
Aro fixo

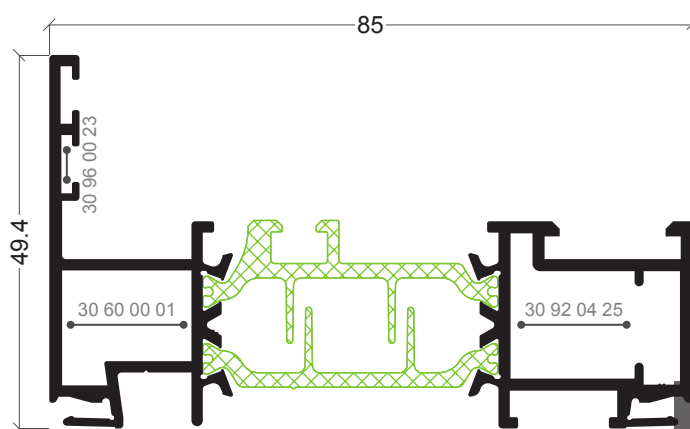

API-80
Aro fixo

155

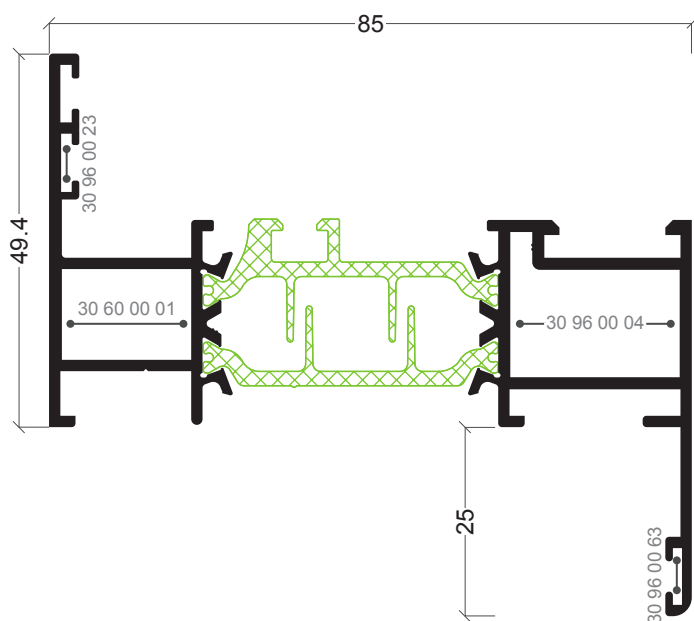

API-35
Aro fixo com remate 25 mm

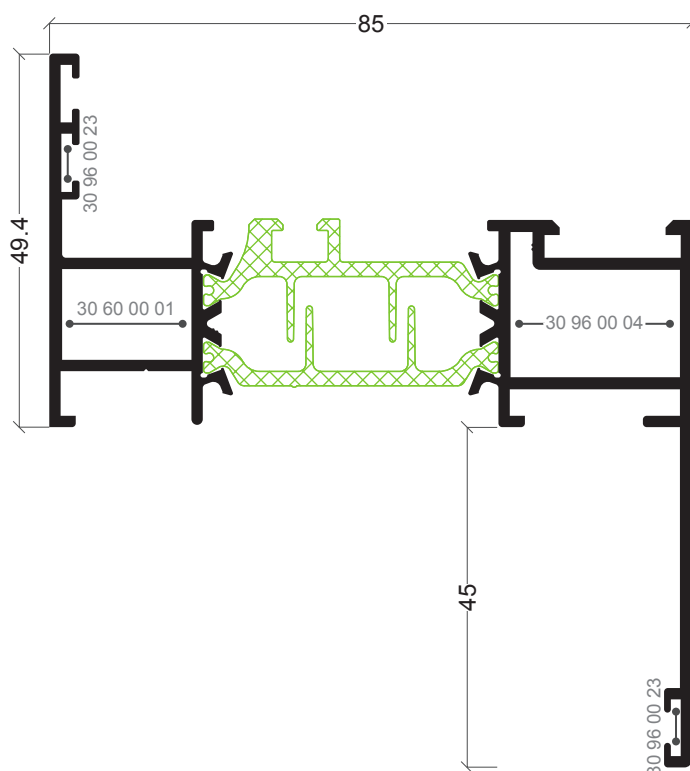

API-33
Aro fixo com remate 45 mm

30 96 00 23

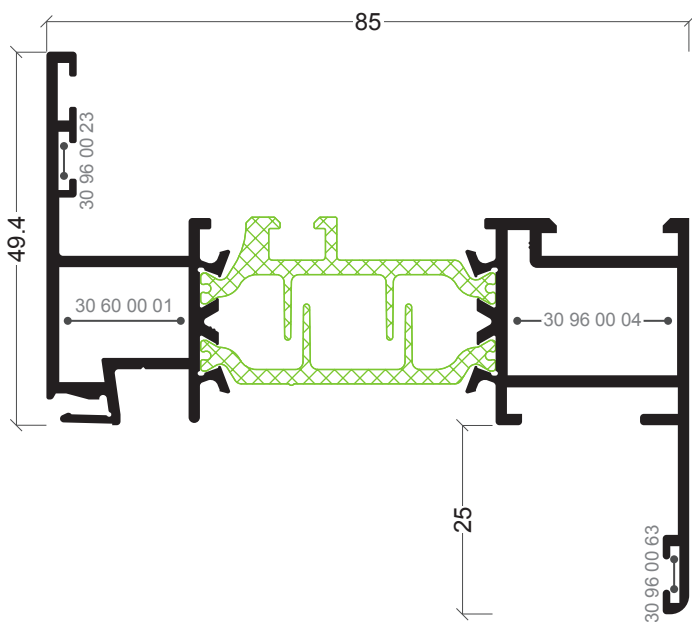

APi-74
Aro fixo com remate 25 mm

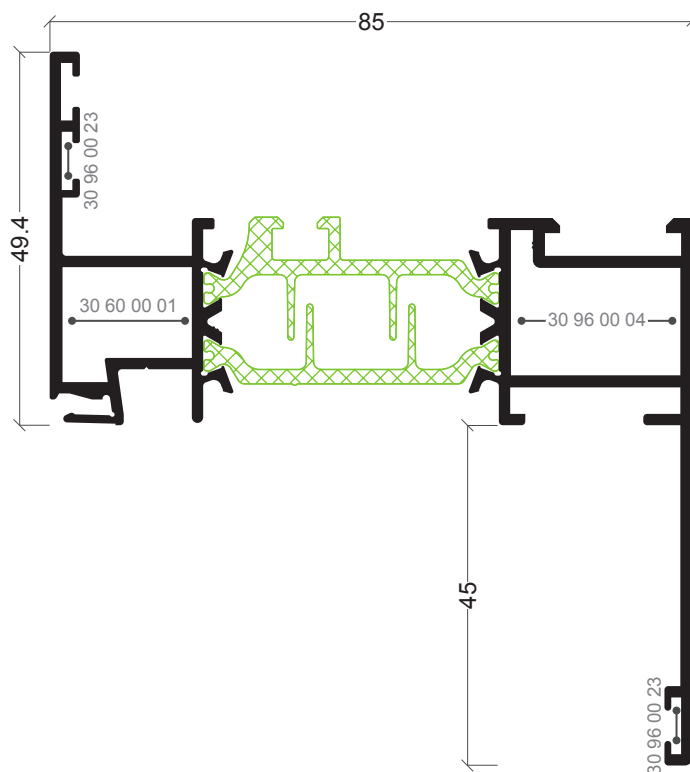

APi-75
Aro fixo com remate 45 mm

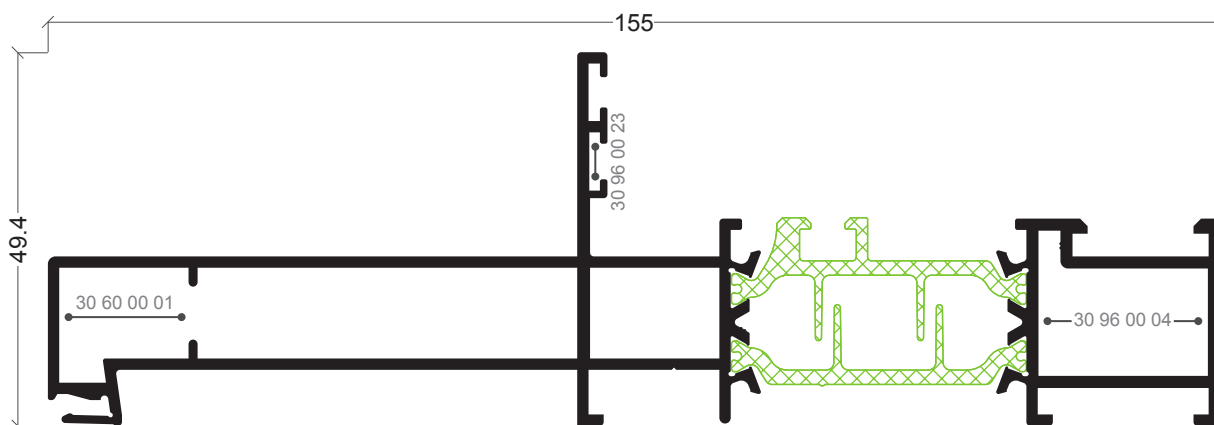

APi-89
Aro fixo

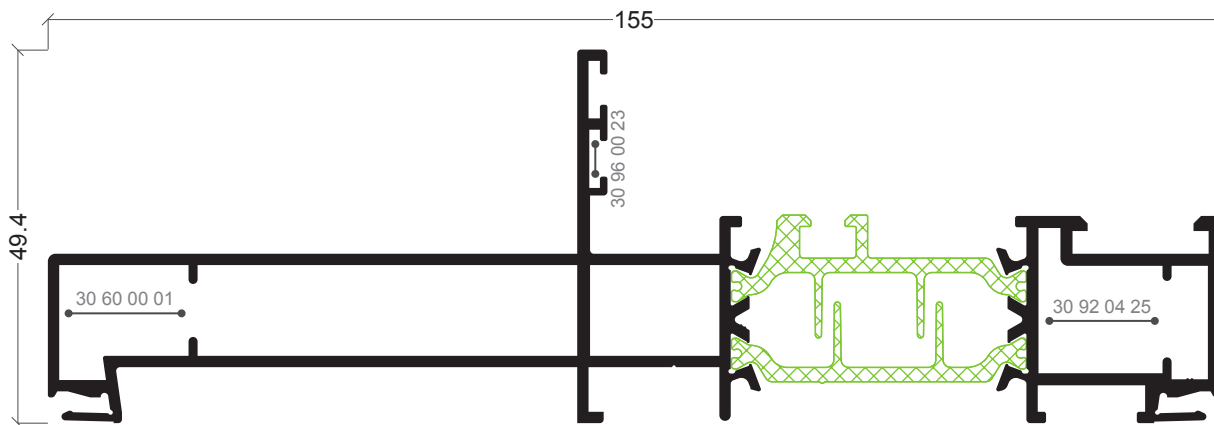

APi-88
Aro fixo

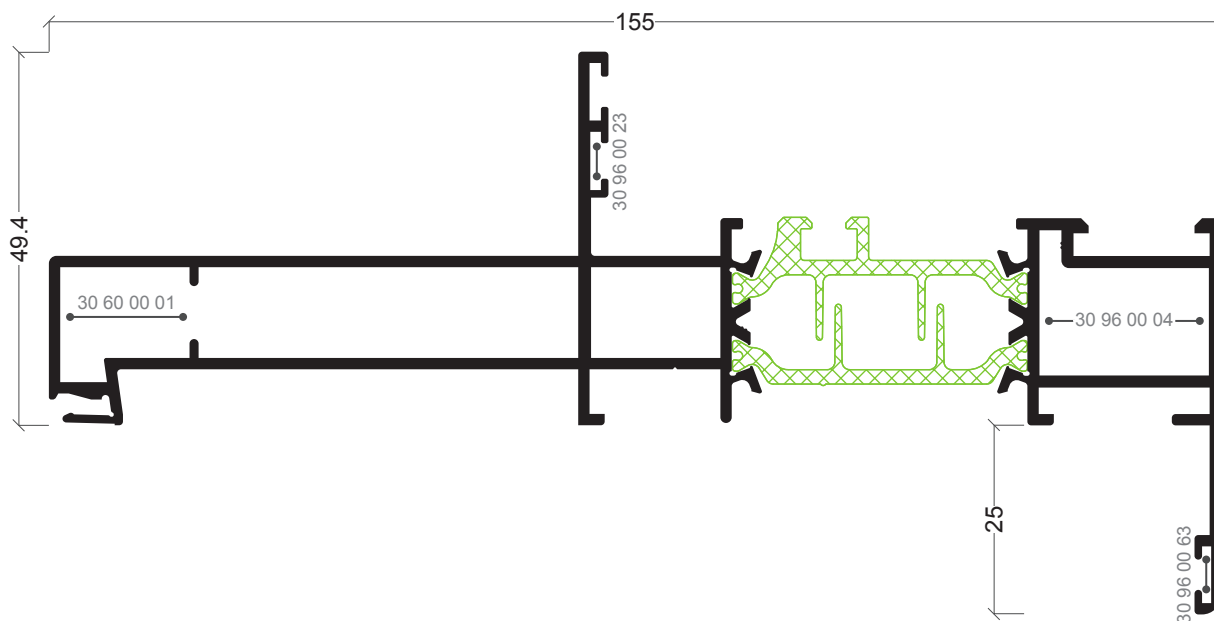

APi-86
Aro fixo com remate 25 mm

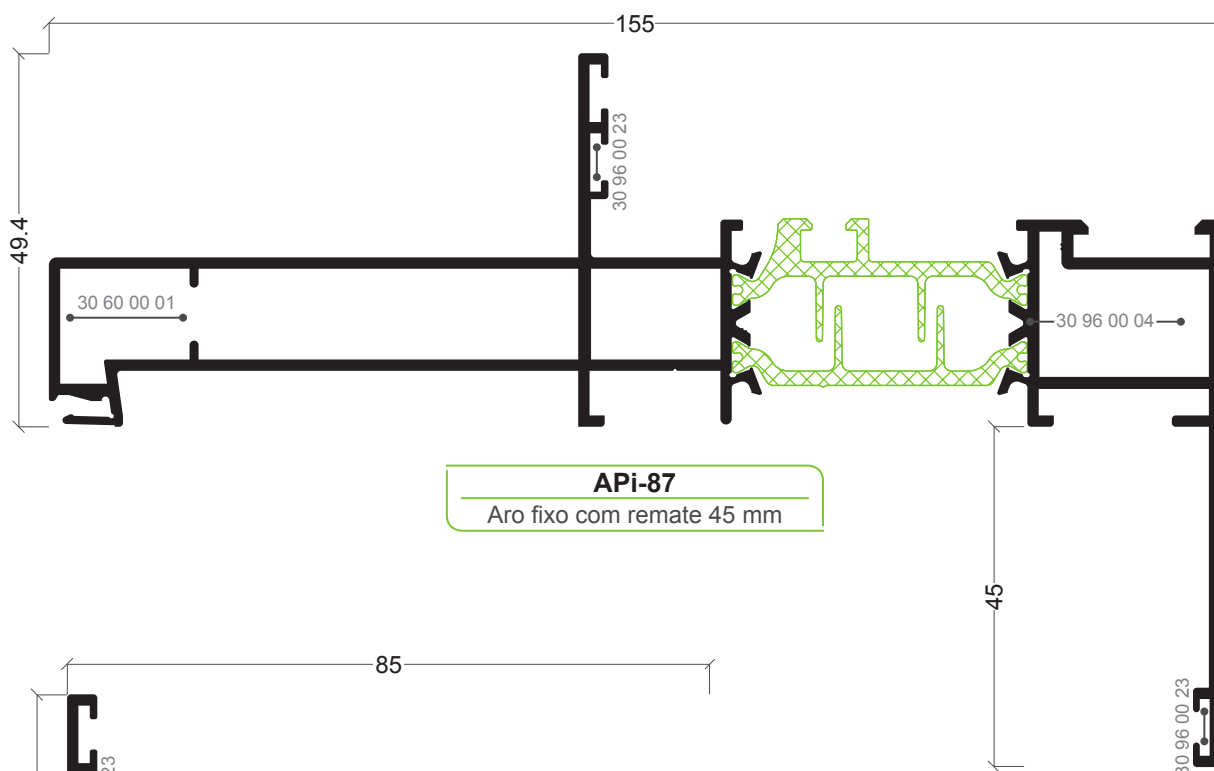

APi-87
Aro fixo com remate 45 mm

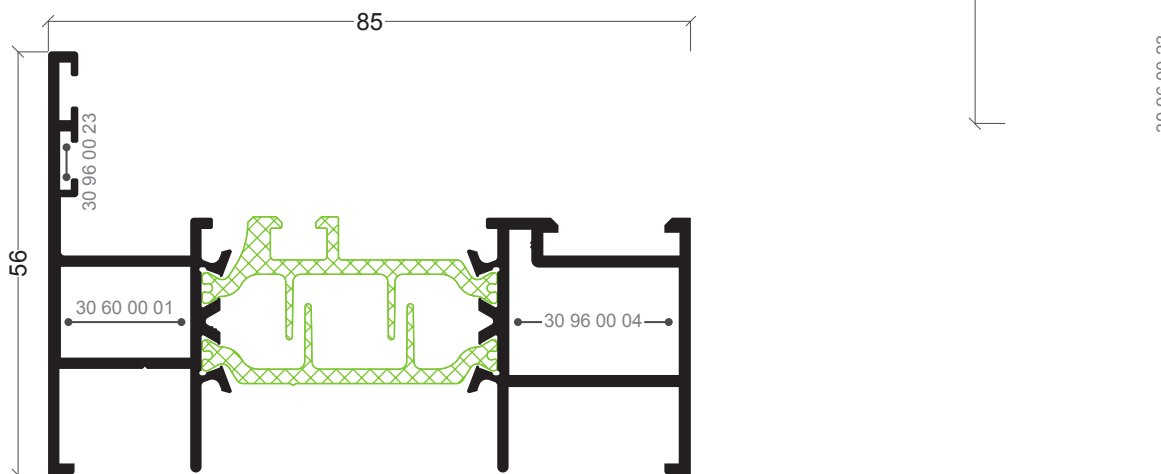

APi-81
Aro fixo

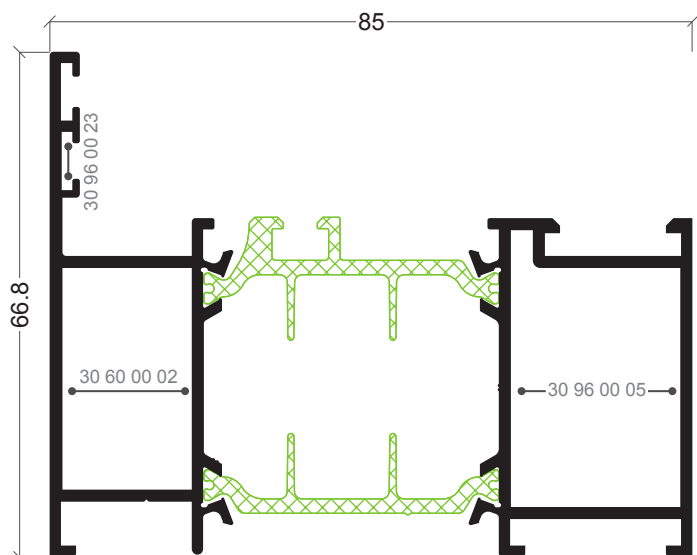

API-08
Aro fixo

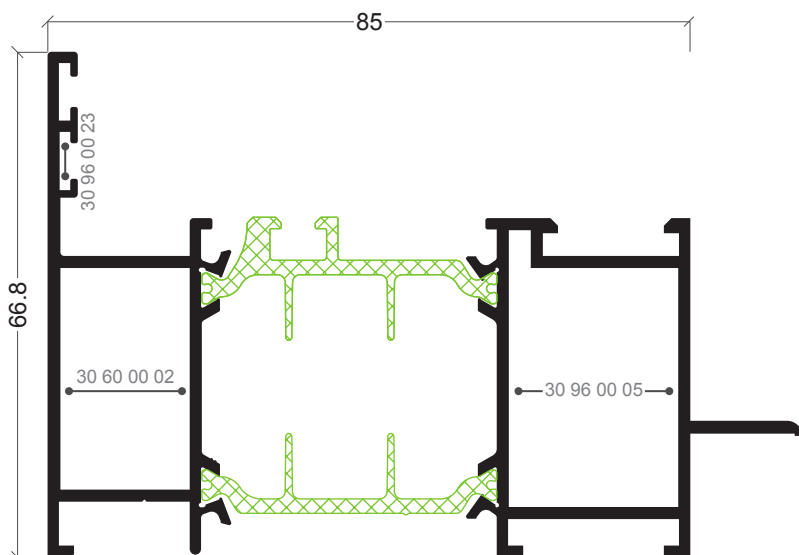

API-68
Aro fixo

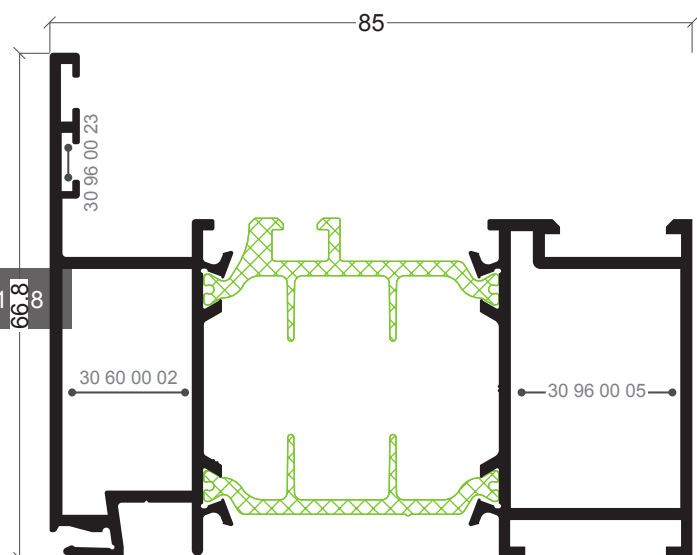

API-92
Aro fixo

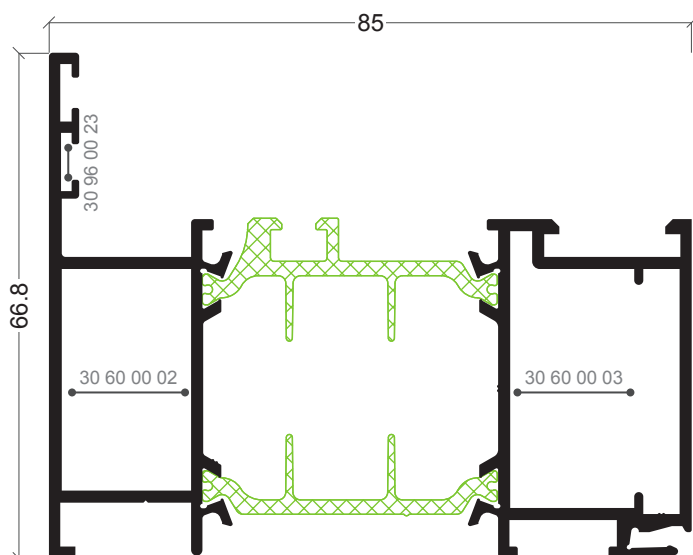

API-93
Aro fixo

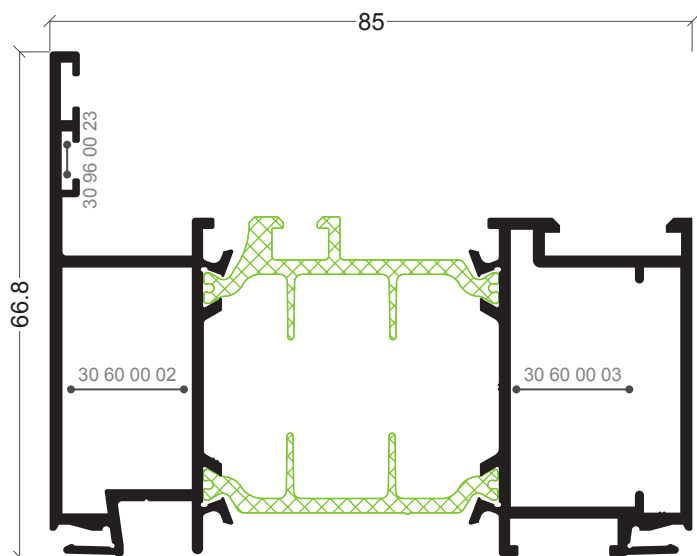

API-94
Aro fixo

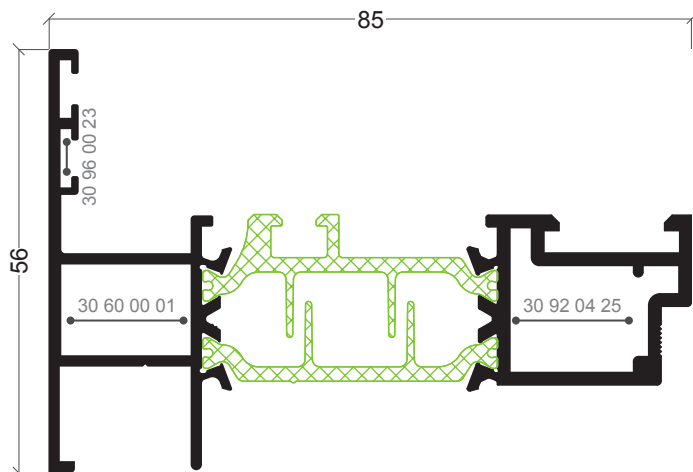

API-73
Inversor de sentido de abertura

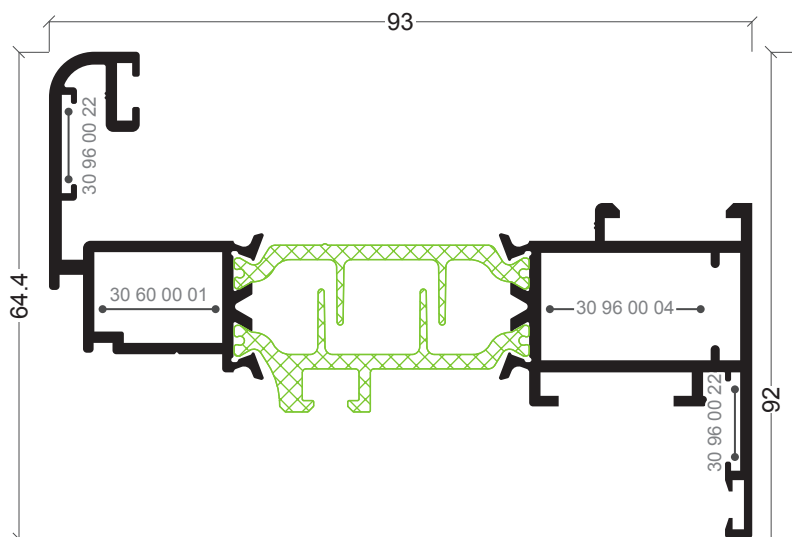

APi-05
Aro móvil

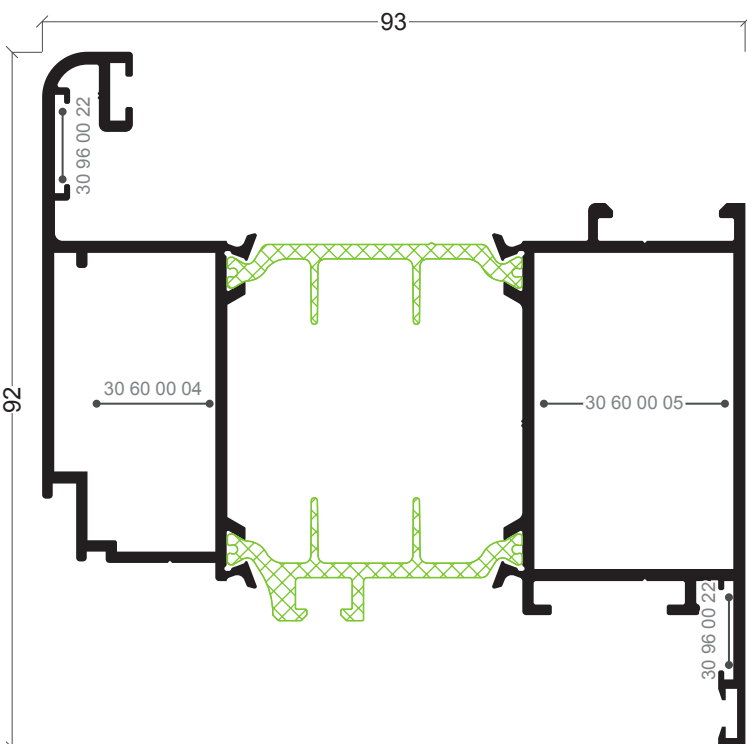

APi-10
Aro móvil

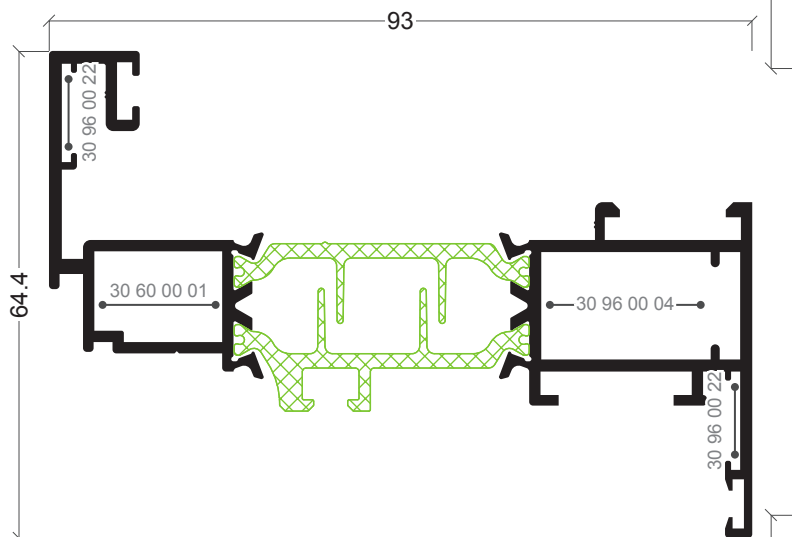

APi-61
Aro móvil

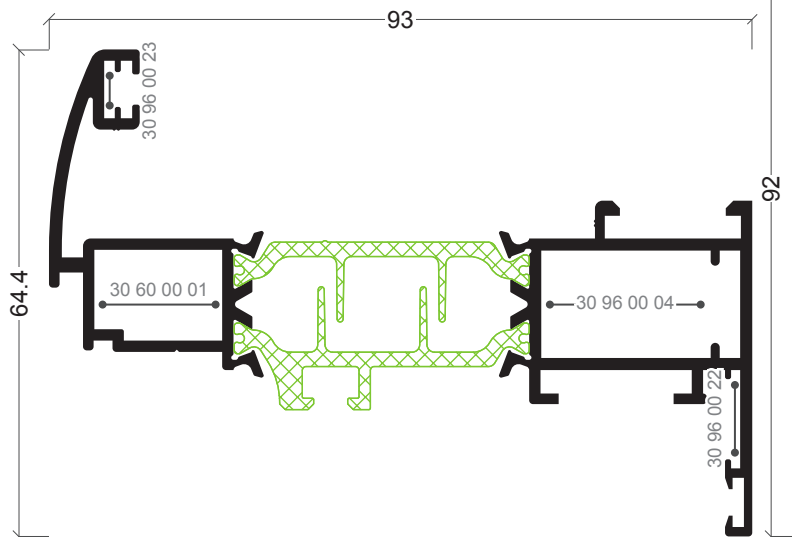

APi-83
Aro móvil

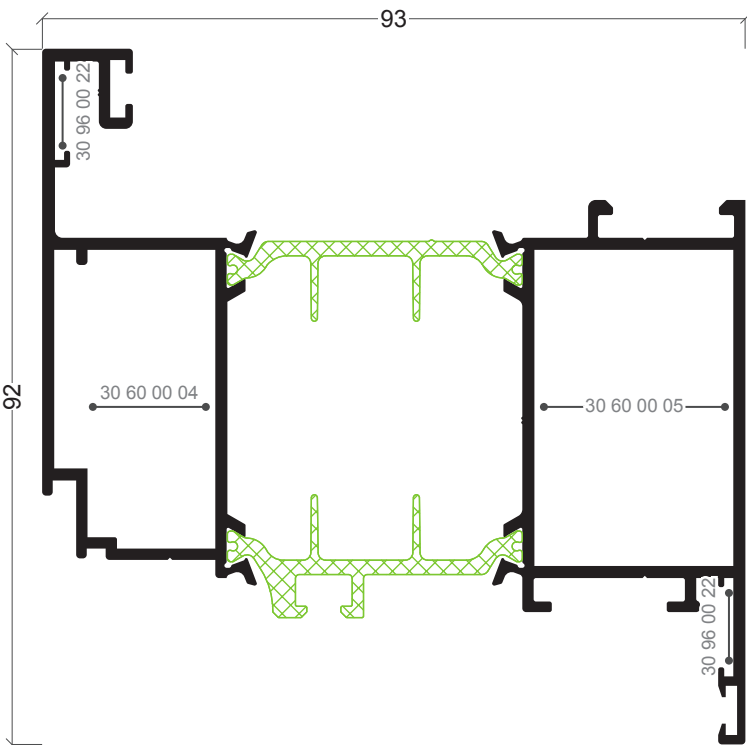

APi-36
Aro móvil

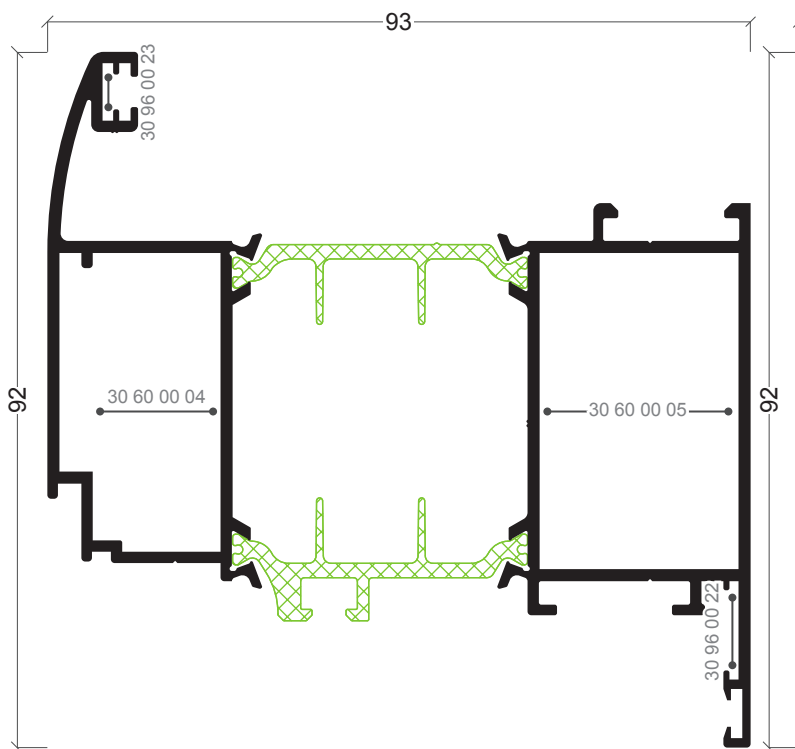

APi-84
Aro móvel

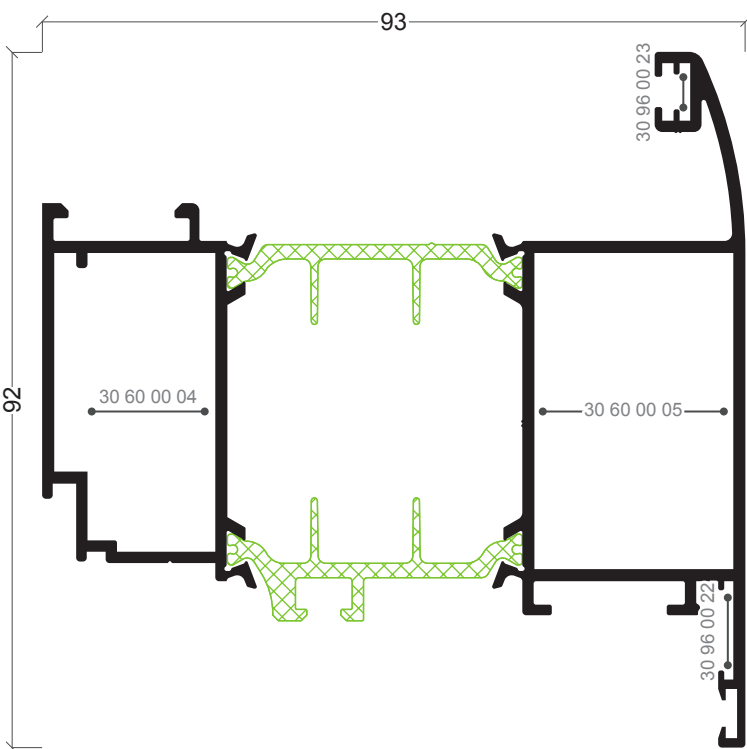

APi-85
Aro móvel

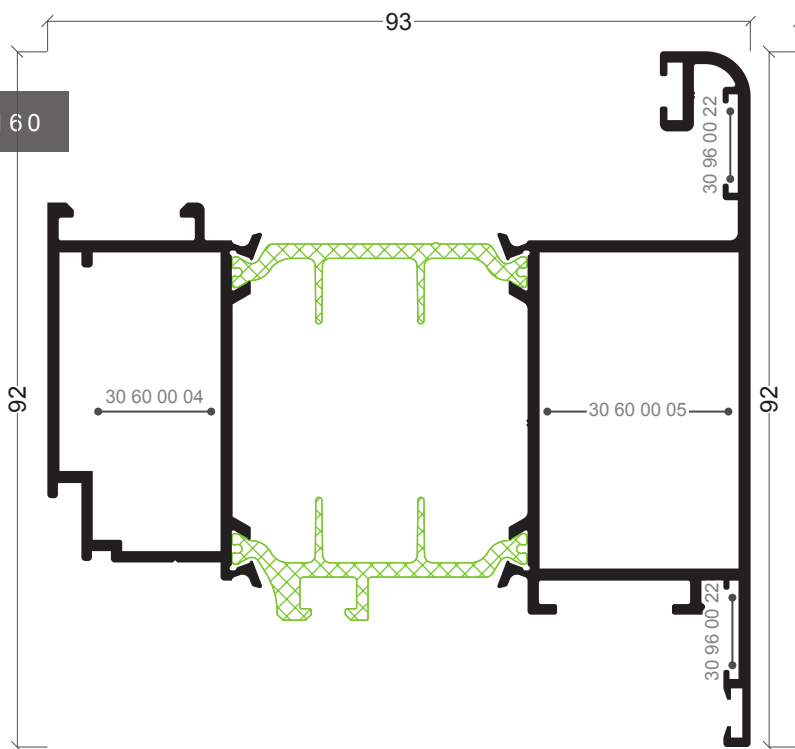

APi-90
Aro móvel

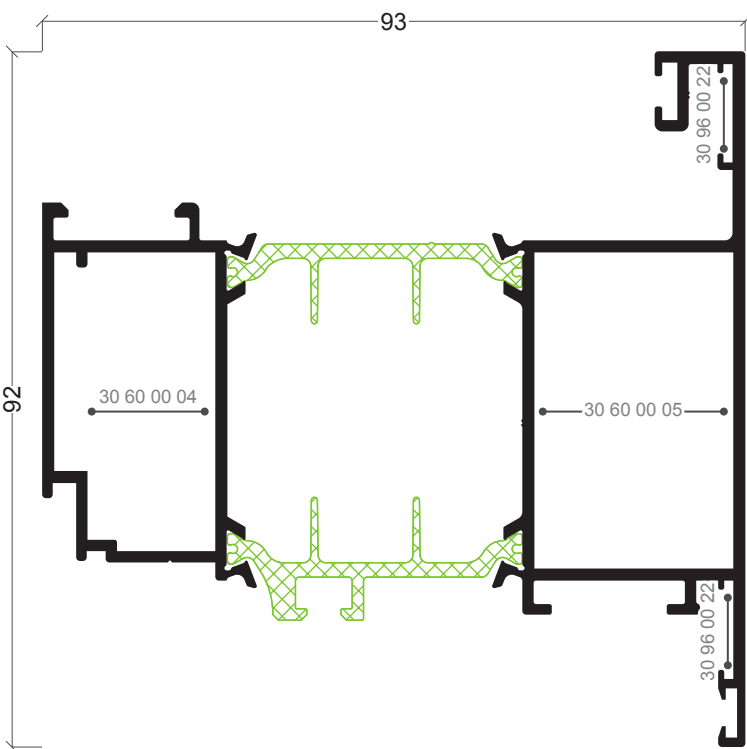

APi-72
Aro móvel

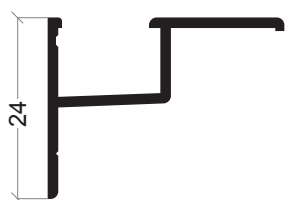

Y-20
Recolha de águas condensação

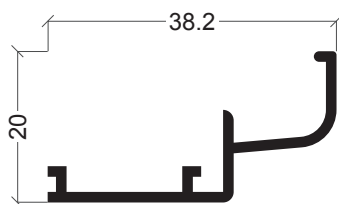

ARi-32
Complemento condensação

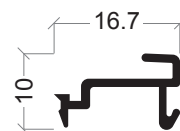

AX-33
Mola Bite

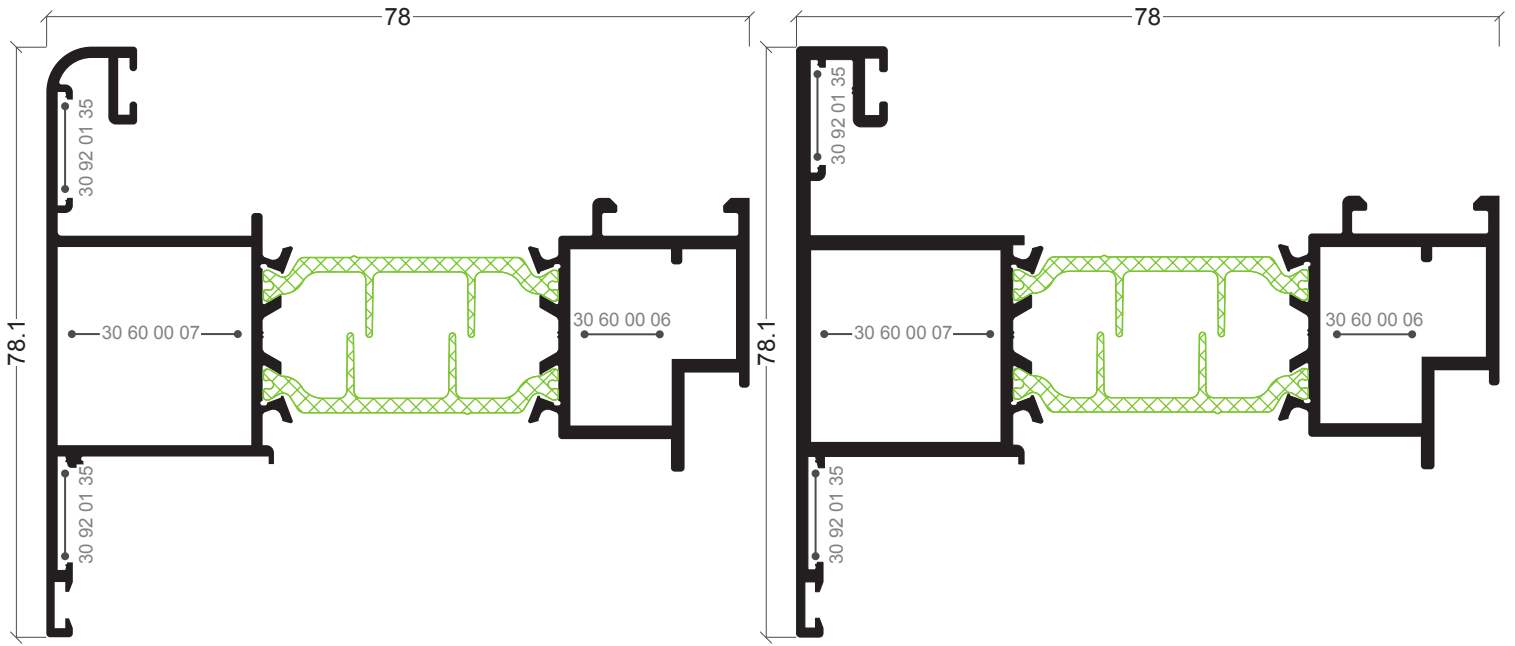

APi-07
Aro móvel projectante

APi-95
Aro móvel projectante

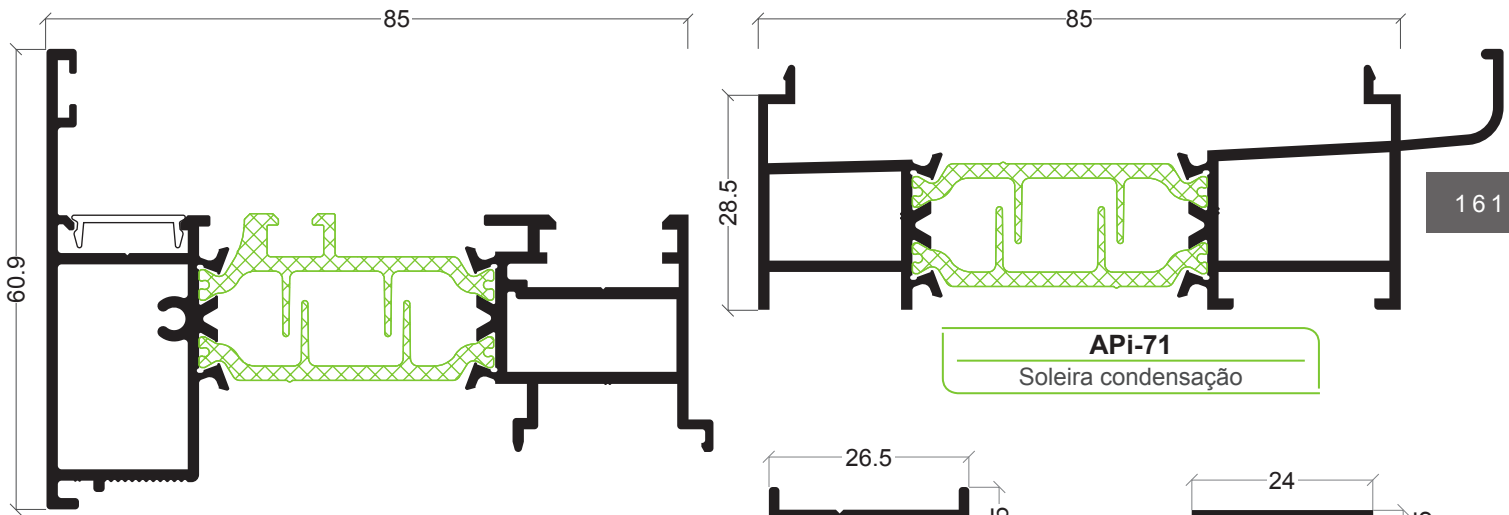

APi-04
Inversor

AXi-32
Complemento projectante

AXi-31
Guia projectante

APi-71
Soleira condensação

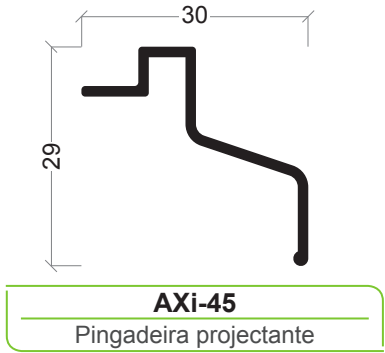

AXi-45
Pingadeira projectante



KL-04
Tampa



AX-19
Vareta

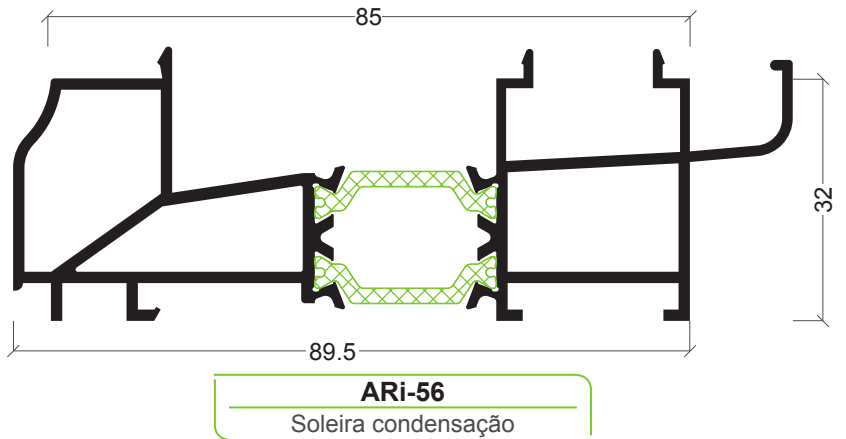

ARi-56
Soleira condensação

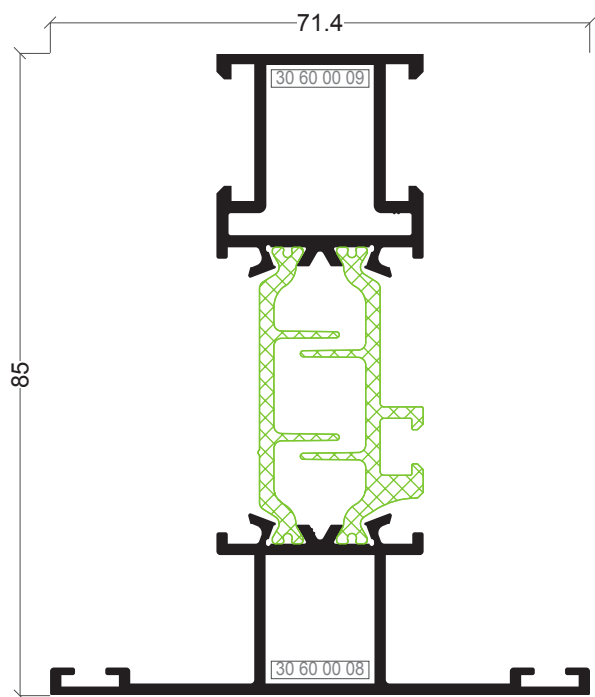

APi-01
Travessa

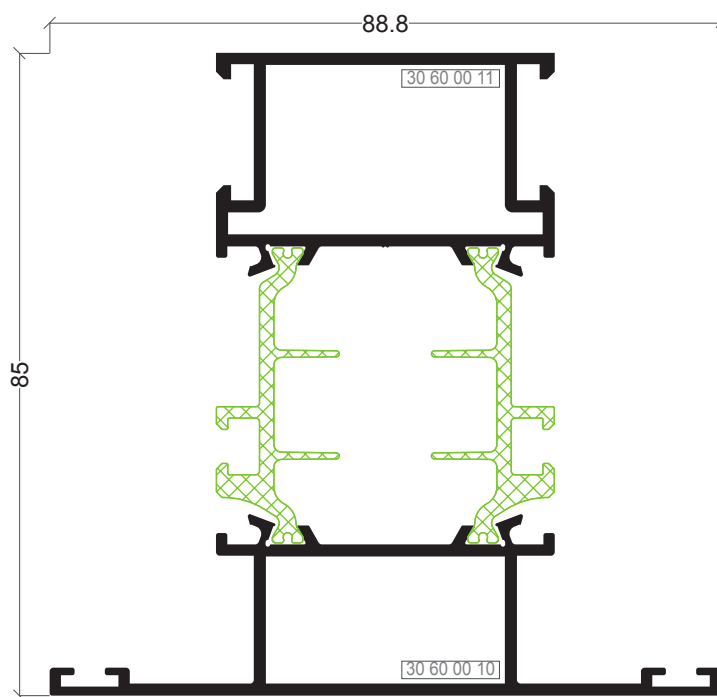

APi-06
Travessa

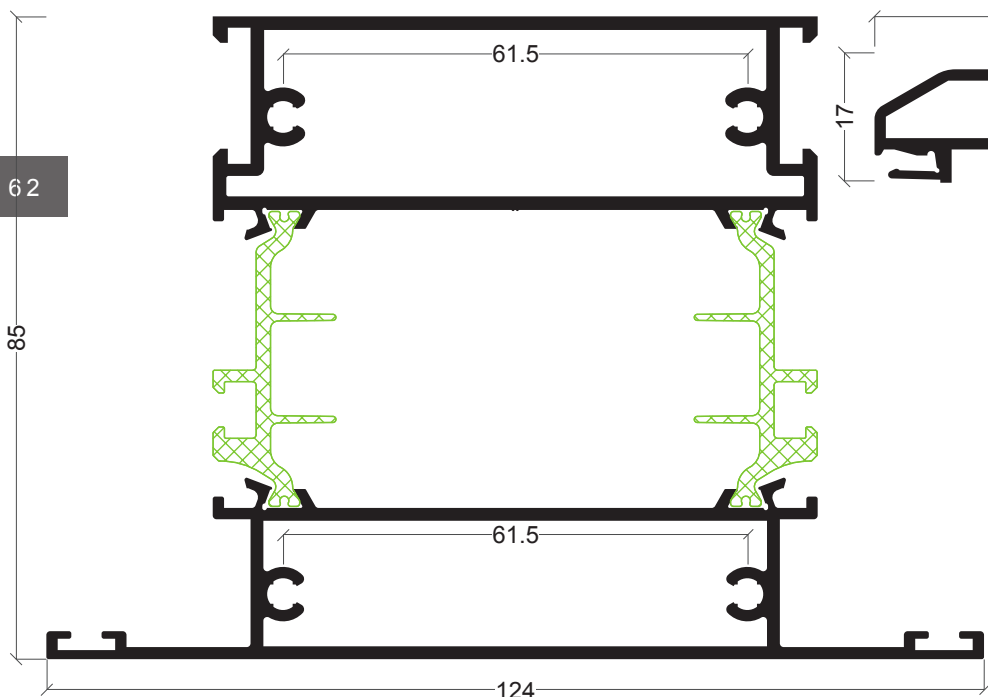

APi-12
Travessa

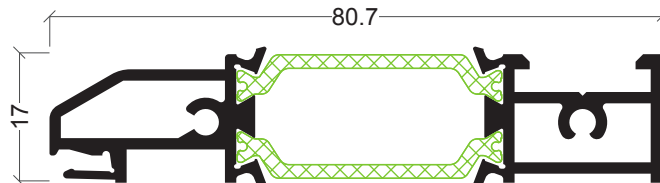

APi-63
Remate inferior porta

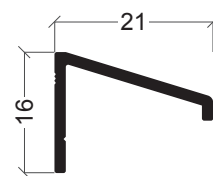

A1-46
Pingadeira janela

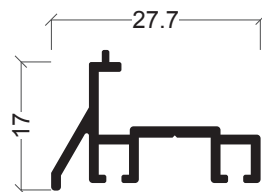

AJi-62
Pingadeira inferior porta sacada

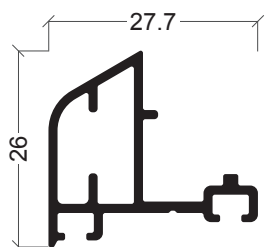

AZ-79
Pingadeira inferior de porta

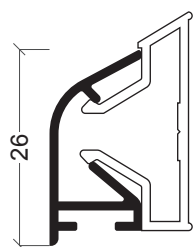

AZ-60
Pingadeira

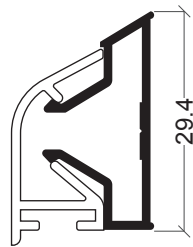

AZ-61
Clip pingadeira

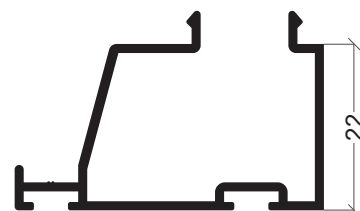

AJi-82
Bite remate

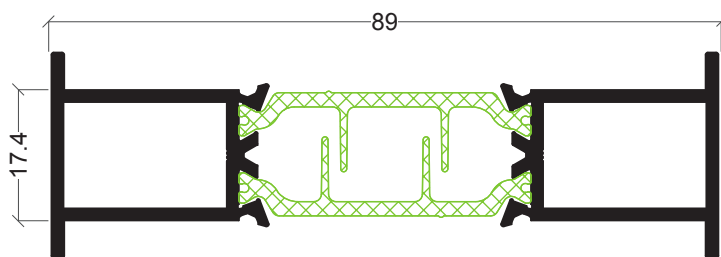

API-21
União de aros

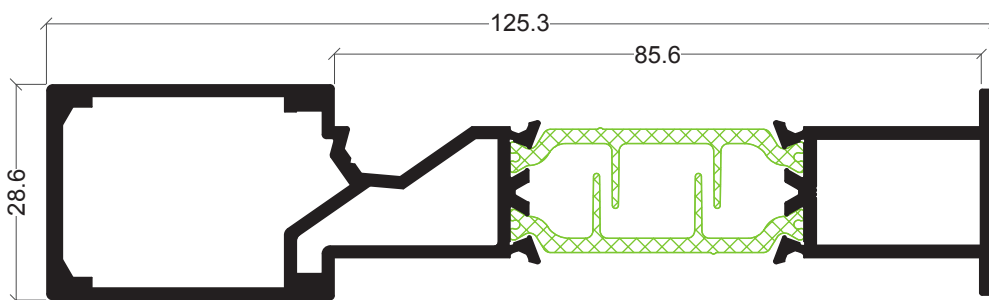

API-65
União de aros

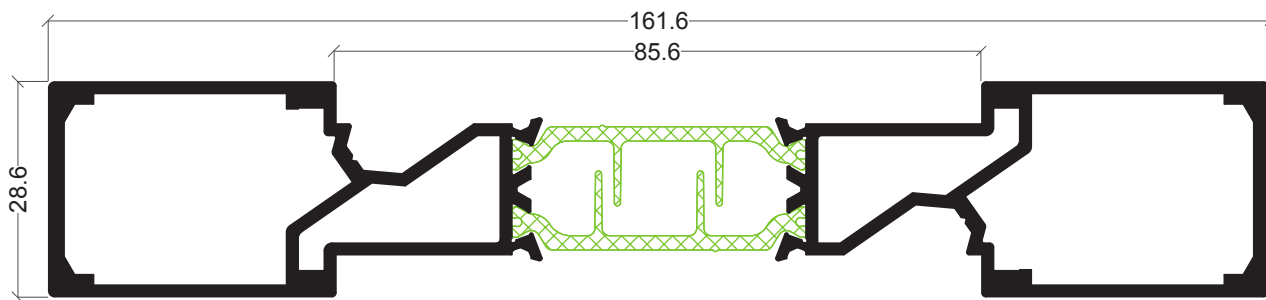

API-67
União de aros

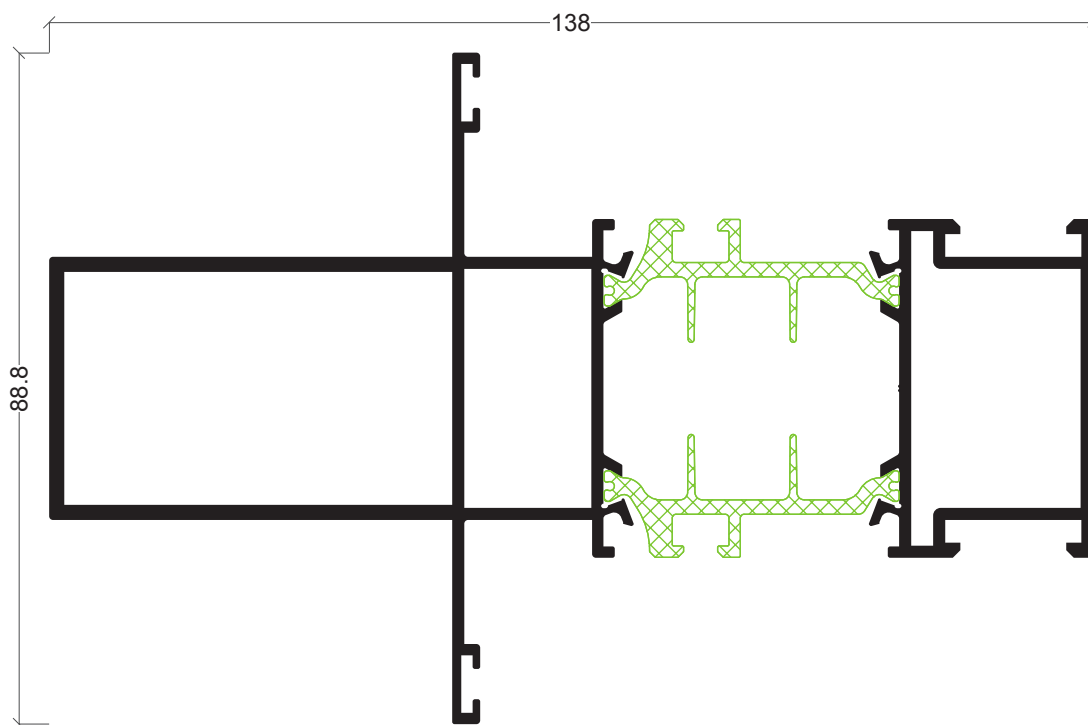

API-79
Montante recto

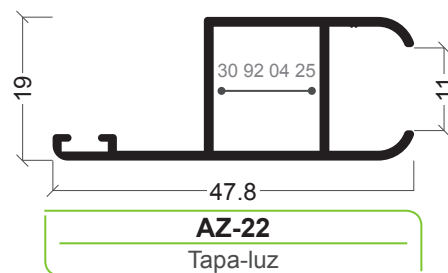
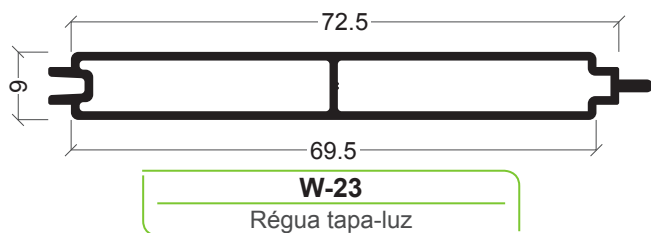
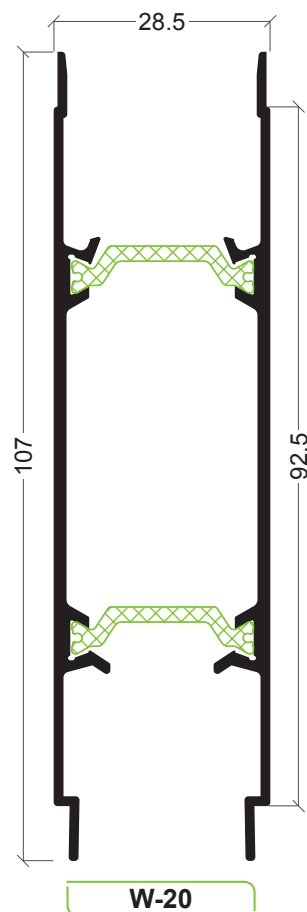
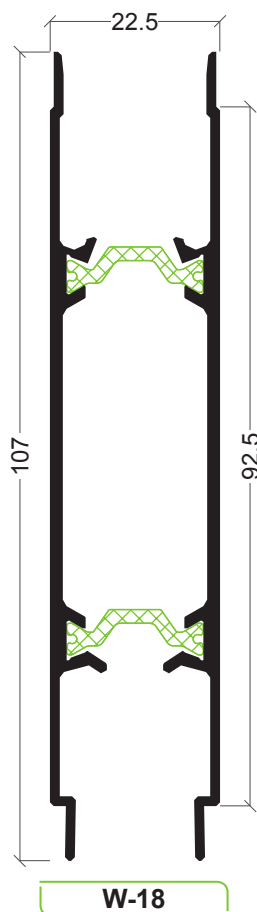
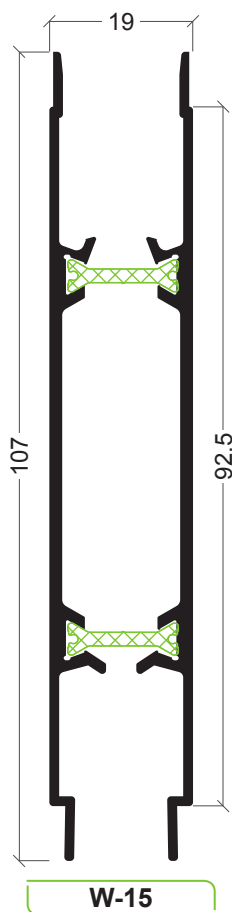

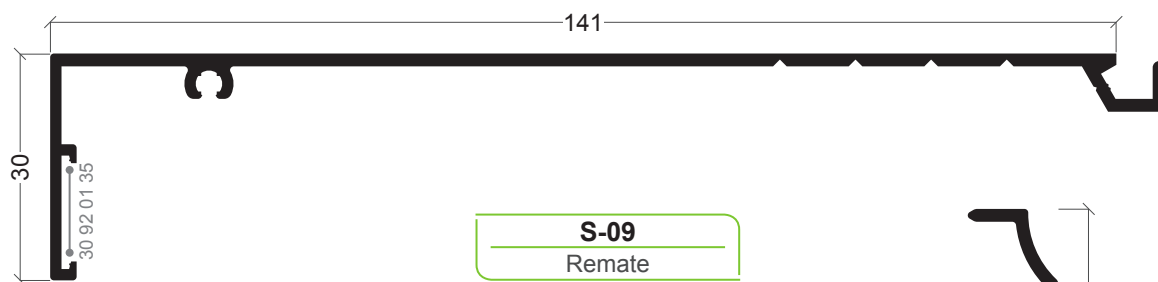

S-09
Remate

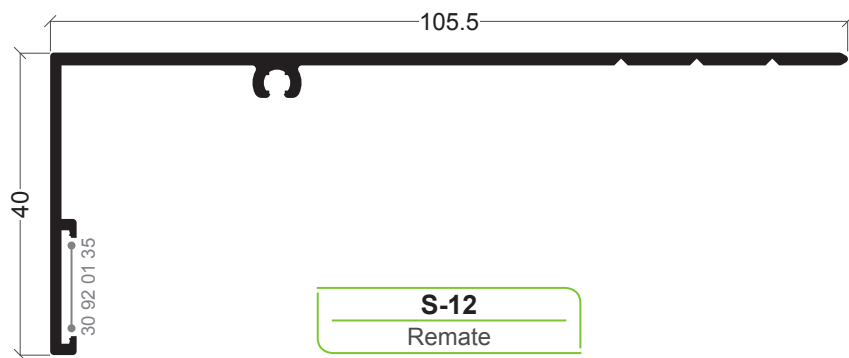

S-12
Remate

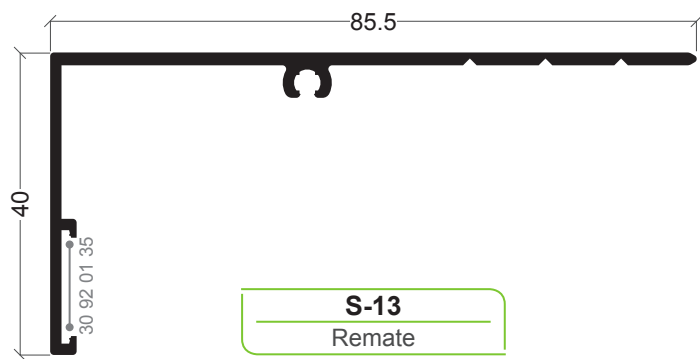

S-13
Remate

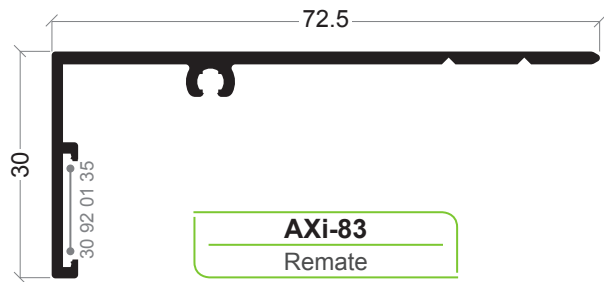

AXi-83
Remate

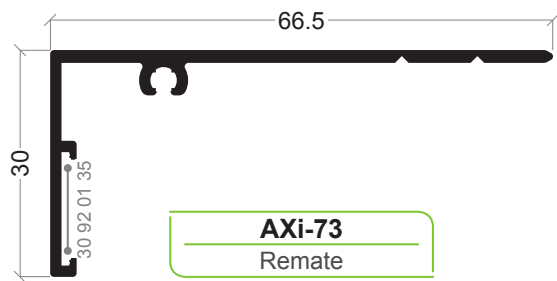

AXi-73
Remate

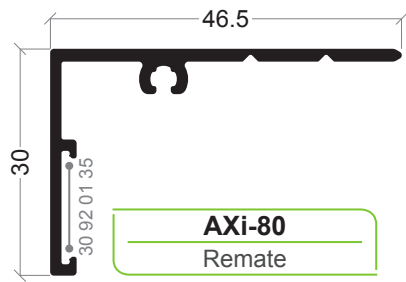

AXi-80
Remate

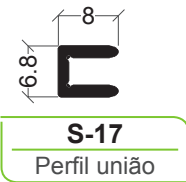

S-17
Perfil união



S-18
Remate



S-14
Remate

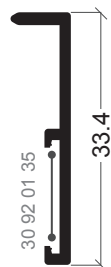

AXi-88
Complemento remate



AXi-91
Complemento remate

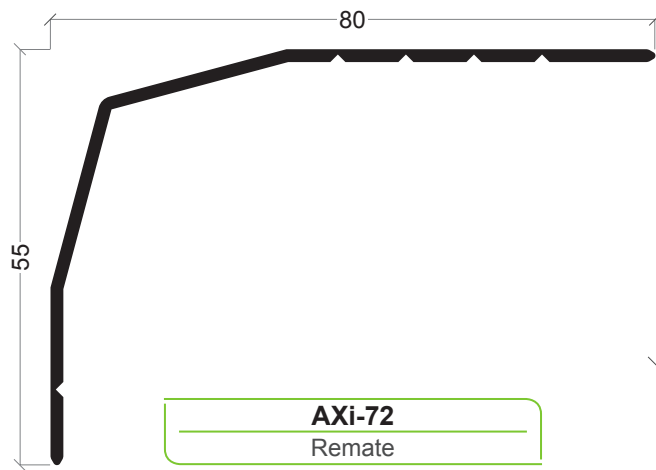

AXi-72
Remate

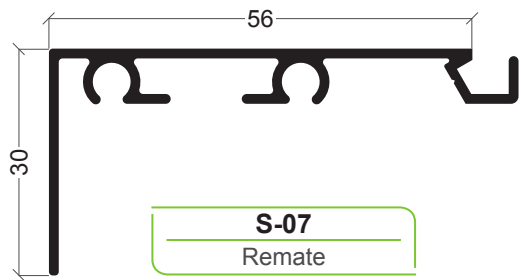

S-07
Remate

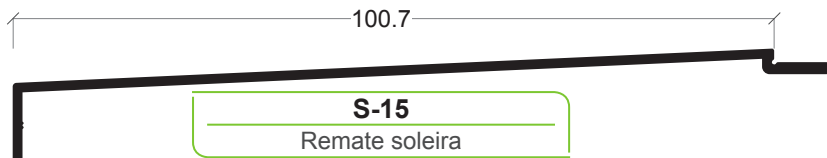

S-15
Remate soleira

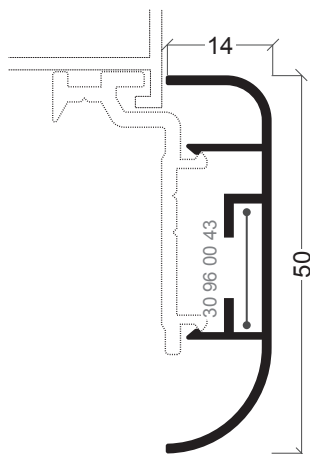

ARi-27
Tapa juntas

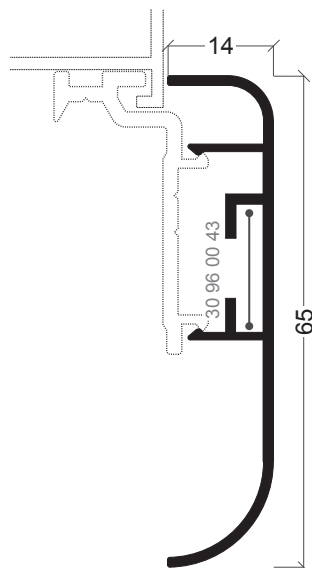

ARi-34
Tapa juntas

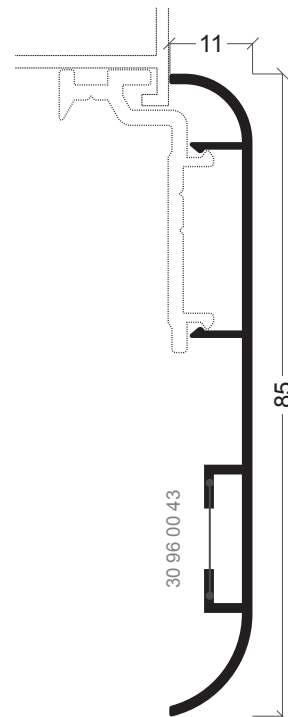

ARi-28
Tapa juntas

166

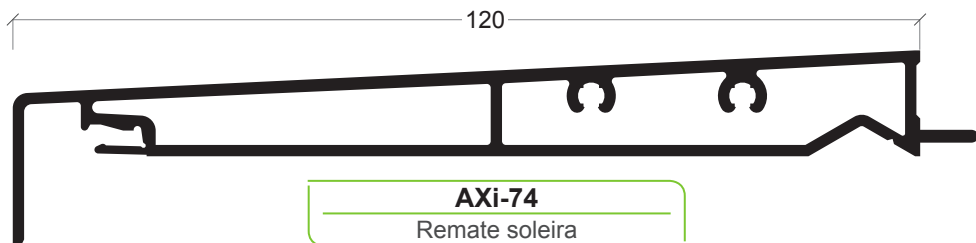

AXi-74
Remate soleira

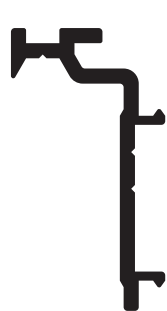

ARi-26
Mola tapa juntas

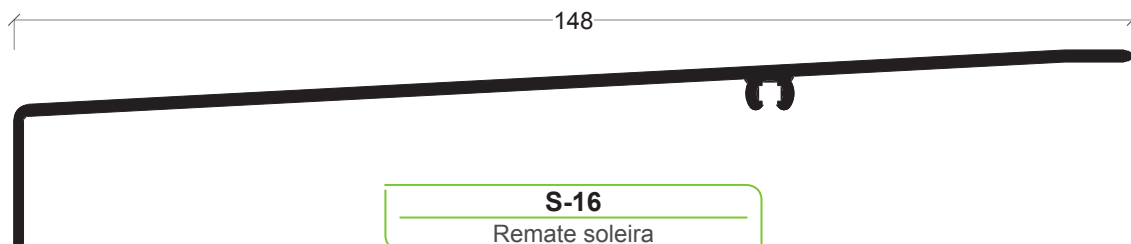

S-16
Remate soleira



ARi-24
Mola tapa juntas

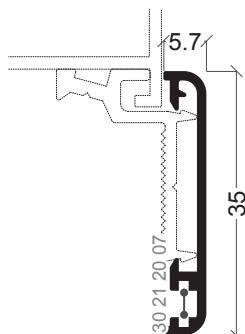

ARi-30
Tapa juntas

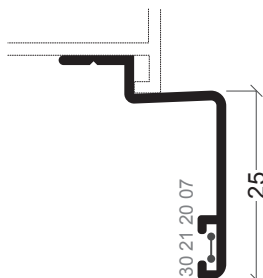

ARi-66
Tapa juntas

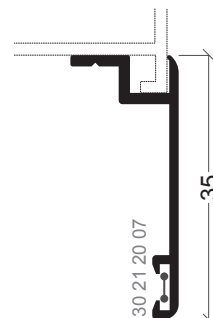

ARi-31
Tapa juntas

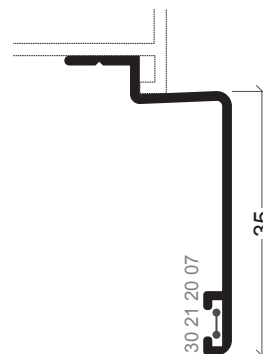

ARi-37
Tapa juntas

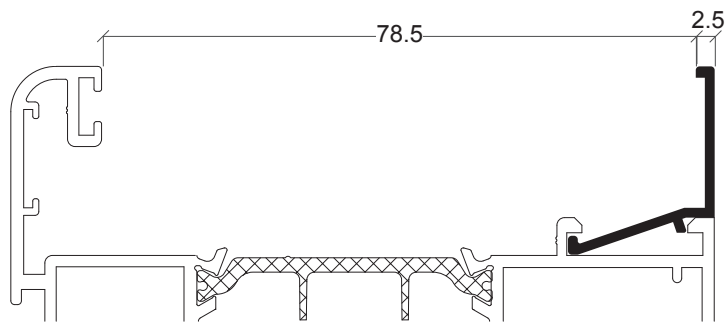

AX-69

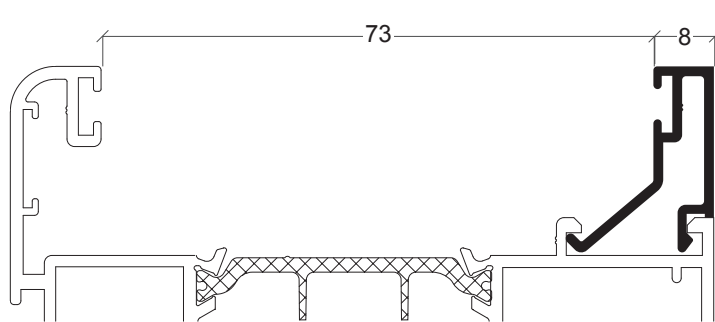

AX-74

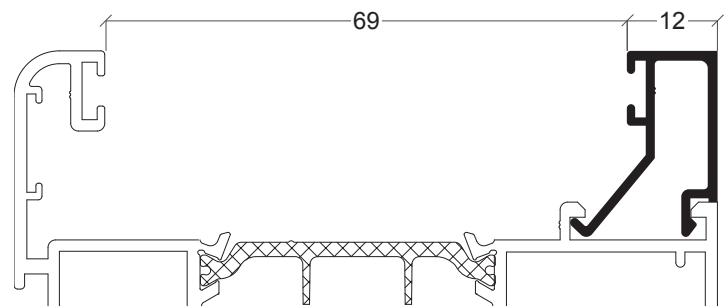

AX-36

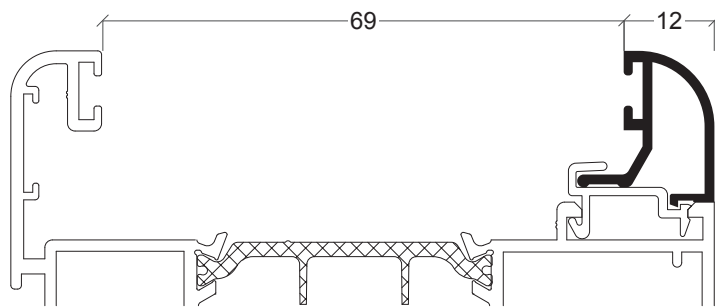

AX-37

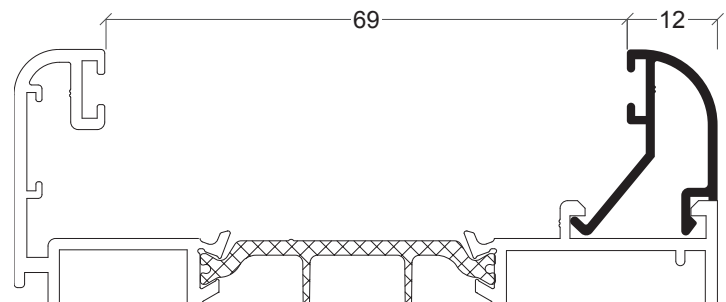

AZ-08

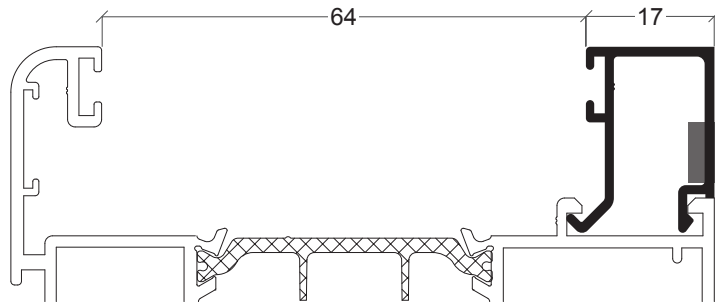

AX-46

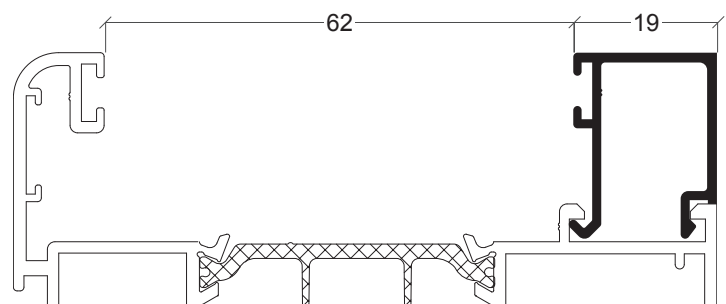

AX-35

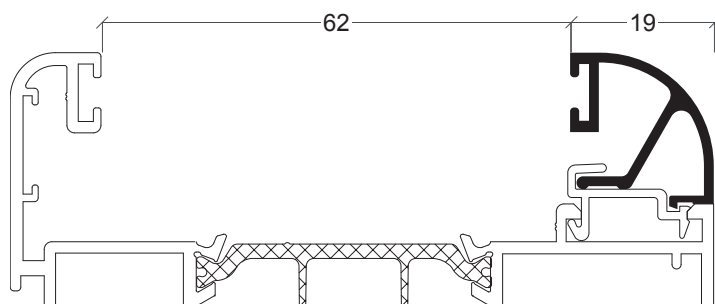

AX-30

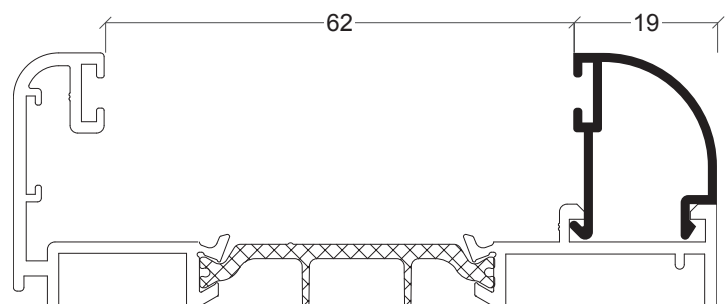

AZ-07

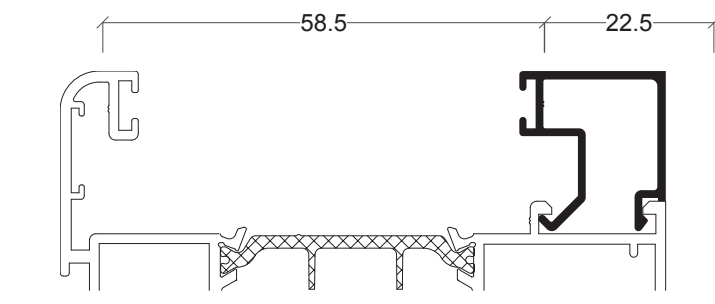

AX-78

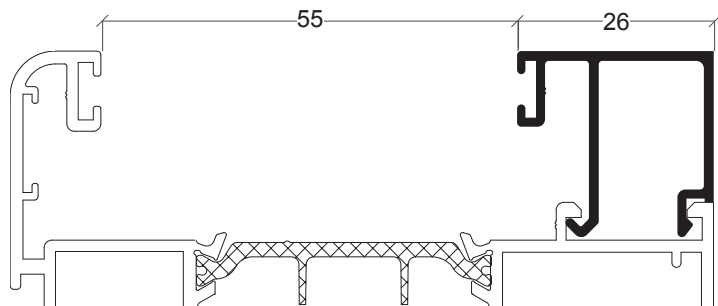

AX-31

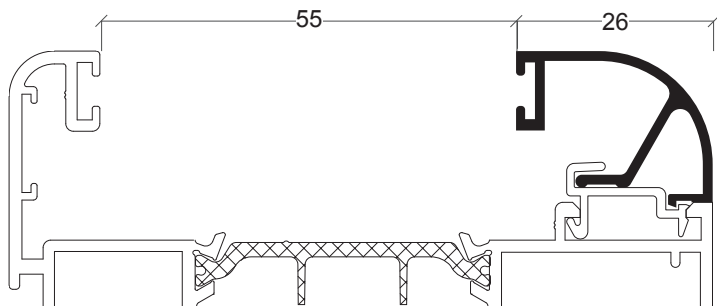

AX-29

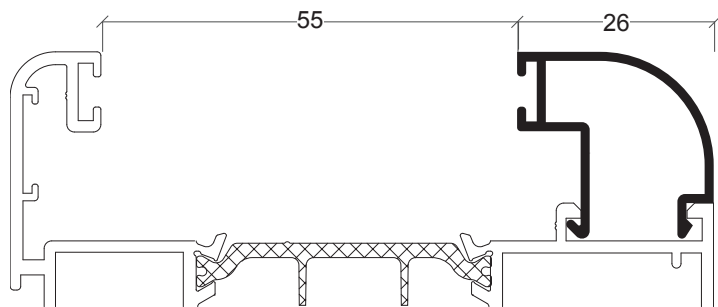

AZ-06

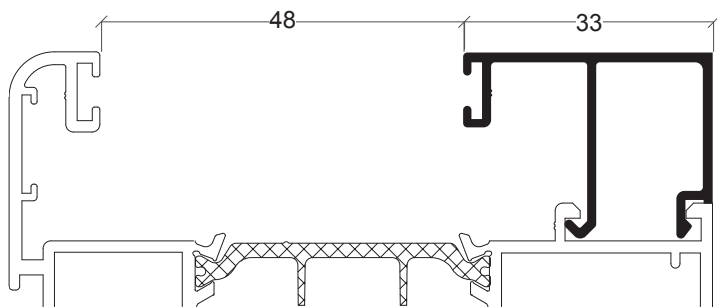

AX-34

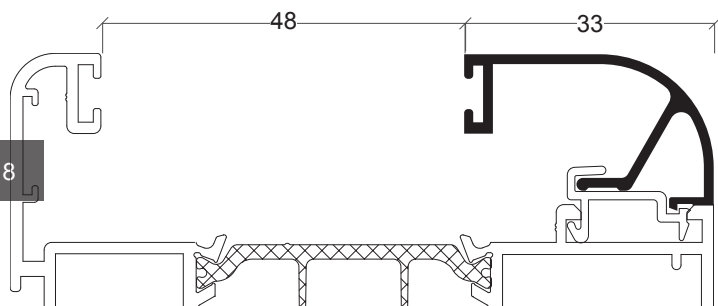

AX-39

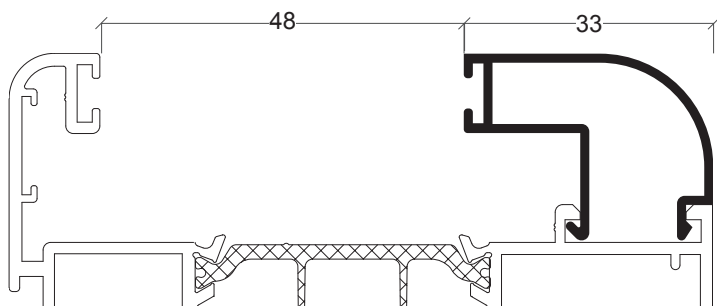

AZ-28

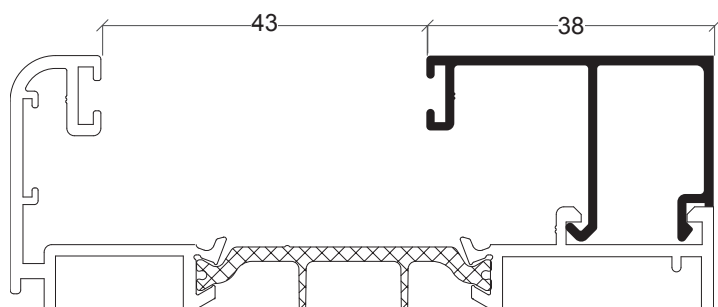

AX-32

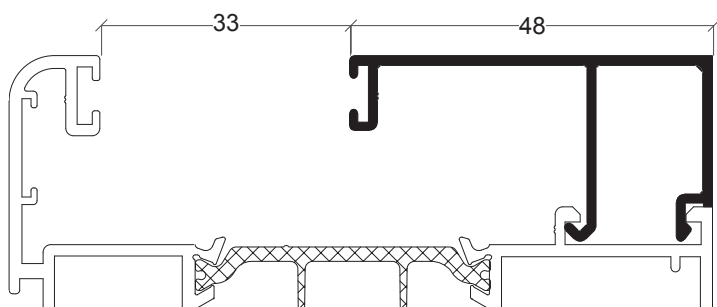

AX-80

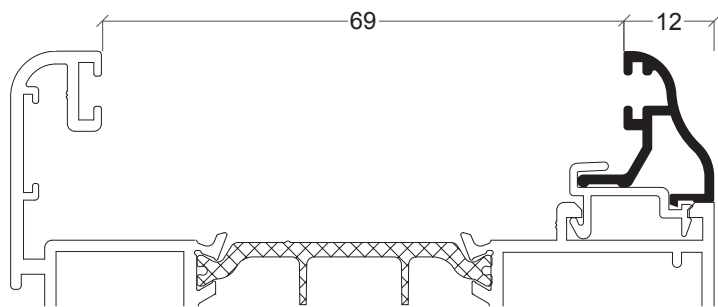

AX-72

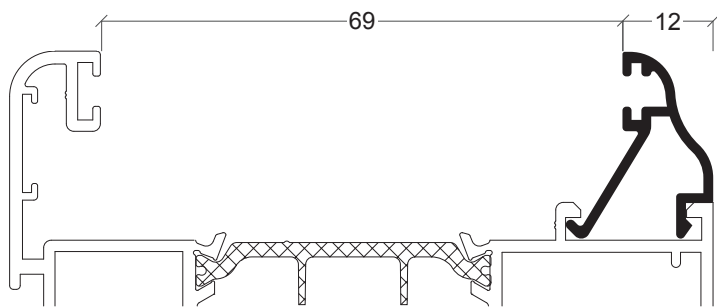

AX-73

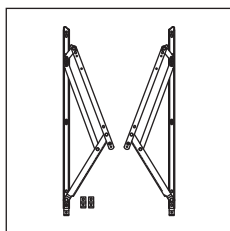

30 00 95 21
Jogo compasso (180 kg)

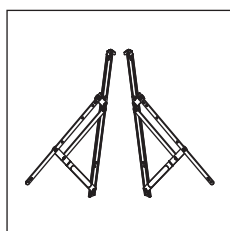

30 00 95 71
Jogo compasso (60 kg)

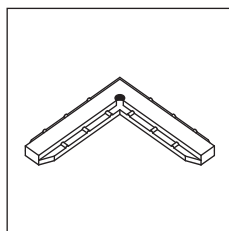

30 21 20 07
Esquadro de alinhamento

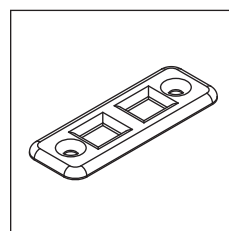

30 24 30 75
Contra-fecho inox

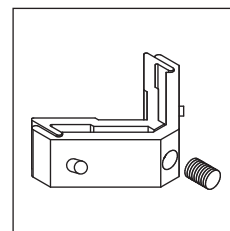

30 60 00 01
Esquadro exterior janela

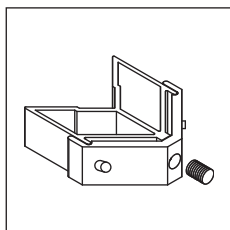

30 60 00 02
Esquadro exterior porta

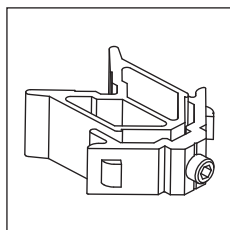

30 60 00 03
Esquadro interior porta com clip

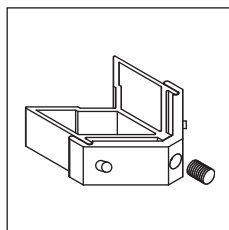

30 60 00 04
Esquadro exterior porta

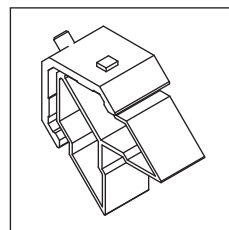

30 60 00 05
Esquadro interior porta

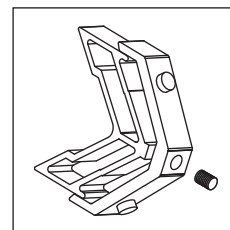

30 60 00 06
Esquadro interior projectante

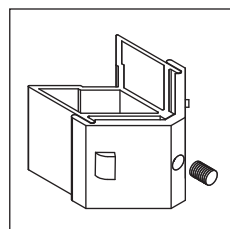

30 60 00 07
Esquadro exterior projectante

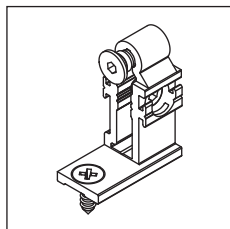

30 60 00 08
União travessa exterior pequena fixo

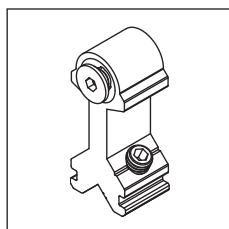

30 60 00 09
União travessa interior pequena

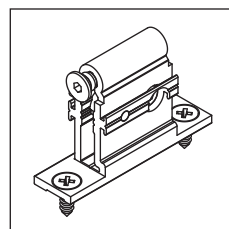

30 60 00 10
União travessa exterior grande fixo/móvel

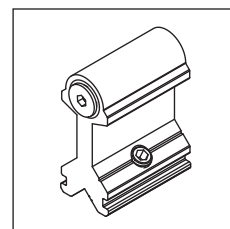

30 60 00 11
União travessa interior grande

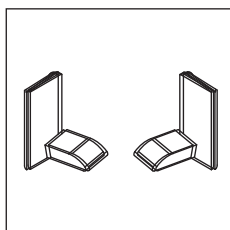

30 60 00 13
Conjunto topos AJI-62

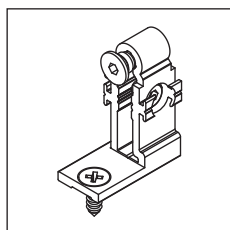

30 60 00 16
União travessa exterior pequena móvel

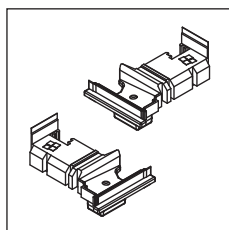

30 70 00 12
Conjunto topos inversor API

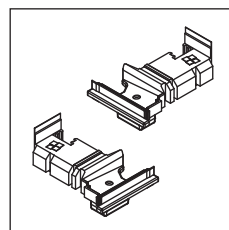

30 70 00 15
Conjunto topos API-63

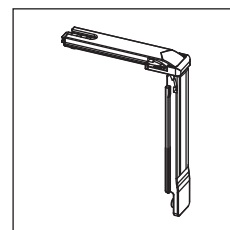

30 90 20 42
Ângulo de reenvio

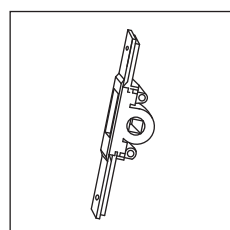

30 90 20 44
Transmissão para abertura exterior

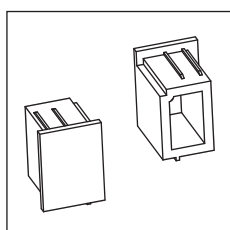

30 91 21 20
Jogo topos condensação Y-20

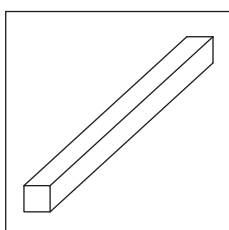

30 91 41 23
Perno 7 x 131 mm

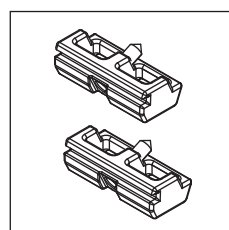

30 92 00 50
Complemento fecho

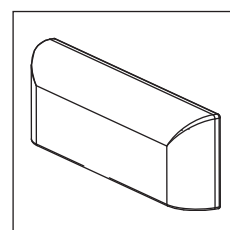

30 92 01 00/01
Goteira preto/branco

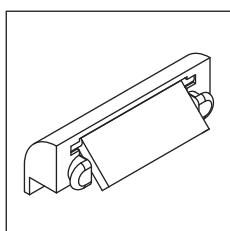

30 92 01 02/03
Goteira com válvula preto /branco

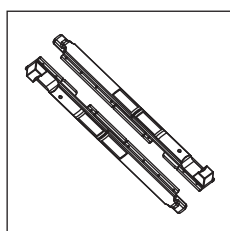

30 92 01 20
Jogo fecho C.E.

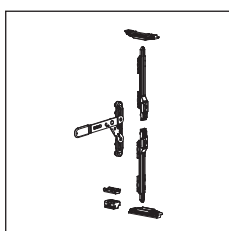

30 92 01 23
Jogo de passadores bidireccional C.E.

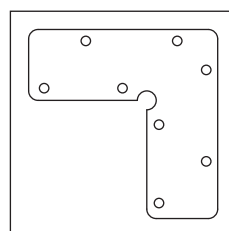

30 92 01 35
Esquadro de alinhamento

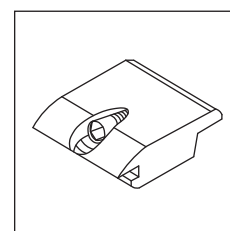

30 92 02 60
Apoio da folha

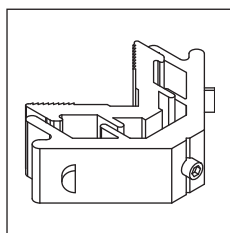

30 92 04 25

Esquadro interior janela fixo com clip

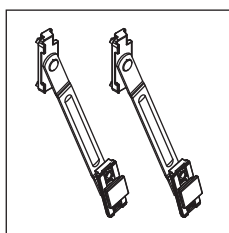

30 92 04 75

Jogo compassos basculante

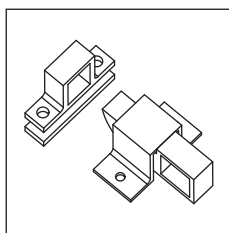

30 92 04 76/77

Fecho clack branco/preto

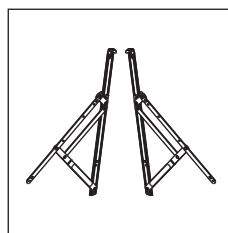

30 92 04 80

Compasso projectante deslizante até 50 kg / folha

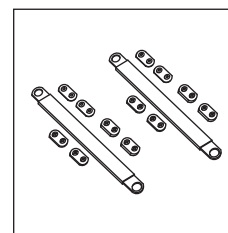

30 92 04 85

Jogo compassos

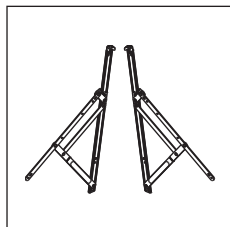

30 92 04 90

Compasso projectante deslizante até 70 kg / folha

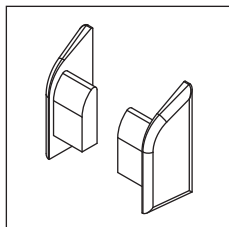

30 92 05 00

Jogo topos

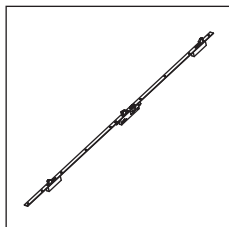

30 92 05 10

Fechadura 3 pontos (35 mm)

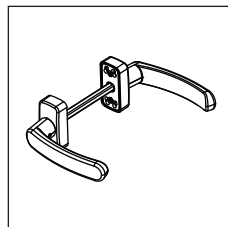

30 92 05 15

Fecho de alavanca com 5 pontos de fecho

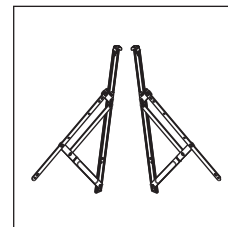

30 92 06 00

Compasso projectante deslizante até 20 kg / folha

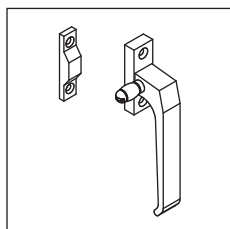

30 92 06 10/11

Cremone de lingueta branco/preto

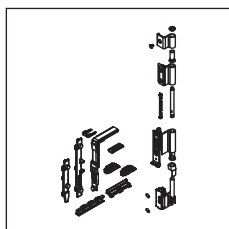

30 92 12 56/57

Kit OB Eco 80 kg sem cremone branco/preto

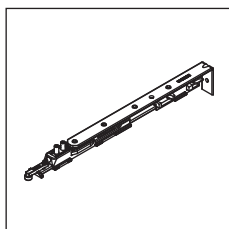

30 92 12 58

Compasso OB Eco 457-1300

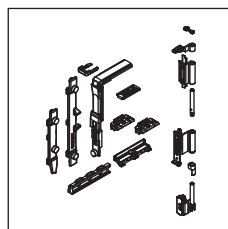

30 92 12 60/61

Kit OB sem cremone branco/preto

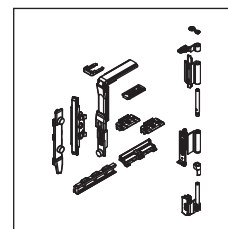

30 92 12 62/63

Kit OB sem puxador com transmissão branco/preto

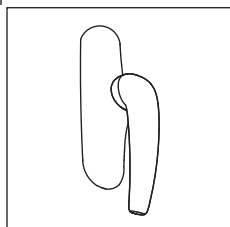

30 92 12 64/65

Cremone OB branco/preto

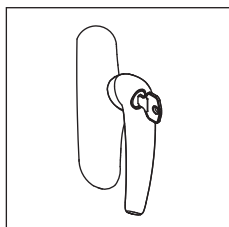

30 92 12 66/67

Cremone OB com chave branco/preto

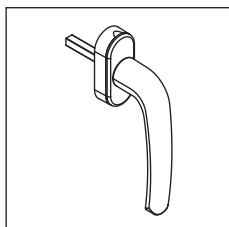

30 92 12 68/69

Puxador branco/preto

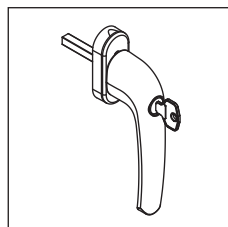

30 92 12 70/71

Puxador com chave branco/preto

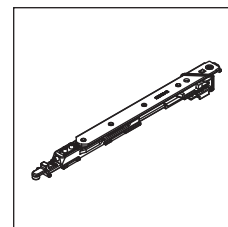

30 92 12 72

Compasso OB pequeno 457-550

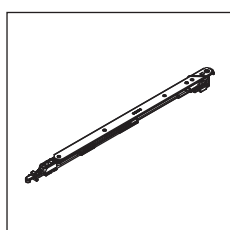

30 92 12 73

Compasso OB grande 551-1800

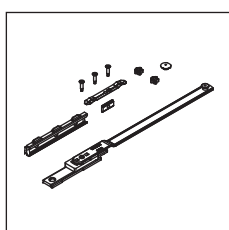

30 92 12 74

Compasso OB suplementar 1000-1800

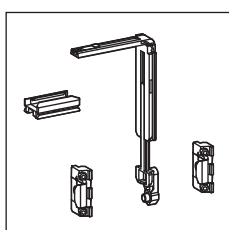

30 92 12 75

Kit fecho 3º ponto OB

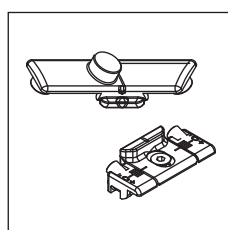

30 92 12 76

Ponto de fecho suplementar

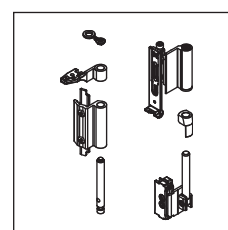

30 92 12 77/78

Kit dobradiça 2ª folha OB branco/preto

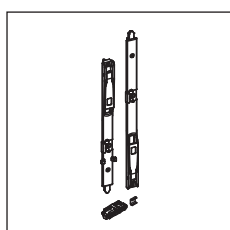

30 92 12 79

Conjunto de fechos 2ª folha OB

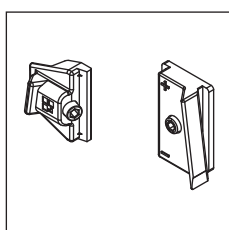

30 92 12 80

Conjunto de ponto de fecho suplementar passivo

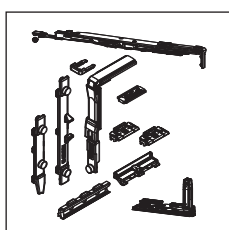

30 92 12 81/82

Kit OB oculto s/ cremone c/ compasso pequeno dir/esq

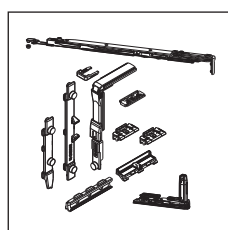

30 92 12 83/84

Kit OB oculto s/ cremone c/ compasso grande dir/esq

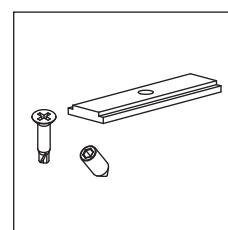

30 92 12 85

Suplemento OB oculto 131-170 kg

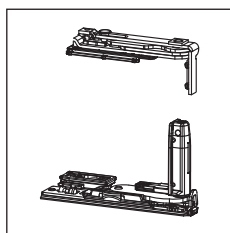

30 92 12 86/87

Kit dobradiça oculto 2ª
folha dir/esq

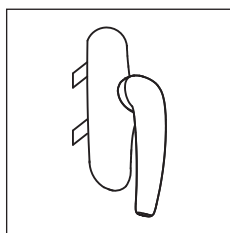

30 92 12 88/89

Cremone batente branco/
preto

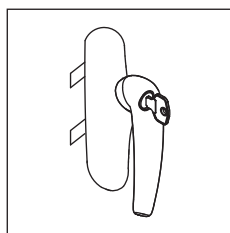

30 92 12 90/91

Cremone batente com
chave branco/preto

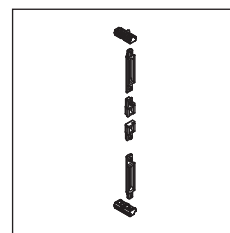

30 92 12 92

Kit batente sem cremone

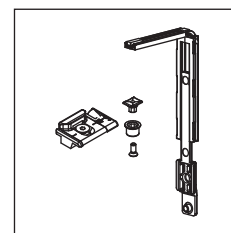

30 92 12 93

Kit fecho 3º ponto vertical
OB oculto

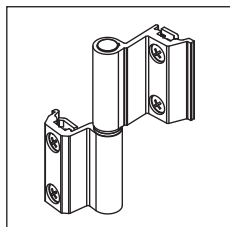

30 92 12 94/95

Dobradiça branco/preto

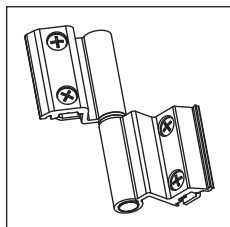

30 92 12 96/97

Dobradiça 3ª folha
branco/preto

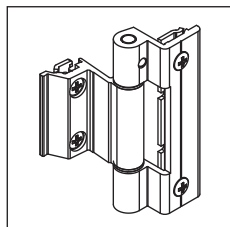

30 92 12 98/99

Dobradiça 3 nós branco/
preto

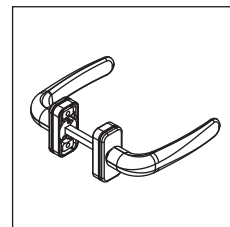

30 92 13 00/01

Puxador duplo branco/
preto

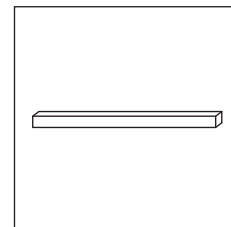

30 92 13 02

Perno 8 x 150 mm

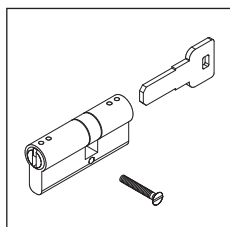

30 92 13 03

Canhão segurança 30 x
80 Níquel

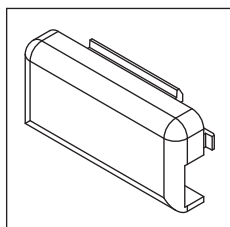

30 92 13 04

Goteira preta

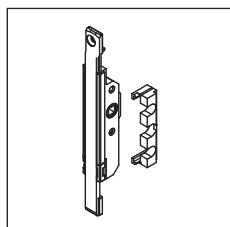

30 92 13 05

Transmissão bi-
direccional

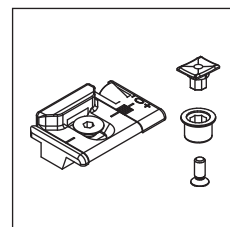

30 92 13 06

Ponto de fecho regulável

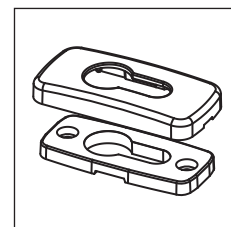

30 92 22 85/86

Escudo para canhão
branco/preto

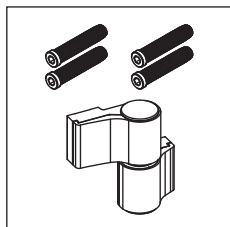

30 92 22 88/89

Dobradiça 2 abas porta c/ ressalto
fixação directa branco/preto

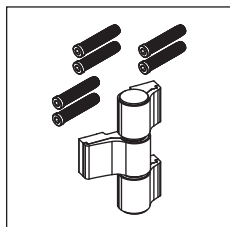

30 92 22 90/91

Dobradiça 3 abas porta c/ ressalto
fixação directa branco/preto

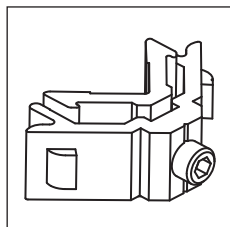

30 96 00 04

Esquadro interior janela

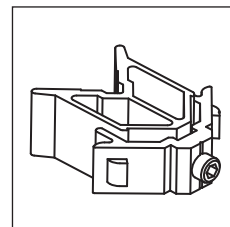

30 96 00 05

Esquadro interior aro fixo
porta

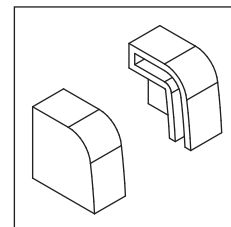

30 96 00 12

Jogo topos condensação

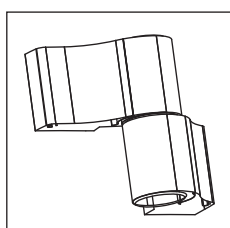

30 96 00 17/21

Dobradiça com ressalto
branco/preto

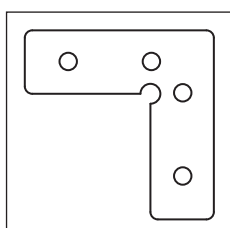

30 96 00 22

Esquadro alinhamento

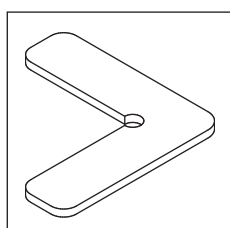

30 96 00 23

Esquadro alinhamento
aro fixo

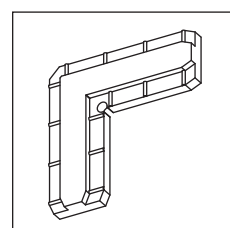

30 96 00 43

Esquadro alinhamento

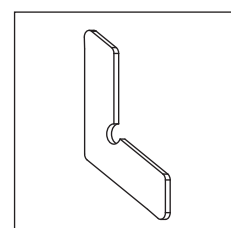

30 96 00 63

Esquadro alinhamento

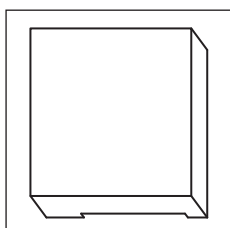

30 96 10 01

Calço para vidro aro
móvel

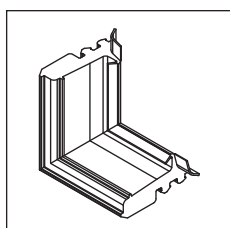

30 96 10 07

Canto vulcanizado

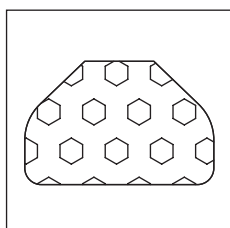

30 99 00 01

ThermoProfile ISO-01

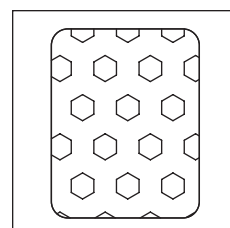

30 99 00 02

ThermoProfile ISO-02

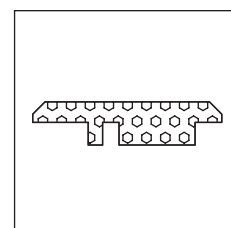

30 99 00 06

ThermoProfile ISO-06

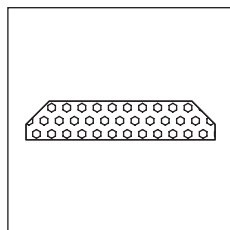

30 99 00 07

ThermoProfile ISO-07

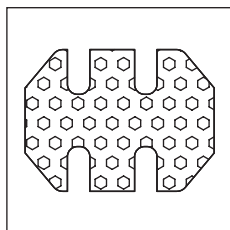

30 99 00 10

ThermoProfile ISO-10

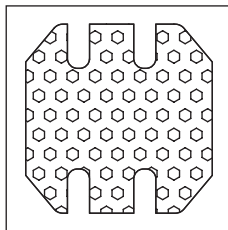

30 99 00 13

ThermoProfile ISO-13

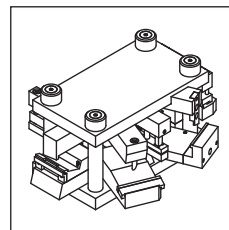

33 98 22 99

Cunho APi

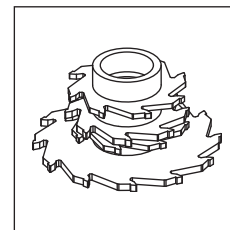

33 98 31 99

Conjunto de frezas fixo

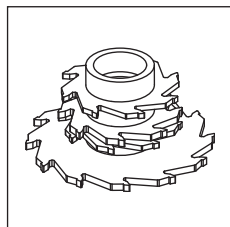

33 98 32 99

Conjunto de frezas móvel

Referência	Desenho	Descrição
30 00 95 15		Junta de vedação curta AZ-79
30 60 00 14		Perfil pelúcia metálica 18 mm preto
30 60 00 17		Junta exterior vidro plana 2 mm preto
30 60 00 18		Junta Isolante
30 92 04 70		Espuma isolante
30 93 00 60		Junta exterior do vidro (4 mm) preto
30 93 00 61		Junta de vedação exterior (2 mm) preto
30 93 00 62		Junta exterior plana para vidro (4 mm) preto
30 93 00 65		Junta interior para vidro (5 mm) preto
30 93 00 66		Junta interior para vidro (4 mm) preto
30 93 00 67		Junta interior para vidro (2 mm) preto
30 93 00 68		Junta interior para vidro (6/7 mm) preto
30 93 00 69		Junta interior para vidro (8/9 mm) preto
30 93 00 82		Junta vedação inferior AZ-79
30 93 01 20		Junta interior
30 94 01 46		Junta para veda-luz AZ-22
30 95 00 10		Pelúcia 7x9 mm
30 96 00 18		Junta interior (abertura projectante/deslizante)
30 96 10 06		Junta central termo isolante

Referência	ThermoProfile (Baguetes de 70 cm)	Aplicação
30 99 00 01		APi-01; APi-03; APi-04; APi-05; APi-07; APi-21; APi-33; APi-35; APi-61; APi-65; APi-67; APi-71; APi-73; APi-74; APi-75; APi-76; APi-80; APi-81; APi-83; APi-86; APi-87; APi-88; APi-89; APi-91; APi-95
30 99 00 02		APi-01; APi-03; APi-04; APi-05; APi-07; APi-21; APi-33; APi-35; APi-61; APi-65; APi-67; APi-71; APi-73; APi-74; APi-75; APi-76; APi-80; APi-81; APi-83; APi-86; APi-87; APi-88; APi-89; APi-91; APi-95
30 99 00 06		APi-01; APi-03; APi-06; APi-08; APi-12; APi-20; APi-33; APi-35; APi-68; APi-73; APi-74; APi-75; APi-76; APi-79; APi-80; APi-81; APi-86; APi-87; APi-88; APi-89; APi-91; APi-92; APi-93; APi-94
30 99 00 07		APi-05; APi-07; APi-10; APi-36; APi-61; APi-72; APi-83; APi-84; APi-85; APi-90; APi-95
30 99 00 10		APi-06; APi-08; APi-68; APi-79; APi-92; APi-93; APi-94
30 99 00 13		APi-10; APi-36; APi-72; APi-84; APi-85; APi-90

Janela 1 folha abrir e oscilo-batente

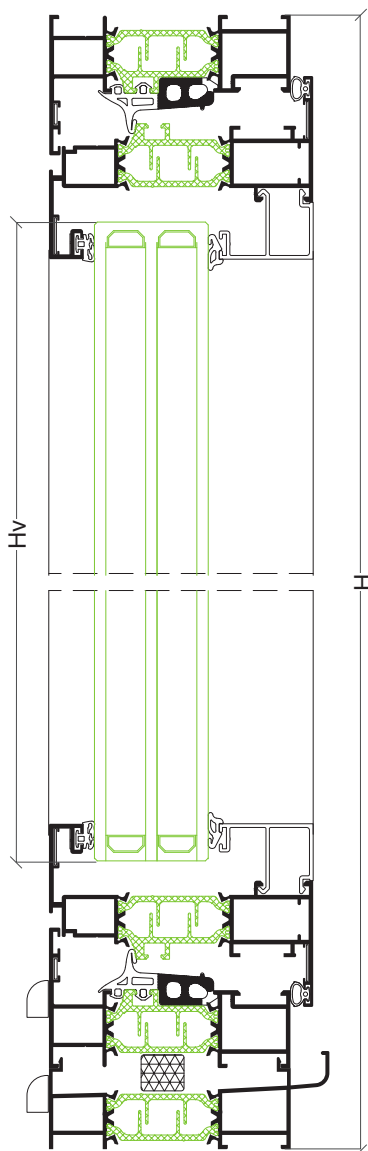
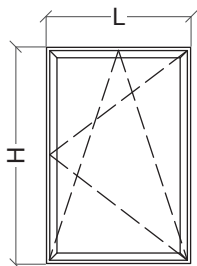

Perfis

Desenho	Ref	Descrição	Corte	Quant	Medida
	API-03	Aro fixo		2	L
				2	H-28.5 mm
	API-61	Aro móvel		2	L-43 mm
				2	H-71.5 mm
	---	Bite		2	L-132 mm
				2	H-200.5 mm
	AX-19	Vareta		várias	---
	API-71	Soleira		1	L

Acessórios e Juntas

Referência	Descrição	Quantidade	
		Abrir	Oscilo-batente
30 96 00 04	Esquadro interior		8
30 60 00 01	Esquadro exterior		8
30 96 00 23	Esquadro alinhamento fixo		4
30 96 00 22	Esquadro alinhamento móvel		8
30 96 10 01	Calço para vidro	4	6
30 92 12 64/65	Cremona OB	---	1
30 92 12 88/89	Cremona batente branco/preto	1	---
---	Ferragem oscilo-batente (ver páginas 27/28)	---	1
30 92 12 92	Kit batente	1	---
30 92 12 94/95	Dobradiça branco/preto	2 ou mais	---
30 92 13 06	Ponto de fecho regulável (H > 1100 mm)	1	---
30 92 02 60	Apoio da folha	1	---
30 92 01 02	Goteira com válvula preto		4 ou mais
30 96 00 12	Jogo topos condensação		1
30 92 04 70	Espuma isolante		L
30 93 01 20	Junta interior		2L+2H
30 96 10 06	Junta central termo isolante		2L+2H
30 96 10 07	Canto vulcanizado		4
---	Junta para vidro (exterior)		2L+2H
---	Junta para vidro (interior)		2L+2H

173

Vidro



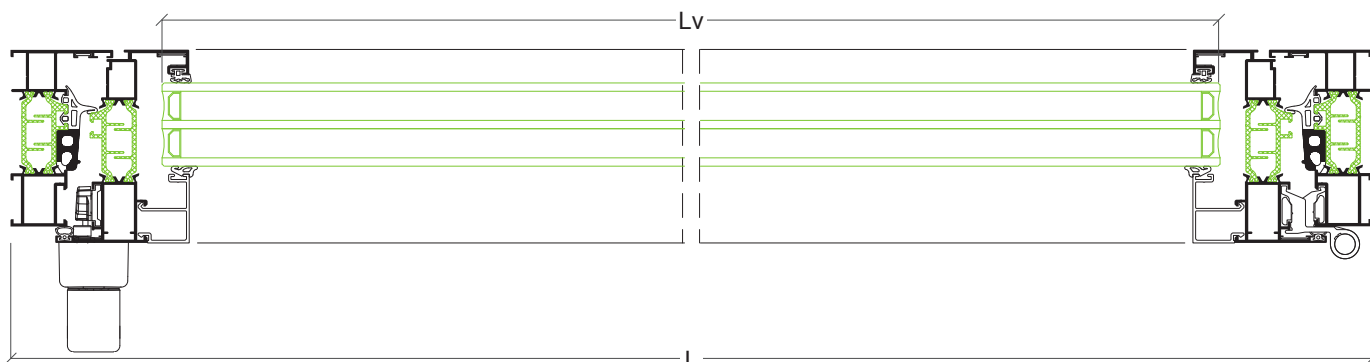



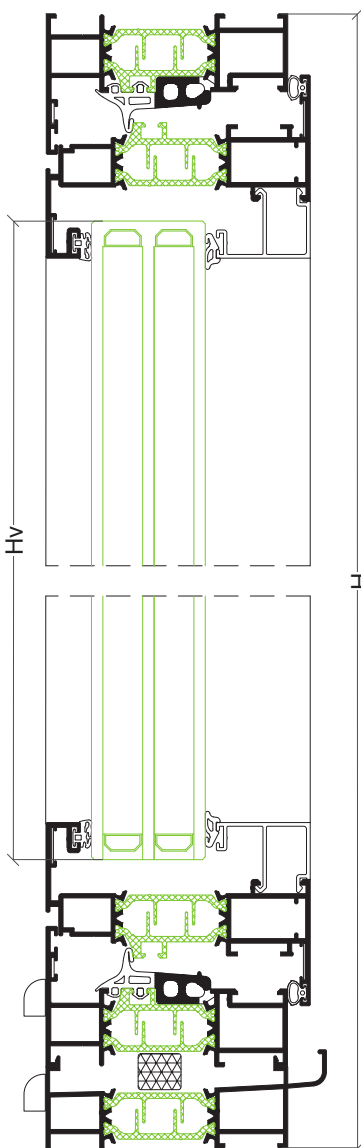
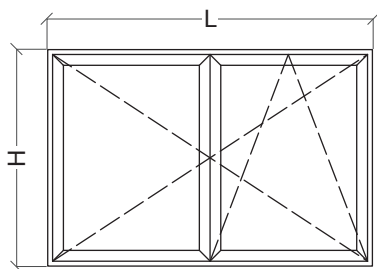



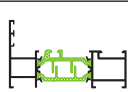

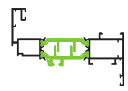



Hv = H-174 mm	Lv = L-146 mm
---------------	---------------



Janela 2 folhas abrir e oscilo-batente



Perfis

Desenho	Ref	Descrição	Corte	Quant	Medida
	API-03	Aro fixo		2	L
				2	H-28.5 mm
	API-61	Aro móvel		2	L/2-24 mm
				2	H-71.5 mm
	---	Bite		4	L/2-113 mm
				4	H-200.5 mm
	AX-19	Vareta		várias	---
	API-04	Inversor		1	H-139.5 mm
	KL-04	Perfil tampa		1	H-139.5 mm
	API-71	Soleira		1	L

Acessórios e Juntas

Referência	Descrição	Quantidade	
		Abrir	Oscilo-batente
30 96 00 04	Esquadro interior		12
30 60 00 01	Esquadro exterior		12
30 96 00 23	Esquadro alinhamento fixo		4
30 96 00 22	Esquadro alinhamento móvel		16
30 96 10 01	Calço para vidro	8	12
30 92 12 64/65	Cremona OB	---	1
---	Ferragem oscilo-batente (ver páginas 27/28)	---	1
30 92 12 92	Kit batente	1	---
30 92 01 20	Jogo fecho C.E.	1	---
30 92 12 94/95	Dobradiça branco/preto	4 ou mais	---
30 92 13 06	Ponto de fecho regulável (H > 1100 mm)	1	---
30 92 02 60	Apoio da folha	1	---
30 70 00 12	Conjunto topos inversor		1
30 96 10 06	Junta central termo isolante		2L+3H
30 96 10 07	Canto vulcanizado		4
30 92 01 02	Goteira com válvula preto		4 ou mais
30 96 00 12	Jogo topos condensação		1
30 92 04 70	Espuma isolante		L
30 93 01 20	Junta interior		2L+4H
---	Junta para vidro (exterior)		2L+4H
---	Junta para vidro (interior)		2L+4H

Vidro

Hv = H-174 mm	Lv = L/2-127 mm
---------------	-----------------

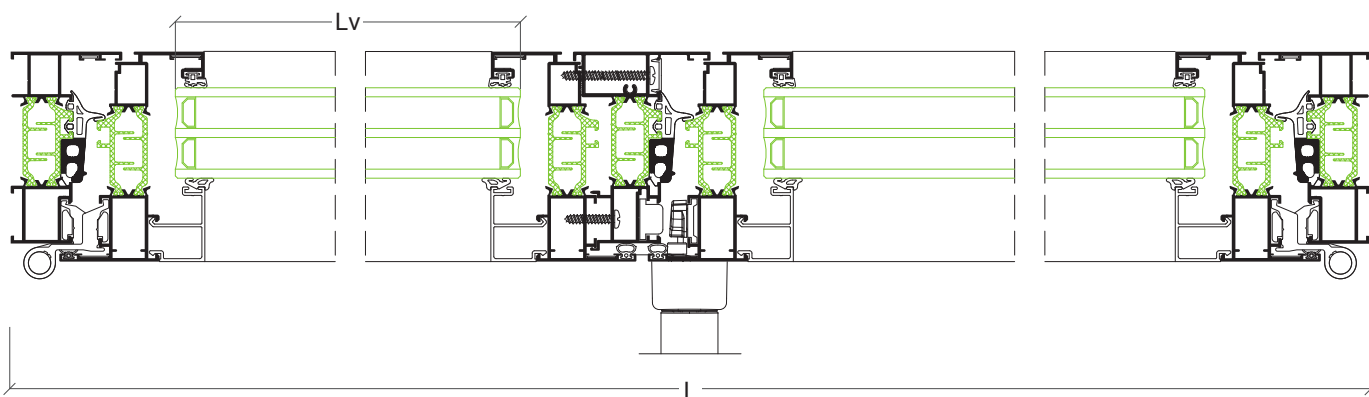

Janela projectante

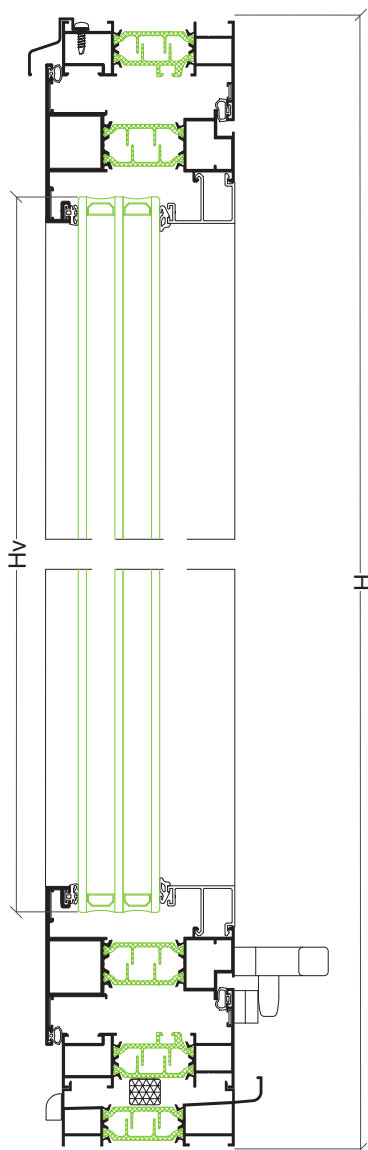
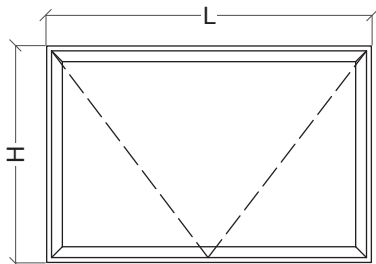

Perfis

Desenho	Ref	Descrição	Corte	Quant	Medida
	API-03	Aro fixo		2	L
				2	H-28.5 mm
	API-95	Aro móvel		2	L-43 mm
				2	H-71.5 mm
	---	Bite		2	L-159.5 mm
				2	H-228 mm
	API-71	Soleira		1	L
	AXi-45	Pingadeira		1	L
	AXi-32	Complemento		1	segundo medida do compasso

Acessórios e Juntas

Referência	Descrição	Quantidade
30 96 00 04	Esquadro interior	4
30 60 00 01	Esquadro exterior	4
30 96 00 23	Esquadro alinhamento fixo	4
30 92 01 35	Esquadro alinhamento móvel	8
30 96 00 06	Esquadro interior	4
30 96 00 07	Esquadro exterior	4
30 96 10 01	Calço para vidro	4
30 96 06 10 ou 11	Cremona de lingueta	2
---	Jogo compasso projectante	1
30 92 01 02	Goteira com válvula preto	2 ou mais
30 96 00 12	Jogo topos condensação	1
30 92 04 70	Espuma isolante	L
30 93 01 20	Junta exterior	2L+2H
30 96 00 18	Junta interior projectante deslizante	2L+2H
---	Junta para vidro (exterior)	2L+2H
---	Junta para vidro (interior)	2L+2H

175

Vidro



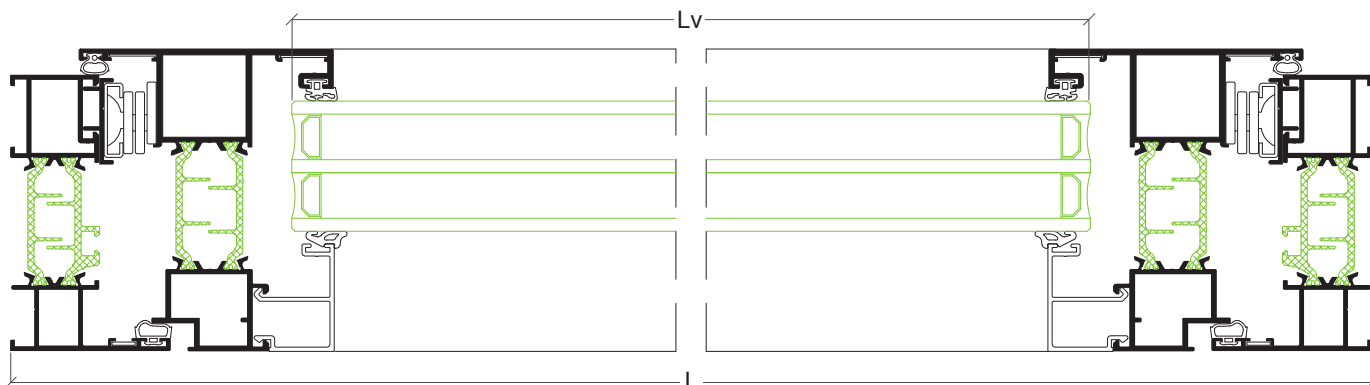



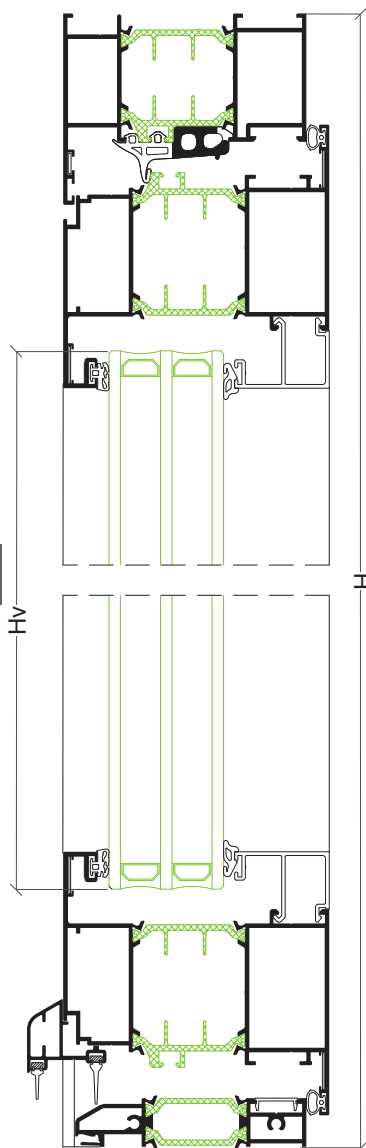
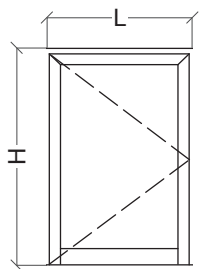



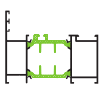

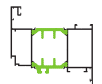

Hv = H-202 mm	Lv = L-173 mm
---------------	---------------



Porta 1 folha



Perfis

Desenho	Ref	Descrição	Corte	Quant	Medida
	API-08	Aro fixo		1	L
				2	H
	API-36	Aro móvel		2	L-78 mm
				2	H-50 mm
	---	Bite		2	L-222 mm
				2	H-234 mm
	API-63	Remate inferior porta		1	L-80.5 mm
	AZ-79	Pingadeira		1	L-135 mm
	KL-04	Perfil tampa		1	L-90 mm

Acessórios e Juntas

Referência	Descrição	Quantidade
30 96 00 05	Esquadro interior	2
30 60 00 02	Esquadro exterior	2
30 60 00 05	Esquadro interior móvel	4
30 60 00 04	Esquadro exterior móvel	4
30 96 00 23	Esquadro alinhamento fixo	2
30 96 00 22	Esquadro alinhamento móvel	8
30 96 10 01	Calço para vidro	4
30 92 22 88 ou 89	Dobradiça 2 abas porta	2
30 92 05 10	Fechadura 3 pontos	1
30 92 13 00 ou 01	Puxador duplo	1
30 92 13 02	Perno	1
30 92 22 85 ou 86	Escudo para canhão	1
30 92 13 03	Canhão	1
30 93 01 20	Junta interior	2L+2H
30 96 10 06	Junta central	L+2H
30 96 10 07	Canto vulcanizado	2
30 92 05 00	Conjunto topos pingadeira	1
30 00 95 15	Junta inferior curta	L
30 93 00 82	Junta inferior	L
---	Junta para vidro (exterior)	2L+2H
---	Junta para vidro (interior)	2L+2H

Vidro

Hv = H-208 mm	Lv = L-236 mm
---------------	---------------

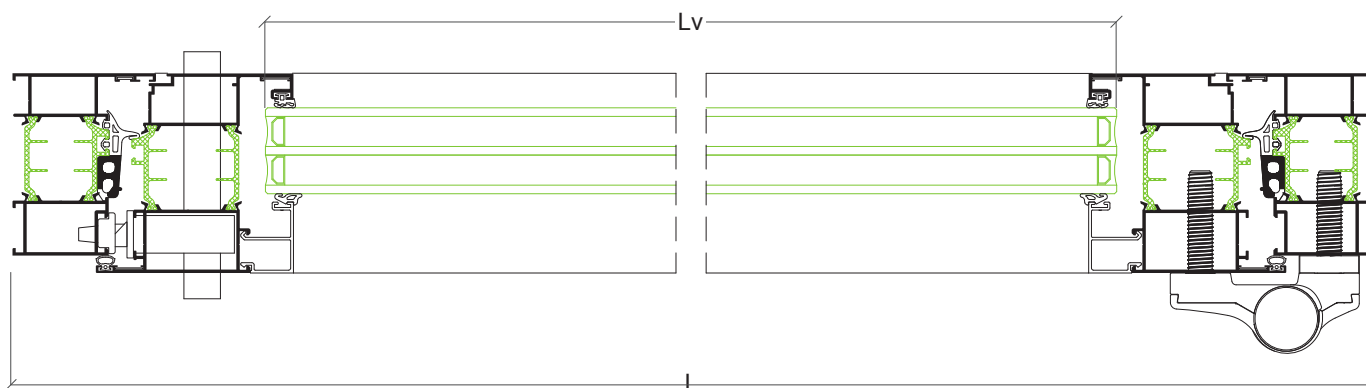

Porta 2 folhas

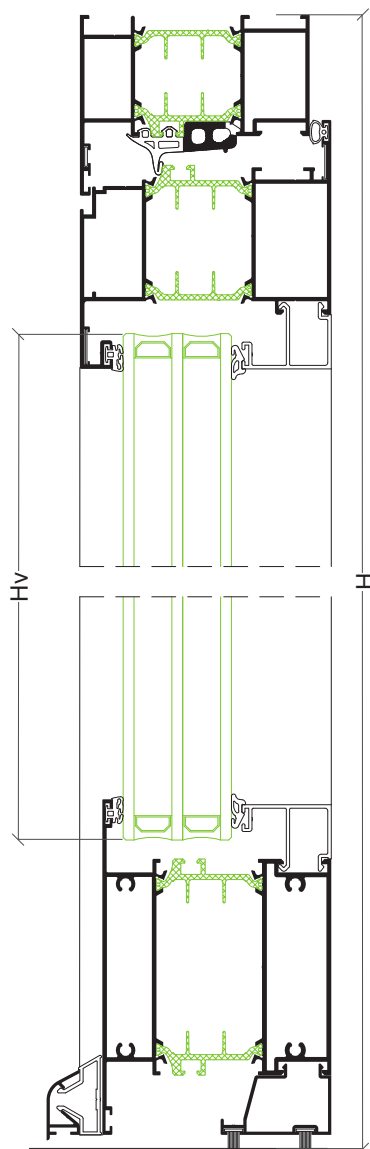
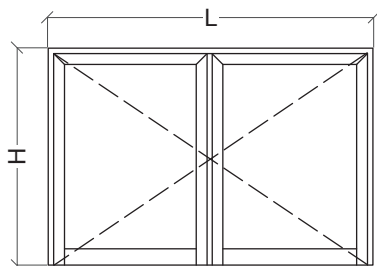

Perfis

Desenho	Ref	Descrição	Corte	Quant	Medida
	APi-08	Aro fixo		1	L
				2	H
	APi-36	Aro móvel		2	L/2-41.5 mm
				4	H-44 mm
	---	Bite		4	L/2-185.5 mm
				4	H-258 mm
	APi-04	Inversor		1	H-78 mm
	KL-04	Perfil tampa		1	H-78 mm
	APi-12	Travessa		2	L/2-176.5 mm
	AJi-82	Bite remate		2	L/2-185.5 mm
	AZ-60	Pingadeira		1	L/2-103 mm
				1	L/2-39 mm
	AZ-61	Suplemento pingadeira		2	L/2-226 mm

Acessórios e Juntas

Referência	Descrição	Quantidade
30 96 00 05	Esquadro interior	2
30 60 00 02	Esquadro exterior	2
30 60 00 05	Esquadro interior móvel	4
30 60 00 04	Esquadro exterior móvel	4
30 96 00 23	Esquadro alinhamento fixo	2
30 96 00 22	Esquadro alinhamento móvel	8
30 70 00 12	Conjunto topos inversor	1
30 92 22 88 ou 89	Dobradiça 2 abas porta	4
30 92 05 10	Fechadura 3 pontos	1
30 92 13 00 ou 01	Puxador duplo	1
30 92 13 02	Perno	1
30 92 22 85 ou 86	Escudo para canhão	1
30 92 13 03	Canhão	1
30 92 00 50	Contra-fecho	1
30 24 30 75	Contra-fecho inferior	1
30 92 01 20	Jogo fecho C.E.	1
30 93 01 20	Junta interior	L+4H
30 96 10 06	Junta central	L+3H
30 96 10 07	Canto vulcanizado	2
30 92 05 00	Conjunto topos pingadeira	1
30 95 00 10	Pelúcia	2L
---	Junta para vidro (exterior)	2L+4H
---	Junta para vidro (interior)	2L+4H

177

Vidro

Hv = H-232 mm	Lv = L/2-200 mm
---------------	-----------------

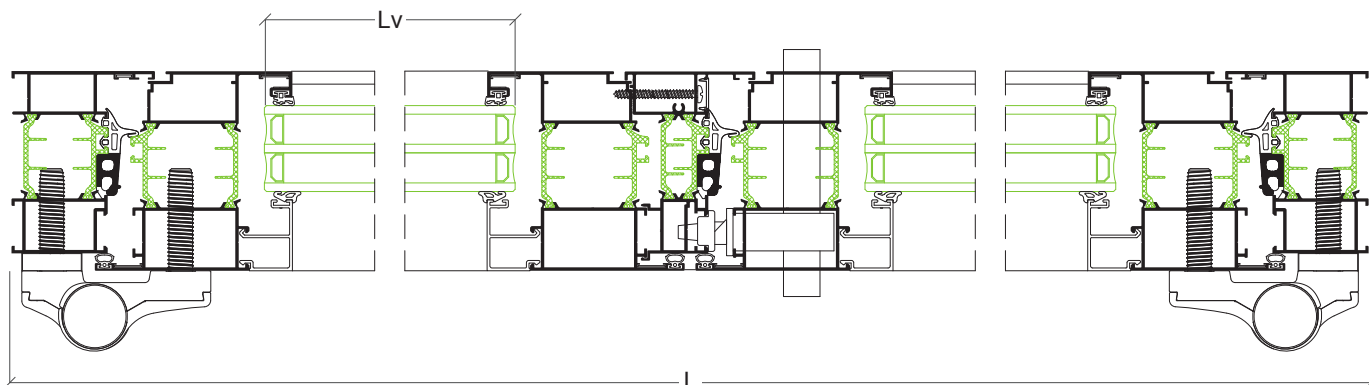

Porta 1 folha abertura exterior

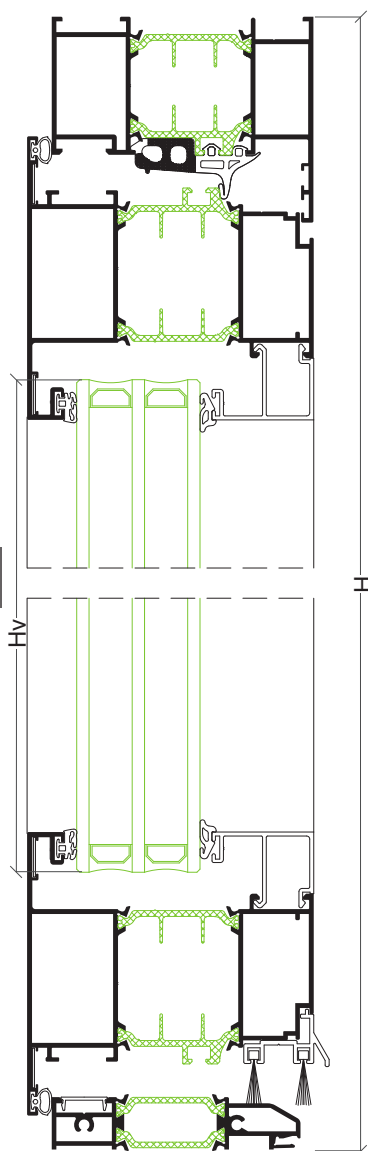
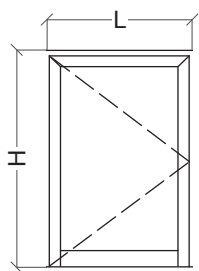

Perfis

Desenho	Ref	Descrição	Corte	Quant	Medida
	API-08	Aro fixo		1	L
				2	H
	API-72	Aro móvel		2	L-78 mm
				2	H-50 mm
	---	Bite		2	L-222 mm
				2	H-234 mm
	API-63	Remate inferior porta		1	L-80.5 mm
	AJi-62	Pingadeira		1	---
	KL-04	Perfil tampa		1	L-90 mm

Acessórios e Juntas

Referência	Descrição	Quantidade
30 96 00 05	Esquadro interior	2
30 60 00 02	Esquadro exterior	2
30 60 00 05	Esquadro interior móvel	4
30 60 00 04	Esquadro exterior móvel	4
30 96 00 23	Esquadro alinhamento fixo	2
30 96 00 22	Esquadro alinhamento móvel	8
30 96 10 01	Calço para vidro	4
30 92 22 88 ou 89	Dobradiça 2 abas porta	2
30 92 05 10	Fechadura 3 pontos	1
30 92 13 00 ou 01	Puxador duplo	1
30 92 13 02	Perno	1
30 92 22 85 ou 86	Escudo para canhão	1
30 92 13 03	Canhão	1
30 93 01 20	Junta interior	2L+2H
30 96 10 06	Junta central	L+2H
30 96 10 07	Canto vulcanizado	2
30 60 00 13	Conjunto topos AJi-62	1
30 60 00 14	Pelúcia preta 18 mm	2L
---	Junta para vidro (exterior)	2L+2H
---	Junta para vidro (interior)	2L+2H

Vidro

Hv = H-208 mm	Lv = L-236 mm
---------------	---------------

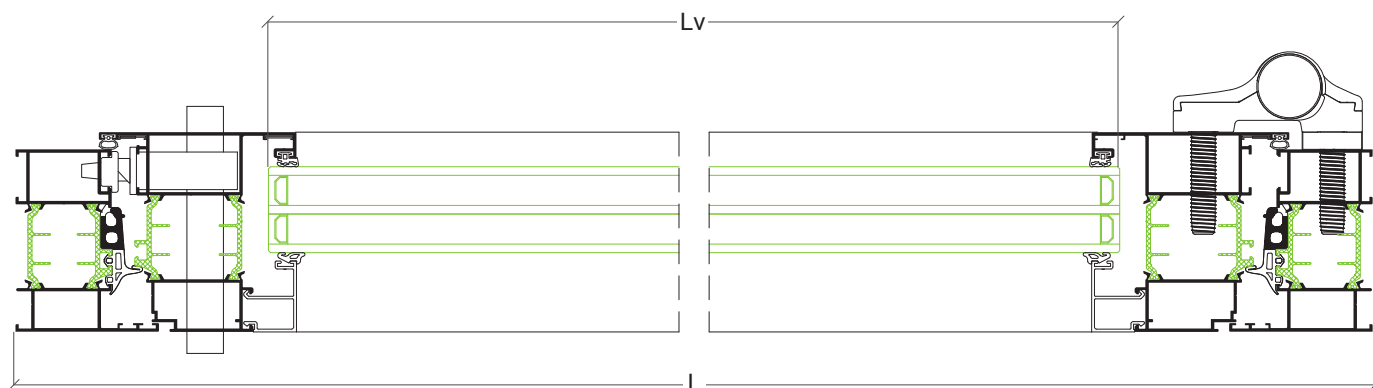

Ferragens para oscilo-batente

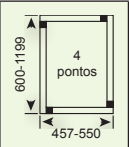
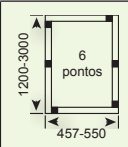
Designação	Referência		
Kit oscilo-batente	30 92 12 60 (branco) 30 92 12 61 (preto)	1	
Cremone OB	30 92 12 64 ou 65 ou 30 92 12 66 ou 67	1	
Compasso pequeno	30 92 12 72	1	
Kit fecho 3º ponto	30 92 12 75		1

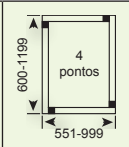
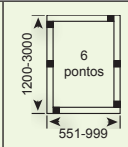
Designação	Referência		
Kit oscilo-batente	30 92 12 60 (branco) 30 92 12 61 (preto)	1	
Cremone OB	30 92 12 64 ou 65 ou 30 92 12 66 ou 67	1	
Compasso grande	30 92 12 73	1	
Kit fecho 3º ponto	30 92 12 75		1

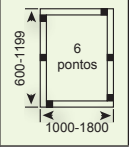
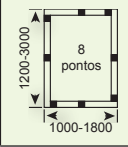
Designação	Referência		
Kit oscilo-batente	30 92 12 60 (branco) 30 92 12 61 (preto)	1	
Cremone OB	30 92 12 64 ou 65 ou 30 92 12 66 ou 67	1	
Compasso grande	30 92 12 73	1	
Compasso suplementar	30 92 12 74	1	
Kit fecho 3º ponto	30 92 12 75	1	2

Ferragens para a 2ª folha

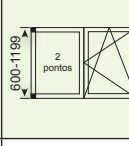
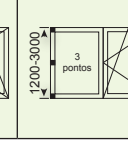
Designação	Referência		
Kit dobradiça 2ª folha	30 92 12 77 (branco) 30 92 12 78 (preto)	1	
Kit fechos para 2ª folha	30 92 12 79	1	
Conjunto ponto fecho suplementar	30 92 12 80		1

Peso máximo da folha: 130 kg (alumínio + vidro)

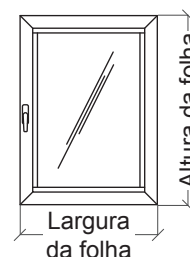
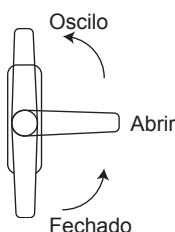

(confirmar com o quadro de dimensão/aplicação do mapa de montagem da ferragem O-B)

Largura mínima: 457 mm / Largura máxima: 1800 mm
 Altura mínima: 600 mm / Altura máxima: 3000 mm

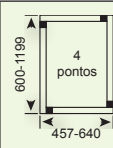
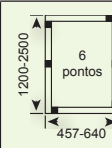

Ferragens para oscilo-batente oculta

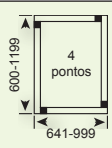
Designação	Referência		
Kit oscilo-batente com compasso pequeno (até 130 kg)	30 92 12 81 (direito) 30 92 12 82 (esquerdo)	1	
Cremone OB	30 92 12 64 ou 65 ou 30 92 12 66 ou 67	1	
Suplemento (131 - 170 kg)	30 92 12 85	1	
Kit fecho 3º ponto vertical	30 92 12 93		1

Designação	Referência		
Kit oscilo-batente com compasso grande (até 130 kg)	30 92 12 83 (direito) 30 92 12 84 (esquerdo)	1	
Cremone OB	30 92 12 64 ou 65 ou 30 92 12 66 ou 67	1	
Suplemento (131 - 170 kg)	30 92 12 85	1	
Kit fecho 3º ponto vertical	30 92 12 93		1

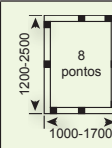
Designação	Referência		
Kit oscilo-batente com compasso grande (até 130 kg)	30 92 12 83 (direito) 30 92 12 84 (esquerdo)	1	
Cremone OB	30 92 12 64 ou 65 ou 30 92 12 66 ou 67	1	
Suplemento (131 - 170 kg)	30 92 12 85	1	
Compasso suplementar	30 92 12 74	1	
Kit fecho 3º ponto horizontal	30 92 12 75	1	
Kit fecho 3º ponto vertical	30 92 12 93		1

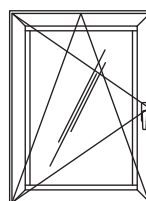

abertura esquerda

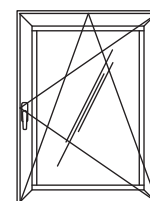

abertura direita

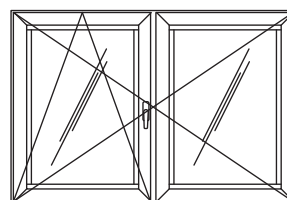

abertura esquerda

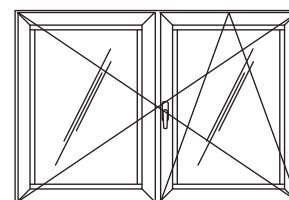

abertura direita

Ferragens para a 2ª folha

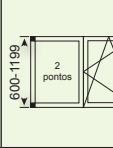
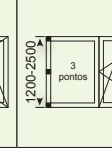
Designação	Referência		
Kit dobradiça 2ª folha (até 130 kg)	30 92 12 86 (direito) 30 92 12 87 (esquerdo)	1	
Kit fechos para 2ª folha	30 92 12 79	1	
Conjunto ponto fecho suplementar	30 92 12 80		1
Suplemento (131-170 kg)	30 92 12 85	1	

Peso máximo da folha: 170 kg (alumínio + vidro)

(confirmar com o quadro de dimensão/aplicação do mapa de montagem da ferragem O-B)

Largura mínima: 457 mm / Largura máxima: 1700 mm

Altura mínima: 600 mm / Altura máxima: 2500 mm

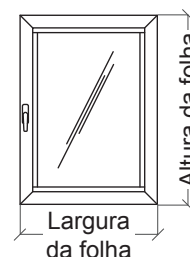
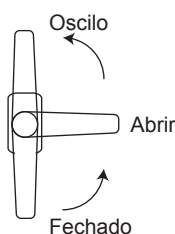

As medidas indicadas reportam-se às dimensões da folha móvel do vão

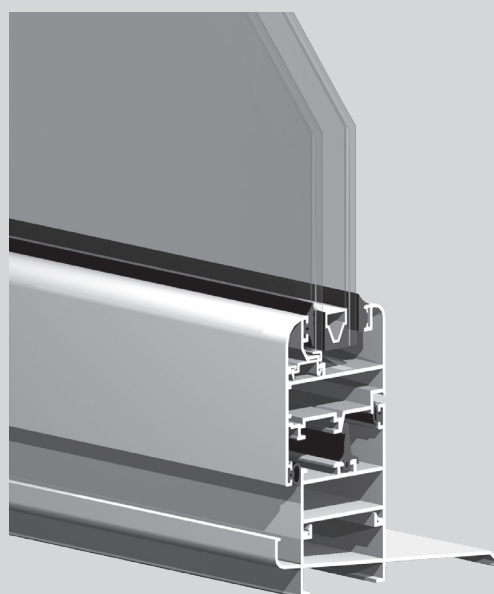

Sistema

AX

Sistema AX

Sistema de batente de câmara europeia - 45 mm

Características do sistema

Sistema de batente com câmara europeia e tripla vedação em EPDM (exterior, central, interior).

O sistema AX possibilita a execução de 2 versões de caixilharia:

1. linha recta;
2. linha curva.

Perfis de alumínio

Os perfis de alumínio são extrudidos na liga de alumínio 6060 para arquitectura de acordo com norma NP EN 12020-02.

Espessura média dos perfis de alumínio de 1.5 mm para janelas e de 1.7 mm para portas.

Aros fixos

Secção dos aros fixos de 45 mm;

Aros fixos com esquadro para montagem a meia esquadria.

Aros móveis

Secção dos aros móveis de 53 mm;

Enchimento para vidro simples ou duplo desde 4 mm até 30 mm;

Aros móveis de linha recta ou curva;

Aro móvel com esquadro para montagem a meia esquadria;

Perfil inversor recto.

Dimensionamento e manobralidade

Dimensões mínimas - máximas de folha: 375 mm - 1700 mm (L); 410 mm - 2700 mm (H);

Peso máximo de 110 kg por folha com oscilo-batente;

Peso máximo de 90 kg por folha para janelas de abrir;

Peso máximo de 150 kg por folha com dobradiça porta;

Possibilidades de abertura: interior com ou sem oscilo-batente,

exterior, basculante, projectante, pivotante, harmónio e oscilo-paralela;

Estanquidade assegurada através de juntas triplas em EPDM.

Performances

Sistema certificado por laboratório notificado para Ensaios Tipo Inicial (ITT) de acordo com a norma de produto EN 14351-1 para efeitos de Marcação CE.

Categorias alcançadas na avaliação do sistema AX tipologia janela:

1. Permeabilidade ao ar: Classe 4 (norma de ensaio EN 1026)
2. Estanquidade à água: Classe E900 (norma de ensaio EN 1027)
3. Resistência ao vento: Classe C5 (norma de ensaio EN 12211)

Categorias alcançadas na avaliação do sistema AX tipologia porta:

1. Permeabilidade ao ar: Classe 4 (norma de ensaio EN 1026)
2. Estanquidade à água: Classe 7A (norma de ensaio EN 1027)
3. Resistência ao vento: Classe C2 (norma de ensaio EN 12211)
4. Resistência à torção estática: Apto 350N (norma de ensaio EN 14609)

Coefficiente de transmissão térmica de vão de 2 folhas com 1.20 m x 1.50 m com vidro Ug = 1.4 W/m²K:

• Uw = 2.92 W/m²K

Coefficiente de atenuação acústica de vão de 2 folhas com vidro 4/12/4:

• Rw (C; Ctr) = 33 dB (-1; -4)

Zonas de aplicação segundo RCCTE (em função do valor Ug): I1, I2, I3, V1, V2, V3.

Sistema AX Milénio

Sistema portas de entrada uso intensivo - 45 mm

Características do sistema

Sistema de batente com dupla vedação em EPDM (exterior, interior).

O sistema AX Milénio possibilita a execução de caixilharia em linha recta com aro fixo e aro móvel faceados.

Perfis de alumínio

Os perfis de alumínio são extrudidos na liga de alumínio 6060 para arquitectura de acordo com norma NP EN 12020-02.

Espessura média dos perfis de alumínio de 2.0 mm.

Aros fixos

Secção dos aros fixos de 45 mm;

Aros fixos com esquadro para montagem a meia esquadria.

Aros móveis

Secção dos aros móveis de 45 mm;

Enchimento para vidro simples ou duplo desde 4 mm até 30 mm;

Aros móveis com esquadro para montagem a meia esquadria.

Dimensionamento e manobralidade

Dimensões mínimas - máximas de folha: 400 mm - 1500 mm (L); 600 mm - 3000mm (H);

Peso máximo de 180 Kg por folha com dobradiça reforçada;

Possibilidades de abertura: interior, exterior e vaivém, com opção de sistema anti-entallamento de dedos.

Performances

Sistema certificado por laboratório notificado para Ensaios Tipo Inicial (ITT) de acordo com a norma de produto EN 14351-1 para efeitos de Marcação CE.

Categorias alcançadas na avaliação do sistema AX Milénio tipologia porta de 2 folhas:

1. Permeabilidade ao ar: Classe 2 (norma de ensaio EN 1026)
2. Estanquidade à água: NPD (norma de ensaio EN 1027)
3. Resistência ao vento: Classe C3 (norma de ensaio EN 12211)
4. Resistência ao impacto: Classe 5 (norma de ensaio EN 13049)

Coefficiente de transmissão térmica de vão de 2 folhas com 1.80 m x 2.20 m com vidro Ug = 1.4 W/m²K:

• Uw = 3.12 W/m²K

Coefficiente de atenuação acústica de vão de 2 folhas com vidro laminado:

• Rw (C; Ctr) = 37 dB (-1; -4)

Zonas de aplicação segundo RCCTE (em função do valor Ug): I1, I2, I3, V1, V2, V3.

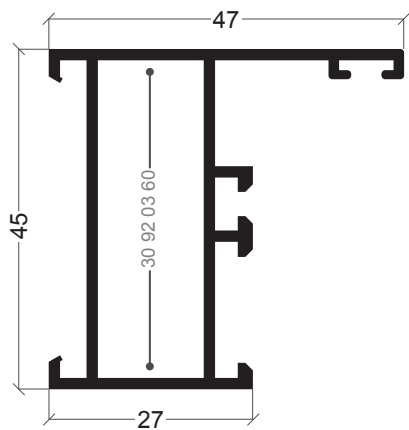

AX-03
Aro fixo

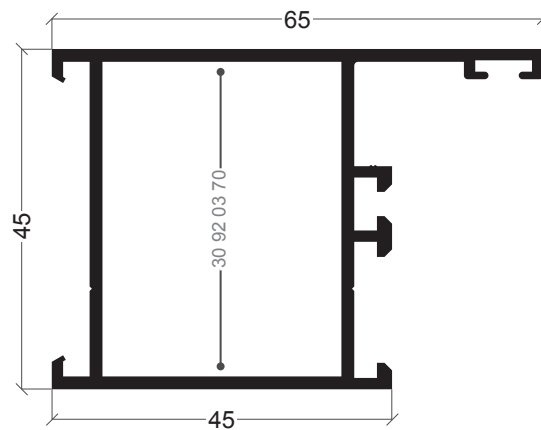

AX-08
Aro fixo

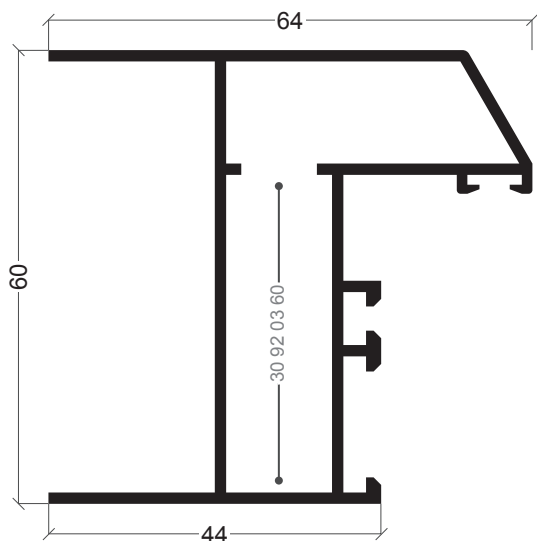

AX-14
Aro fixo 60 mm

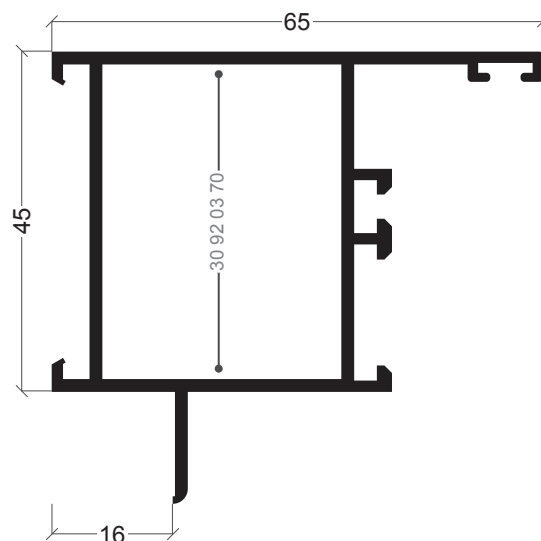

AX-38
Aro fixo para apanelado

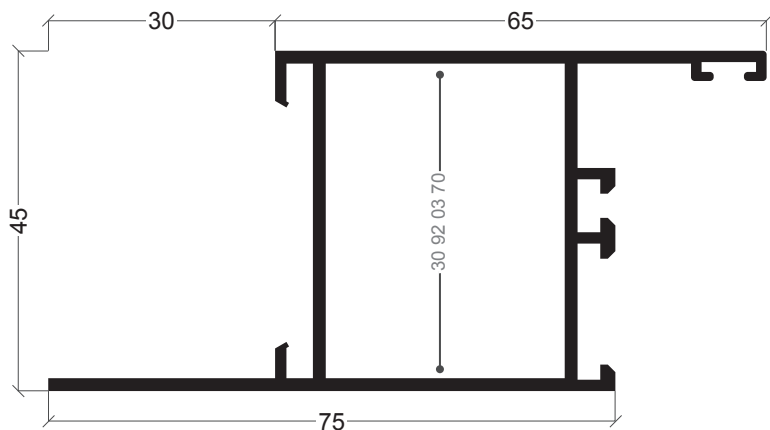

AX-41
Aro fixo com remate

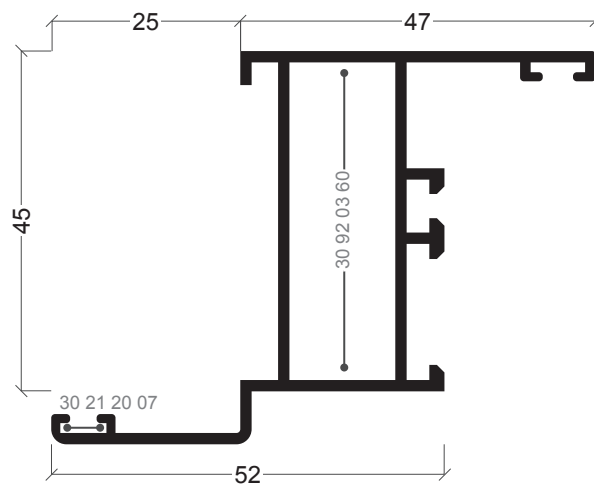

AX-26
Aro fixo com remate

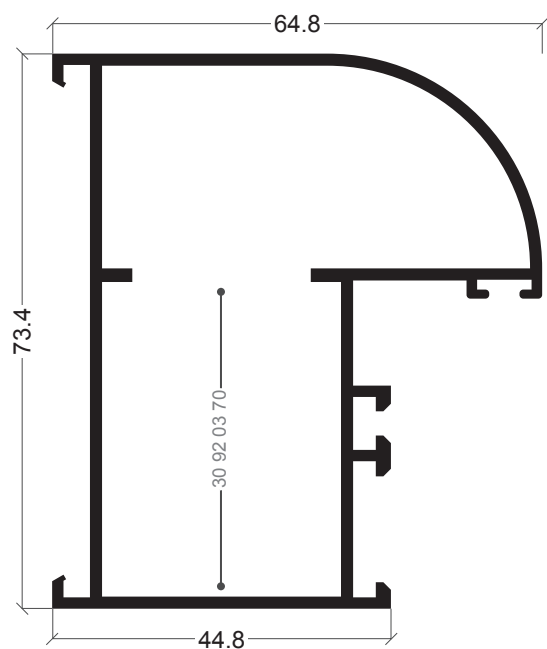

AX-52
Aro fixo com reforço

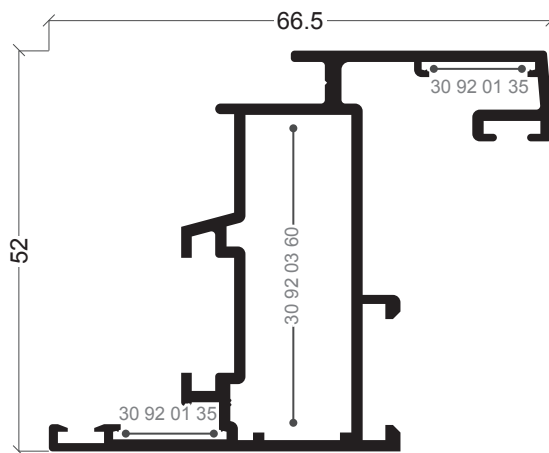

AX-02
Aro móvel

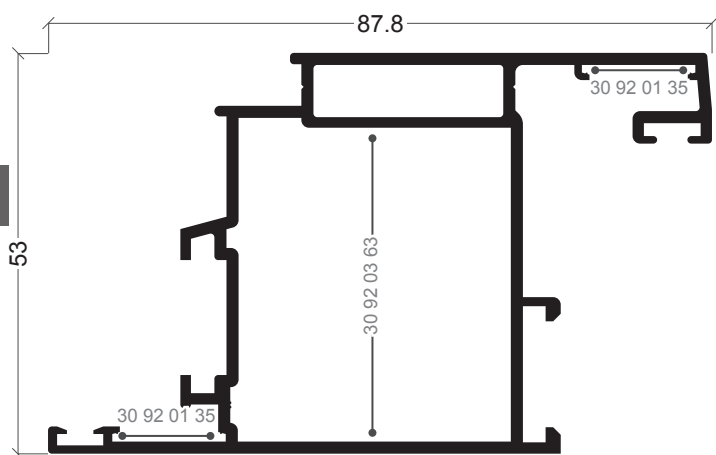

AX-07
Aro móvel

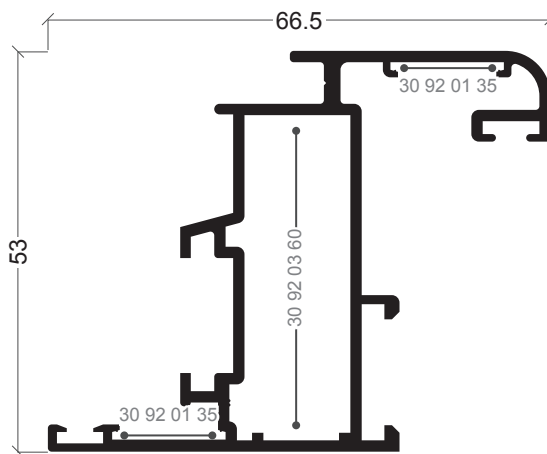

AX-05
Aro móvel

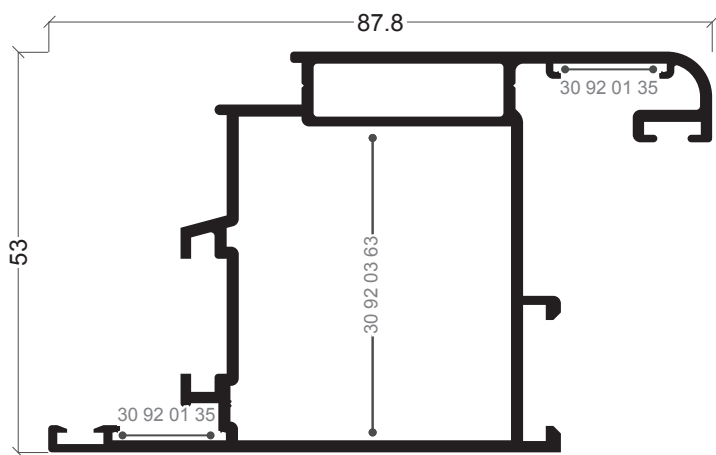

AX-10
Aro móvel

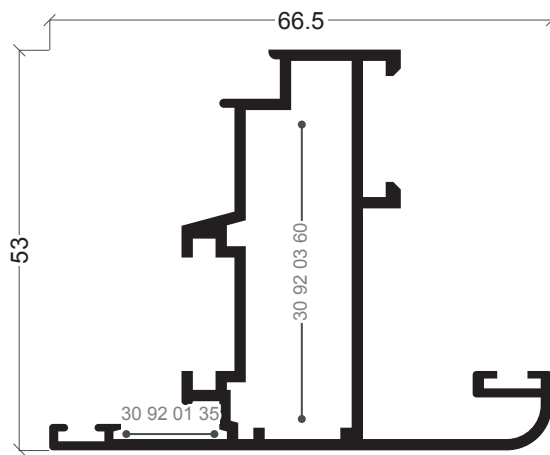

AX-04
Aro móvel

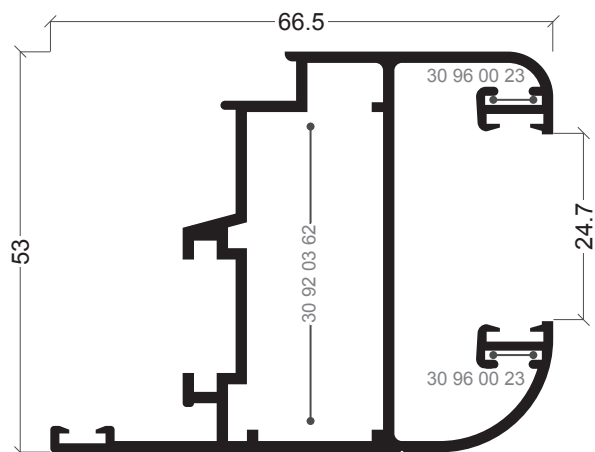

AX-53
Aro móvel

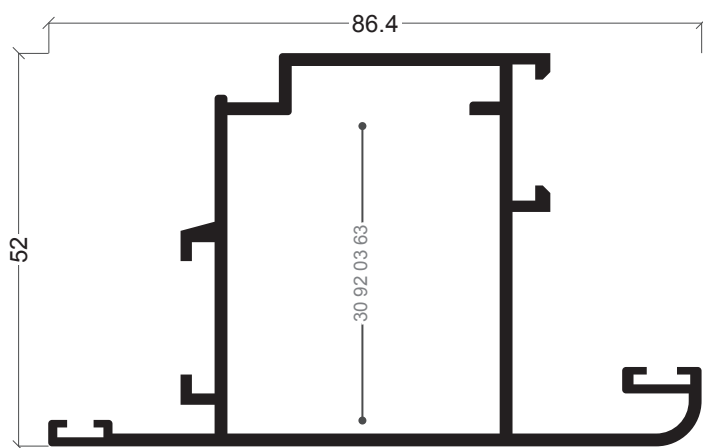

AX-09
Aro móvel abertura exterior

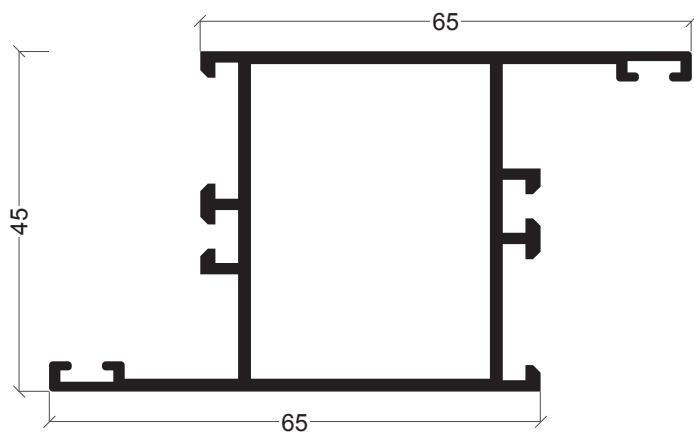

AX-47
Aro abertura exterior com fixo

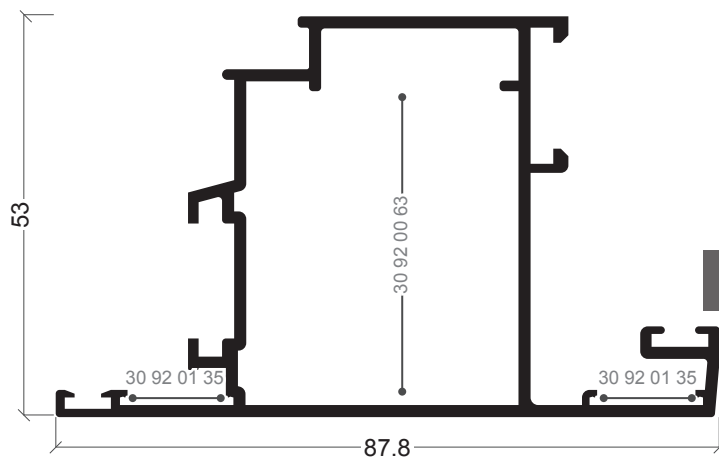

AX-06
Aro móvel abertura exterior

185

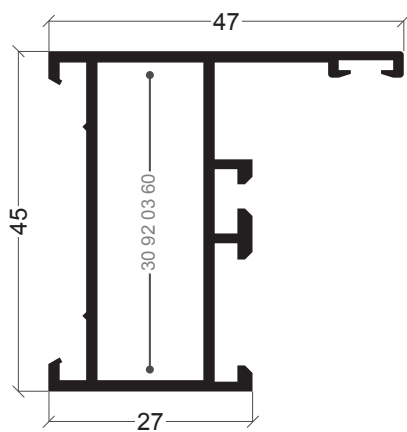

AX-51
Aro fixo pivotante

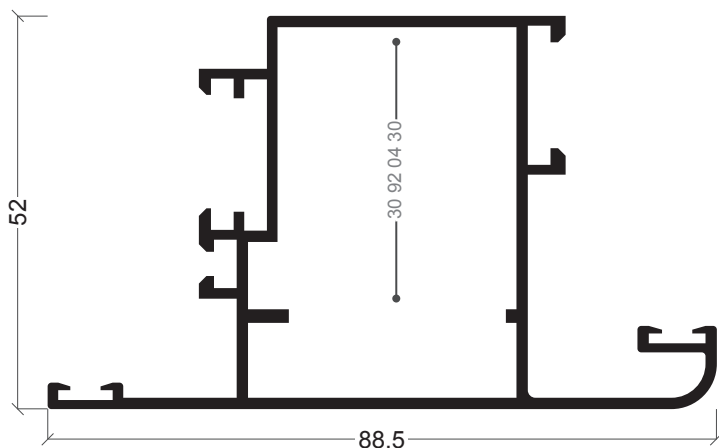

AX-54
Aro móvel pivotante

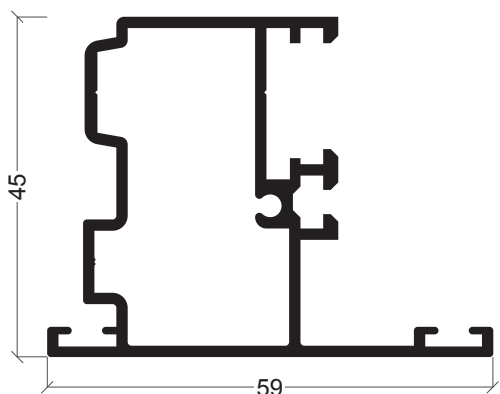

AX-11
Inversor

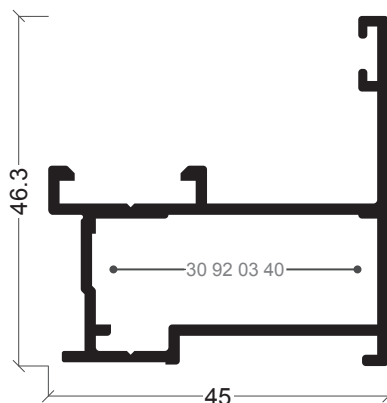

AX-79
Inversor sentido de abertura

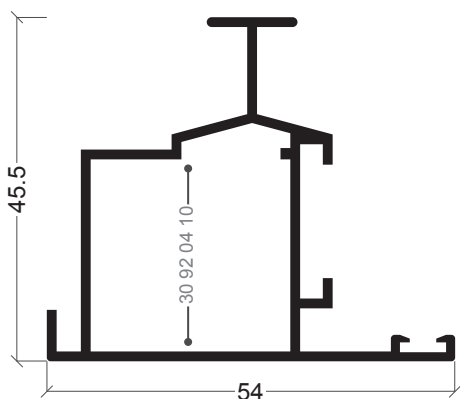

AX-55
Inversor pivotante

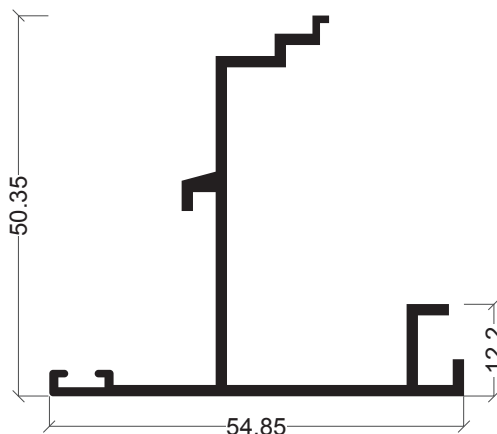

AX-21
Inversor clip

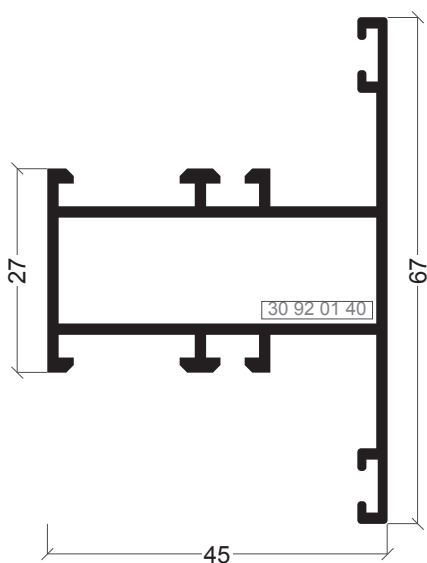

AX-01
Travessa

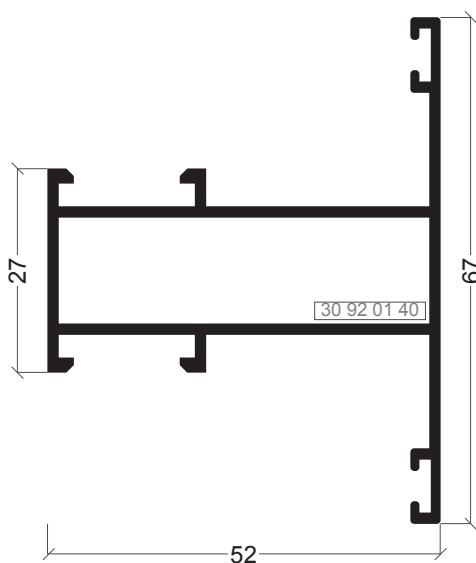

AX-27
Travessa

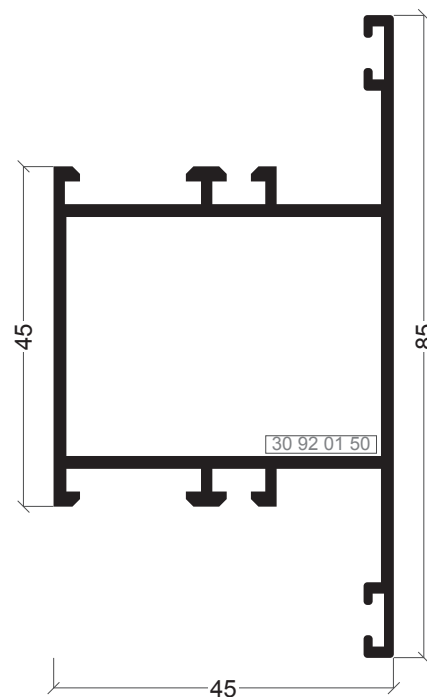

AX-28
Travessa

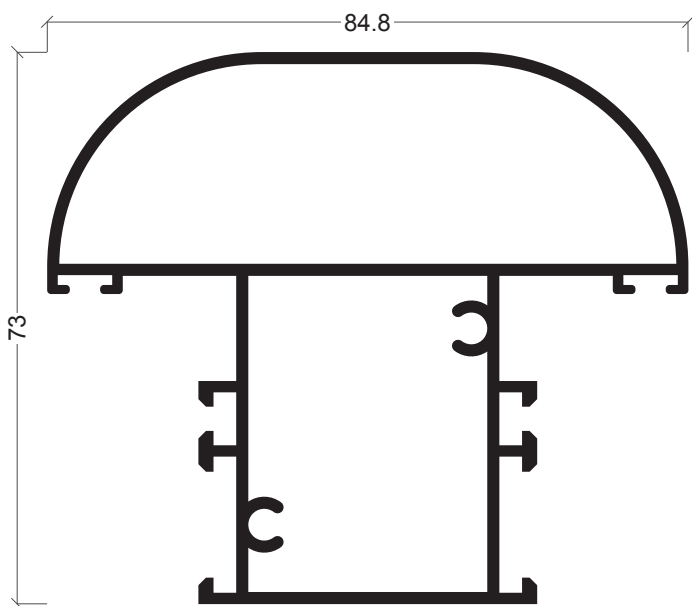

AX-56
Travessa com reforço

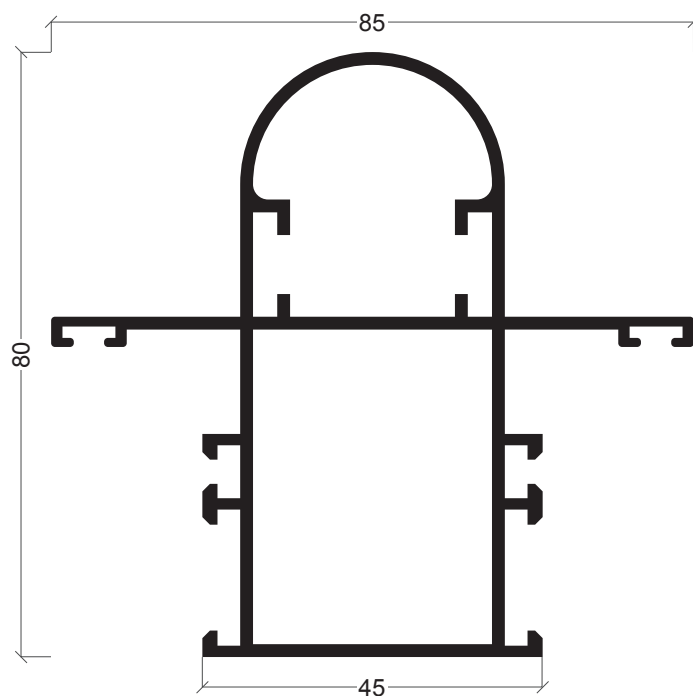

AX-24
Montante

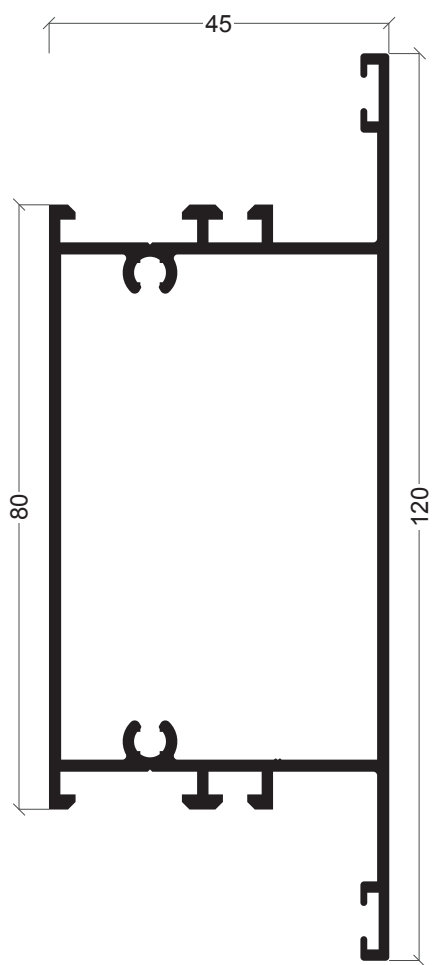

AX-12
Travessa

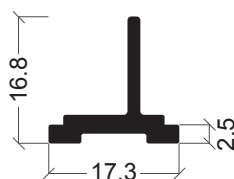

AX-48
Complemento batente

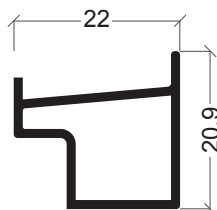

AX-45
Adaptador condensação

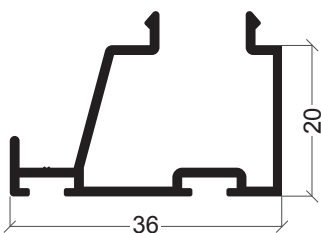

AX-15
Bite remate

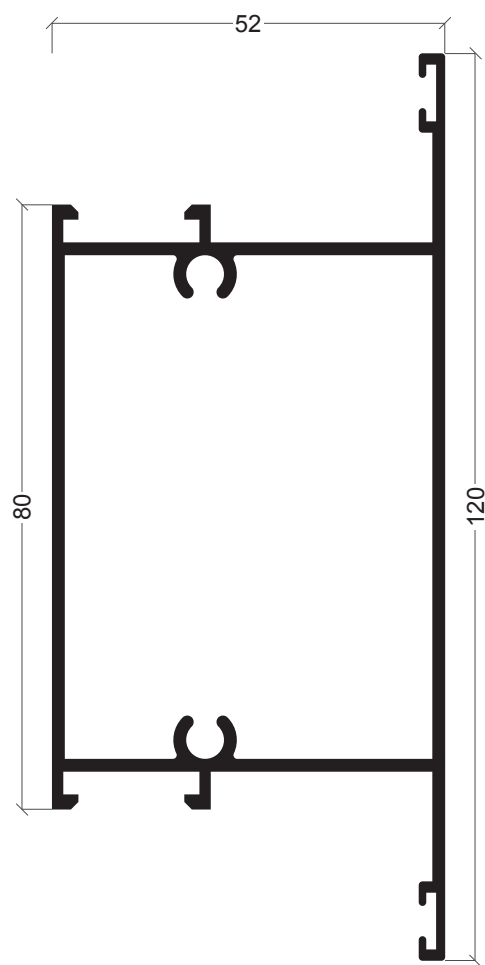

AX-13
Travessa 52 mm

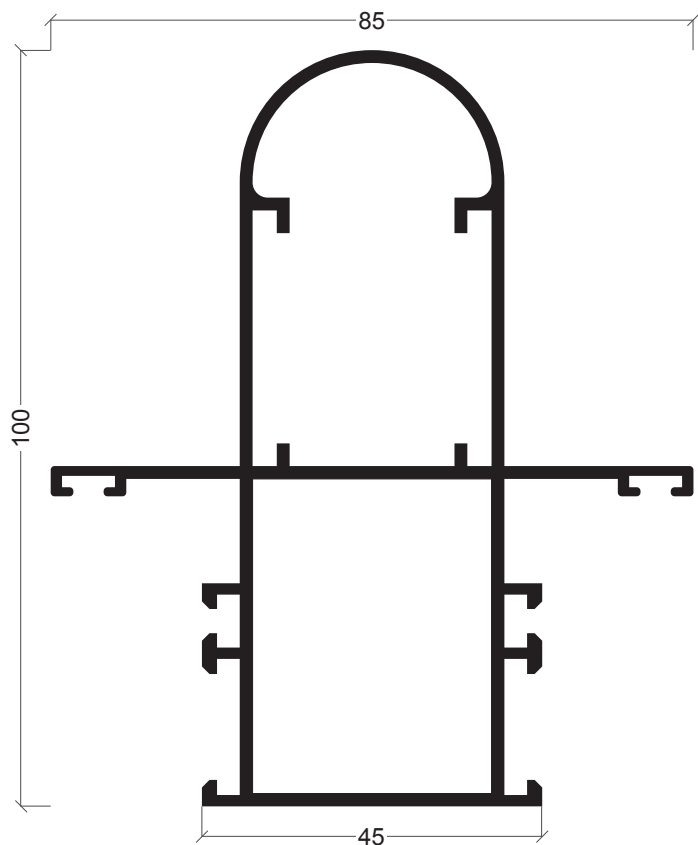

AX-25
Montante

AX-23
União de aros para ângulos

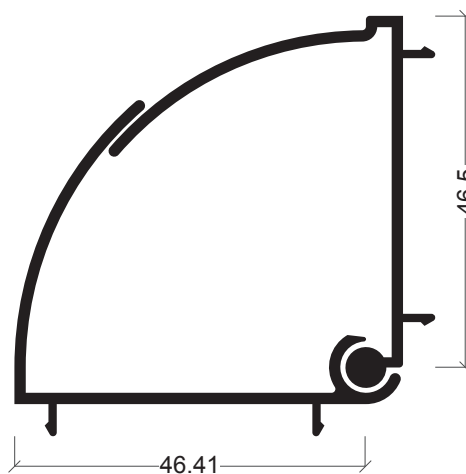

AX-22
União de aros para ângulos

188

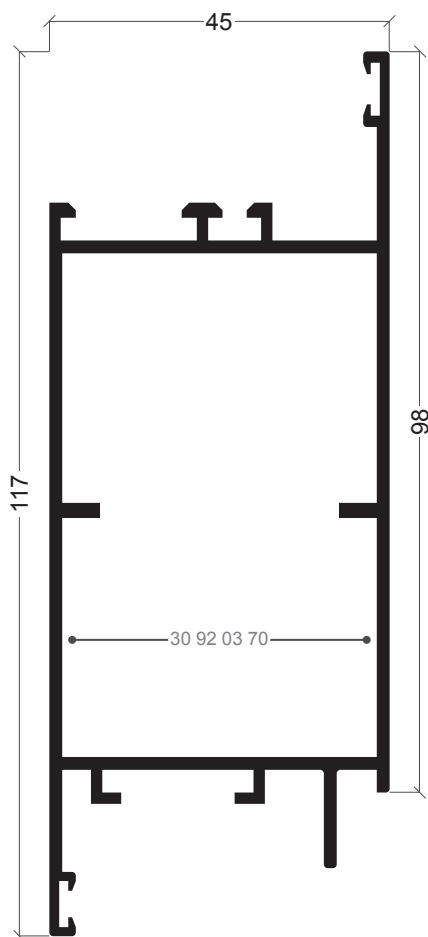

AX-49
Aro móvel

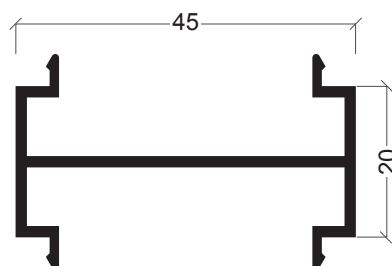

AX-20
União de aros

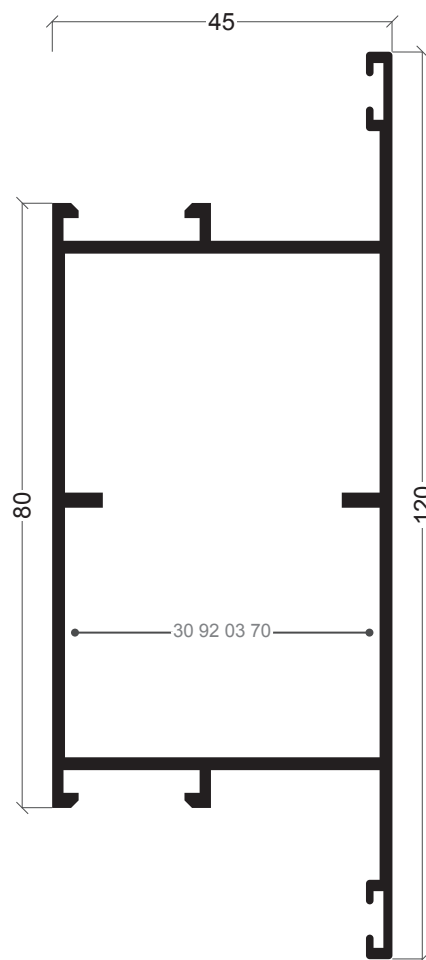

AX-50
Travessa

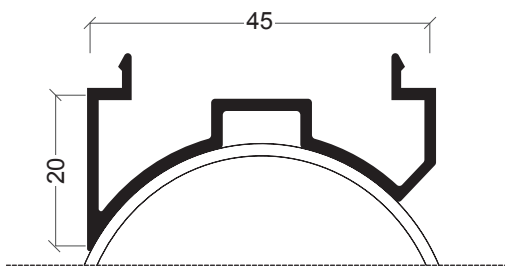

CP-16
Ângulo com tubo 50 mm

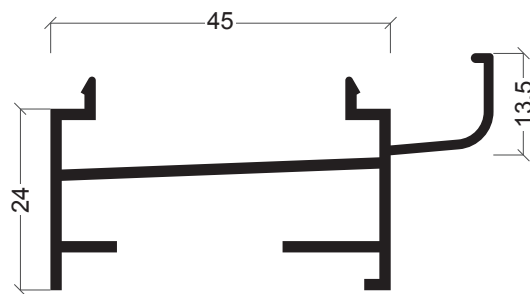

AX-58
Soleira condensação

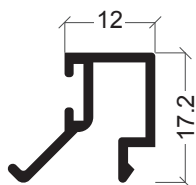

AX-70
Bite para AX-57

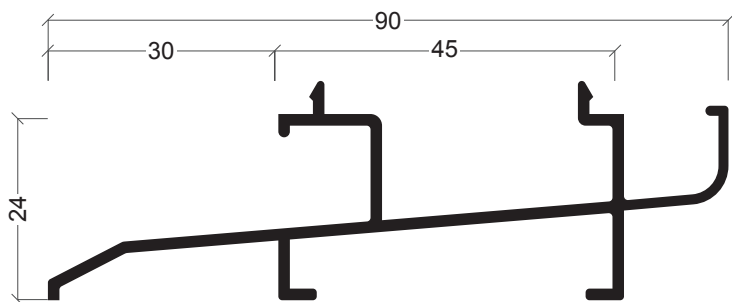

AX-17
Soleira condensação

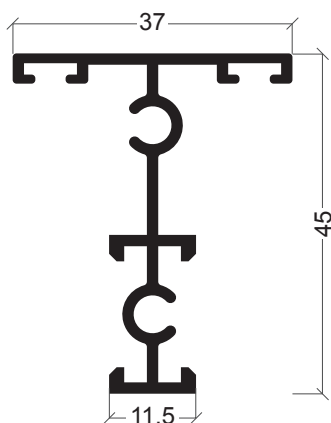

AX-57
Divisor de vidro

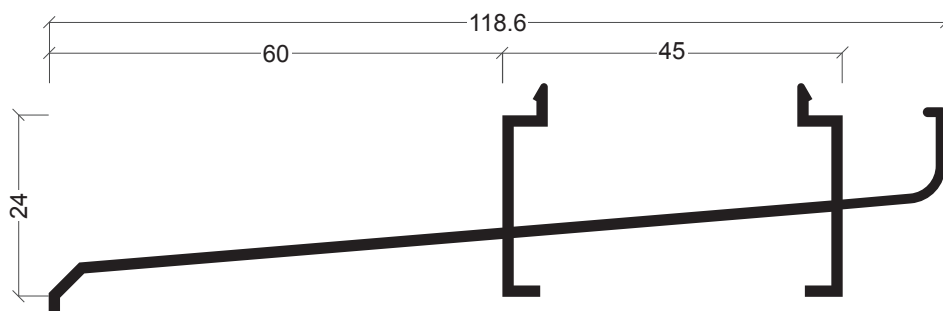

AX-18
Soleira condensação

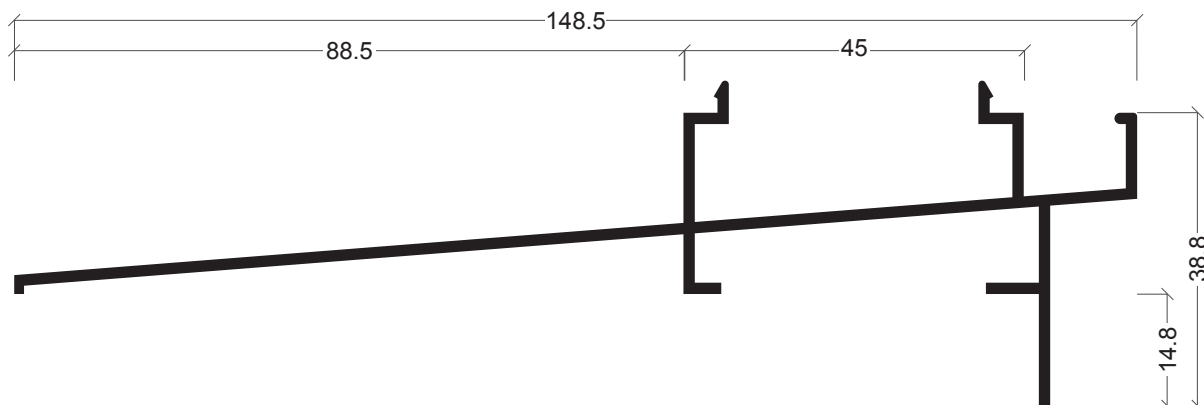

AX-43
Soleira condensação

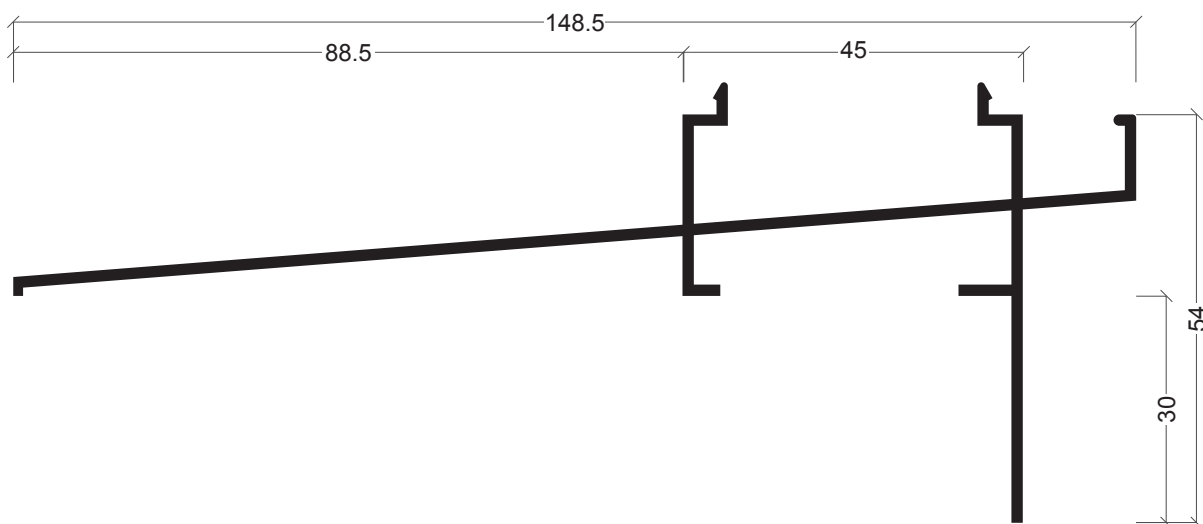

AX-44
Soleira condensação

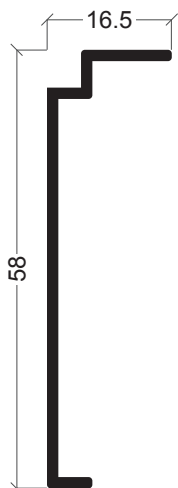

AX-59
Tapa juntas

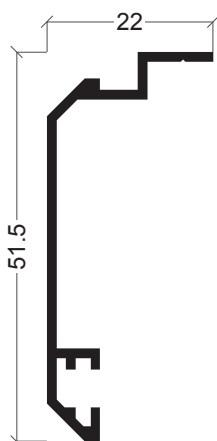

AX-40
Tapa juntas

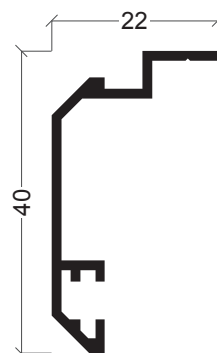

AX-16
Tapa juntas

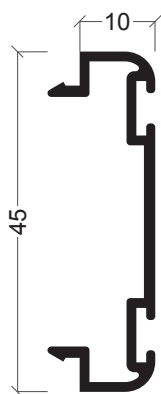

AX-42
Complemento vaivém



AX-19
Vareta

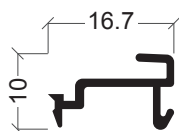

AX-33
Mola Bite

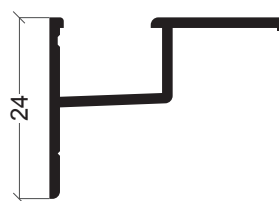

Y-20
Recolha de águas condensação

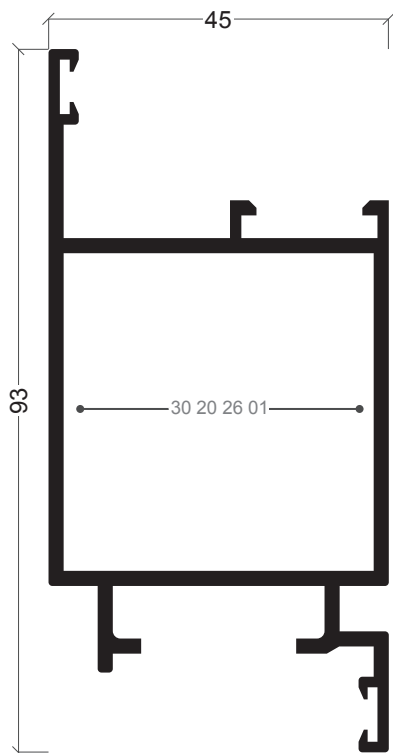

AX-65
Aro móvel

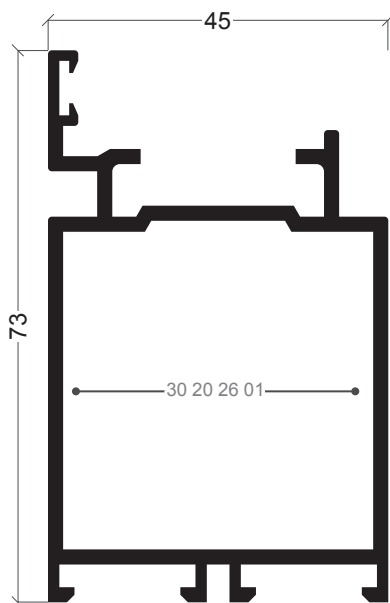

AX-64
Aro fixo

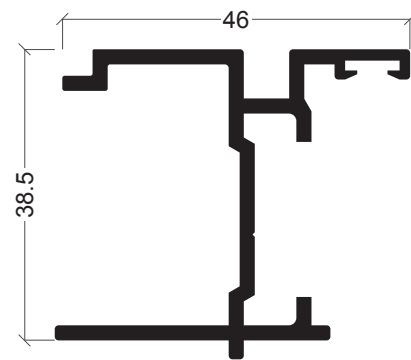

AX-62
Suplemento abertura exterior

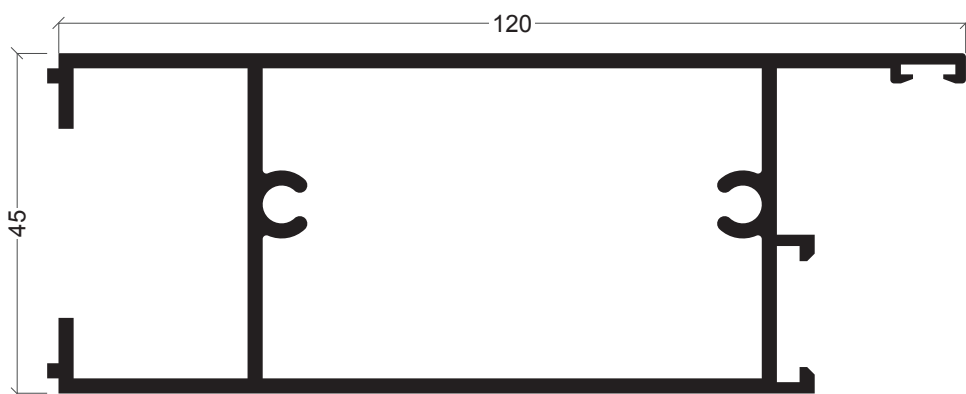

AX-68
Almofada

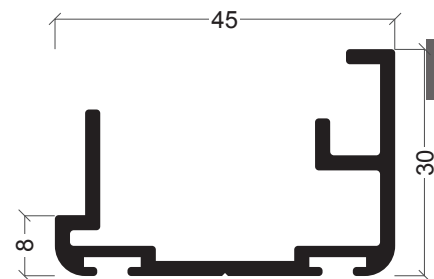

AX-71
Suplemento vaivém

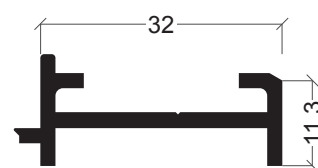

AX-61
Suplemento abertura interior



AX-63
Remate pavimento

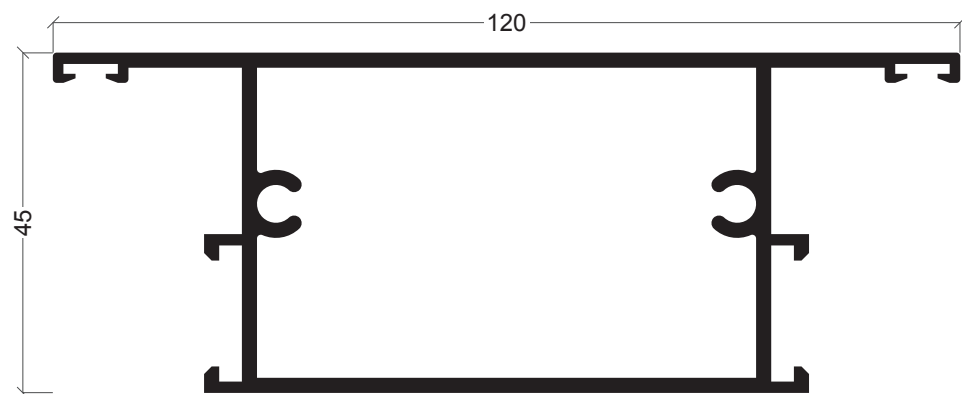

AX-67
Travessa



AX-60
Vedação inferior

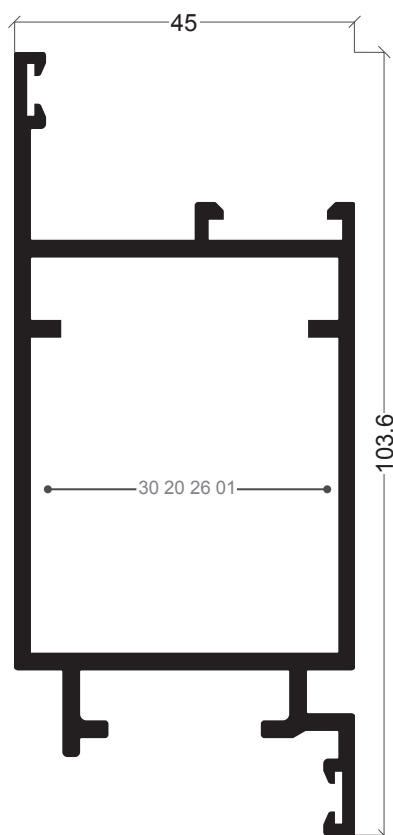

AX-76
Aro móvel

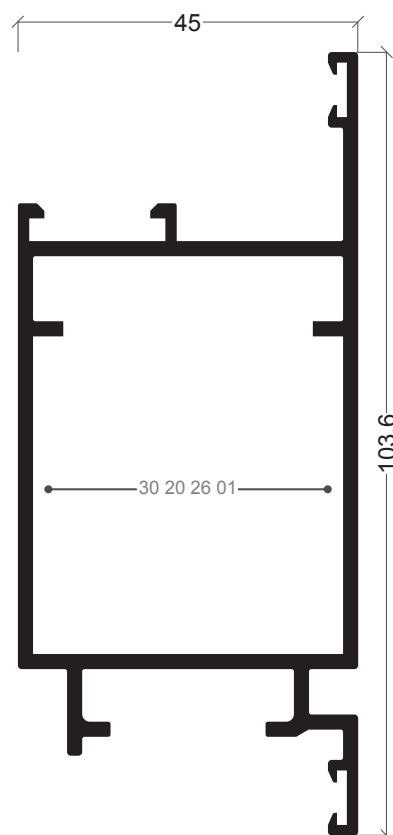

AX-77
Aro móvel abertura exterior

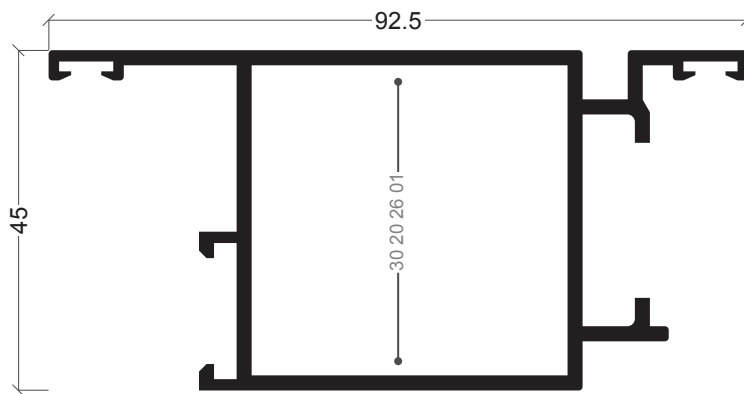

AX-66
Aro móvel abertura exterior

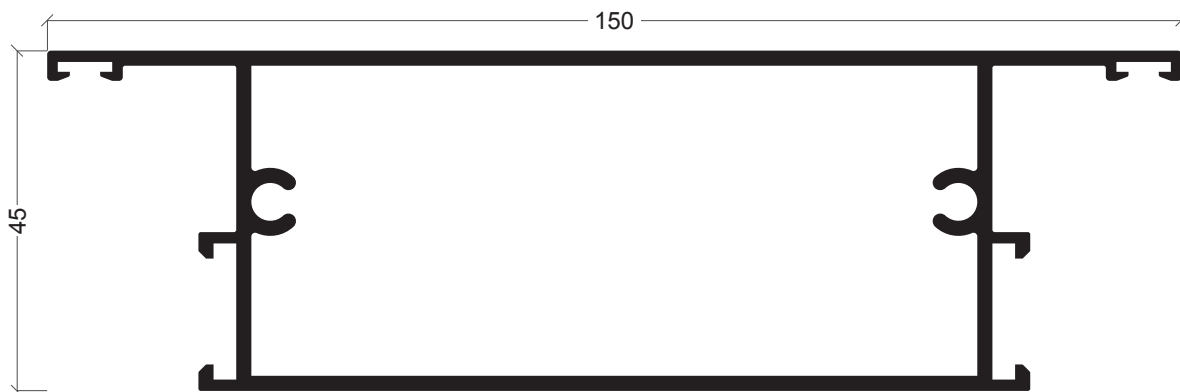

AX-75
Travessa

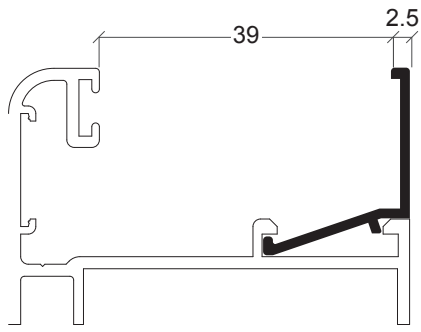

AX-69

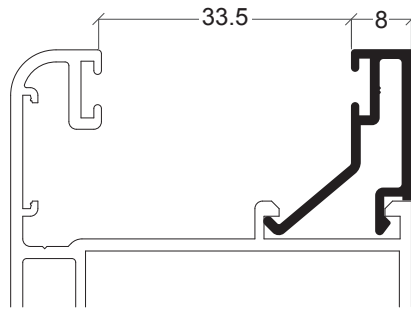

AX-74

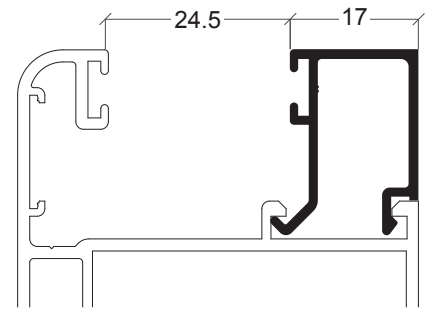

AX-46

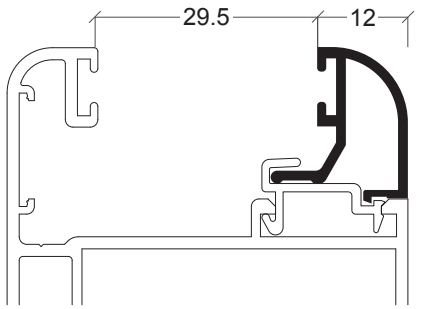

AX-37

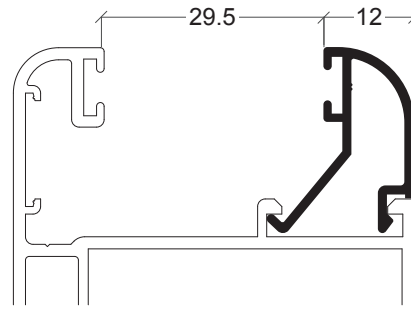

AZ-08

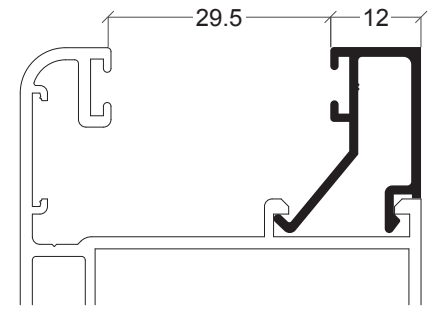

AX-36

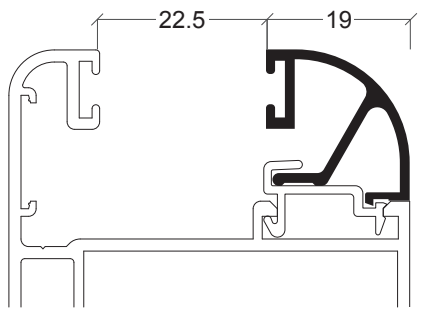

AX-30

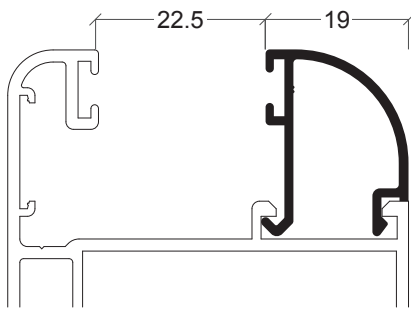

AZ-07

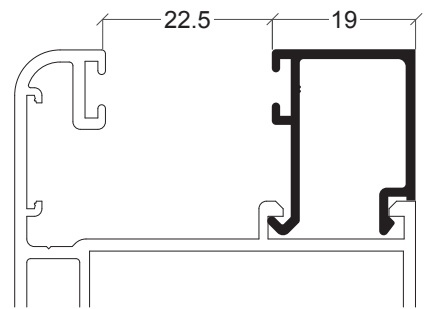

AX-35

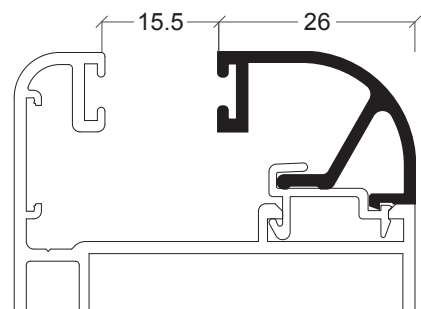

AX-29

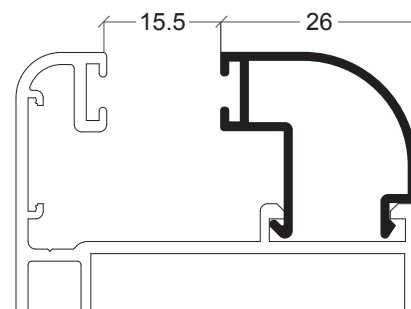

AZ-06

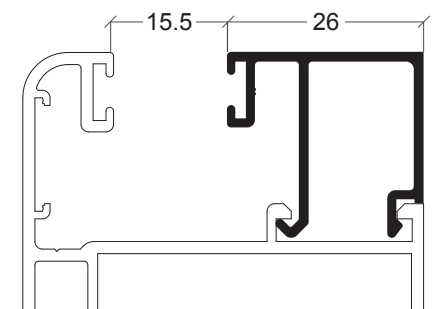

AX-31

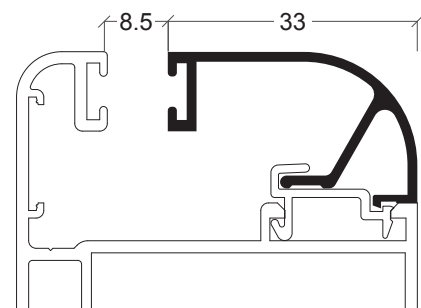

AX-39

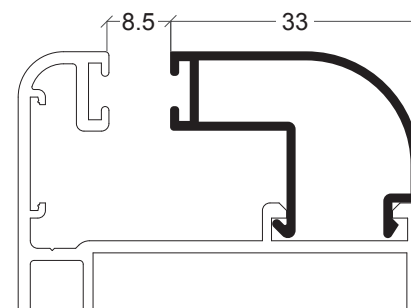

AZ-28

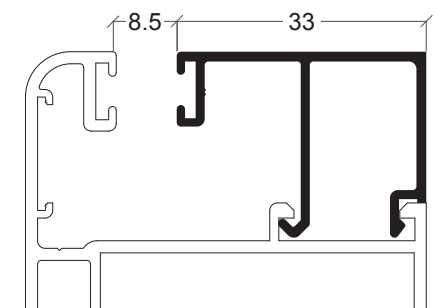

AX-34

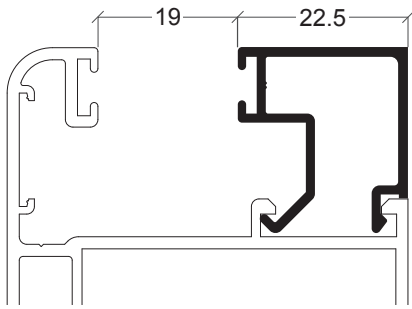

AX-78

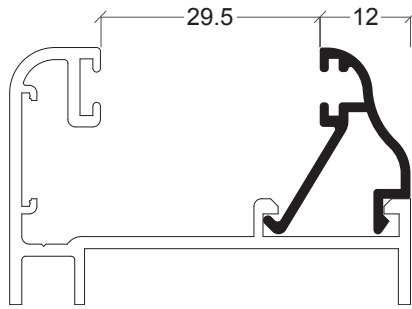

AX-73

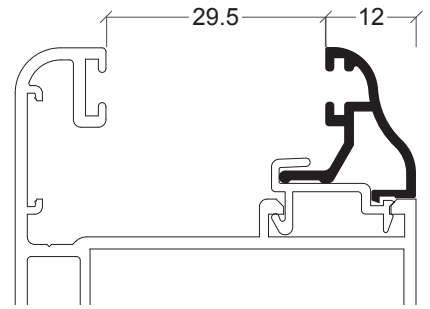

AX-72

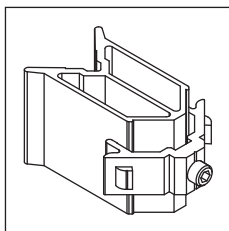

30 20 26 01
Esquadro porta milénio

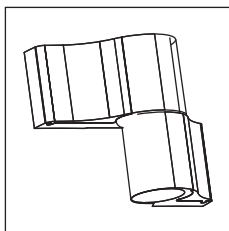

30 20 26 02/06
Dobradiça abas desiguais branca/preta

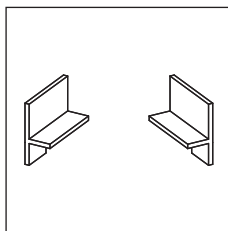

30 20 26 04
Jogo tampas batente da folha

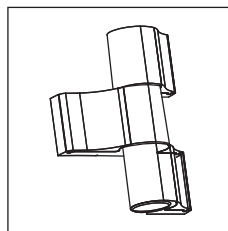

30 20 26 05/07
Dobradiças 3 abas desiguais branco/preto

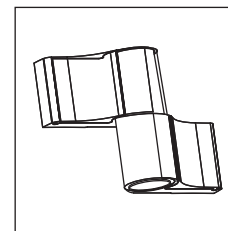

30 20 26 09/12
Dobradiça abas iguais preta/branca

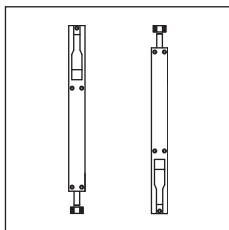

30 20 26 10/11
Fecho 2ª folha pequeno/grande

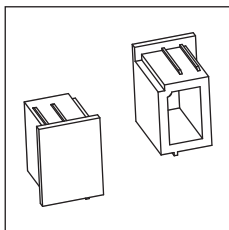

30 91 21 20
Jogo topos condensação Y-20

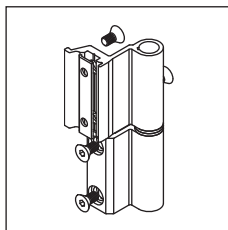

30 92 00 20/21
Dobradiça C.E. branco/preto

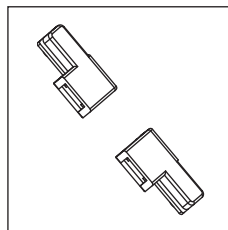

30 92 00 30
Transmissão barra cremone

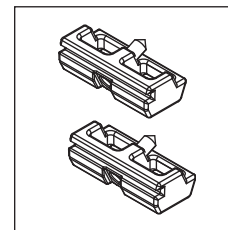

30 92 00 50
Complemento fecho

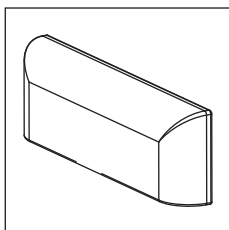

30 92 01 00/01
Goteiras branco/preto

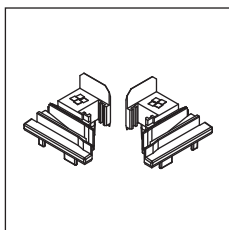

30 92 01 13
Jogo topos inversor com furo

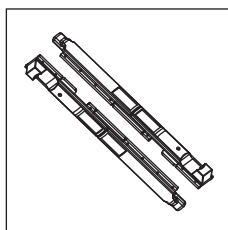

30 92 01 20
Jogo fecho C.E.

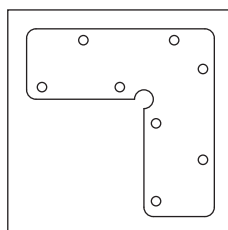

30 92 01 35
Esquadro alinhamento aro móvel

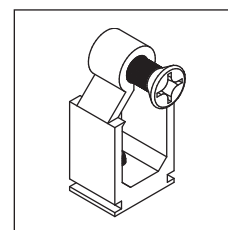

30 92 01 40
União topos janela

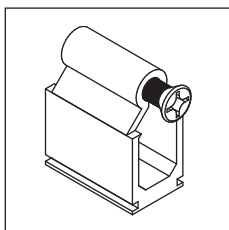

30 92 01 50
União topos porta

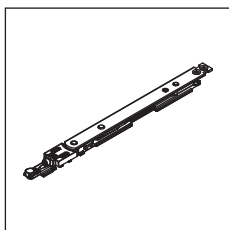

30 92 02 10/11/12
Compasso oscilo 300/400/500

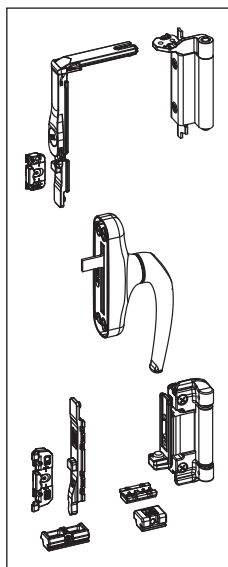

30 92 02 20/21
Kit oscilobatente branco/preto

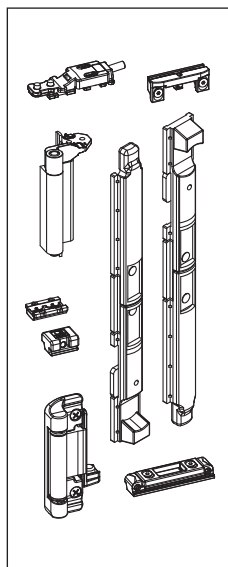

30 92 02 24/25
Kit 2ª folha oscilobatente branco/preto

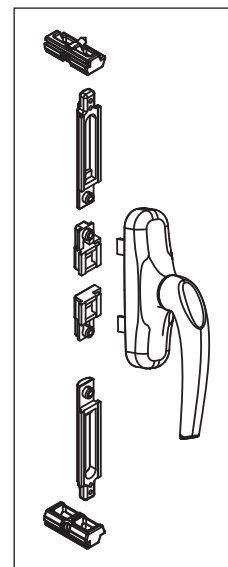

30 92 03 10
Kit cremone branco/preto

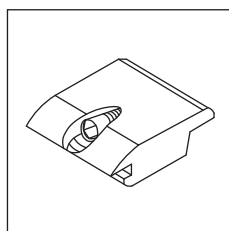

30 92 02 60
Apoio da folha

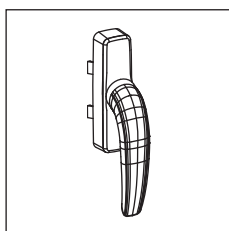

30 92 03 20/21
Cremone abertura exterior branco/preto

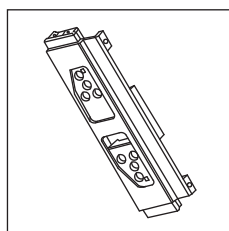

30 92 03 30
Jogo transmissão abertura exterior

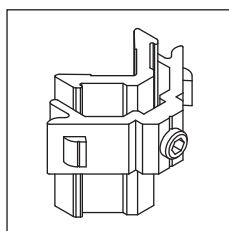

30 92 03 60
Esquadro janela

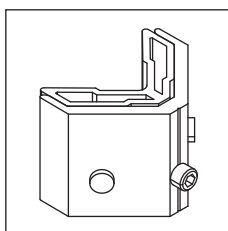

30 92 03 62
Esquadro aro móvel AX-53

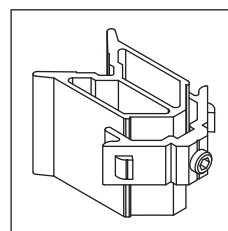

30 92 03 63
Esquadro aro móvel AX-06/07/09/10

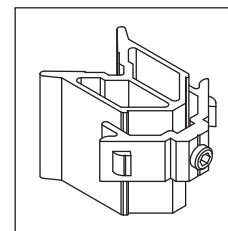

30 92 03 70
Esquadro porta

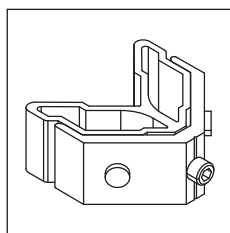

30 92 04 10

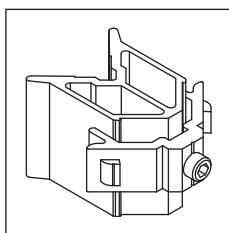
Esquadro inversor pivotante

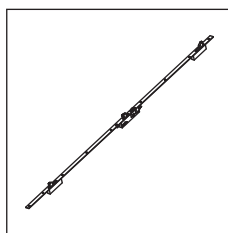

30 92 04 30

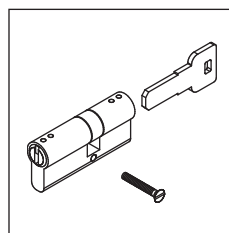
Esquadro móvel pivotante

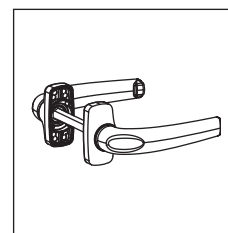

30 92 05 10/11

 Fechadura 3 pontos
 35 mm/30 mm

30 92 05 40

Canhão fechadura

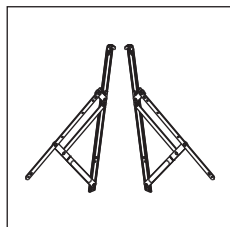
30 92 05 60/61

Puchador duplo branco/preto

30 92 06 00

Compasso projectante deslizante

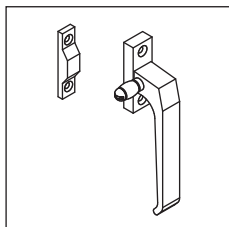
30 92 06 10/11

Cremona de lingueta branco/preto

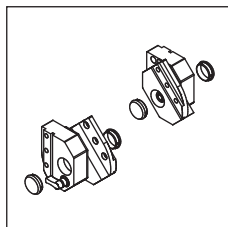
30 92 07 10/11

Jogo pivotante preto/branco (60 kg)

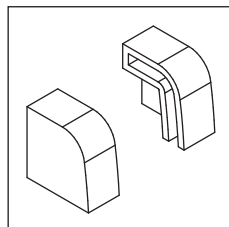
30 96 00 12

Jogo topos condensação

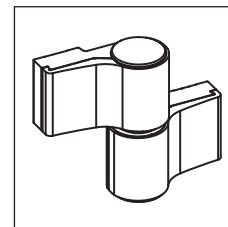
30 96 00 32

Dobradiça dupla lisa 80 mm (preto)

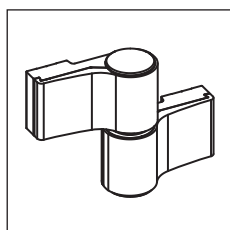
30 96 00 34

Dobradiça dupla anti-entalamento (preto)

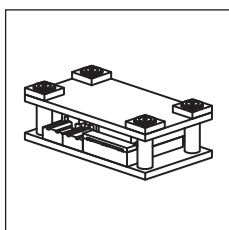
33 96 69 99

Cunho AX-Milénio

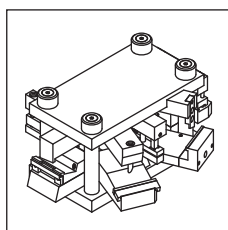
33 96 79 99







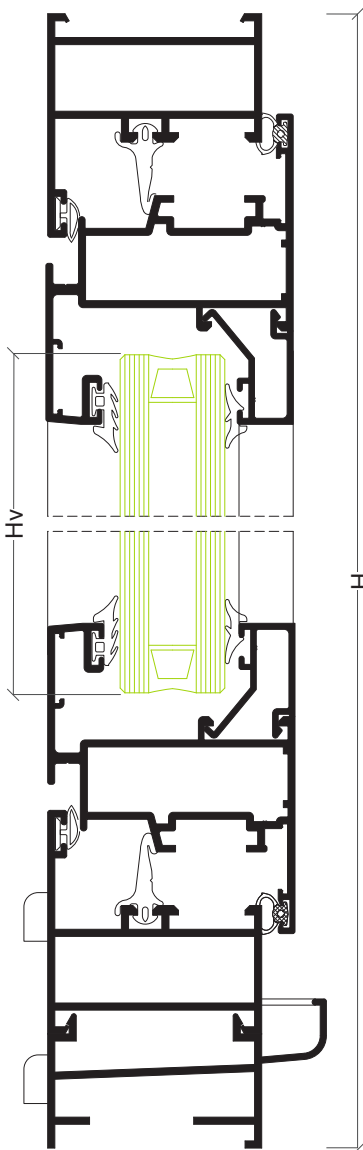
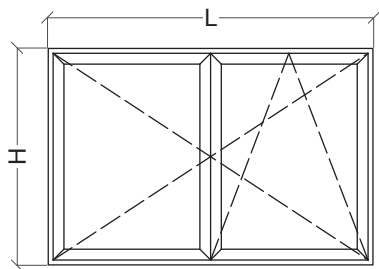







Cunho CE

Referência	Desenho	Descrição
30 00 95 15		Junta vedação interior curta
30 20 26 03		Junta interior/exterior
30 20 26 14		Junta anti-entalamento 4.40 mts (preto)
30 60 00 17		Junta exterior vidro plana 2 mm preto
30 93 00 50		Junta central
30 93 00 60		Vedante exterior do vidro (opcional)
30 93 00 61		Junta vedação exterior vidro 2 mm
30 93 00 62		Junta plana para vidro
30 93 00 65		Junta interior para vidro (5 mm)
30 93 00 66		Junta interior para vidro (4 mm)
30 93 00 67		Junta interior para vidro (2 mm)
30 93 00 68		Junta interior para vidro (6/7 mm)
30 93 00 69		Junta interior para vidro (8/9 mm)
30 93 00 70		Vedante interior do vidro (opcional)
30 93 00 81		Junta vedação inferior
30 93 00 82		Junta vedação inferior
30 93 00 90		Junta exterior
30 93 01 20		Junta interior
30 93 01 30		Junta exterior (abertura exterior/projectante)
30 95 00 10		Pelúcia 7x9 mm
30 95 00 40		Pelúcia 7x5.5 mm

Janela 2 folhas abrir e oscilo-batente



Perfis

Desenho	Ref	Descrição	Corte	Quant	Medida
	AX-03	Aro fixo		2	L
				2	H-24 mm
	AX-02	Aro móvel		4	L/2-24 mm
				4	H-66 mm
	AX-11	Inversor		1	H-134 mm
	---	Bite		4	L/2-117 mm
				4	H-199 mm
	AX-58	Soleira de condensação		1	L
	AX-19	Vareta		2	Apro. H/2 mm

Acessórios e Juntas

Referência	Descrição	Quantidade	
		Abrir	Oscilo-batente
30 92 00 20	Dobradiças C.E.	4	---
30 92 01 00	Goteiras	4	4
30 92 01 13	Jogo topos inversor	1	1
30 92 01 20	Jogo fecho C.E.	1	---
30 92 01 35	Esquadro alinhamento aro móvel	8	8
30 92 02 XX	Compasso O.B.	---	1
30 92 02 20	Kit oscilo-batente	---	1
30 92 02 24	Kit 2ª folha oscilo-batente	---	1
30 92 02 60	Apoio da folha	1	---
30 92 03 10	Kit cremone	1	---
30 92 03 60	Esquadro janela	12	12
30 96 00 12	Jogo topos condensação	1	
30 93 00 50	Junta central	2L+3H	
30 93 00 90	Junta exterior	2L+4H	
30 93 01 20	Junta interior	2L+4H	
---	Junta exterior vidro	2L+4H	
---	Junta interior vidro	2L+4H	

197

Vidro

Hv = H-173 mm	Lv = L/2-131 mm
---------------	-----------------

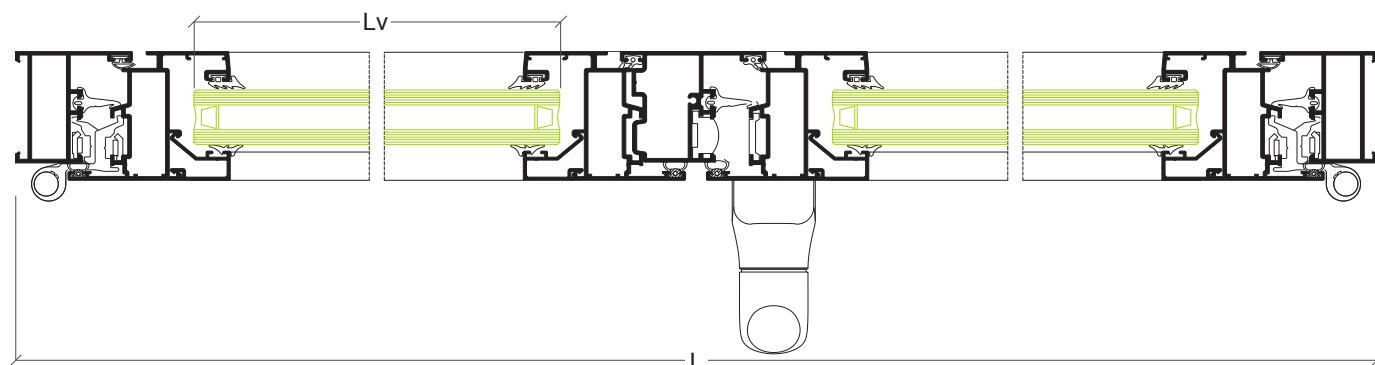

Janela projectante

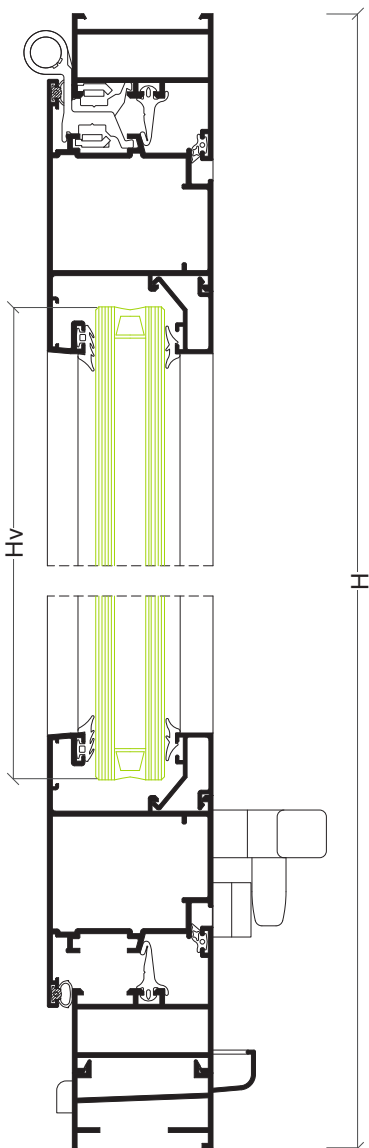
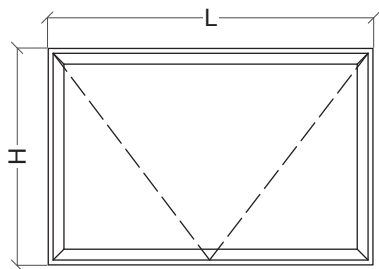

Perfis

Desenho	Ref	Descrição	Corte	Quant	Medida
	AX-03	Aro fixo		2	L
				2	H-24 mm
	AX-06	Aro móvel		2	L-42 mm
				2	H-66 mm
	---	Bite		2	L-178 mm
				4	H-242 mm
	AX-58	Soleira de condensação		1	L

Acessórios e Juntas

Referência	Descrição	Quantidade
30 92 00 20	Dobradiças C.E.	2
30 92 01 00	Goteiras	2
30 92 03 60	Esquadro janela	4
30 92 03 63	Esquadro porta	4
30 93 00 50	Junta central (facultativa)	2L+2H
30 92 01 35	Esquadro alinhamento aro móvel	4
30 92 04 85	Jogo compasso projectante	1
30 92 06 10	Cremona lingueta	2
30 96 00 12	Jogo topos condensação	1
30 93 00 90	Junta interior	2L+2H
30 93 01 30	Junta exterior	2L+2H
---	Junta exterior vidro	2L+2H
---	Junta interior vidro	2L+2H

Vidro

Hv = H-216 mm	Lv = L-192 mm
---------------	---------------

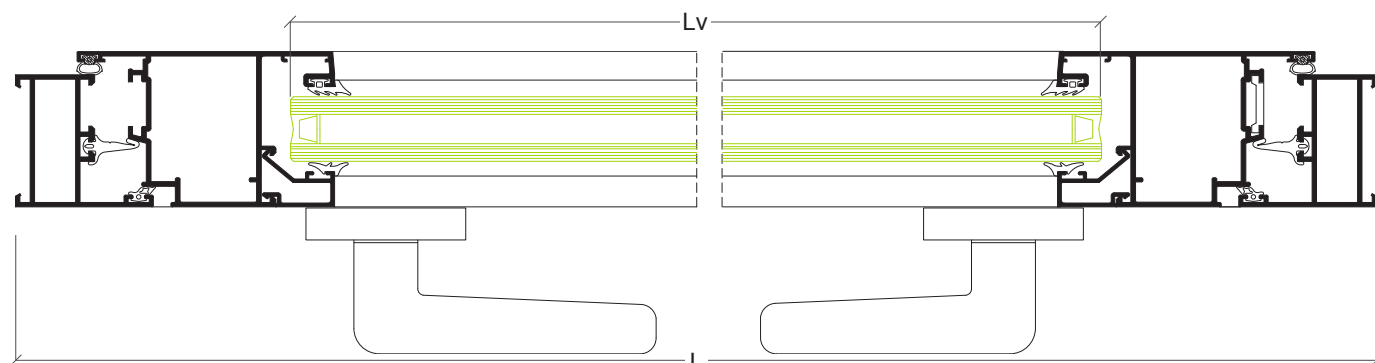

Janela pivotante horizontal

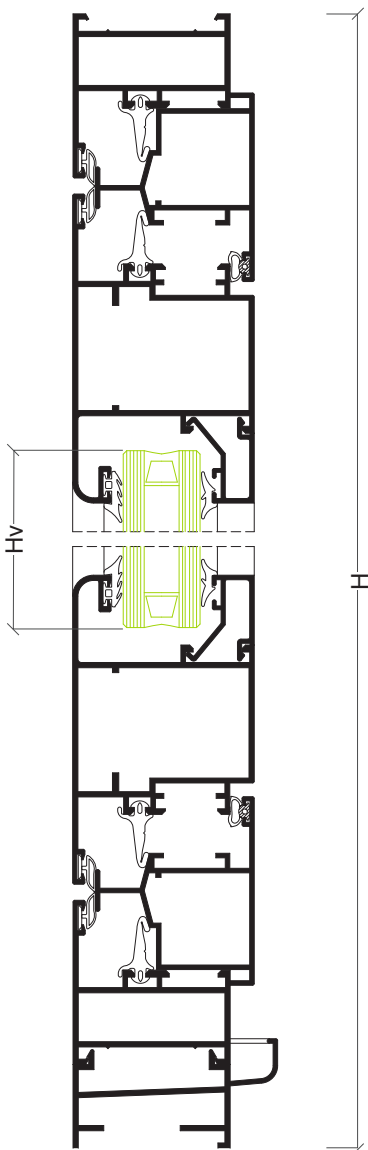
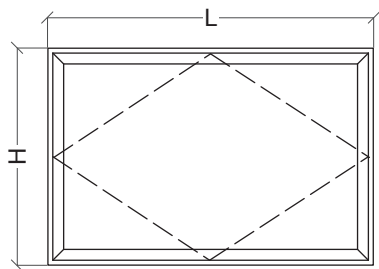

Perfis

Desenho	Ref	Descrição	Corte	Quant	Medida
	AX-51	Aro fixo pivotante		2	L
				2	H-24 mm
	AX-54	Aro móvel pivotante		2	L-103 mm
				2	H-127 mm
	AX-55	Inversor superior		1	L-44 mm
				2 (1+1)	H/2-34 mm
	AX-55	Inversor inferior		1	L-44 mm
				2 (1+1)	H/2-34 mm
	---	Bite		2	L-240 mm
				2	H-304 mm
	AX-58	Soleira de condensação		1	L

Acessórios e Juntas

Referência	Descrição	Quantidade
30 92 01 00	Goteiras	4
30 92 03 60	Esquadro janela	4
30 92 04 10	Esquadro inversor pivotante	4
30 92 04 30	Esquadro porta	4
30 92 07 10	Jogo pivotante	1
30 92 06 11	Cremona lingueta	2
30 93 00 50	Junta central	4L+4H
30 93 00 90	Junta interior	4L+4H
30 93 01 30	Junta exterior	2L+2H
---	Junta exterior vidro	2L+2H
---	Junta interior vidro	2L+2H

199

Vidro



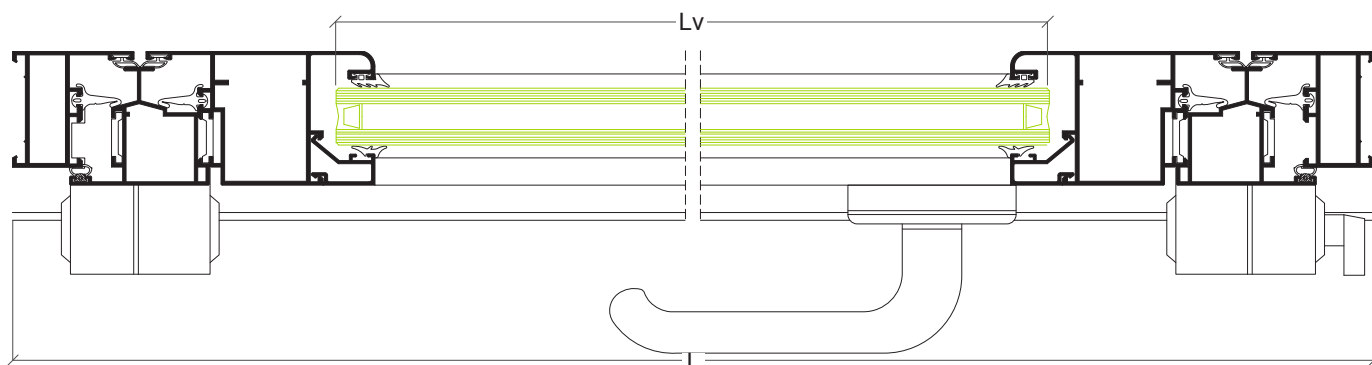



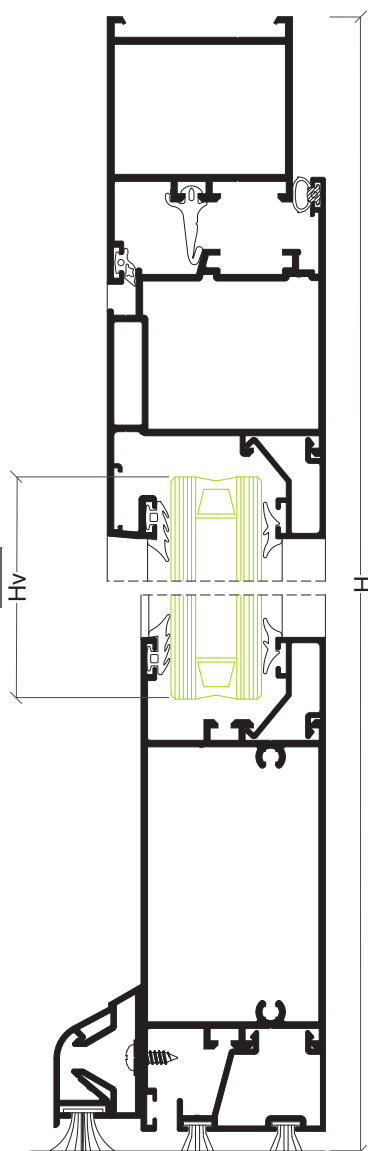
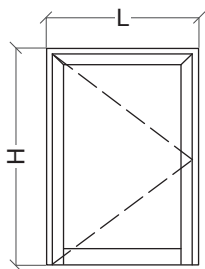



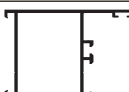

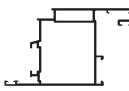



Hv = H-278 mm	Lv = L-254 mm
---------------	---------------



Porta 1 folha



Perfis

Desenho	Ref	Descrição	Corte	Quant	Medida
	AX-08	Aro fixo		1	L
				2	H
	AX-07	Aro móvel		1	L-78 mm
				2	H-45 mm
	AX-12	Travessa		1	L-205 mm
	AX-15	Bite remate		1	L-213.5 mm
	---	Bite		2	L-213.5 mm
				2	H-253 mm
	AZ-60	Pingadeira		1	L-148 mm
	AZ-61	Suplemento		1	L-254 mm

Acessórios e Juntas

Referência	Descrição	Quantidade
30 92 00 20	Dobradiças C.E.	3
30 92 01 35	Esquadro alinhamento móvel	4
30 92 03 63	Esquadro móvel	2
30 92 03 70	Esquadro porta	2
30 92 05 10	Fechadura 3 pontos	1
30 92 05 40	Canhão fechadura	1
30 92 05 60	Puxador duplo	1
30 92 01 00	Goteira	2
30 92 05 00	Jogo topos	1
30 93 00 50	Junta central	1L+2H
30 93 00 90	Junta exterior	1L+2H
30 93 01 20	Junta interior	1L+2H
30 95 00 10	Pelúcia 7x9 mm	2L
---	Junta exterior vidro	2L+2H
---	Junta interior vidro	2L+2H

Vidro



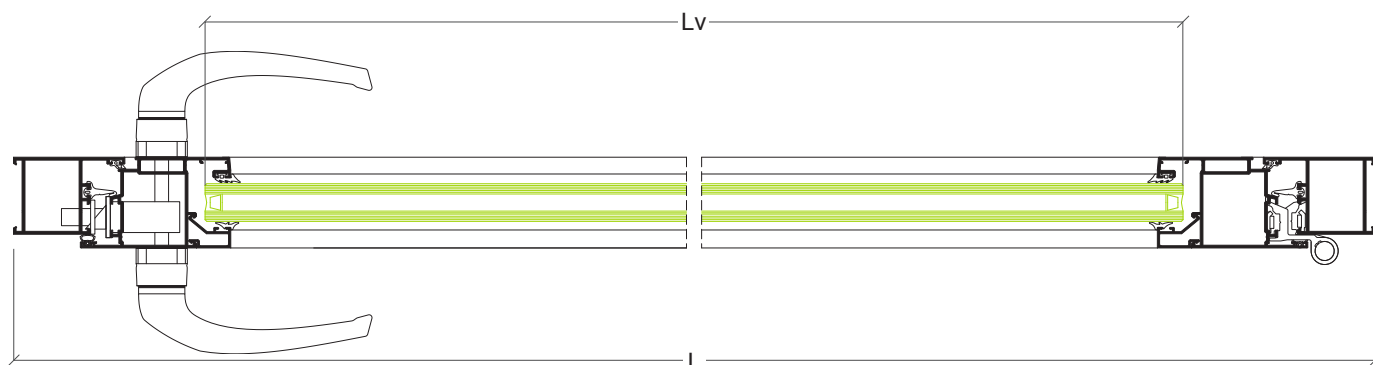



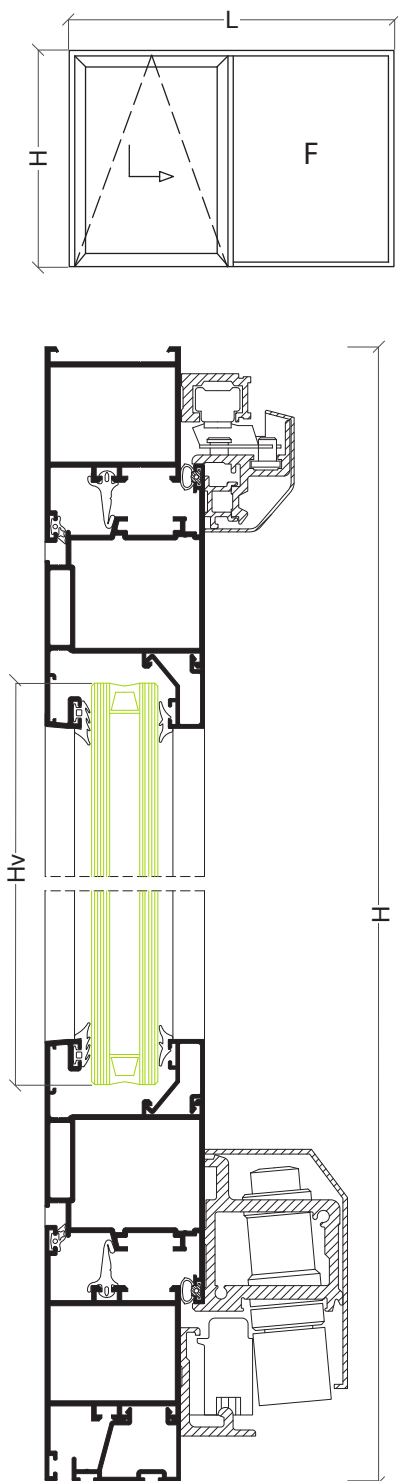



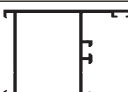

Hv = H-227 mm	Lv = L-227 mm
---------------	---------------

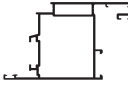

Porta oscilo-paralela com fixo lateral



Perfis

Desenho	Ref	Descrição	Corte	Quant	Medida
	AX-08	Aro fixo		1	L
				2	H
	AX-28	Travessa		1	L-81 mm
				1	H-101 mm
	AX-07	Aro móvel		2	L1-55.5 mm
				2	H-98 mm
	---	Bite		2	L1-191 mm
				2	H-273.5 mm
	---	Bite		2	L2-67.5 mm
				2	H-150 mm
	AX-15	Bite remate		1	L-90 mm
	AX-19	Vareta		1	Apro. L1
				2	Apro. L1

Acessórios e Juntas

Referência	Descrição	Quantidade
30 92 01 00	Goteiras	4
30 92 01 35	Esquadro alinhamento móvel	8
30 92 03 63	Esquadro móvel AX-10	4
30 92 03 70	Esquadro porta	4
---	Kit oscilo-paralela	1
30 92 01 50	União porta	4
30 93 00 50	Junta central	L+2H
30 93 00 90	Junta exterior	L+2H
30 93 01 20	Junta interior	L+2H
---	Junta exterior vidro	2L+4H
---	Junta interior vidro	2L+4H

Vidro

Hv folha = H-248 mm	Lv folha = L1-205 mm	
Hv fixo = H-124 mm	Lv fixo = L2-82 mm	
	Mínimo	Máximo
Largura da folha	700 mm	1650 mm
Altura da folha	850 mm	2400 mm
Peso máximo por folha 150 kg		



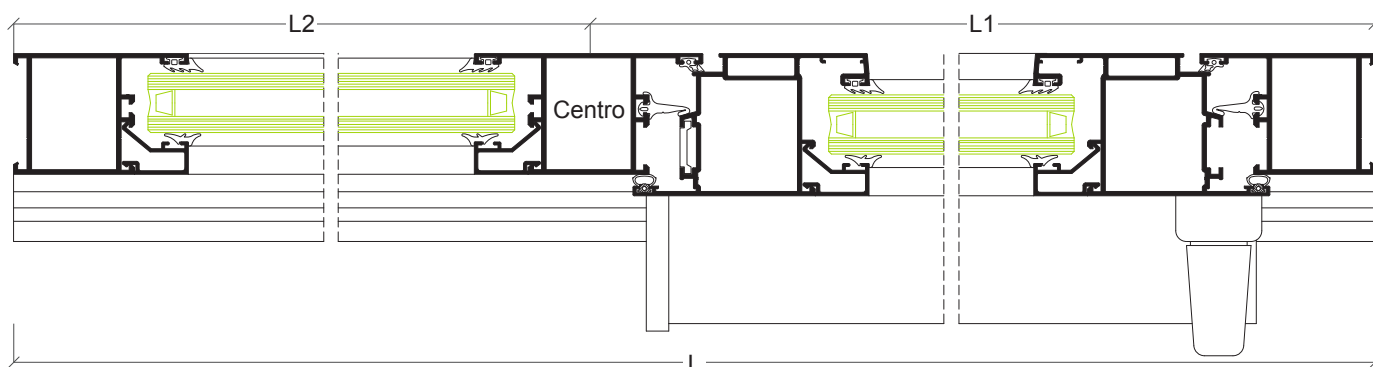



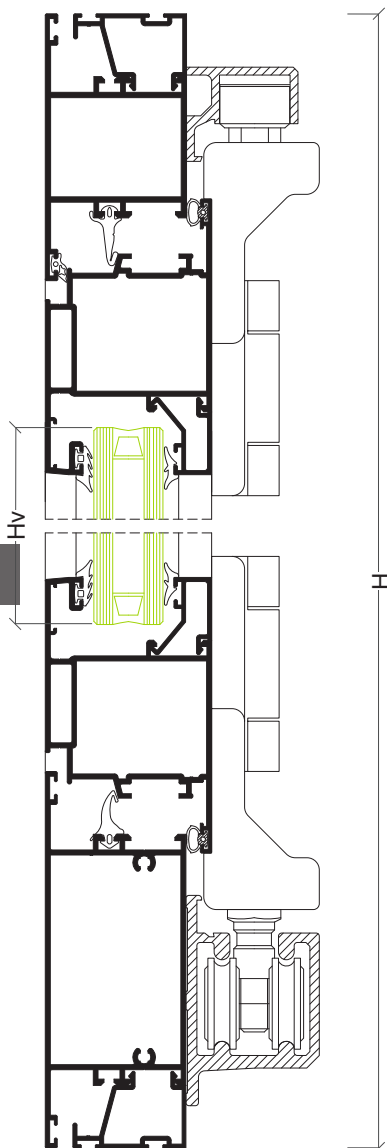
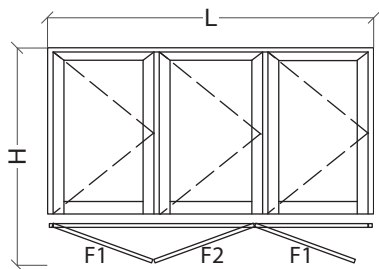







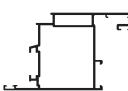

201



Porta 3 folhas harmónio



Perfis

Desenho	Ref	Descrição	Corte	Quant	Medida
	AX-08	Aro fixo		2	H
	AX-28	Travessa		1	L-81 mm
	AX-07	Aro móvel		4	F1 consultar
				2	F2 consultar
				6	consultar
	AX-11	Inversor		2	consultar
	---	Bite		2	consultar
				2	consultar
	AX-15	Bite remate		2	L
	AX-19	Vareta		1+1	H+H

Acessórios e Juntas

Referência	Descrição	Quantidade
30 92 00 26	Dobradiças 3 nós	3
30 92 01 00	Goteiras	4
30 92 01 13	Jogo topos inversor	2
30 92 01 35	Esquadro alinhamento móvel	24
30 92 03 63	Esquadro móvel	12
30 92 03 70	Esquadro porta	4
---	Kit harmónio (3+0)	1
30 93 00 50	Junta central	2L+4H
30 93 00 90	Junta exterior	2L+6H
30 93 01 20	Junta interior	2L+6H
---	Junta exterior vidro	2L+4H
---	Junta interior vidro	2L+4H

Vidro

Hv = consultar	Lv 1 = consultar	
	Lv 2 = consultar	
	Mínimo	Máximo
Largura da folha	600 mm	900 mm
Altura da folha	850 mm	2400 mm
Peso máximo por folha 80 kg		

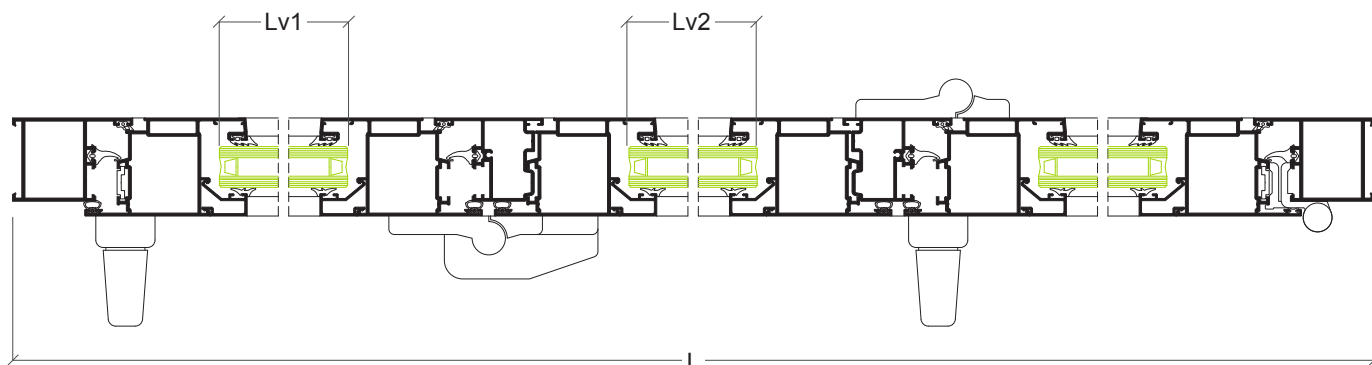

Porta 1 folha

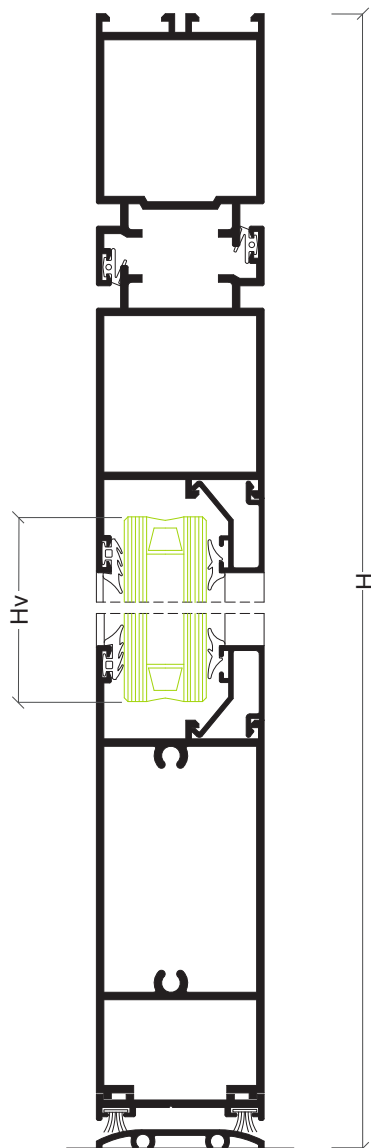
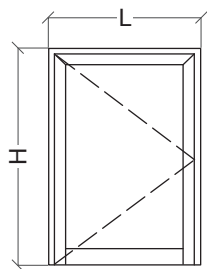

Perfis

Desenho	Ref	Descrição	Corte	Quant	Medida
	AX-64	Aro fixo		1	L
				2	H
	AX-65	Aro fixo		1	L-114 mm
				2	H-72 mm
	AX-68	Almofada		1	L-250 mm
	AX-36	Bite		2	L-260 mm
				2	H-285 mm
	AX-60	Vedação inferior		1	L-114 mm
	AX-63	Remate pavimento		1	L-105 mm

Acessórios e Juntas

Referência	Descrição	Quantidade
30 20 26 01	Esquadro porta	4
30 20 26 02	Dobradiças	3
---	Fechadura especial (sob encomenda)	1
---	Chapa testas (sob encomenda)	3
30 92 05 40	Canhão de fechadura	1
30 92 05 60	Puxador duplo	1
30 20 26 03	Junta interior	2L+4H
30 95 00 10	Pelúcia 7x9 mm	2L







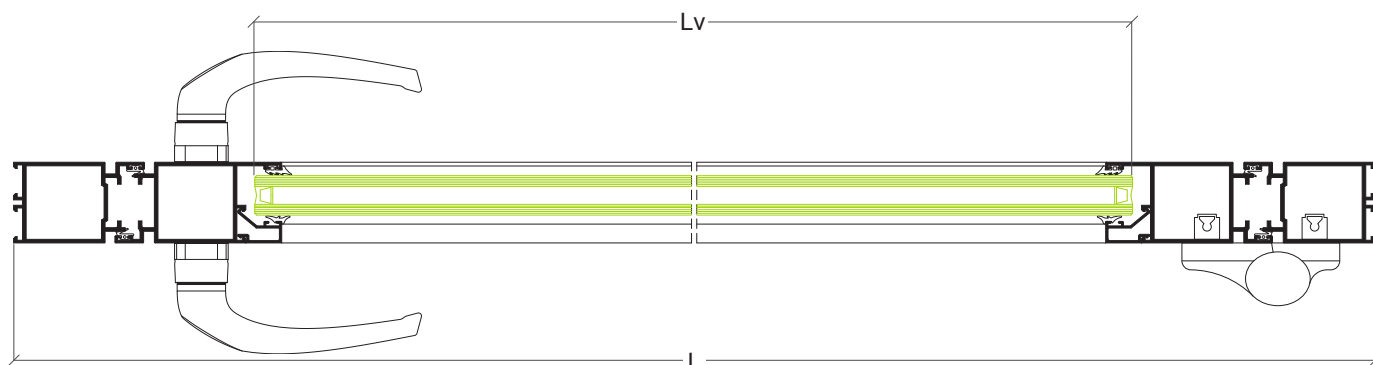

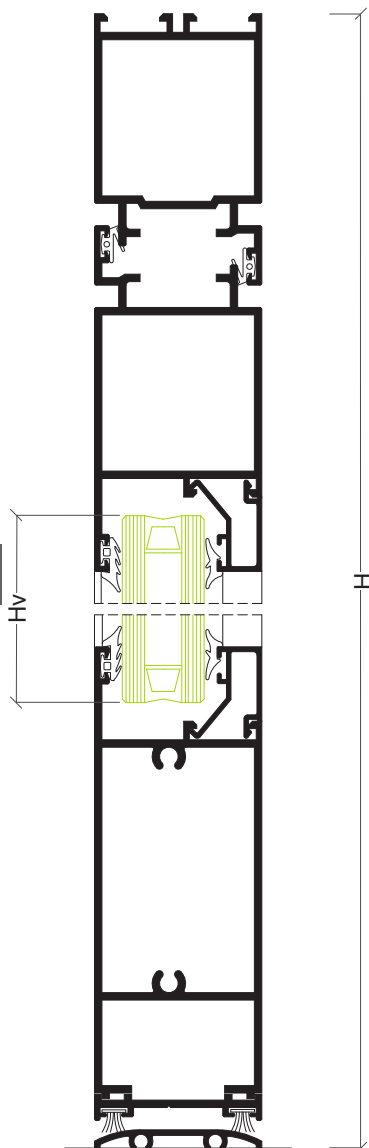
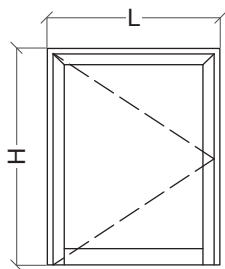

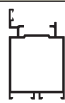

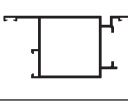
203

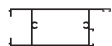
Vidro

Hv = H-259 mm	Lv = L-274 mm
---------------	---------------



Porta 1 folha abertura exterior

Perfis

Desenho	Ref	Descrição	Corte	Quant	Medida
	AX-64	Aro fixo		1	L
				2	H
	AX-66	Aro móvel abertura exterior		1	L-114 mm
				2	H-72 mm
	AX-68	Almofada		1	L-250 mm
	AX-36	Bite		2	L-260 mm
				2	H-285 mm
	AX-60	Vedação inferior		1	L-114 mm
	AX-63	Remate pavimento		1	L-105 mm

Acessórios e Juntas

Referência	Descrição	Quantidade
30 20 26 01	Esquadro porta	4
30 20 26 02	Dobradiças	3
30 20 26 04	Jogo tampas batente	1
---	Fechadura especial (sob encomenda)	1
---	Chapa testas (sob encomenda)	3
30 92 05 40	Canhão de fechadura	1
30 92 05 60	Puxador duplo	1
30 20 26 03	Junta interior	2L+4H
30 95 00 10	Pelúcia 7x9 mm	2L

Vidro



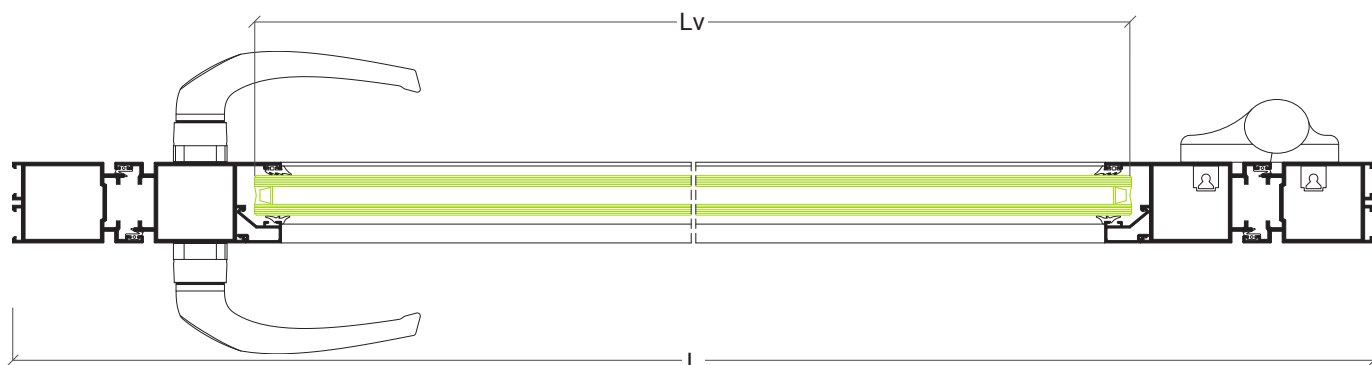



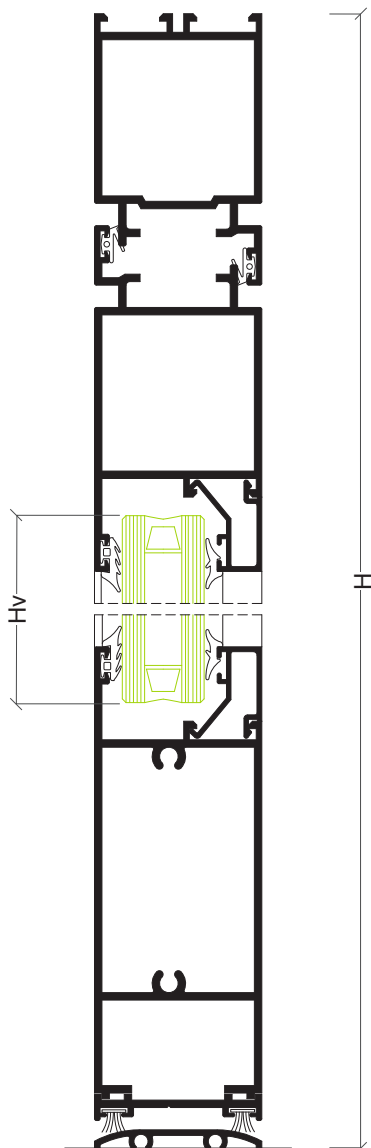
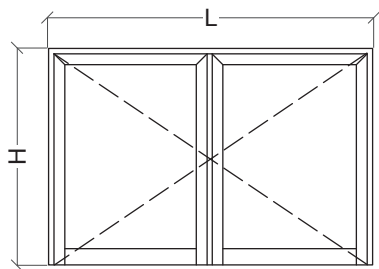





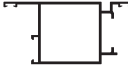

Hv = H-259 mm	Lv = L-274 mm
---------------	---------------

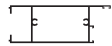

Porta 2 folhas abertura exterior



Perfis

Desenho	Ref	Descrição	Corte	Quant	Medida
	AX-64	Aro fixo		1	L
				2	H
	AX-65	Aro móvel		1	H-72 mm
	AX-66	Aro móvel abertura exterior		2	L/2-49 mm
				3	H-72 mm
	AX-68	Almofada		2	L/2-185 mm
	AX-36	Bite		4	L/2-195 mm
				4	H-285 mm
	AX-60	Vedação inferior		2	L/2-49 mm
	AX-63	Remate pavimento		1	L-105 mm

Acessórios e Juntas

Referência	Descrição	Quantidade
30 20 26 01	Esquadro porta	6
30 20 26 02	Dobradiças	6
30 20 26 04	Jogo tampas batente	2
30 20 26 10	Fecho 2ª folha pequeno	1
30 20 26 11	Fecho 2ª folha grande	1
---	Fechadura especial (sob encomenda)	1
---	Chapa testas (sob encomenda)	3
30 92 05 40	Canhão de fechadura	1
30 92 05 60	Puxador duplo	1
30 20 26 03	Junta interior	2L+6H
30 95 00 10	Pelúcia 7x9 mm	2L

205

Vidro



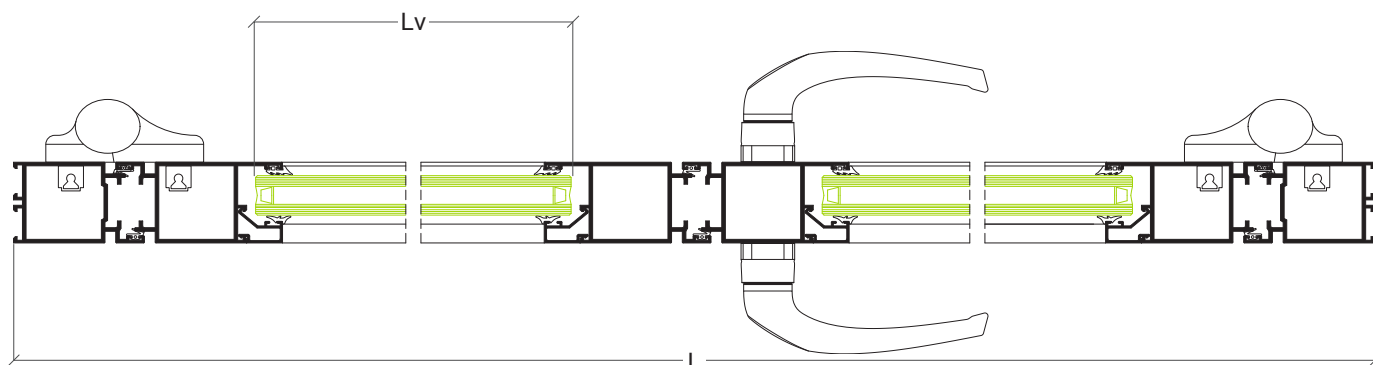



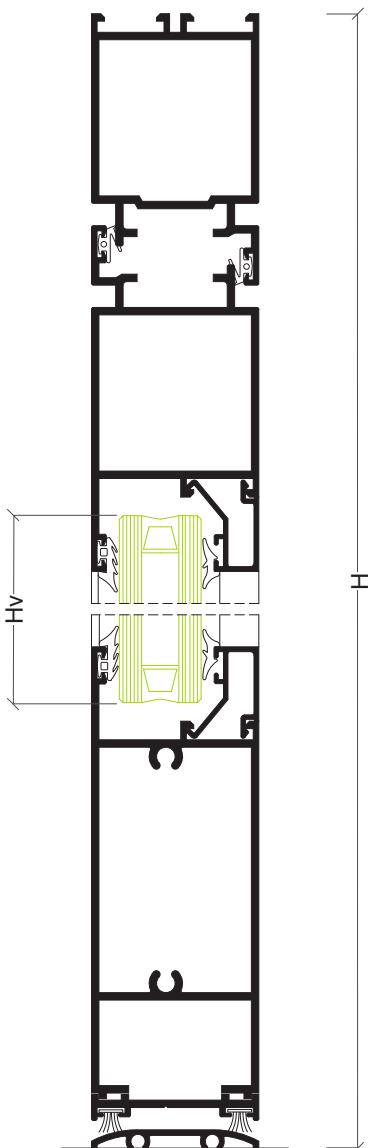
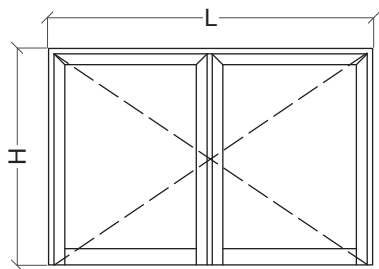





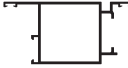

Hv = H-259 mm	Lv = L/2-209 mm
---------------	-----------------

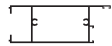

Porta 2 folhas abertura exterior com junta anti-entalamento



Perfis

Desenho	Ref	Descrição	Corte	Quant	Medida
	AX-64	Aro fixo		1	L
				2	H
	AX-65	Aro móvel		1	H-72 mm
	AX-66	Aro móvel abertura exterior		2	L/2-85 mm
				3	H-72 mm
	AX-68	Almofada		2	L/2-222 mm
	AX-36	Bite		4	L/2-231mm
				4	H-285 mm
	AX-60	Vedação inferior		2	L/2-49 mm
	AX-63	Remate pavimento		1	L-105 mm

Acessórios e Juntas

Referência	Descrição	Quantidade
30 20 26 01	Esquadro porta	6
30 96 00 34	Dobradiça dupla anti-entalamento	6
30 20 26 04	Jogo tampas batente	2
30 20 26 10	Fecho 2ª folha pequeno	1
30 20 26 11	Fecho 2ª folha grande	1
30 92 05 40	Canhão de fechadura	1
---	Fechadura especial (sob encomenda)	1
---	Chapa testas (sob encomenda)	3
30 92 05 60	Puxador duplo	1
30 20 26 14	Junta anti-entalamento	4H
30 20 26 03	Junta interior	2L+2 H
30 95 00 10	Pelúcia 7x9 mm	2L

Vidro

Hv = H-259 mm	Lv = L/2-209 mm
---------------	-----------------

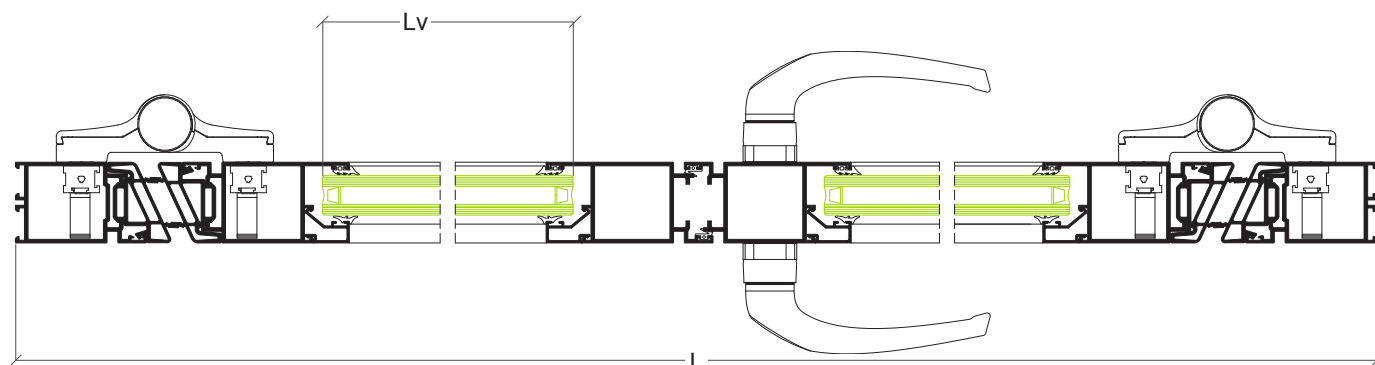

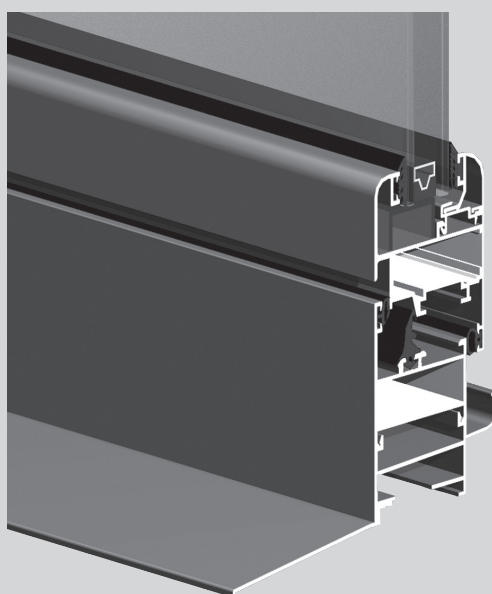

Sistema
AZ

Sistema AZ

Sistema de batente de câmara europeia - 40 mm

Características do sistema

Sistema de batente com câmara europeia e tripla vedação em EPDM (exterior, central, interior).

O sistema AZ possibilita a execução de 4 versões de caixilharia:

1. linha recta;
2. linha curva;
3. linha tradição;
4. linha oval.

Perfis de alumínio

Os perfis de alumínio são extrudidos na liga de alumínio 6060 para arquitectura de acordo com norma NP EN 12020-02.

Espessura média dos perfis de alumínio de 1.5 mm para janelas e portas.

Aros fixos

Secção dos aros fixos de 40 mm ou 72 mm;

Aros fixos com esquadro para montagem a meia esquadria.

Aros móveis

Secção dos aros móveis de 48 mm;

Enchimento para vidro simples ou duplo de 4 mm a 32 mm;

Aros móveis de linha recta, curva, tradição sem bite ou oval sem bite;

Aros móveis com esquadro para montagem a meia esquadria;

Perfil inversor de linha recta ou tradição.

Dimensionamento e manobralidade

Dimensões mínimas - máximas de folha: 375 mm - 1700 mm (L); 410 mm - 2700 mm (H);

Peso máximo de 110 kg por folha com oscilo-batente;

Peso máximo de 90 kg por folha para janelas de abrir;

Peso máximo de 150 kg por folha com dobradiça porta;

Possibilidades de abertura: batente interior (com ou sem oscilo-batente), exterior, basculante, projectante, pivotante, harmónio e oscilo-paralela;

Estanquidade assegurada através de juntas triplas em EPDM.

Performances

Sistema certificado por laboratório notificado para Ensaio Tipo Inicial (ITT) de acordo com a norma de produto EN 14351-1 para efeitos de Marcação CE.

Categorias alcançadas na avaliação do sistema AZ tipologia janela:

1. Permeabilidade ao ar: Classe 4 (norma de ensaio EN 1026)
2. Estanquidade à água: Classe 9A (norma de ensaio EN 1027)
3. Resistência ao vento: Classe C5 (norma de ensaio EN 12211)

Categorias alcançadas na avaliação do sistema AZ tipologia porta:

1. Permeabilidade ao ar: Classe 3 (norma de ensaio EN 1026)
2. Estanquidade à água: Classe 8A (norma de ensaio EN 1027)
3. Resistência ao vento: Classe C2 (norma de ensaio EN 12211)
4. Resistência à torção estática: Apto 350N (norma de ensaio EN 14609)

Coefficiente de transmissão térmica de vão de 2 folhas com 1.20 m x 1.50 m com vidro $U_g = 1.4 \text{ W/m}^2\text{K}$:

• $U_w = 2.92 \text{ W/m}^2\text{K}$

Coefficiente de atenuação acústica de vão de 2 folhas com vidro 4/12/4:

• $R_w (C; C_{tr}) = 33 \text{ dB} (-1; -4)$

Zonas de aplicação segundo RCCTE (em função do valor U_g): I1, I2, I3, V1, V2, V3;

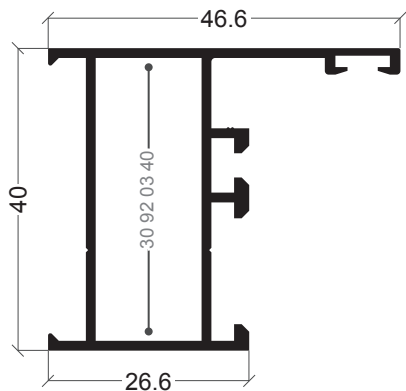

AZ-03
Aro fixo

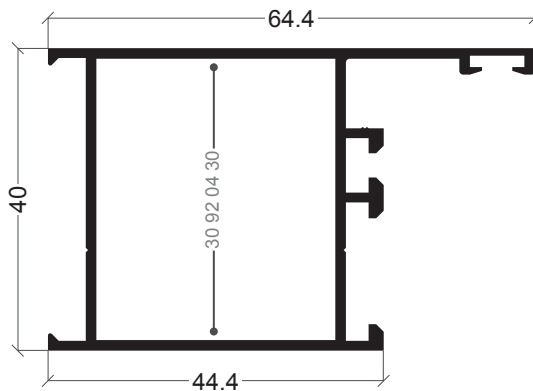

AZ-11
Aro fixo

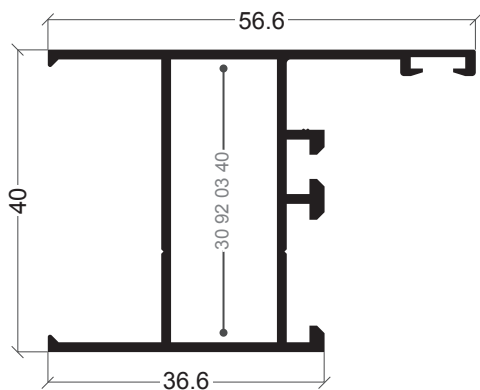

AZ-33
Aro fixo

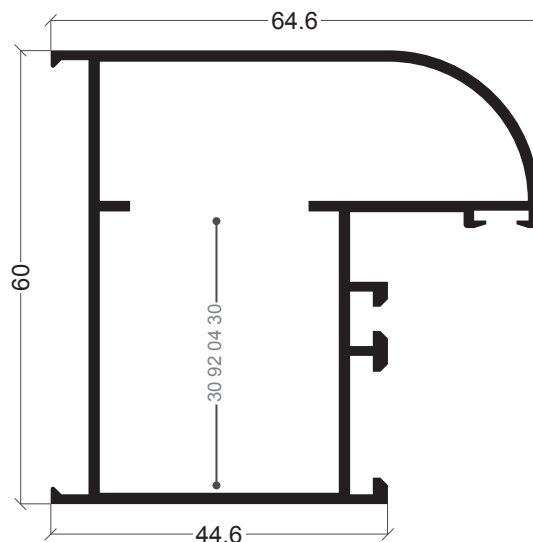

AZ-48
Aro fixo

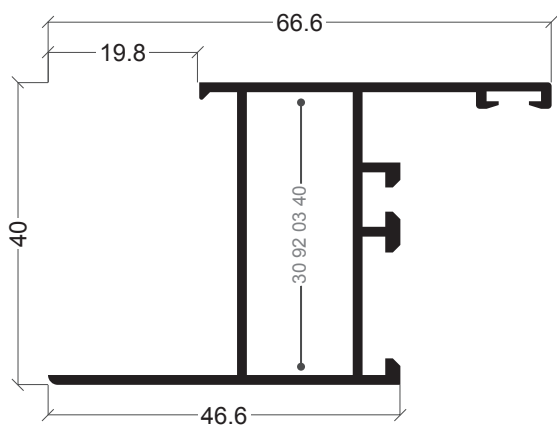

AZ-21
Aro fixo com remate

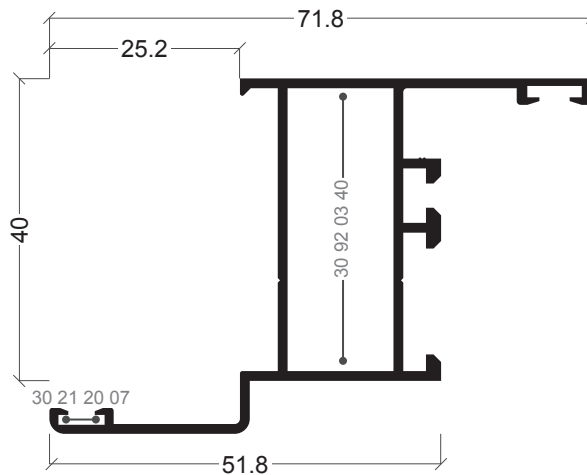

AZ-02
Aro fixo com remate

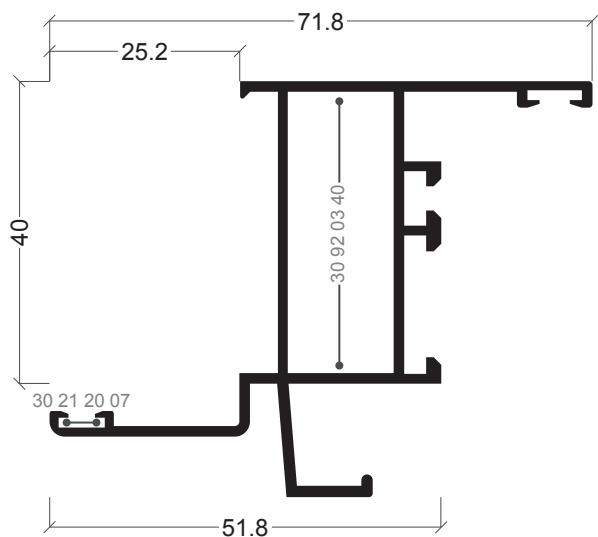

AZ-34
Aro fixo c/ remate e condensação

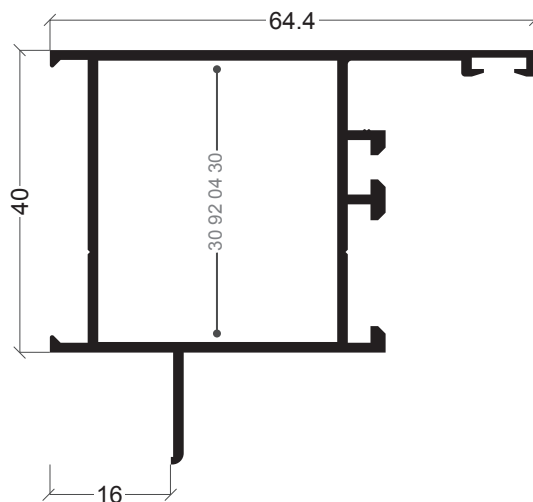

AZ-46
Aro fixo para apanelado

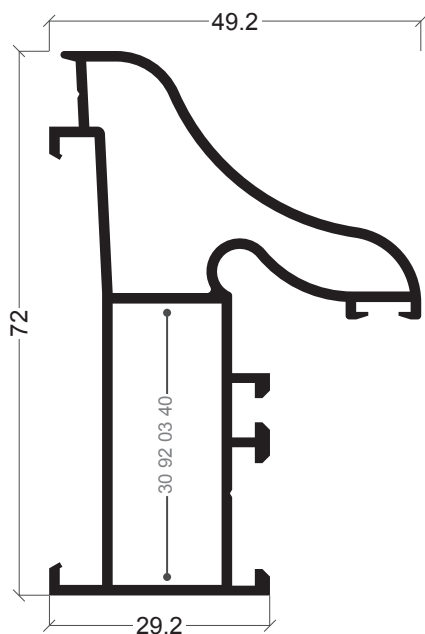

AZ-39
Aro fixo

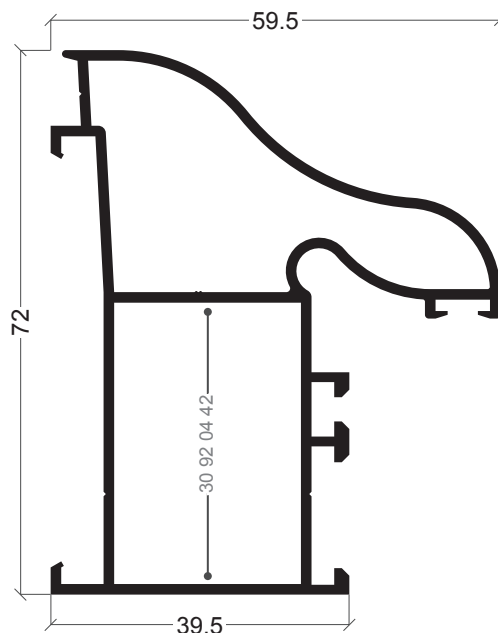

AZ-40
Aro fixo

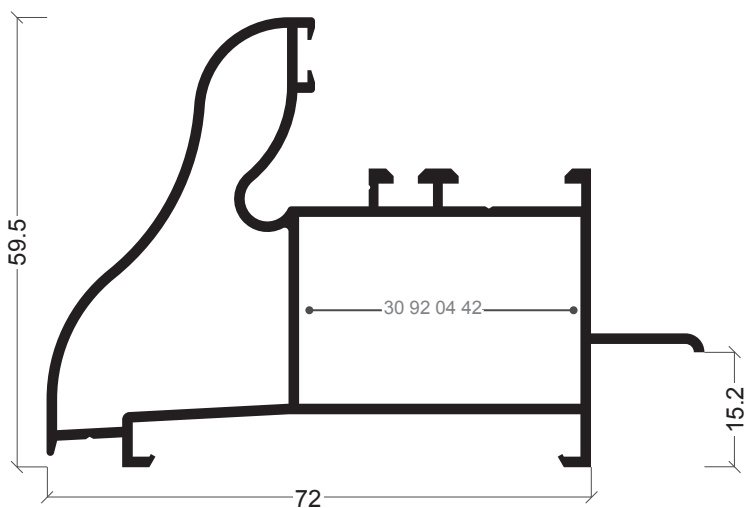

AZ-51
Aro fixo para apanelado

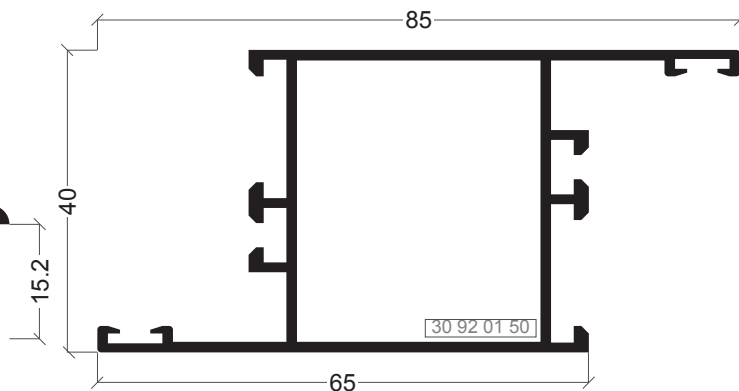

AZ-13
Aro fixo abertura exterior fixo lateral

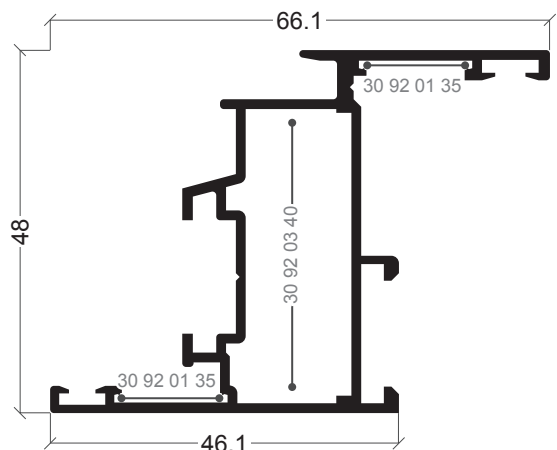

AZ-67
Aro móvel

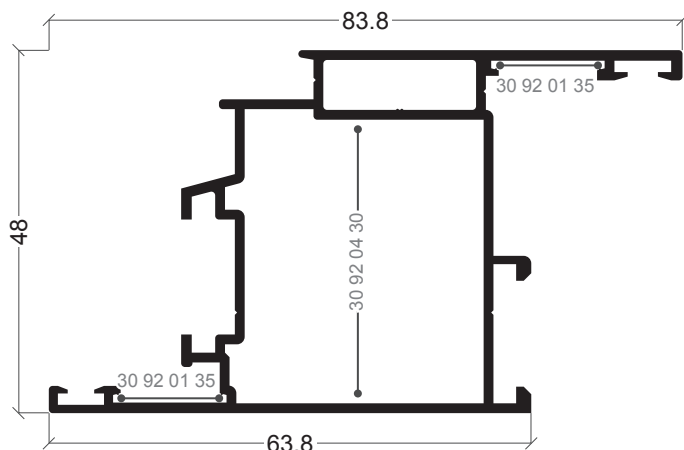

AZ-62
Aro móvel

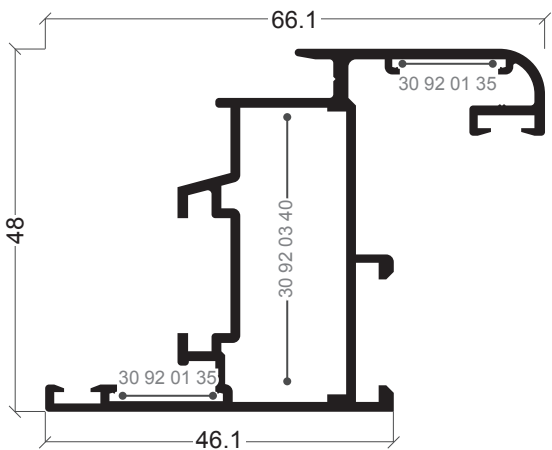

AZ-05
Aro móvel

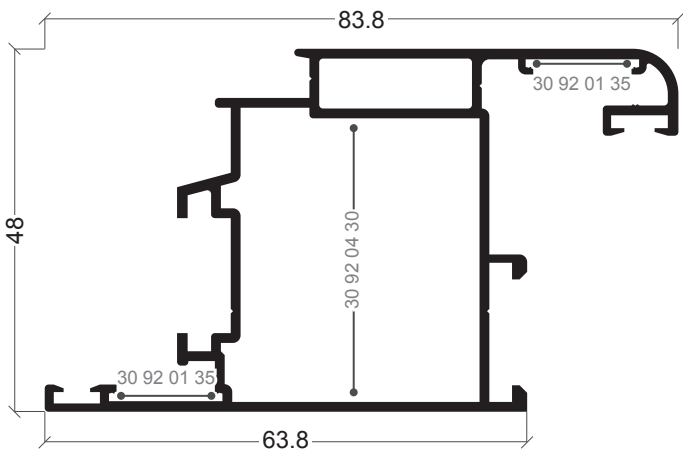

AZ-10
Aro móvel

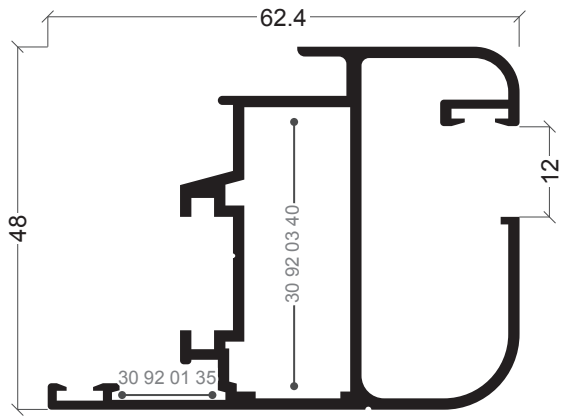

AZ-50
Aro móvel

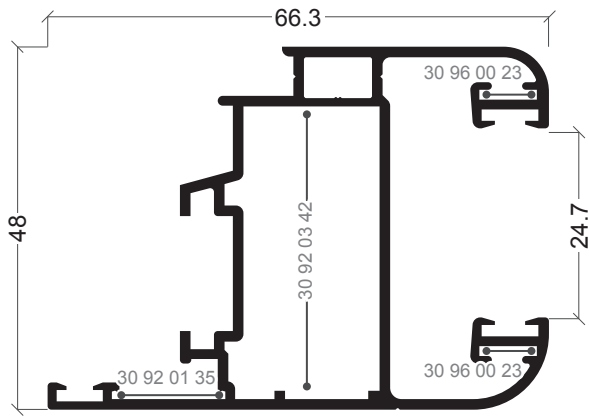

AZ-32
Aro móvel

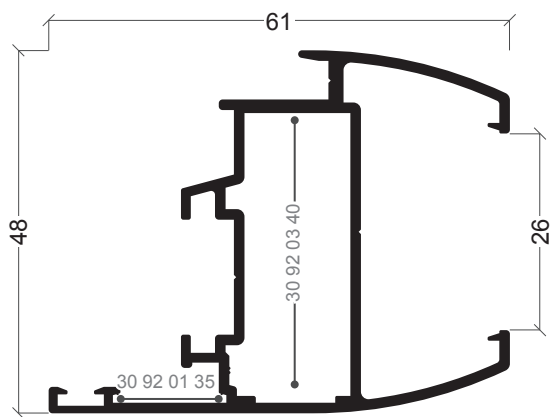

AZ-71
Aro móvel

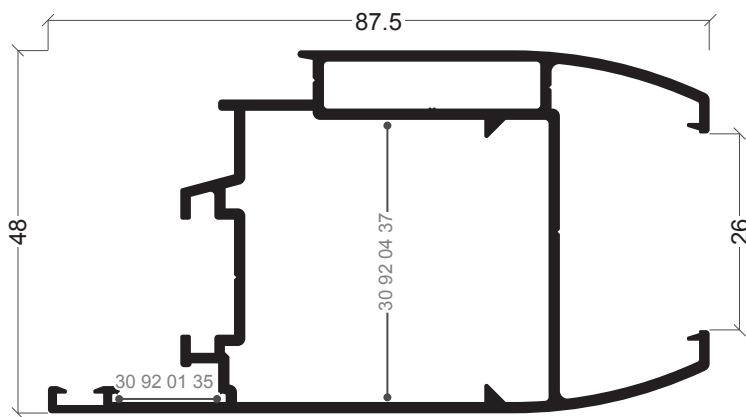

AZ-72
Aro móvel

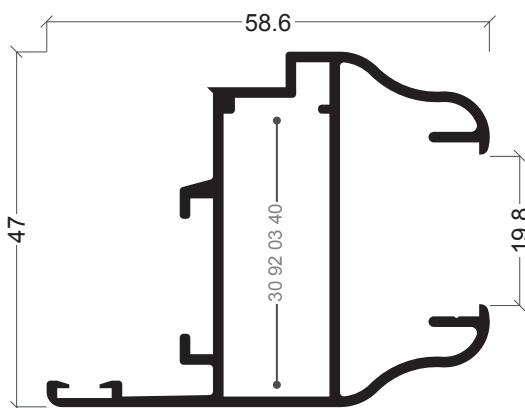

AZ-41
Aro móvel

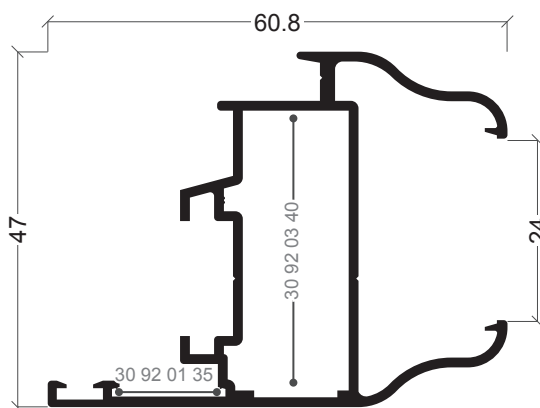

AZ-52
Aro móvel

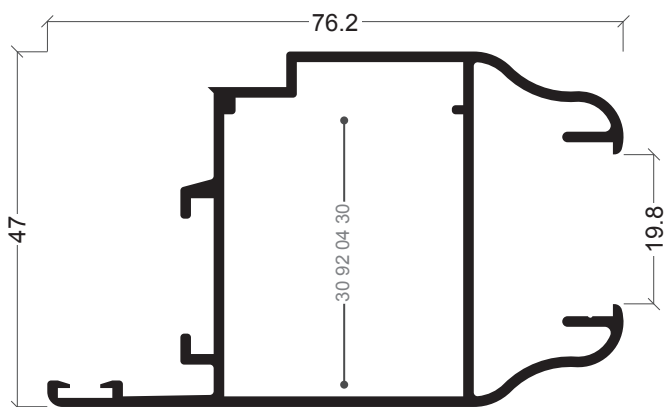

AZ-42
Aro móvel

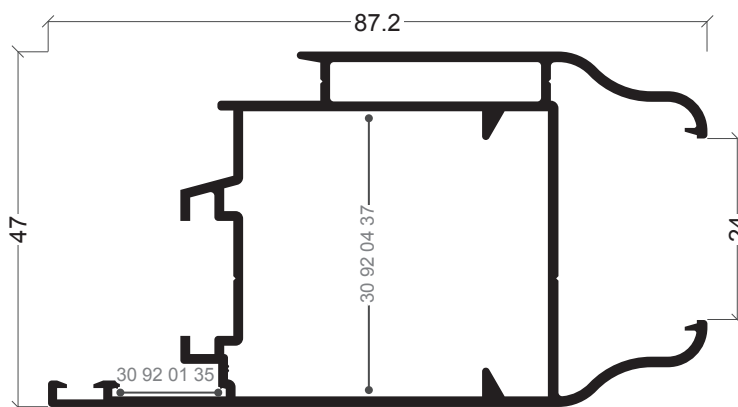

AZ-53
Aro móvel

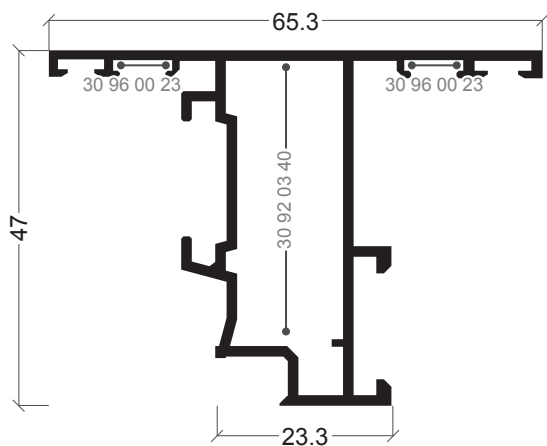

AZ-68
Aro móvel abertura.exterior

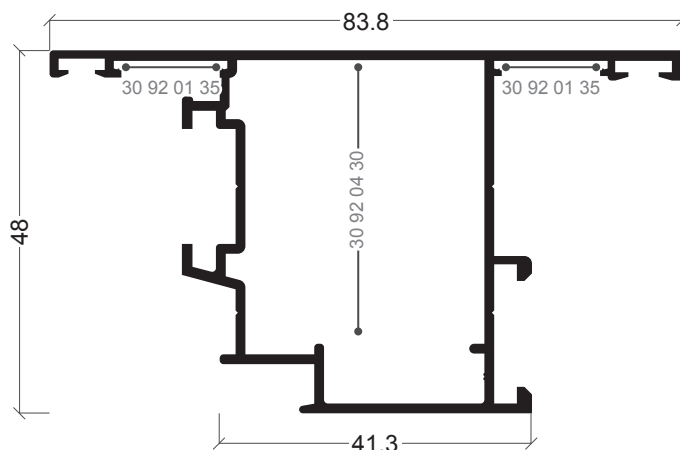

AZ-63
Aro móvel abertura.exterior

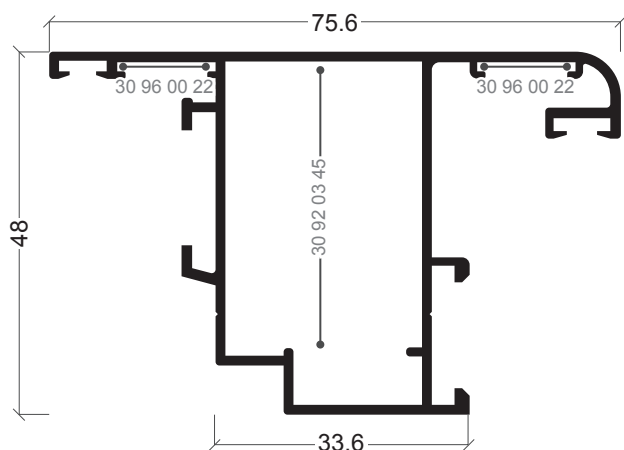

AZ-15
Aro móvel abertura.exterior

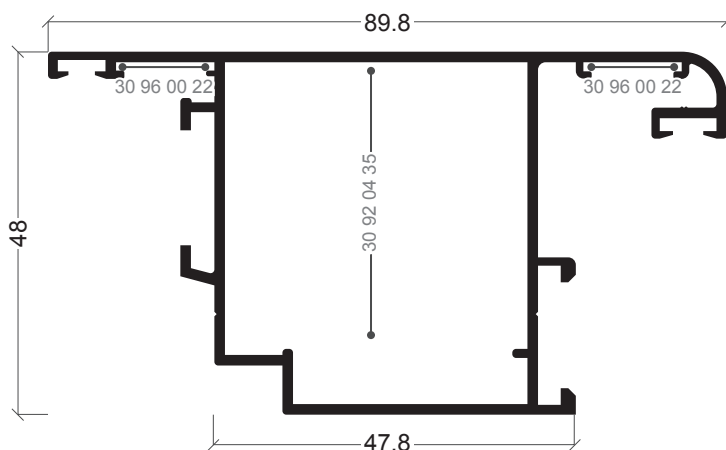

AZ-14
Aro móvel abertura.exterior

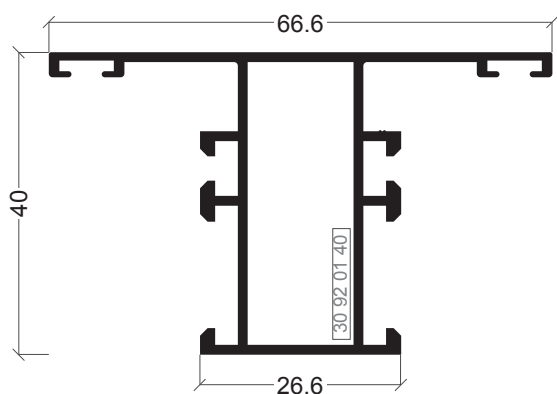

AZ-01
Travessa

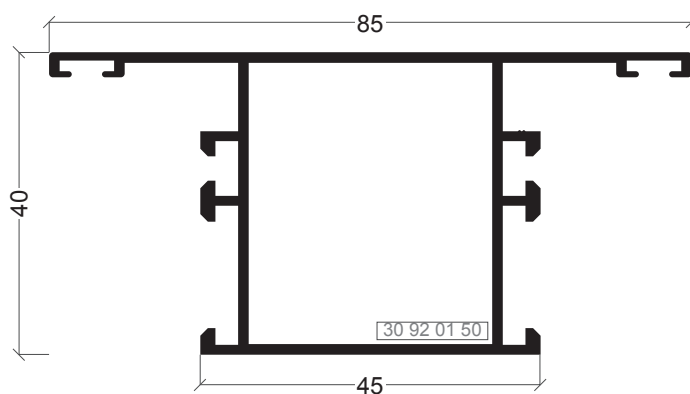

AZ-09
Travessa

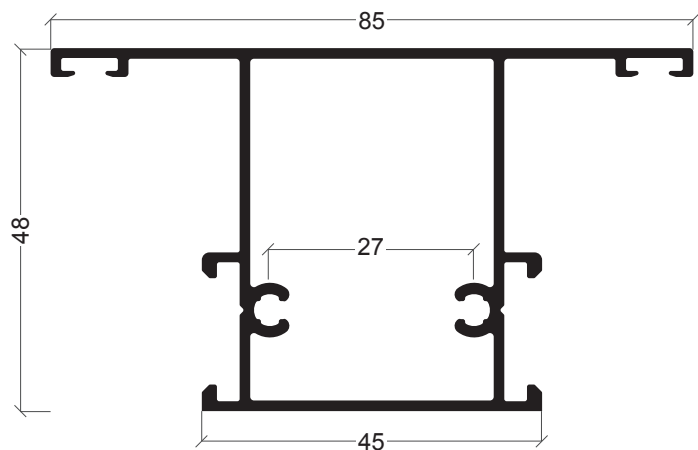

AZ-78
Travessa AZ-62/63/67

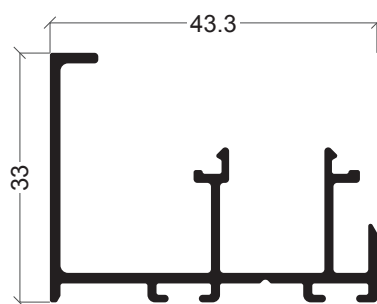

AZ-75
Remate almofada

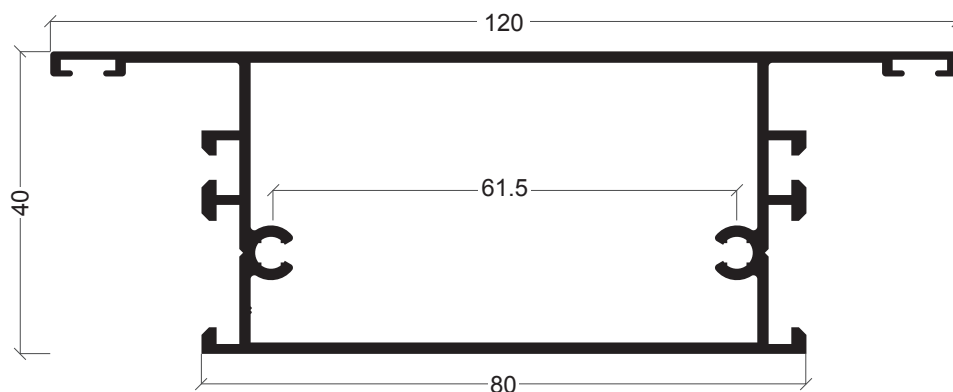

AZ-12
Travessa

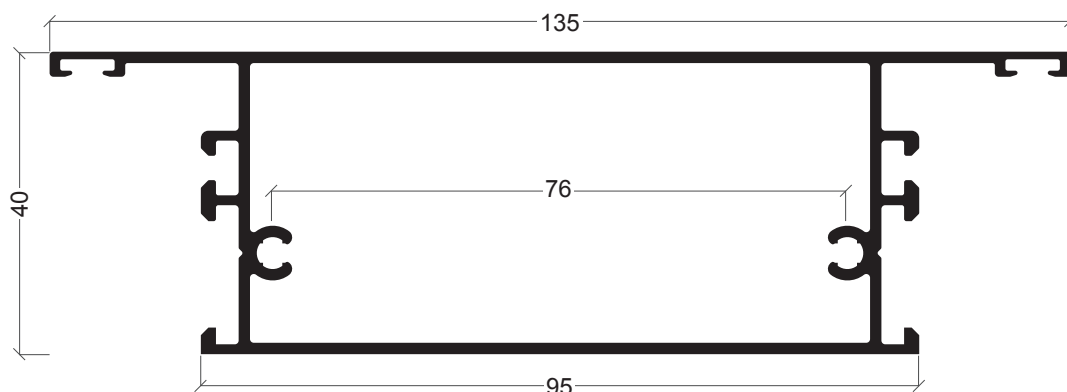

AZ-73
Travessa

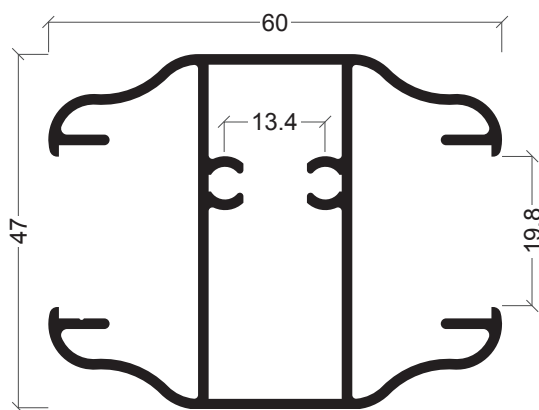

AZ-45
Travessa

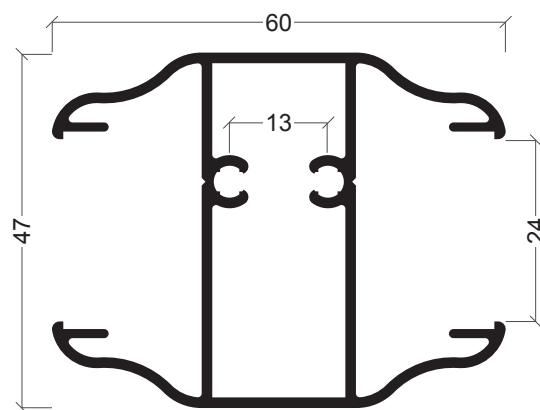

AZ-56
Travessa

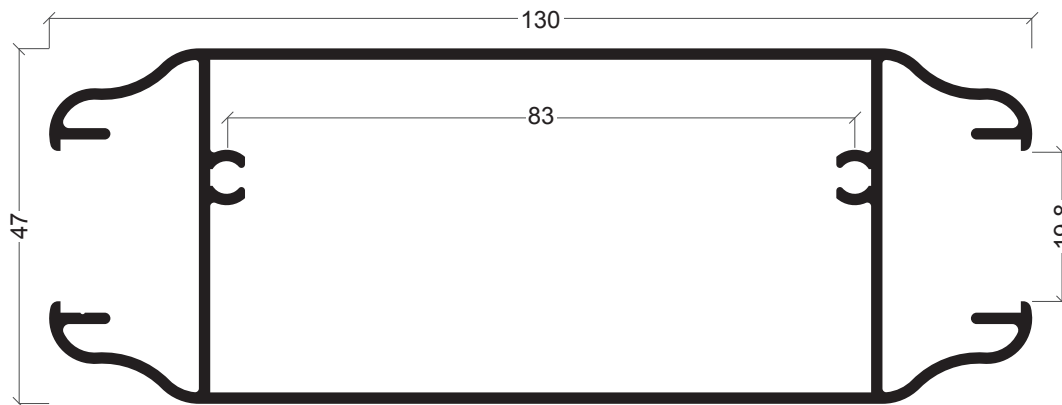

AZ-43
Travessa

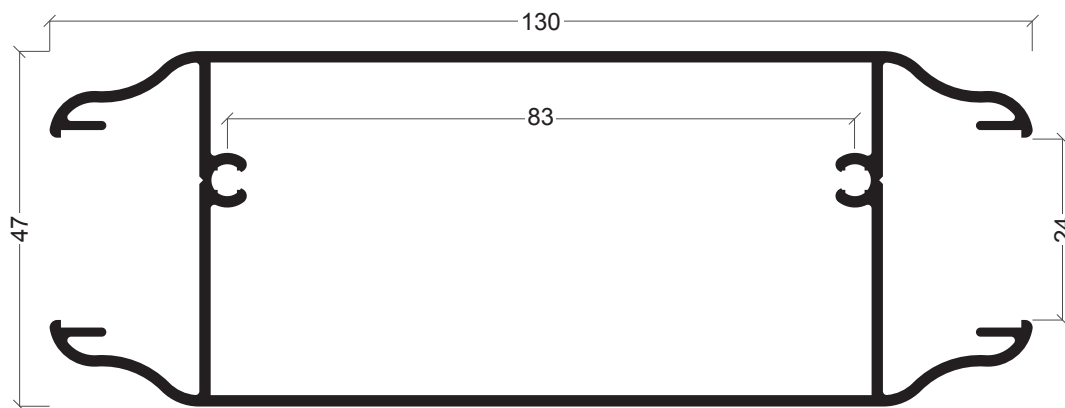

AZ-54
Travessa

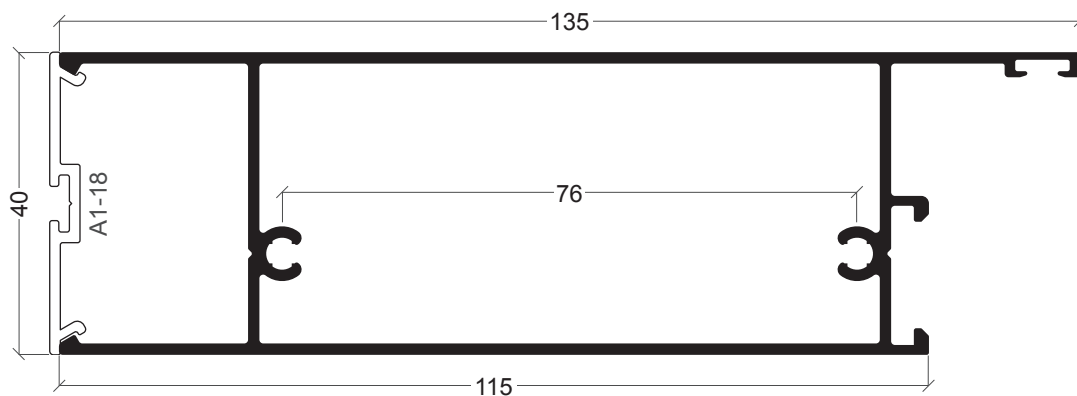

AZ-74
Almofada

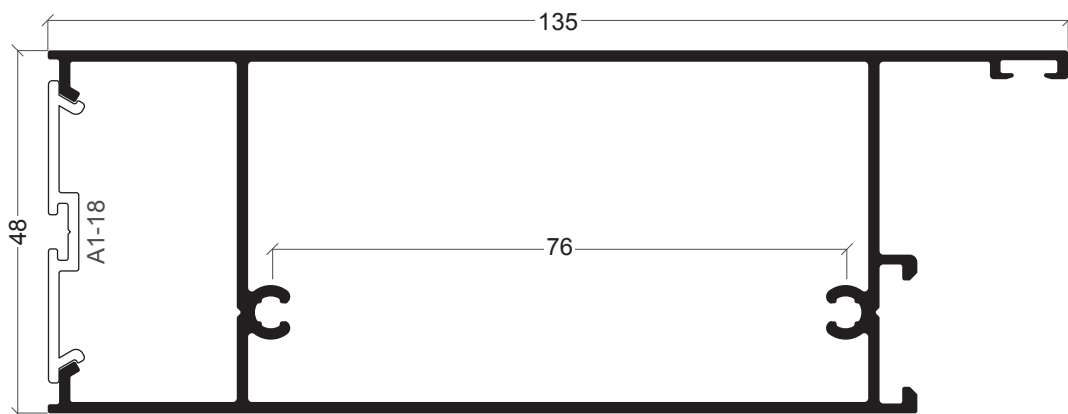

AZ-77
Almofada

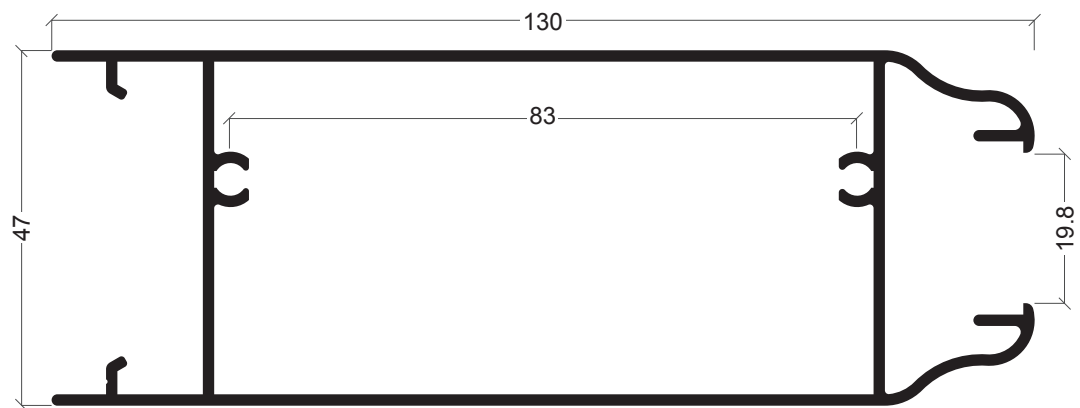

AZ-44
Alufada

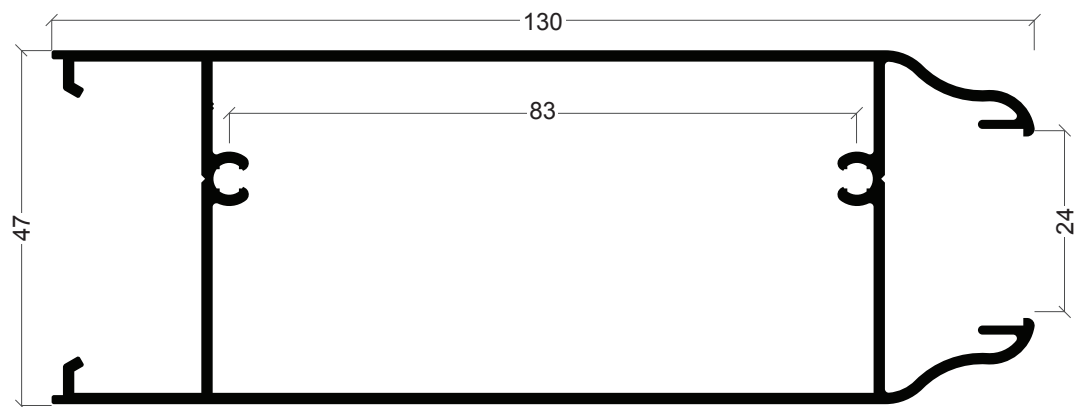

AZ-55
Alufada

216

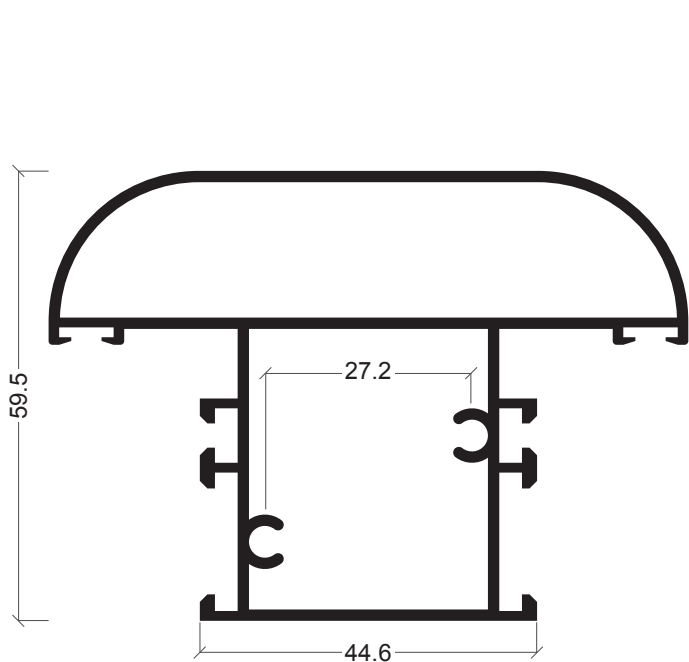

AZ-49
Travessa

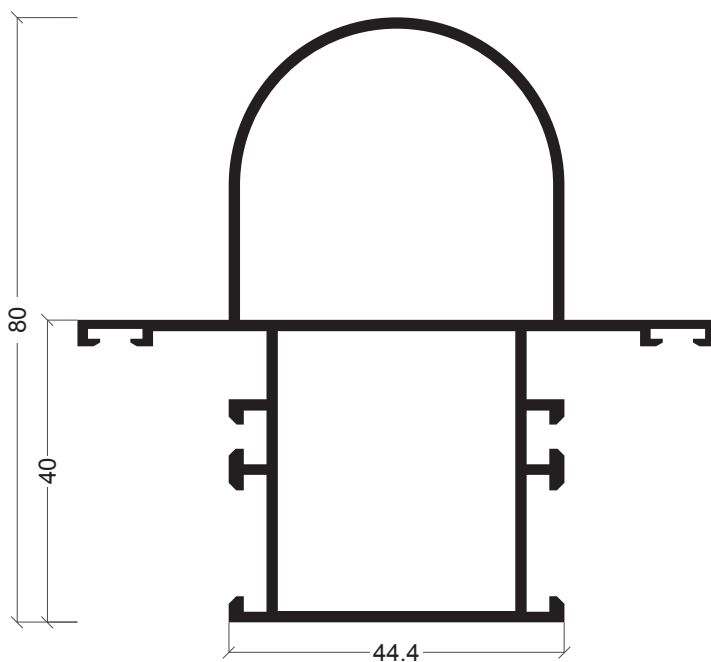

AZ-57
Montante

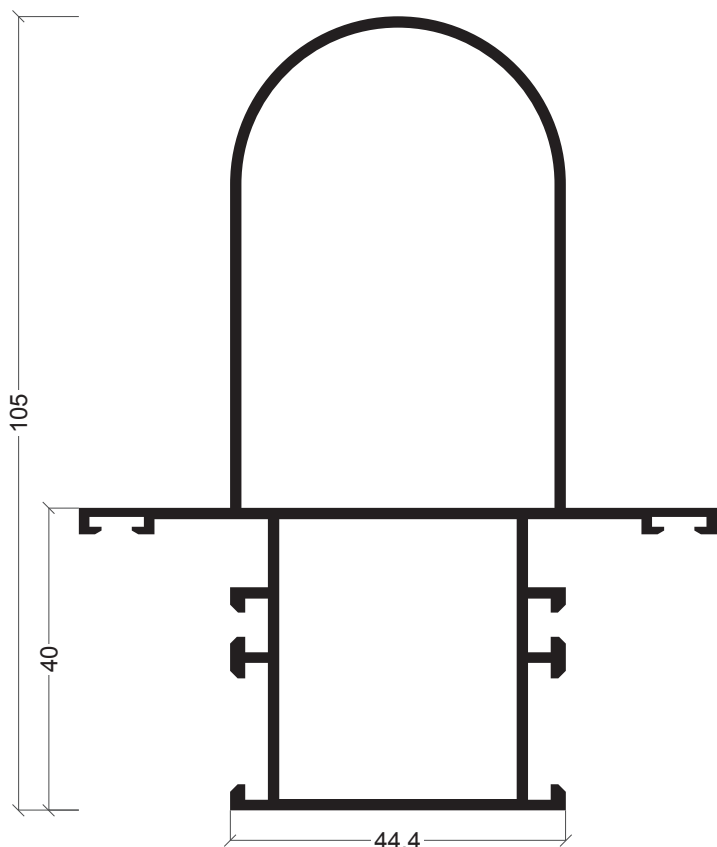

AZ-58
Montante

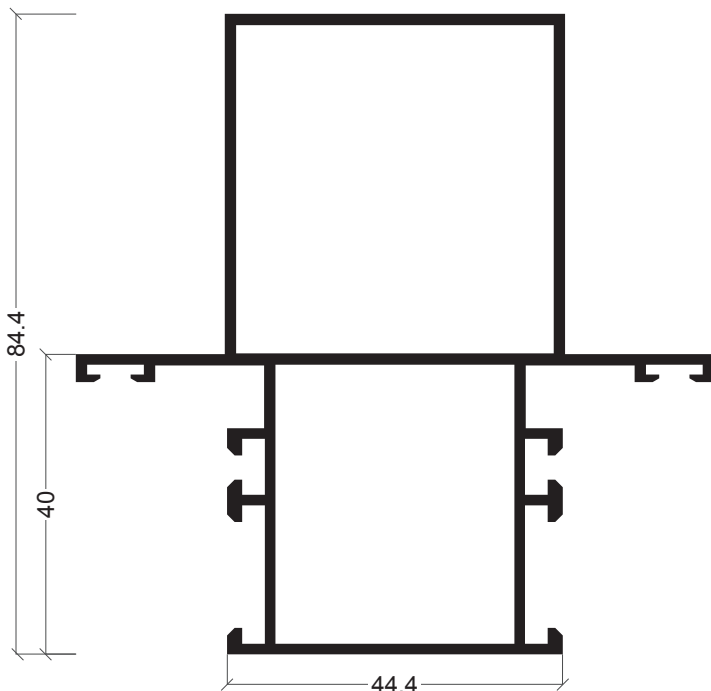

AZ-64
Montante

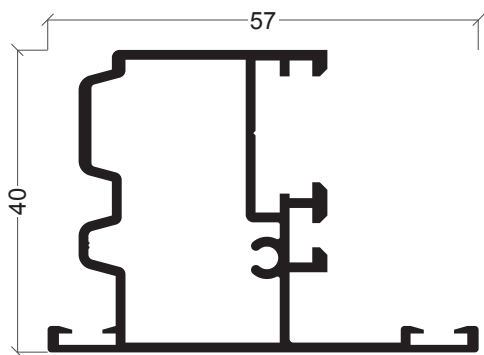

AZ-04
Inversor

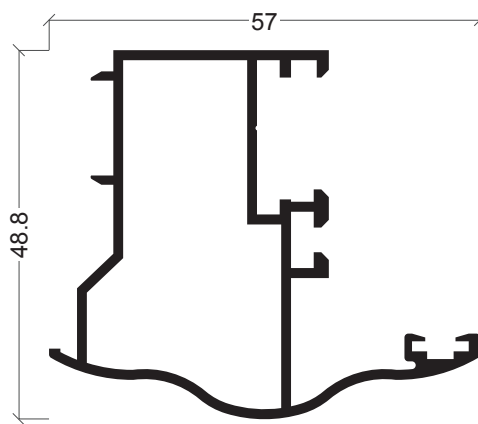

AZ-65
Inversor

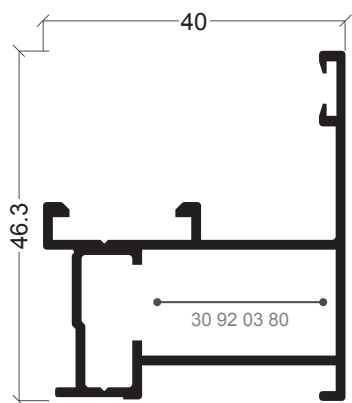

AZ-76
Inversor sentido de abertura

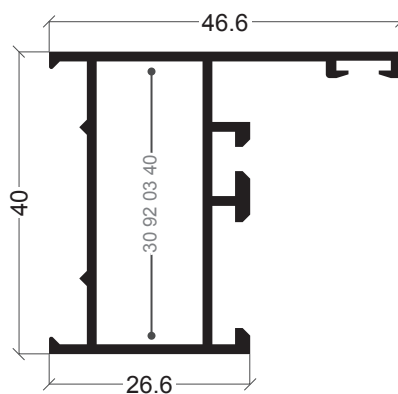

AZ-16
Aro fixo pivotante

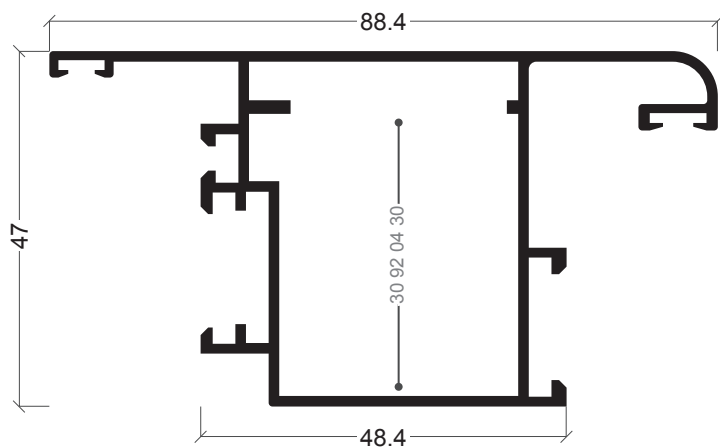

AZ-17
Aro móvel pivotante

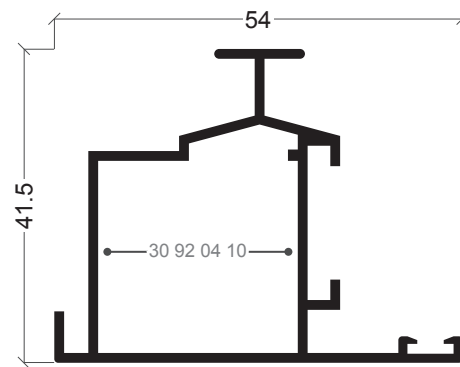

AZ-18
Inversor pivotante

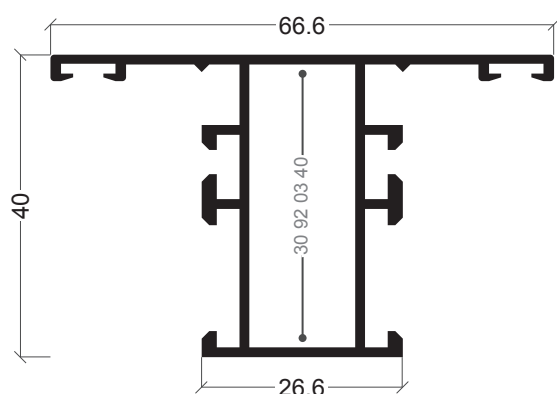

AZ-31
Travessa pivotante

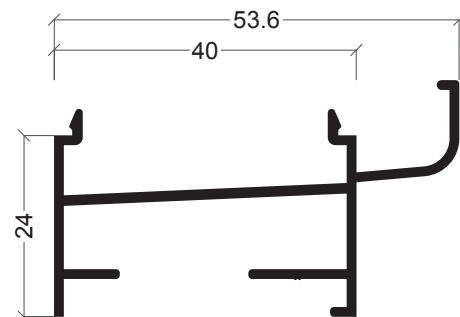

AZ-19
Soleira condensação

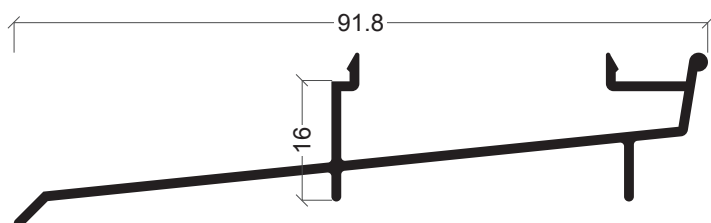

AZ-26
Soleira condensação

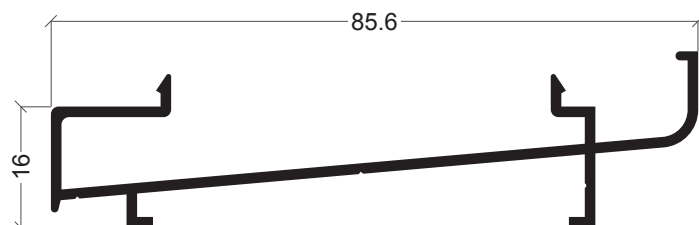

AZ-66
Soleira condensação

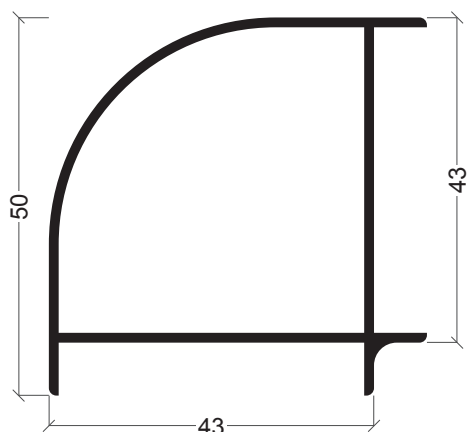

AZ-25
Canto 90°

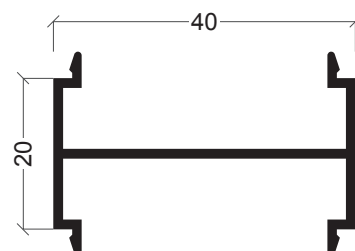

AZ-20
União de aros

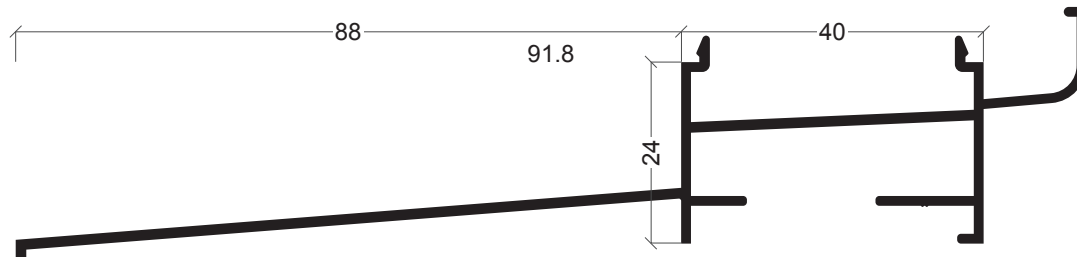

AZ-80
Soleira condensação

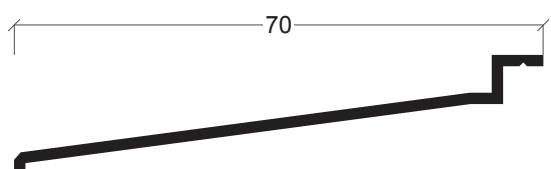

AZ-23
Pingadeira 60 mm

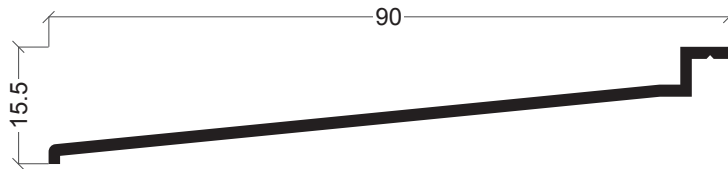

AZ-30
Pingadeira

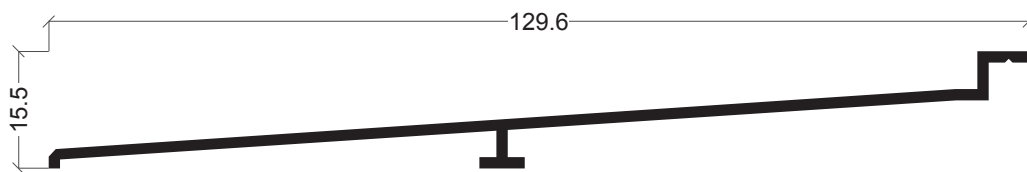

AZ-24
Pingadeira

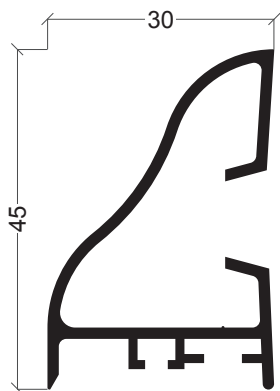

AZ-70
Pingadeira

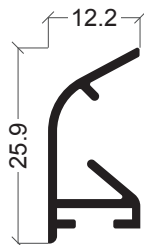

AZ-60
Pingadeira



AZ-61
Clip pingadeira

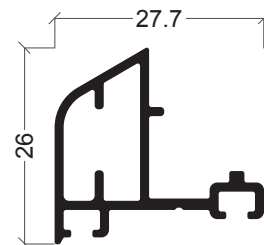

AZ-79
Pingadeira

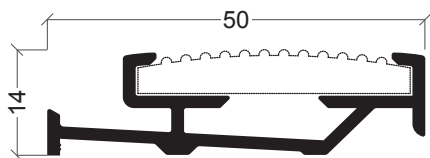

AZ-69
Remate inferior porta

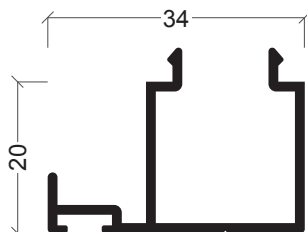

AZ-59
Bite de remate

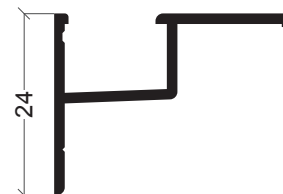

Y-20
Recolha de águas condensação

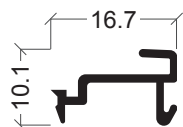

AX-33
Mola bite



AX-19
Vareta

PORTADAS

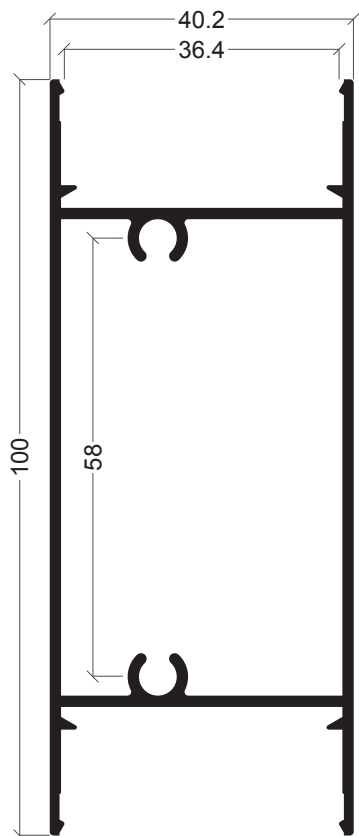

AZ-37
Travessa

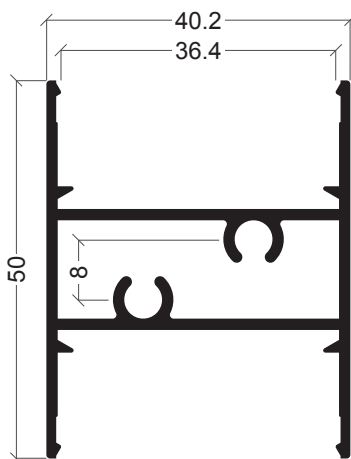

AZ-47
Travessa

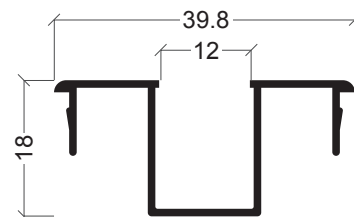

AZ-38
Remate lâmina

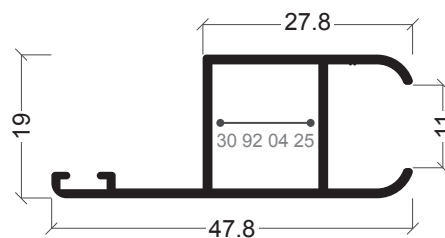

AZ-22
Aro móvel portada interior

220

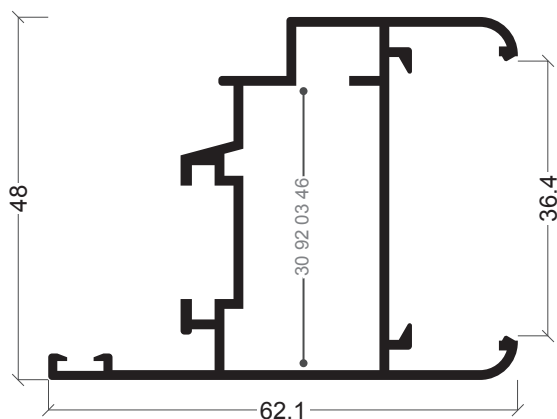

AZ-35
Aro móvel

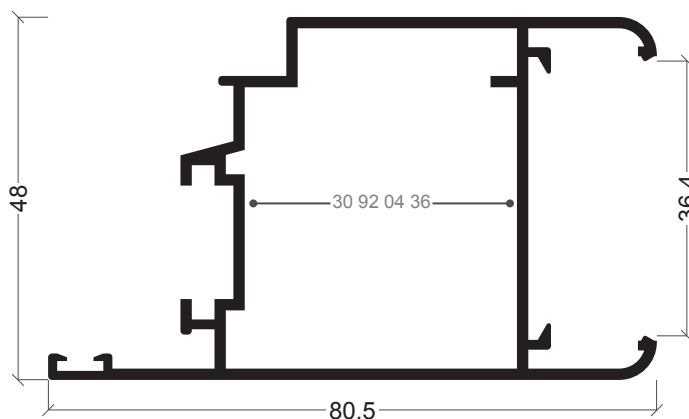

AZ-36
Aro móvel

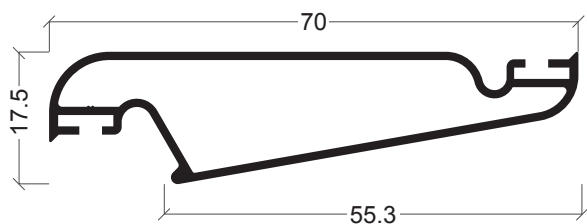

Z-53
Lâmina móvel

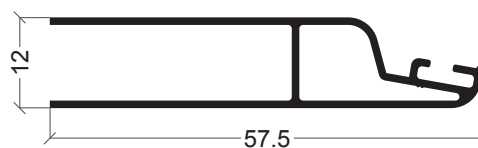

Z-54
Meia lâmina

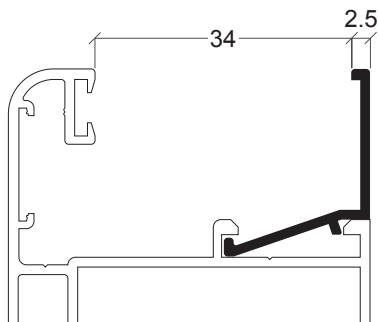

AX-69

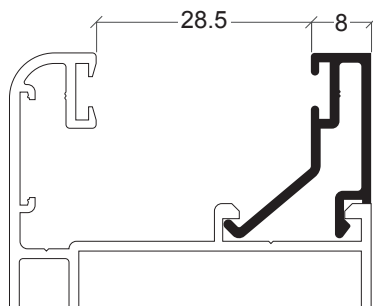

AX-74

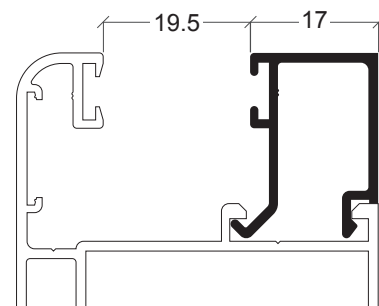

AX-46

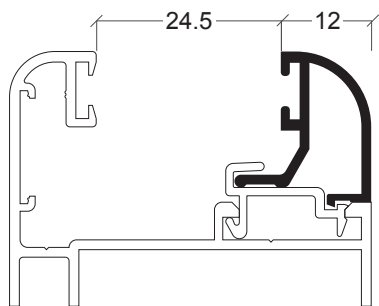

AX-37

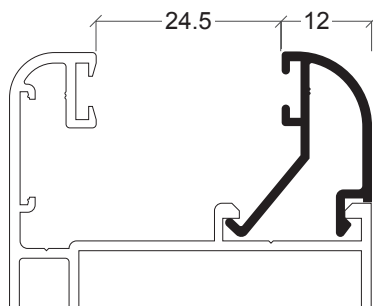

AZ-08

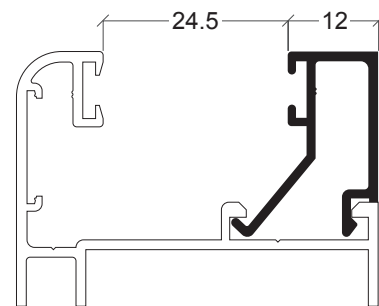

AX-36

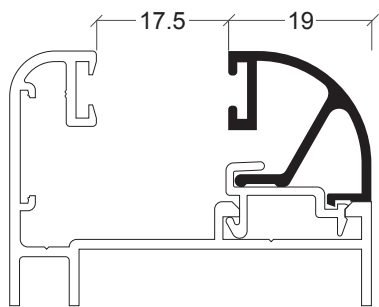

AX-30

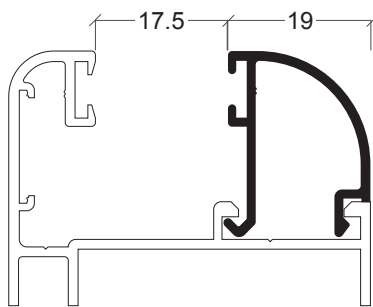

AZ-07

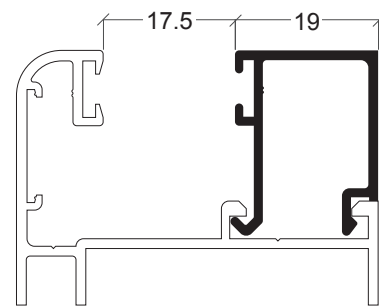

AX-35

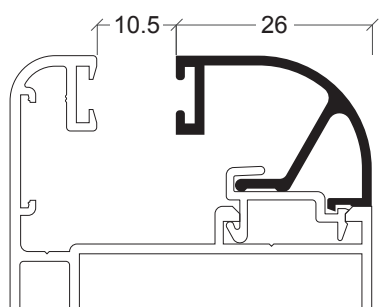

AX-29

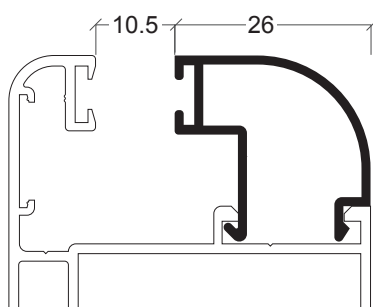

AZ-06

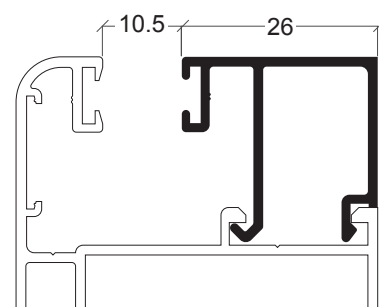

AX-31

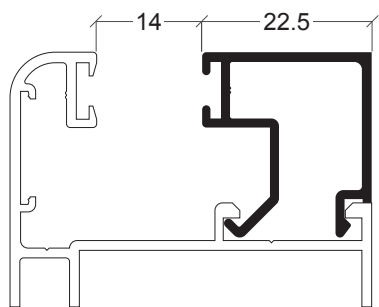

AX-78

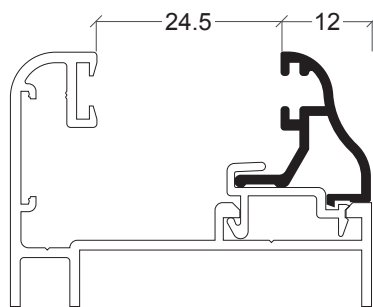

AX-72

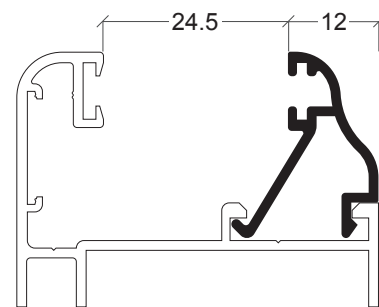

AX-73

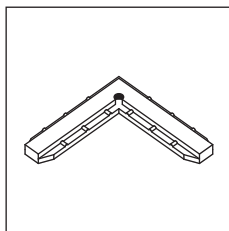

30 21 20 07
Esquadro alinhamento

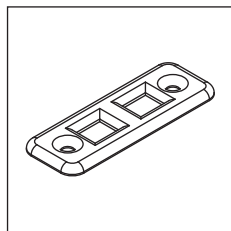

30 24 30 75
Contra-fecho duplo inferior inox

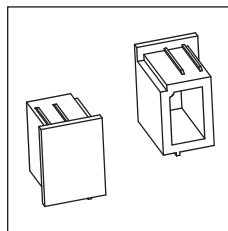

30 91 21 20
Jogo topos condensação para Y-20

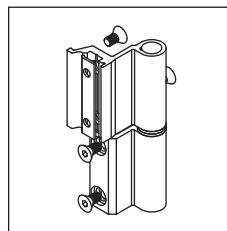

30 92 00 20/21
Dobradiça C.E. branco/preto

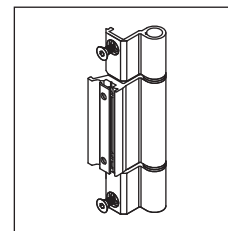

30 92 00 26/27/28
Dobradiça três nós (bruto/branco/preto)

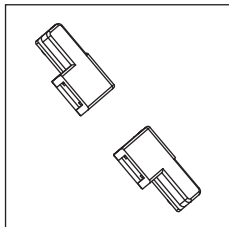

30 92 00 30
Transmissão barra cremone

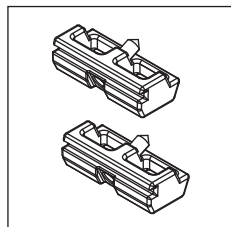

30 92 00 50
Contra-fecho

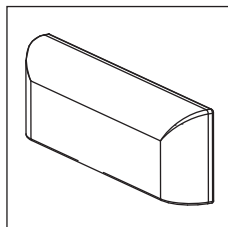

30 92 01 00/01
Goteira preto/branco

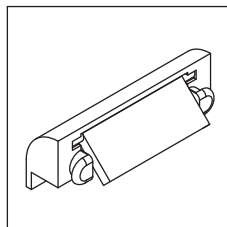

30 92 01 02/03
Goteira preto/branco

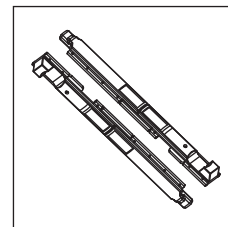

30 92 01 20
Jogo fecho C.E.

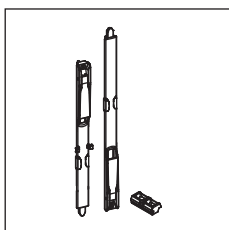

30 92 01 21
Jogo fecho C.E. Zamack

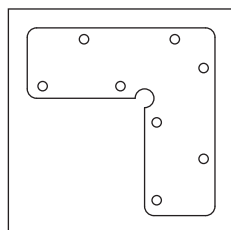

30 92 01 35
Esquadro alinhamento aro móvel

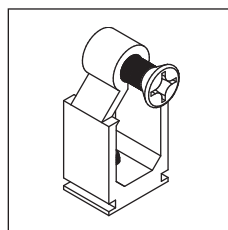

30 92 01 40
União topos janela

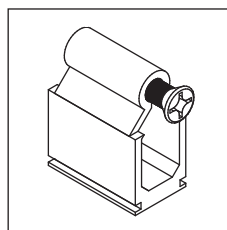

30 92 01 50
União topos porta

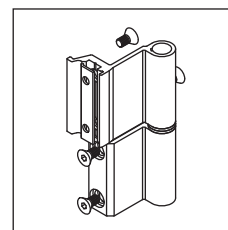

30 92 01 70/80
Dobradiça 3 folhas branco/preto

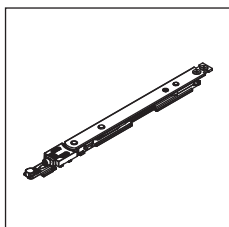

30 92 02 10/11/12
Compasso oscilo 300/400/500

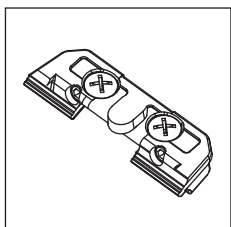

30 92 02 15
Fecho para micro-ventilação

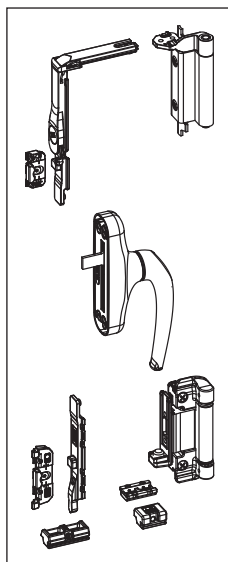

30 92 02 20/21
Kit oscilo-batente branco/preto

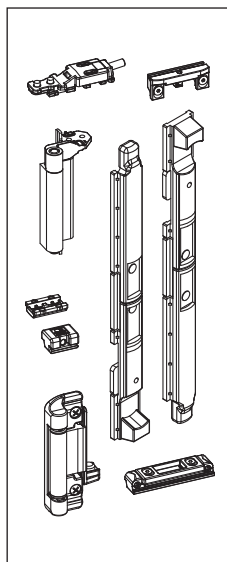

30 92 02 24/25
Kit 2ª folha oscilo-batente branco/preto

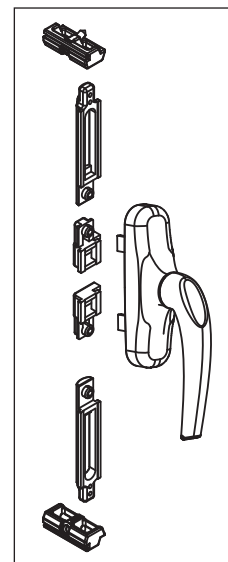

30 92 03 10/11
Kit cremone branco/preto

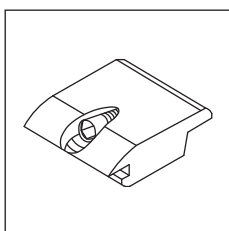

30 92 02 60
Apoyo da folha

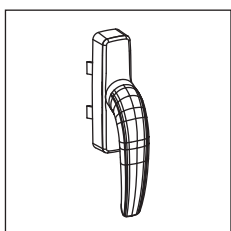

30 92 03 20/21
Cremone abertura exterior branco/preto

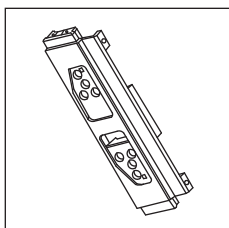

30 92 03 30
Jogo transmissão abertura exterior

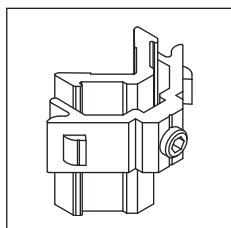

30 92 03 40
Esquadro janela

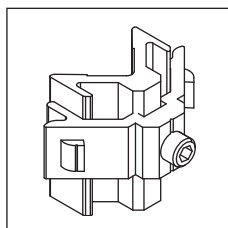

30 92 03 42
Esquadro AZ-32

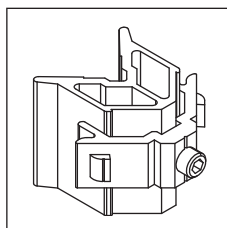

30 92 03 45
Esquadro AZ-15

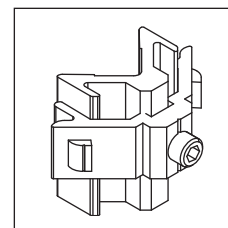

30 92 03 46
Esquadro AZ-35

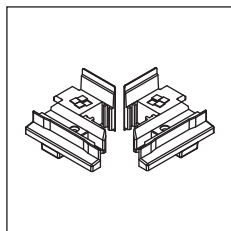

30 92 03 51

Jogo topos inversor
AZ-4

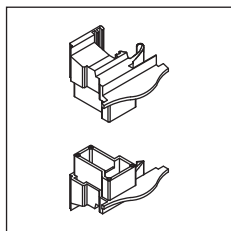

30 92 03 55

Jogo topos inversor
AZ-65

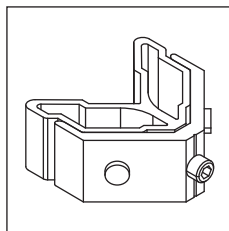

30 92 04 10

Esquadro AZ-18

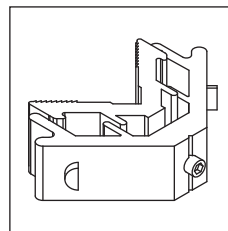

30 92 04 25

Esquadro AZ-22

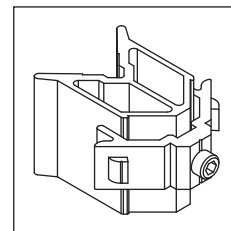

30 92 04 30

Esquadro porta

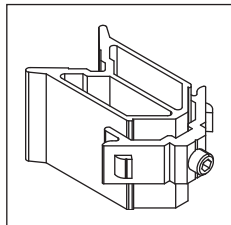

30 92 04 35

Esquadro AZ-14

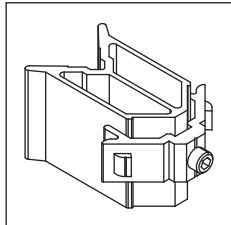

30 92 04 36

Esquadro AZ-36

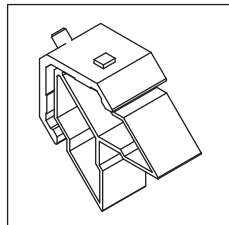

30 92 04 37

Esquadro AZ-53/72

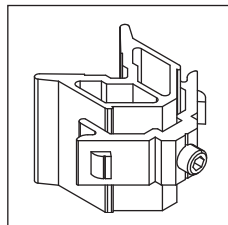

30 92 04 42

Esquadro aro porta AZ
tradição

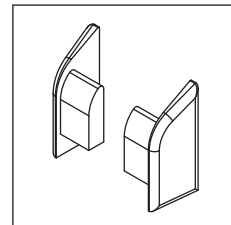

30 92 05 00

Jogo topos AZ-60

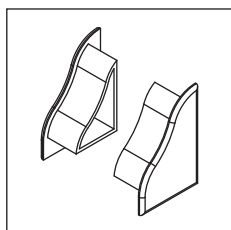

30 92 05 01

Jogo topos AZ-70

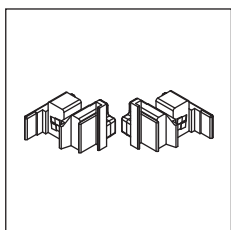

30 92 05 05

Jogo topos AZ-75

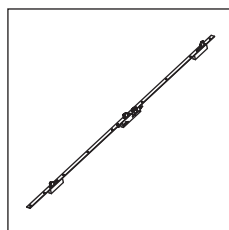

30 92 05 10

Fechadura 3 pontos

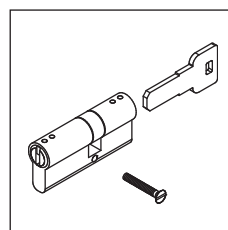

30 92 05 40

Canhão fechadura

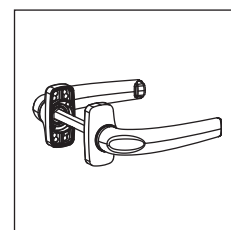

30 92 05 60/61

Puxador duplo branco/
preto

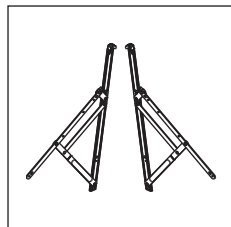

30 92 06 00

Compasso projectante
deslizante

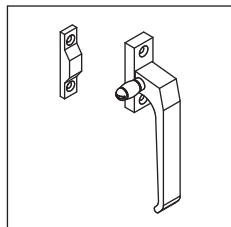

30 92 06 10/11

Cremona de lingueta
branco/preto

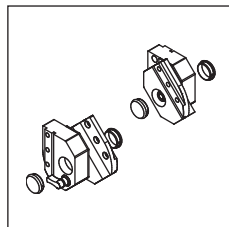

30 92 07 10/11

Jogo pivotante preto/
branco (60kg)

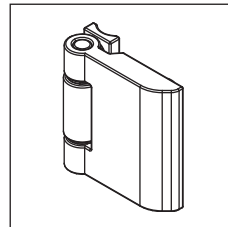

30 92 08 20/21

Dobradiça AZ-22 branco/
preto

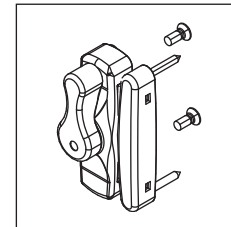

30 92 08 30/31

Fecho veda luz branco/
preto

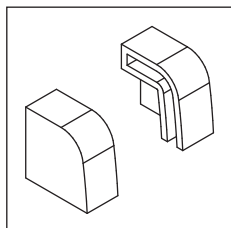

30 96 00 12

Jogo topos condensação
soleira

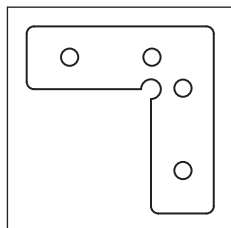

30 96 00 22

Esquadro alinhamento
especial

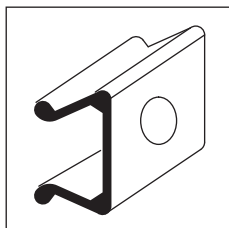

31 03 40 00



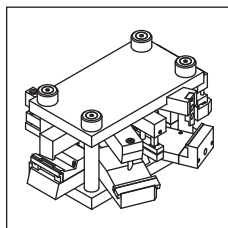

















Mola para AZ-60



33 96 79 99

Cunho C.E.



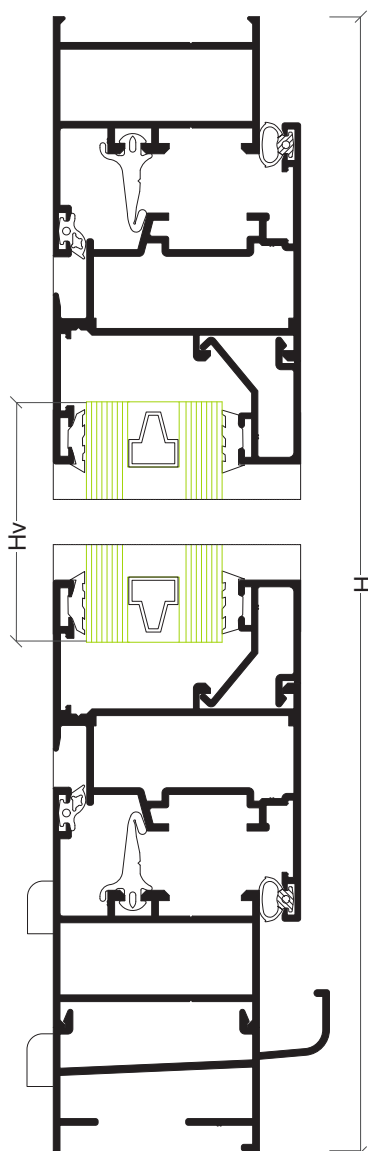
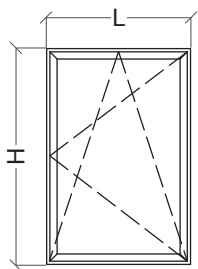

Porta-lâminas para caixa de 36 mm					
Referência	Nº de lâminas	Altura mínima de corte (mm)	Altura nominal (mm)	Altura janela (mínimo)	Altura janela (máximo)
30 92 09 40	6	400	460	570	630
30 92 09 41	7	460	520	630	690
30 92 09 42	8	520	580	690	750
30 92 09 43	9	580	640	750	810
30 92 09 44	10	640	700	810	870
30 92 09 45	11	700	760	870	930
30 92 09 46	12	760	820	930	990
30 92 09 47	13	820	880	990	1050
30 92 09 48	14	880	940	1050	1110
30 92 09 49	15	940	1000	1110	1170
30 92 09 50	16	1000	1060	1170	1230
30 92 09 51	17	1060	1120	1230	1290
30 92 09 52	18	1120	1180	1290	1350
30 92 09 53	19	1180	1240	1350	1410
30 92 09 54	20	1240	1300	1410	1470
30 92 09 55	21	1300	1360	1470	1530
30 92 09 56	22	1360	1420	1530	1590
30 92 09 57	23	1420	1480	1590	1650
30 92 09 58	24	1480	1540	1650	1710
30 92 09 59	25	1540	1600	1710	1770

Referência	Desenho	Descrição
30 00 95 15		Junta vedação inferior curta AZ-70/79
30 60 00 17		Junta exterior vidro plana 2 mm preto
30 92 04 70		Espuma isolante
30 93 00 50		Junta central
30 93 00 60		Vedante exterior de vidro (opcional)
30 93 00 62		Junta exterior plana
30 93 00 65		Junta interior para vidro 5 mm
30 93 00 66		Junta interior para vidro 4 mm
30 93 00 67		Junta interior para vidro 2 mm
30 93 00 68		Junta interior para vidro 6/7 mm
30 93 00 69		Junta interior para vidro 8/9 mm
30 93 00 70		Vedante interior de vidro (opcional)
30 93 00 81		Junta vedação inferior A1-18
30 93 00 82		Junta vedação inferior AZ-70/79
30 93 00 90		Junta exterior
30 93 01 20		Junta interior
30 93 01 40		Junta lâminas
30 94 01 46		Junta para veda-luz AZ-22
30 95 00 10		Pelúcia 7x9 mm
30 95 00 40		Pelúcia 7x5.5 mm

Janela 1 folha abrir e oscilo-batente

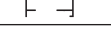

Perfis

Desenho	Ref	Descrição	Corte	Quant	Medida
	AZ-03	Aro fixo		2	L
				2	H-24 mm
	AZ-67	Aro móvel		2	L-41 mm
				2	H-65 mm
	---	Bíte		2	L-133.5 mm
				2	H-197.5 mm
	AX-19	Vareta		2	Apro. H/2 mm
	AZ-19	Soleira de condensação		1	L

Acessórios e Juntas

Referência	Descrição	Quantidade	
		Abrir	Oscilo-batente
30 92 00 20	Dobradiças C.E.	2	---
30 92 01 00	Goteiras	2	2
30 92 01 35	Esquadro alinhamento aro móvel	4	4
30 92 02 (xx)	Compasso O.B.	---	1
30 92 02 20	Kit oscilo-batente	---	1
30 92 02 60	Apoio da folha	1	---
30 92 03 10	Kit cremone	1	---
30 92 03 40	Esquadro janela	8	8
30 96 00 12	Jogo topos condensação	1	1
30 93 00 50	Junta central	2L+2H	
30 93 00 90	Junta exterior	2L+2H	
30 93 01 20	Junta interior	2L+2H	
---	Junta exterior vidro	2L+2H	
---	Junta interior vidro	2L+2H	

225

Vidro



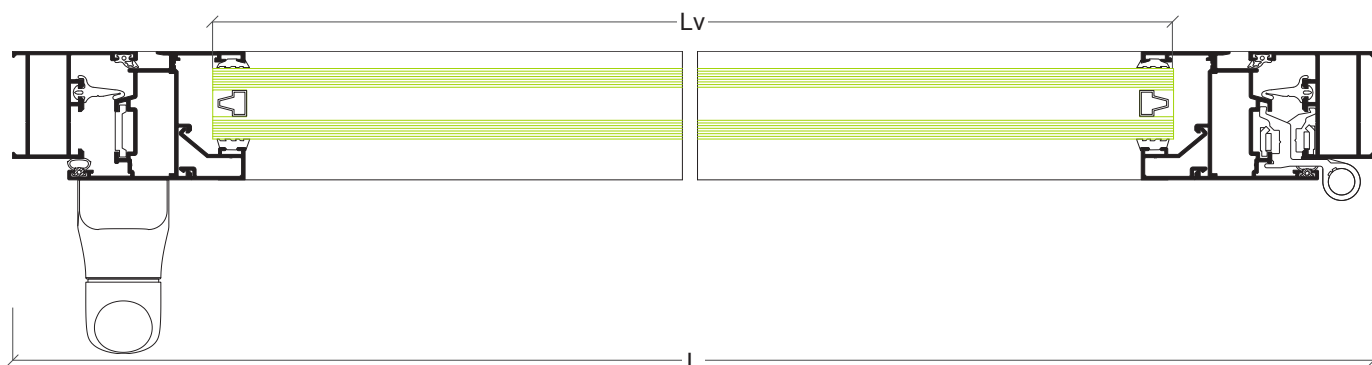



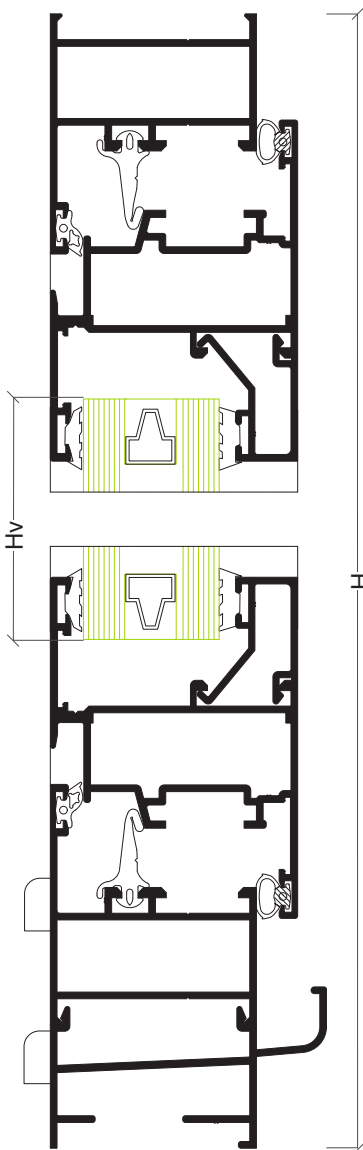
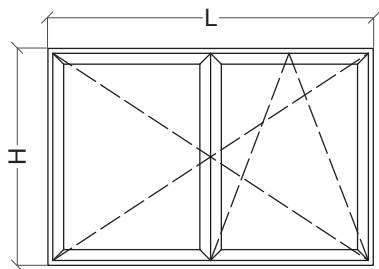

Hv = H-171 mm	Lv = L-147 mm
---------------	---------------

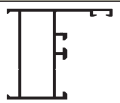

Janela 2 folhas abrir e oscilo-batente

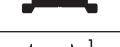

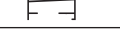
Perfis

Desenho	Ref	Descrição	Corte	Quant	Medida
	AZ-03	Aro fixo		2	L
				2	H-24 mm
	AZ-67	Aro móvel		4	L/2-23 mm
				4	H-65 mm
	AZ-04	Inversor		1	H-133 mm
	---	Bite		4	L/2-115.5 mm
				4	H-197.5 mm
	AX-19	Vareta		2	Apro. H/2 mm
	AZ-19	Soleira de condensação		1	L

Acessórios e Juntas

Referência	Descrição	Quantidade	
		Abrir	Oscilo-batente
30 92 00 20	Dobradiças C.E.	4	---
30 92 01 00	Goteiras	2	2
30 92 01 20	Jogo fecho C.E.	1	---
30 92 01 35	Esquadro alinhamento aro móvel	8	8
30 92 02 (xx)	Compasso O.B.	---	1
30 92 02 20	Kit oscilo-batente	---	1
30 92 02 24	Kit 2ª folha oscilo-batente	---	1
30 92 02 60	Apoio da folha	1	1
30 92 03 10	Kit cremone	1	---
30 92 03 40	Esquadro janela	12	12
30 92 03 51	Jogo topos inversor	1	1
30 96 00 12	Jogo topos condensação	1	1
30 93 00 50	Junta central	2L+3H	
30 93 00 90	Junta exterior	2L+4H	
30 93 01 20	Junta interior	2L+4H	
---	Junta exterior vidro	2L+4H	
---	Junta interior vidro	2L+4H	

Vidro

Hv = H-171 mm	Lv = L/2-129 mm
---------------	-----------------

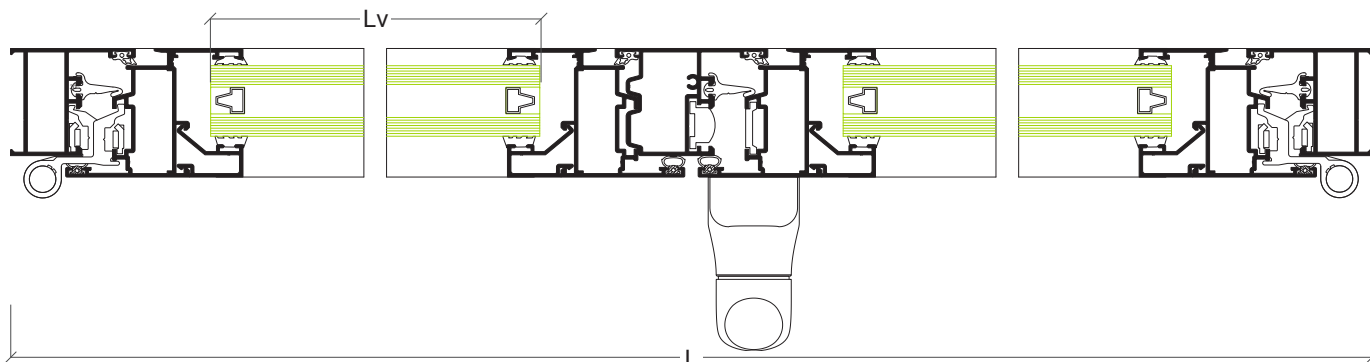

Janela 1 folha projectante

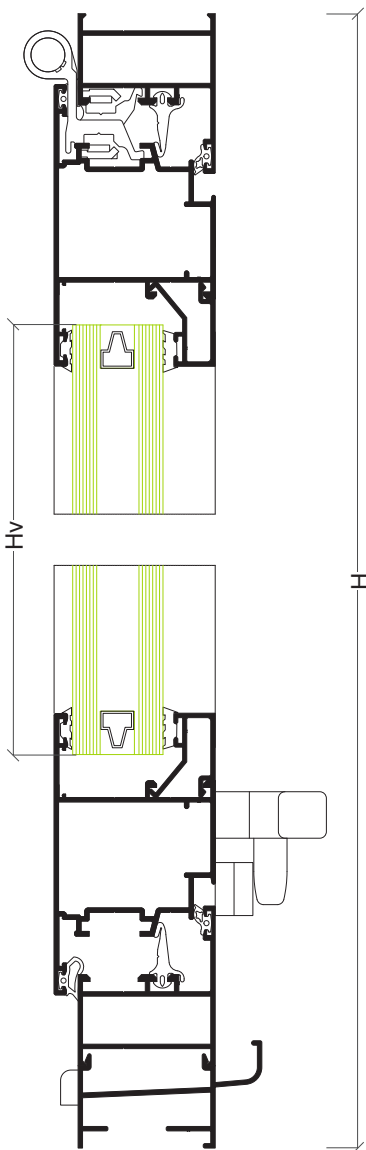
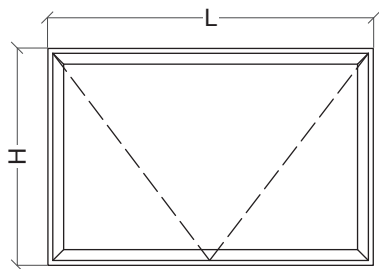

Perfis

Desenho	Ref	Descrição	Corte	Quant	Medida
	AZ-03	Aro fixo		2	L
				2	H-24 mm
	AZ-63	Aro móvel		2	L-41 mm
				2	H-65 mm
	---	Bite		2	L-168.5 mm
				2	H-192.5 mm
	AX-19	Vareta		2	Apro. H/2 mm
	AZ-19	Soleira de condensação		1	L

Acessórios e Juntas

Referência	Descrição	Quantidade
30 92 00 20	Dobradiças C.E.	2
30 92 01 00	Goteiras	2
30 92 03 40	Esquadro janela	4
30 92 04 30	Esquadro móvel	4
30 92 04 85	Jogo compassos projectante	1
30 92 06 10	Cremona de lingueta	2
30 96 00 12	Jogo topos condensação	1
30 92 01 35	Esquadro alinhamento	8
30 93 00 90	Junta interior	2L+2H
30 93 01 30	Junta exterior	2L+2H
---	Junta exterior vidro	2L+2H
---	Junta interior vidro	2L+2H

227

Vidro



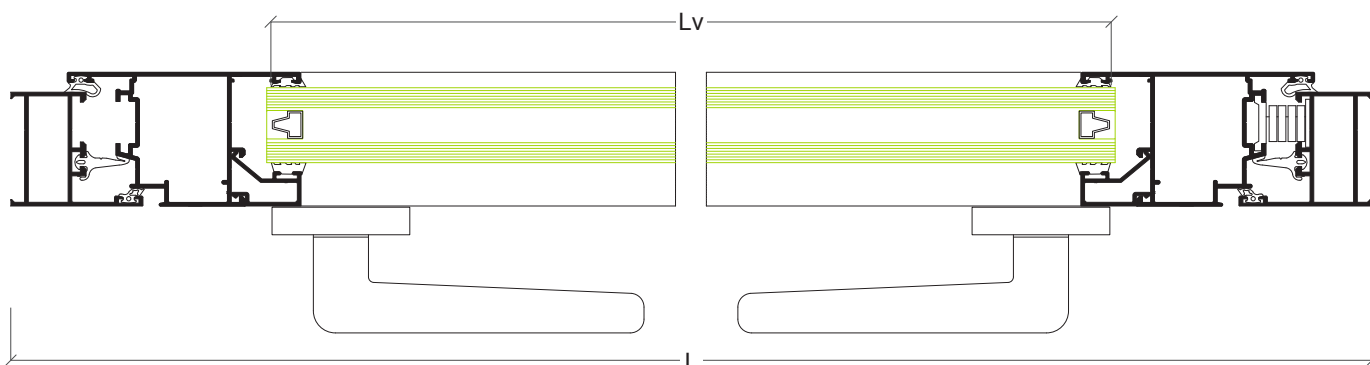



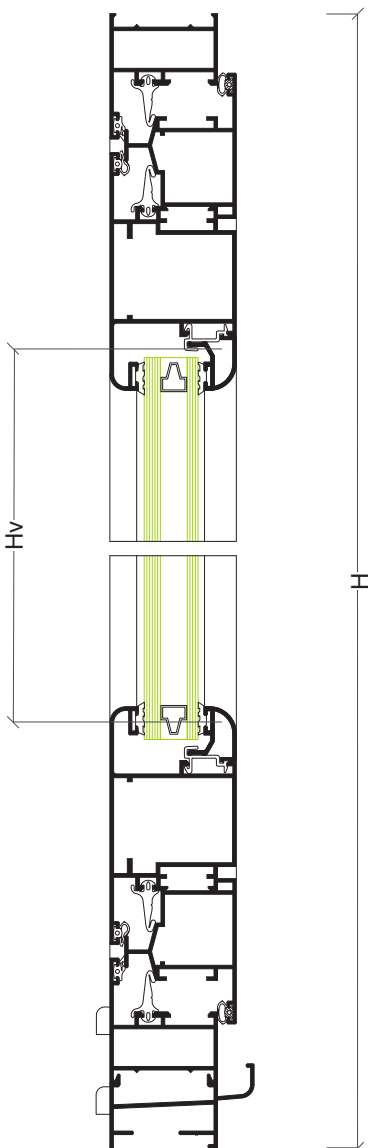
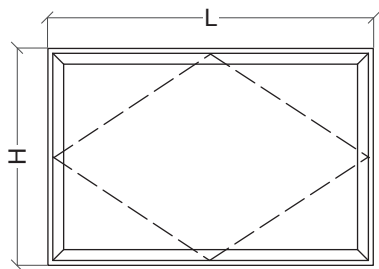



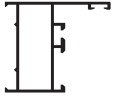

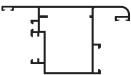

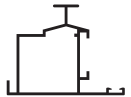
Hv = H-206 mm	Lv = L-182 mm
---------------	---------------

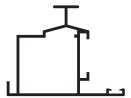

Janela pivotante horizontal



Perfis

Desenho	Ref	Descrição	Corte	Quant	Medida
	AZ-16	Aro fixo pivotante		2	L
				2	H-24 mm
	AZ-17	Aro móvel pivotante		2	L-104 mm
				2	H-128 mm
	AZ-18	Inversor pivotante superior		1	L-45 mm
				2	H/2-12 mm
	AZ-18	Inversor pivotante inferior		1	L-45 mm
				2	H/2+12 mm
	---	Bite redondo		2	L-240 mm
	---	Bite redondo clip		2	H-255 mm
	AX-33	Mola bite		A cada 300 mm	80 mm
	AZ-19	Soleira de condensação		1	L

Acessórios e Juntas

Referência	Descrição	Quantidade
30 92 01 00	Goteiras	4
30 92 03 40	Esquadro janela	4
30 92 04 10	Esquadro AZ-18	4
30 92 04 30	Esquadro porta	4
30 92 07 10	Jogo pivotante	1
30 96 00 12	Jogo topos condensação	1
30 92 06 11	Cremona de lingueta	2
30 93 00 50	Junta central	4L+4H
30 93 00 90	Junta exterior	2L+2H
30 93 01 20	Junta interior	4L+4H
---	Junta exterior vidro	2L+2H
---	Junta interior vidro	2L+2H

Vidro

Hv = H-278 mm	Lv = L-254 mm
---------------	---------------

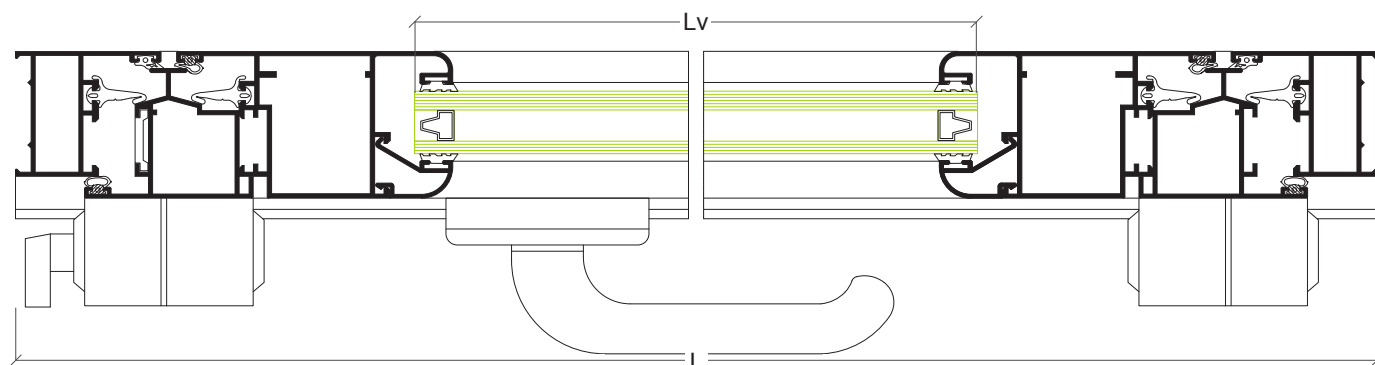

Porta 1 folha

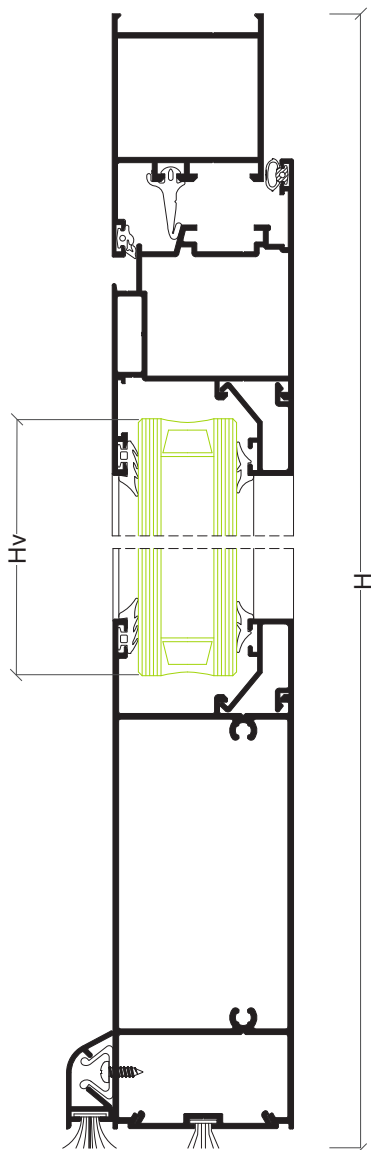
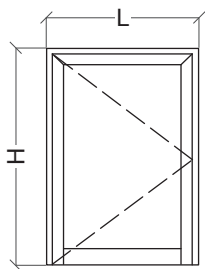

Perfis

Desenho	Ref	Descrição	Corte	Quant	Medida
	AZ-11	Aro fixo		1	L
				2	H
	AZ-62	Aro móvel		1	L-77 mm
				2	H-44 mm
	AZ-77	Travessa		1	L-196 mm
	A1-18	Remate		1	L-204.5 mm
	---	Bite		2	L-204.5 mm
				2	H-263 mm
	AZ-60	Pingadeira		1	L-149 mm

Acessórios e Juntas

Referência	Descrição	Quantidade
30 92 00 20	Dobradiças C.E.	3
30 92 01 00	Goteiras	2
30 92 04 30	Esquadro porta	4
30 92 05 10	Fechadura 3 pontos	1
30 92 05 40	Canhão fechadura	1
30 92 05 60	Puxador duplo	1
30 93 00 50	Junta central	1L-2H
30 93 00 90	Junta exterior	1L-2H
30 93 01 20	Junta interior	1L-2H
30 95 00 10	Pelúcia 7x9 mm	L
31 03 40 00	Mola	A cada 150 mm
30 92 05 00	Jogo topos	1
---	Junta exterior vidro	2L+2H
---	Junta interior vidro	2L+2H

229

Vidro

Hv = H-237 mm	Lv = L-218 mm
---------------	---------------

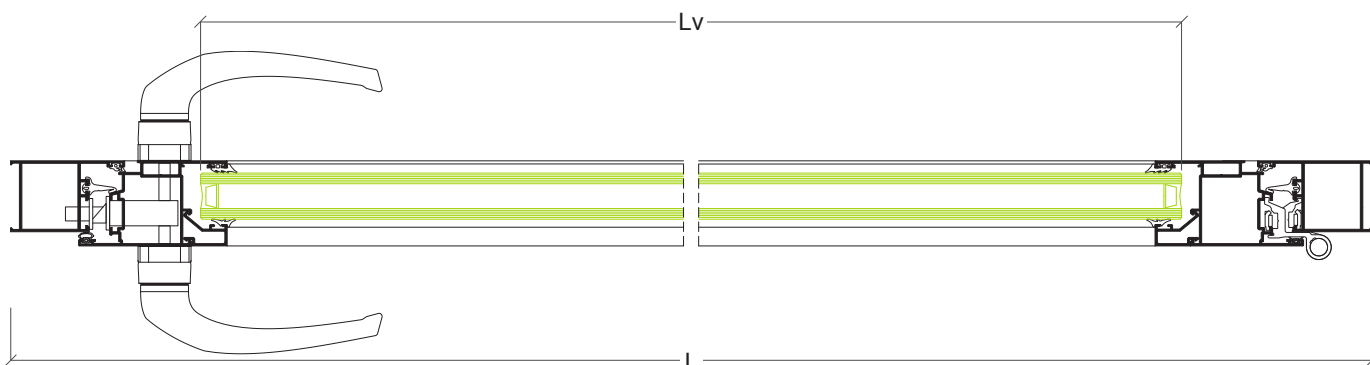

Porta 2 folhas

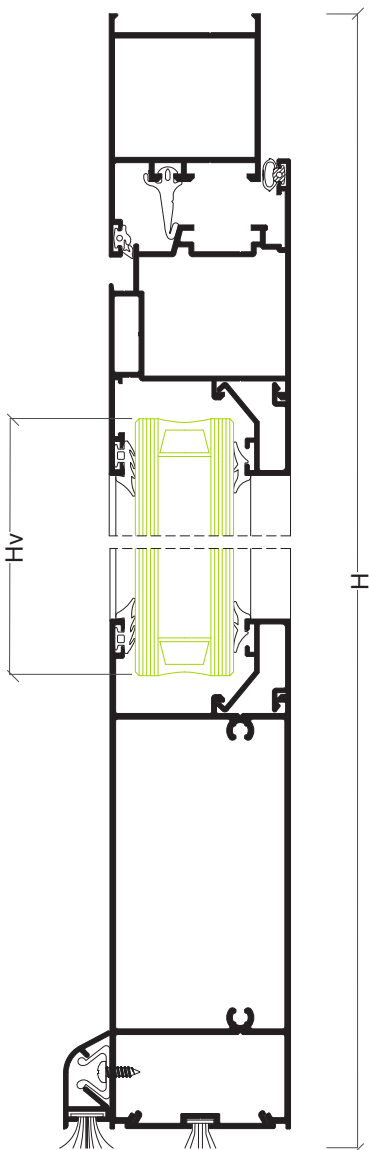
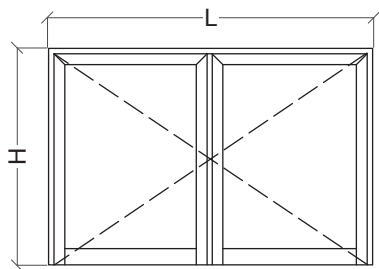

Perfis

Desenho	Ref	Descrição	Corte	Quant	Medida
	AZ-11	Aro fixo		1	L
				2	H
	AZ-62	Aro móvel		2	L/2-41 mm
				4	H-44 mm
	AZ-04	Inversor		1	H-78 mm
	AZ-77	Travessa		2	L/2-160 mm
	A1-18	Bite remate		2	L/2-168 mm
	---	Bite		4	L/2-168 mm
				4	H-263 mm
	AZ-60	Pingadeira		1	L/2-113 mm
				1	L/2-40 mm

Acessórios e Juntas

Referência	Descrição	Quantidade
30 92 00 20	Dobradiças C.E.	6
31 03 40 00	Mola para pingadeira	a cada 150 mm
30 92 01 20	Jogo fecho C.E.	1
30 92 03 51	Jogo topos inversor	1
30 92 04 30	Esquadro porta	6
30 92 05 10	Fechadura 3 pontos	1
30 92 05 40	Canhão fechadura	1
30 92 05 60	Puxador duplo	1
30 93 00 50	Junta central	1L+3H
30 93 00 90	Junta exterior	1L+4H
30 93 01 20	Junta interior	1L+4H
30 95 00 10	Pelúcia 7x9 mm	L
---	Junta exterior vidro	2L+4H
---	Junta interior vidro	2L+4H
30 92 05 00	Jogo topos	1

Vidro



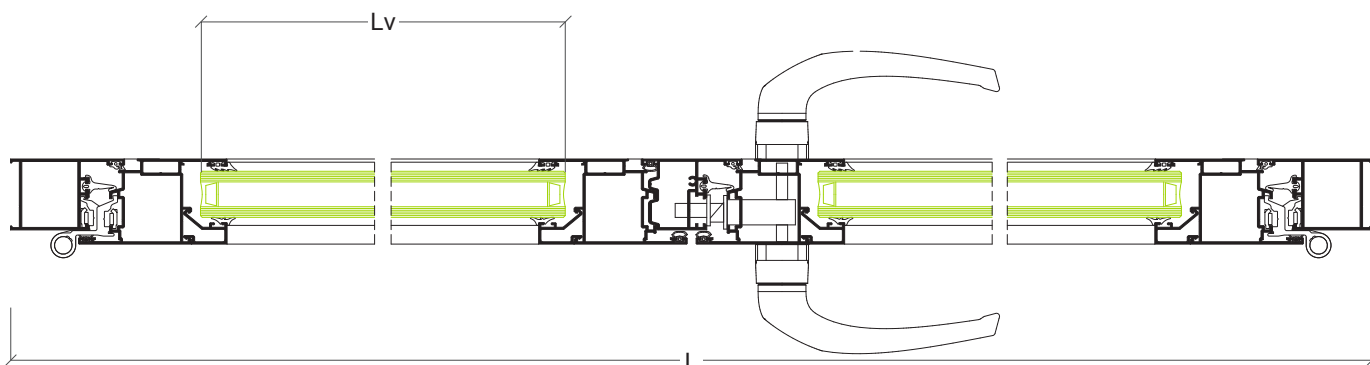



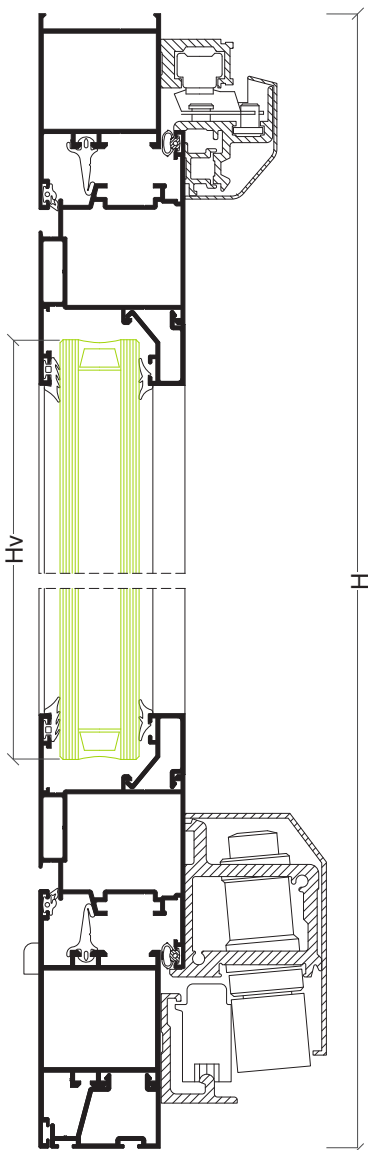
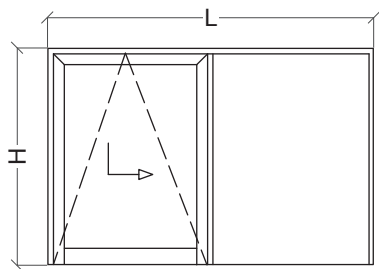













Hv = H-237 mm	Lv = L/2-183 mm
---------------	-----------------



Porta oscilo-paralela com fixo lateral



Perfis

Desenho	Ref	Descrição	Corte	Quant	Medida
	AZ-11	Aro fixo		1	L
				1	H
	AZ-62	Aro móvel		2	L1-55 mm
				2	H-97.5 mm
	AZ-09	Travessa		1	L-80 mm
				1	H-100.5 mm
	AX-15	Bite remate		1	L-89 mm
	---	Bite (folha)		2	L1-183 mm
				2	H-265.5 mm
	---	Bite (fixo)		2	L-87 mm
				2	H-129 mm
	AX-19	Vareta		2	Apro. L1 mm
				1+1	Apro. H+H/2 mm

Acessórios e Juntas

Referência	Descrição	Quantidade
30 92 01 00	Goteiras	4
30 92 01 50	União topos porta	2
30 92 04 30	Esquadro porta	8
---	Kit oscilo-paralela	1
30 92 01 35	Esquadro alinhamento	8
30 93 00 50	Junta central	L+2H
30 93 00 90	Junta exterior	L+2H
30 93 01 20	Junta interior	L+2H
---	Junta exterior vidro	2L+4H
---	Junta interior vidro	2L+4H

Vidro

Hv folha = H-239 mm	Lv folha = L1-196 mm	
Hv fixo = H-103 mm	Lv fixo = L2-81 mm	
Para vidros iguais $L1 = L/2+58$ mm		
	Mínimo	Máximo
Largura da folha	700 mm	1650 mm
Altura da folha	850 mm	2400 mm
Peso máximo por folha 150 kg		

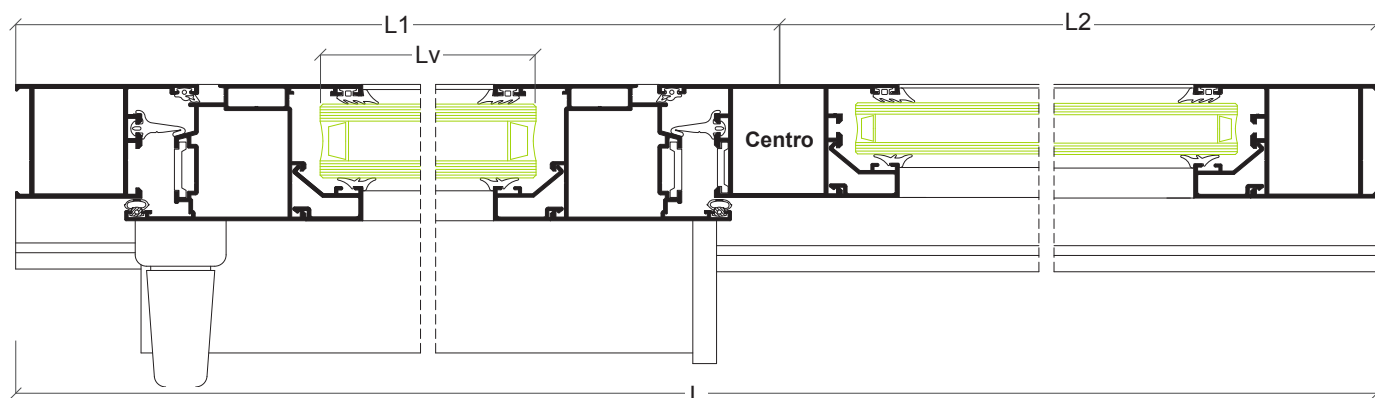

Porta 3 folhas harmónio

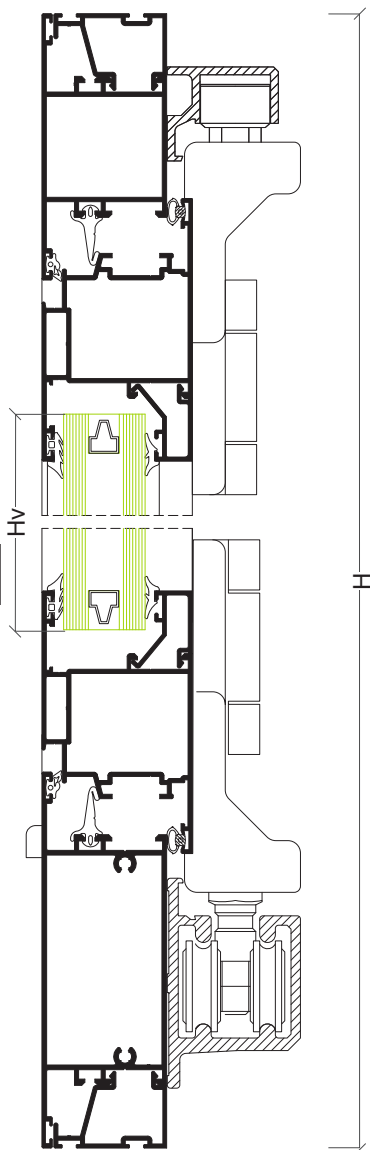
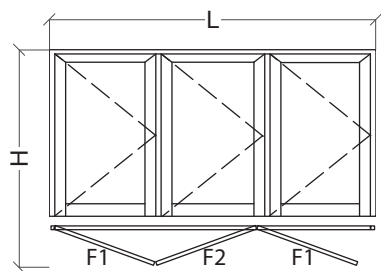

Perfis

Desenho	Ref	Descrição	Corte	Quant	Medida
	AZ-11	Aro fixo		2	H
	AZ-09	Travessa		1	L-80 mm
	AZ-12	Travessa		1	L-80 mm
	AZ-62	Aro móvel		4	F1 consultar
				2	F2 consultar
	AZ-62	Aro móvel		6	Consultar
	---	Bite			F1 consultar
					F2 consultar
	AX-19	Vareta		1+1	H+H
	AZ-04	Inversor		3	consultar
	---	Bite			consultar
					consultar
	AX-15	Bite remate		2	L-89 mm

Acessórios e Juntas

Referência	Descrição	Quantidade
30 92 00 26	Dobradiças 3 nós	3
30 92 01 00	Goteiras	4
30 92 01 20	Jogo fecho C.E.	1
30 92 01 50	União topos porta	2
30 92 03 51	Jogo topos inversor	2
30 92 04 30	Esquadro porta	12
---	Kit harmónio (3+0)	1
30 92 01 35	Esquadro alinhamento	24
30 93 00 50	Junta central	2L+4H
30 93 00 90	Junta exterior	2L+6H
30 93 01 20	Junta interior	2L+6H
---	Junta exterior vidro	2L+6H
---	Junta interior vidro	2L+6H

Vidro

Vidro H1 = consultar	Vidro Lv1/Lv2 = consultar	
	Mínimo	Máximo
Largura da folha	600 mm	900 mm
Altura da folha	850 mm	2400 mm
Peso máximo por folha 80 kg		

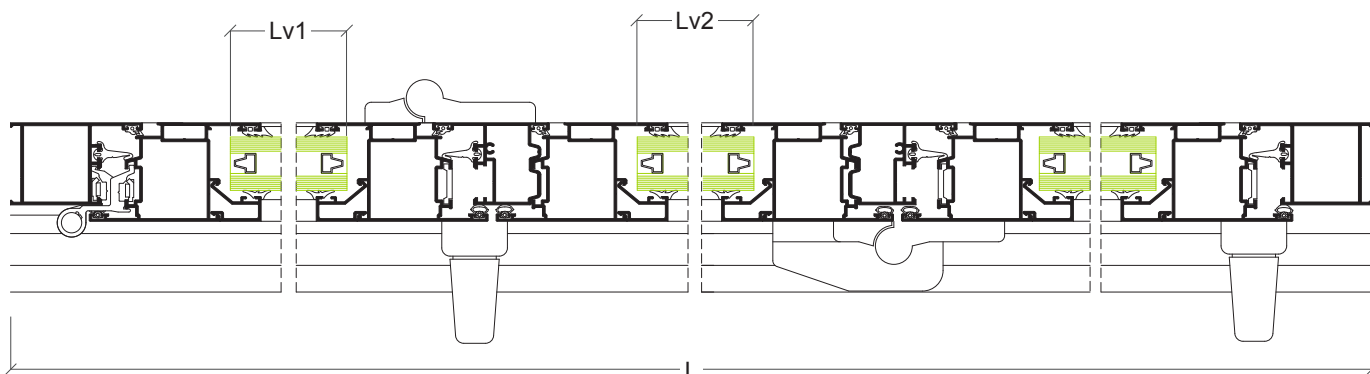

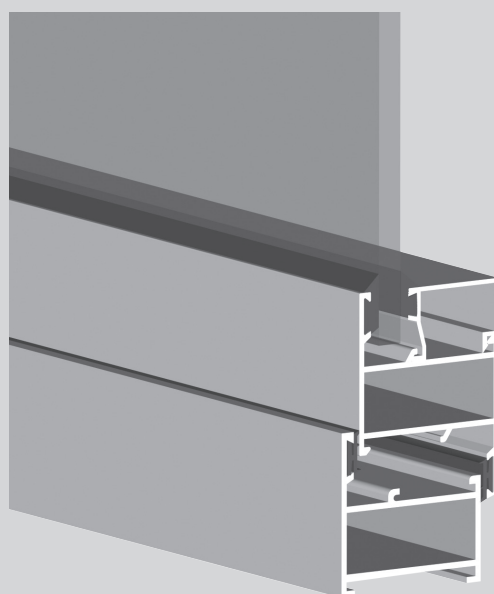
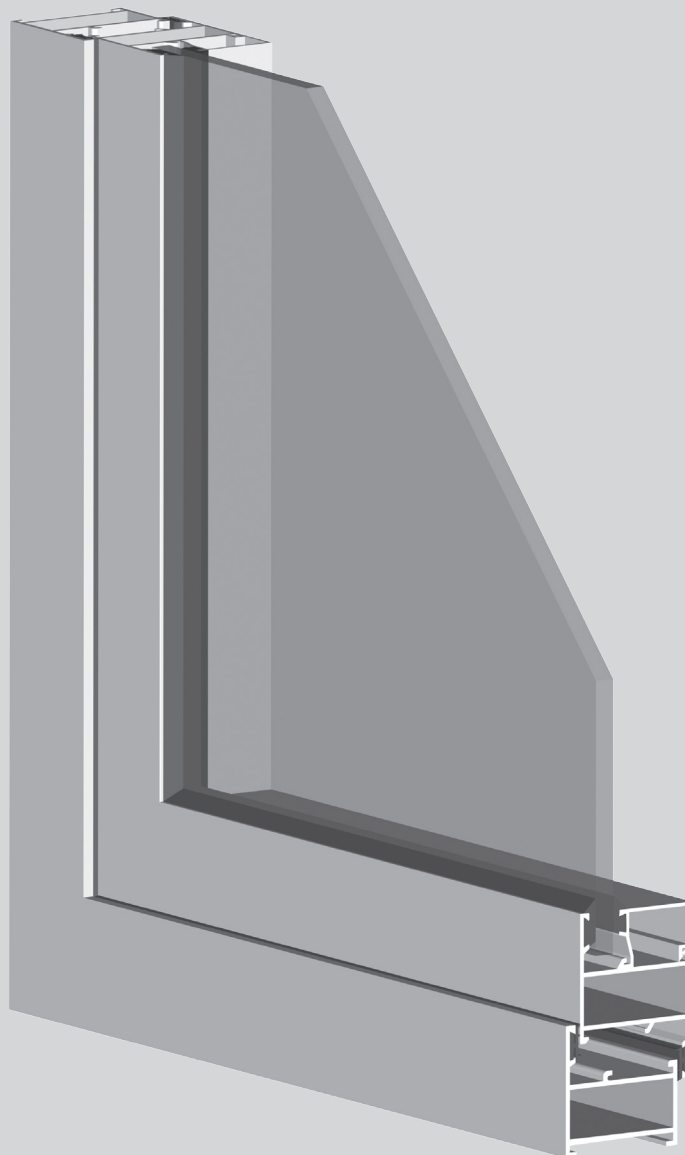

**Sistema
A1/A6**

Sistema A1/A6

Sistema de batente tradicional - 40 mm

Características do sistema

Sistema de batente tradicional com dupla vedação (exterior, interior).

O sistema A1/A6 possibilita a execução de 2 versões de caixilharia:

1. linha recta;
2. linha oval;

Inclui também várias possibilidades de concepção de modelos do portadas com lâminas fixas ou orientáveis.

Perfis de alumínio

Os perfis de alumínio são extrudidos na liga de alumínio 6060 para arquitectura de acordo com norma NP EN 12020-02.

Espessura média dos perfis de alumínio de 1.4 mm para janelas e portas.

Aros fixos

Secção dos aros fixos de 40 mm;

Aros fixos com esquadro para montagem a meia esquadria.

Aros móveis

Secção dos aros móveis de 40 mm;

Enchimento para vidro simples ou duplo de 4 mm a 24 mm;

Aros móveis de linha recta ou oval sem bite;

Aros móveis com esquadro para montagem a meia esquadria.

Dimensionamento e manobralidade

Dimensões mínimas - máximas de folha: 375 mm - 1700 mm (L); 410 mm - 2500 mm (H);

Peso máximo de 80 kg por folha para janelas de abrir;

Possibilidades de abertura: Fixo, batente interior 1 ou 2 folhas, exterior, basculante, projectante e pivotante;

Estanquidade assegurada através de juntas em PVC.

Performances

Sistema certificado por laboratório notificado para Ensaio Tipo Inicial (ITT) de acordo com a norma de produto EN 14351-1 para efeitos de Marcação CE.

Categorias alcançadas na avaliação do sistema A1/A6 tipologia janela:

1. Permeabilidade ao ar: Classe 2 (norma de ensaio EN 1026)
2. Estanquidade à água: Classe 7A (norma de ensaio EN 1027)
3. Resistência ao vento: Classe C3 (norma de ensaio EN 12211)

Categorias alcançadas na avaliação do sistema A1/A6 tipologia porta:

1. Permeabilidade ao ar: Classe 2 (norma de ensaio EN 1026)
2. Estanquidade à água: Classe 7A (norma de ensaio EN 1027)
3. Resistência ao vento: Classe C1 (norma de ensaio EN 12211)

Coefficiente de transmissão térmica de vão de 2 folhas com 1.20 m x 1.50 m com vidro $U_g = 1.8 \text{ W/m}^2\text{K}$:

• $U_w = 4.14 \text{ W/m}^2\text{K}$

Coefficiente de atenuação acústica de vão de 2 folhas com vidro 4/12/4:

• $R_w (C; C_{tr}) = 33 \text{ dB} (-1; -4)$

Zonas de aplicação segundo RCCTE (em função do valor U_g): I1, I2, I3, V1, V2, V3;

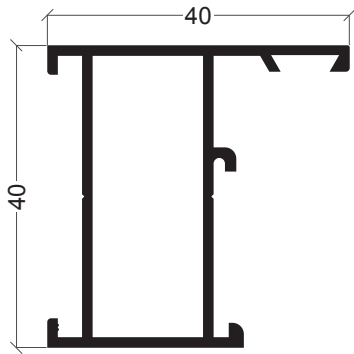

A1-03
Aro fixo

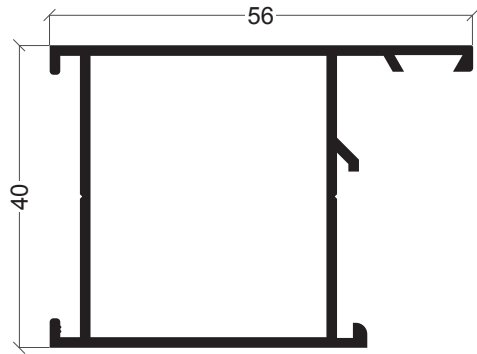

A1-08
Aro fixo

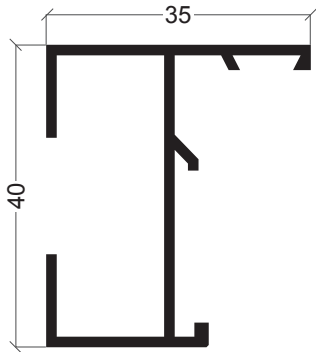

A1-52
Aro fixo

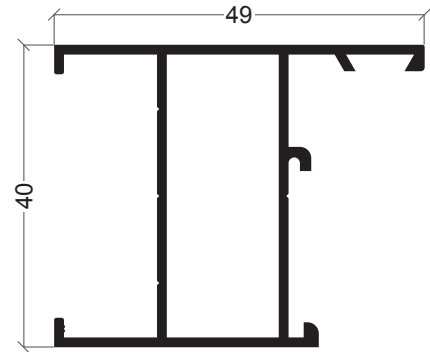

A1-76
Aro fixo/móvel

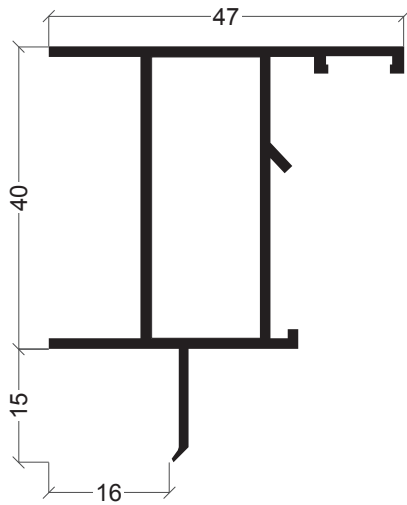

A1-51
Aro fixo para apainelado

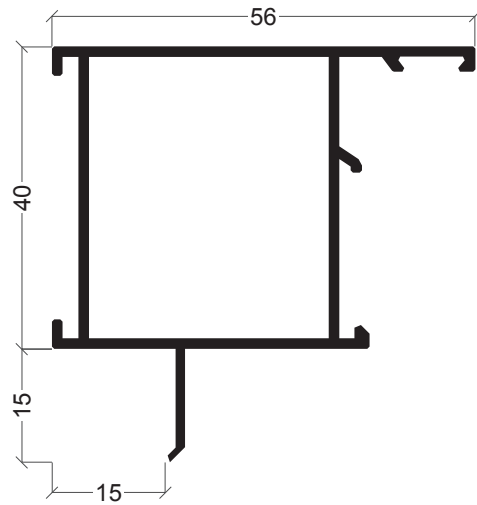

A1-61
Aro fixo para apainelado

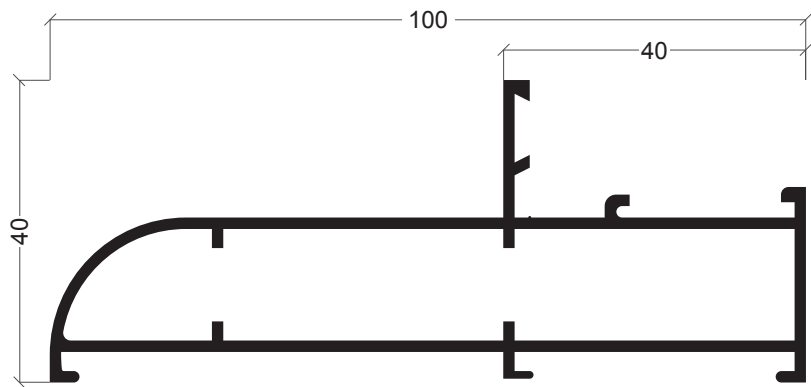

A1-73
Aro fixo

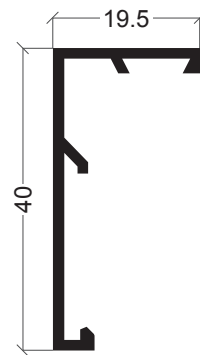

A1-33
Aro fixo

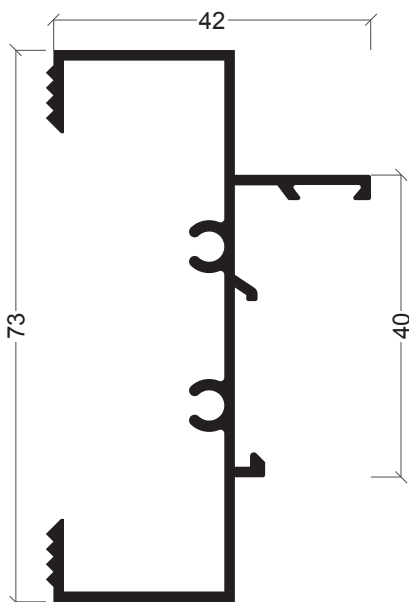

A1-22
União aros com fixo

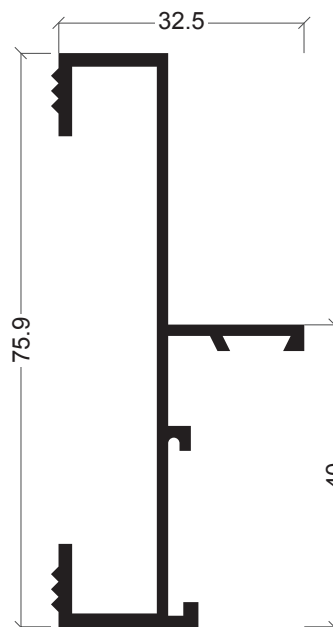

A1-72
União aros com fixo

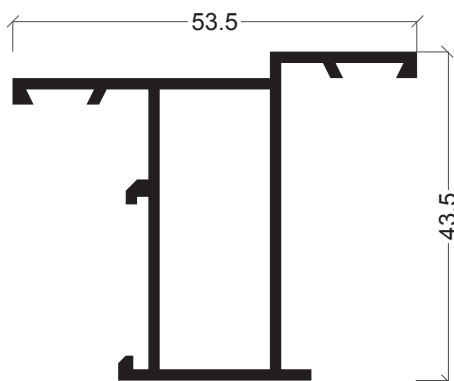

A1-04
Aro móvel/inversor

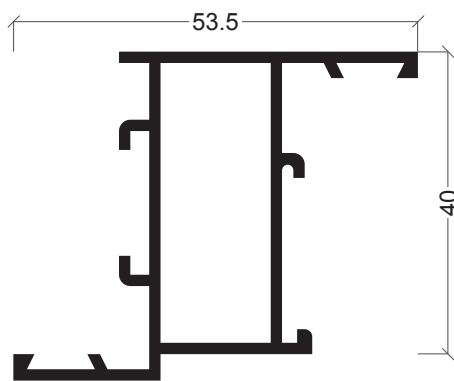

A1-05
Aro móvel/inversor

236

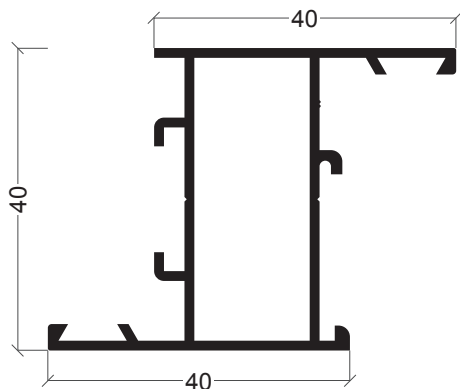

A1-02
Aro móvel

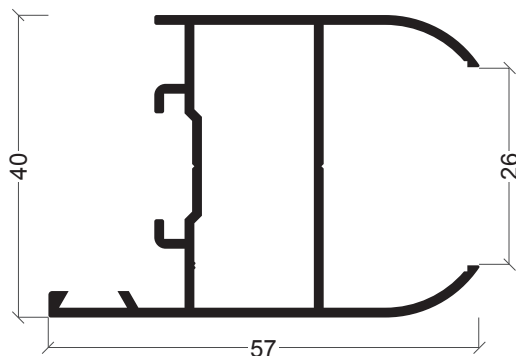

A1-42
Aro móvel

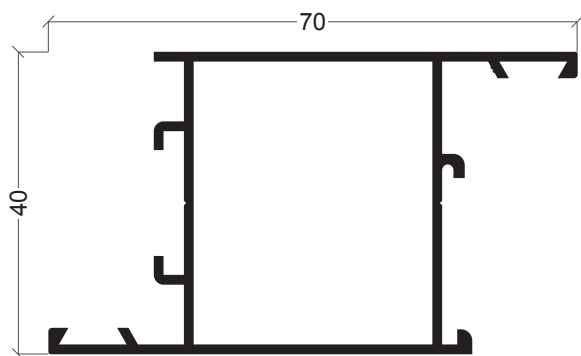

A1-07
Aro móvel

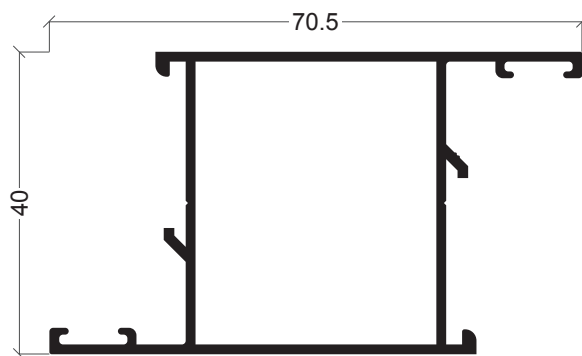

A1-60
Aro móvel

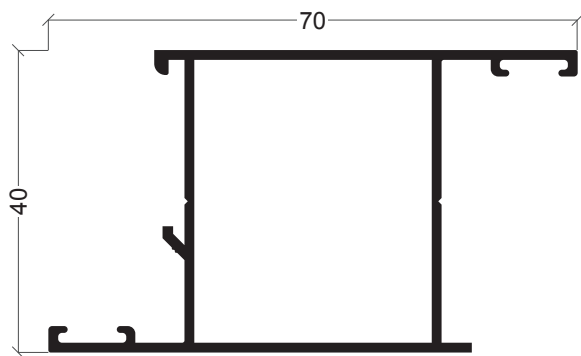

A1-68
Aro móvel

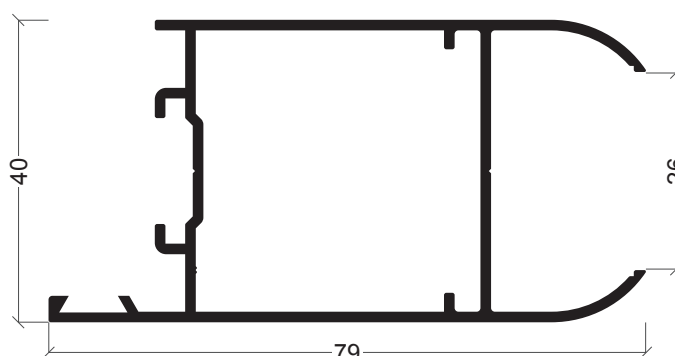

A1-58
Aro móvel

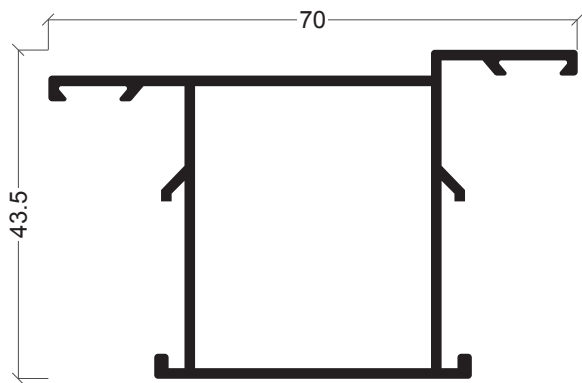

A1-09
Aro móvel/inversor

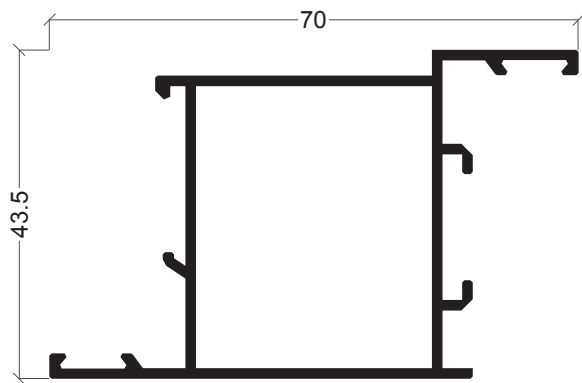

A1-10
Aro móvel/inversor

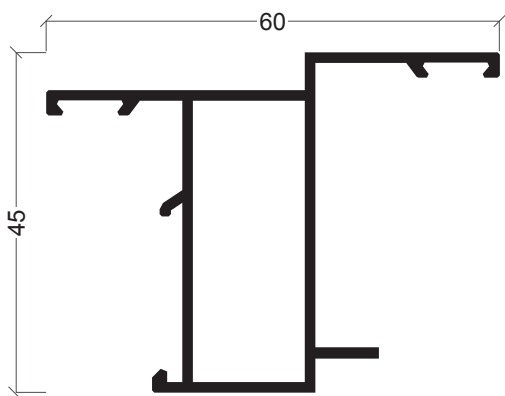

A1-24
Aro móvel/inversor

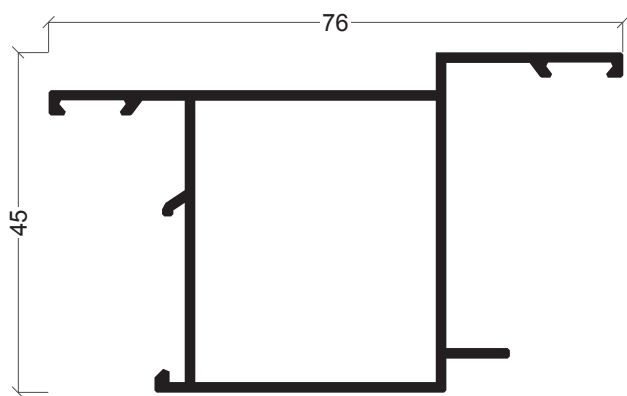

A1-29
Aro móvel/inversor

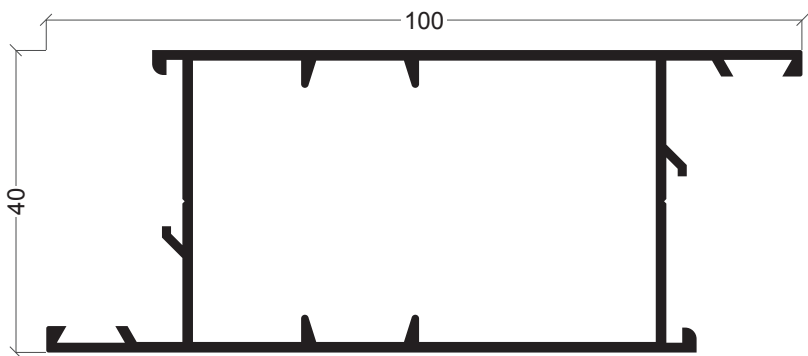

A1-66
Aro móvel

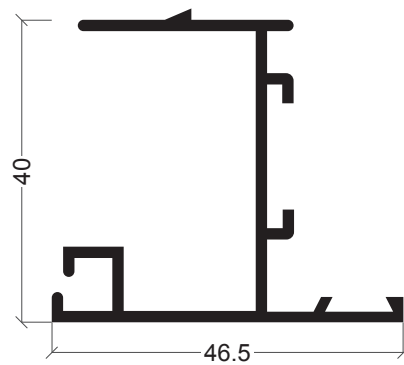

A1-47
Inversor

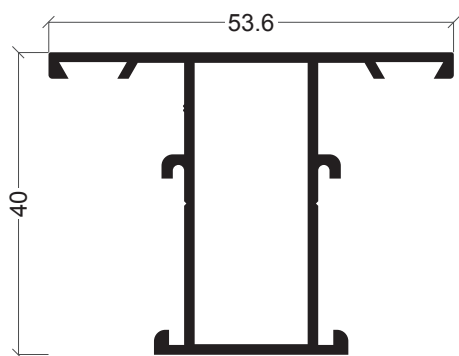

A1-01
Travessa

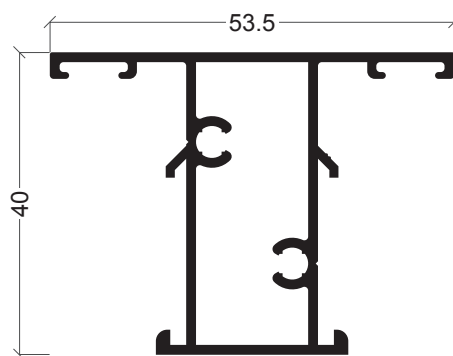

A1-34
Travessa

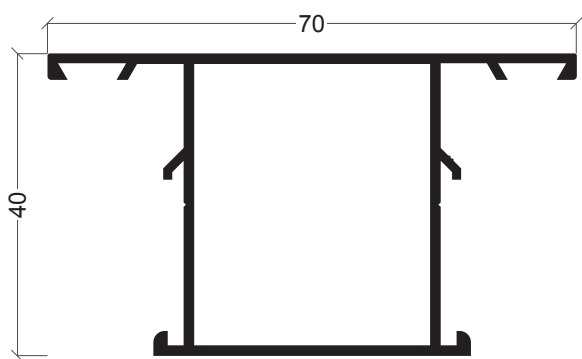

A1-06
Travessa

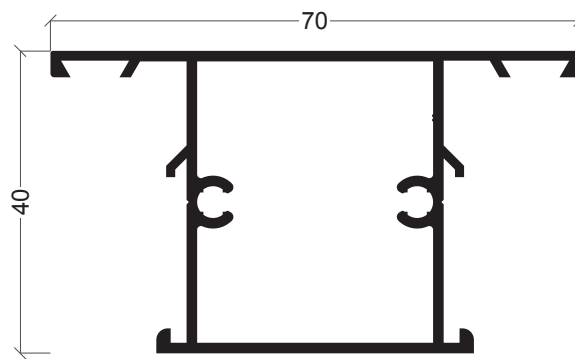

A1-25
Travessa

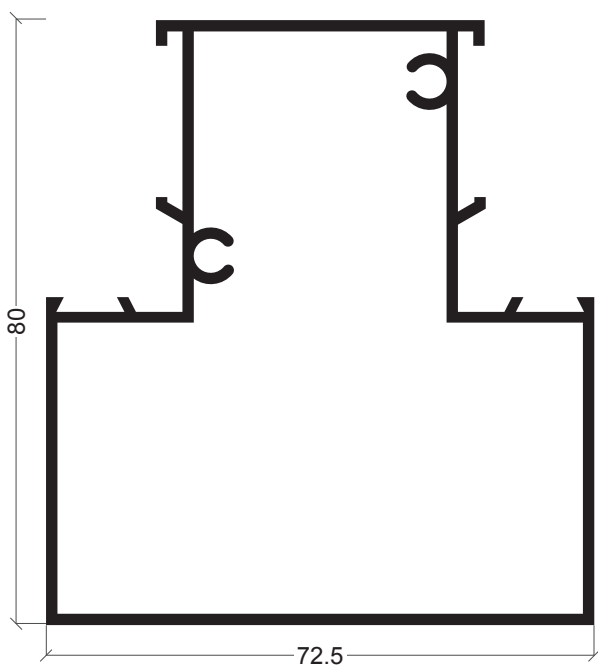

A1-62
Montante

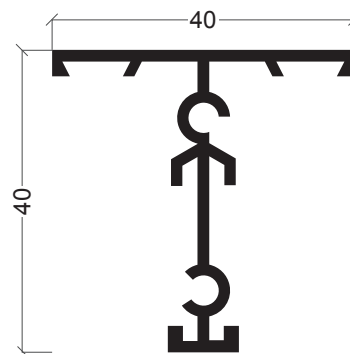

A1-55
Travessa

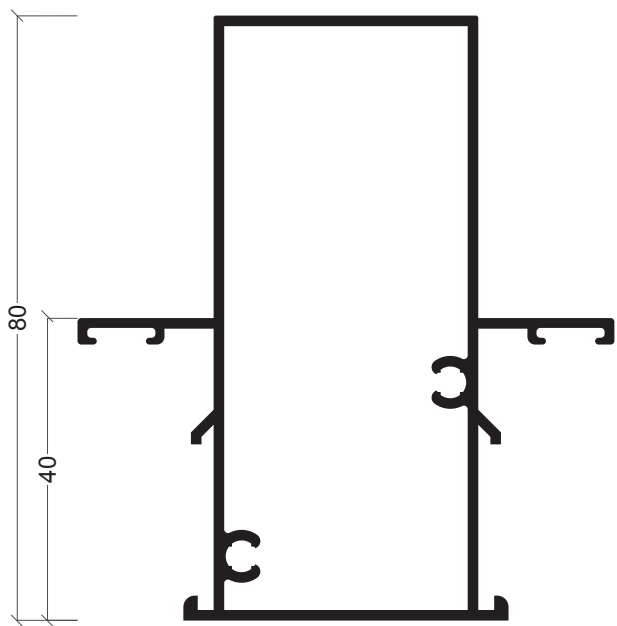

A1-35
Montante

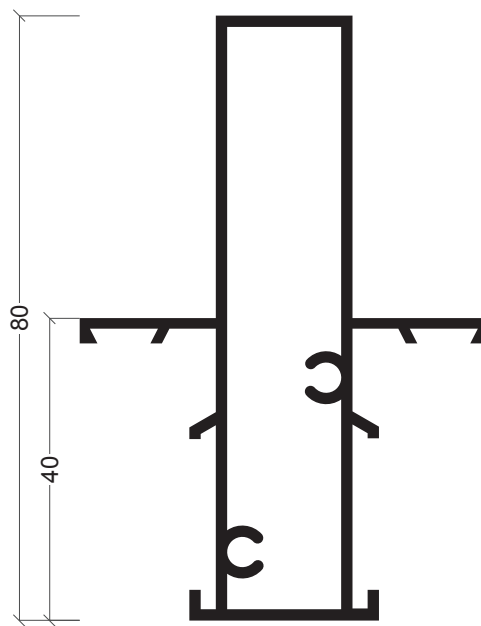

A1-36
Montante

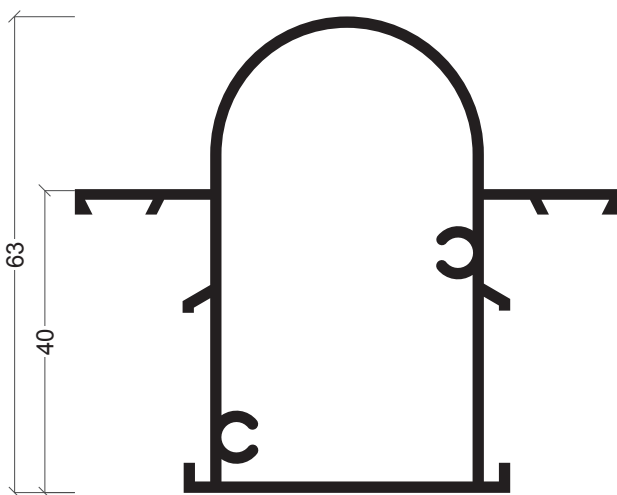

A1-70
Montante

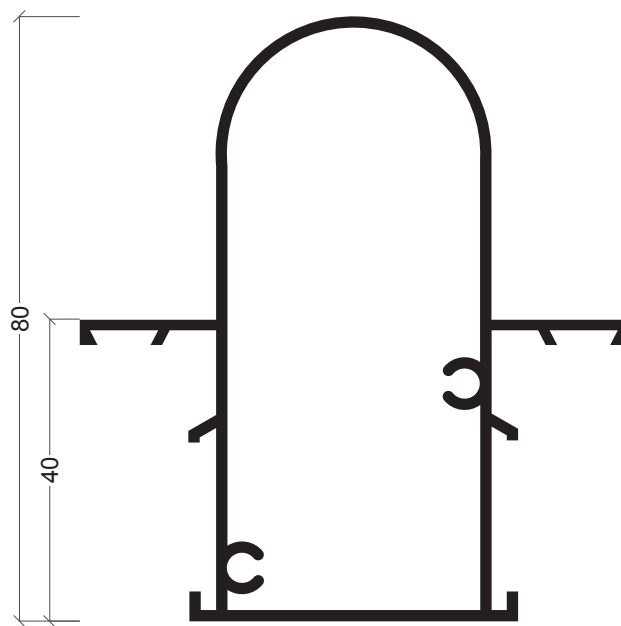

A1-71
Montante

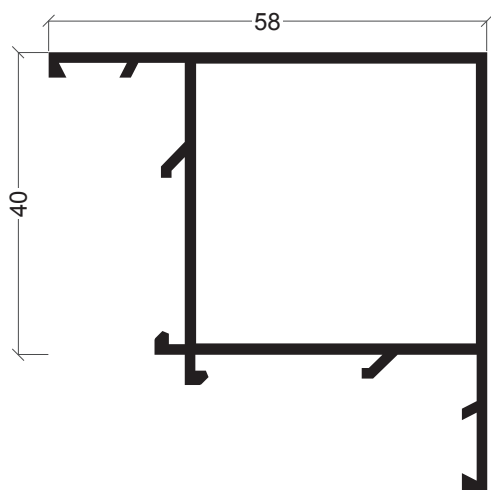

A1-11
Esquina

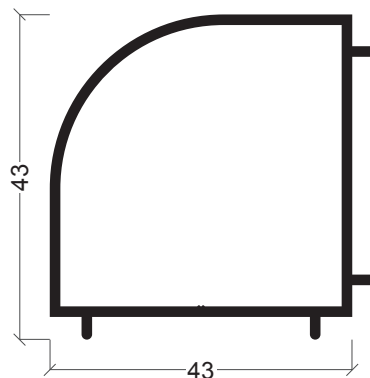

A1-57
Esquina

240

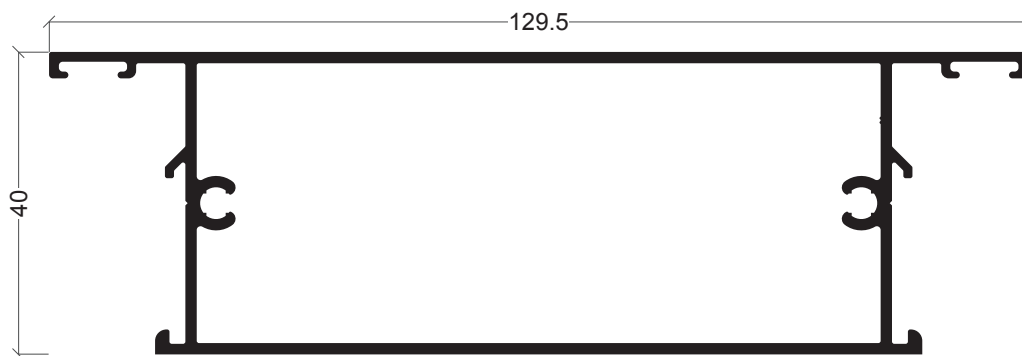

A1-12
Travessa

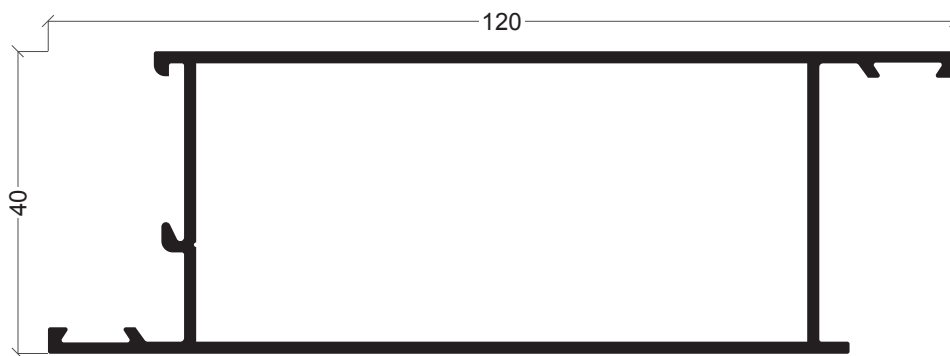

A1-14
Aro móvel/almofada

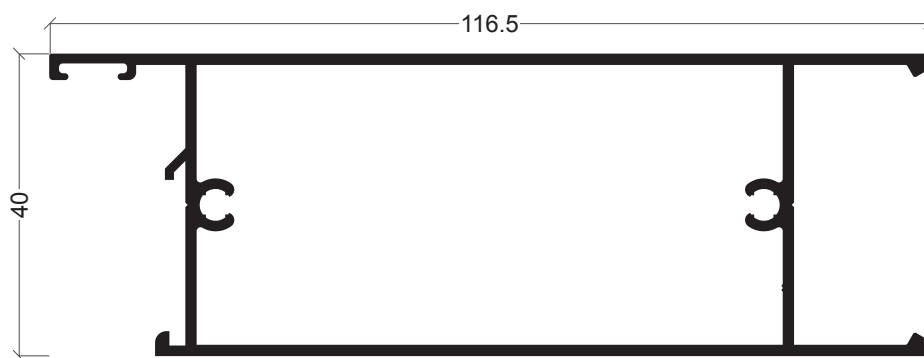

A1-63
Almofada

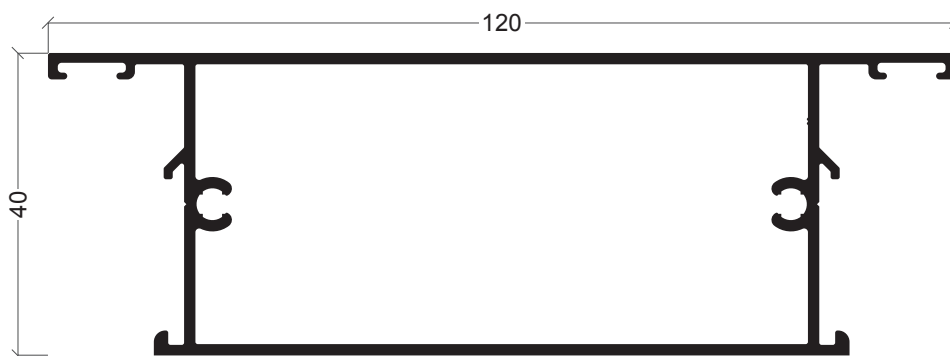

A1-65
Travessa

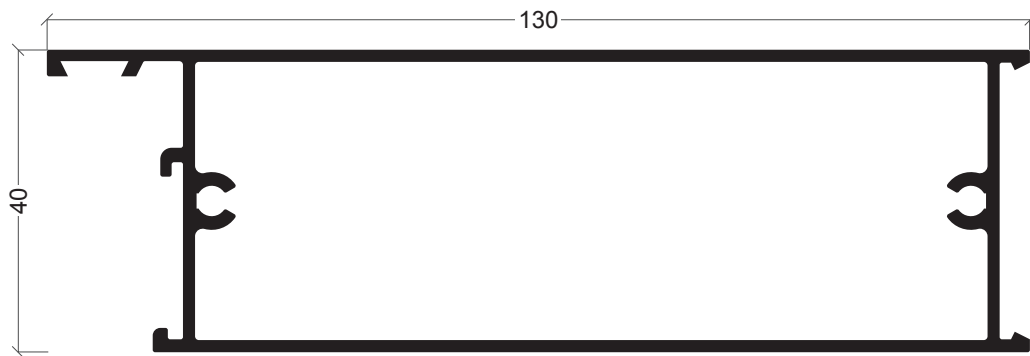

A1-13
Almofada

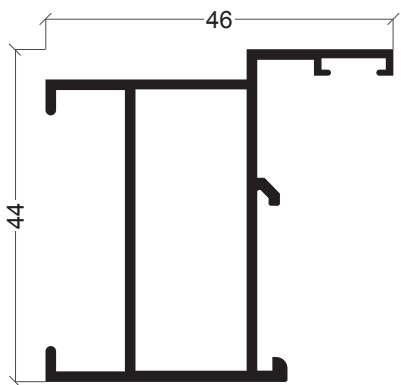

A1-74
Almofada

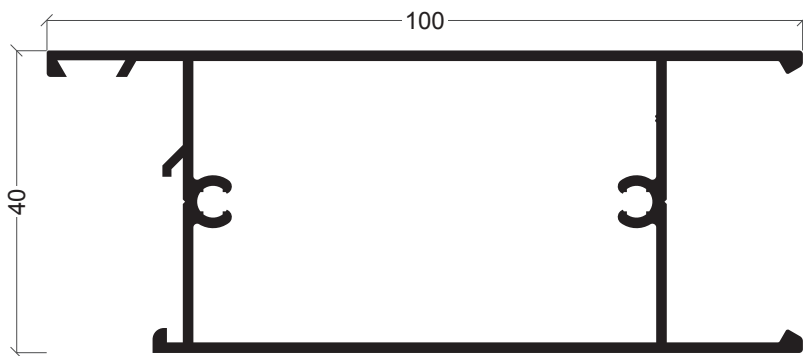

A1-64
Almofada

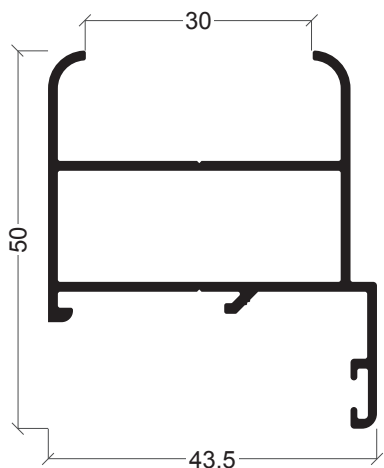

A1-83
Aro fixo/móvel portada

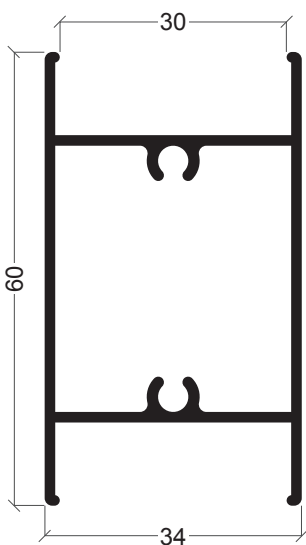

A1-85
Travessa

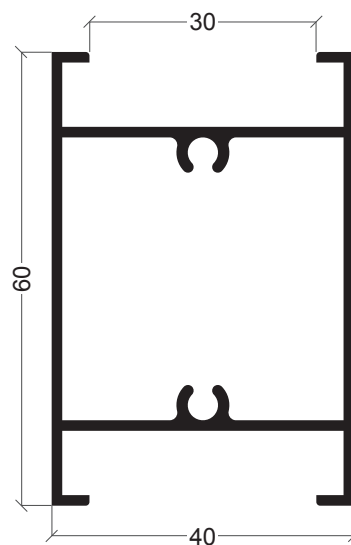

A1-75
Travessa

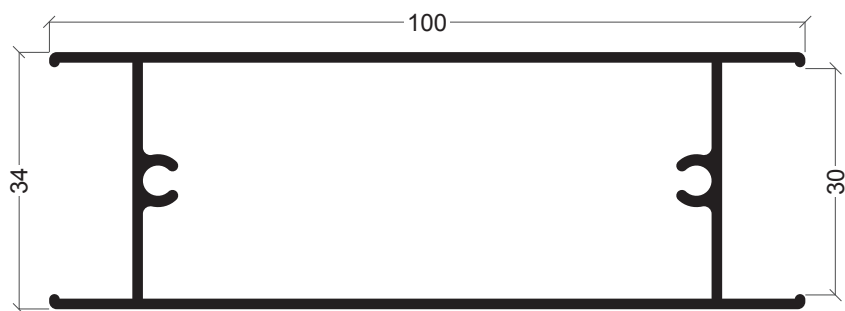

A1-84
Travessa

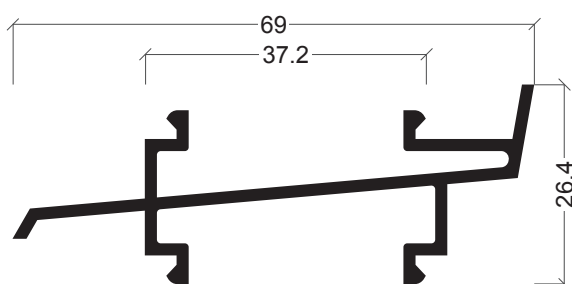

A1-17
Soleira

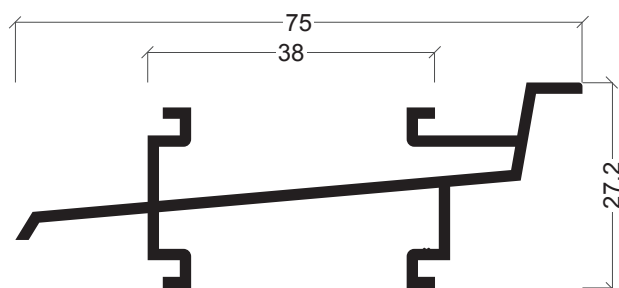

A1-86
Soleira

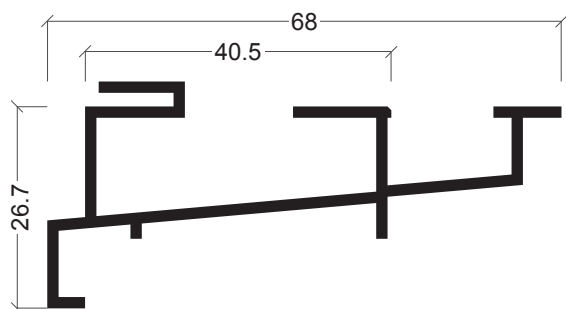

A1-48
Soleira



A1-18
Perfil de remate

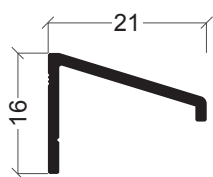

A1-46
Pingadeira



A1-19
Vareta



A1-20
União de aros

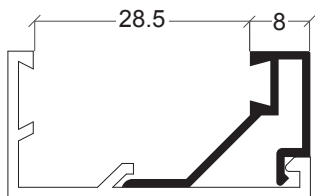

A1-43

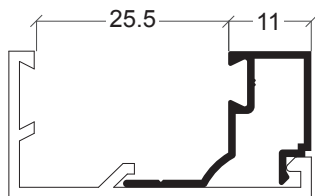

A1-44

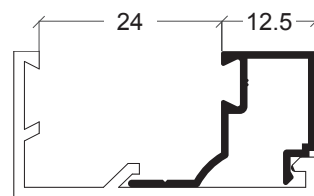

A1-32

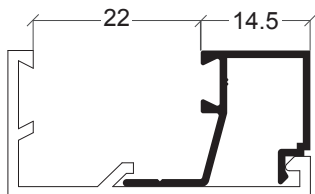

A1-49

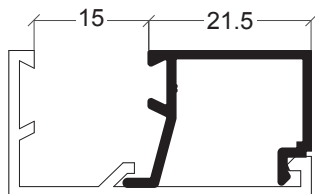

A1-30

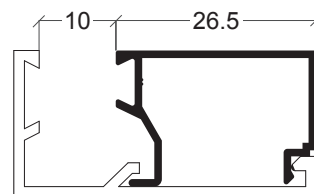

A1-31

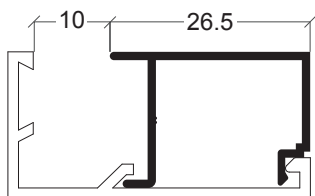

A6-09

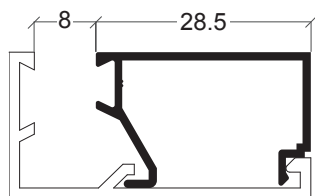

A1-15

244



A6-23
Calha de comando

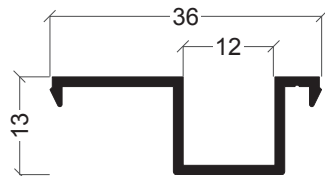

A6-21
Compensador

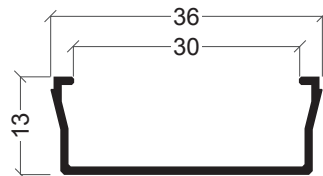

A6-24
Redutor

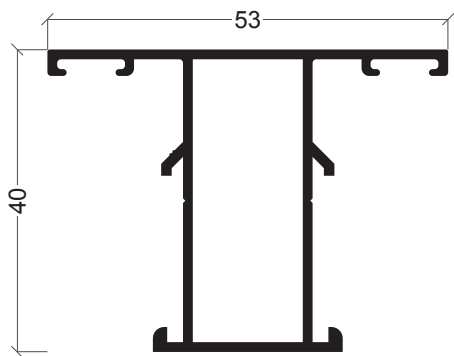

A6-01
Travessa

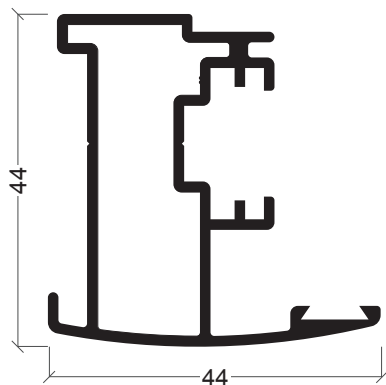

A6-26
Inversor



A6-27
Vareta

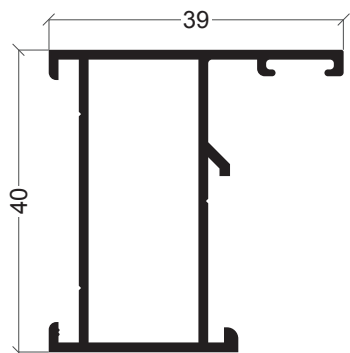

A6-03
Aro fixo

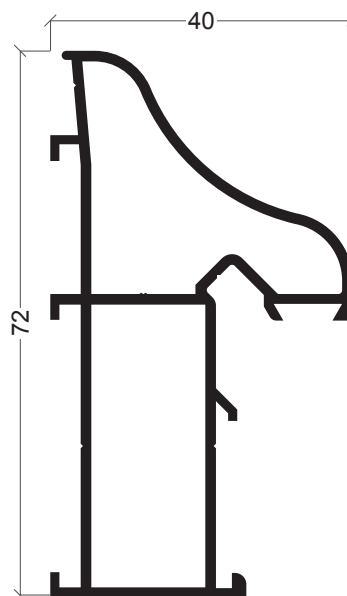

A6-10
Aro fixo

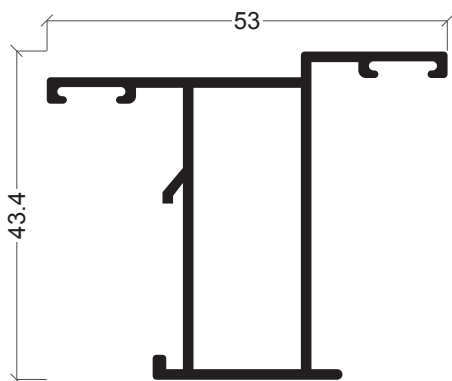

A6-04
Aro móvel/inversor

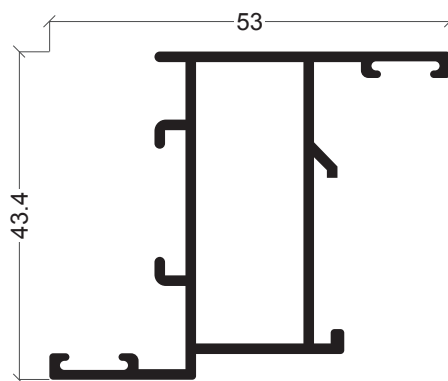

A6-05
Aro móvel/inversor

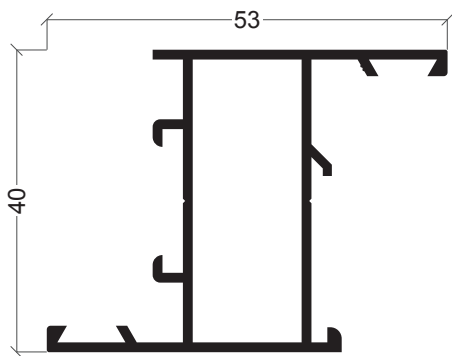

A6-02
Aro móvel

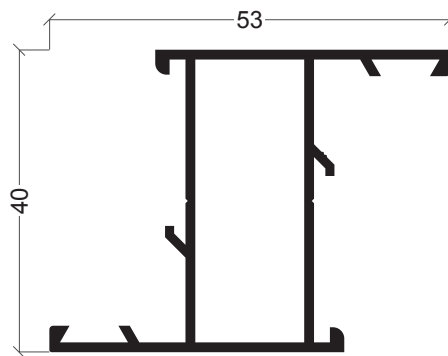

A6-06
Aro móvel

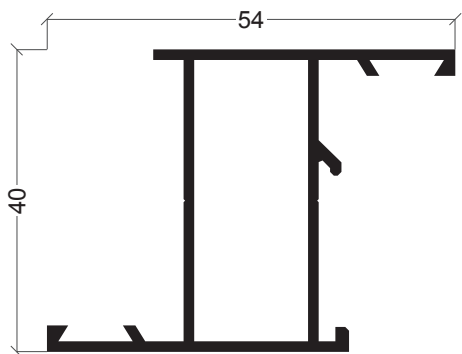

A6-07
Aro móvil

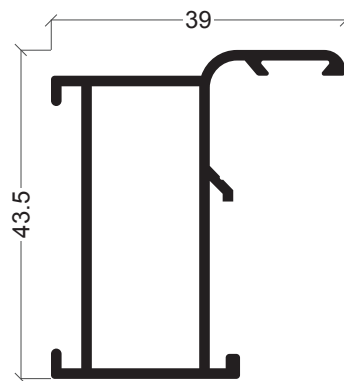

A6-17
Aro fijo

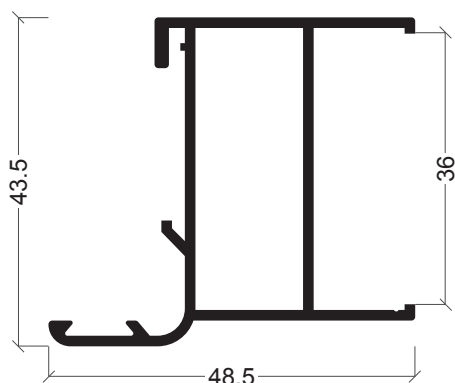

A6-18
Aro móvil portada

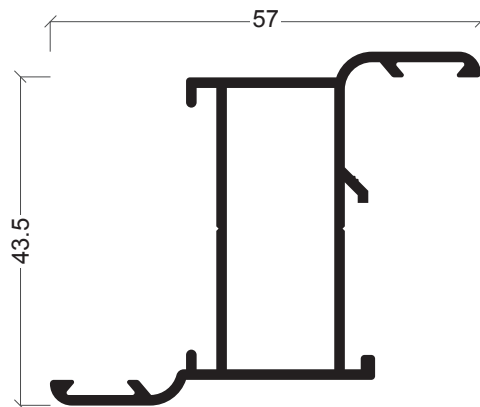

A6-19
Aro fijo/móvel

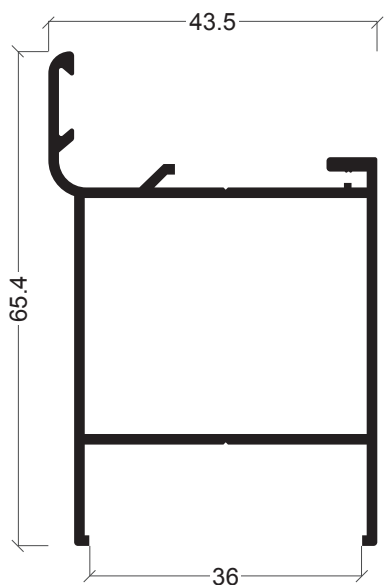

A6-20
Aro móvil portada

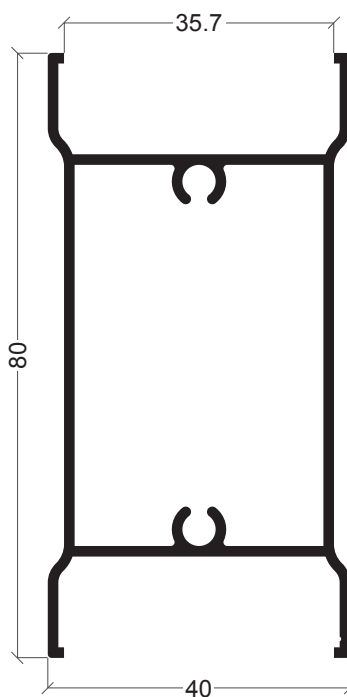

A6-22
Travessa portada

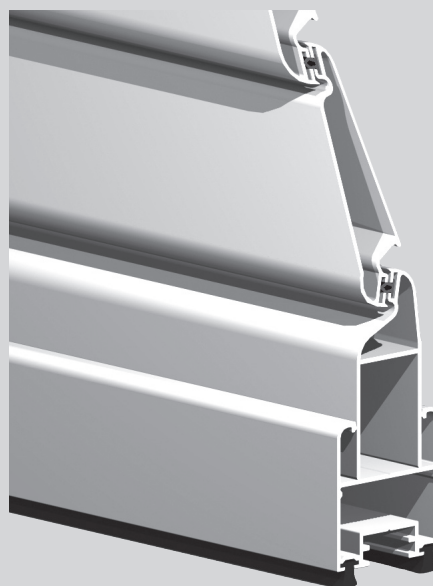

Sistema
XP

Sistema XP

Sistema de Portadas

Características do sistema

Sistema de portada que oferece a possibilidade de dois tipos de lâminas:

- Lâminas fixas
- Lâminas orientáveis

As lâminas orientáveis permitem uma total regulação através de mecanismos de rotação que permitem assim um controle da luminosidade de interior.

Este sistema não utiliza inversores graças à fisionomia da folha, utilizando apenas um pequeno perfil de batente.

Perfis de alumínio

As secções do aro e do móvel são de 40 e 47 mm respectivamente, com uma espessura média dos perfis de alumínio de 1.5 mm.

Dimensionamento e manobralidade

Possibilidades de abertura: exterior (1, 2, 3 e 4 folhas), harmónio e correr.

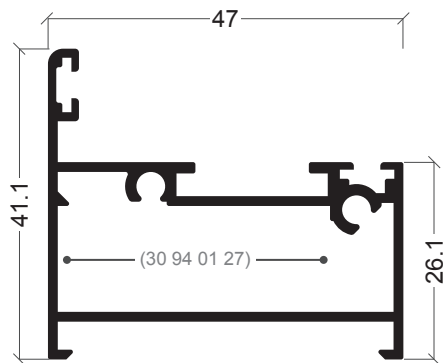

XP-03
Aro fixo

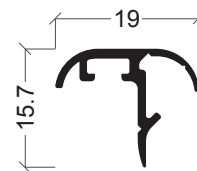

XP-04
Perfil de batente

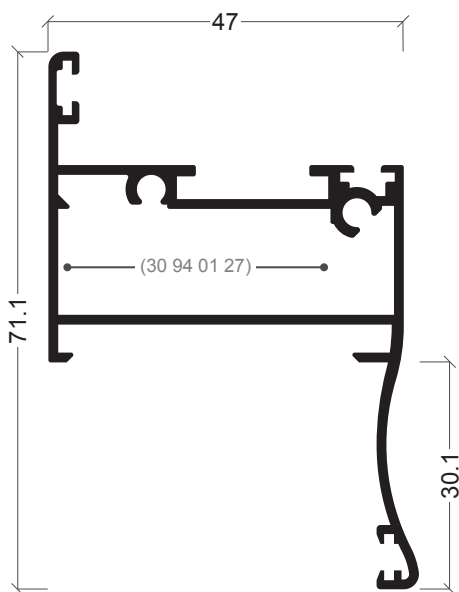

XP-09
Aro fixo com remate

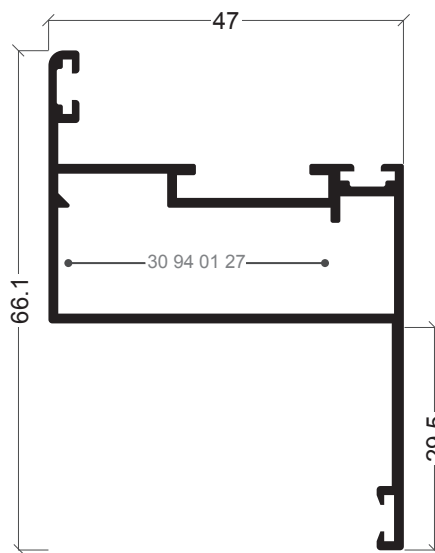

XP-26
Aro fixo com remate

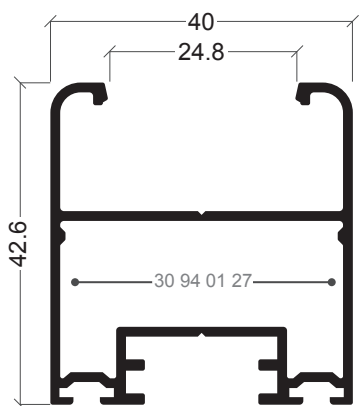

XP-05
Aro móvel

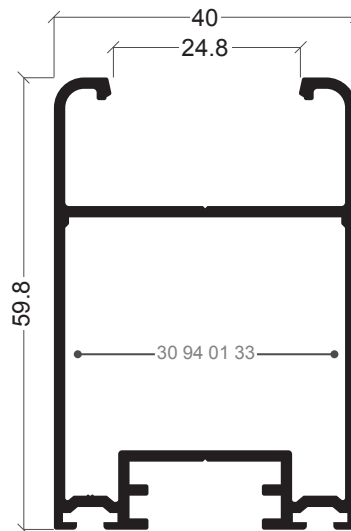

XP-18
Aro móvel

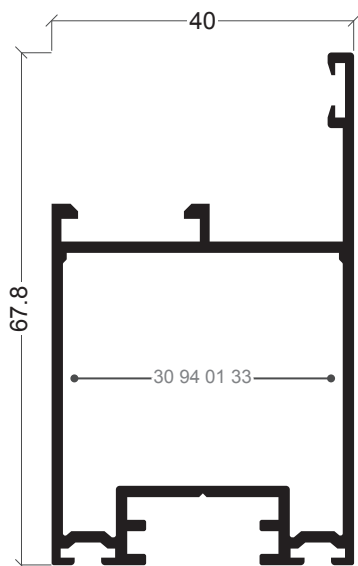

XP-22
Aro móvel com bite

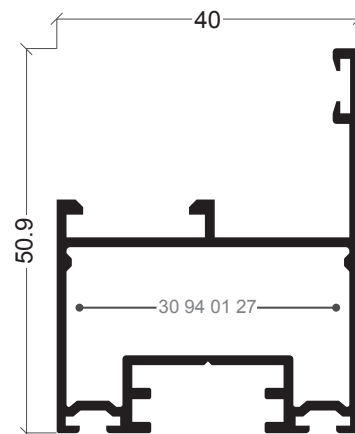

XP-11
Aro móvel com bite

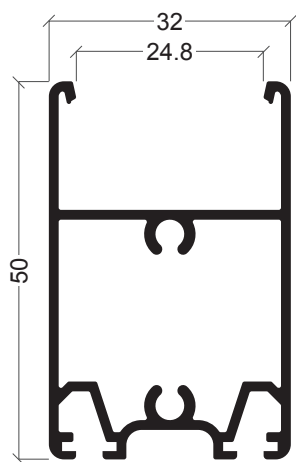

XP-10
Almofada 50 mm

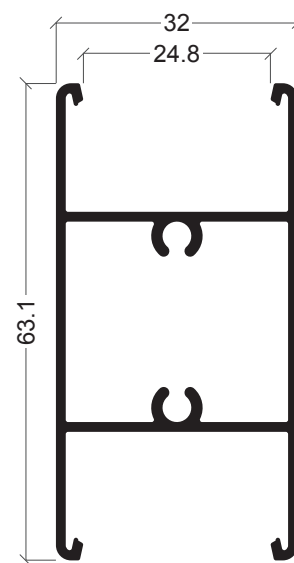

XP-25
Travessa 63 mm

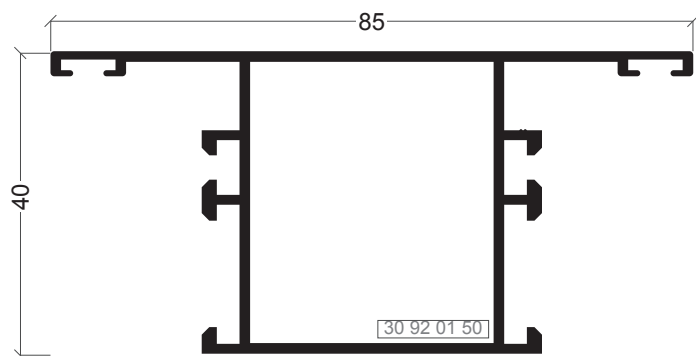

AZ-09
Travessa

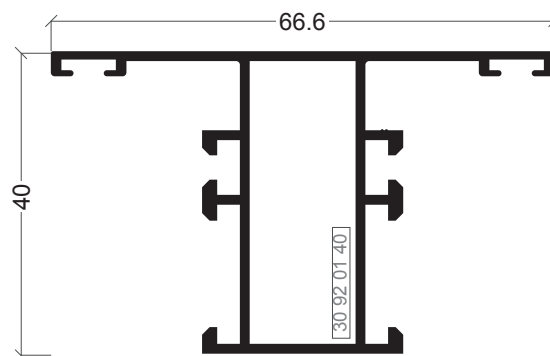

AZ-01
Travessa

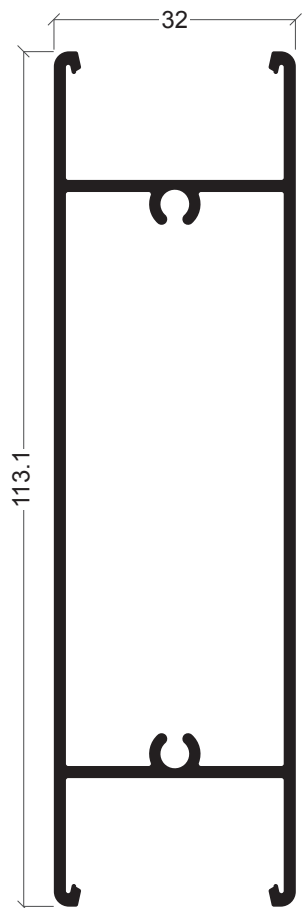

XP-27
Travessa 113 mm

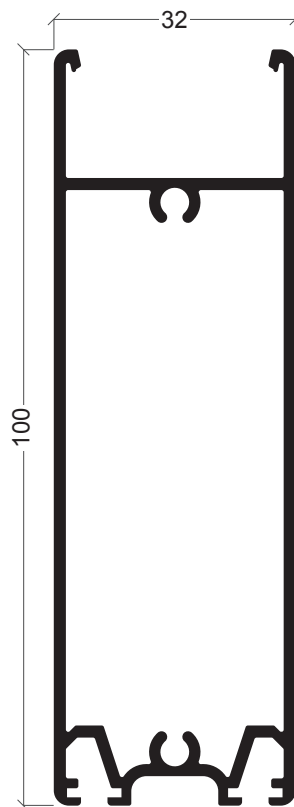

XP-16
Almofada 100 mm

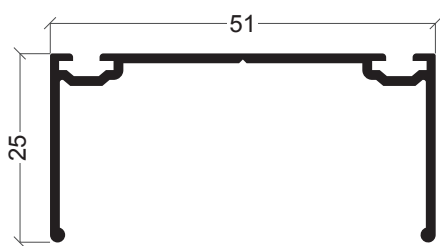

XP-20
Distanciador aro fixo de correr

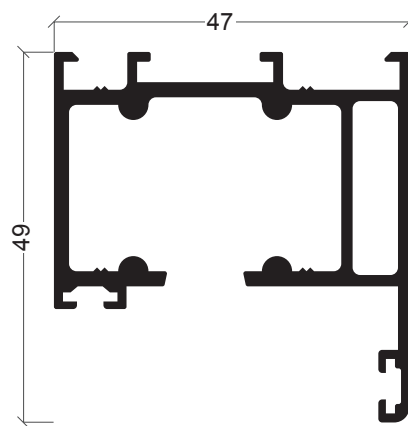

XP-21
Aro fixo de correr

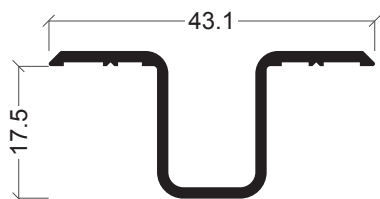

XP-23
Guia embutir de correr

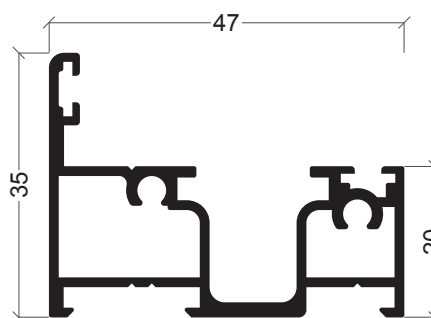

XP-24
Aro fixo guia de correr

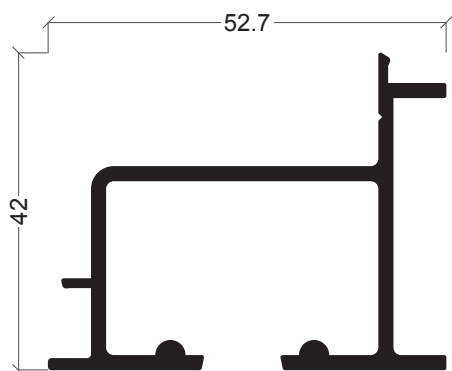

XP-07
Guia superior de correr

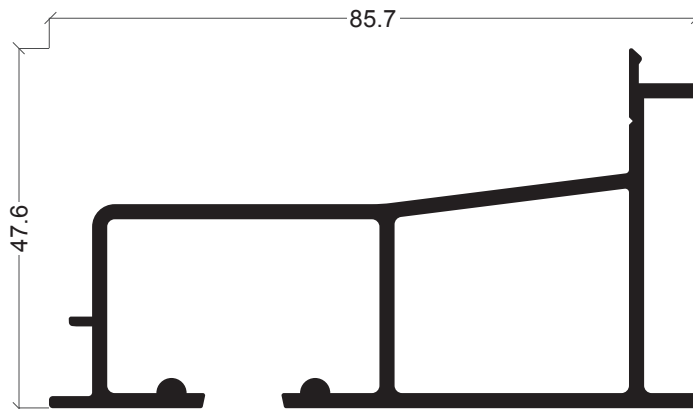

XP-13
Guia superior de correr

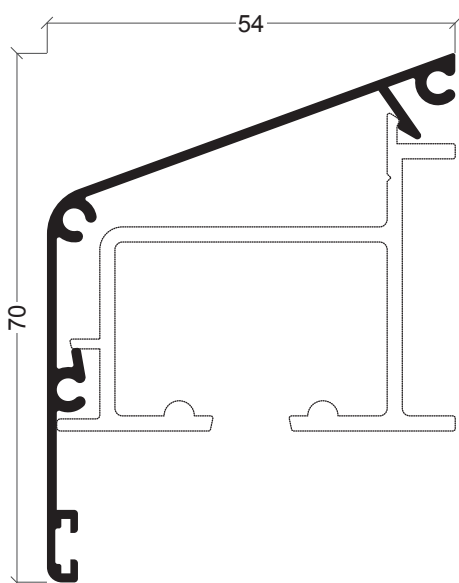

XP-06
Tampa guia superior de correr

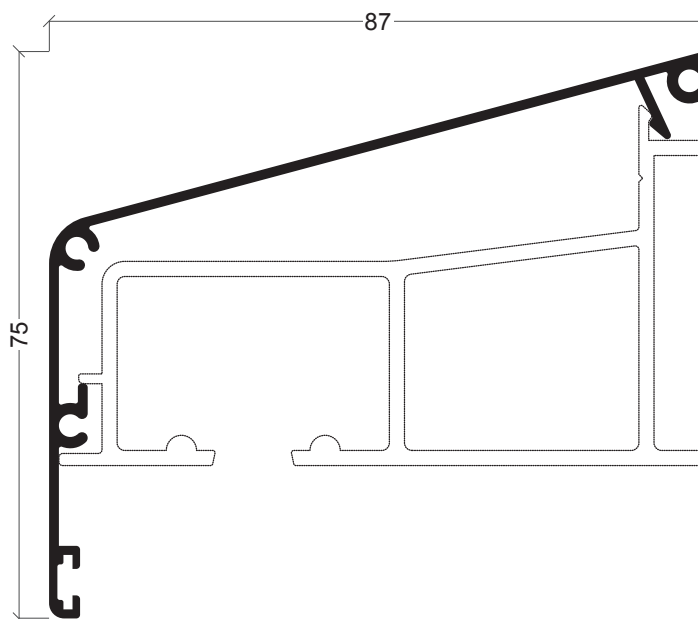

XP-12
Tampa guia superior de correr longa

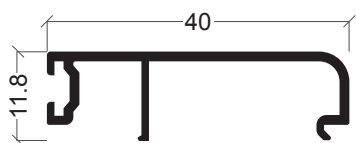

XP-08
Tampa lateral de correr

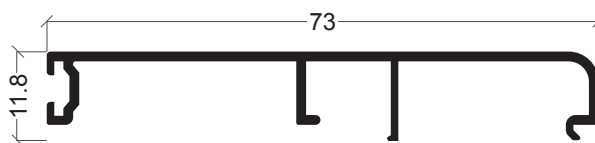

XP-14
Tampa lateral de correr larga

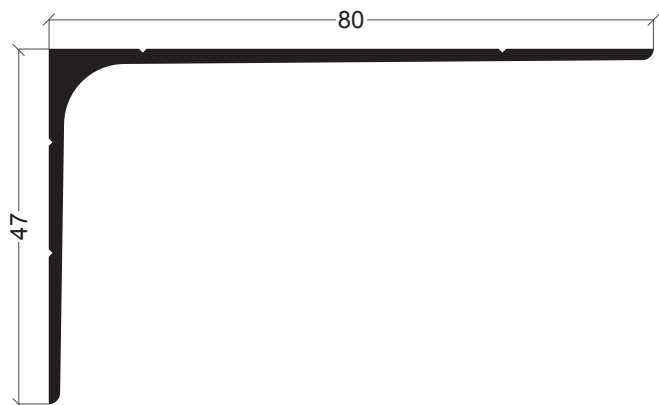

XP-15
Guia inferior de correr

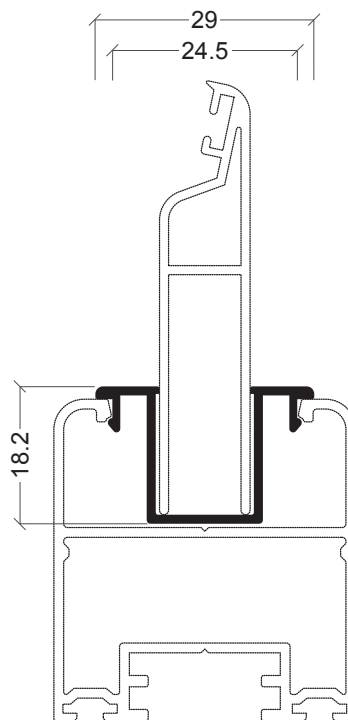

XP-19
Redutor para Z/54

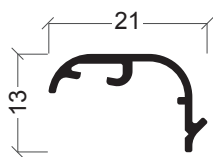

XP-17
Perfil batente de correr



AX-19
Vareta

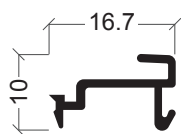

AX-33
Mola Bite

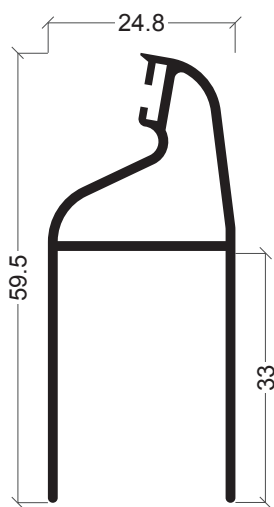

XP-01
Meia lâmina 33 mm

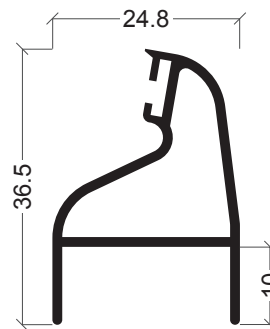

XP-02
Meia lâmina 10 mm

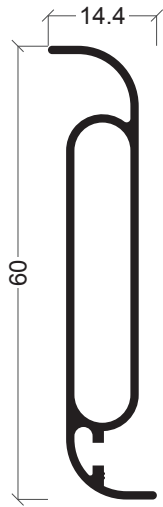

Z-52
Lâmina móvel

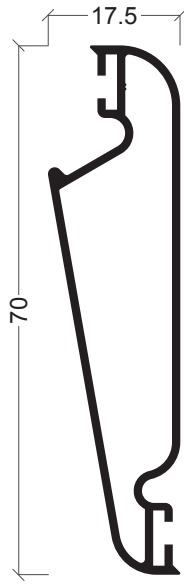

Z-53
Lâmina móvel

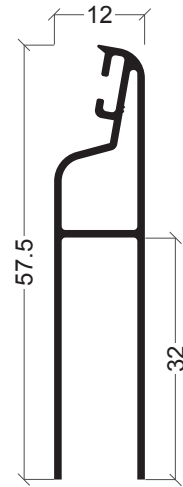

Z-54
Meia lâmina 32 mm

254

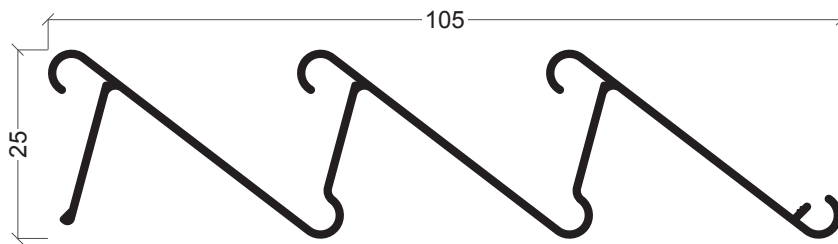

Z-20
Meia lâmina

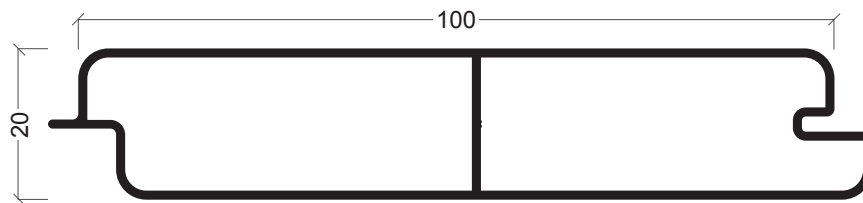

W-25
Lâmina de encaixe 100 x 20

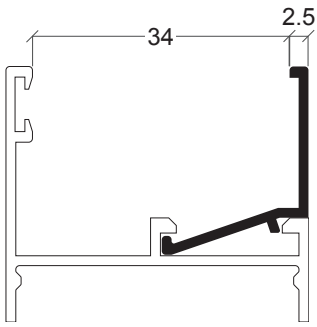

AX-69

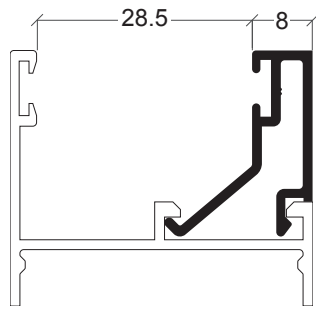

AX-74

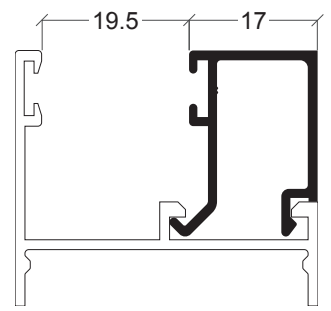

AX-46

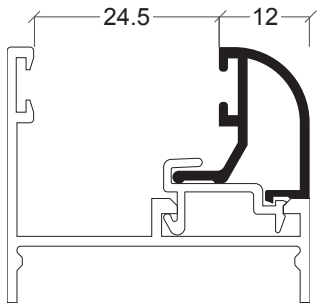

AX-37

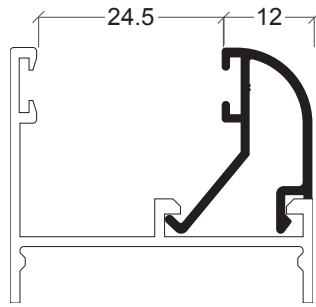

AZ-8

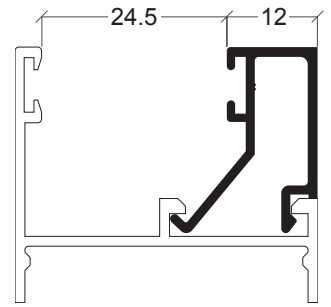

AX-36

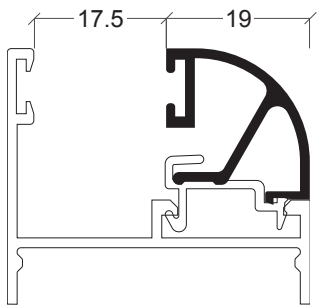

AX-30

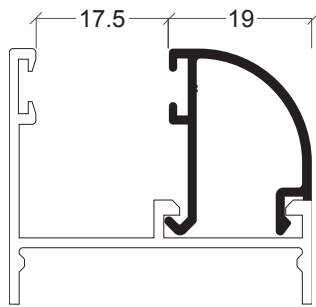

AZ-7

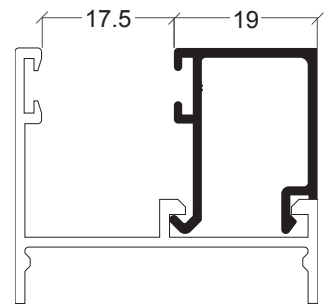

AX-35

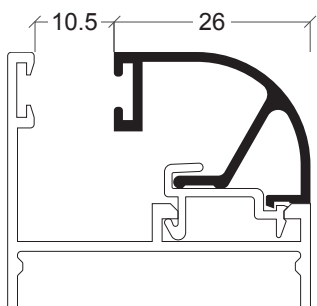

AX-29

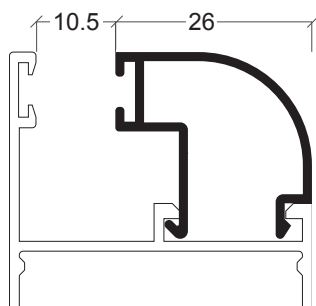

AZ-6

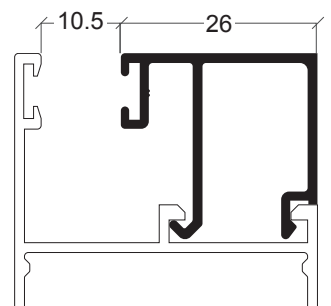

AX-31

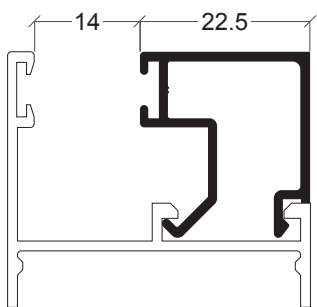

AX-78

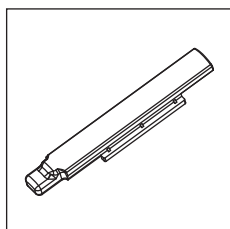

30 92 00 41

Terminal superior

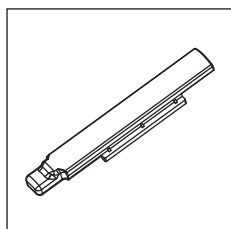

30 92 00 42

Terminal inferior

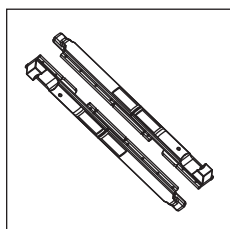

30 92 01 20

Fecho 2ª folha

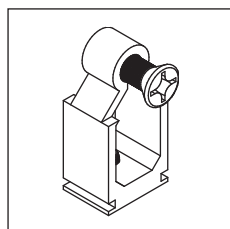

30 92 01 40

União topos janela

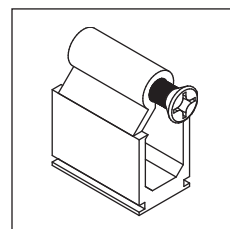

30 92 01 50

União topos porta

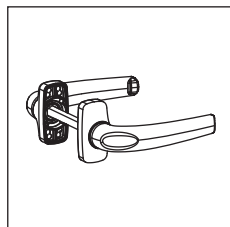

30 92 05 60

Puxador duplo

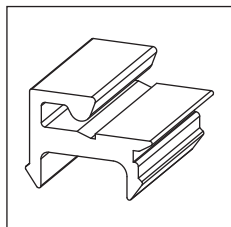

30 94 01 01

Mola bite plástica

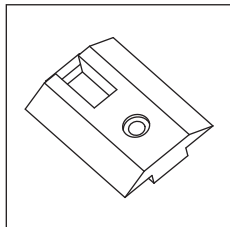

30 94 01 02

Complemento de fecho

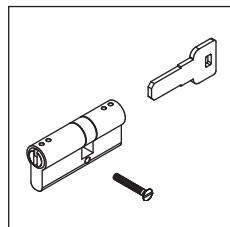

30 94 01 03

Canhão 30x30

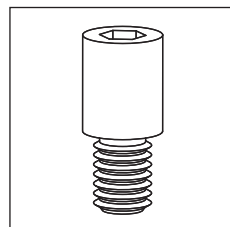

30 94 01 04

Jogo parafusos
distanciadores

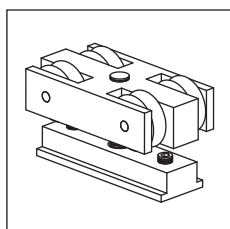

30 94 01 05

Rolamentos

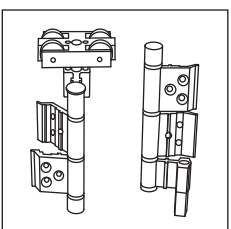

30 94 01 06/14

Rolamento e dobradiça
harmónio (branco/preto)

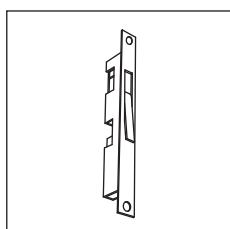

30 94 01 07/15

Fecho de embutir
(branco/preto)

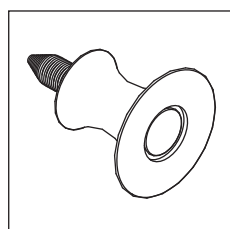

30 94 01 08/16

Aplicador fixador (branco/
preto)

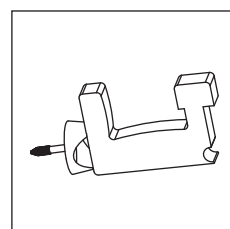

30 94 01 09/17

Fixador de portada 2
folhas (branco/preto)

256

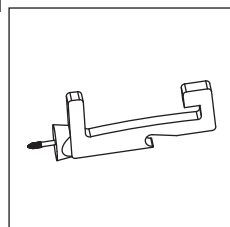

30 94 01 10/18

Fixador portada 4 folhas
(branco/preto)

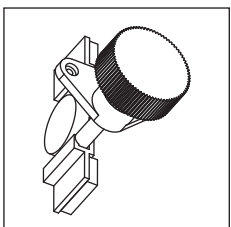

30 94 01 11/19

Comando lâminas
orientáveis (branco/preto)

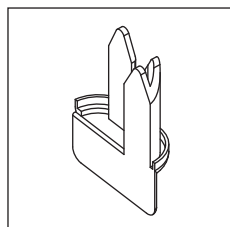

30 94 01 12/20

Jogo topos perfil batente
(branco/preto)

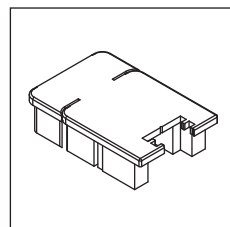

30 94 01 13/21

Tampa aro móvel
(branco/preto)

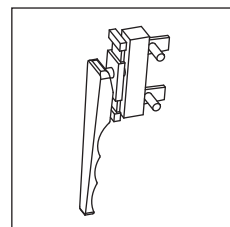

30 94 01 23/29 - 30 94 02 23/29

Cremone 4ª folha direito (branco/
preto) - esquerdo (branco/preto)

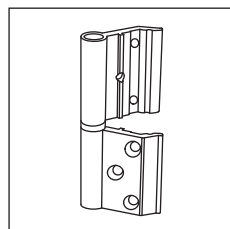

30 94 01 24/30

Dobradiça (branco/preto)

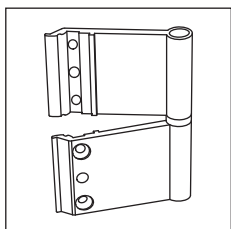

30 94 01 25/31

Dobradiça 4ª folha
(branco/preto)

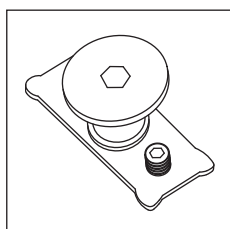

30 94 01 26

Distanciador aro

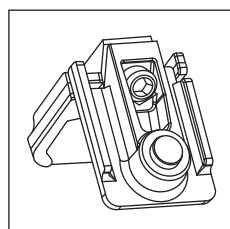

30 94 01 27

Esquadro janela

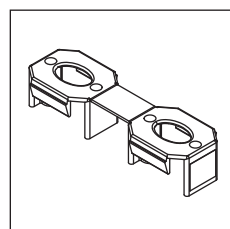

30 94 01 32

Distanciador travessa

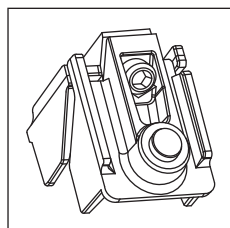

30 94 01 33

Esquadro porta

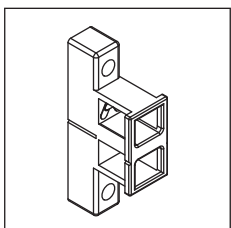

30 94 01 34

Fecho superior correr

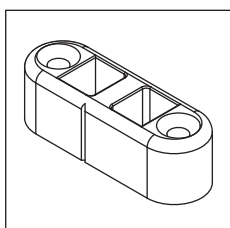

30 94 01 35

Fecho inferior correr

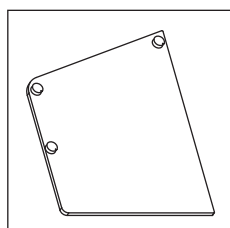

30 94 01 36

Tampa lateral correr
54 mm

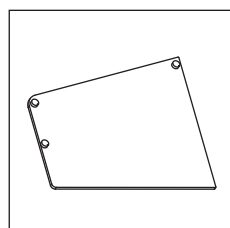

30 94 01 37

Tampa lateral correr
87 mm

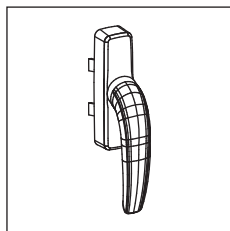

30 94 01 38

Cremone abertura exterior

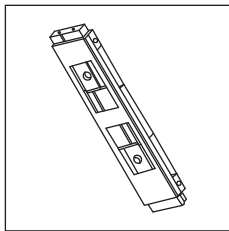

30 94 01 39

Kit fixação cremone abertura exterior

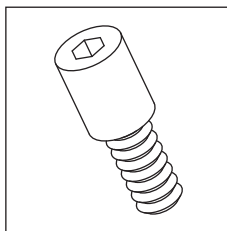

30 94 01 40

Distanciador abertura exterior 14 mm

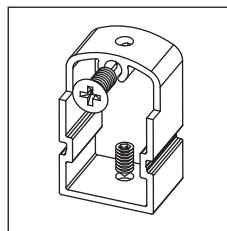

30 94 01 42

Topo travessa XP-10

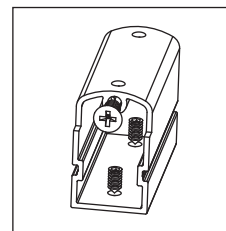

30 94 01 43

Topo travessa XP-16

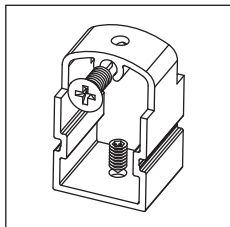

30 94 01 44

União topos janela

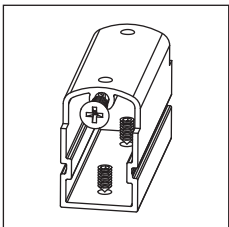

30 94 01 45







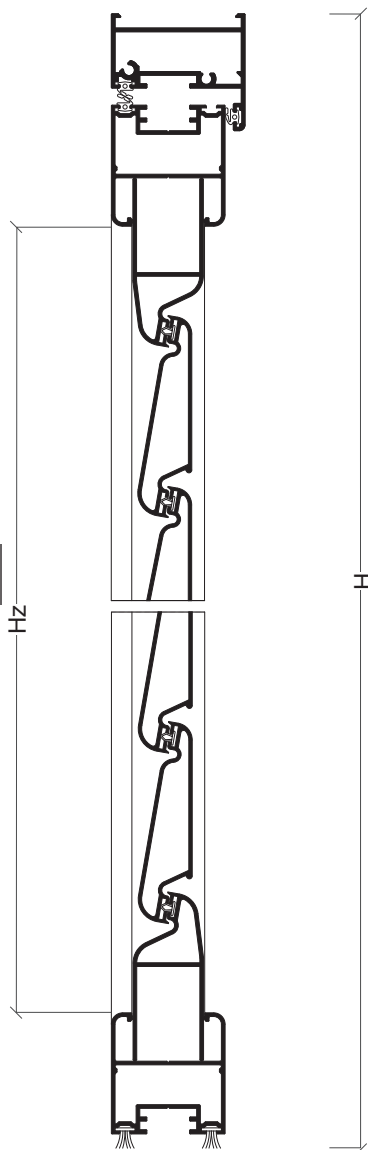
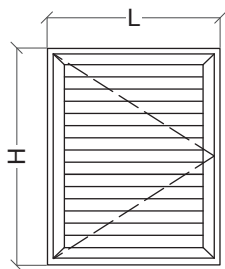

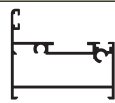

Topo travessa XP-27

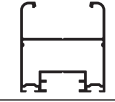
Referência	Desenho	Descrição
30 93 01 40		Junta lâminas
30 94 01 46		Junta interior/exterior
30 95 00 10		Pelúcia 7x9 mm
30 95 00 30		Pelúcia 7x7 mm

Janela 1 folha abertura exterior



Perfis

Desenho	Ref	Descrição	Corte	Quant	Medida
	XP-03	Aro fixo		1	L
				2	H
	XP-05	Aro móvel de janela		2	L-64 mm
				2	H-37 mm
	XP-01	Meia lâmina		2	L-173 mm
	Z-53	Lâmina		Segundo altura	L-163 mm
	AX-19	Vareta		2	Apro. H/2 mm

Acessórios e Juntas

Referência	Descrição	Quantidade
30 94 01 02	Complemento fecho de portada	2
30 94 01 09	Fixador de portada	1
30 94 01 24	Dobradiça branca	2
30 94 01 27	Esquadro de janela	6
30 92 00 41	Terminal de fecho	2
30 94 01 38	Cremona abertura exterior	1
30 94 01 39	Kit fixação cremone	1
30 94 01 40	Distanciador 14 mm abertura exterior	2
---	Jogo portalâminas (segundo altura)	1
30 93 01 40	Vedante lâminas	Nº lâminas + 1L
30 94 01 46	Junta interior/exterior	3L+6H
30 95 00 30	Pelúcia 7x7 mm	2L

Portalâminas

Hz = H-122 mm

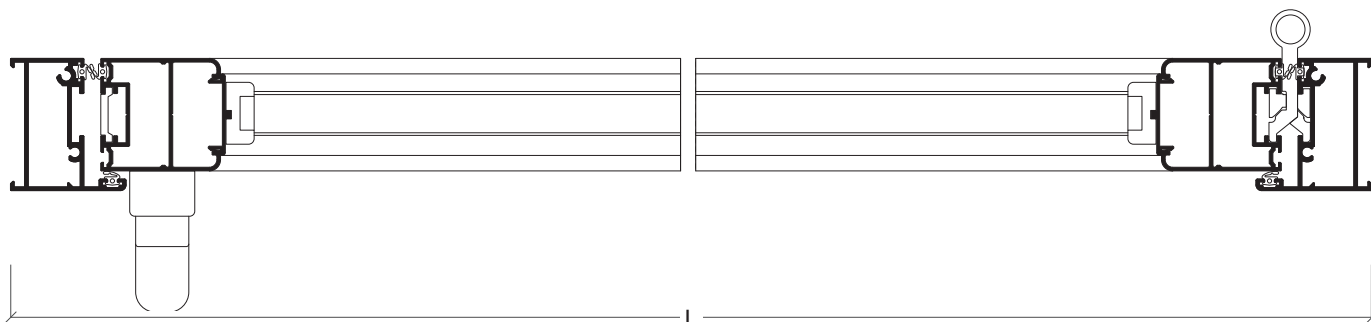

Janela 1 folha abertura exterior - lâminas fixas

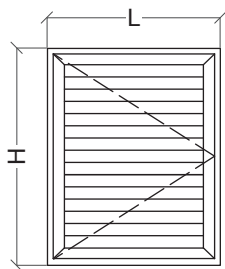

Perfis

Desenho	Ref	Descrição	Corte	Quant	Medida
	XP-03	Aro fixo		1	L
				2	H
	XP-05	Aro móvel de janela		2	L-64 mm
				2	H-37 mm
	W-25	Lâmina		Segundo altura	H-93 mm
	AX-19	Vareta		2	Apro. H/2 mm

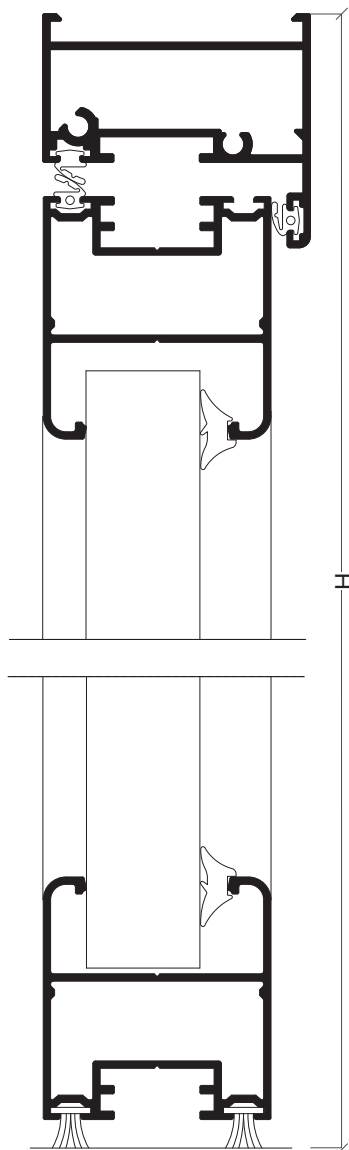

Acessórios e Juntas

Referência	Descrição	Quantidade
30 94 01 02	Complemento fecho de portada	2
30 94 01 09	Fixador de portada	1
30 94 01 24	Dobradiça branca	2
30 94 01 27	Esquadro de janela	6
30 92 00 40	Terminal de fecho	2
30 94 01 38	Cremone abertura exterior	1
30 94 01 39	Kit fixação cremone	1
30 94 01 40	Distanciador 14 mm abertura exterior	2
30 94 01 46	Junta interior/exterior	3L+6H
30 95 00 30	Pelúcia 7x7 mm	2L
30 93 00 65	Junta de cunha	2L+2H



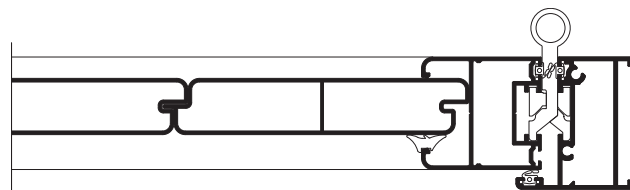
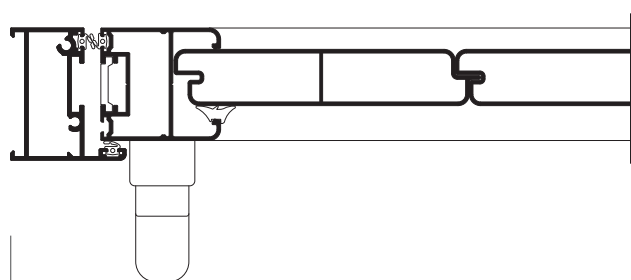



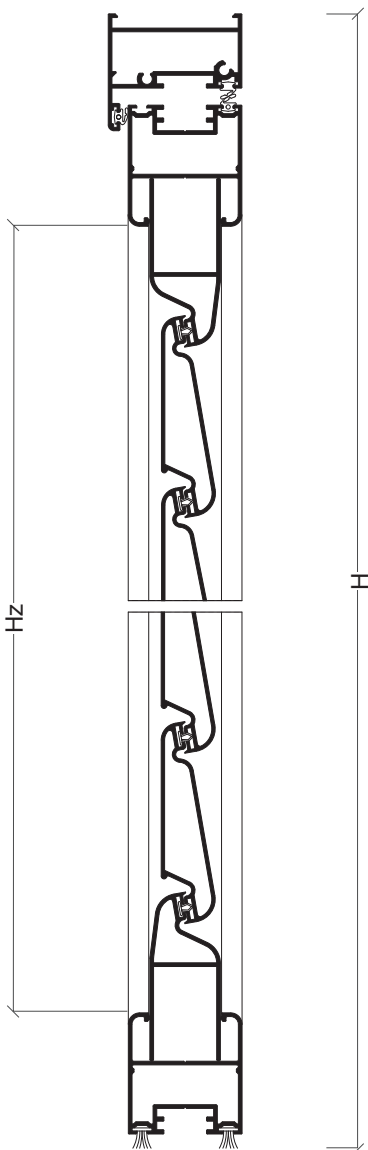
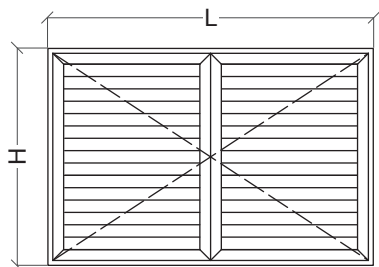



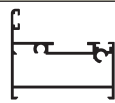

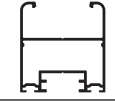
259



Janela 2 folhas abertura exterior



Perfis

Desenho	Ref	Descrição	Corte	Quant	Medida
	XP-03	Aro fixo		1	L
				2	H
	XP-05	Aro móvel de janela		4	L/2-37 mm
				4	H-37 mm
	XP-01	Meia lâmina		4	L/2-144 mm
	Z-53	Lâmina		Segundo altura	L/2-134 mm
	XP-04	Perfil de batente		2	H-37 mm
	AX-19	Vareta		2	Apro. H/2 mm

Acessórios e Juntas

Referência	Descrição	Quantidade
30 92 00 41	Terminal de fecho	2
30 94 01 02	Complemento fecho de portada	2
30 92 01 20	Fecho 2ª folha	2
30 94 01 09	Fixador de portada	2
30 94 01 12	Jogo topos para perfil batente	2
30 94 01 24	Dobradiça	4
30 94 01 27	Esquadro de janela	10
30 94 01 38	Cremone abertura exterior	1
30 94 01 39	Kit fixação cremone	1
30 94 01 40	Distanciador 14 mm abertura exterior	2
---	Jogo portalâminas (segundo altura)	1
30 93 01 40	Vedante lâminas	Nº lâminas + 1 L/2
30 94 01 46	Junta interior/exterior	2L+2L/2+8H
30 95 00 30	Pelúcia 7x7 mm	4L/2

Portalâminas

Hz = H-122 mm

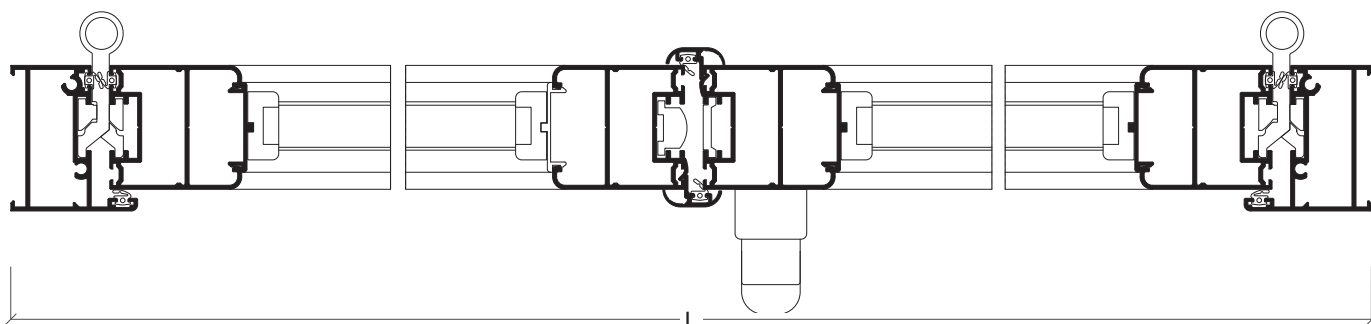

Janela 3 folhas abertura exterior

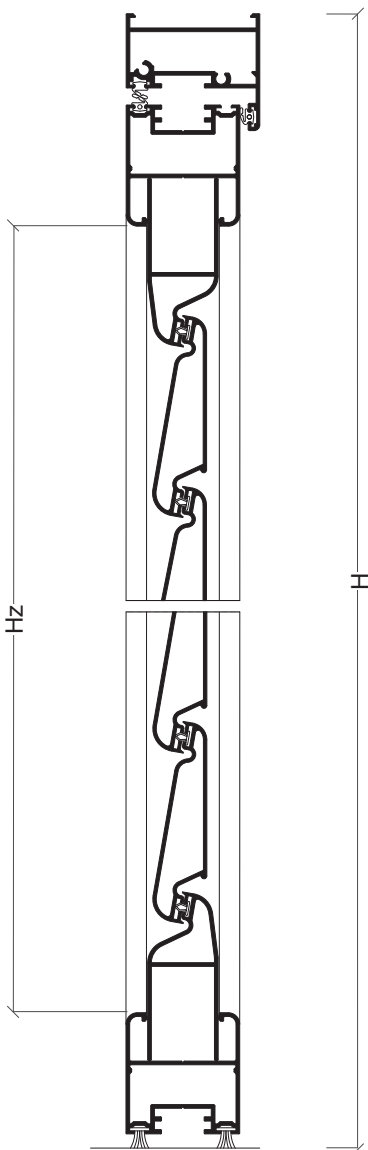
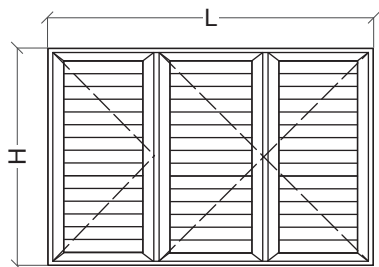

Perfis

Desenho	Ref	Descrição	Corte	Quant	Medida
	XP-03	Aro fixo		1	L
				2	H
	XP-05	Aro móvel de janela		4	Lat. = L/2-37 mm
				2	Cen. = L/3-42 mm
				6	H-37 mm
	XP-01	Meia lâmina		4	Lat. = L/3-126 mm
				2	Cen. = L/3-151 mm
	Z-53	Lâmina		Segundo altura	Lat. = L/3-116 mm
				Segundo altura	Cen. = L/3-141 mm
	XP-04	Perfil de batente		2	H-37 mm
	AX-19	Vareta		2	Apro. H/2 mm

Acessórios e Juntas

Referência	Descrição	Quantidade
30 92 00 41	Terminal de fecho	2
30 94 01 02	Complemento fecho de portada	4
30 92 01 20	Fecho 2ª folha	4
30 94 01 09	Fixador de portada (opcional)	1
30 94 01 10	Fixador de portada 3/4 folhas (opcional)	1
30 94 01 12	Jogo topos para perfil batente	3
30 94 01 24	Dobradiça	4
30 94 01 25	Dobradiça 3ª/4ª folha	2
30 94 01 27	Esquadro de janela	14
30 94 01 38	Cremone abertura exterior	1
30 94 01 39	Kit fixação cremone	1
30 94 01 40	Distanciador 14 mm abertura exterior	2
---	Jogo portalâminas (segundo altura)	3
30 93 01 40	Vedante lâminas	Nº lâminas + 1 L/3
30 94 01 46	Junta interior/exterior	2L+3L/3+11H
30 95 00 30	Pelúcia 7x7 mm	6L/2

261

Portalâminas

Hz = H-122 mm

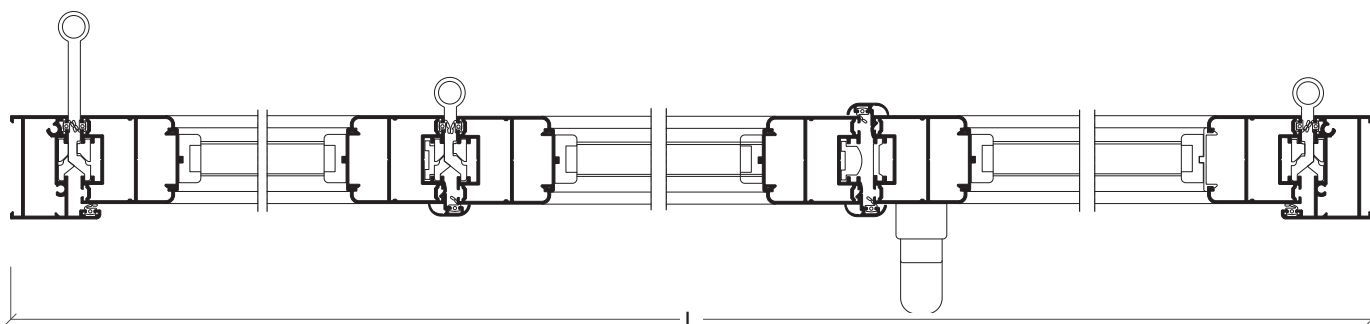

Janela 4 folhas abertura exterior

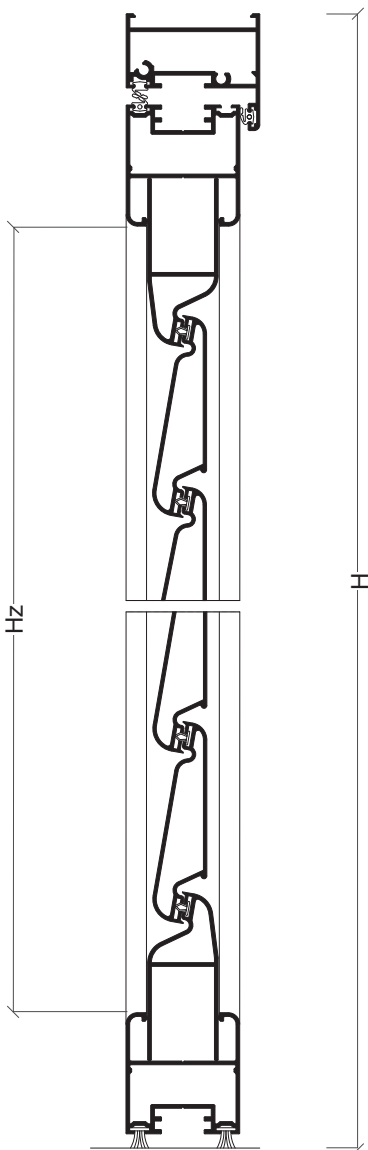
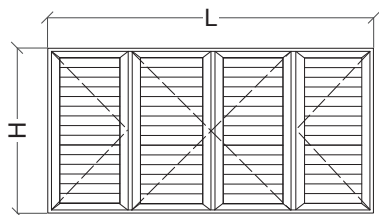

Perfis

Desenho	Ref	Descrição	Corte	Quant	Medida
	XP-03	Aro fixo		1	L
				2	H
	XP-05	Aro móvel de janela		4	Lat. = L/4-8 mm
				4	Cen. = L/4-33 mm
				8	H-37 mm
	XP-01	Meia lâmina		4	Lat. = L/4-117 mm
				4	Cen. = L/4-132 mm
	Z-53	Lâmina		Segundo altura	Lat. = L/4-107 mm
				Segundo altura	Cen. = L/4-132 mm
	XP-04	Perfil de batente		4	H-37 mm
	AX-19	Vareta		2	Apro. H/2 mm

Acessórios e Juntas

Referência	Descrição	Quantidade
30 92 00 41	Terminal de fecho	2
30 94 01 02	Complemento fecho de portada	6
30 92 01 20	Fecho 2ª folha	6
30 94 01 09	Fixador de portada (opcional)	2
30 94 01 10	Fixador de portada 3/4 folhas (opcional)	2
30 94 01 12	Jogo topos para perfil batente	4
30 94 01 24	Dobradiça	4
30 94 01 25	Dobradiça 3ª/4ª folha	4
30 94 01 27	Esquadro de janela	18
30 94 01 38	Cremone abertura exterior	1
30 94 01 39	Kit fixação cremone	1
30 94 01 40	Distanciador 14 mm abertura exterior	2
---	Jogo portalâminas (segundo altura)	4
30 93 01 40	Vedante lâminas	Nº lâminas + 1 L/4
30 94 01 46	Junta interior/exterior	2L+4L/4+14H
30 95 00 30	Pelúcia 7x7 mm	8L/4

Portalâminas

Hz = H-122 mm

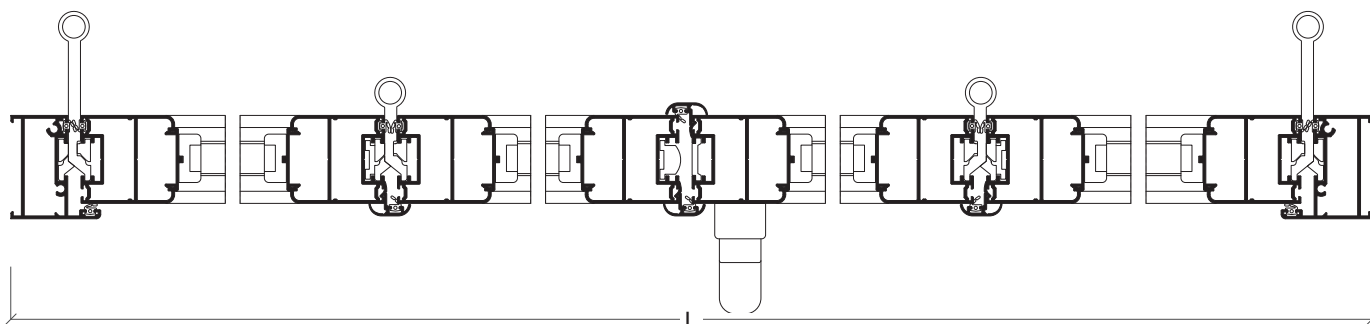

Porta 2 folhas abertura exterior

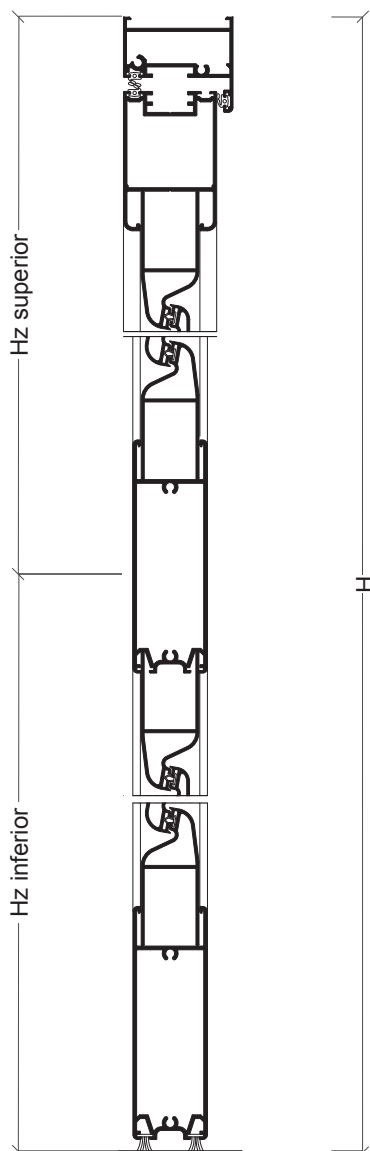
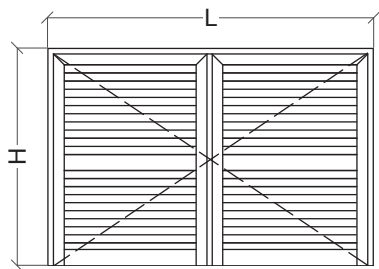

Perfis

Desenho	Ref	Descrição	Corte	Quant	Medida
	XP-03	Aro fixo		1	L
				2	H
	XP-18	Aro móvel de porta		2	L/2-35 mm
				4	H-37 mm
	XP-16	Almofada 100 mm		4	L/2-154 mm
	XP-01	Meia lâmina		8	L/2-178 mm
	Z-53	Lâmina		Segundo altura	L/2-168 mm
	XP-04	Perfil de batente		2	H-37 mm
	AX-19	Vareta		2	Apro. H/2 mm

Acessórios e Juntas

Referência	Descrição	Quantidade
30 94 01 38	Cremona abertura exterior	1
30 94 01 02	Complemento fecho de portada	2
30 94 01 39	Kit fixação cremona	1
30 94 01 12	Jogo topos para perfil batente	2
30 94 01 13	Tampa da folha	4
30 94 01 24	Dobradiça	8
30 94 01 27	Esquadro de janela	2
30 94 01 32	Distanciador de travessa	8
30 94 01 33	Esquadro porta	4
30 92 02 40	Fecho 2ª folha	6
30 94 01 40	Distanciador 14 mm abertura exterior	2
30 92 05 60	Puxador duplo	1
---	Jogo portalâminas (segundo Hz superior)	2
---	Jogo portalâminas (segundo Hv inferior)	2
30 93 01 40	Vedante lâminas	Nº lâminas + 2 L/2
30 94 01 46	Junta interior/exterior	2L+2L/2+8H
30 95 00 30	Pelúcia 7x7 mm	4L/2

Portalâminas



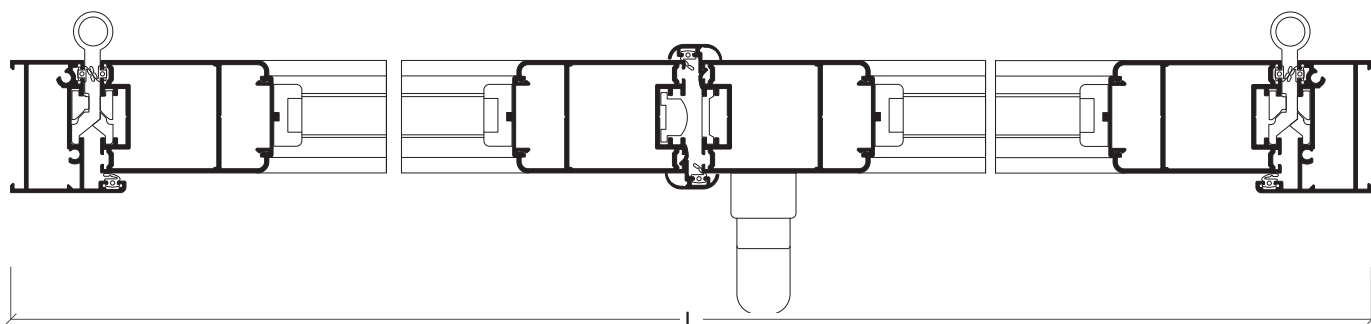

Hz superior = H1-148 mm
Hv inferior = H2-161 mm

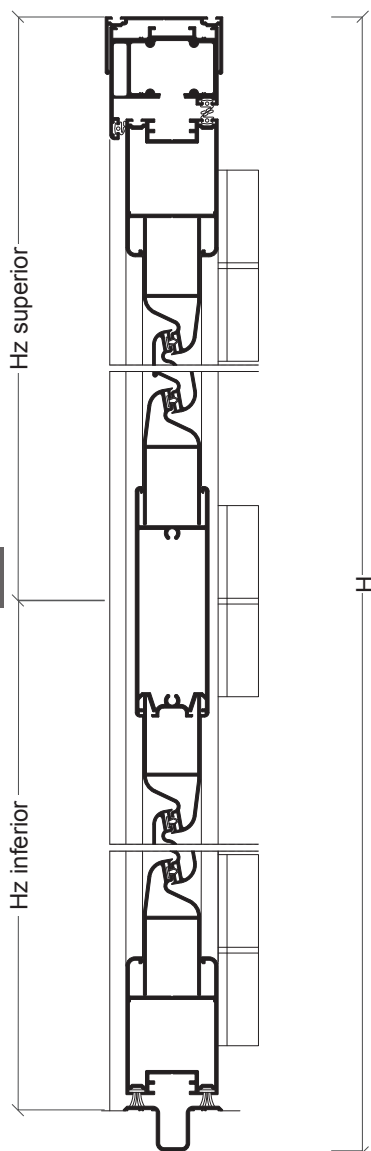
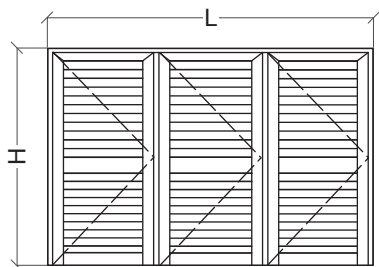

Porta 3 folhas harmónio abertura exterior



Perfis

Desenho	Ref	Descrição	Corte	Quant	Medida
	XP-20	Distanciador de aro		1	L
	XP-21	Aro fixo para carril		1	L
	XP-03	Aro fixo		2	H-31 mm
	XP-18	Aro móvel de porta		6	L/3-25 mm
				6	H-47 mm
	XP-16	Almofada 100 mm		3	L/3-145 mm
	XP-01	Meia lâmina		12	L/3-168 mm
	Z-53	Lâmina		Segundo altura	L/3-158 mm
	XP-23	Guia de embutir		1	L
	AX-19	Vareta		2	Apro. H

Dimensões máximas: 800x2500 mm por folha
 Peso máximo: 40 Kg por folha

Acessórios e Juntas

Referência	Descrição	Quantidade
30 94 01 04	Jogo parafusos distanciadores	2
30 94 01 07	Fecho de embutir portada	2
30 94 01 08	Aplique fixador	2
30 94 01 06	Rolamentos/dobradiças harmónio	1
30 94 01 23	Cremona 4 folhas (opcional a A)	2
30 94 01 24	Dobradiça	8
30 94 01 26	Distanciador de pavimento	4
30 94 01 32	Distanciador chão	8
30 94 01 33	Esquadro porta	12
30 92 00 41	Terminal fecho	2
30 92 00 42	Terminal fecho inferior	2
---	Jogo portalâminas (segundo Hz superior)	3
---	Jogo portalâminas (segundo Hz inferior)	3
30 93 01 40	Vedante lâminas	Nº lâminas + 2 L/3
30 94 01 46	Junta interior/exterior	2L+3L/3+14H
30 95 00 30	Pelúcia 7x7 mm	6L/3

Portalâminas



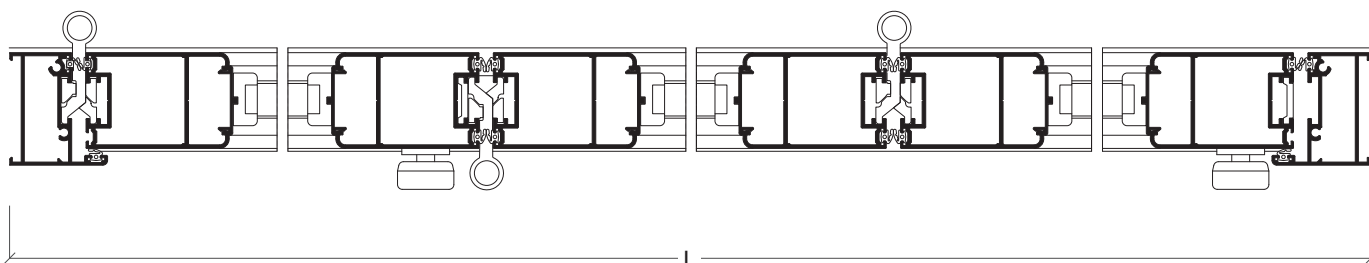



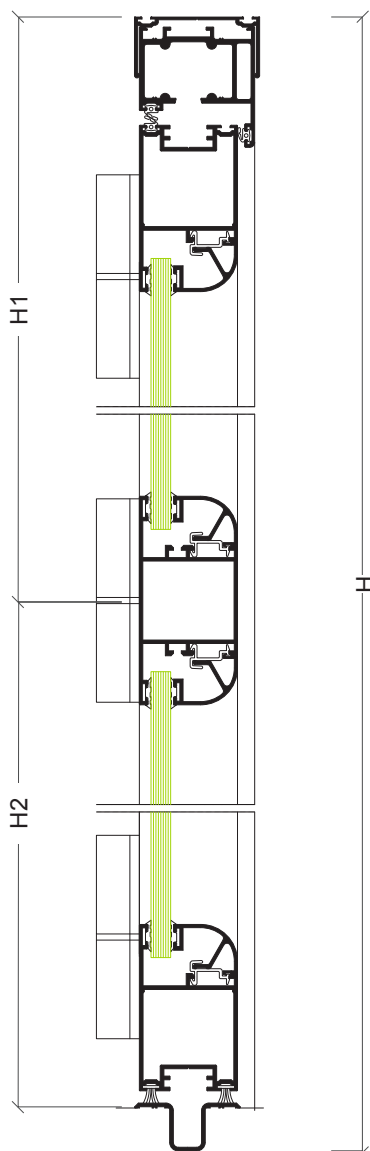
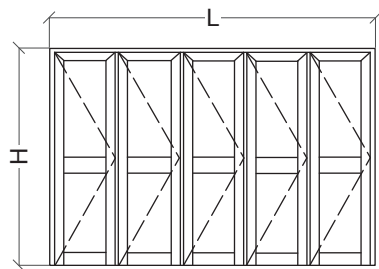















Hz superior = H1-156 mm
Hz inferior = H2-123 mm



Porta 5 folhas harmónio abertura exterior com vidro



Perfis

Desenho	Ref	Descrição	Corte	Quant	Medida
	XP-20	Distanciador de aro		1	L
	XP-21	Aro fixo para carril		1	L
	XP-03	Aro fixo		2	H-31 mm
	XP-22	Aro móvel de porta		10	L/5-17 mm
				10	H-47 mm
	AZ-09	Travessa		5	L/5-103 mm
	AZ-06	Bite redondo		10	H1-100 mm
				10	H2-67 mm
	AX-29	Bite redondo		20	L/5-113 mm
	AX-33	Mola bite		A cada 300 mm	80 mm
	XP-23	Guia de embutir		1	L
	AX-19	Vareta		2	Apro. H

Dimensões máximas: 800x2500 mm por folha
 Peso máximo: 40 Kg por folha

Acessórios e Juntas

Referência	Descrição	Quantidade
30 94 01 04	Jogo parafusos distanciadores	3
30 94 01 07	Fecho de embutir portada	3
30 94 01 08	Aplique fixador	3
30 94 01 06	Rolamentos/dobradiças harmónio	2
30 94 01 23	Cremona 4 folhas (opcional a A)	3
30 94 01 24	Dobradiça	11
30 94 01 26	Distanciador de aro	1 a cada 50 cm
30 94 01 33	Esquadro porta	20
30 92 00 41	Terminal fecho	3
30 92 00 42	Terminal fecho inferior	3
30 92 01 50	União topos porta	10
30 94 01 46	Junta interior/exterior	2L+5L/5+22H
30 95 00 30	Pelúcia 7x7 mm	10L/5
---	Junta exterior vidro	4L+10H
---	Junta interior vidro	4L+10H

Vidros

L/5-126 mm	H1-123 mm
L/5-126 mm	H2-90 mm

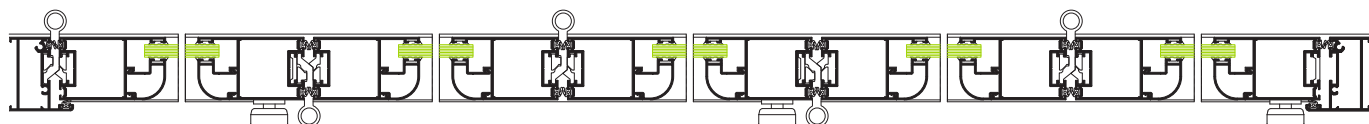

Janela 1 folha correr

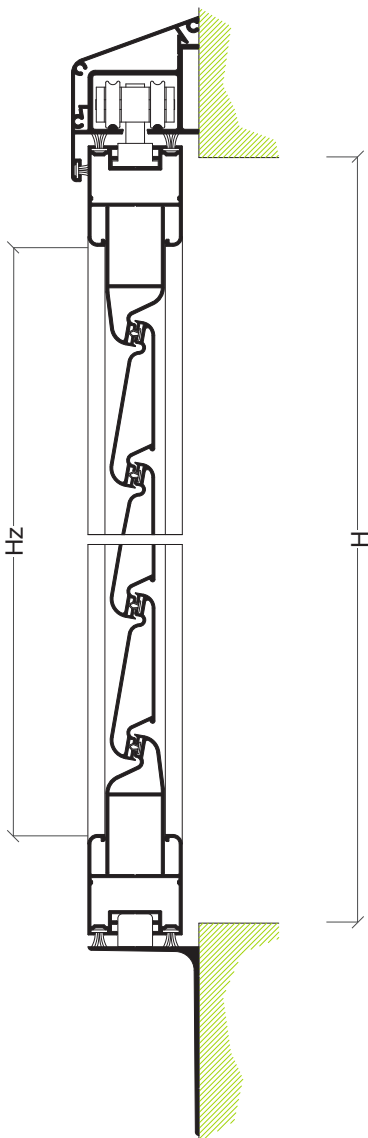
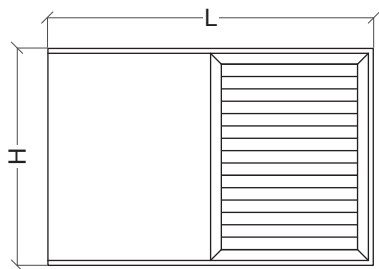

Perfis

Desenho	Ref	Descrição	Corte	Quant	Medida
	XP-07	Guia superior de correr		1	2L+59 mm
	XP-05	Aro móvel de janela		2	L+10 mm
				2	L+10 mm
	XP-01	Meia lâmina		2	L-99 mm
	Z-53	Lâmina		Segundo altura	L-89 mm
	AX-19	Vareta		2	Apro. H/2 mm
	XP-06	Tampa da guia superior		1	2L+59 mm
	XP-08	Tampa lateral de correr		2	H+10 mm
	XP-15	Guia inferior de correr		1	2L+59 mm

Acessórios e Juntas

Referência	Descrição	Quantidade
30 94 01 04	Jogo parafusos distanciadores	1
30 94 01 05	Rolamentos portada de correr	2
30 94 01 07	Fecho de embutir portada	1
30 94 01 27	Esquadro de janela	4
30 94 01 34	Fecho superior correr	2
30 94 01 35	Fecho inferior correr	2
30 94 01 36	Tampa lateral	2
30 92 00 41	Terminal fecho	2
---	Jogo portalâminas (segundo altura)	1
30 93 01 40	Vedante lâminas	Nº lâminas + 1 L
30 95 00 10	Pelúcia 7x9 mm	4L+2H+12L

Portalâminas

Hz = H-75 mm

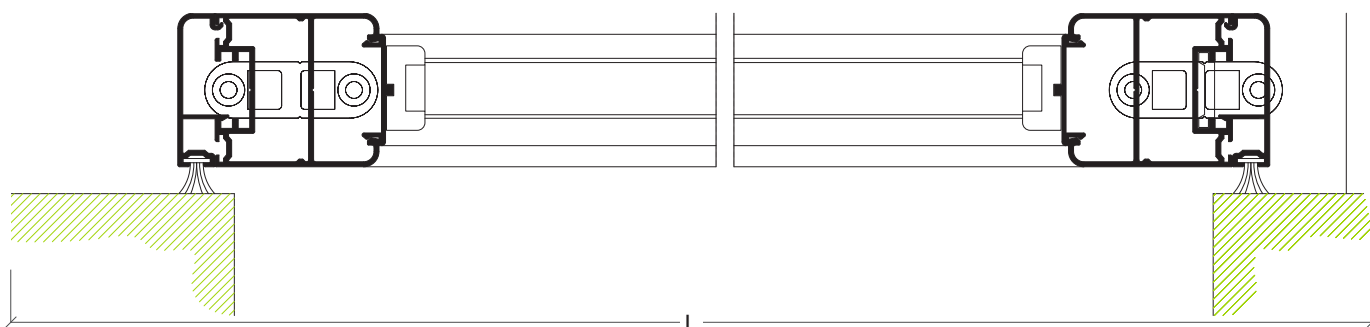

Janela 2 folhas correr

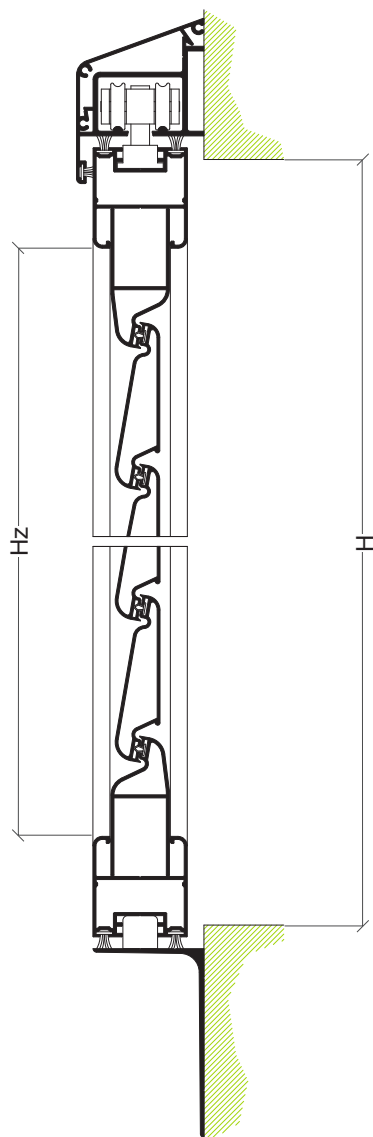
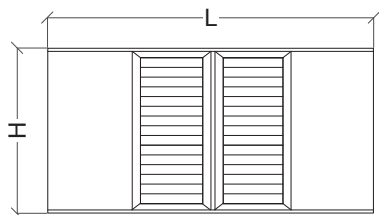

Perfis

Desenho	Ref	Descrição	Corte	Quant	Medida
	XP-07	Guia superior de correr		1	2L+19 mm
	XP-05	Aro móvel de janela		4	L/2 mm
				4	H+10 mm
	XP-01	Meia lâmina		4	L/2-109 mm
	Z-53	Lâmina		Segundo altura	L/2-99 mm
	AX-19	Vareta		2	Apro. H/2 mm
	XP-06	Tampa da guia superior		1	2L+19 mm
	XP-08	Tampa lateral de correr		2	H+10 mm
	XP-15	Guia inferior de correr		1	2L+19 mm
	XP-17	Perfil de batente		2	H-7 mm

Acessórios e Juntas

Referência	Descrição	Quantidade
30 94 01 04	Jogo parafusos distanciadores	2
30 94 01 05	Rolamentos portada de correr	4
30 94 01 07	Fecho de embutir portada	2
30 94 01 12	Jogo topos para perfil batente	2
30 94 01 27	Esquadro de janela	8
30 94 01 34	Fecho superior correr	3
30 94 01 35	Fecho inferior correr	3
30 94 01 36	Tampa lateral	2
30 92 00 41	Terminal fecho	4
---	Jogo portalâminas (segundo altura)	2
30 93 01 40	Vedante lâminas	Nº lâminas + L/2
30 95 00 10	Pelúcia 7x9 mm	8L/2+4H+12L

267

Portalâminas

Hz = H-75 mm

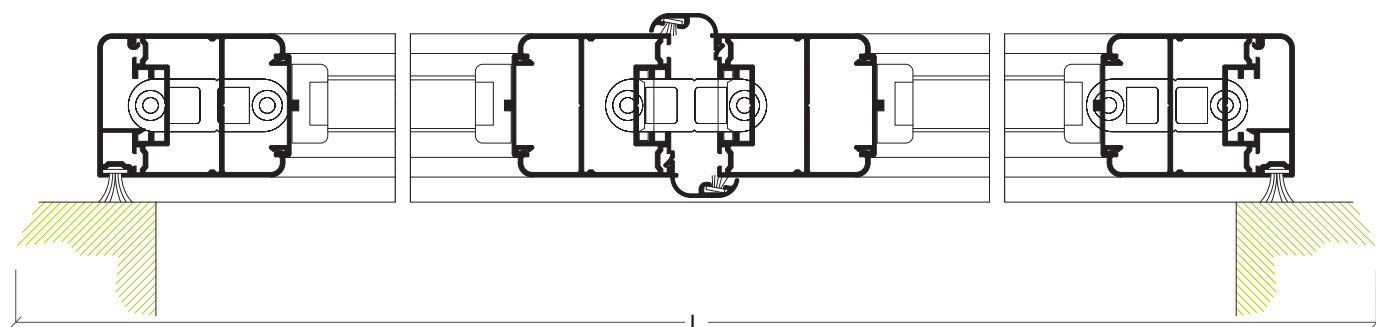

Janela 2 folhas correr afastada

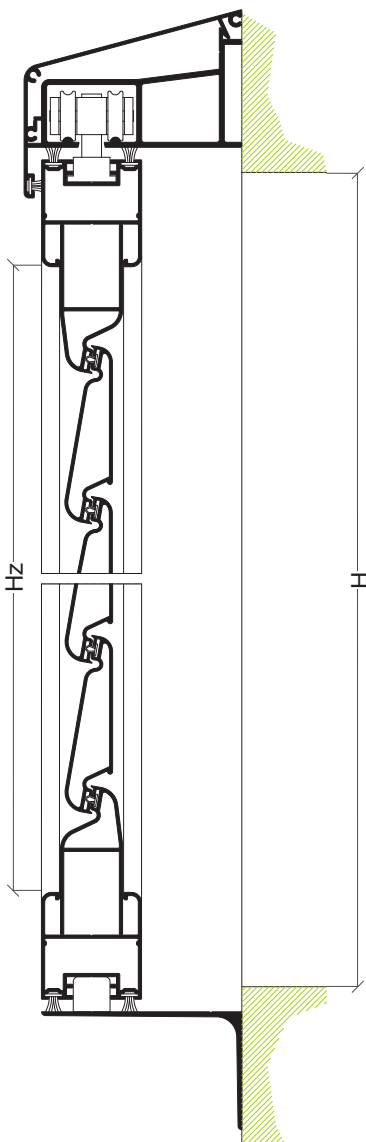
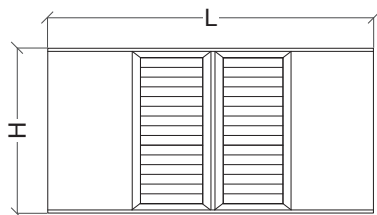

Perfis

Desenho	Ref	Descrição	Corte	Quant	Medida
	XP-13	Guia superior de correr larga		1	2L+19 mm
	XP-05	Aro móvel de janela		4	L/2 mm
				4	H+10 mm
	XP-01	Meia lâmina		4	L/2-109 mm
	Z-53	Lâmina		Segundo altura	L/2-99 mm
	AX-19	Vareta		2	Apro. H/2 mm
	XP-12	Tampa guia superior larga		2	2L+19 mm
	XP-14	Tampa lateral de correr larga		2	H+10 mm
	XP-15	Guia inferior de correr		1	2L+19 mm
	XP-17	Perfil de batente		2	H-7 mm

Acessórios e Juntas

Referência	Descrição	Quantidade
30 94 01 04	Jogo parafusos es	2
30 94 01 05	Rolamentos portada de correr	4
30 94 01 07	Fecho de embutir portada	2
30 94 01 12	Jogo topos para perfil batente	2
30 94 01 27	Esquadro de janela	8
30 94 01 34	Fecho superior correr	3
30 94 01 35	Fecho inferior correr	3
30 94 01 36	Tampa lateral	2
30 92 00 41	Terminal fecho	4
---	Jogo portalâminas (segundo altura)	2
30 93 01 40	Vedante lâminas	Nº lâminas + L/2
30 95 00 10	Pelúcia 7x9 mm	8L/2+4H+12L

Portalâminas

Hz = H-75 mm

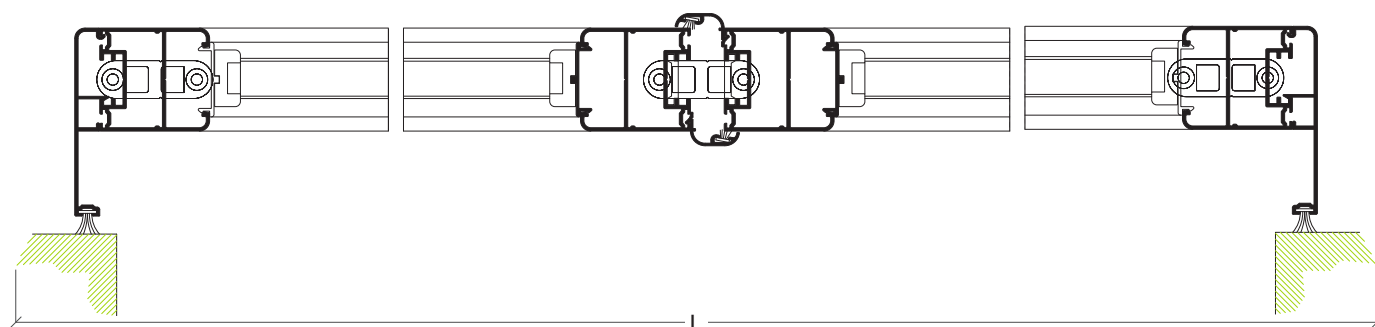

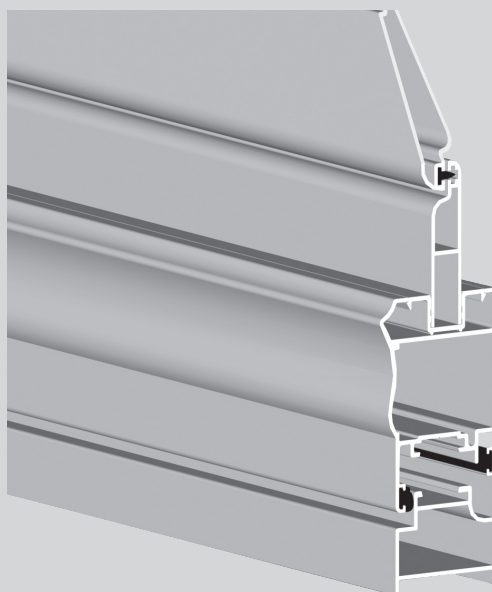

Sistema
BE

Sistema BE

Sistema de Portadas

Características do sistema

Sistema de portada que oferece a possibilidade de dois tipos de lâminas:

- Lâminas fixas
- Lâminas orientáveis

As lâminas orientáveis permitem uma total regulação através de mecanismos de rotação que permitem assim um controle da luminosidade de interior.

Perfis de alumínio

As secções do aro e do móvel são ambas de 40 mm, com uma espessura média dos perfis de alumínio de 1.5 mm.

Dimensionamento e manobralidade

Possibilidades de abertura: exterior (1, 2 ,3 e 4 folhas);

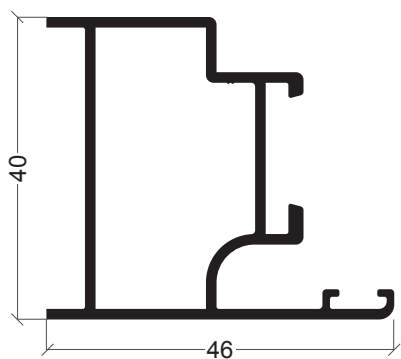

BE-01

Aro fixo

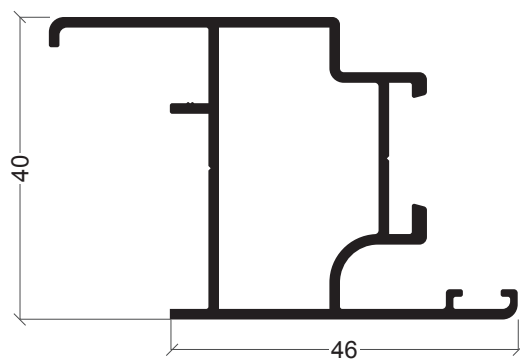

BE-27

Aro fixo com remate

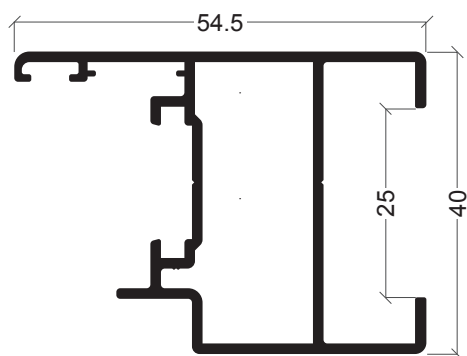

BE-19

Aro móvel caixa 25 mm

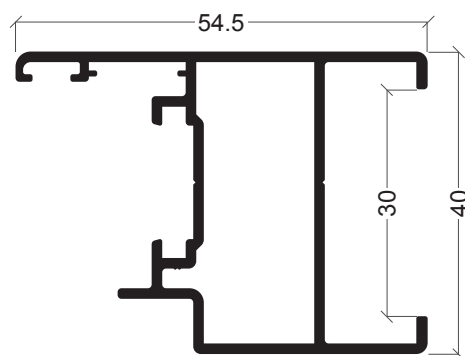

BE-03

Aro móvel caixa 30 mm

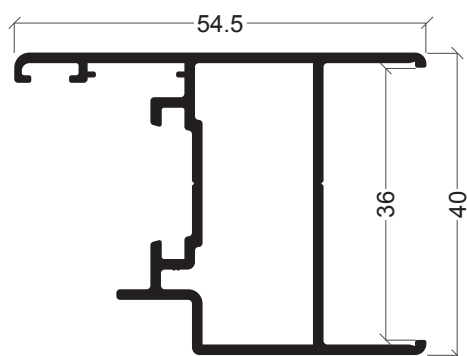

BE-02

Aro móvel caixa 36 mm

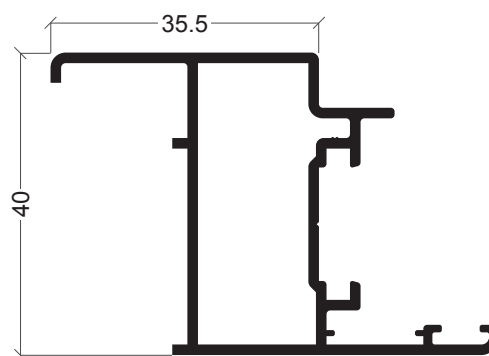

BE-17

Aro fixo com remate

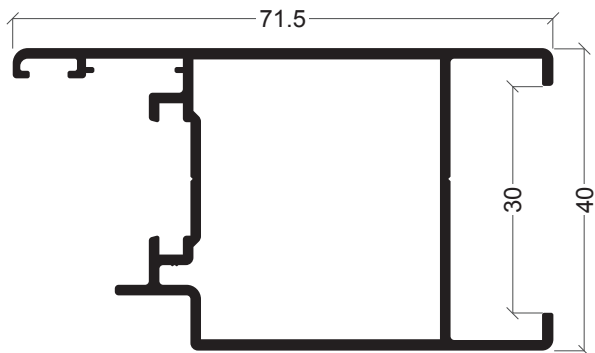

BE-22
Aro móvel caixa 30 mm

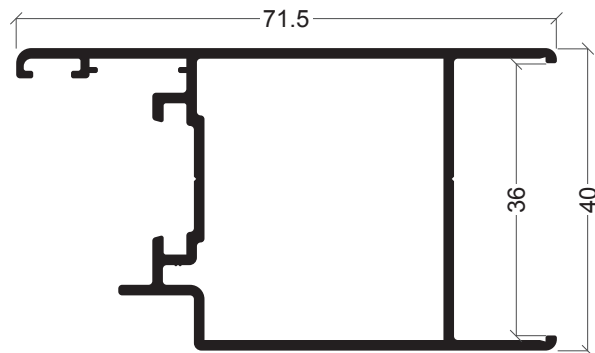

BE-23
Aro móvel caixa 36 mm

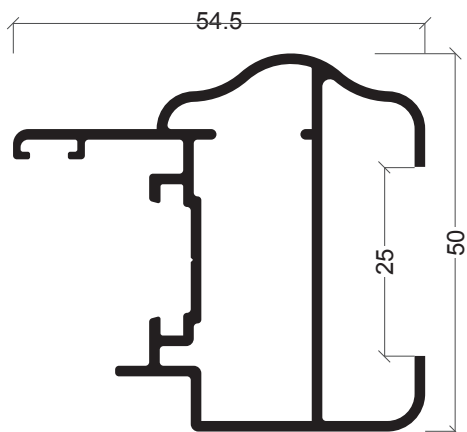

BE-20
Aro móvel decorativo caixa 25 mm

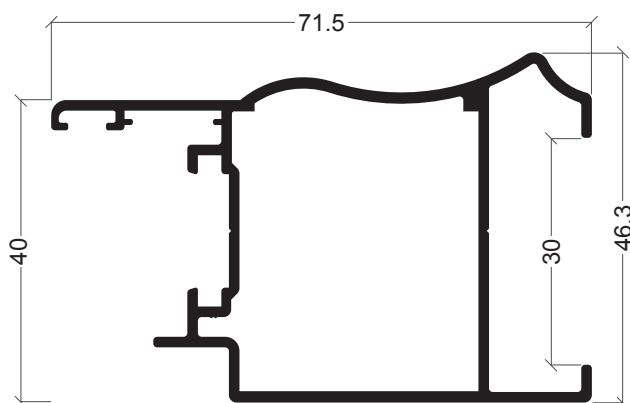

BE-24
Aro móvel decorativo caixa 36 mm

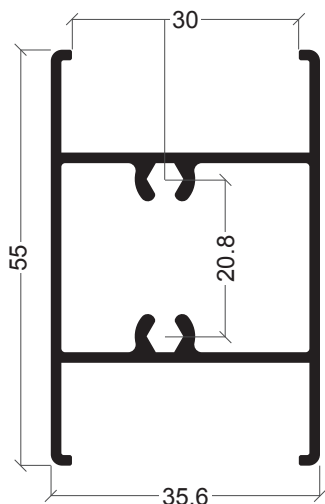

BE-05
Travessa caixa 30 mm

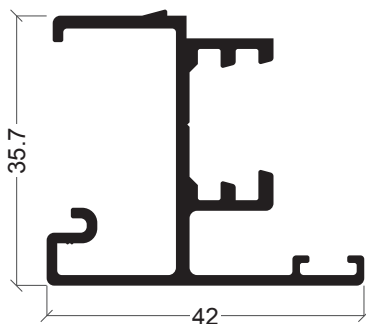

BE-04
Inversor

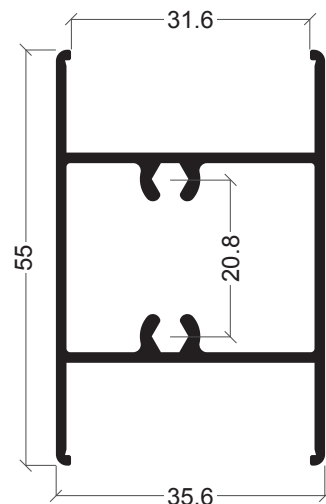

BE-06
Travessa caixa 31.6 mm

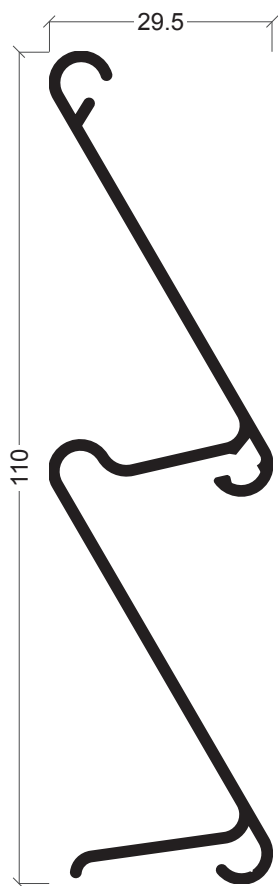

Z-34
Lâmina fixa

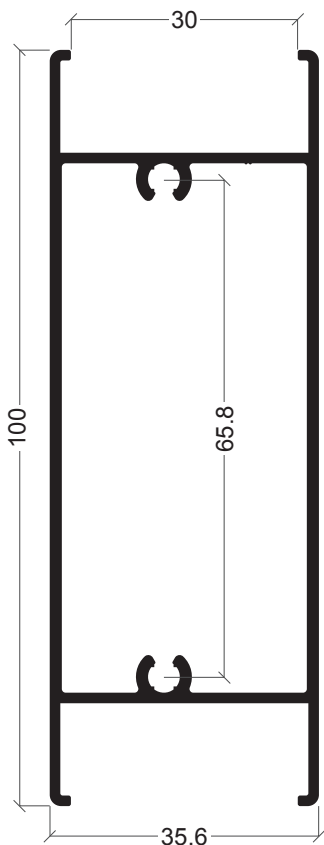

BE-09
Travessa caixa 30 mm

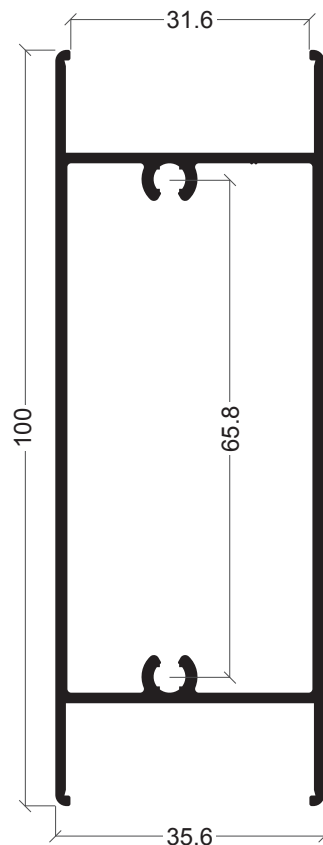

BE-10
Travessa caixa 31.6 mm

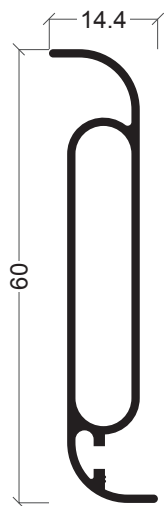

Z-52
Lâmina móvel

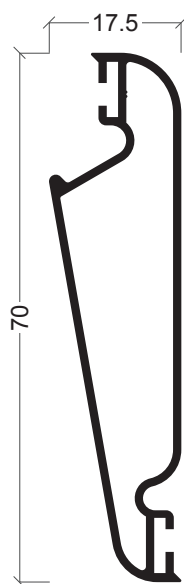

Z-53
Lâmina móvel

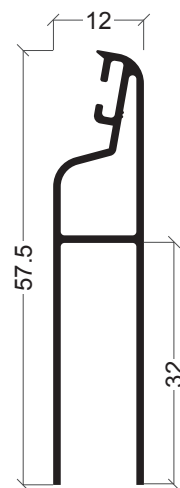

Z-54
Meia lâmina 32 mm



BE-12
Calha fecho

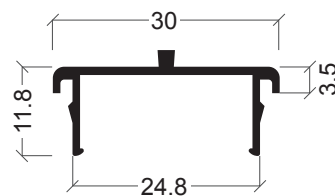

BE-18
Calha comando

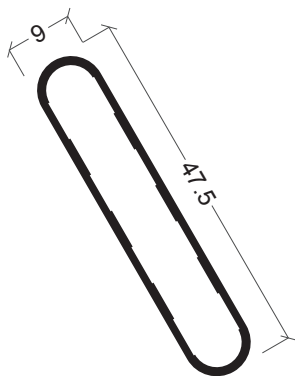

Z-35
Lâmina fixa

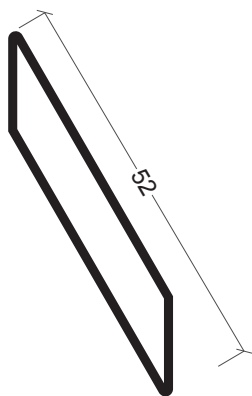

Z-40
Lâmina fixa

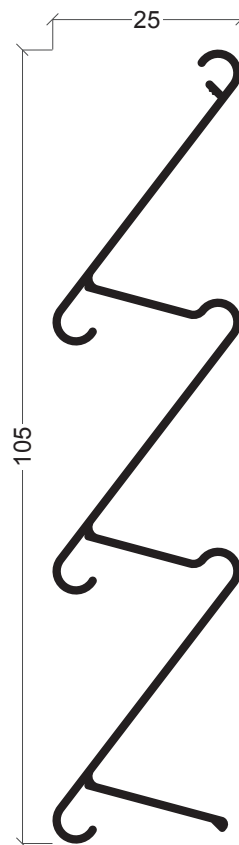

Z-20
Lâmina fixa

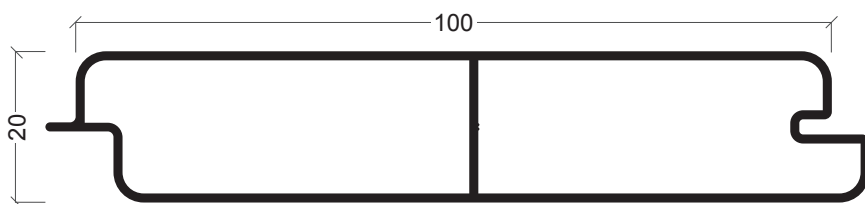

W-25
Lâmina de encaixe 100 x 20

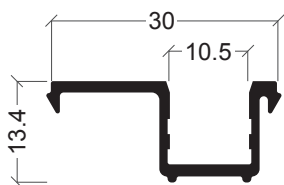

BE-26
Calha fecho

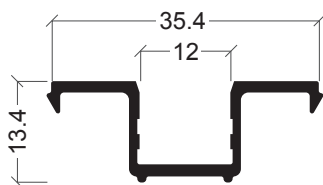

BE-15
Compensador

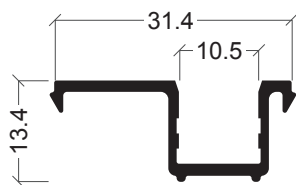

BE-11
Compensador

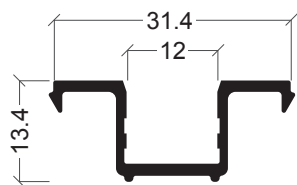

BE-16
Compensador

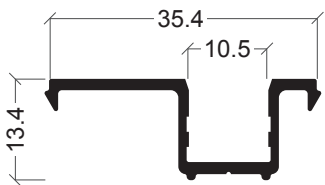

BE-08
Compensador

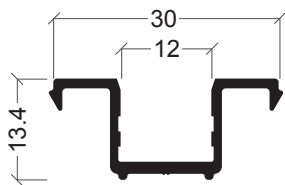

BE-25
Compensador

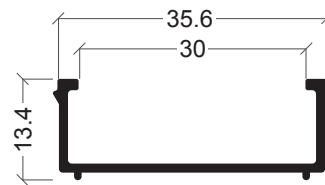

BE-14
Redutor

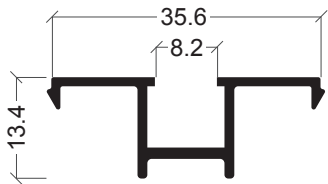

BE-07
Compensador

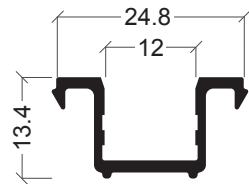

BE-21
Compensador

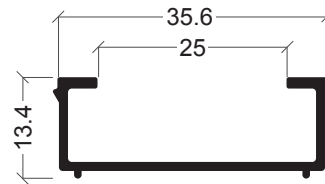





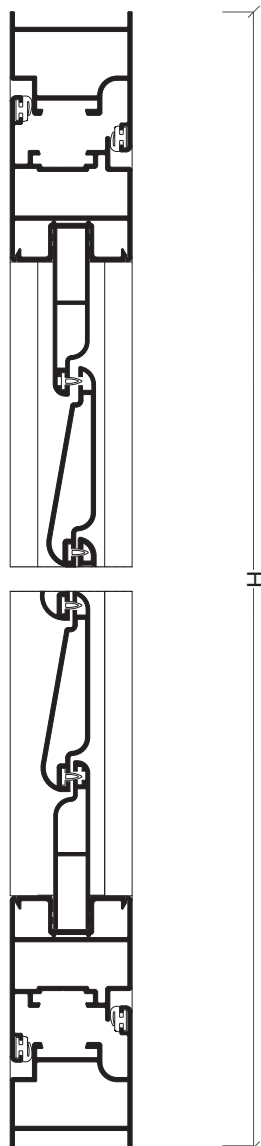
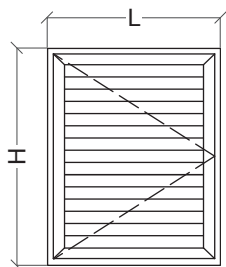





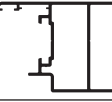

BE-13
Redutor

Janela 1 folha abertura exterior

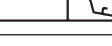

Perfis

Desenho	Ref	Descrição	Corte	Quant	Medida
	BE-01	Aro fixo		2	L
				2	H
	BE-02	Aro móvel		2	L-55 mm
				2	H-55 mm
	BE-15	Compensador		2	L-164 mm
	Z-53	Lâmina		Segundo altura	L-184 mm
	Z-54	Meia lâmina		2	L-184 mm
	AX-19	Vareta		2	Apro. H/2 mm

Acessórios e Juntas

Referência	Descrição	Quantidade
---	Dobradiça aro fixo	3
31 02 70 01	Esquadro janela	8
30 94 01 38	Cremona abertura exterior	1
30 94 01 39	Kit fixação cremona	1
30 94 01 40	Parafuso de ligação	2
30 92 00 40	Terminal de fecho	2
---	Contra-fecho aro fixo	2
30 96 00 22	Esquadro alinhamento	4
30 94 01 09	Fixador de portada	1
---	Jogo portalaminas (segundo altura)	1
30 92 09 60	Comando rotativo	1
31 02 60 50	Junta de batente	4L+4H
30 93 01 40	Junta para lamina	(nº laminas + 1) L

275

Portalâminas

Hv = H-164 mm

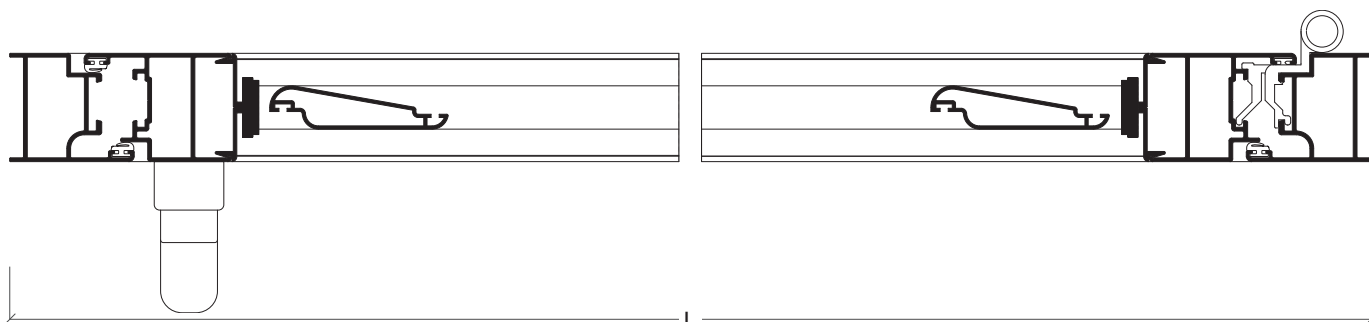

Janela 2 folhas abertura exterior

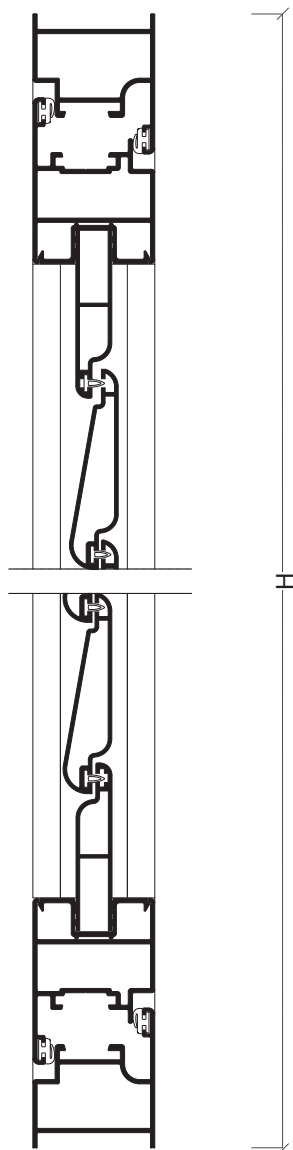
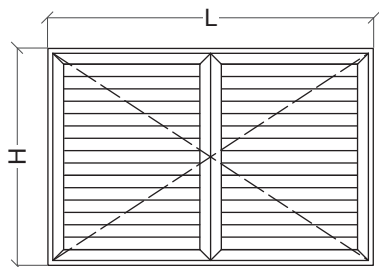

Perfis

Desenho	Ref	Descrição	Corte	Quant	Medida
	BE-01	Aro fixo		2	L
				2	H
	BE-02	Aro móvel		4	L/2-30 mm
				4	H-55 mm
	BE-04	Inversor		1	H-102 mm
	BE-15	Compensador		4	L/2-139 mm
	Z-53	Lâmina		Segundo altura	L/2-159 mm
	Z-54	Meia lâmina		4	L/2-159 mm
	AX-19	Vareta		2	Apro. H/2 mm

Acessórios e Juntas

Referência	Descrição	Quantidade
---	Dobradiça aro fixo	6
31 02 70 01	Esquadro janela	12
30 94 01 38	Cremona abertura exterior	1
30 94 01 39	Kit fixação cremone	1
30 94 01 40	Parafuso de ligação	2
30 92 00 40	Terminal de fecho	2
31 02 60 04	Jogo topos	1
30 92 01 20	Fecho 2ª folha	1
30 96 00 22	Esquadro alinhamento	8
---	Contra-fecho aro fixo	2
30 94 01 09	Fixador de portada	2
---	Jogo portalaminas (segundo altura)	2
30 92 09 60	Comando rotativo	2
31 02 60 50	Junta de batente	4L+6H
30 93 01 40	Junta para lamina	(nº laminas + 2) L/2

Portalaminas

Hv = H-164 mm

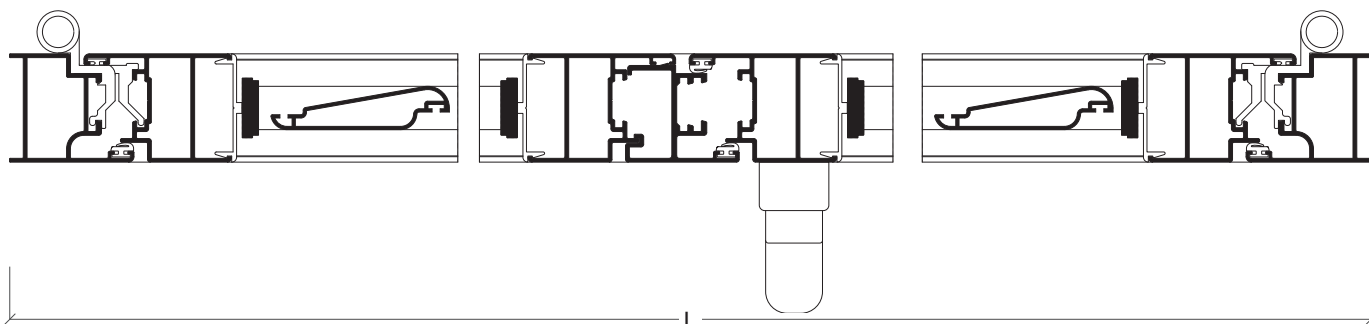

Janela 3 folhas abertura exterior

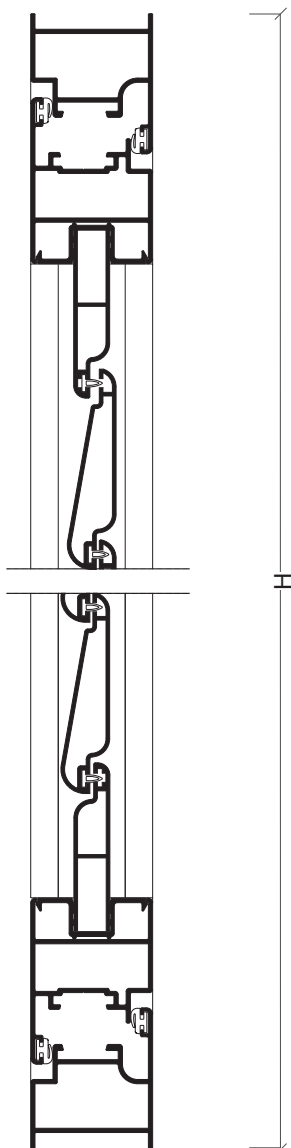
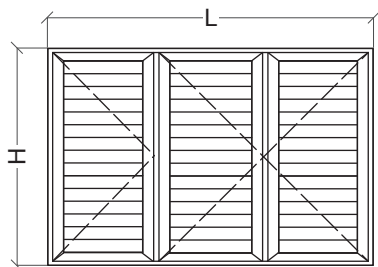

Perfis

Desenho	Ref	Descrição	Corte	Quant	Medida
	BE-01	Aro fixo		2	L
				2	H
	BE-02	Aro móvel		4	Lat. = L/3 mm
				2	Centr. = L/3-65 mm
				6	H-55 mm
	BE-04	Inversor		2	H-102 mm
	BE-15	Compensador		4	Lat. = L/3-109 mm
				2	Centr. = L/3-174 mm
	Z-53	Lâmina		Segundo altura	Lat. = L/3-129 mm
				Segundo altura	Centr. = L/3-194 mm
	Z-54	Meia lâmina		4	Lat. = L/3-129 mm
				2	Centr. = L/3-194 mm
	AX-19	Vareta		2	Apro. H/2 mm

Acessórios e Juntas

Referência	Descrição	Quantidade
---	Dobradiça aro fixo	6
---	Dobradiça de balanço aro fixo	3
31 02 70 01	Esquadro janela	16
30 94 01 38	Cremona abertura exterior	1
30 94 01 39	Kit fixação cremona	1
30 94 01 40	Parafuso de ligação	2
30 92 00 40	Terminal de fecho	2
31 02 60 04	Jogo topos	2
30 92 01 20	Fecho 2ª folha	2
30 96 00 22	Esquadro alinhamento	12
---	Contra-fecho aro fixo	4
30 94 01 09	Fixador de portada	1
30 94 01 10	Fixador de portada duplo	1
---	Jogo portalaminas (segundo altura)	3
30 92 09 60	Comando rotativo	3
31 02 60 50	Junta de batente	4L+8H
30 93 01 40	Junta para lamina	(nº laminas + 3) L/3

Portalâminas

Hv = H-164 mm

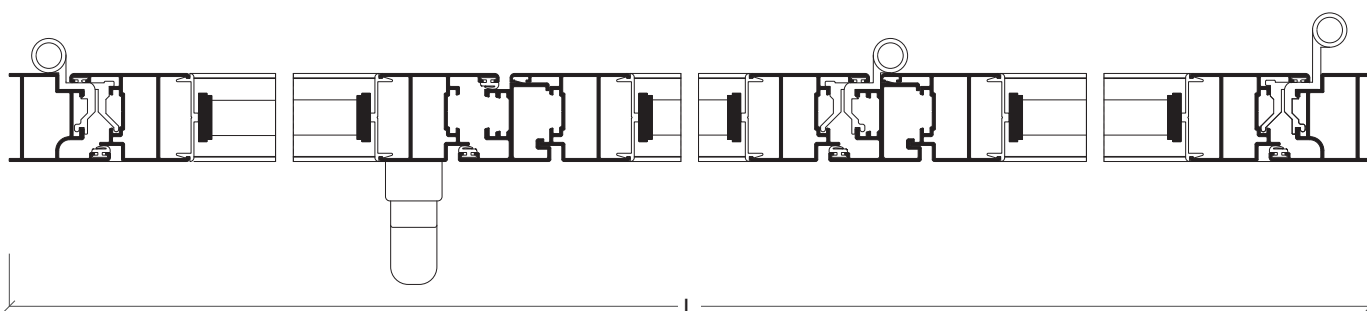

Janela 4 folhas abertura exterior

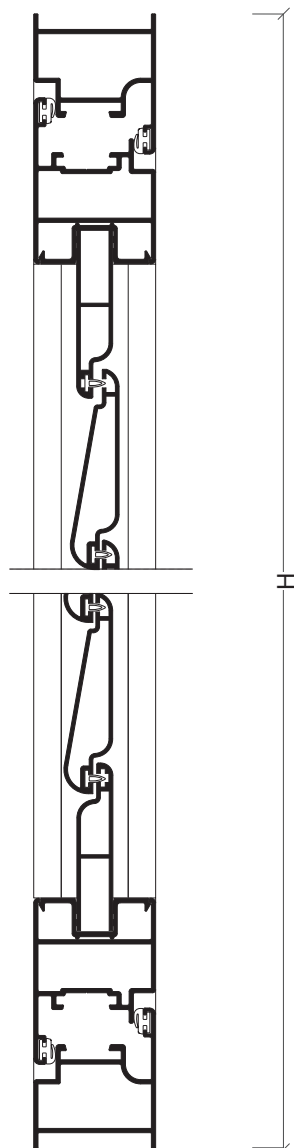
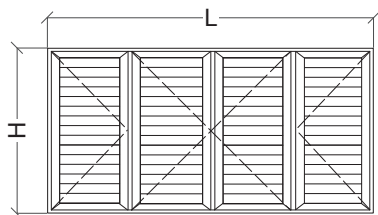

Perfis

Desenho	Ref	Descrição	Corte	Quant	Medida
	BE-01	Aro fixo		2	L
				2	H
	BE-02	Aro móvel		4	Lat. = L/4+10 mm
				4	Centr. = L/4-45 mm
				8	H-55 mm
	BE-04	Inversor		3	H-102 mm
	BE-15	Compensador		4	Lat. = L/4-119 mm
				4	Centr. = L/4-154 mm
	Z-53	Lâmina		Segundo altura	Lat. = L/4-139 mm
				Segundo altura	Centr. = L/4-174 mm
	Z-54	Meia lâmina		4	Lat. = L/4-139 mm
				4	Centr. = L/4-174 mm
	AX-19	Vareta		2	Apro. H/2 mm

Acessórios e Juntas

Referência	Descrição	Quantidade
---	Dobradiça aro fixo	6
---	Dobradiça de balanço aro fixo	6
31 02 70 01	Esquadro janela	20
30 94 01 38	Cremona abertura exterior	1
30 94 01 39	Kit fixação cremona	1
30 94 01 40	Parafuso de ligação	2
30 92 00 40	Terminal de fecho	2
31 02 60 04	Jogo topos	3
30 92 01 20	Fecho 2ª folha	3
30 96 00 22	Esquadro alinhamento	16
---	Contra-fecho aro fixo	6
30 94 01 10	Fixador de portada duplo	2
---	Jogo portalaminas (segundo altura)	4
30 92 09 60	Comando rotativo	4
31 02 60 50	Junta de batente	4L+10H
30 93 01 40	Junta para lamina	(nº laminas + 4) L/4

Portalâminas

Hv = H-164 mm

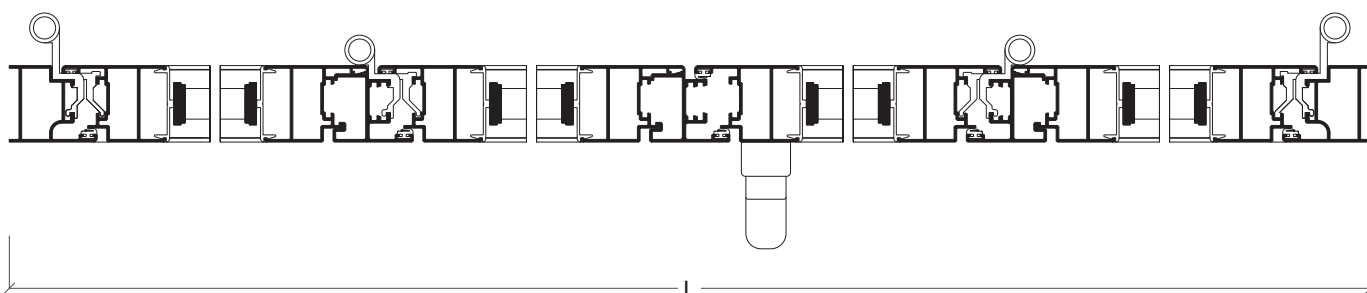

Porta 2 folhas abertura exterior

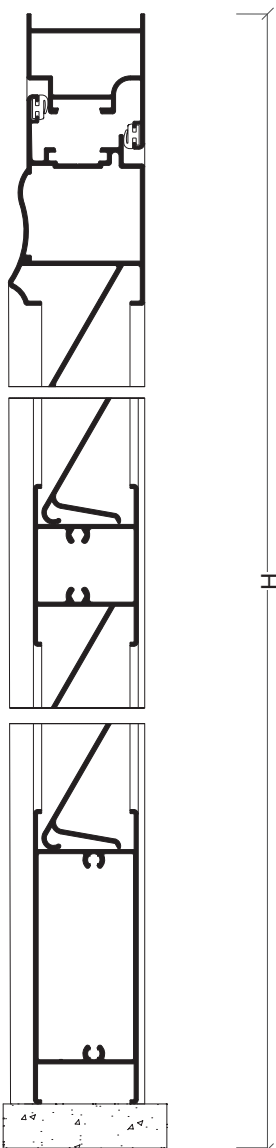
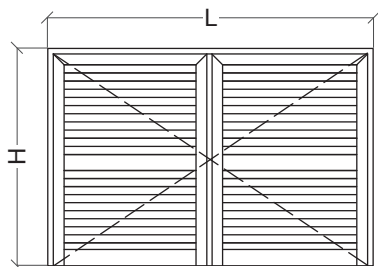

Perfis

Desenho	Ref	Descrição	Corte	Quant	Medida
	BE-01	Aro fixo		1	L
				2	H
	BE-24	Aro móvel		2	L/2-30 mm
				4	H-33 mm
	BE-04	Inversor		1	H-156 mm
	BE-05	Travessa 55 mm		2	(L-146 mm)/2
	BE-09	Travessa 100 mm		2	(L-146 mm)/2
	Z-34	Lâmina fixa		Segundo altura	(L-146 mm)/2
	AX-19	Vareta		2	Apro. H/2 mm

Acessórios e Juntas

Referência	Descrição	Quantidade
---	Dobradiça aro fixo	8
31 02 70 01	Esquadro janela	2
31 02 70 02	Esquadro porta	4
30 94 01 38	Cremona abertura exterior	1
30 94 01 39	Kit fixação cremona	1
30 94 01 40	Parafuso de ligação	2
30 92 00 40	Terminal de fecho	2
31 02 60 04	Jogo topos	1
30 92 01 20	Fecho 2ª folha	1
30 96 00 22	Esquadro alinhamento	4
---	Contra-fecho aro fixo	1
30 94 01 09	Fixador de portada	2
30 24 30 75	Contra-fecho inferior	1
31 02 60 50	Junta de batente	2L+6H

Portalâminas

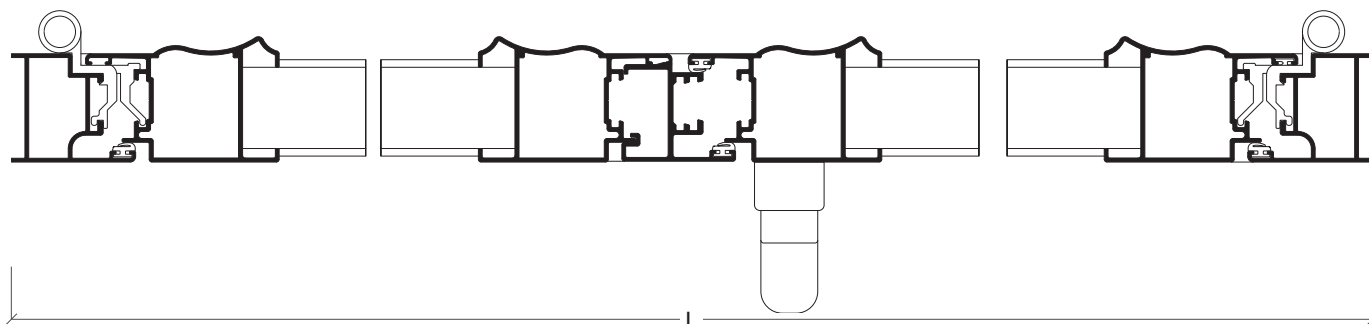

Hv = H-164 mm

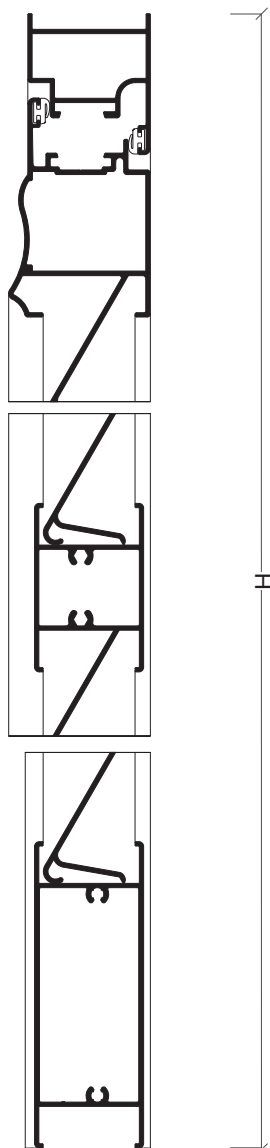
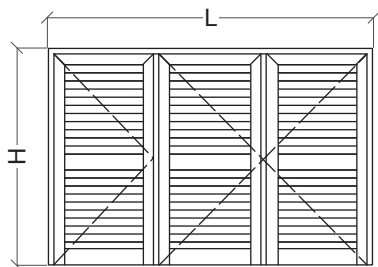

Porta 3 folhas abertura exterior

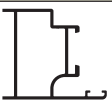

Perfis

Desenho	Ref	Descrição	Corte	Quant	Medida
	BE-01	Aro fixo		1	L
				2	H
	BE-24	Aro móvel		2	Lat. = L/3 mm
				1	Centr. = L/3-67 mm
				6	H-33 mm
	BE-04	Inversor		2	H-56 mm
	BE-05	Travessa 55 mm		2	Lat. = L/3-116 mm
				1	Centr. = L/3-183 mm
	BE-09	Travessa 100 mm		2	Lat. = L/3-116 mm
				1	Centr. = L/3-183 mm
	Z-34	Lâmina fixa		Segundo altura	Lat. = L/3-116 mm
				Segundo altura	Centr. = L/3-183 mm
	AX-19	Vareta		2	Apro. H/2 mm

Acessórios e Juntas

Referência	Descrição	Quantidade
---	Dobradiça aro fixo	8
---	Dobradiça de balanço aro fixo	4
31 02 70 01	Esquadro janela	2
31 02 70 02	Esquadro porta	6
30 94 01 38	Cremona abertura exterior	1
30 94 01 39	Kit fixação cremone	1
30 94 01 40	Parafuso de ligação	2
30 92 00 40	Terminal de fecho	2
31 02 60 04	Jogo topos	2
30 92 01 20	Fecho 2ª folha	2
30 96 00 22	Esquadro alinhamento	6
---	Contra-fecho aro fixo	2
30 94 01 09	Fixador de portada	1
30 94 01 10	Fixador de portada duplo	1
30 24 30 75	Contra-fecho inferior	2
31 02 60 50	Junta de batente	2L+6H

Portalâminas

Hv = H-164 mm

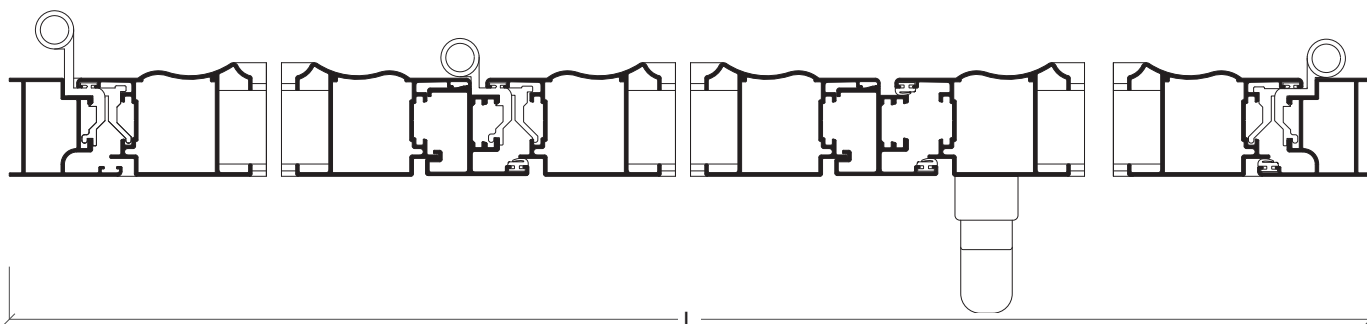

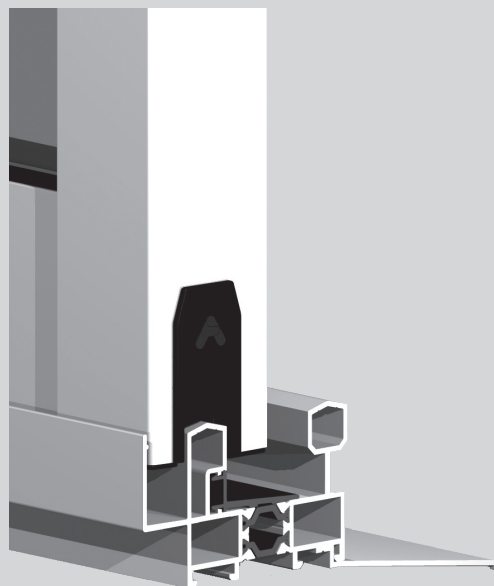
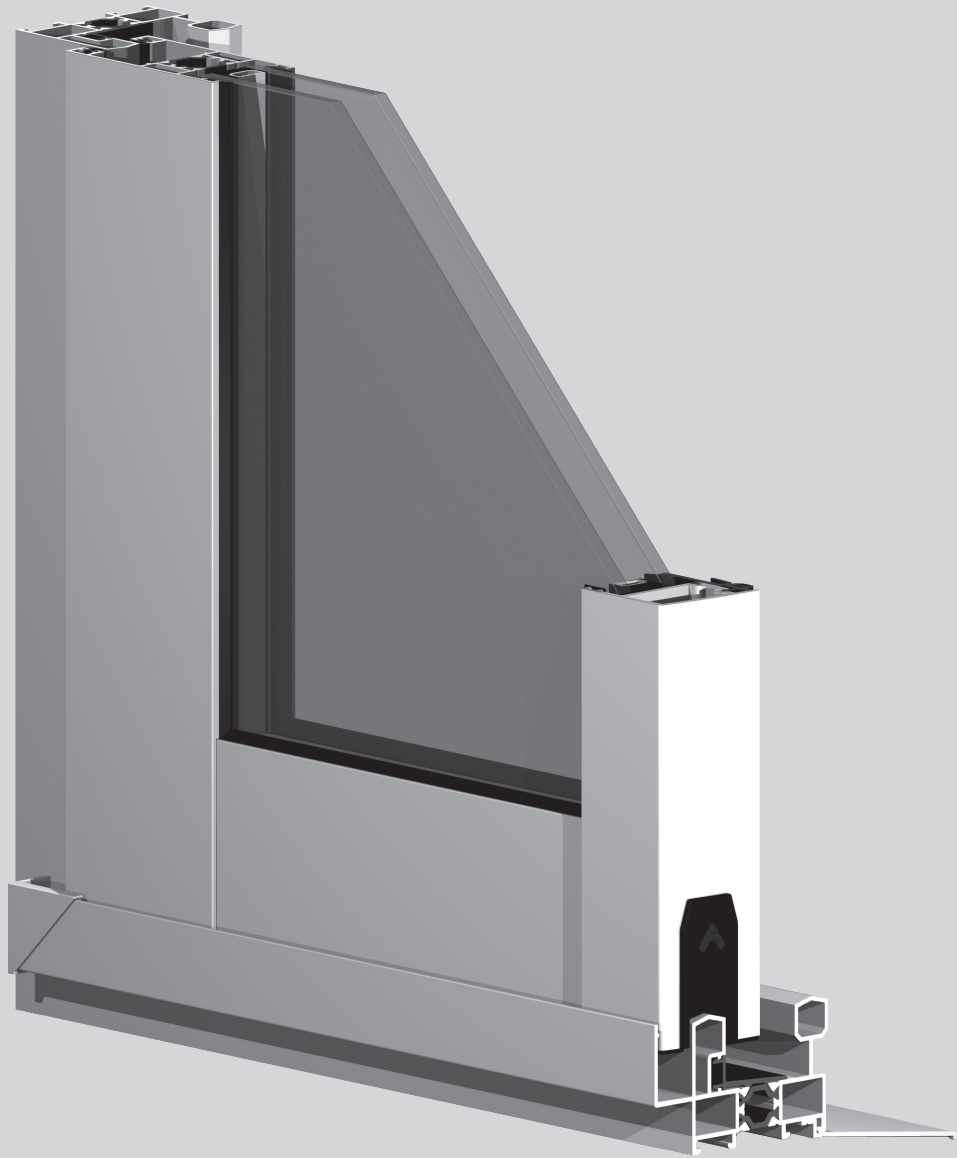

Sistema

CT

Sistema CT

Sistema de correr com RPT - 60 mm

Características do sistema

Sistema de alumínio com rotura térmica para execução de vãos de correr.

Perfis de alumínio

Os perfis de alumínio são extrudidos na liga de alumínio 6060 para arquitetura de acordo com norma NP EN 12020-02.

Os perfis com rotura térmica são obtidos por inserção de varetas isolantes de poliamida 6.6 mm reforçadas com 25% de fibra de vidro. Versátil sistema de rotura térmica com aros e folhas perimetrais ou de corte recto designado por Benelux, é o sistema indicado para as inovadoras soluções arquitectónicas da actualidade.

Espessura média dos perfis de alumínio de 1.5 mm.

Aros fixos

Secção do aro fixo perimetral de 2 guias de 60 mm para montagem a meia esquadria;

Perfis com rotura térmica obtida por inserção de varetas isolantes de poliamida de 14.6 mm ou 18 mm;

Perfil guia de deslizamento inferior em aço inoxidável 304 ou em poliamida, para evitar desgaste das peças.

Aros móveis

Secção dos aros móveis perimetrais de 33.1 mm para montagem a meia esquadria;

Enchimento de 18 mm a 26 mm;

Aros móveis de linha recta ou curva com ou sem bite;

Estanquidade assegurada através de junta em TPE e/ou pelúcia tipo Sin-Feal.

Dimensionamento e manobralidade

Peso máximo de 150 kg por folha (com 2 rolamentos duplos);

Possibilidades de abertura: 2, 3, 4 e 6 folhas com folhas móveis e/ou fixas;

Rolamento duplo oscilante com regulação;

Rolamentos de agulhas inox com eixo temperado rectificando sendo possível a substituição sem desmontagem da folha;

Suporte exterior com tratamento cataforese (anti-corrosivo);

Abertura do vão com fecho lateral ou ferragem multi-ponto com 2 ou 4 pontos de fecho.

Performances

Sistema certificado por laboratório notificado do ensaio tipo inicial (ITT) de acordo com a norma de produto EN 14351-1 para efeitos de Marcação CE.

Categorias alcançadas na avaliação do sistema CT tipologia janela:

1. Permeabilidade ao ar: Classe 3 (norma de ensaio EN 1026)
2. Estanquidade à água: Classe 7A (norma de ensaio EN 1027)
3. Resistência ao vento: Classe C5 (norma de ensaio EN 12211)

Categorias alcançadas na avaliação do sistema CT tipologia porta:

1. Permeabilidade ao ar: Classe 4 (norma de ensaio EN 1026)
2. Estanquidade à água: Classe 7A (norma de ensaio EN 1027)
3. Resistência ao vento: Classe C2 (norma de ensaio EN 12211)

Coefficiente de transmissão térmica de vão de 2 folhas com 1.80 m x 2.20 m com vidro $U_g = 1.0 \text{ W/m}^2\text{K}$ com intercalar efeito "Warm Edge":

• $U_w = 1.91 \text{ W/m}^2\text{K}$

Coefficiente de atenuação acústica de vão de 2 folhas com vidro 6/14/33.1 acústico:

• $R_w (C; C_{tr}) = 34 \text{ dB} (-1; -6)$

Zonas de aplicação segundo RCCTE (em função do valor U_g): I1, I2, I3, V1, V2, V3;

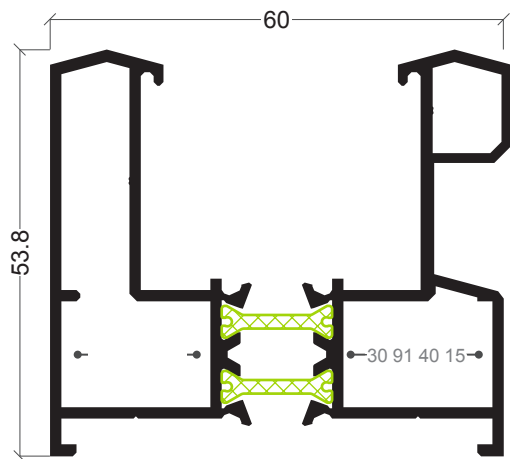

CT-01
Aro fixo perimetral

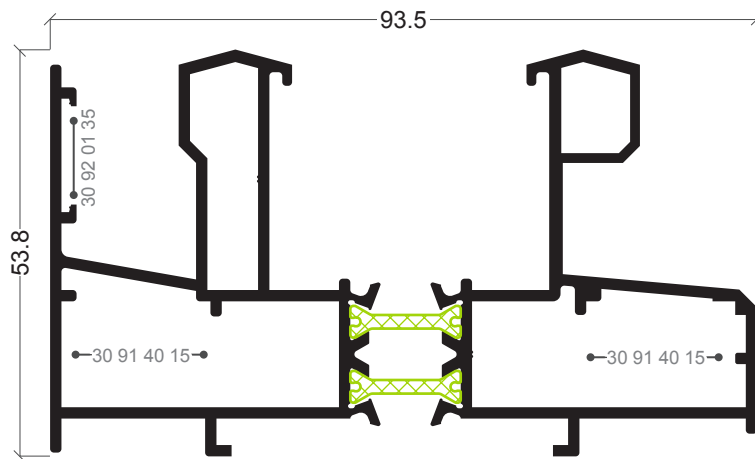

CT-16
Aro fixo perimetral

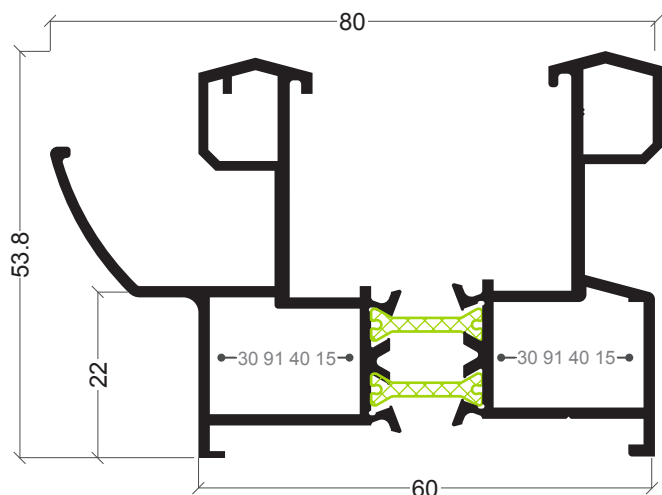

CT-15
Aro fixo perimetral

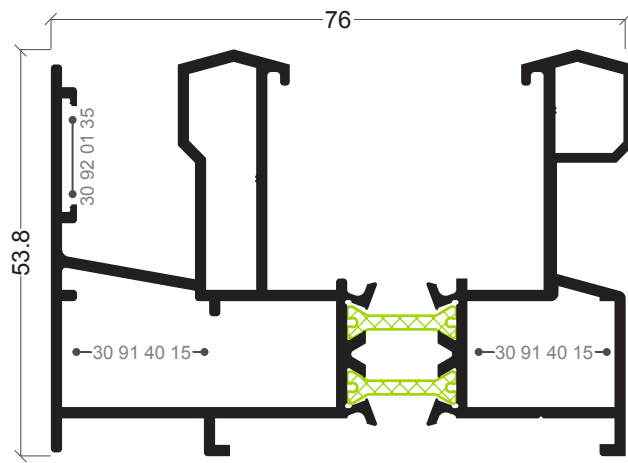

CT-22
Aro fixo perimetral

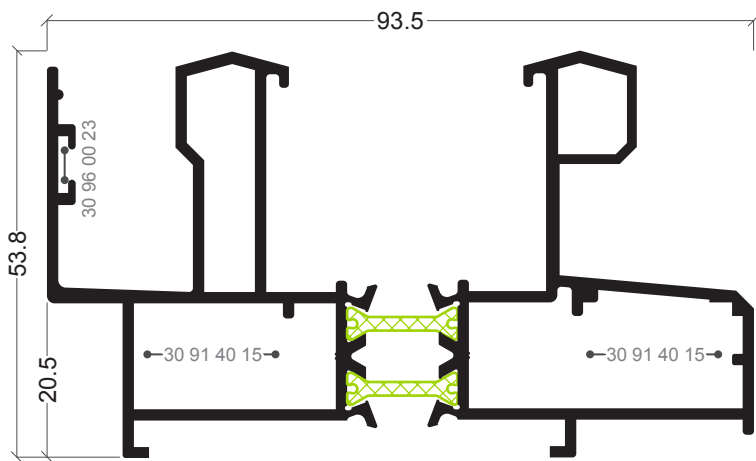

CT-17
Aro fixo perimetral

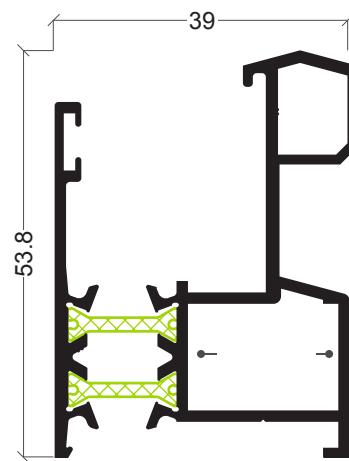

CT-59
Aro fixo perimetral mono-rail

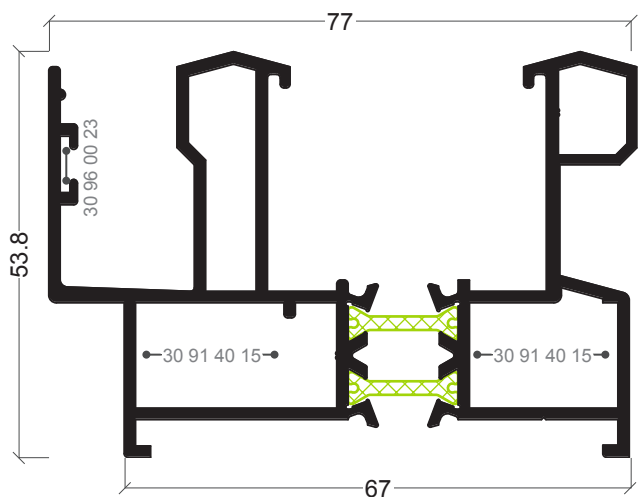

CT-60
Aro fixo perimetral

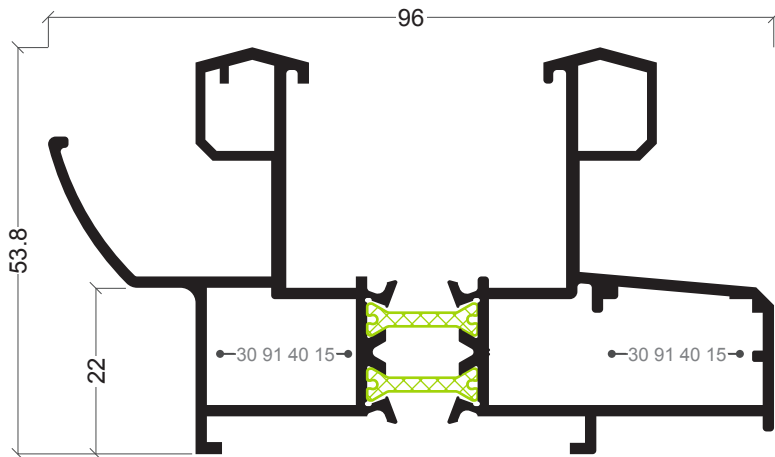

CT-20
Aro fixo perimetral

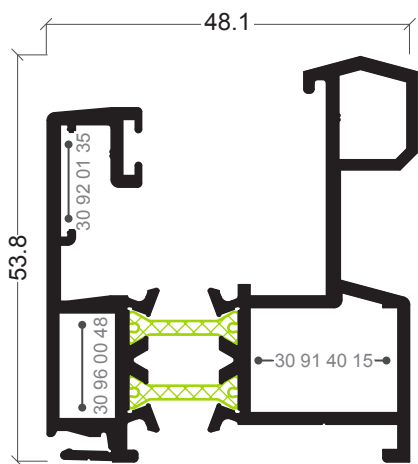

CT-66
Aro fixo monorail

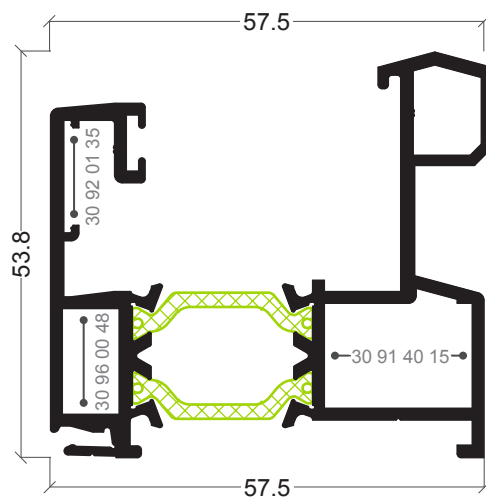

CT-70
Aro fixo monorail galandage

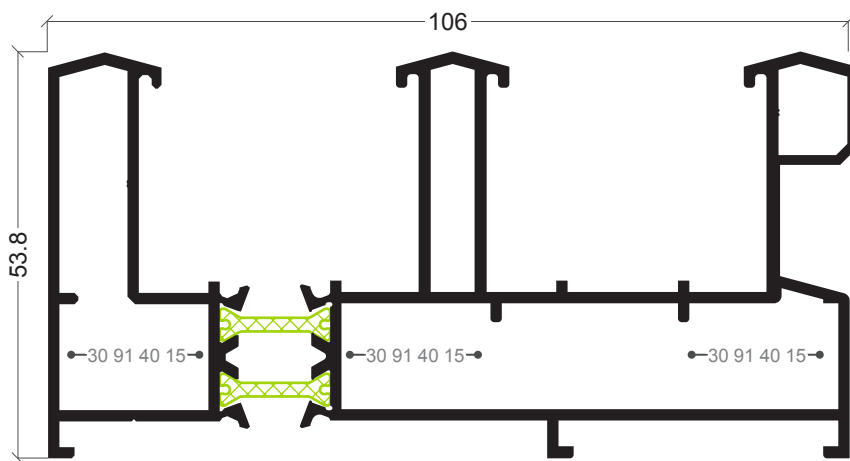

CT-14
Aro fixo perimetral tri-rail

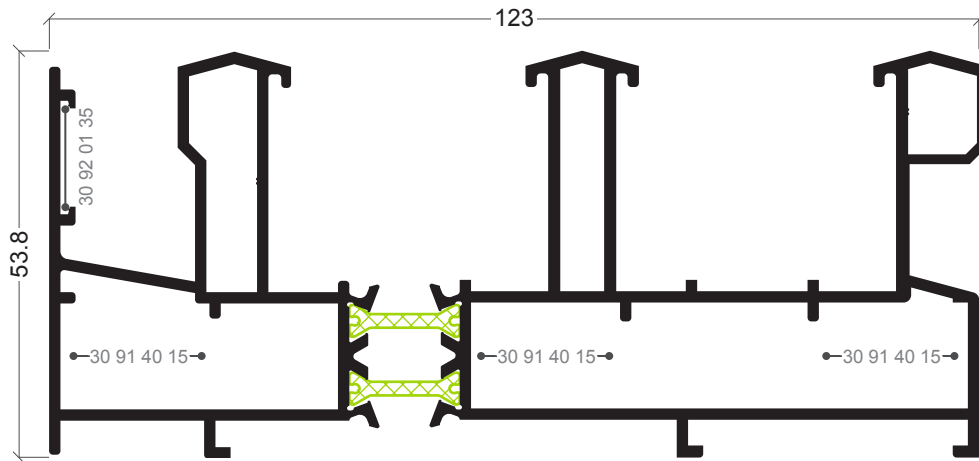

CT-18
Aro fixo perimetral tri-rail

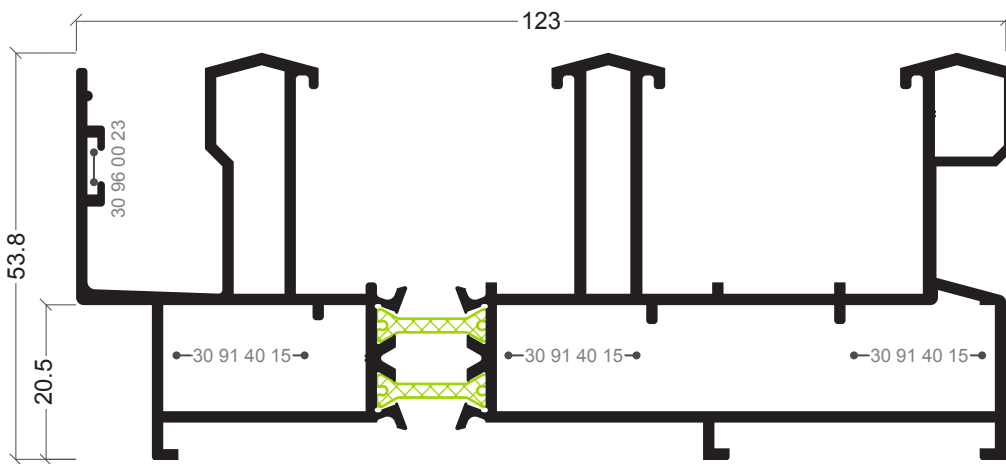

CT-19
Aro fixo perimetral tri-rail

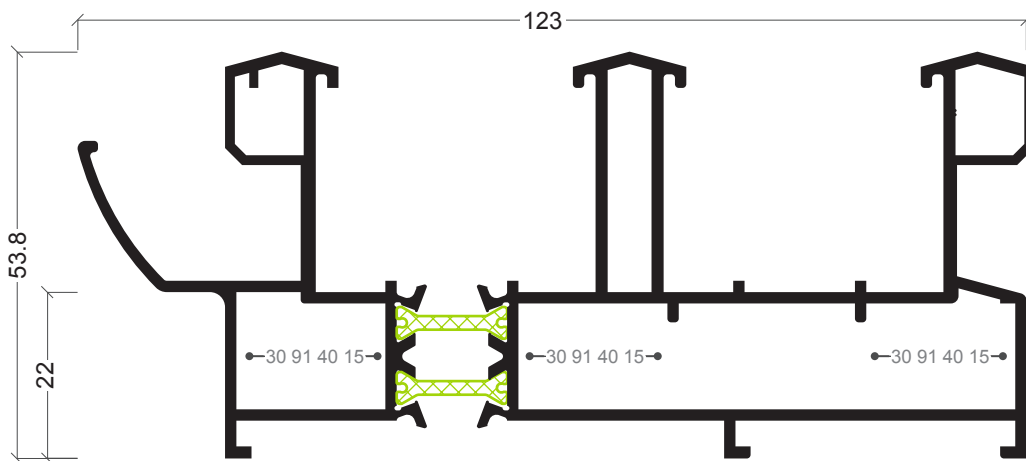

CT-21
Aro fixo perimetral tri-rail

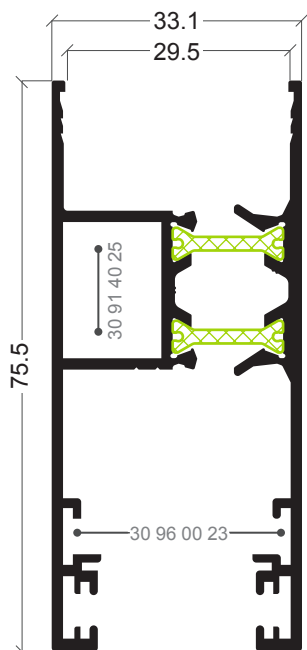

CT-53
Aro fixo perimetral recto

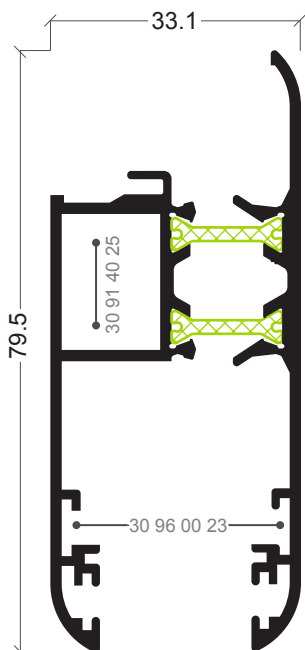

CT-02
Aro móvel perimetral c/ bite

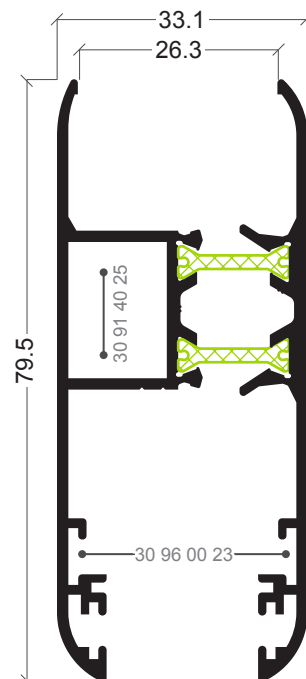

CT-12
Aro móvel perimetral

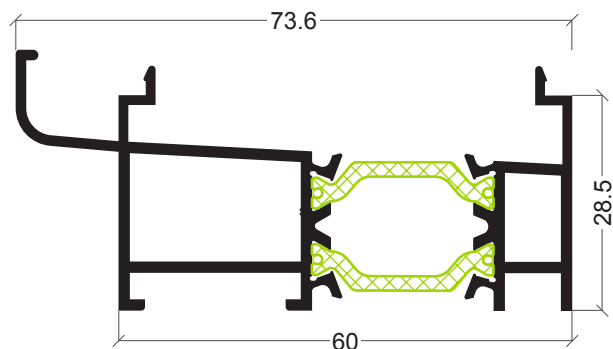

CT-11
Soleira condensação

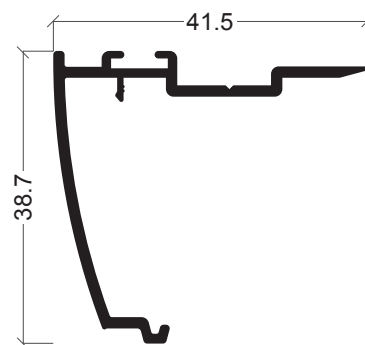

CT-06
Tampa cruzamento aro móvel

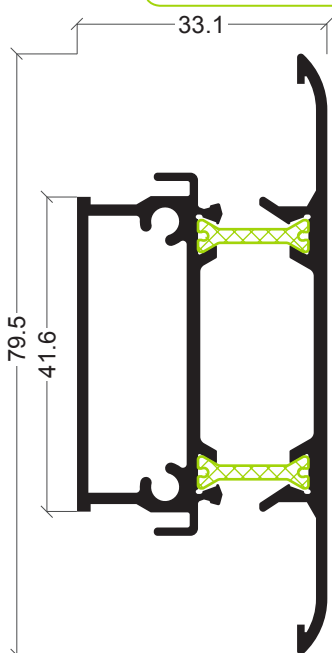

CT-04
Travessa com bite

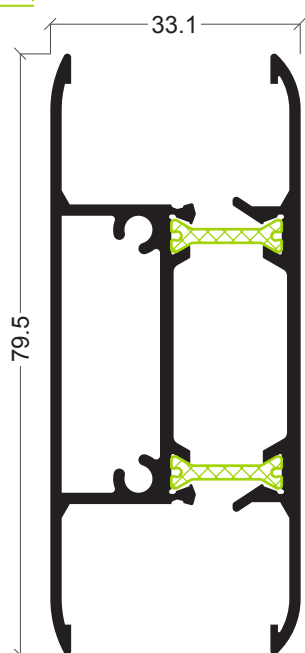

CT-13
Travessa sem bite

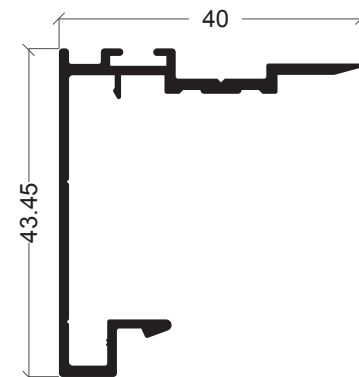

CT-54
Tampa cruzamento aro móvel recto

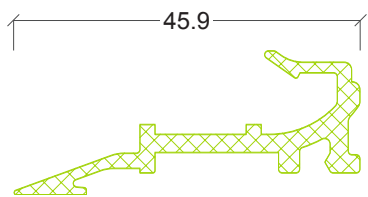

CT-08

Cruzamento móvel

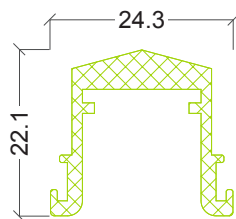

CT-10

União 3/4 folhas CT-02/12

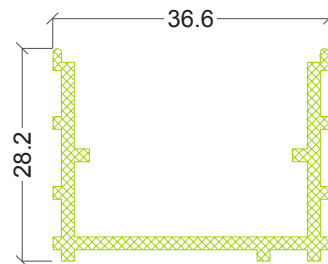

CT-09

Tampa aro fixo perimetral

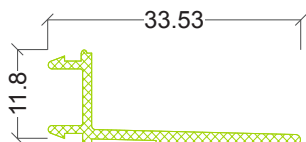

CT-23

Tampa aro fixo perimetral

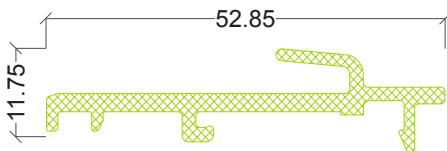

CT-26

Cruzamento móvel

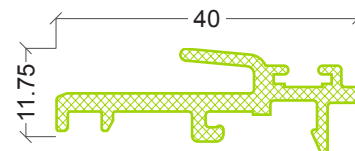

CT-25

Cruzamento móvel

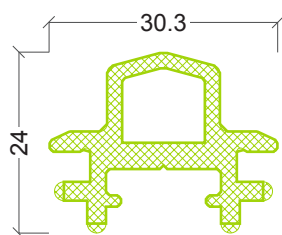

CT-24

União 3/4 folhas CT-35/53

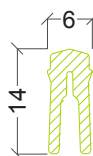

CT-71

Guia carril (poliamida)

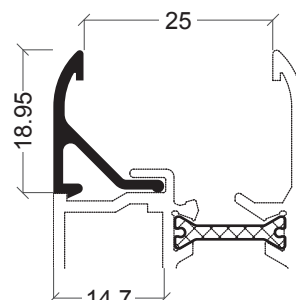

CT-05

Bite

287

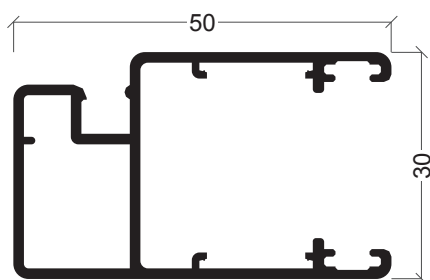

CT-73

Perfil para rede mosquiteira

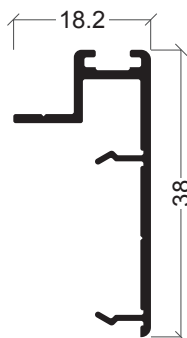

CT-74

Tampa

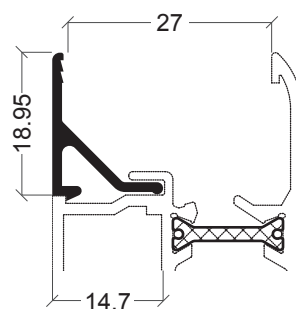

CT-40

Bite

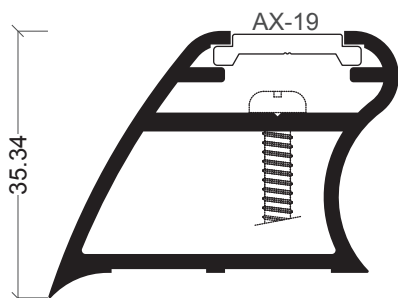

CT-03

Reforço

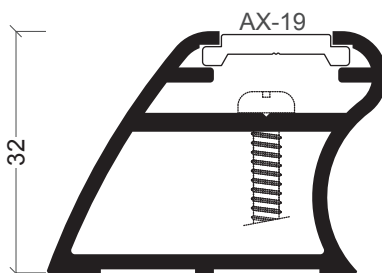

CT-27

Reforço

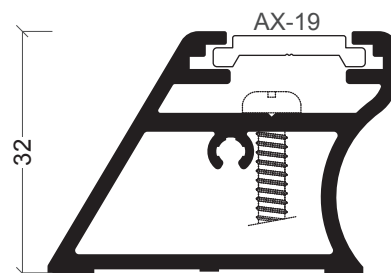

CT-28

Reforço

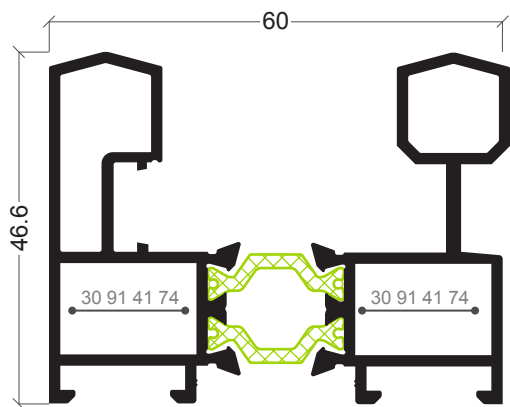

CT-41
Aro fixo perimetral

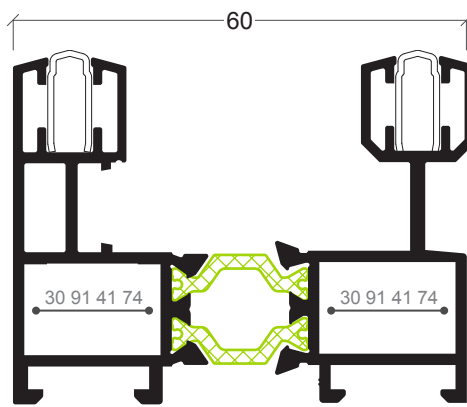

CT-42
Aro fixo perimetral

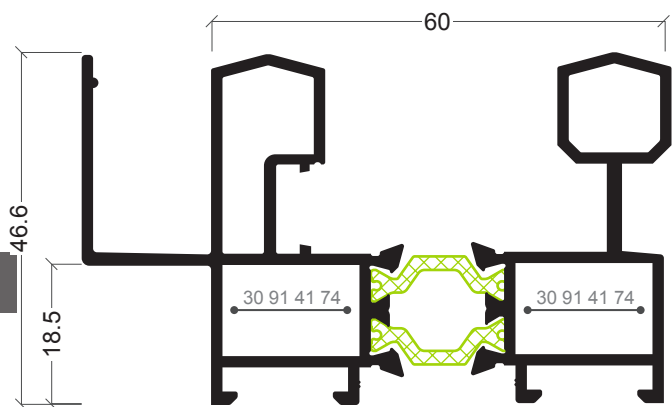

CT-43
Aro fixo perimetral

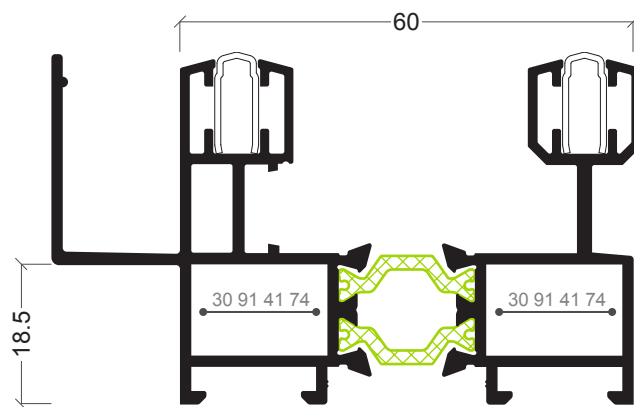

CT-44
Aro fixo perimetral

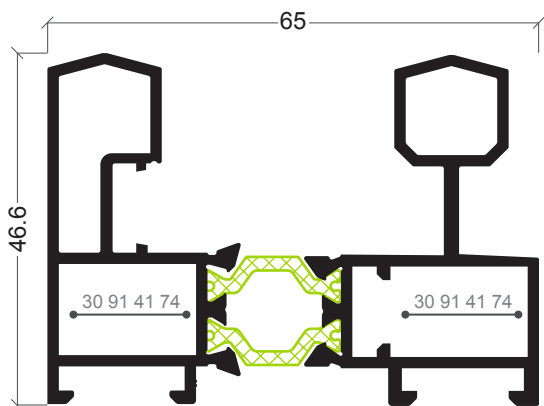

CT-45
Aro fixo perimetral

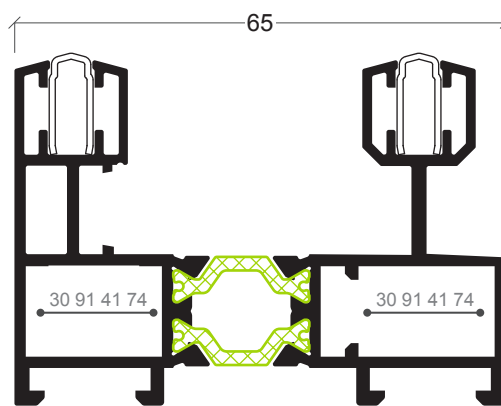

CT-46
Aro fixo perimetral

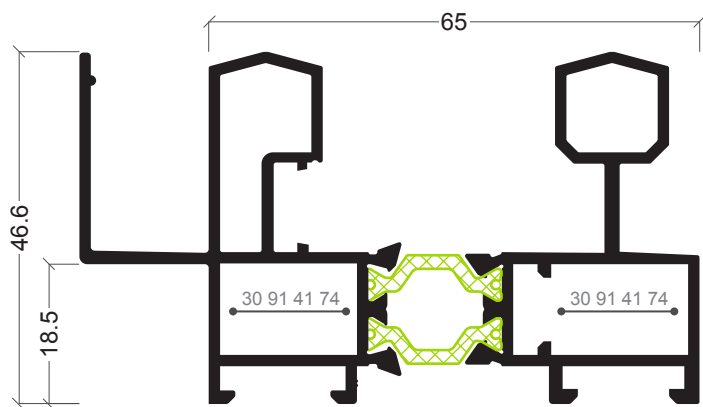

CT-47
Aro fixo perimetral

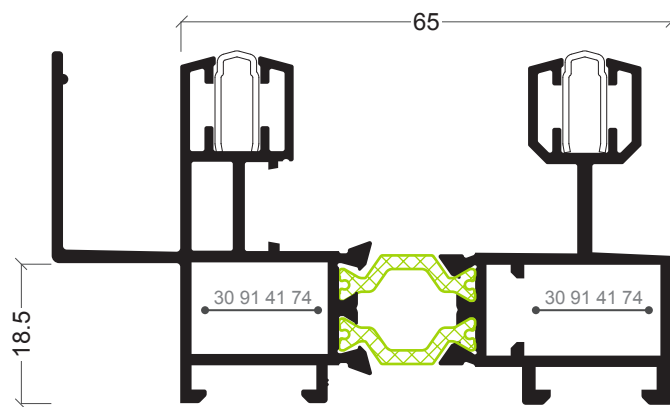

CT-48
Aro fixo perimetral

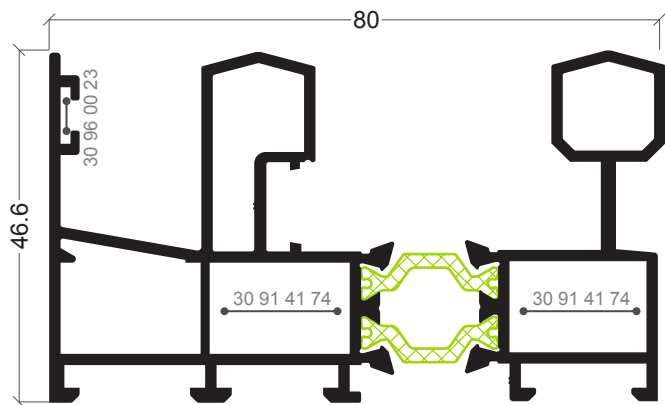

CT-49
Aro fixo perimetral

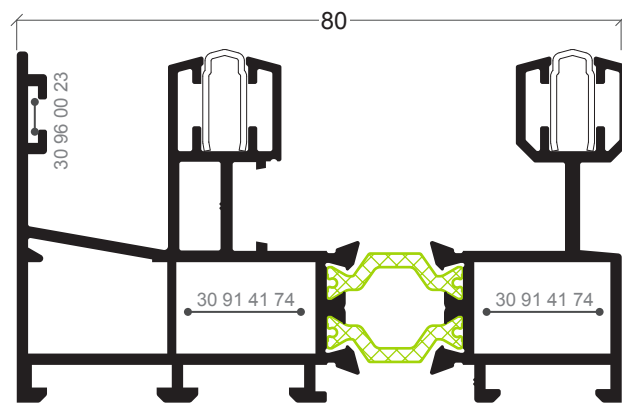

CT-50
Aro fixo perimetral

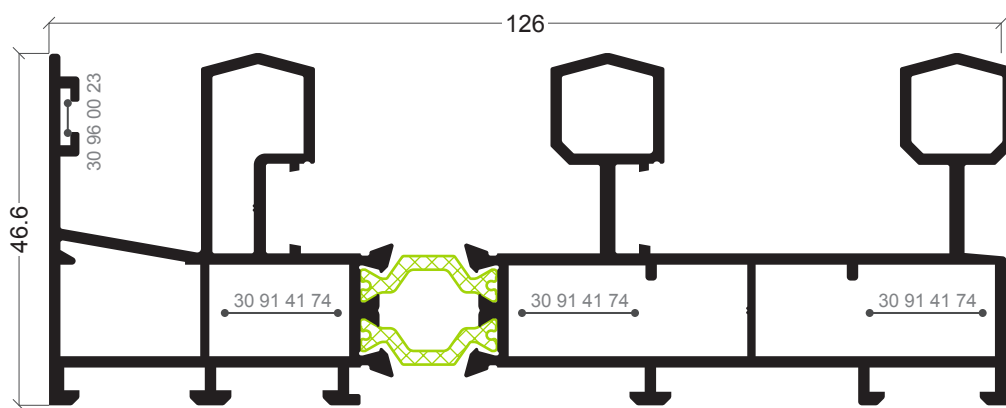

CT-51
Aro fixo perimetral tri-rail

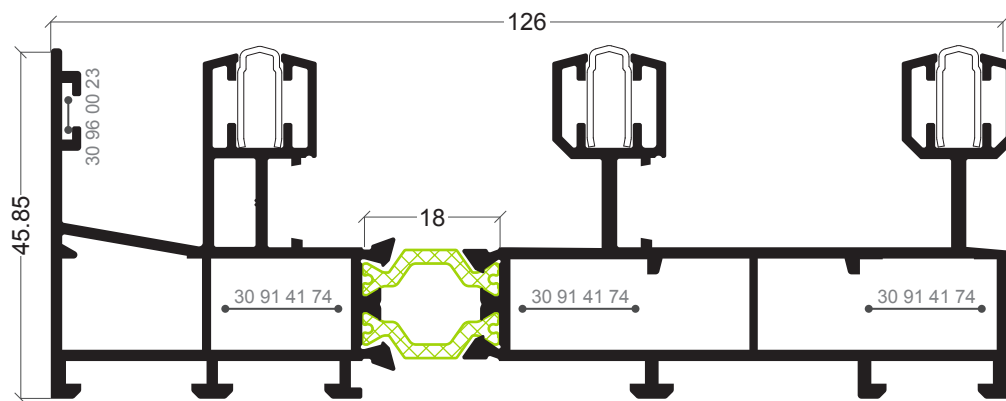

CT-52
Aro fixo perimetral tri-rail

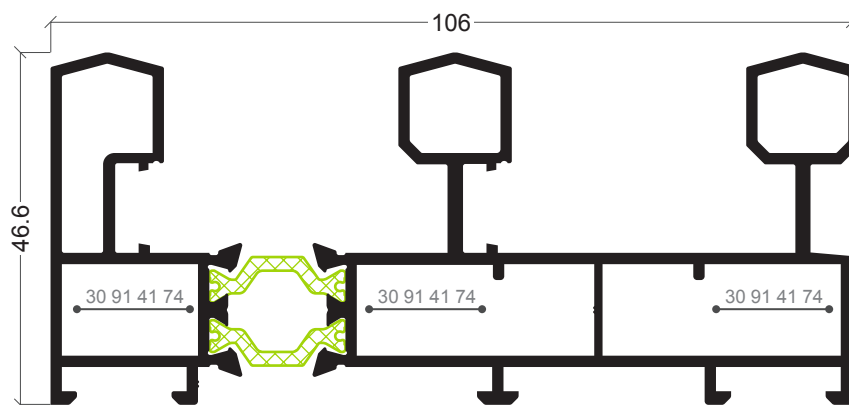

CT-55
Aro fixo perimetral tri-rail

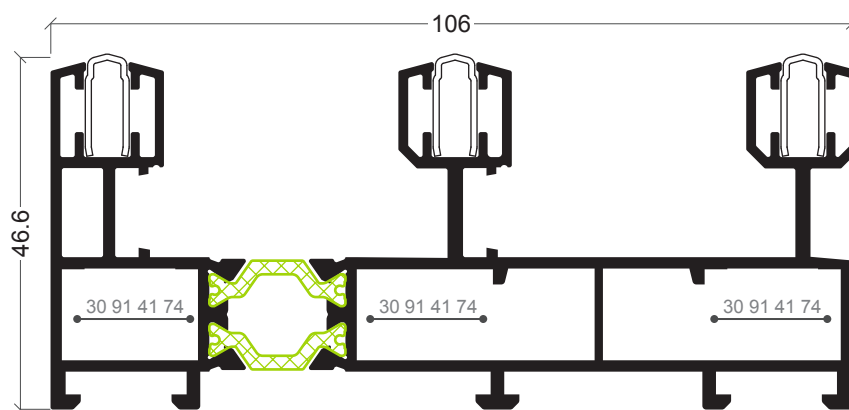

CT-56
Aro fixo perimetral tri-rail

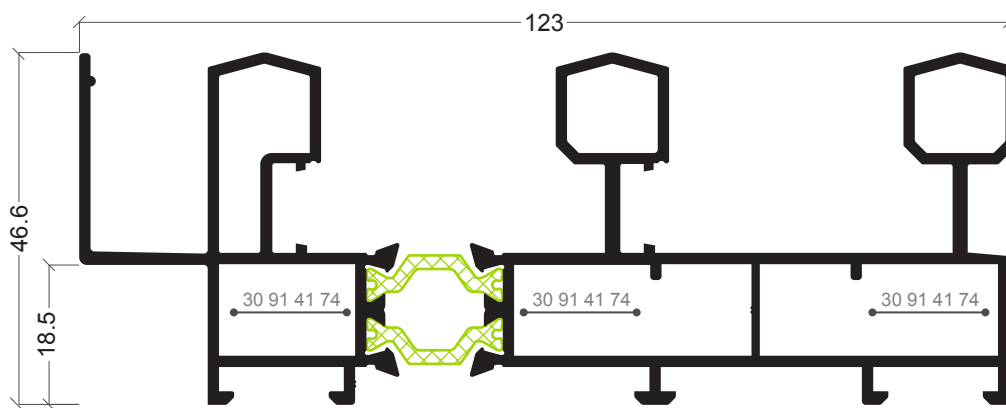

CT-57
Aro fixo perimetral tri-rail

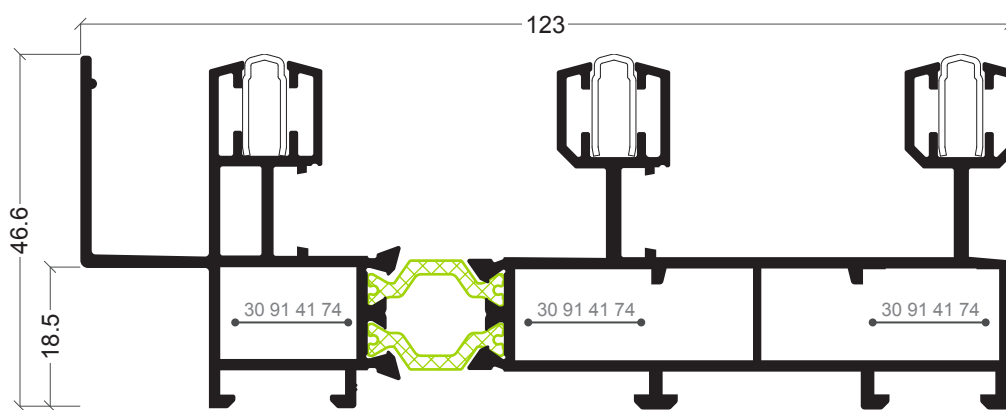

CT-58
Aro fixo perimetral tri-rail

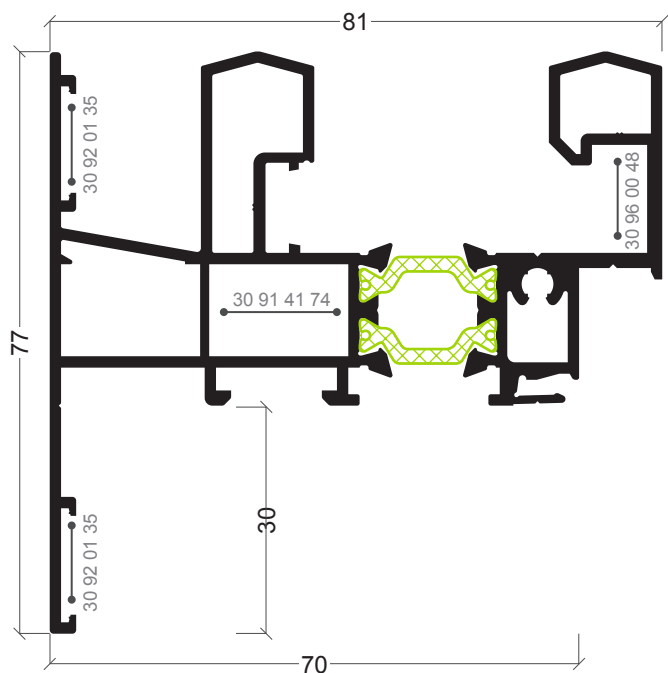

CT-61
Aro fixo perimetral c/ aba remate

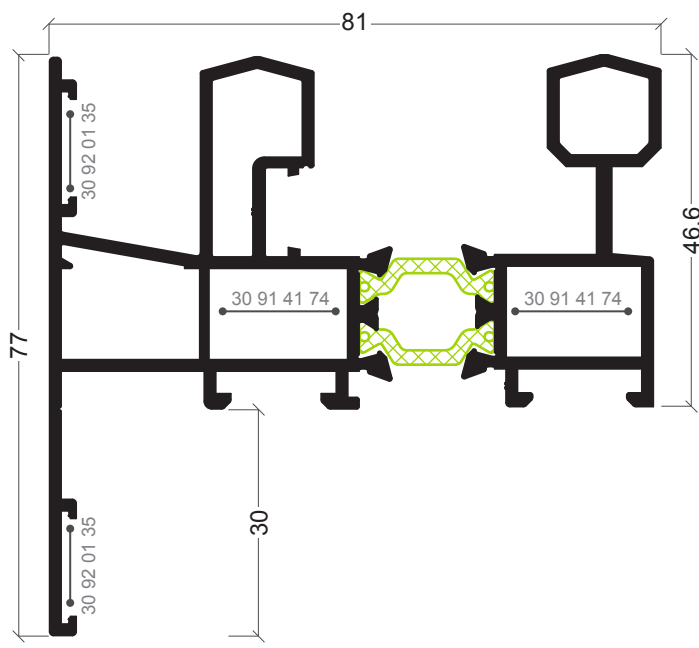

CT-62
Aro fixo perimetral c/ aba remate

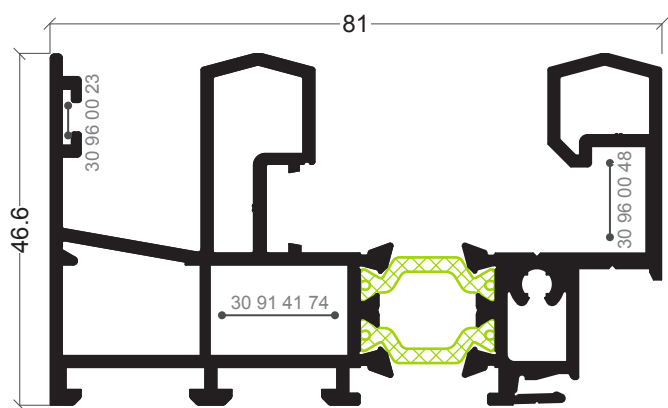

CT-63
Aro fixo perimetral

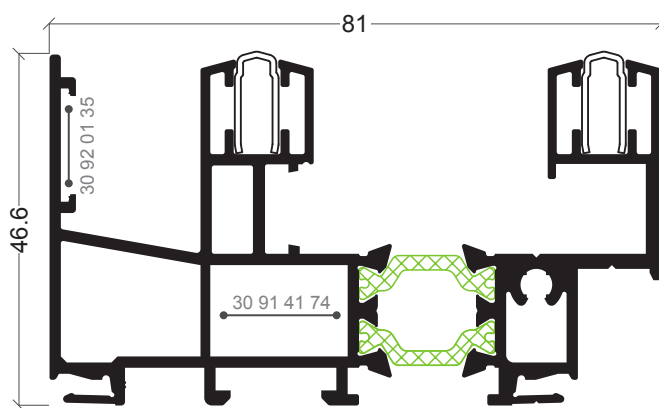

CT-69
Aro fixo perimetral

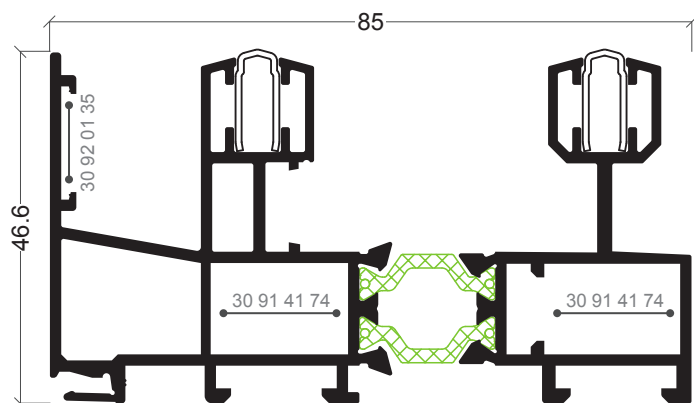

CT-72
Aro fixo perimetral

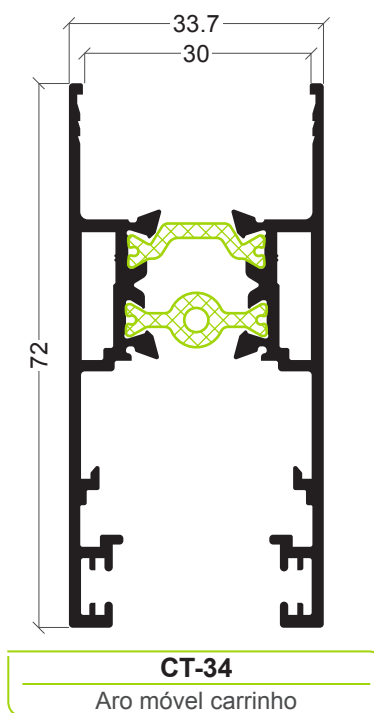
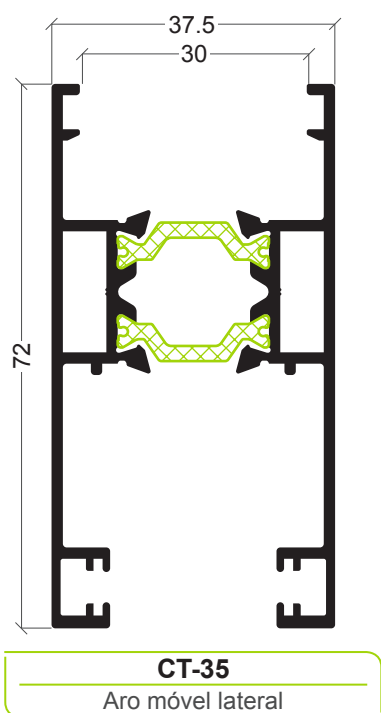
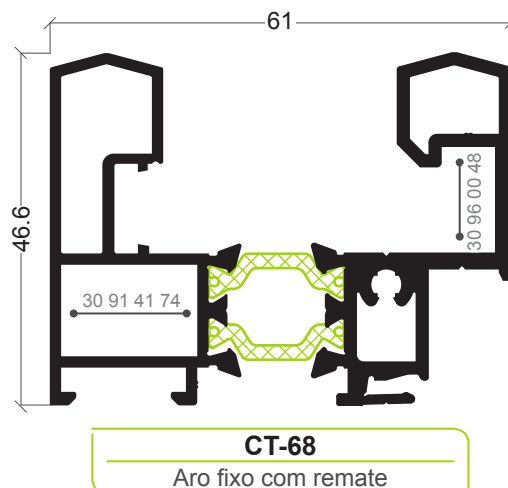
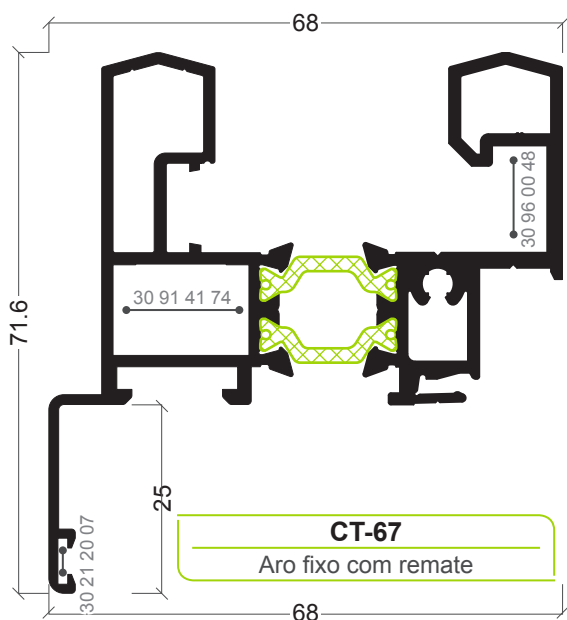
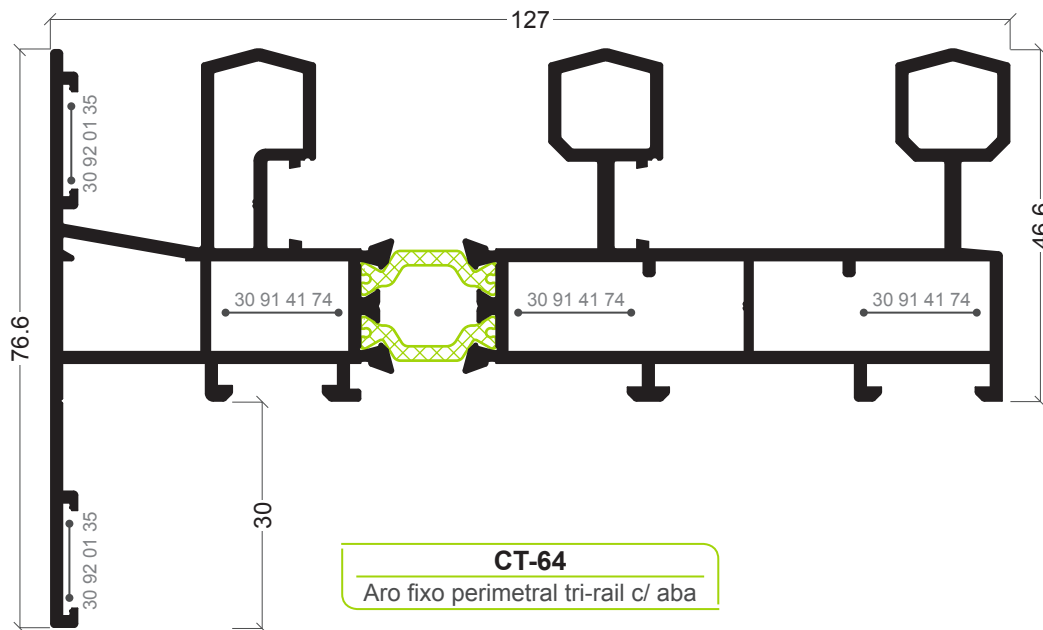

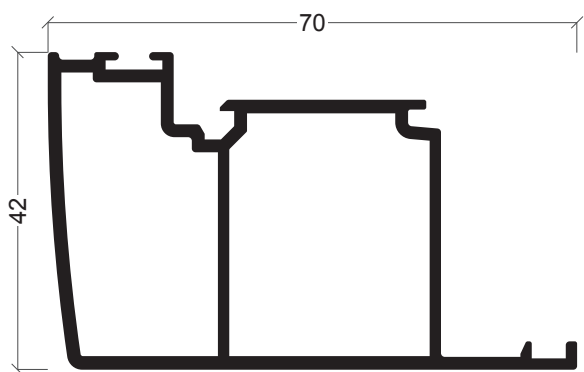

CT-37
Aro móvel central

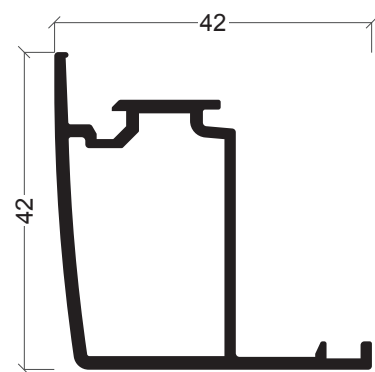

CT-36
Aro móvel central

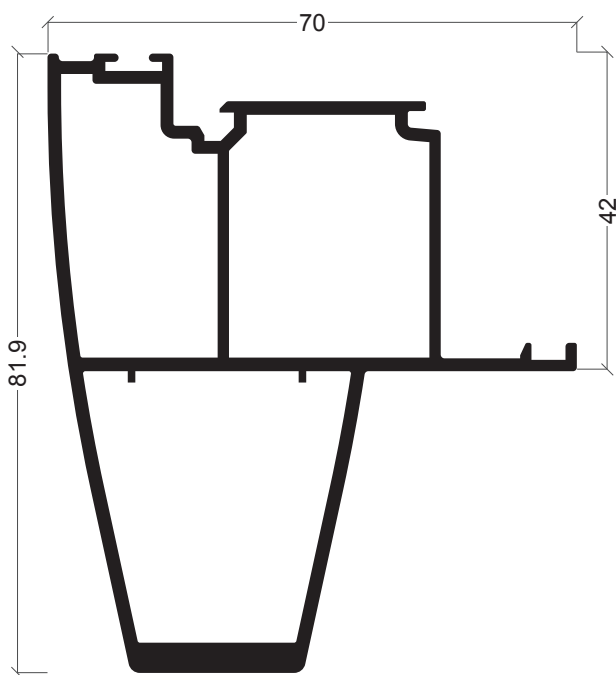

CT-39
Aro móvel central com reforço

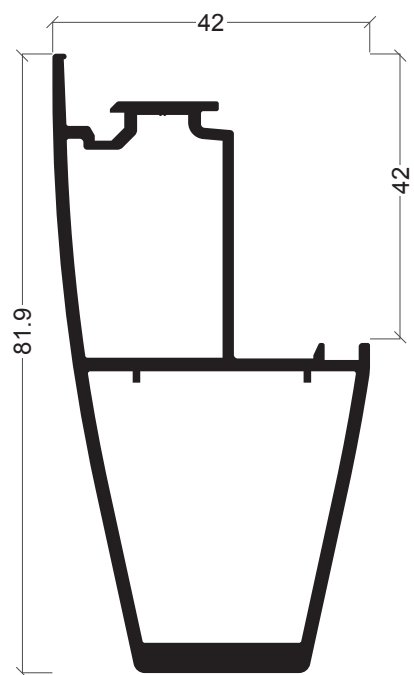

CT-38
Aro móvel central com reforço

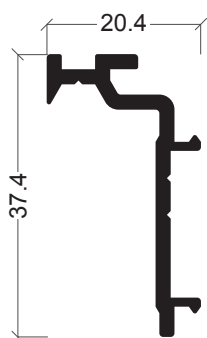

ARI-26
Mola tapa juntas

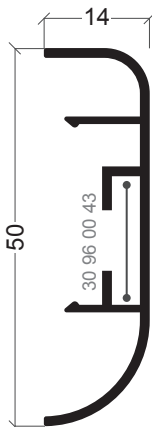

ARI-27
Tapa juntas

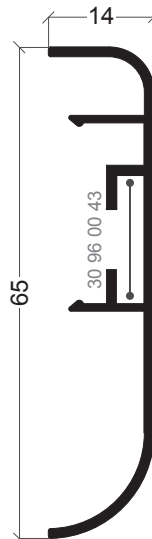

ARI-34
Tapa juntas

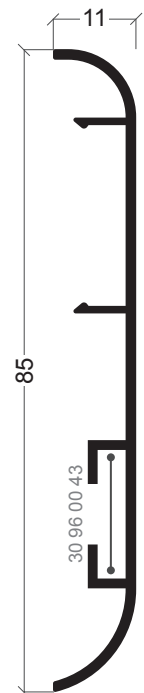

ARI-28
Tapa juntas

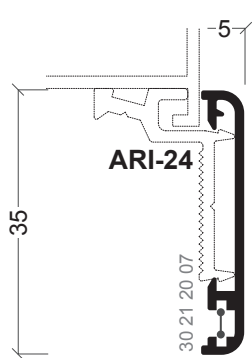

ARI-30
Tapa juntas

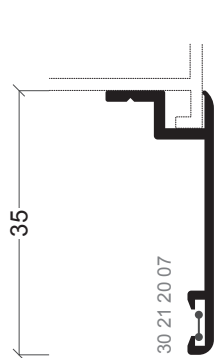

ARI-31
Tapa juntas

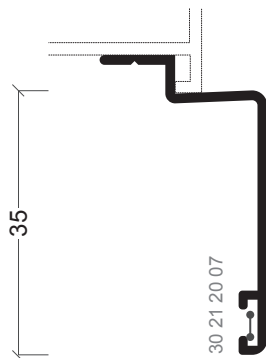

ARI-37
Tapa juntas

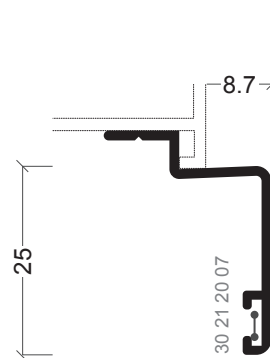

ARI-66
Tapa juntas

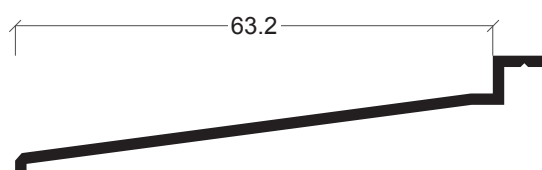

AZ-23
Pingadeira 60 mm



ARI-32
Complemento condensação

294

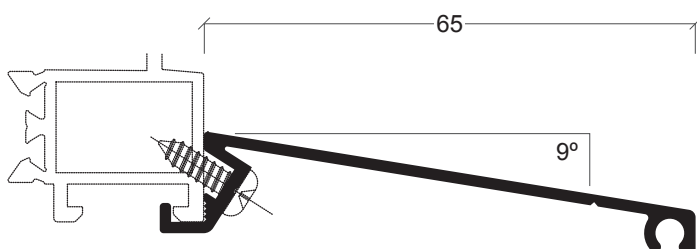

CT-30
Pingadeira 65 mm



CT-33
Guia carril (aço inox 304)

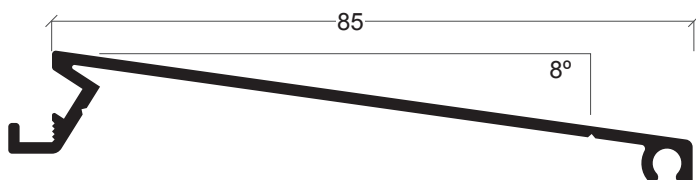

CT-31
Pingadeira 85 mm

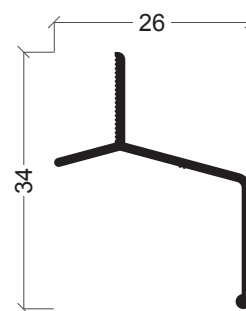

CT-07
Pingadeira superior

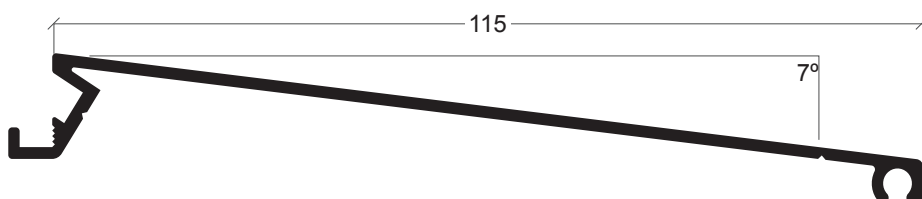

CT-32
Pingadeira 115 mm

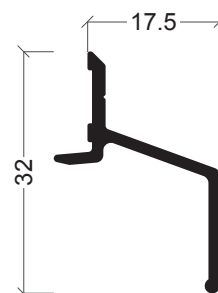

CT-29
Pingadeira superior

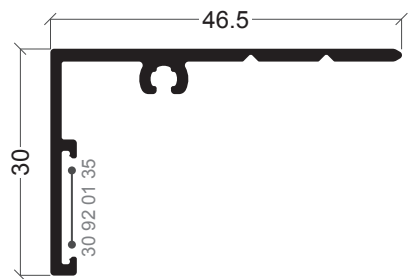

AXi-80
Remate

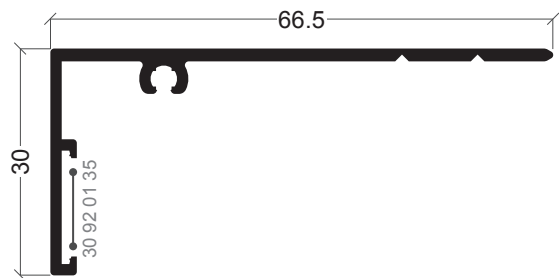

AXi-73
Remate

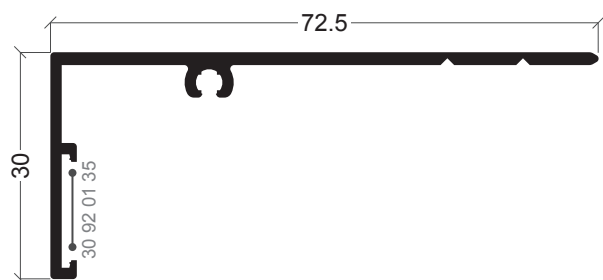

AXi-83
Remate

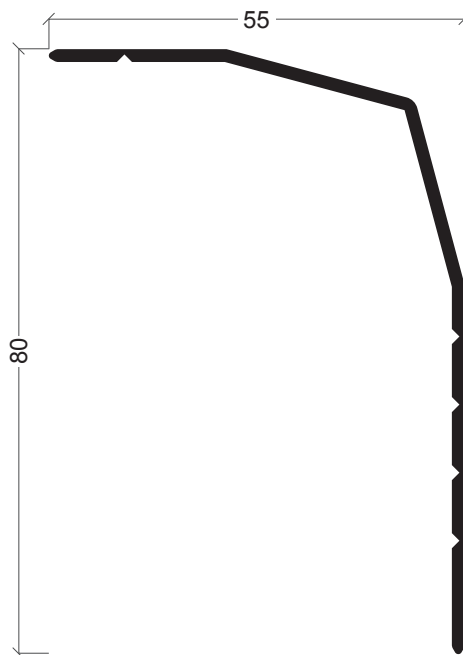

AXi-72
Remate

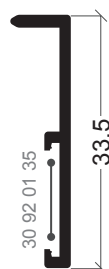

AXi-88
Remate



AXi-91
Complemento remate

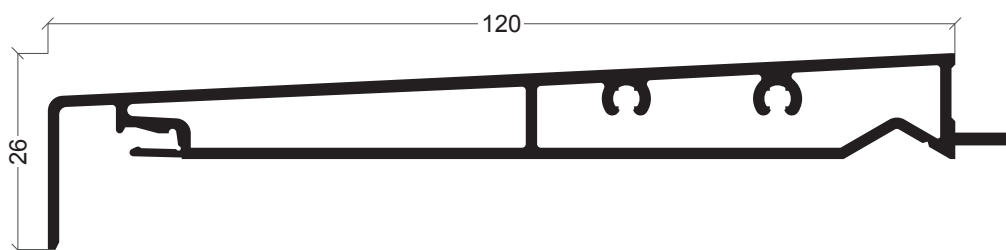

AXi-74
Pingadeira de 120 mm

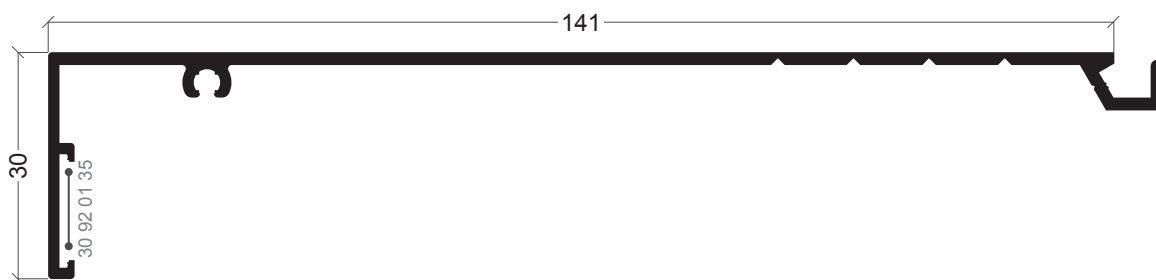

S-09
Remate

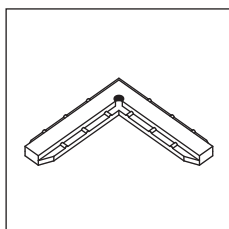

30 21 20 07

Esquadro de alinhamento

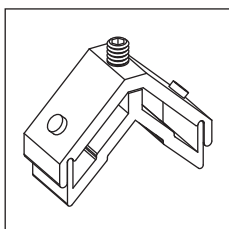

30 91 40 15

Esquadro aro fixo

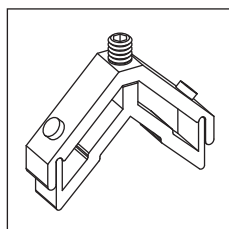

30 91 40 25

Esquadro aro móvel

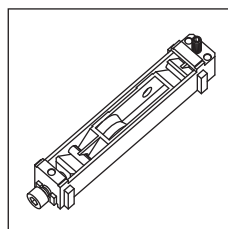

30 91 40 35

Rolamento simples (25Kg)

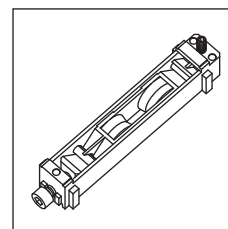

30 91 40 36

Rolamento simples (50Kg)

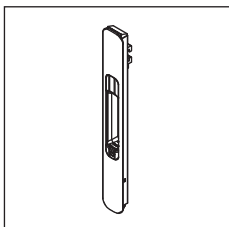

30 91 40 39/40/41

Fecho lateral manual natural/branco/preto

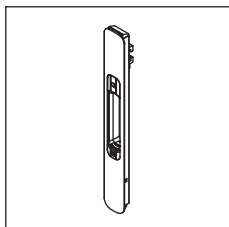

30 91 40 42/43

Fecho lateral de embutir branco/preto

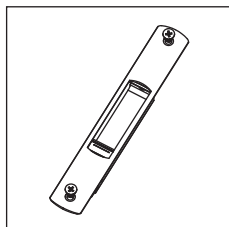

30 91 40 45/46

Fecho lateral com fixação branco/preto

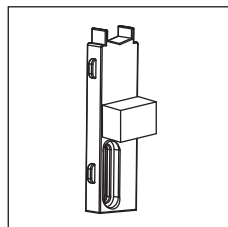

30 91 40 50

Guia lateral batente

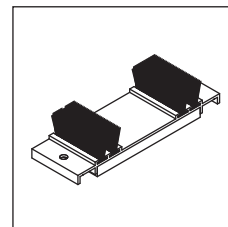

30 91 40 70

Corta-vento superior/inferior

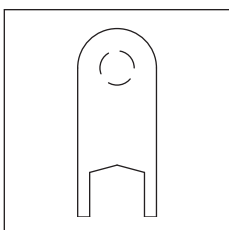

30 91 41 00

Tampa aro móvel recta

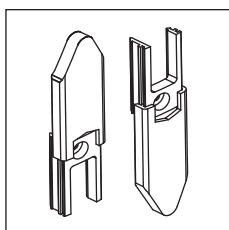

30 91 41 05

Jogo topos laterais

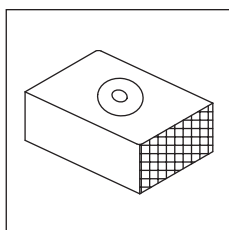

30 91 41 10

Taco anti-levantamento preto

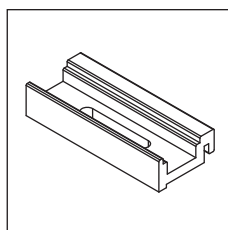

30 91 41 20

Calço nº 1 para multi-ponto CT-02/12/53

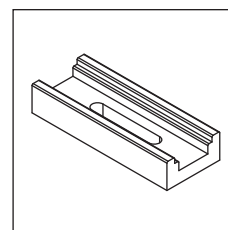

30 91 41 21

Calço nº 2 para multi-ponto CT-35

296

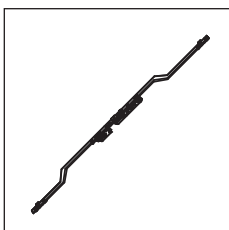

30 91 41 22

Ferragem MP c/ chave sem canhão

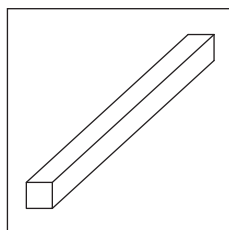

30 91 41 23

Perno 7x131 mm

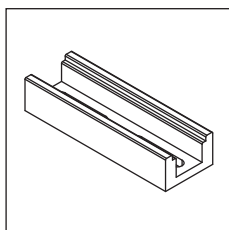

30 91 41 24

Calço nº 3 para multi-ponto inox

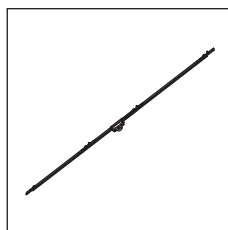

30 91 41 29

Barra 4 pontos (1800 mm)

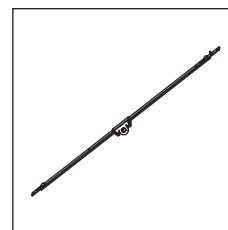

30 91 41 30

Barra 2 pontos (600 mm)

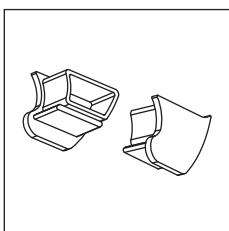

30 91 41 35

Jogo topos CT-03

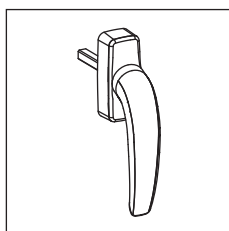

30 91 41 47/48

Cremone multi-ponto branco/preto

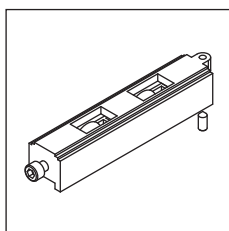

30 91 41 49

Rolamento duplo (75 kg)

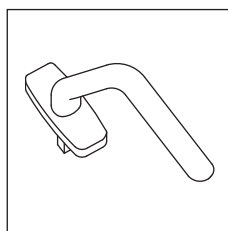

30 91 41 52/53

Cremone desviado direita branco/preto

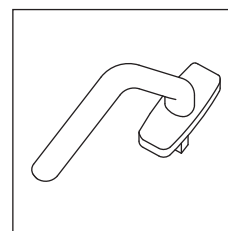

30 91 41 54/55

Cremone desviado esquerda branco/preto

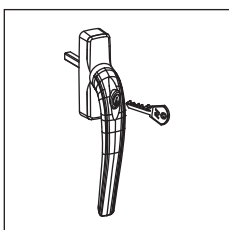

30 91 41 56/57

Cremone porta com chave branco/preto

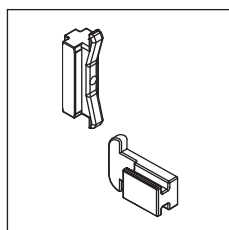

30 91 41 60

Ponto de fecho para carris abertos

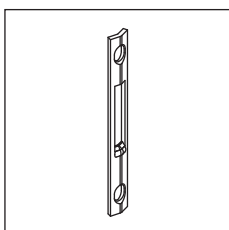

30 91 41 61

Ponto de fecho plano (para ferragem inox)

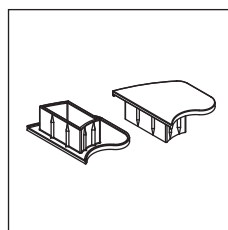

30 91 41 63/64

Jogo topos CT-27 branco/preto

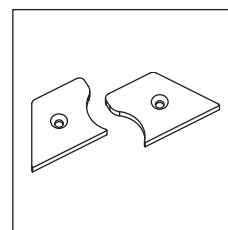

30 91 41 65/66

Jogo topos CT-28 branco/preto

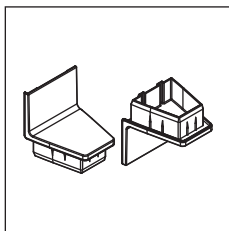

30 91 41 67/68
Jogo topos centrais
(branco/preto)

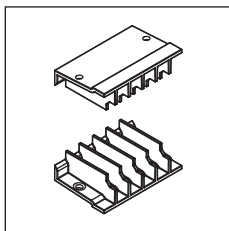

30 91 41 69
Corta ventos aro fixo
Benelux (CT-36/38)

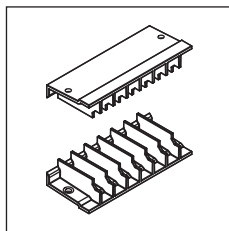

30 91 41 70
Corta ventos aro fixo Benelux
(CT-02/12/37/39/53)

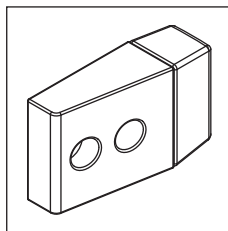

30 91 41 71
Topo limitador de
abertura

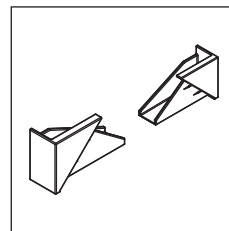

30 91 41 72/73
Jogo topos aro
condensação branco/preto

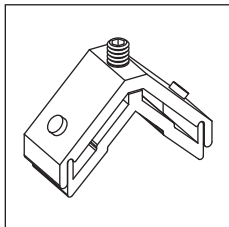

30 91 41 74
Esquadro aro fixo
perimetral Benelux

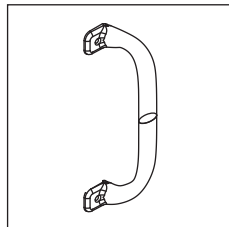

30 91 41 77/78
Puxador p/ fecho embutir
(branco/preto)

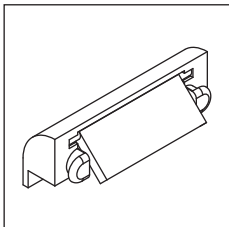

30 92 01 02/03
Goteira nylon c/ válvula
preto / branco

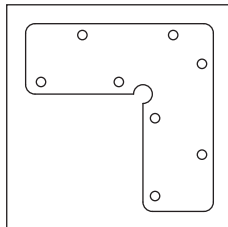

30 92 01 35
Esquadro alinhamento

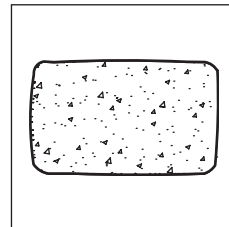

30 92 04 70
Espuma isolante

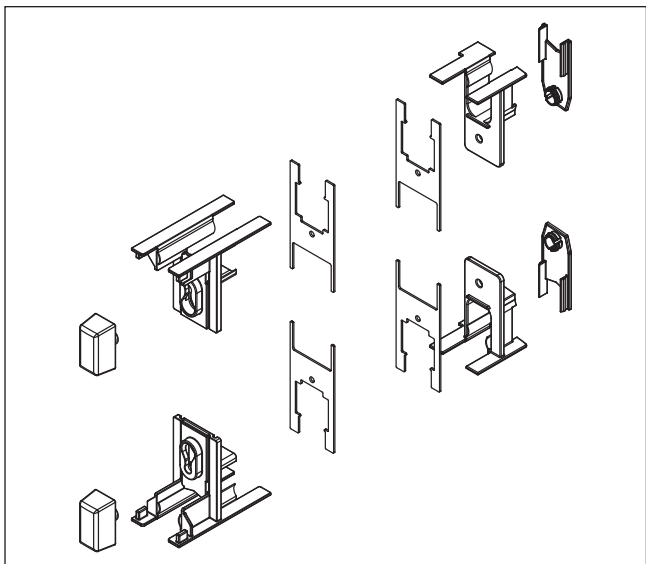

30 91 41 81
Kit topos de janela folhas
laterais Benelux (1 folha)

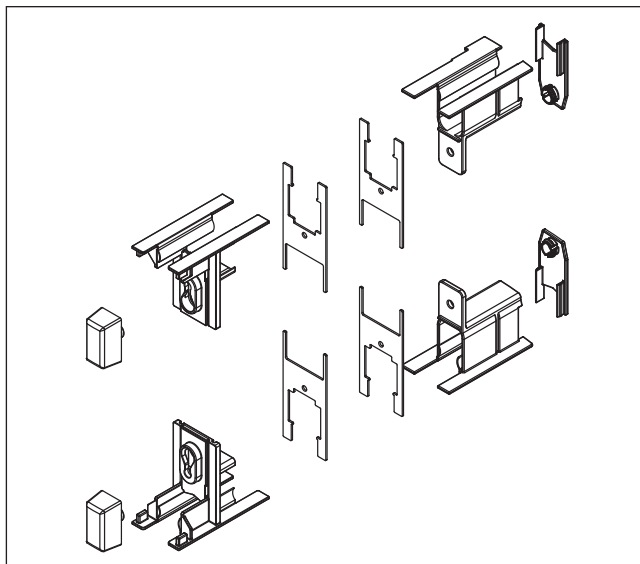

30 91 41 82
Kit topos de porta folhas
laterais Benelux (1 folha)

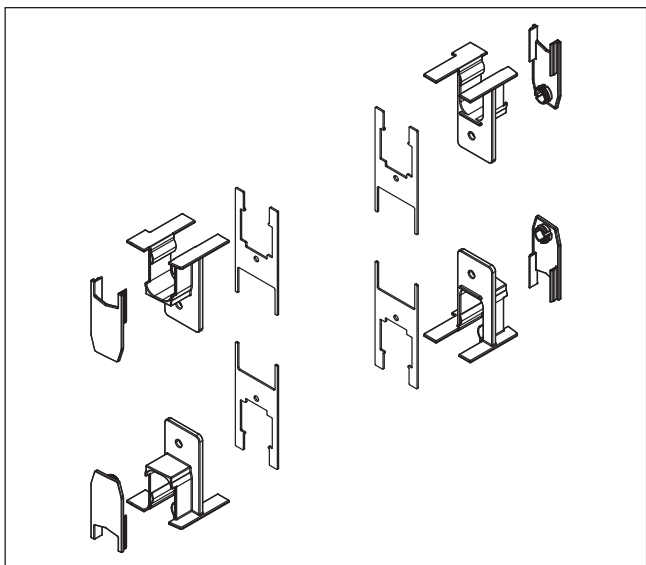

30 91 41 83
Kit topos de janela folha
central Benelux (3ª folha)

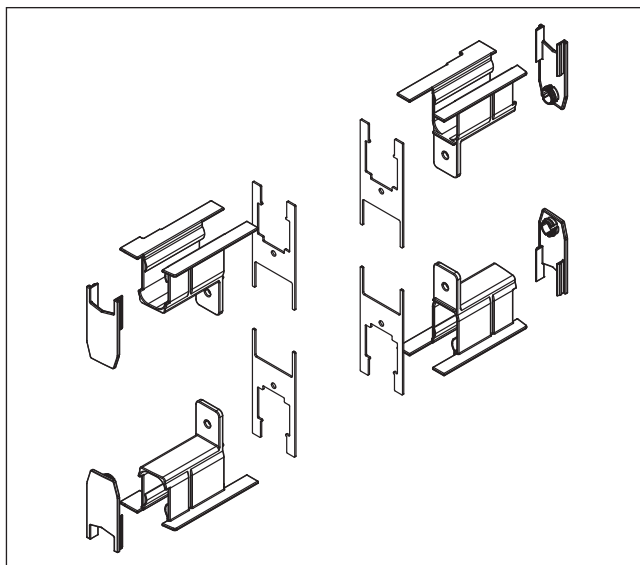

30 91 41 84
Kit topos de porta folha
central Benelux (3ª folha)

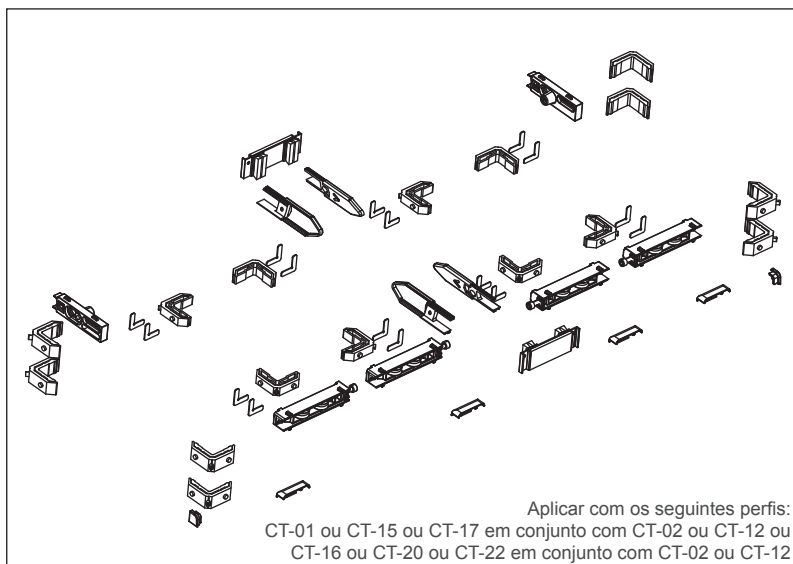

Aplicar com os seguintes perfis:
CT-01 ou CT-15 ou CT-17 em conjunto com CT-02 ou CT-12 ou
CT-16 ou CT-20 ou CT-22 em conjunto com CT-02 ou CT-12

30 91 41 85

Kit de correr janela CT (2 folhas). Resistência até 50Kg/folha. Utilização vãos de 2 folhas.

30 91 41 86

Kit de correr porta CT (2 folhas). Resistência até 100Kg/folha. Utilização vãos de 2 folhas.

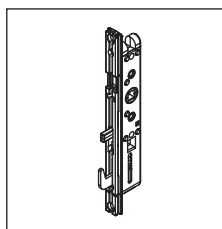

30 92 07 30

Ferragem MP regulável inox 1 ponto CT-35



30 92 07 35

Ferragem MP regulável inox 2 pontos CT-35



30 92 07 40

Ferragem MP regulável inox 3 pontos CT-35



30 92 07 45

Ferragem MP regulável inox 3 pontos com chave CT-35

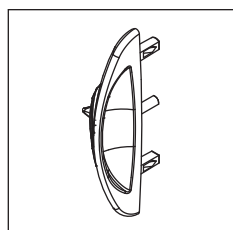

30 92 07 50/55

Puxador calipso interior branco/preto (p/ ferragem inox)

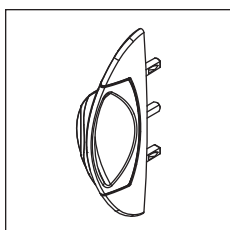

30 92 07 60/65

Puxador neptune interior branco/preto (p/ ferragem inox)

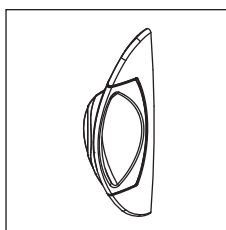

30 92 07 70/75

Puxador neptune exterior branco/preto (p/ ferragem inox)

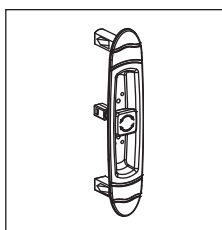

30 92 07 80/85

Fecho lateral hera branco/preto (p/ ferragem inox)

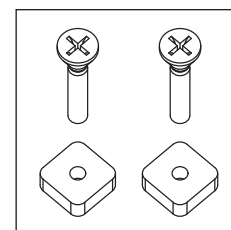

30 92 07 96

Placas para pontos de fecho multiponto com carris abertos

298

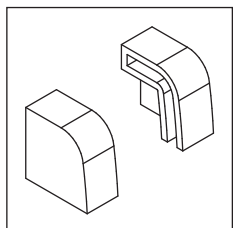

30 96 00 12

Jogo topos condensação CT-11/ARI-32

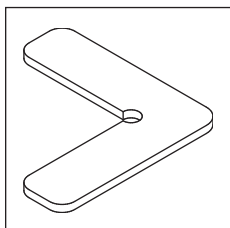

30 96 00 23

Esquadro alinhamento

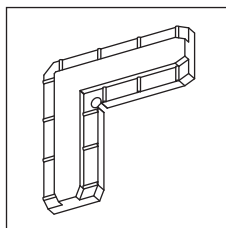

30 96 00 43

Esquadro de alinhamento 004

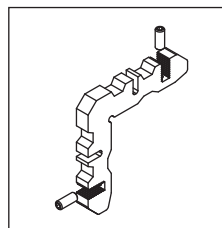

30 96 00 48

Esquadro de alinhamento 7x14 c/ parafusos

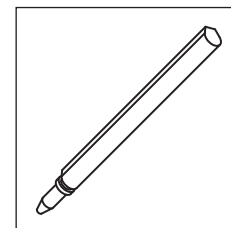

30 96 00 55

Perno alternativo para fixação de esquadro

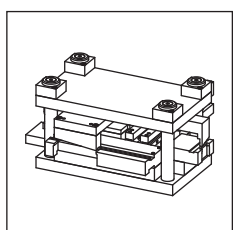

33 94 29 99

Cunho CT

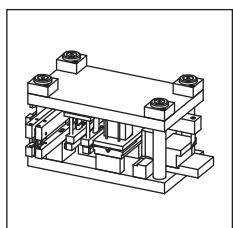

33 94 30 00

Cunho CT Benelux

Referência	Desenho	Descrição
30 20 30 03		Junta isolante CT-01/11/15/17
30 25 44 15		Junta tapa canal
30 91 41 87		Junta tapa carril aberto
30 91 41 88		Junta de correr
30 93 00 65		Junta interior para vidro (5 mm)
30 93 00 66		Junta interior para vidro (4 mm)
30 93 00 67		Junta interior para vidro (2 mm)
30 93 00 68		Junta interior para vidro (6/7 mm)
30 93 00 69		Junta interior para vidro (8/9 mm)
30 95 00 40		Pelúcia 7x5.5 mm
30 95 00 50		Pelúcia 7x6 mm
30 95 00 70		Pelúcia 7x3.5 mm

Janela 2 folhas correr

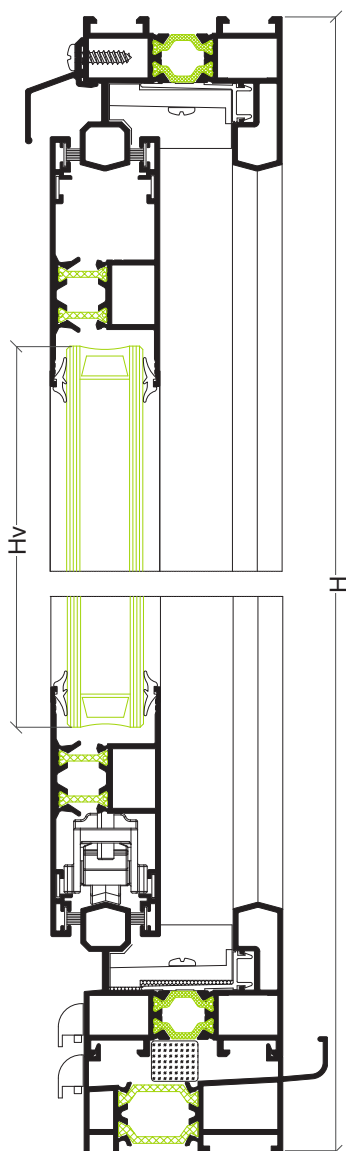
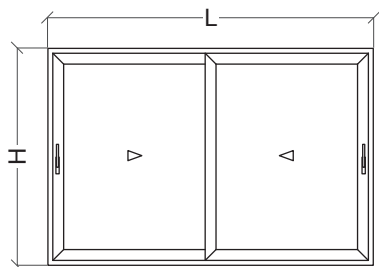

Perfis

Desenho	Ref	Descrição	Corte	Quant	Medida
	CT-41	Aro fixo perimetral		2	L
				2	H-28.5 mm
	CT-23	Tampa aro fixo		2	L-40 mm
				2	H-68 mm
	CT-53	Aro móvel perimetral		4	L/2+1 mm
				4	H-101.5 mm
	CT-54	Tampa cruzamento 2 folhas		2	H-101.5 mm
	CT-29	Pingadeira superior		1	L
	CT-08	União cruzamento 2 folhas		2	H-101.5 mm
	CT-11	Soleira de condensação		1	L

Acessórios e Juntas

Referência	Descrição	Quantidade
30 91 41 74	Esquadro aro fixo	8
30 91 40 25	Esquadro aro móvel	8
30 91 40 35	Rolamento simples	4
30 91 40 42	Fecho lateral	2
30 91 40 50	Guia lateral	4
30 91 40 70	Corta-ventos inferior/superior	1
30 91 41 00	Tampa móvel recta	4
30 92 01 02	Goteiras	4
30 96 00 12	Jogo topos condensação	1
30 96 00 23	Esquadro alinhamento	16
30 91 41 10	Taco anti-levantamento	2
30 92 04 70	Espuma isolante	L
----	Junta vidro	4L+8H
30 95 00 40*	Pelúcia 7x5.5 mm	4L+6H

* junta alternativa ref.: 30 91 41 88

Vidro

Hv = H-200 mm	Lv = L/2-126 mm
---------------	-----------------

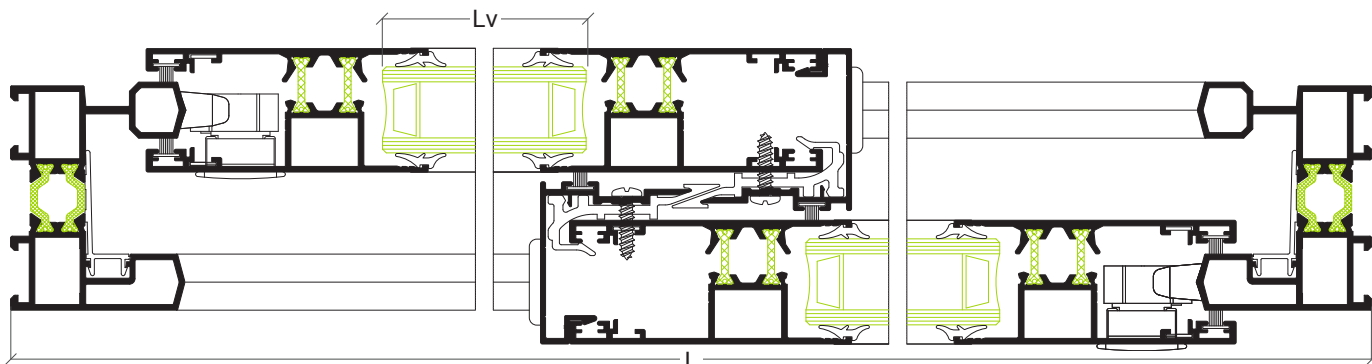

Janela 2 folhas correr

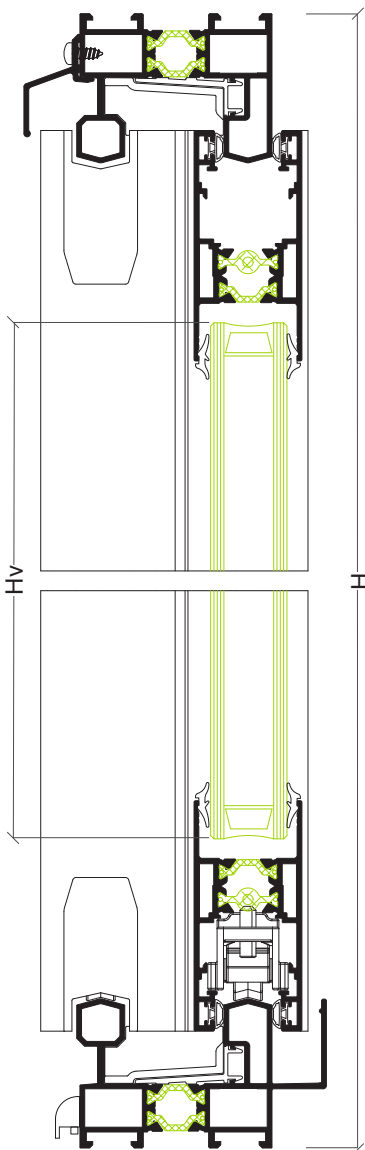
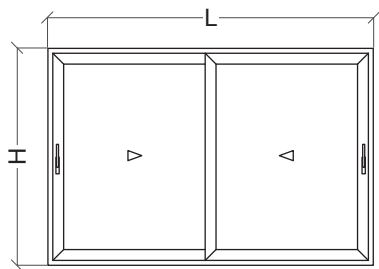

Perfis

Desenho	Ref	Descrição	Corte	Quant	Medida
	CT-41	Aro fixo perimetral		1	L
				2	H
	CT-43	Aro fixo perimetral condensação		1	L
	CT-23	Tampa aro fixo		2	L-40 mm
				2	H-40 mm
	CT-34	Aro móvel carrinho		4	L/2-93 mm
	CT-35	Aro móvel lateral		2	H-73 mm
	CT-36	Aro móvel central		2	H-73 mm
	CT-25	Cruzamento móvel		2	H-73 mm
	CT-29	Pingadeira superior		1	L

Acessórios e Juntas

Referência	Descrição	Quantidade
30 91 41 74	Esquadro aro fixo	8
30 91 40 35	Rolamento simples	4
30 91 40 42	Fecho lateral	2
30 91 41 69	Jogo corta-ventos superior/inferior	1
30 91 41 81	Kit topos janela	2
30 92 01 02	Goteiras	2
30 91 41 73	Jogo topos condensação	1
30 91 41 10	Taco anti-levantamento	2
30 91 41 88*	Junta de correr	4L+6H

* pelúcia alternativa ref.: 30 95 00 40

Vidro



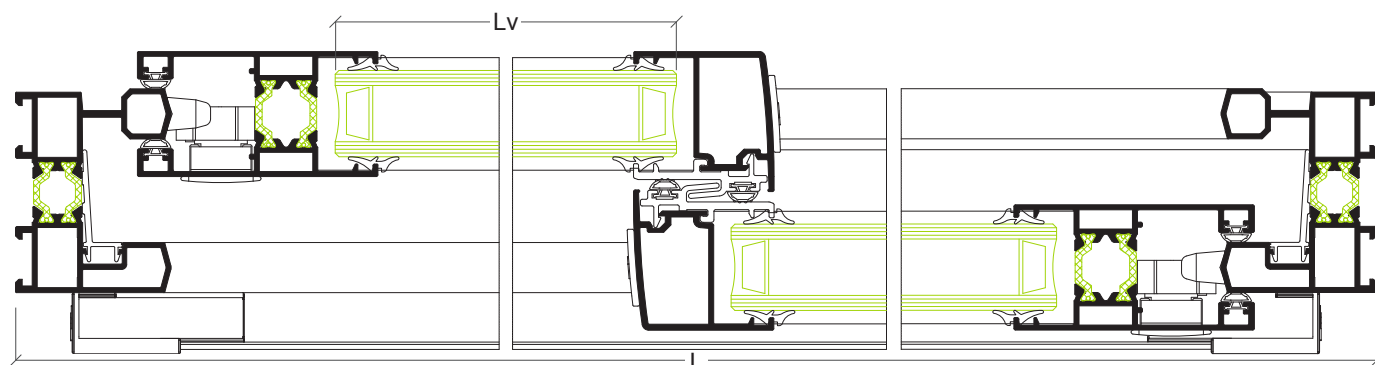



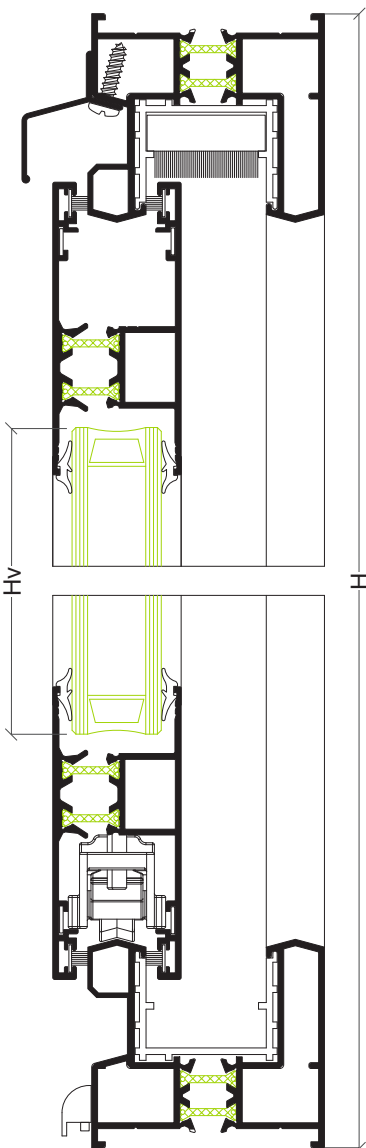
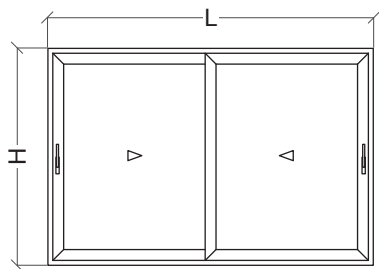









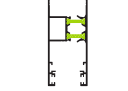

Hv = H-192 mm	Lv = L/2-103 mm
---------------	-----------------

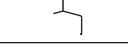

Porta 2 folhas correr multiponto



Perfis

Desenho	Ref	Descrição	Corte	Quant	Medida
	CT-01	Aro fixo perimetral		2	L
				2	H
	CT-09	Tampa aro fixo		2	L-45 mm
				2	H-45 mm
	CT-53	Aro móvel perimetral		4	L/2-7 mm
				4	H-87 mm
	CT-54	Tampa cruzamento 2 folhas		2	H-87 mm
	CT-07	Pingadeira superior		1	L
	CT-08	União cruzamento 2 folhas		2	H-87 mm
	CT-28	Perfil de reforço		1	H-170 mm
	AX-19	Complementar para perfil de reforço		1	H-170 mm

Acessórios e Juntas

Referência	Descrição	Quantidade
30 91 40 15	Esquadro aro fixo	8
30 91 40 25	Esquadro aro móvel	8
30 91 41 49	Rolamento duplo reforçado	4
----	Ferragem multiponto (600 ou 1800 mm)	2
30 91 41 47	Cremona multiponto	2
30 91 41 20	Calço nº 1 para multiponto	8 ou 16
30 91 41 71	Limitador de abertura	1
30 91 40 50	Guia lateral	4
30 91 40 70	Corta ventos inferior/superior	2
30 91 41 00	Tampa móvel recta	4
30 92 01 02	Goteiras	2
30 96 00 23	Esquadro alinhamento	16
30 91 41 66	Jogo topos CT-28	2
----	Junta vidro	4L+8H
30 95 00 40'	Pelúcia 7x5.5 mm	4L+6H

* junta alternativa ref.: 30 91 41 88

Vidro

Hv = H-214 mm	Lv = L/2-134 mm
---------------	-----------------

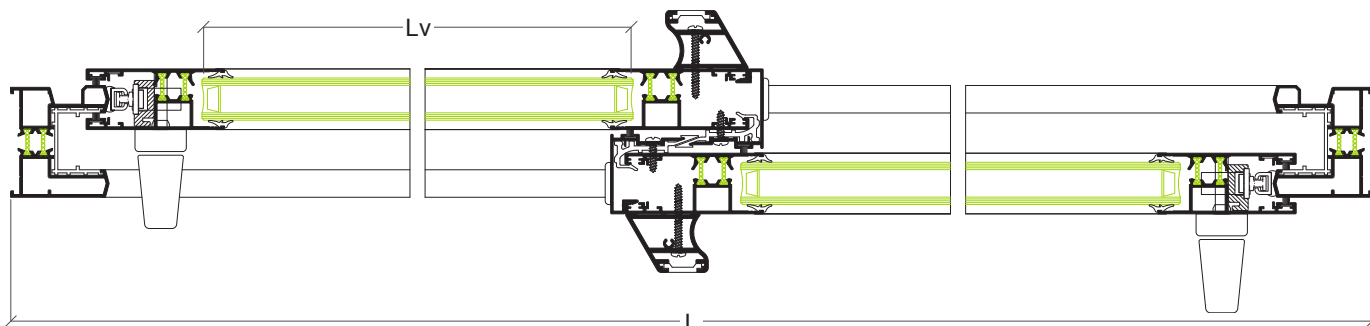

Porta 2 folhas correr multiponto

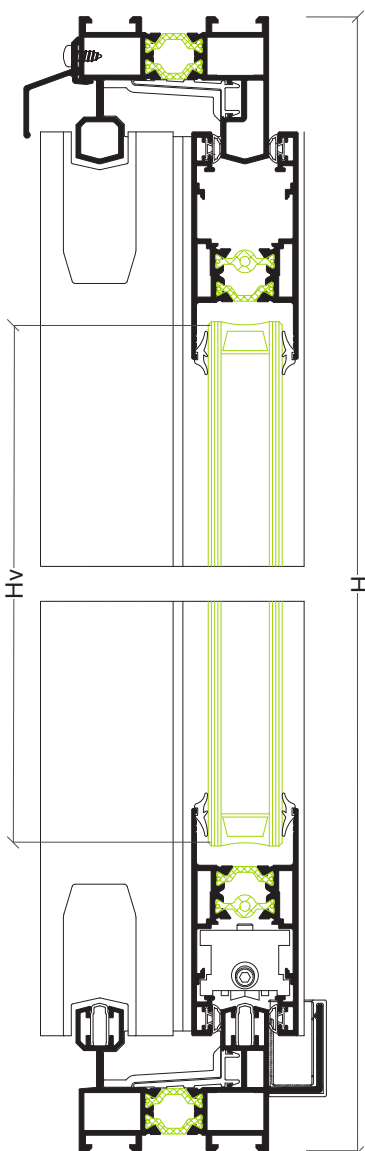
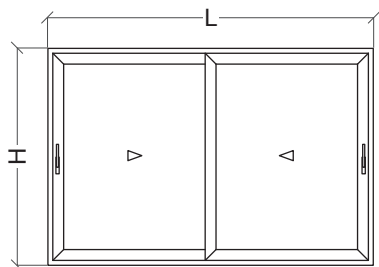

Perfis

Desenho	Ref	Descrição	Corte	Quant	Medida
	CT-41	Aro fixo perimetral		1	L
				2	H
	CT-44	Aro fixo perimetral condensação		1	L
	CT-33	Guia carril		2	L-93 mm
	CT-23	Tampa aro fixo		2	L-40 mm
				2	H-40 mm
	CT-34	Aro móvel carrinho		4	L/2-107 mm
	CT-35	Aro móvel lateral		2	H-73 mm
	CT-37	Aro móvel central		1	H-73 mm
	CT-39	Aro móvel central com reforço		1	H-73 mm
	CT-26	Cruzamento móvel		2	H-73 mm
	CT-29	Pingadeira superior		1	L

Acessórios e Juntas

Referência	Descrição	Quantidade
30 91 41 74	Esquadro aro fixo	8
30 91 41 49	Rolamento duplo reforçado	4
----	Ferragem multiponto (600 ou 1800 mm)	2
30 91 41 47	Cremona multiponto	2
30 91 41 21	Calço nº 2 para multiponto	8 ou 16
30 91 41 71	Limitador de abertura	1
30 91 41 70	Jogo corta-ventos superior/inferior	1
30 91 41 82	Kit topos porta	2
30 92 01 00	Goteiras	2
30 91 41 73	Jogo topos condensação	1
30 91 41 67	Jogo topo central	1
30 91 41 88*	Junta de correr	4L+6H

* pelúcia alternativa ref.: 30 95 00 40

Vidro



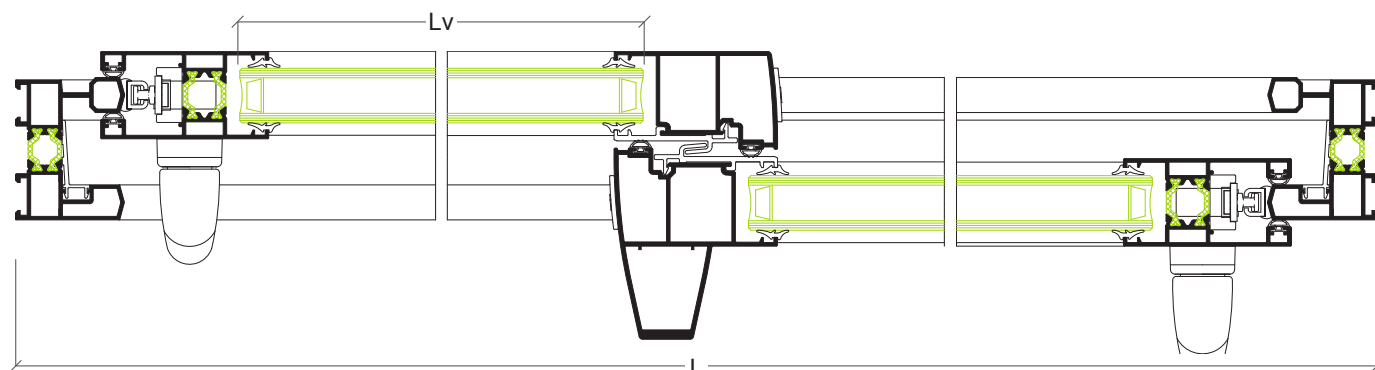



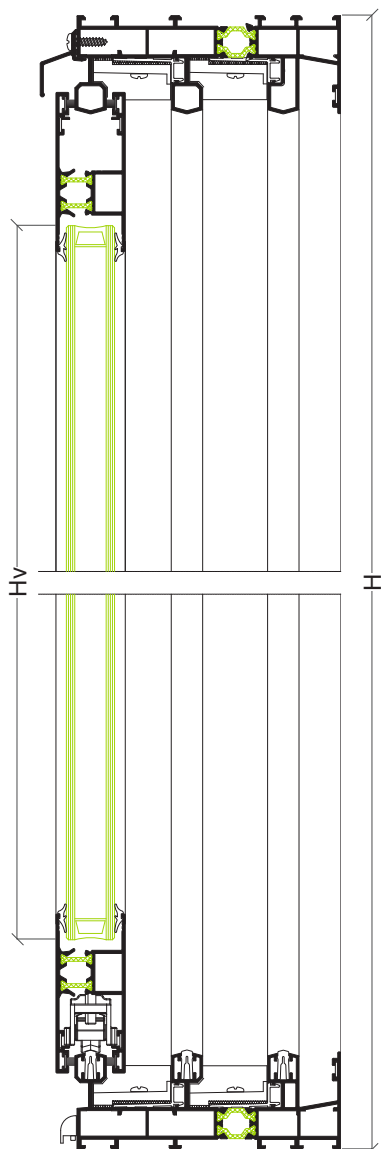
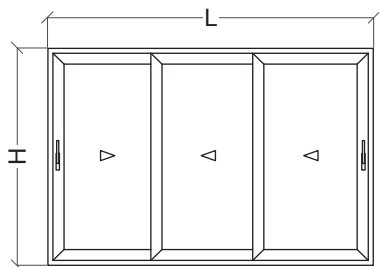





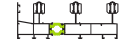

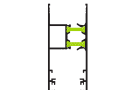

Hv = H-192 mm	Lv = L/2-119 mm
---------------	-----------------

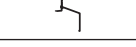

Porta 3 folhas correr tri-rail



Perfis

Desenho	Ref	Descrição	Corte	Quant	Medida
	CT-51	Aro fixo perimetral		1	L
				2	H
	CT-52	Aro fixo perimetral		1	L
	CT-23	Tampa aro fixo		4	L-40 mm
				4	H-40 mm
	CT-53	Aro móvel perimetral		6	L/3+22.5 mm
				6	H-73 mm
	CT-54	Tampa cruzamento móvel		4	H-73 mm
	CT-29	Pingadeira superior		1	L
	CT-08	Cruzamento móvel		4	H-73 mm
	CT-71	Guia carril (poliamida)		3	L-93 mm

Acessórios e Juntas

Referência	Descrição	Quantidade
30 91 41 74	Esquadro aro fixo	12
30 91 40 25	Esquadro aro móvel	12
30 91 41 49	Rolamento duplo reforçado	6
----	Ferragem multiponto (600 ou 1800 mm)	2
30 91 41 47	Cremona multiponto	2
30 91 41 20	Calço nº 1 para multiponto	8 ou 16
30 91 41 71	Limitador de abertura	2
30 91 40 50	Guia lateral	4
30 91 41 70	Corta-ventos inferior/superior	6
30 91 41 00	Tampa guia recta	8
30 92 01 02	Goteiras	4
30 96 00 23	Esquadro alinhamento	24
----	Junta vidro	4L+12H
30 95 00 40'	Pelúcia 7x5.5 mm	4L+8H

* junta alternativa ref.: 30 91 41 88

Vidro

Hv = H-200 mm	Lv = L/3-104 mm
---------------	-----------------

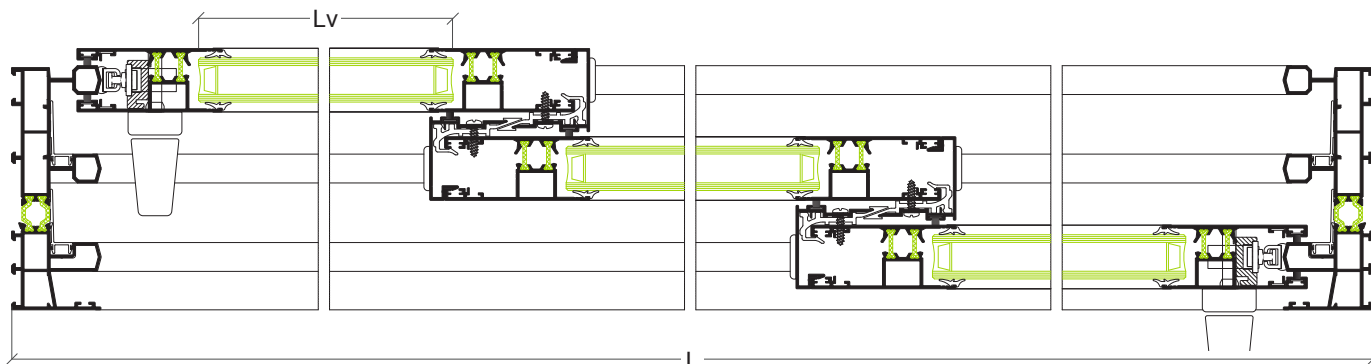

Janela 3 folhas correr tri-rail

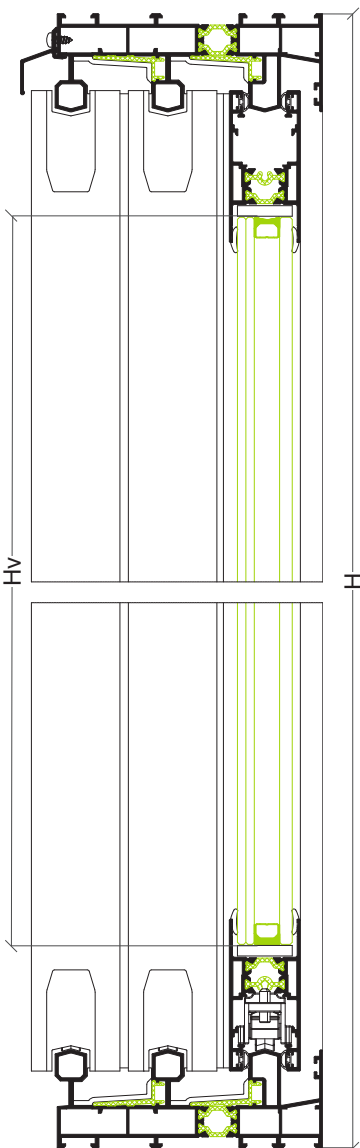
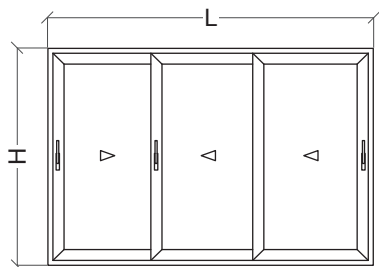

Perfis

Desenho	Ref	Descrição	Corte	Quant	Medida
	CT-51	Aro fixo perimetral		2	L
				2	H
	CT-23	Tampa aro fixo		4	L-40 mm
				4	H-40 mm
	CT-34	Aro móvel carrinho		6	L/3-64 mm
	CT-35	Aro móvel lateral		2	H-73 mm
	CT-36	Aro móvel central		4	H-73 mm
	CT-25	Cruzamento móvel		4	H-73 mm
	CT-29	Pingadeira superior		1	L

Acessórios e Juntas

Referência	Descrição	Quantidade
30 91 41 74	Esquadro aro fixo	12
30 91 40 35	Rolamento simples	6
30 91 40 42	Fecho lateral	2
30 91 41 69	Jogo cortaventos superior/inferior	2
30 91 41 81	Kit topos janela folhas laterais	2
30 91 41 83	Kit topos janela folhas centrais	1
30 92 01 00	Goteiras	2
30 91 41 88 *	Junta de correr	4L+8H

* pelúcia alternativa ref.: 30 95 00 40

Vidro

Hv = H-193 mm	Lv = L/3-76 mm
---------------	----------------

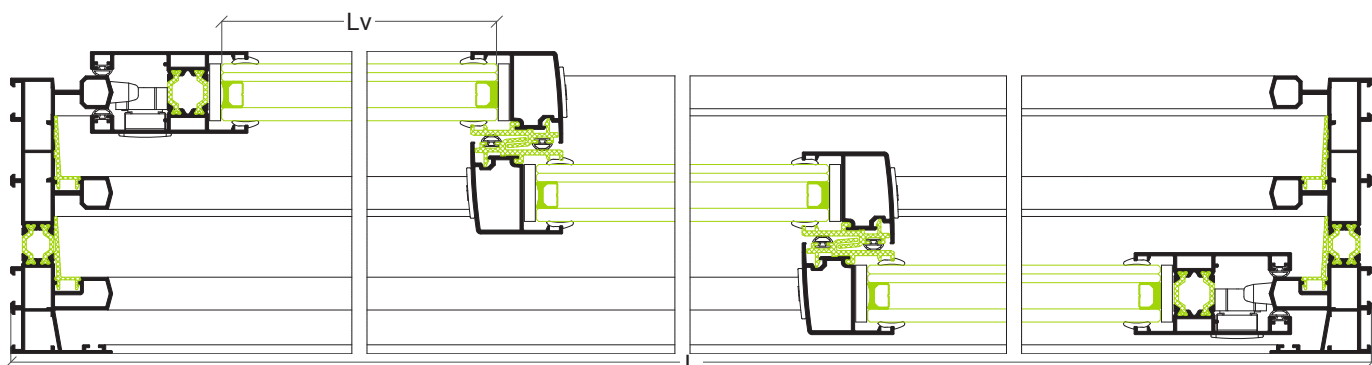

Janela 4 folhas correr

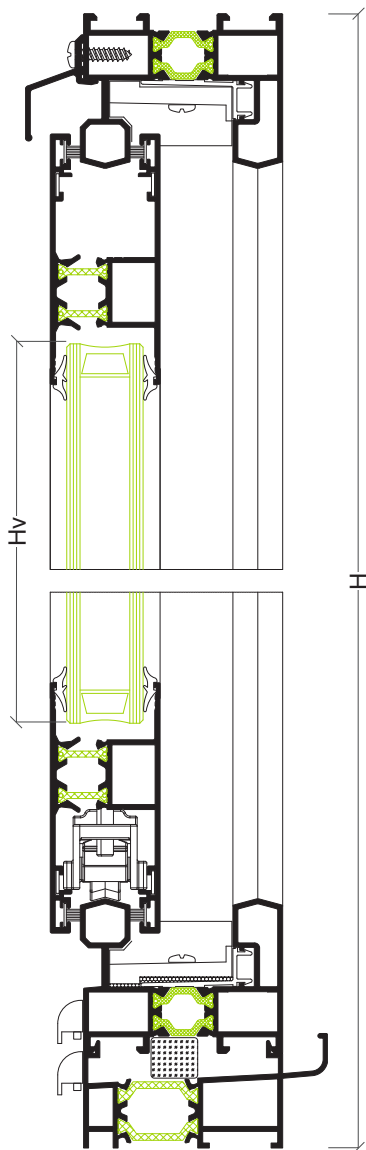
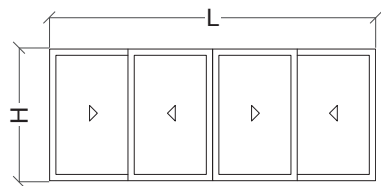

Perfis

Desenho	Ref	Descrição	Corte	Quant	Medida
	CT-41	Aro fixo perimetral		2	L
				2	H-28.5 mm
	CT-23	Tampa aro fixo		4	L-40 mm
				4	H-68 mm
	CT-53	Aro móvel perimetral		8	L/4+16.5 mm
				8	H-101.5 mm
	CT-54	Tampa cruzamento 2 folhas		4	H-101.5 mm
	CT-29	Pingadeira superior		1	L
	CT-08	Cruzamento móvel		4	H-101.5 mm
	CT-11	Soleira de condensação		1	L
	CT-24	União 3/4 folhas		1	L-101.5 mm

Acessórios e Juntas

Referência	Descrição	Quantidade
30 91 41 74	Esquadro aro fixo	8
30 91 40 25	Esquadro aro móvel	16
30 91 40 35	Rolamento simples	8
30 91 40 42	Fecho lateral	3
30 91 40 50	Guia lateral	6
30 91 41 70	Corta-ventos inferior/superior	3
30 91 41 00	Tampa móvel recta	8
30 92 01 02	Goteiras	4
30 96 00 12	Jogo topos condensação	1
30 96 00 23	Esquadro alinhamento	32
30 91 41 10	Taco anti-levantamento	3
30 92 04 70	Espuma isolante	L
----	Junta vidro	4L+16H
30 95 00 40'	Pelúcia 7x5.5 mm	4L+10H

* junta alternativa ref.: 30 91 41 88

Vidro

Hv = H-200 mm	Lv = L/4-110 mm
---------------	-----------------

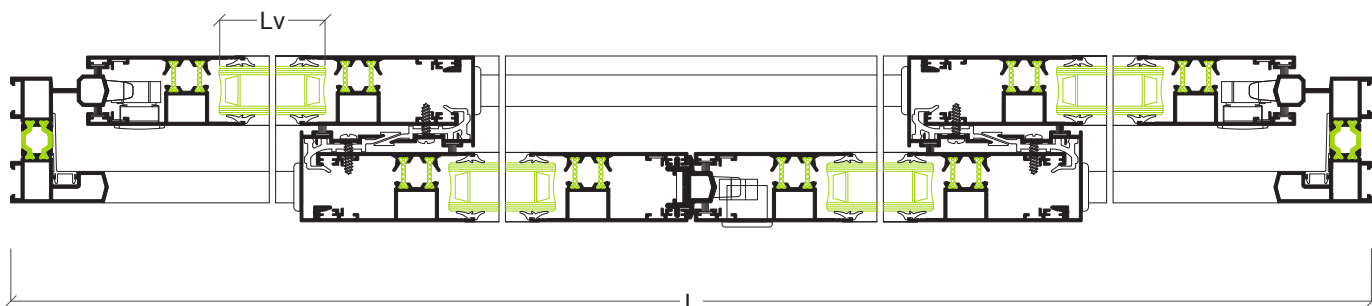

Porta 2 folhas correr multiponto

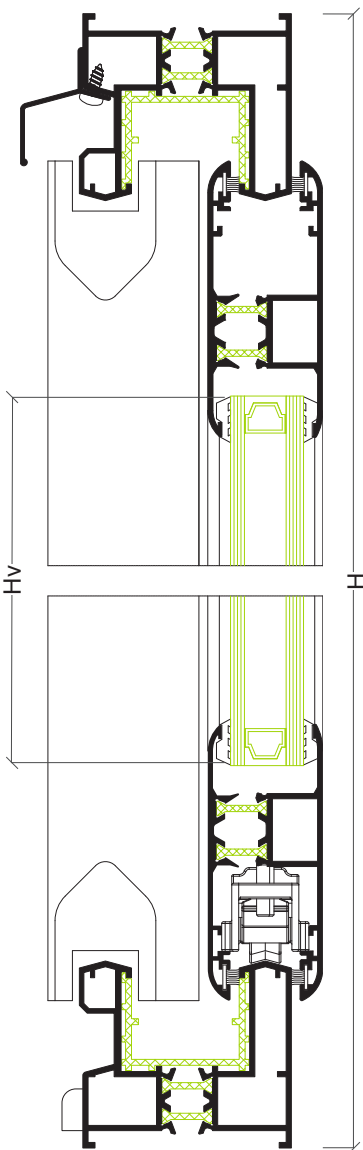
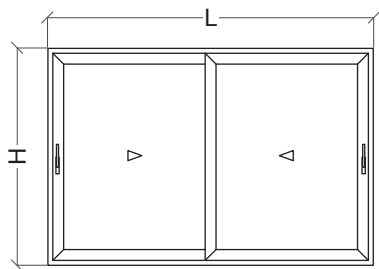

Perfis

Desenho	Ref	Descrição	Corte	Quant	Medida
	CT-01	Aro fixo perimetral		2	L
				2	H
	CT-09	Tampa aro fixo		2	L-45 mm
				2	H-45 mm
	CT-12	Aro móvel perimetral		4	L/2-4 mm
				4	H-85 mm
	CT-06	Tampa cruzamento móvel		2	H-85 mm
	CT-07	Pingadeira superior		1	L
	CT-08	Cruzamento móvel		2	H-85 mm
	CT-03	Reforço (opcional)		2	H-170 mm
	AX-19	Vareta (opcional)		2	H-170 mm

Acessórios e Juntas

Referência	Descrição	Quantidade
30 91 40 15	Esquadro aro fixo	8
30 91 40 25	Esquadro aro móvel	8
30 91 40 36	Rolamento duplo	4
30 91 40 50	Guia lateral	2
30 91 40 70	Corta-ventos inferior/superior	2
30 91 41 05	Jogo topos laterais	2
30 91 41 35	Jogo topos CT-03	2
30 92 01 02	Goteiras	2
30 96 00 23	Esquadro alinhamento	16
-----	Barra de ferragem multi-ponto (600 ou 1800 mm)	2
30 91 41 47	Cremona multiponto	2
30 91 41 20	Calço nº 1	8 ou 16
30 95 00 40*	Pelúcia 7x5.5 mm	2L+6H
-----	Junta vidro	4L+8H

* junta alternativa ref.: 30 91 41 88

Vidro

Hv = H-214 mm	Lv = (L/2)-133 mm
---------------	-------------------

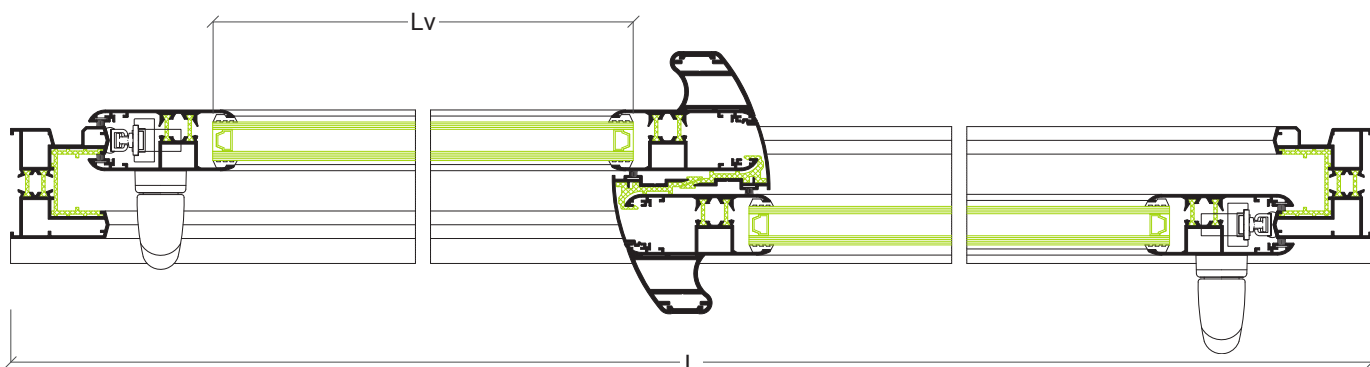

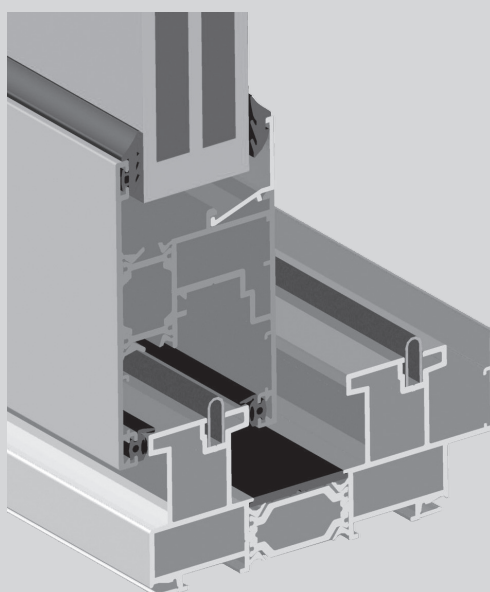
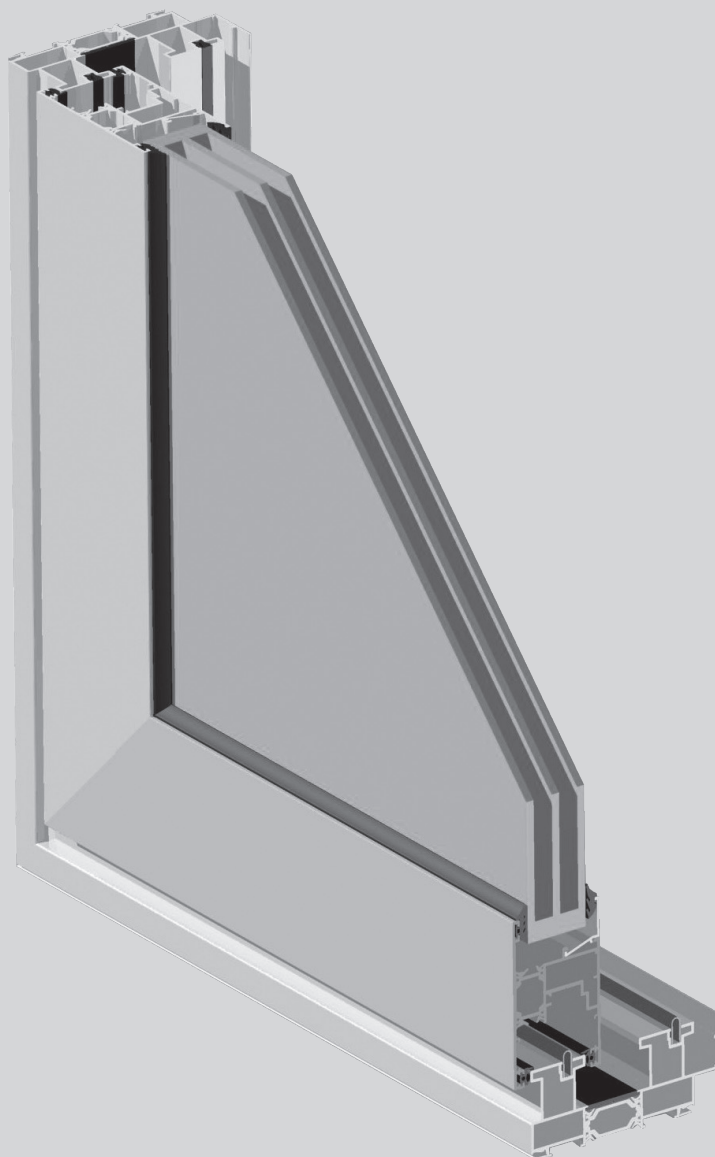

Sistema
CW

Sistema CW

Sistema de correr com RPT - 105 mm

Características do sistema

Sistema de alumínio com rotura térmica para executar vãos de correr.

Perfis de alumínio

Os perfis de alumínio são extrudidos na liga de alumínio 6060 para arquitetura de acordo com norma NP EN 12020-02.

Perfis com rotura térmica obtida por inserção de varetas isolantes de poliamida de 6.6 mm reforçadas com 25% de fibra de vidro de 30 mm nos aros fixos e de 14.6 mm nos aros móveis.

Espessura média dos perfis de alumínio de 1.5 mm.

Aros fixos

Secção do aro fixo perimetral de 2 guias de 105 mm para montagem a meia esquadria;

Perfil guia de deslizamento inferior em aço inoxidável AISI 304 para evitar desgaste das peças.

Aros móveis

Secção dos aros móveis perimetrais de 48 mm com montagem a meia esquadria;

Enchimento de 4 a 36 mm;

Aros móveis de linha recta com ou sem bite ou com bite reduzido;

Bites rectos;

Estanquidade assegurada através de juntas em EPDM e pelúcia tipo Fin-Seal.

Dimensionamento e manobralidade

Dimensões mínimas - máximas de folha: 300 mm - 2500 mm (L); 350 mm - 2675 mm (H);

Peso máximo de 200 kg por folha (com 2 rolamentos duplos);

Tipologias de 2, 3, 4 e 6 folhas móveis e/ou fixas;

Tipologias de correr Galandage de 1 ou 2 folhas;

Rolamento duplo oscilante com regulação;

Rolamentos de agulhas em inox com eixo temperado retificado sendo possível a substituição sem desmontagem da folha;

Suporte exterior com tratamento cataforese (anti-corrosivo);

Abertura do vão com fecho lateral ou ferragem multi-ponto com 2 ou 4 pontos de fecho;

Puxadores desviados (esquerdo ou direito) para ferragem multi-ponto permitindo maior facilidade de abertura;

Possibilidade de aplicação de ferragem elevatória de média dimensão;

Puxador específico para ferragem elevatória de modo a facilitar as manobras de abertura e fecho do vão;

Existe a opção de puxador duplo com colocação de canhão com chave para permitir a abertura do vão pelo exterior.

Performances

Sistema certificado por laboratório notificado para Ensaio Tipo Inicial (ITT) de acordo com a norma de produto EN 14351-1 para efeitos de Marcação CE.

Categorias alcançadas na avaliação do sistema CW tipologia janela:

1. Permeabilidade ao ar: Classe 3 (norma de ensaio EN 1026)
2. Estanquidade à água: Classe 7A (norma de ensaio EN 1027)
3. Resistência ao vento: Classe C5 (norma de ensaio EN 12211)

Categorias alcançadas na avaliação do sistema CW tipologia porta:

1. Permeabilidade ao ar: Classe 3 (norma de ensaio EN 1026)
2. Estanquidade à água: Classe 6A (norma de ensaio EN 1027)
3. Resistência ao vento: Classe B3 (norma de ensaio EN 12211)

Categorias alcançadas na avaliação do sistema CW tipologia porta elevatória:

1. Permeabilidade ao ar: Classe 4 (norma de ensaio EN 1026)
2. Estanquidade à água: Classe 7A (norma de ensaio EN 1027)
3. Resistência ao vento: Classe C3 (norma de ensaio EN 12211)

Categorias alcançadas na avaliação do sistema CW para determinação das forças de manobra (EN 12046):

1. Libertação da ferragem de fecho: Classe 2
2. Abertura da folha: Classe 1
3. Fecho da folha: Classe 2
4. Engate da ferragem de fecho: Classe 2

Categoria alcançada na determinação da resistência a abertura e fecho repetidos (5000 ciclos): Classe 1 (EN 1191)

Coefficiente de transmissão térmica de vão de 2 folhas com 4.0 m x 2.4 m com vidro $U_g = 0.7 \text{ W/m}^2\text{K}$, com intercalar efeito "Warm Edge":

- $U_w = 1.48 \text{ W/m}^2\text{K}$

Coefficiente de atenuação acústica de vão de 2 folhas com vidro acústico 6/16/44.1:

- $R_w (C; C_{tr}) = 34 \text{ dB} (-1; -6)$

Zonas de aplicação segundo RCCTE (em função do valor U_g): I1, I2, I3, V1, V2, V3.

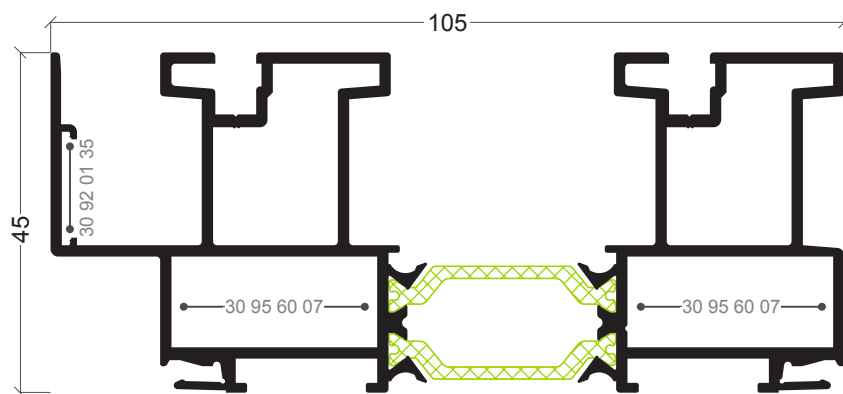

CW-01
Aro fixo perimetral

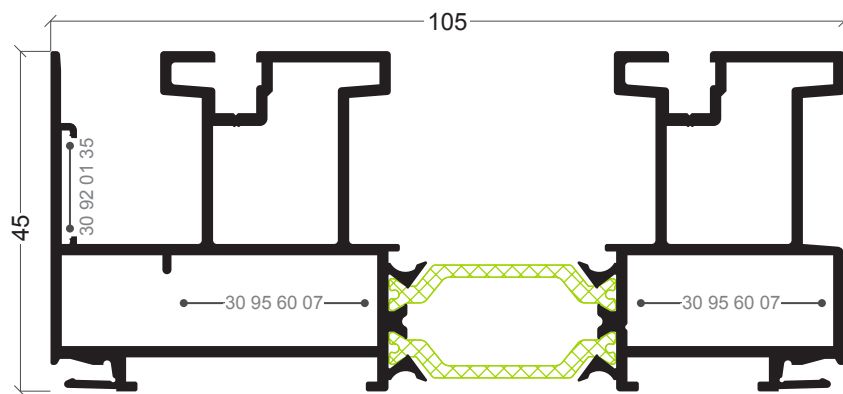

CW-05
Aro fixo perimetral

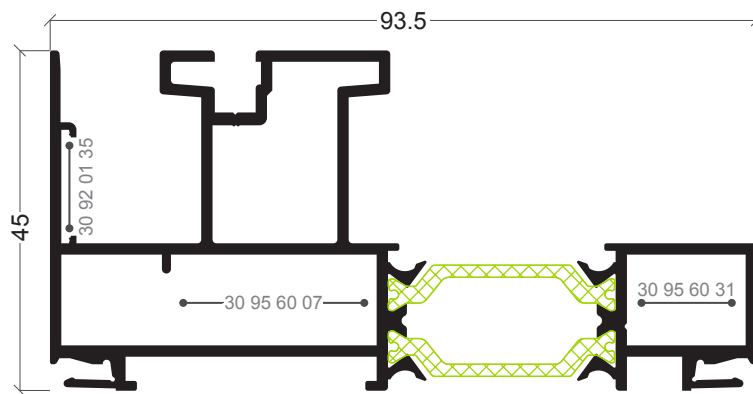

CW-07
Aro fixo mono-rail galandage

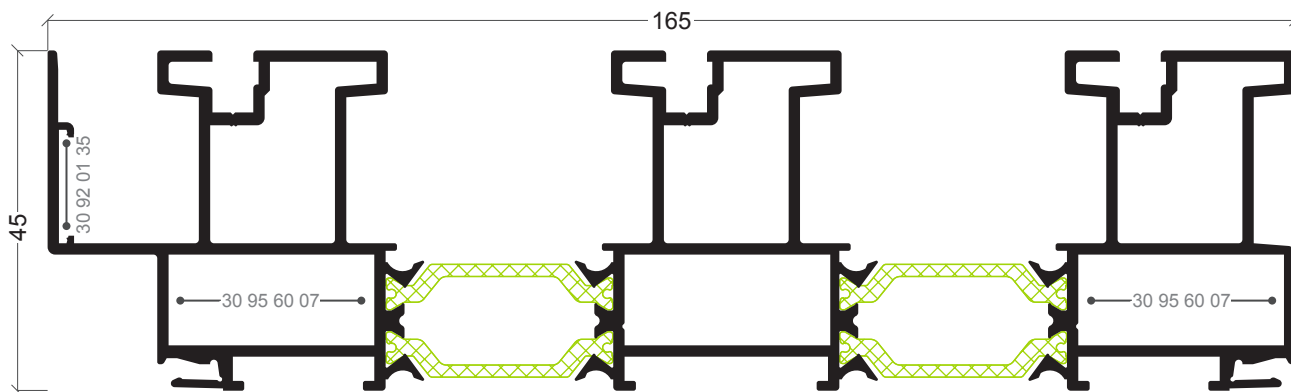

CW-08
Aro fixo tri-rail perimetral

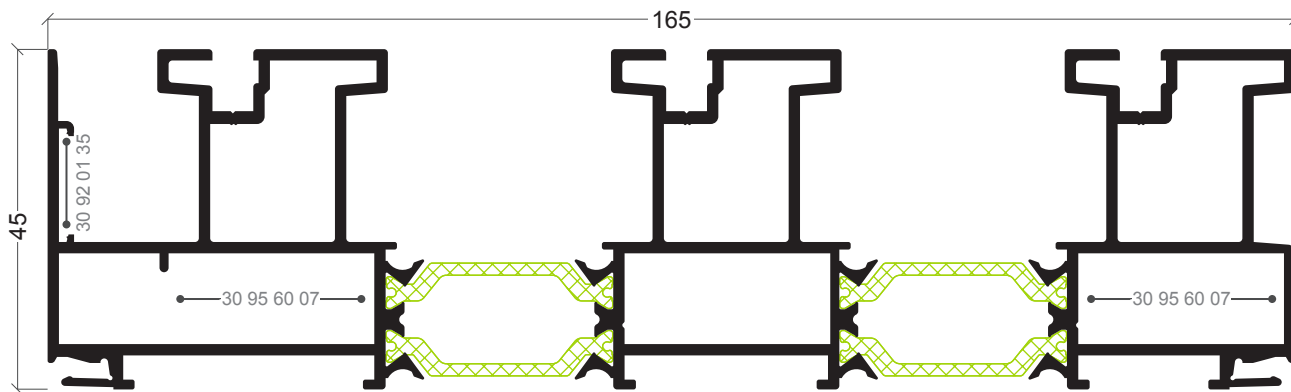

CW-09
Aro fixo tri-rail perimetral

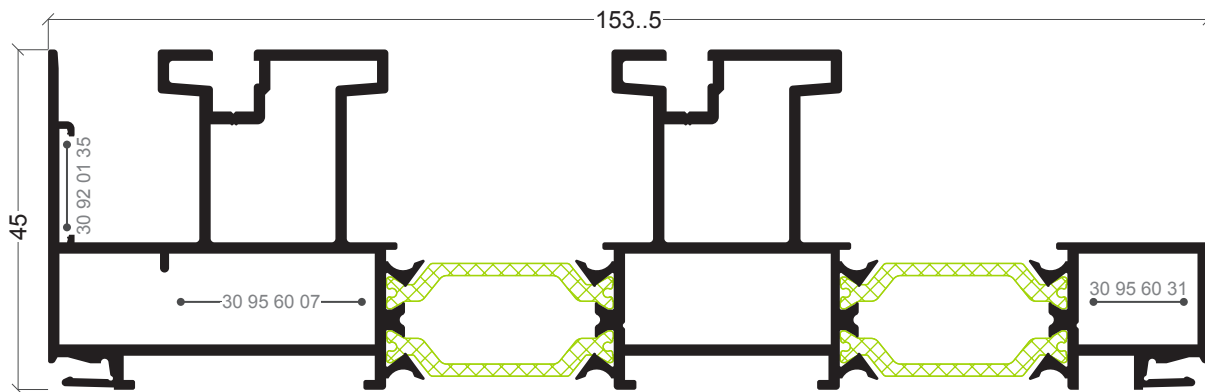

CW-10
Aro fixo bi-rail galandage

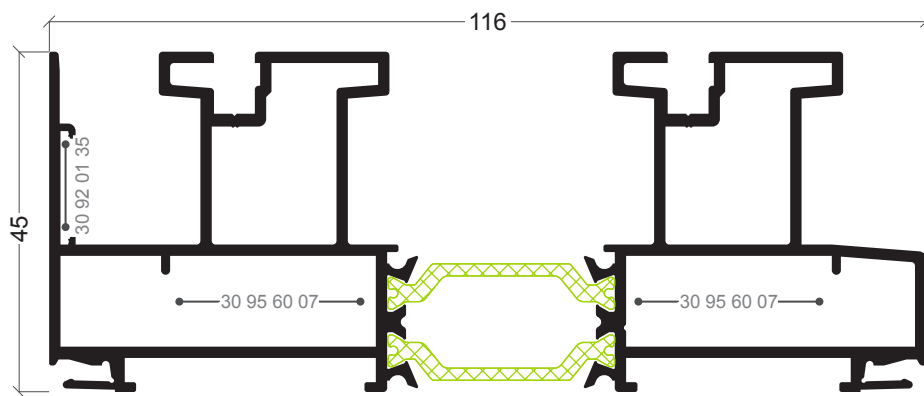

CW-20
Aro fixo bi-rail

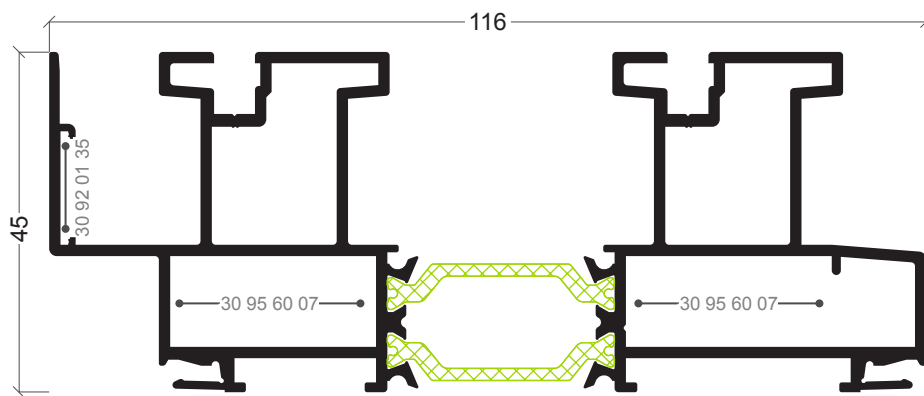

CW-21
Aro fixo bi-rail

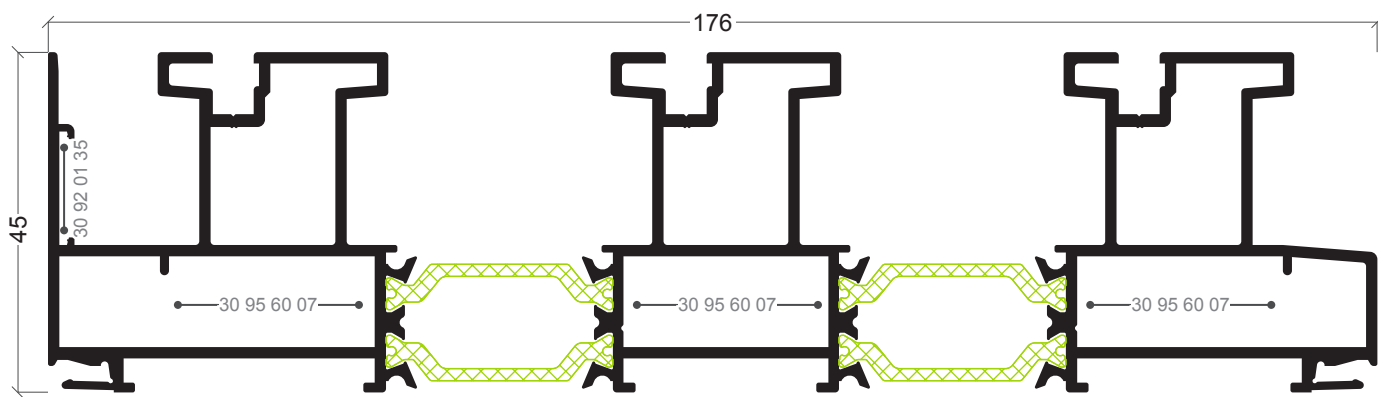

CW-22
Aro fixo tri-rail

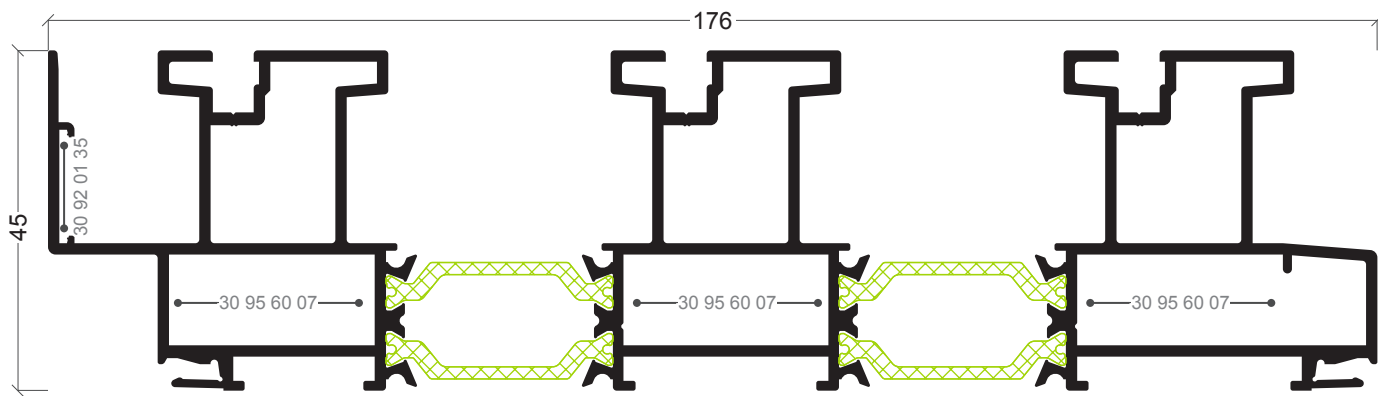

CW-23
Aro fixo tri-rail

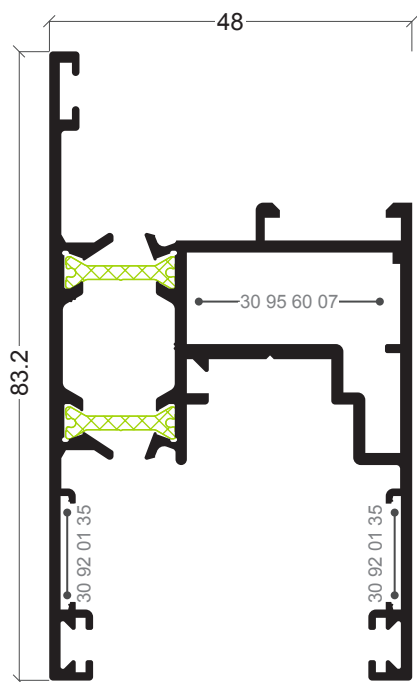

CW-02
Aro móvel perimetral

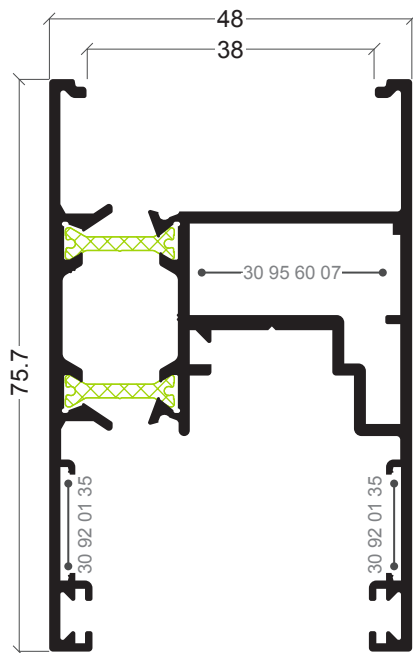

CW-03
Aro móvel perimetral

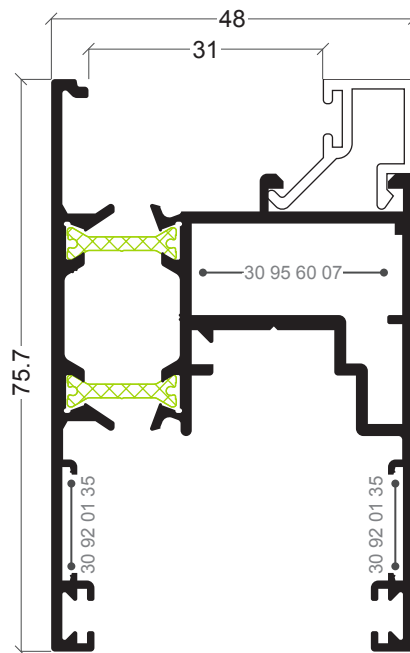

CW-04
Aro móvel perimetral

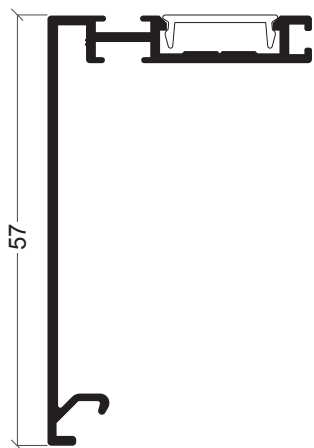

CW-06
Aro móvel perimetral

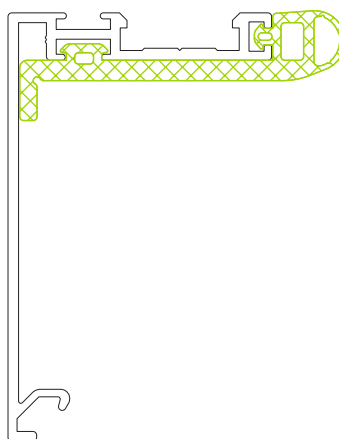

30 95 60 04
Junta central para CW-02

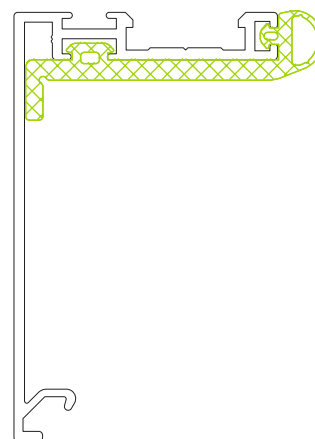

30 95 60 05
Junta central para CW-03/04



CW-15
Tampa

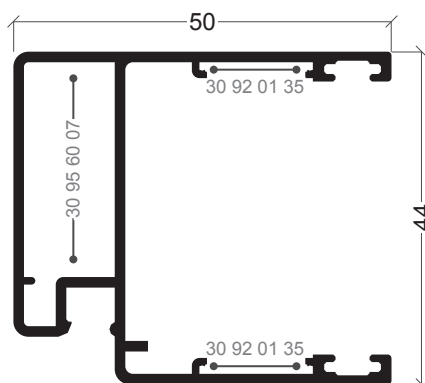

CW-14
Perfil para rede mosquiteira

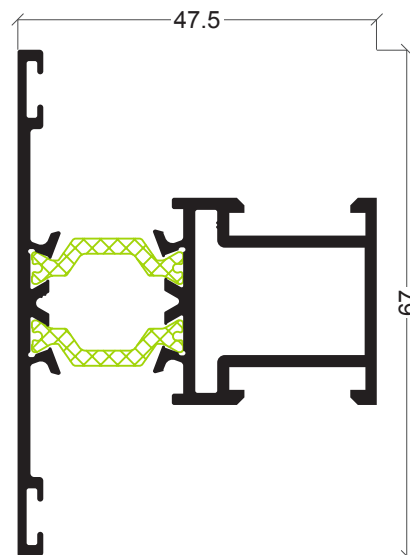

CW-16
Travessa

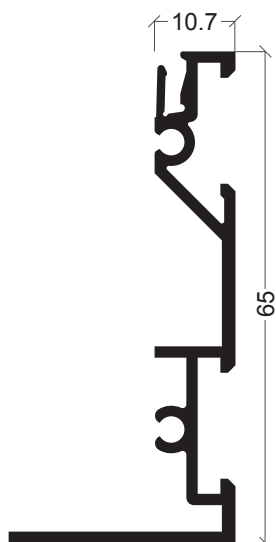

CW-11
Perfil para isolamento

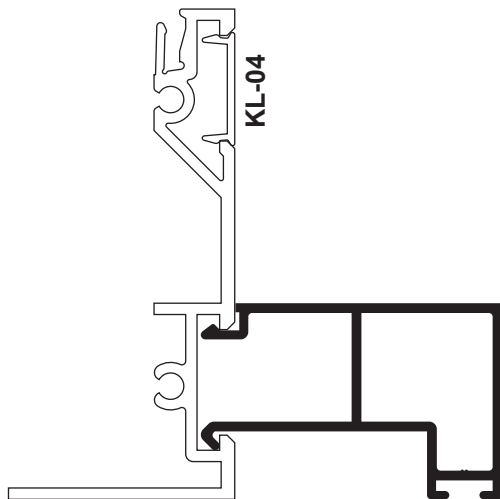

ARi-48
Bite

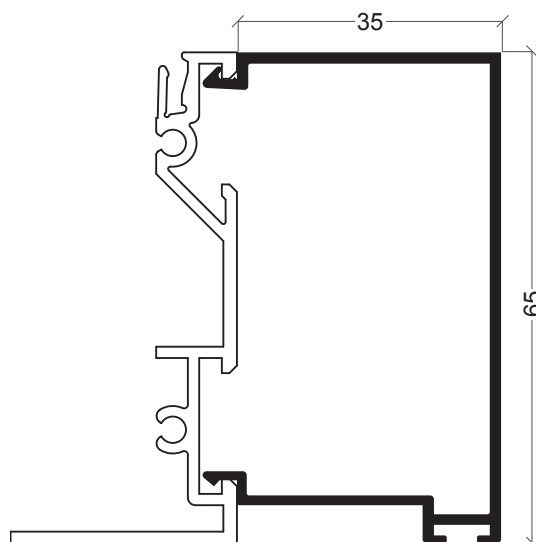

CW-12
Remate de isolamento

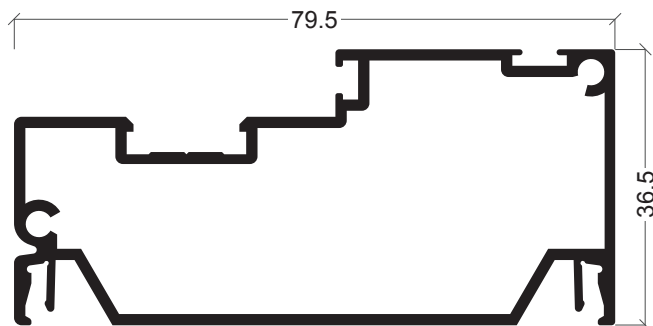

CW-13
Prumo de cruzamento

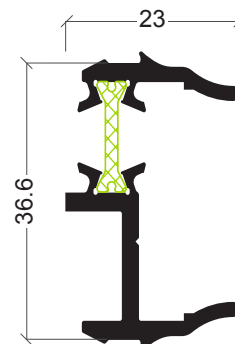

CTe-09
Perfil 4 folhas

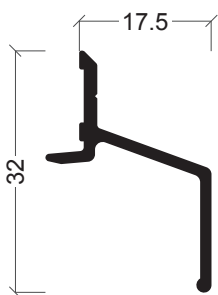

CT-29
Pingadeira superior

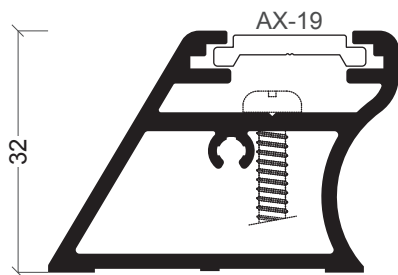

CT-28
Reforço

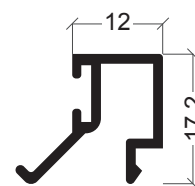

AX-70
Bite CW-04



CTe-03
Perfil guia



KL-04
Perfil complementar

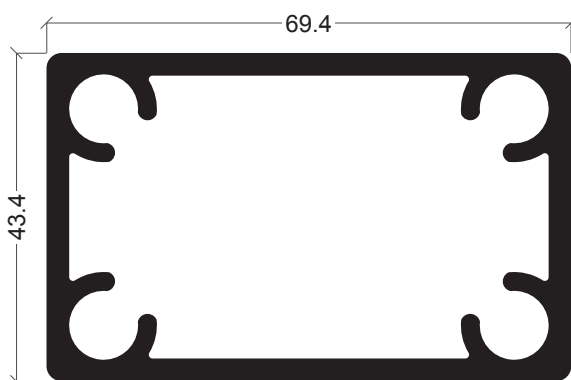

PO-07

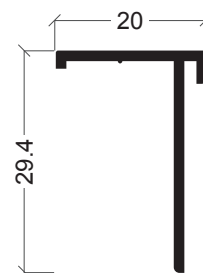

Y-24
Remate p/ apainelado

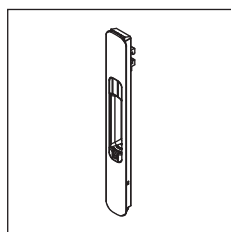

30 91 40 39/40/41
Fecho embutir manual
(natural/preto/branco)

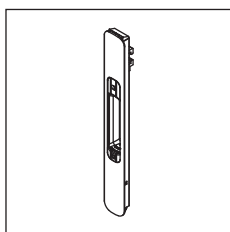

30 91 40 42/43/44
Fecho embutir automático
(natural/preto/branco)

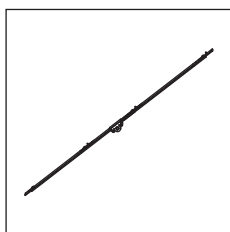

30 91 41 29
Barra multiponto 4
pontos (1800 mm)

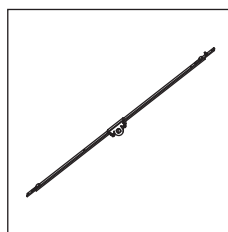

30 91 41 30
Barra multiponto 2
pontos (600 mm)

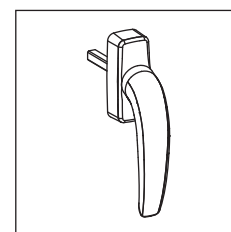

30 91 41 47/48
Cremone multi-ponto
(branco/preto)

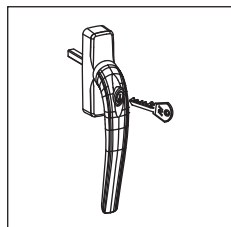

30 91 41 56/57
Cremone com chave multi-
ponto (branco/preto)

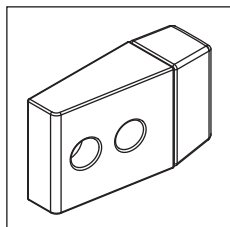

30 91 41 71
Topo limitador de
abertura

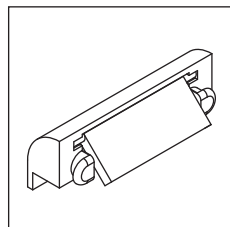

30 92 01 02/03
Goteira (preto/branco)

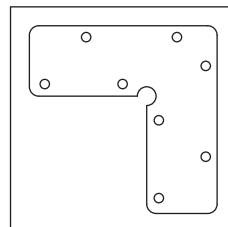

30 92 01 35
Esquadro de alinhamento
CW-01/02/03/04/05/08/09

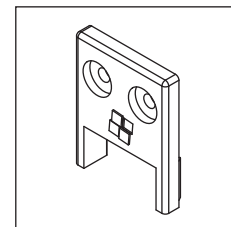

30 94 50 35
Tampa guia móvel recta
CW-06

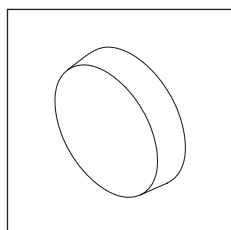

30 94 50 36
Tampa preta para parafuso
cabeça de queijo 9.3

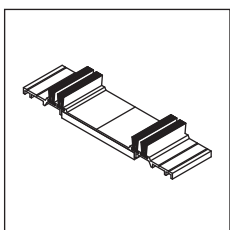

30 94 50 41
Cortavento superior
elevável

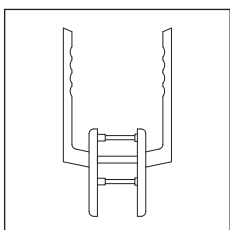

30 94 52 00/01/02
Puxador duplo para correr-
elevatória (natural/preto/inox)

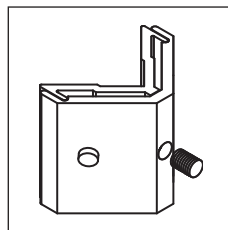

30 95 60 07
Esquadro 27x12 mm
centrado

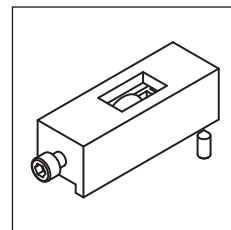

30 95 60 08
Rolamento simples regulável
CW (50 kg por rolamento)

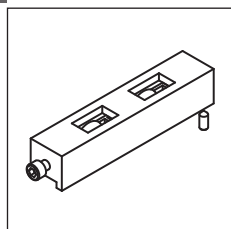

30 95 60 09
Rolamento duplo regulável
CW (100 kg por rolamento)

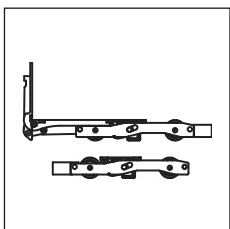

30 95 60 10
Conjunto rolamentos
elevável 200kg

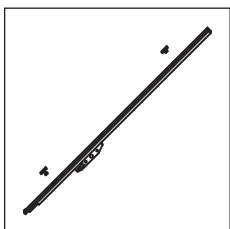

30 95 60 11
Ferragem correr/
elevatória 170

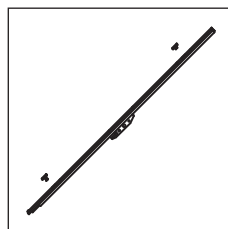

30 95 60 12
Ferragem correr/
elevatória 220

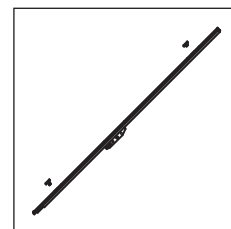

30 95 60 13
Ferragem correr/
elevatória 260

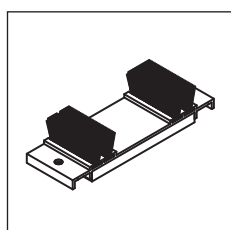

30 95 60 14
Corta-vento inferior/
superior

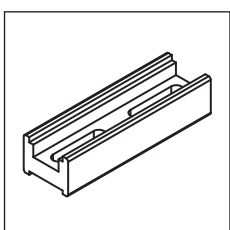

30 95 60 15
Calço multi-ponto nº 4

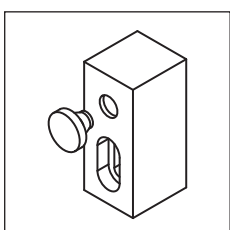

30 95 60 16
Batente lateral

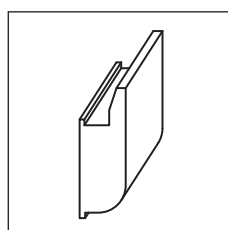

30 95 60 17
Guia

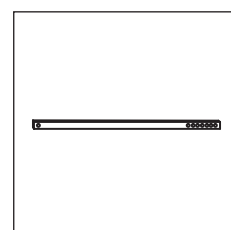

30 95 60 18
Barra de ligação 150

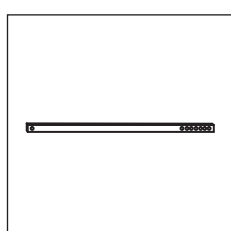

30 95 60 19
Barra de ligação 200

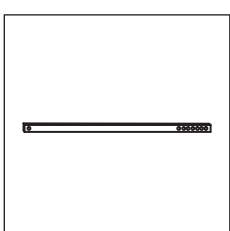

30 95 60 20
Barra de ligação 250

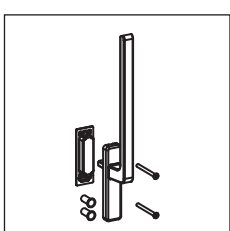

30 95 60 21/22/23/24/25
Conjunto puxador elevável
(natural/preto/branco/inox/bronze)

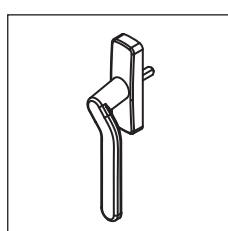

30 95 60 26/28
Puxador desviado M-P
direito branco/preto

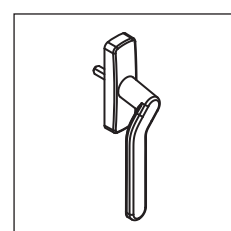

30 95 60 27/29
Puxador desviado M-P
esquerdo branco/preto

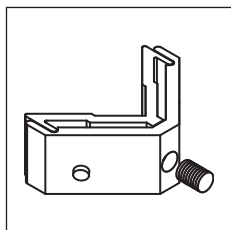

30 95 60 31

Esquadro 15x12 mm exterior

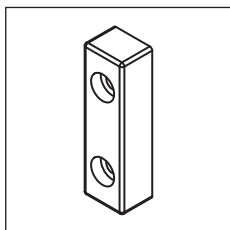

30 95 60 34

Calço 3/4 folhas

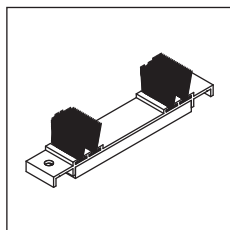

30 95 60 35

Corta-vento inferior/superior mono-rail

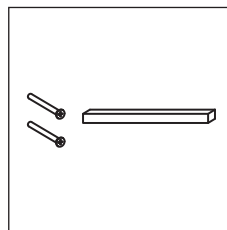

30 95 60 36

Conjunto perno + parafuso para puxador multiponto desviado duplo

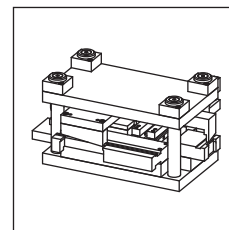

33 92 29 99







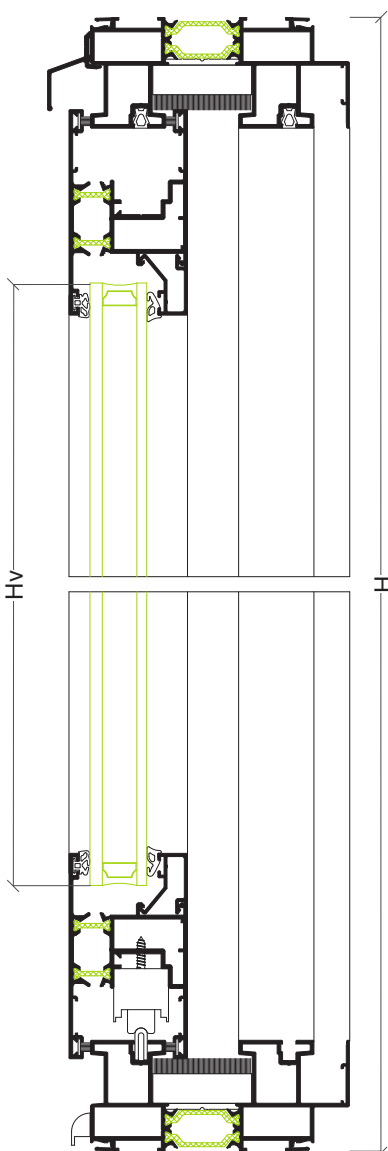
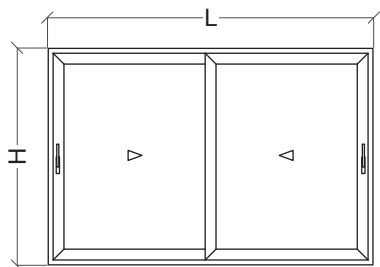



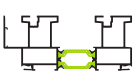

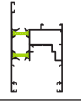



Cunho

Referência	Desenho	Descrição
30 20 26 03		Junta interior/exterior
30 93 00 60		Vedante exterior do vidro
30 93 00 61		Junta vedação exterior vidro 2 mm
30 93 00 62		Junta plana para vidro
30 93 00 65		Junta interior para vidro (5 mm)
30 93 00 66		Junta interior para vidro (4 mm)
30 93 00 67		Junta interior para vidro (2 mm)
30 93 00 68		Junta interior para vidro (6/7 mm)
30 93 00 69		Junta interior para vidro (8/9 mm)
30 94 01 46		Junta para CW-13
30 94 60 12		Pelúcia tri-fin
30 95 00 10		Pelúcia 7x9 mm
30 95 00 40		Pelúcia 7x5.5 mm
30 95 60 01		Junta tapa-canal central
30 95 60 02		Junta tapa-canal aro fixo
30 95 60 03		Junta vedação aro móvel
30 95 60 04		Junta central CW-02
30 95 60 05		Junta central CW-03/04
30 95 60 06		Junta em U para vidro de 30 mm
30 95 60 30		Junta isolante CW

Janela 2 folhas correr



Perfis

Desenho	Ref	Descrição	Corte	Quant	Medida
	CW-01	Aro fixo perimetral		2	L
				2	H
	CW-02	Aro móvel perimetral		4	L/2+2 mm
				4	H-75 mm
	CW-06	Tampa de cruzamento		2	H-75 mm
	CTe-03	Perfil guia		2	L-74 mm
	CT-29	Pingadeira		1	L
	KL-04	Perfil tampa central		2	H-75 mm
	---	Bite horizontal		4	L/2-124.5 mm
	---	Bite vertical		4	H-241.5 mm

Acessórios e Juntas

Referência	Descrição	Quantidade
30 95 60 07	Esquadro	16
30 92 01 35	Esquadro de alinhamento	20
30 95 60 14	Corta-vento inferior/superior	2
30 95 60 16	Batente lateral	4
30 94 50 35	Tampa guia	4
30 92 01 02	Goteira com válvula (preto)	diversas
30 91 40 43	Fecho lateral automático (preto)	2
30 95 60 09	Rolamento duplo regulável	4
30 95 00 40	Pelúcia 7x5.5 mm fin-seal	4L+2H
30 95 60 01	Junta tapa-canal central	2L+2H
30 95 60 02	Junta tapa-canal	2L+4H
30 95 60 03	Junta de vedação	4H
30 95 60 04	Junta central CW-02	2H
---	Junta exterior para vidro	2L+4H
---	Junta interior para vidro	2L+4H

Vidro

Hv = H-215 mm	Lv = L/2-138 mm
---------------	-----------------

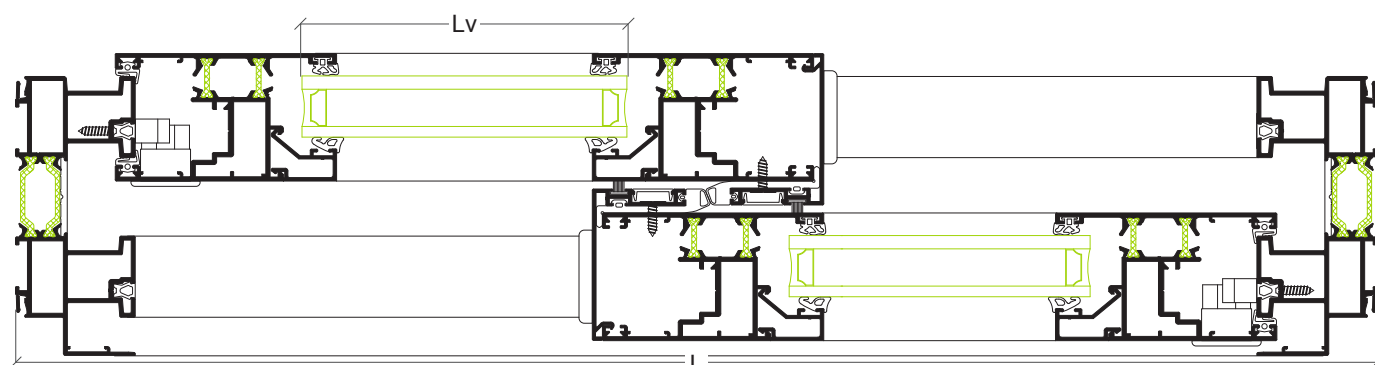

Porta 1 folha galandage

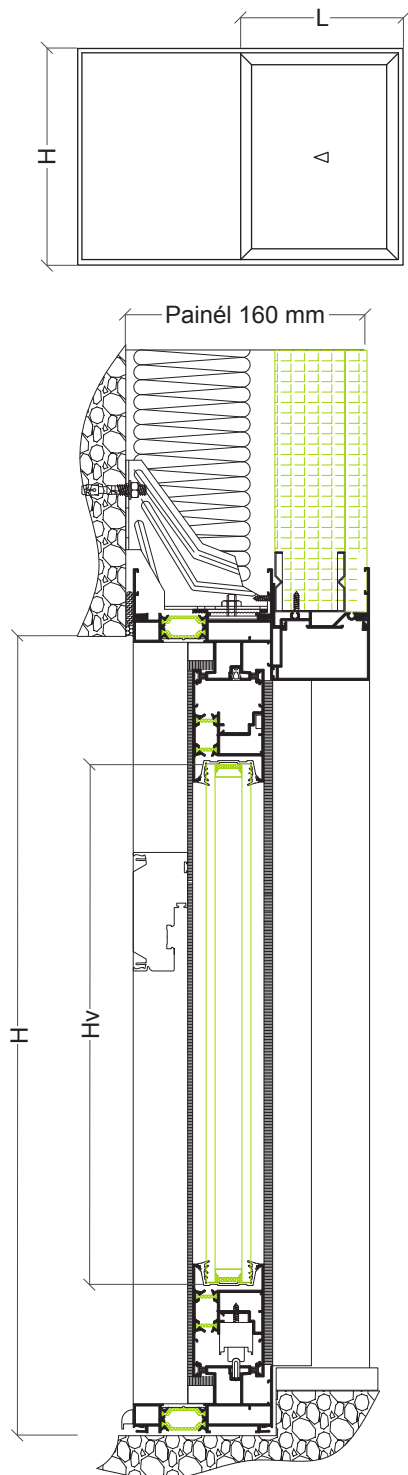

Perfis

Desenho	Ref	Descrição	Corte	Quant	Medida
	CW-07	Aro fixo perimetral		2	(Lx2)+112 mm
				2	H+15 mm
	CW-03	Aro móvel perimetral		2	L+52 mm
				2	H-60 mm
	CW-06	Tampa de cruzamento		1	H-60 mm
	CW-11	Perfil para isolamento		1	L+167 mm
				2	H-39 mm
	CW-12	Remate de isolamento		1	L+106 mm
				2	L+106 mm
	CW-13	Prumo de cruzamento		1	H-24 mm
	CTe-03	Perfil guia		1	(Lx2)+38 mm
	KL-04	Perfil tampa central		1	H-24 mm
				1	H-60 mm
	AXi-88	Remate lateral de isolamento exterior		1	(Lx2)+126 mm
				2	H+45 mm
	AXi-88	Remate lateral de isolamento interior		1	L+188 mm
				2	H+1.5 mm

Acessórios e Juntas

Referência	Descrição	Quantidade
30 95 60 07	Esquadro	8
30 95 60 31	Esquadro exterior	4
30 92 01 35	Esquadro alinhamento	24
30 95 60 35	Corta-vento inferior/superior mono-rail	2
30 95 60 16	Batente lateral	2
30 94 50 35	Tampa guia	2
30 92 01 02	Goteira com válvula (preto)	diversas
30 91 41 48	Puxador preto	1
30 95 60 09	Rolamento duplo regulável	2
30 91 41 30	Ferragem multi-ponto 600 mm	2
30 95 60 15	Calço MP nº 4	4
30 95 00 40	Pelúcia 7x5.5 mm fin-seal	4L+2H
30 95 60 01	Junta tapa-canal central	4L+2H
30 95 60 02	Junta tapa-canal	4L+4H
30 95 60 03	Junta de vedação	2H
30 95 60 05	Junta central CW-03/04	H
30 59 60 06	Junta para vidro (30 mm)	2L+2H
30 94 01 46	Junta para CW-13	H
30 95 00 10	Pelúcia 7x9 mm	H
30 94 01 46	Junta para CW-13	H

3 1 7

Vidro



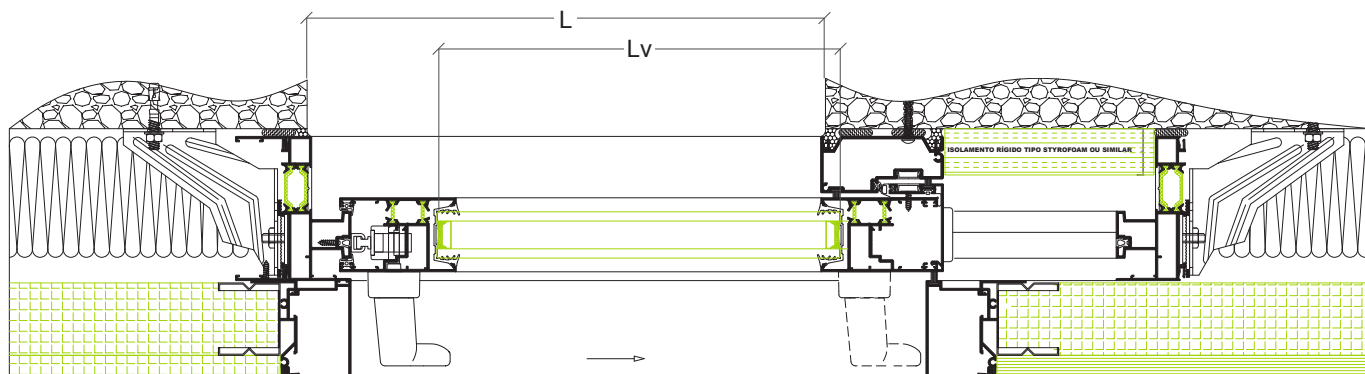



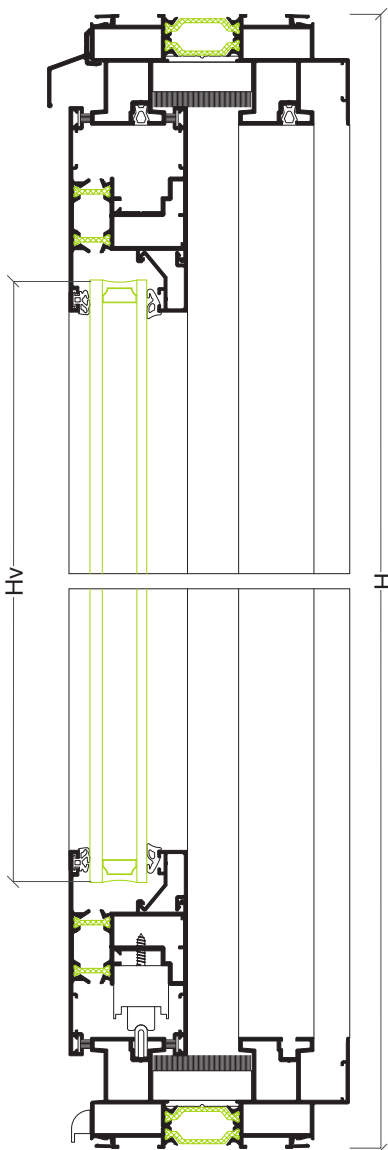
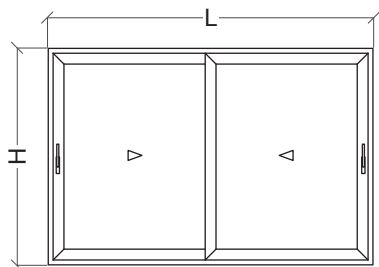



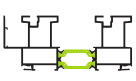

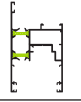



Hv = H-186 mm	Lv = L-75 mm
---------------	--------------



Porta 2 folhas correr



Perfis

Desenho	Ref	Descrição	Corte	Quant	Medida
	CW-01	Aro fixo perimetral		2	L
				2	H
	CW-02	Aro móvel perimetral		4	L/2+2 mm
				4	H-75 mm
	CW-06	Tampa de cruzamento		2	H-75 mm
	CTe-03	Perfil guia		2	L-74 mm
	CT-29	Pingadeira		1	L
	KL-04	Perfil tampa central		2	H-75 mm
	---	Bite horizontal		4	L/2-124.5 mm
	---	Bite vertical		4	H-241.5 mm

Acessórios e Juntas

Referência	Descrição	Quantidade
30 95 60 07	Esquadro	16
30 92 01 35	Esquadro de alinhamento	20
30 95 60 14	Corta-vento inferior/superior	2
30 95 60 16	Batente lateral	4
30 94 50 35	Tampa guia	4
30 92 01 02	Goteira com válvula (preto)	diversas
30 95 60 29	Puxador desviado esquerdo (preto)	1
30 95 60 28	Puxador desviado direito (preto)	1
30 91 41 30	Ferragem multi-ponto 600 mm	2
30 95 60 15	Calço MP nº 4	8
30 91 41 71	Limitador	1
30 95 60 09	Rolamento duplo regulável	4
30 95 00 40	Pelúcia 7x5.5 mm fin-seal	4L+2H
30 95 60 01	Junta tapa-canal central	2L+2H
30 95 60 02	Junta tapa-canal	2L+4H
30 95 60 03	Junta de vedação	4H
30 95 60 04	Junta central CW-02	2H
---	Junta exterior para vidro	2L+4H
---	Junta interior para vidro	2L+4H

Vidro



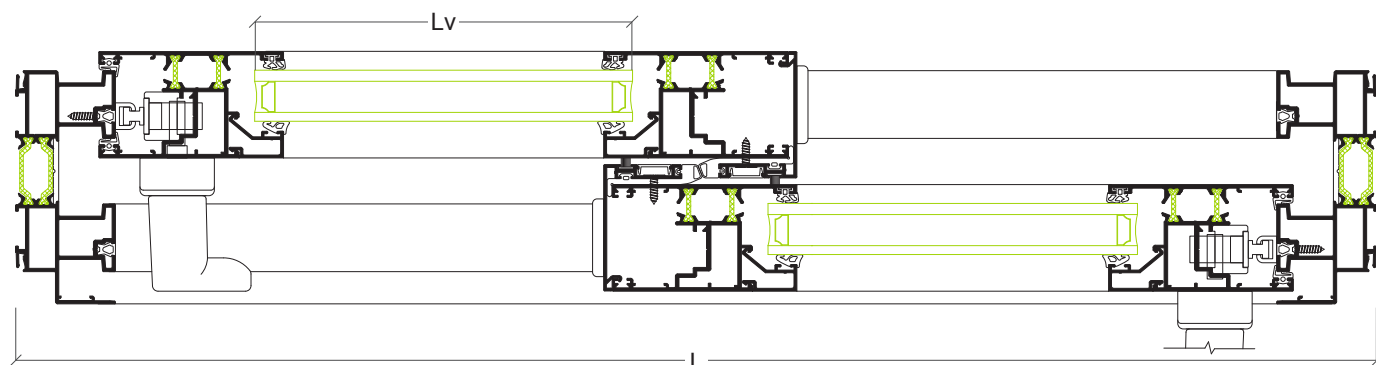



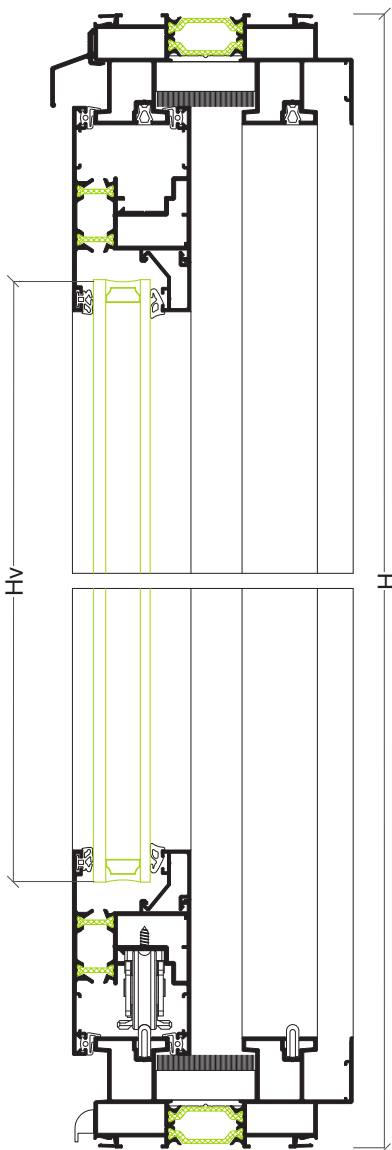
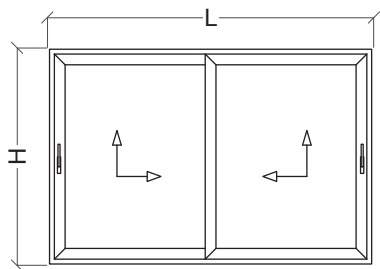



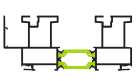

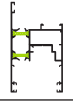



Hv = H-215 mm	Lv = L/2-138 mm
---------------	-----------------



Porta 2 folhas correr elevável



Perfis

Desenho	Ref	Descrição	Corte	Quant	Medida
	CW-01	Aro fixo perimetral		2	L
				2	H
	CW-02	Aro móvel perimetral		4	L/2+2 mm
				4	H-75 mm
	CW-06	Tampa de cruzamento		2	H-75 mm
	CTe-03	Perfil guia		2	L-74 mm
	CT-29	Pingadeira		1	L
	KL-04	Perfil tampa central		2	H-75 mm
	---	Bite horizontal		4	L/2-124.5 mm
	---	Bite vertical		4	H-241.5 mm

Acessórios e Juntas

Referência	Descrição	Quantidade
30 95 60 07	Esquadro	16
30 92 01 35	Esquadro de alinhamento	20
30 95 60 14	Corta-vento inferior	1
30 94 50 41	Corta-vento superior (elevável)	1
30 94 50 35	Tampa guia	4
30 92 01 02	Goteira com válvula (preto)	diversas
30 95 60 XX	Ferragem correr/elevatória	2
30 95 60 10	Conjunto rolamentos elevável	2
30 95 60 XX	Conjunto puxador elevável	2
30 95 60 XX	Barra de ligação	2
30 91 41 71	Limitador	1
30 95 00 40	Pelúcia 7x5.5 mm fin-seal	2H
30 95 60 01	Junta tapa-canal central	2L+2H
30 95 60 02	Junta tapa-canal	2L+4H
30 95 60 03	Junta de vedação	4L+4H
30 95 60 04	Junta central CW-02	2H
---	Junta exterior para vidro	2L+4H
---	Junta interior para vidro	2L+4H

3 1 9

Vidro



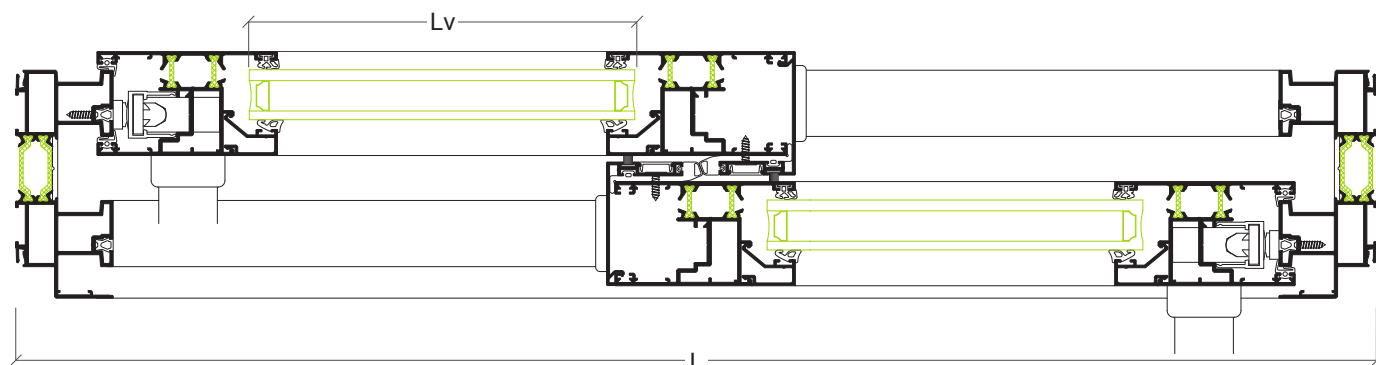



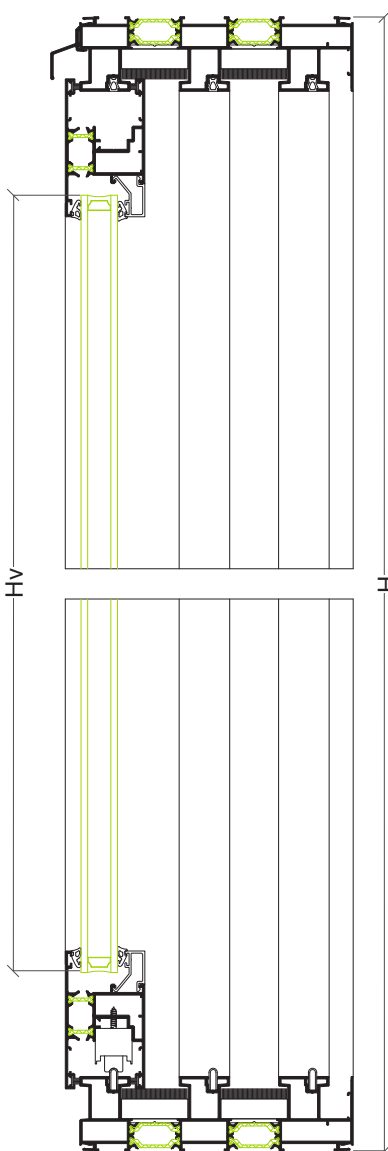
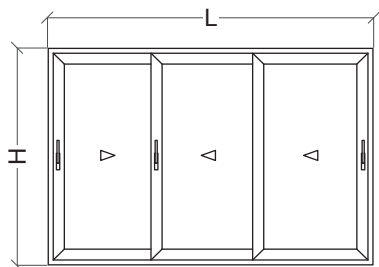











Hv = H-215 mm	Lv = L/2-138 mm
---------------	-----------------



Porta 3 folhas correr tri-rail



Perfis

Desenho	Ref	Descrição	Corte	Quant	Medida
	CW-09	Aro fixo tri-rail perimetral		2	L
				2	H
	CW-02	Aro móvel perimetral		6	L/3+28 mm
				6	H-75 mm
	CW-06	Tampa de cruzamento		4	H-75 mm
	CTe-03	Perfil guia		3	L-74 mm
	CT-29	Pingadeira		1	L
	KL-04	Perfil tampa central		4	H-75 mm
	---	Bite horizontal		6	L/3-98.5 mm
	---	Bite vertical		6	H-241.5 mm

Acessórios e Juntas

Referência	Descrição	Quantidade
30 95 60 07	Esquadro	20
30 92 01 35	Esquadro de alinhamento	28
30 95 60 14	Corta-vento inferior/superior	4
30 95 60 16	Batente lateral	4
30 94 50 35	Tampa guia	8
30 92 01 02	Goteira com válvula (preto)	diversas
30 95 60 29	Puxador desviado esquerdo (preto)	1
30 95 60 28	Puxador desviado direito (preto)	1
30 91 41 30	Ferragem multiponto 600 mm	2
30 95 60 15	Calço MP nº 4	8
30 91 41 71	Limitador	2
30 95 60 09	Rolamento duplo regulável	6
30 95 00 40	Pelúcia 7x5.5 mm fin-seal	4H+4L
30 95 60 01	Junta tapa-canal central	4L+4H
30 95 60 02	Junta tapa-canal	3L+6H
30 95 60 03	Junta de vedação	4H
30 95 60 04	Junta central CW-02	4H
---	Junta exterior para vidro	2L+6H
---	Junta interior para vidro	2L+6H

Vidro



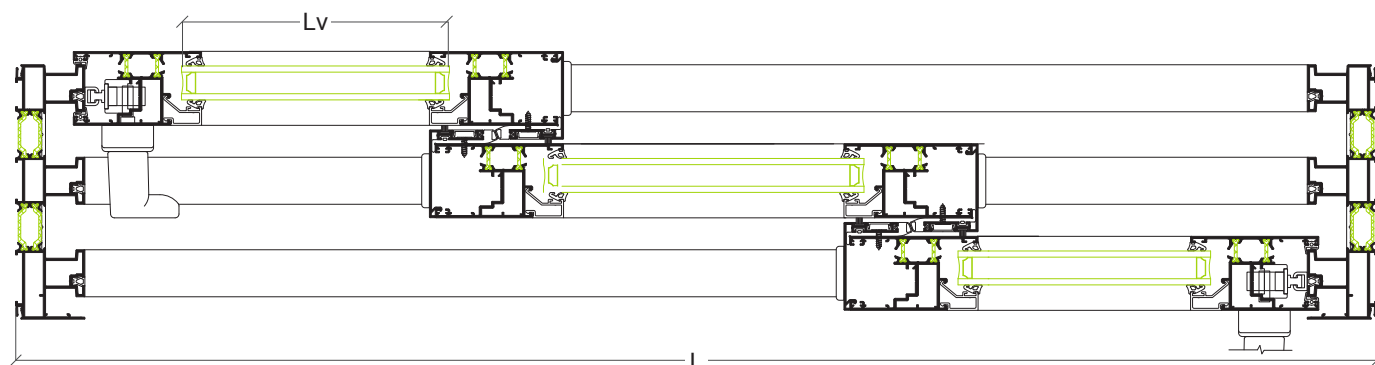



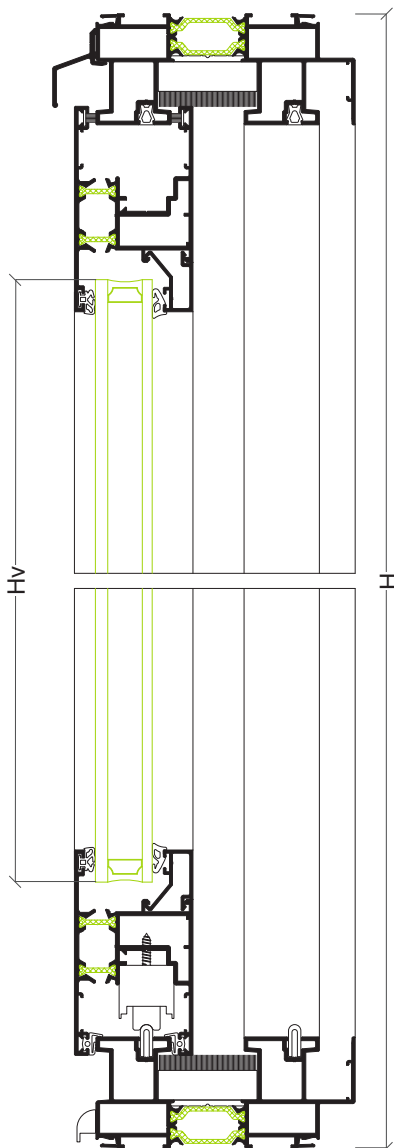
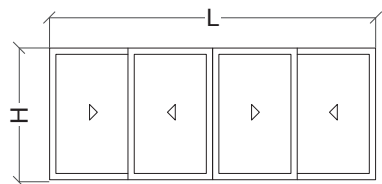

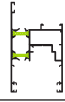

Hv = H-215 mm	Lv = L/3-113 mm
---------------	-----------------



Porta 4 folhas correr



Perfis

Desenho	Ref	Descrição	Corte	Quant	Medida
	CW-01	Aro fixo perimetral		2	L
				2	H
	CW-02	Aro móvel perimetral		8	L/4+20 mm
				8	H-75 mm
	CW-06	Tampa de cruzamento		4	H-75 mm
	CTe-03	Perfil guia		2	L-74 mm
	CT-29	Pingadeira		1	L
	KL-04	Perfil tampa central		4	H-75 mm
	CTe-09	Perfil 4 folhas		1	H-75 mm
	---	Bite horizontal		8	L/4-107 mm
	---	Bite vertical		8	H-241.5 mm

Acessórios e Juntas

Referência	Descrição	Quantidade
30 95 60 07	Esquadro	24
30 92 01 35	Esquadro de alinhamento	36
30 95 60 14	Corta-vento inferior/superior	6
30 95 60 16	Batente lateral	6
30 95 60 34	Calço 3-4 folhas	4
30 94 50 35	Tampa guia	8
30 92 01 02	Goteira com válvula (preto)	diversas
30 95 60 29	Puxador desviado esquerdo (preto)	1
30 95 60 28	Puxador desviado direito (preto)	2
30 91 41 30	Ferragem multiponto 600 mm	3
30 95 60 15	Calço MP nº 4	12
30 91 41 71	Limitador	2
30 95 60 09	Rolamento duplo regulável	8
30 95 00 40	Pelúcia 7x5.5 mm fin-seal	4L+6H
30 95 60 01	Junta tapa-canal central	2L+2H
30 95 60 02	Junta tapa-canal	2L+4H
30 95 60 03	Junta de vedação	4H
30 95 60 04	Junta central CW-02	4H
---	Junta exterior para vidro	2L+8H
---	Junta interior para vidro	2L+8H

Vidro

Hv = H-215 mm	Lv = L/4 - 120 mm
---------------	-------------------

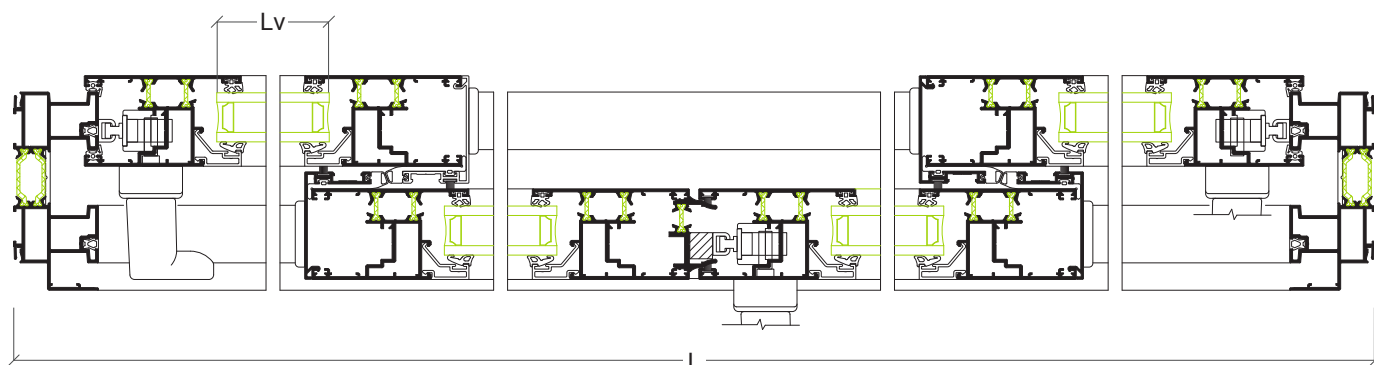



Sistema
CTe

Sistema CTe

Sistema de correr-elevável com RPT - 125 mm

Características do sistema

Sistema de alumínio com rotura térmica para executar vãos de correr eleváveis.

Perfis de alumínio

Os perfis de alumínio são extrudidos na liga de alumínio 6060 para arquitetura de acordo com norma NP EN 12020-02.

Perfis com rotura térmica obtida por inserção de varetas isolantes de poliamida de 6.6 mm reforçadas com 25% de fibra de vidro de 24 mm ou 30 mm nos aros fixos e de 14.6 mm nos aros móveis.

Espessura média dos perfis de alumínio de 2 mm.

Aros fixos

Secção dos aros fixos de 2 guias de 127.4 mm para montagem em corte recto;

Secção dos aros fixos de 3 guias (tri-rail) de 189.4 mm para montagem em corte recto;

Secção do aro fixo perimetral de 2 guias de 123 mm para montagem a meia esquadria;

Secção do aro fixo perimetral de 3 guias (tri-rail) de 185 mm para montagem a meia esquadria;

Perfil guia de deslizamento inferior em aço inoxidável AISI 304 para evitar desgaste das peças.

Aros móveis

Secção dos aros móveis perimetrais de 50.6 mm com montagem a meia esquadria;

Enchimento de 4 a 38 mm;

Aros móveis de linha recta ou curva;

Bites rectos ou curvos;

Estanquidade assegurada através de juntas em EPDM e pelúcia tipo Fin-Seal.

Dimensionamento e manobralidade

Dimensões mínimas - máximas de folha: 720 mm - 3350 mm (L); 1190 mm - 2690 mm (H) com opção de 3325 mm com prolongador;

Peso máximo de 300 kg por folha com a ferragem base, com opção de 400 kg por folha com kit suplementar;

Tipologias de 2, 3, 4 e 6 folhas móveis e/ou fixas;

Sistema de correr elevável com funcionamento baseado numa ferragem montada em conjunto nas folhas e que permite a elevação destas aquando da sua abertura, mesmo com configurações extremas de peso ou dimensão. Quando fechada a folha comprime as juntas em EPDM permitindo uma estanquidade perimetral perfeita;

Ferragem base com 2 pontos de fecho e possibilidade de adicionar mais 1 ou 2 pontos suplementares;

Ferragem base com micro ventilação;

Ferragem constituída por carrinhos de 4 rodas em pvc reforçadas com fibra de vidro e rolamentos de agulha de alta prestação;

Puxador específico para facilitar as manobra de abertura e fecho do vão;

Existe a opção de puxador duplo com colocação de canhão com chave para permitir a abertura pelo exterior.

Performances

Sistema certificado por laboratório notificado para Ensaio Tipo Inicial (ITT) de acordo com a norma de produto EN 14351-1 para efeitos de Marcação CE.

Categorias alcançadas na avaliação do sistema CTe:

1. Permeabilidade ao ar: Classe 3 (norma de ensaio EN 1026)
2. Estanquidade à água: Classe 7A (norma de ensaio EN 1027)
3. Resistência ao vento: Classe C2 (norma de ensaio EN 12211)

Coefficiente de transmissão térmica de vão de 2 folhas com 5.0 m x 2.5 m com vidro $U_g = 0.7 \text{ W/m}^2\text{K}$, com intercalar efeito "Warm Edge":

• $U_w = 1.37 \text{ W/m}^2\text{K}$

Coefficiente de atenuação acústica de vão de 2 folhas com vidro acústico 6/16/44.1:

• $R_w (C; C_{tr}) = 41 \text{ dB} (-1; -5)$

Zonas de aplicação segundo RCCTE (em função do valor U_g): I1, I2, I3, V1, V2, V3.

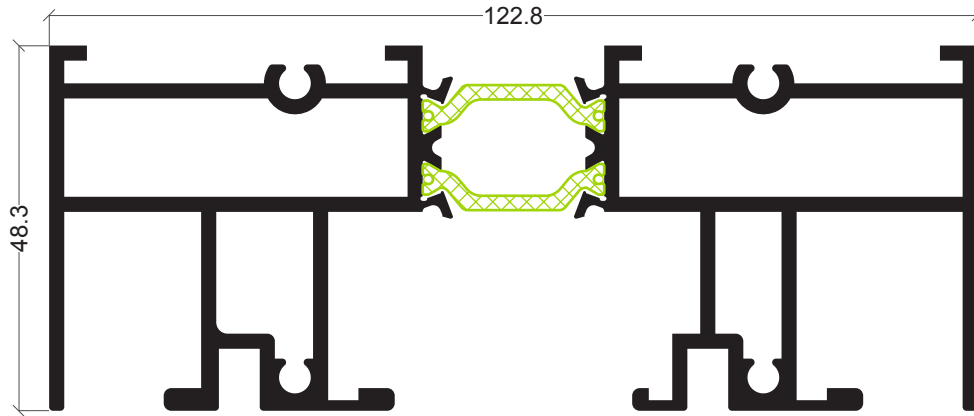

CTe-05
Padieira

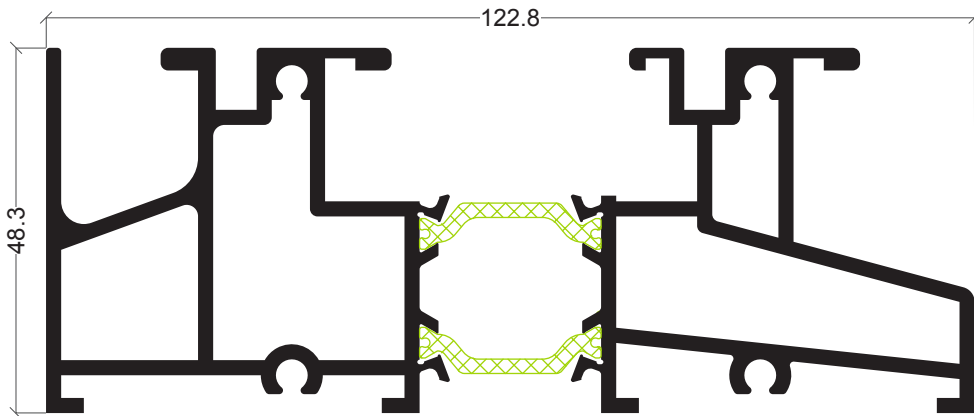

CTe-01
Soleira

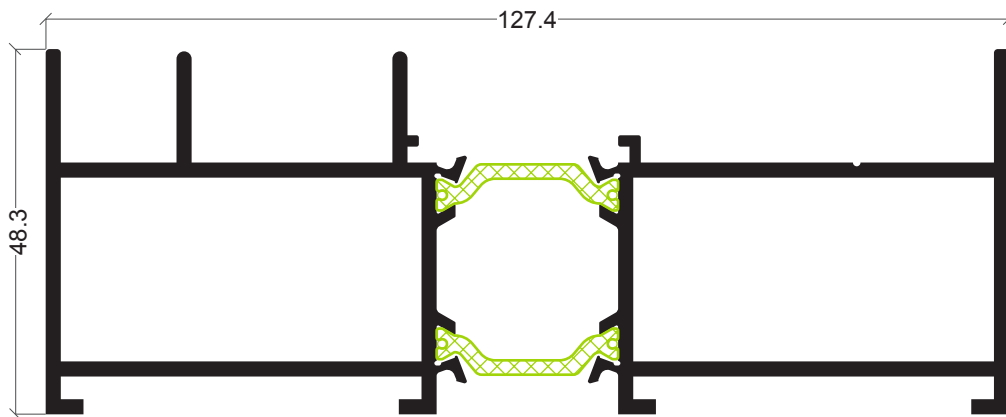

CTe-08
Ombreira

326

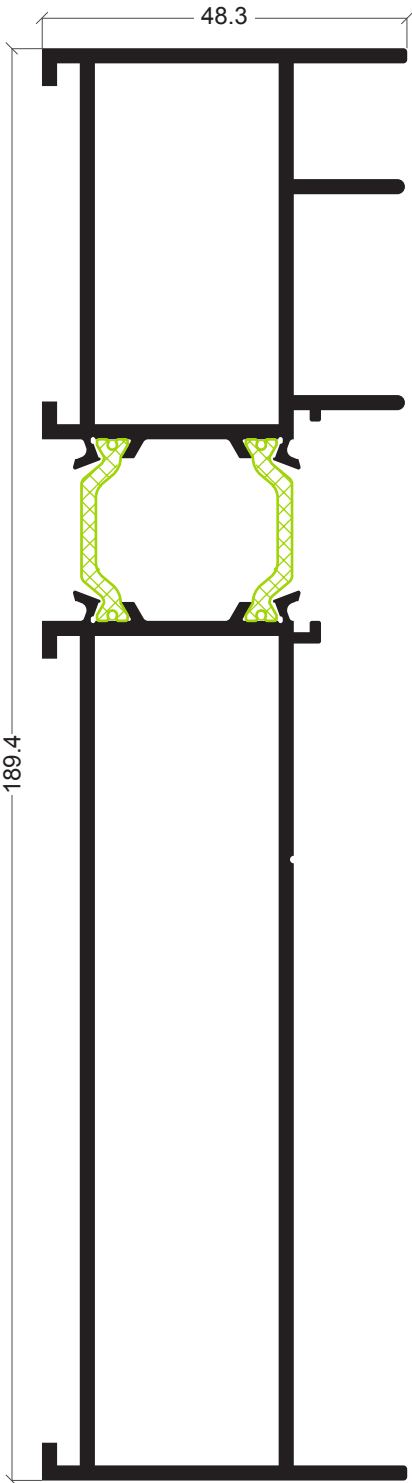

CTe-12
Ombreira tri-rail

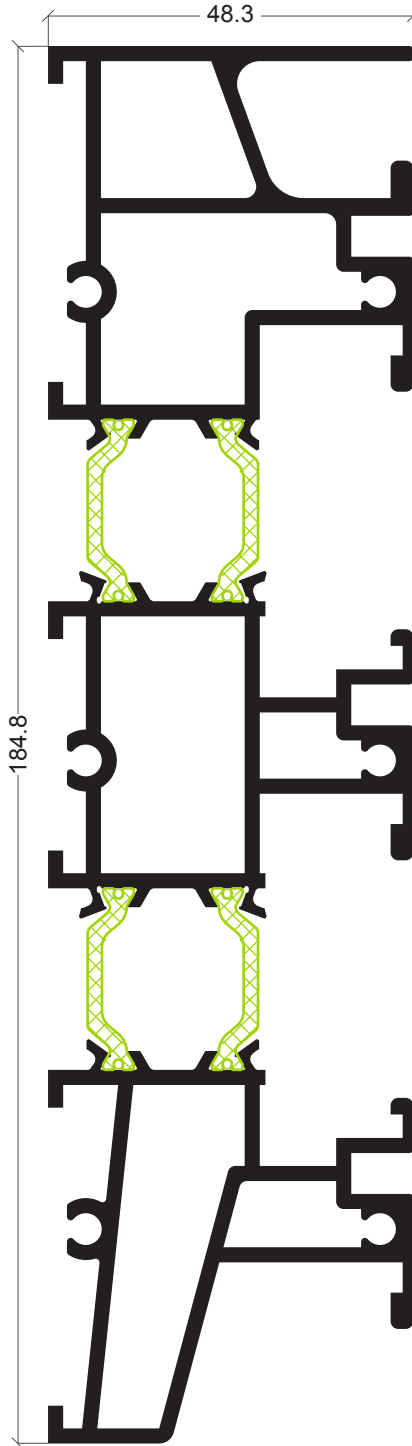

CTe-13
Soleira tri-rail

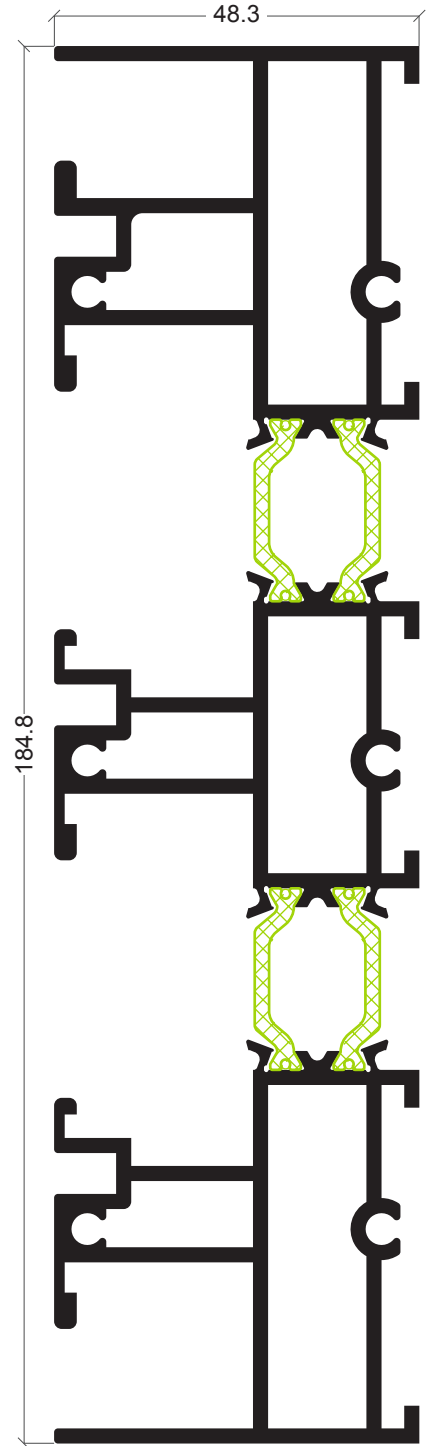

CTe-11
Padieira tri-rail

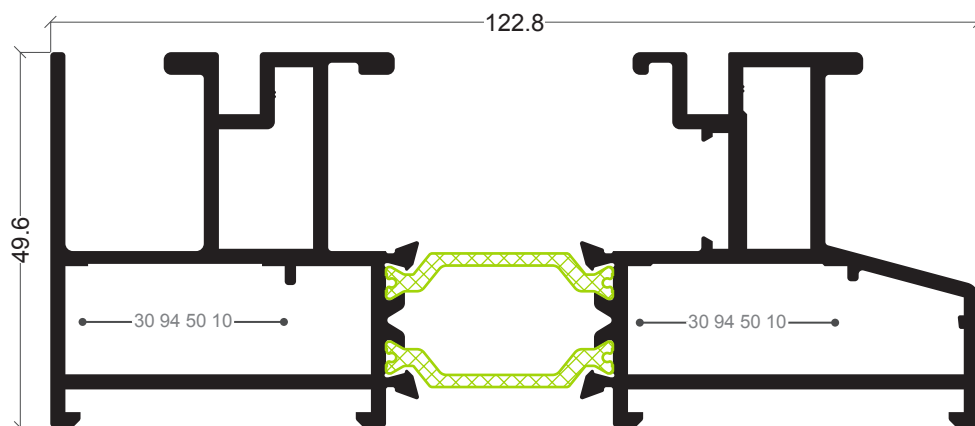

CTe-14
Soleira bi-rail

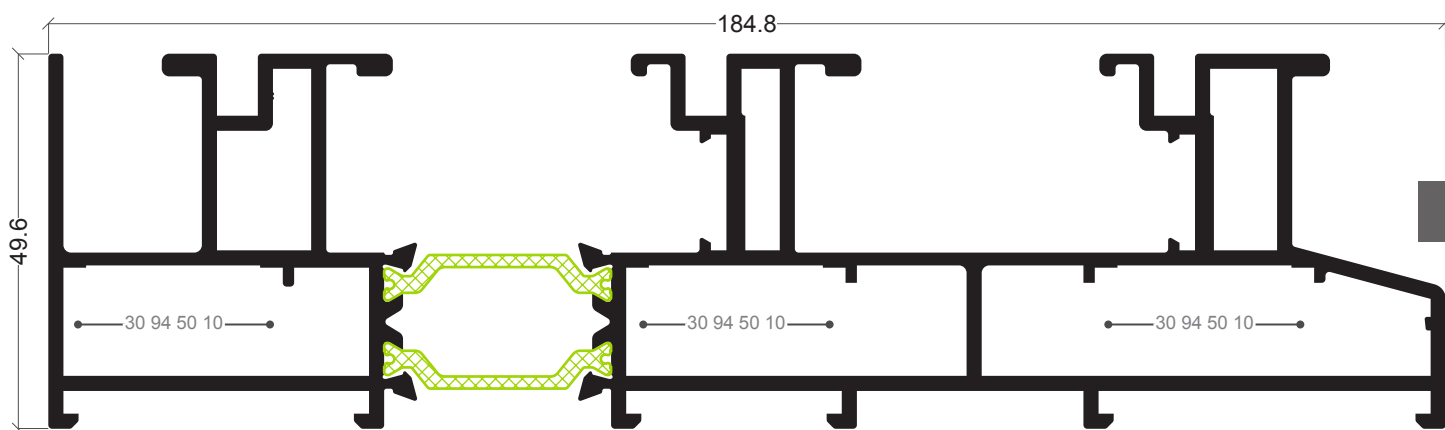

CTe-15
Soleira tri-rail

327



CTe-03
Guia carril (aço inox 304)



CTe-07
Tampa aro inf. PVC CTe-01/13



CTe-16
Tampa aro PVC CTe-05/11/14/15

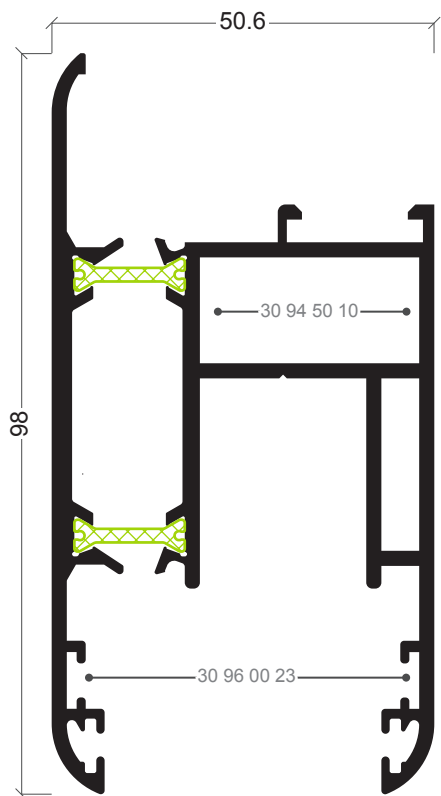

CTe-02
Aro móvel perimetral

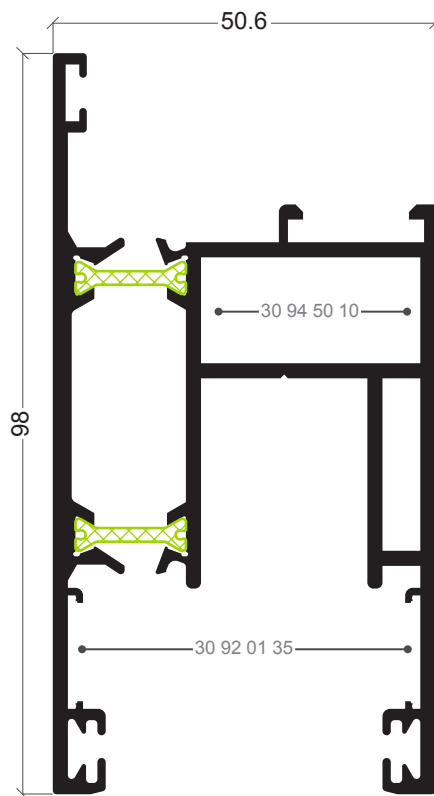

CTe-17
Aro móvel perimetral

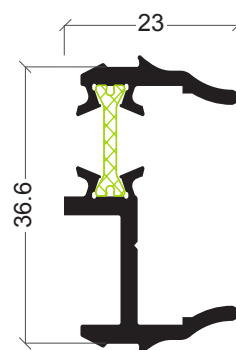

CTe-09
União 3/4 Folhas

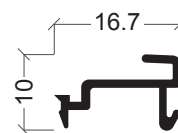

AX-33
Mola bite

328

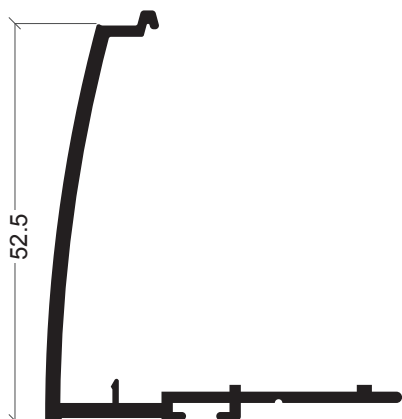

CTe-06
Tampa cruzamento

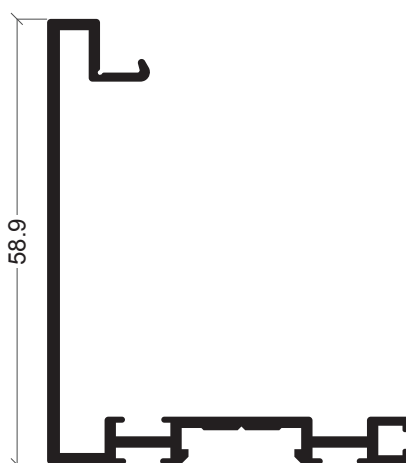

CTe-18
Tampa cruzamento recta



CTe-04
Cruzamento PVC



30 94 50 95
Junta central para CTe-18

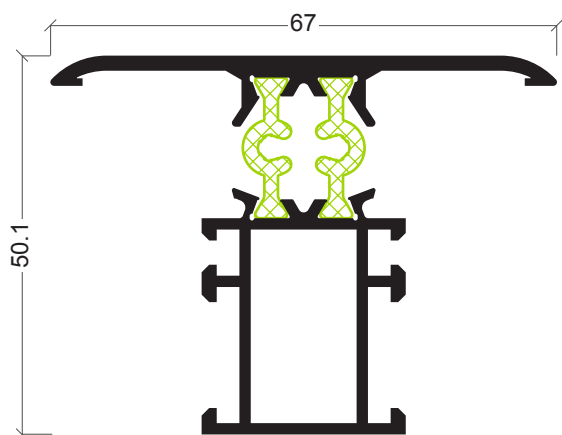

CTe-10
Travessa

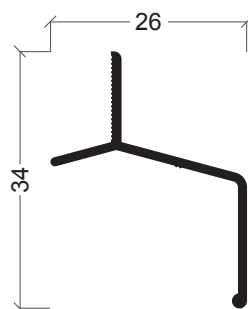

CT-07
Pingadeira superior



AX-19
Vareta

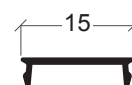

KL-04
Tampa p/ CTe-18

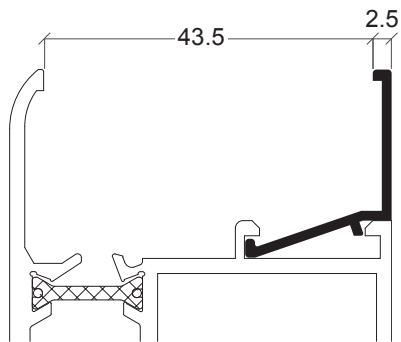

AX-69

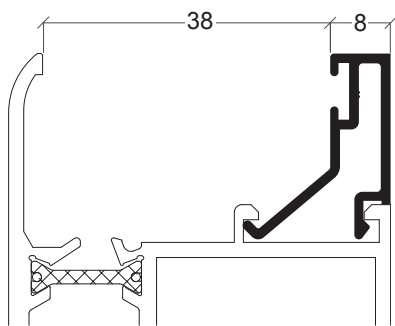

AX-74

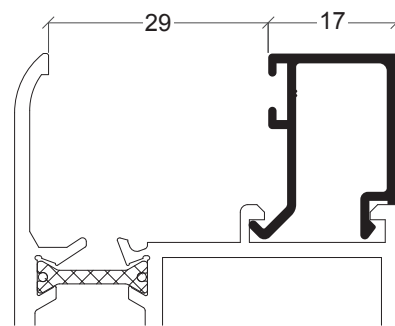

AX-46

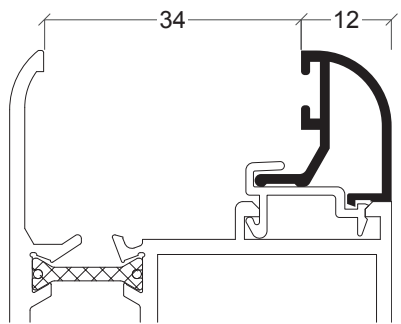

AX-37

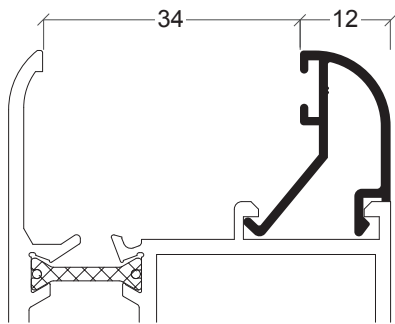

AZ-08

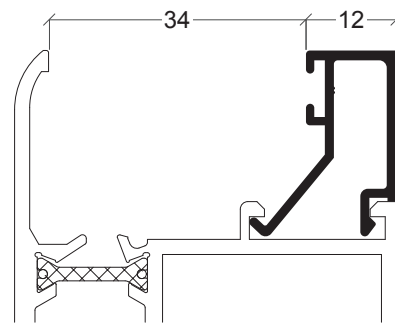

AX-36

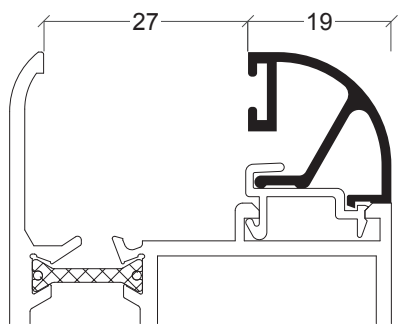

AX-30

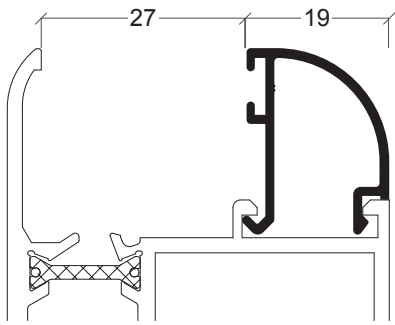

AZ-07

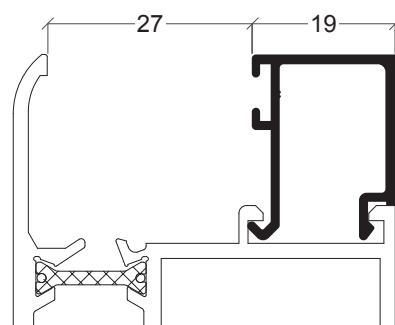

AX-35

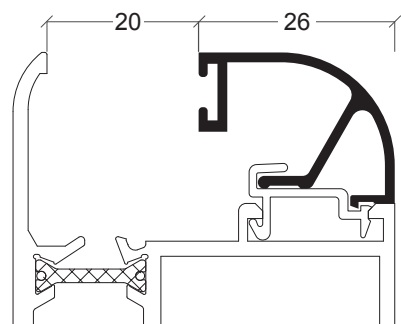

AX-29

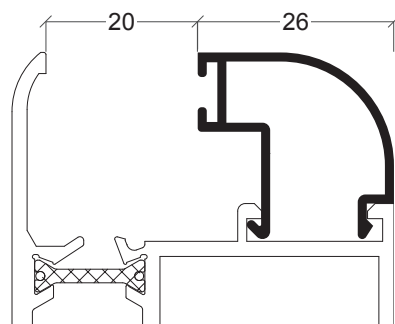

AZ-06

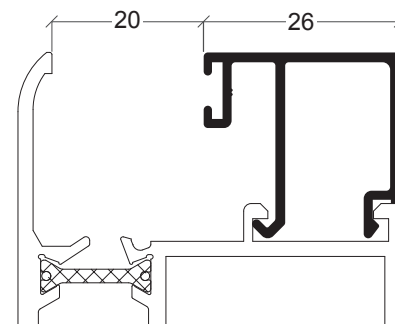

AX-31

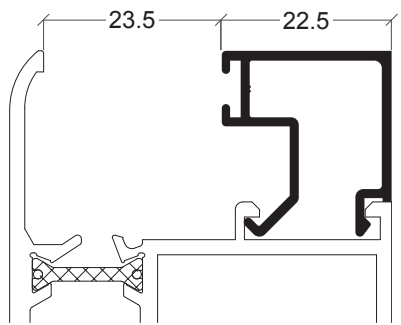

AX-78

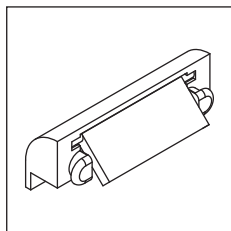

30 92 01 02/03

Goteira preto/branco

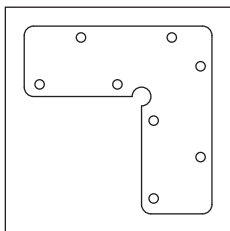

30 92 01 35

Esquadro alinhamento

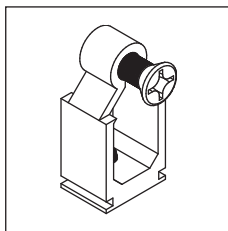

30 92 01 40

União travessa

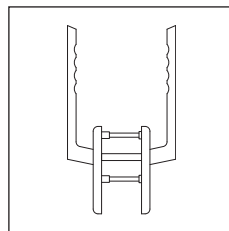

30 94 50 00/01/02

Puxador duplo para correr-elevatória (natural/preto/inox)

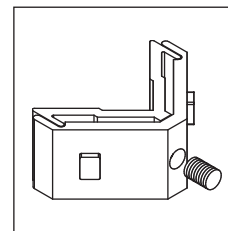

30 94 50 10

Esquadro

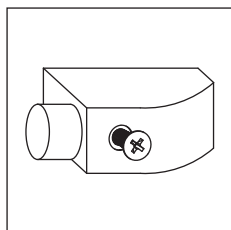

30 94 50 20

Limitador abertura

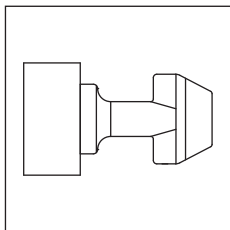

30 94 50 22

Ponto de fecho nº 1 para CTe-14/15

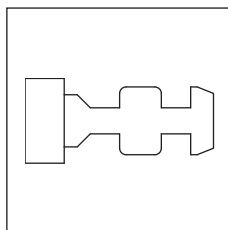

30 94 50 23

Ponto de fecho nº 2 para CTe-14/15

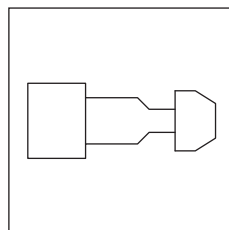

30 94 50 24

Ponto de fecho nº 3 para CTe-08/09/12

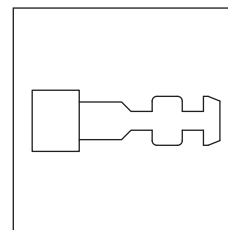

30 94 50 25

Ponto de fecho nº 4 para CTe-08/09/12

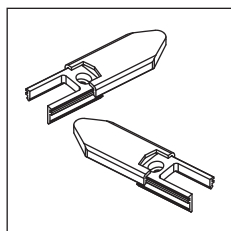

30 94 50 30

Jogo guia móvel CTe-06

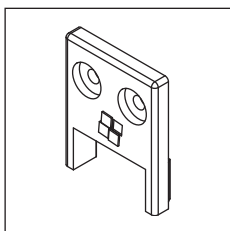

30 94 50 35

Tampa guia móvel CTe-18

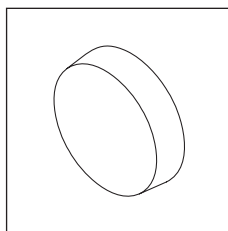

30 94 50 36

Tampa preta para parafuso cabeça de queijo 9.3

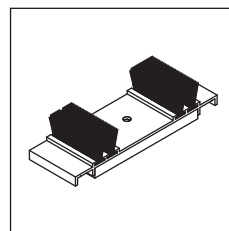

30 94 50 40

Corta vento inf. CTe-01/13

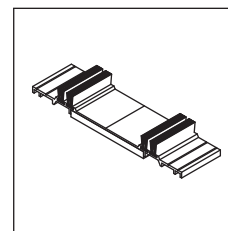

30 94 50 41

Corta vento inf/sup para CTe-05/11/14/15

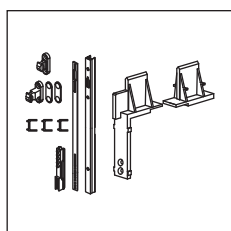

30 94 50 50

Prolongador

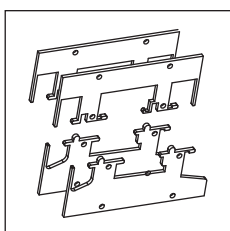

30 94 50 60

Junta estanq. aro inf/sup

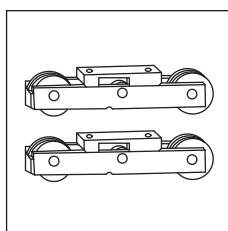

30 94 50 70

Jogo rolamento folha fixa 225Kg

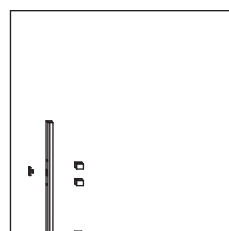

30 94 51 95

Kit elevável 400kg

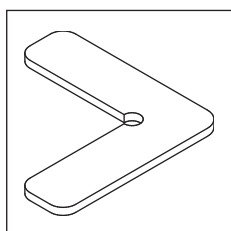

30 96 00 23

Esquadro alinhamento

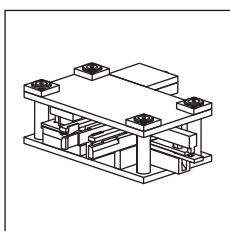

33 94 59 99

Cunho

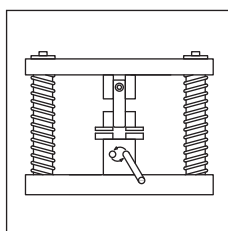





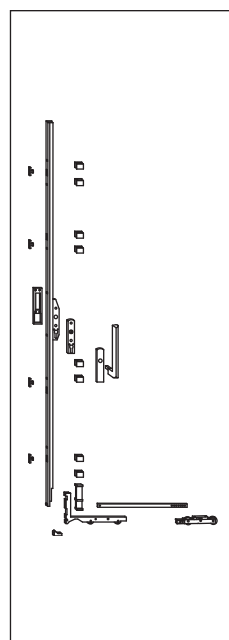









33 94 69 99

Cunho CTe-18



Ver tabela

Kit correr-elevatório para folha até 300kg

Referência	Desenho	Descrição
30 60 00 17		Junta exterior vidro plana 2 mm preto
30 93 00 60		Junta exterior para vidro para o perfil CTe-17 (4 mm)
30 93 00 61		Junta de vedação exterior para o perfil CTe-17 (2 mm)
30 93 00 62		Junta exterior plana para vidro para o perfil CTe-17 (4 mm)
30 93 00 65		Junta interior para vidro (5 mm)
30 93 00 66		Junta interior para vidro (4 mm)
30 93 00 67		Junta interior para vidro (2 mm)
30 93 00 68		Junta interior para vidro (6/7 mm)
30 93 00 69		Junta interior para vidro (8/9 mm)
30 94 50 90		Junta para os perfis CTe-2 ou CTe-17
30 94 50 95		Junta para o perfil CTe-18
30 94 51 00		Junta para os perfis CTe-8 ou CTe-12
30 95 00 40		Pelúcia 7x5.5 mm Fin-Seal para o perfil CTe-06
30 95 00 50		Pelúcia 7x6 mm Fin-Seal para o perfil CTe-18
30 95 60 02		Junta tapa-canal

largura mínima da folha: 720 mm
 largura máxima folha: 3350 mm

altura mínima folha: 1190 mm
 altura máxima folha: 2690 mm^a

Kits Correr-eleváveis (peso máximo por folha 300kg ^b)							
Largura LF	Altura HF	Cor	Referência	Cor	Referência	Cor	Referência
720/1500	1190/1790	Branco	30 94 51 06	Preto	30945107	Natural	30945108
720/1500	1791/2090	Branco	30 94 51 11	Preto	30945112	Natural	30945113
720/1500	2091/2390	Branco	30 94 51 16	Preto	30945117	Natural	30945118
720/1500	2391/2690	Branco	30 94 51 21	Preto	30945122	Natural	30945123
1501/2000	1190/1790	Branco	30 94 51 26	Preto	30945127	Natural	30945128
1501/2000	1791/2090	Branco	30 94 51 31	Preto	30945132	Natural	30945133
1501/2000	2091/2390	Branco	30 94 51 36	Preto	30945137	Natural	30945138
1501/2000	2391/2690	Branco	30 94 51 41	Preto	30945142	Natural	30945143
2011/2500	1190/1790	Branco	30 94 51 46	Preto	30945147	Natural	30945148
2011/2500	1791/2090	Branco	30 94 51 51	Preto	30945152	Natural	30945153
2011/2500	2091/2390	Branco	30 94 51 56	Preto	30945157	Natural	30945158
2011/2500	2391/2690	Branco	30 94 51 61	Preto	30945162	Natural	30945163
2501/3350	1190/1790	Branco	30 94 51 66	Preto	30945167	Natural	30945168
2501/3350	1791/2090	Branco	30 94 51 71	Preto	30945172	Natural	30945173
2501/3350	2091/2390	Branco	30 94 51 76	Preto	30945177	Natural	30945178
2501/3350	2391/2690	Branco	30 94 51 81	Preto	30945182	Natural	30945183

^a Altura máxima até 3325 mm com prolongador (sob encomenda)

^b para folha com peso inferior a 300kg. Para folha entre 301kg e 400kg acrescentar o kit suplementar 30945195

Cor Inox sob encomenda

Porta 2 folhas correr elevável perimetral

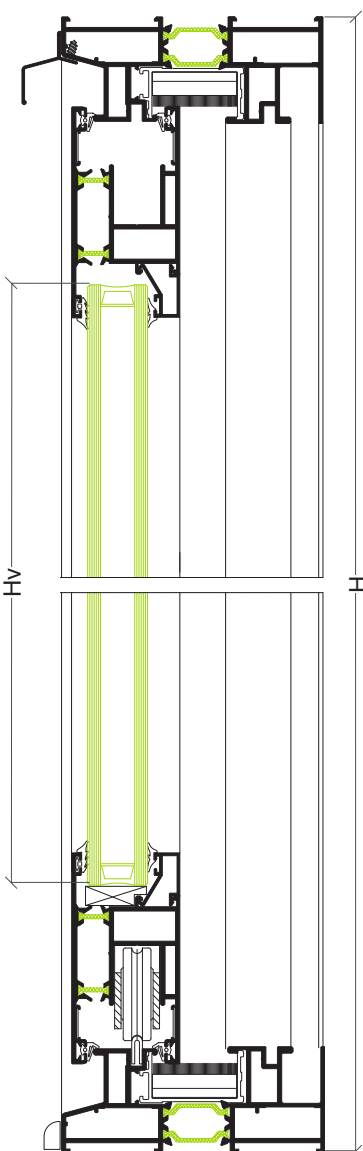
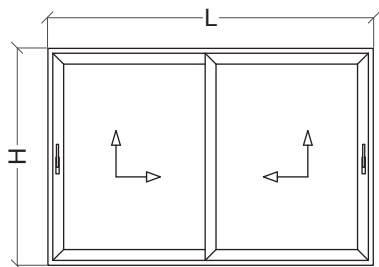

Perfis

Desenho	Ref	Descrição	Corte	Quant	Medida
	CTe-14	Aro fixo perimetral		2	L
				2	H
	CTe-17	Aro móvel perimetral		4	L/2+4 mm
				4	H-83 mm
	CTe-18	Tampa de cruzamento		2	H-83 mm
	CTe-03	Perfil guia		2	L-83 mm
	CT-07	Pingadeira		1	L
	----	Bite recto		4	L/2-152 mm
				4	H-279 mm
	CTe-16'	Tampa aro perimetral PVC		2	L-47 mm
				2	H-47 mm
	KL-04	Tampa para CTe-18		2	H-83 mm

* cortar juntamente com o perfil CTe-14

Acessórios e Juntas

Referência	Descrição	Quantidade	
		Móvel/Fixa	Móvel/Móvel
----	Kit elevável	1	2
30 94 50 10	Esquadro	16	16
30 94 50 35	Tampa guia lateral	4	4
30 92 01 35	Esquadro alinhamento	16	16
30 94 50 41	Corta ventos	2	2
30 92 01 02	Goteira com válvula (cor preto)	diversas	diversas
30 95 00 50	Pelúcia 7x6 mm Fin-seal	4H	4H
30 94 50 95	Junta central CTe-Recta	2H	2H
30 94 50 90	Junta aro móvel perimetral	2L+4H	2L+4H
----	Junta para vidro (interior)	2L+4H	2L+4H
----	Junta para vidro (exterior)	2L+4H	2L+4H
30 94 51 95	Kit suplementar (folha com 301kg-400kg)	1 (opcional)	2 (opcional)
30 94 50 50	Prolongador (Hf -> 2790 mm-3225 mm)	1 (opcional)	2 (opcional)
30 94 50 20	Limitador de abertura	-	1
30 94 50 70	Rolamento folha fixa	2	-

Vidro



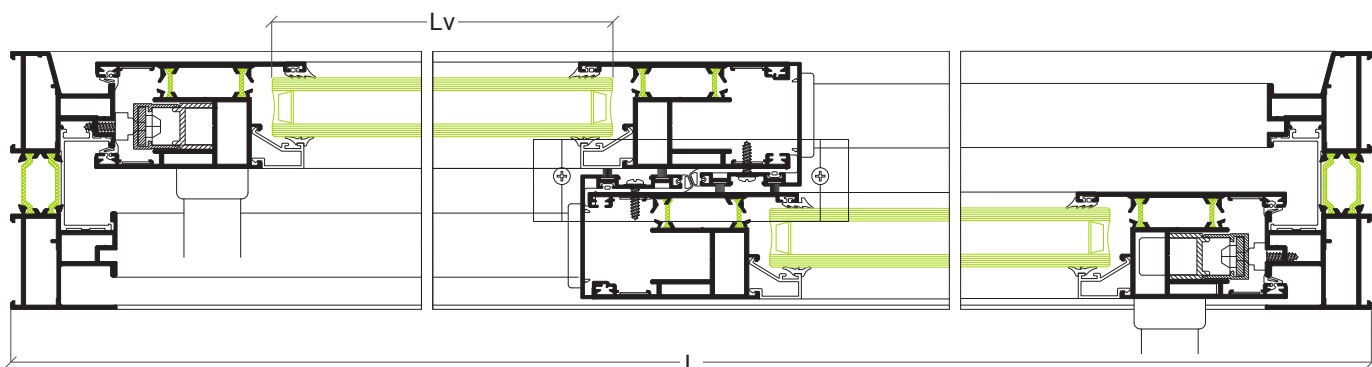



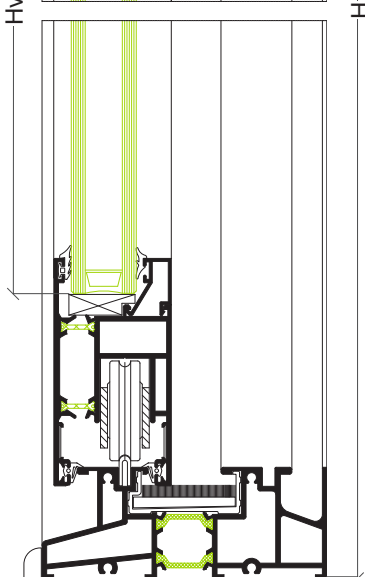
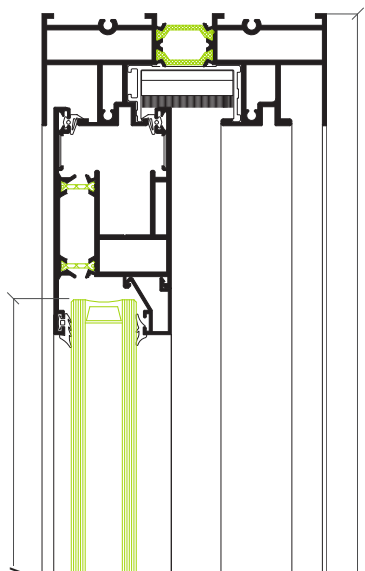
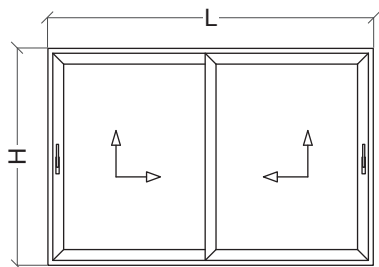





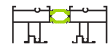

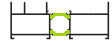

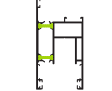



Hv = H-253 mm	Lv = L/2-162 mm
---------------	-----------------



Porta 2 folhas correr elevável



Perfis

Desenho	Ref	Descrição	Corte	Quant	Medida
	CTe-01	Soleira		1	L-67 mm
	CTe-05	Padieira		1	L-67 mm
	CTe-08	Ombreira		2	H
	CTe-17	Aro móvel perimetral		4	L/2-6 mm
	CTe-18	Tampa de cruzamento		2	H-81 mm
	CTe-03	Perfil guia		2	L-67 mm
	----	Bite recto		4	L/2-150 mm
	CTe-16'	Tampa para padieira		1	L-67 mm
	CTe-07'	Tampa para soleira		1	L-67 mm
	KL-04	Tampa para CTe-18		2	H-83 mm

* cortar juntamente com o respectivo perfil de alumínio

Acessórios e Juntas

Referência	Descrição	Quantidade
----	Kit elevável	2
30 94 50 10	Esquadro	8
30 94 50 35	Tampa guia lateral	4
30 92 01 35	Esquadro alinhamento	16
30 94 50 40	Corta vento inferior	1
30 94 50 41	Corta vento superior	1
30 94 50 60	Kit de juntas de estanquidade	1
30 92 01 02	Goteira com válvula (cor preto)	diversas
30 95 00 50	Pelúcia 7x6 mm Fin-Seal	4H
30 94 50 90	Junta aro perimetral	4L+4H
30 94 51 00	Junta ombreira	2H
30 94 50 95	Junta central CTe-Recta	2H
----	Junta para vidro (interior)	2L+4H
----	Junta para vidro (exterior)	2L+4H
30 94 51 95	Kit suplementar (folha com 301kg-400kg)	2 (opcional)
30 94 50 50	Prolongador (Hf -> 2790 mm-3225 mm)	2 (opcional)
30 94 50 20	Limitador de abertura	1

Vidro

Hv = H-253 mm	Lv = L/2-164 mm
---------------	-----------------

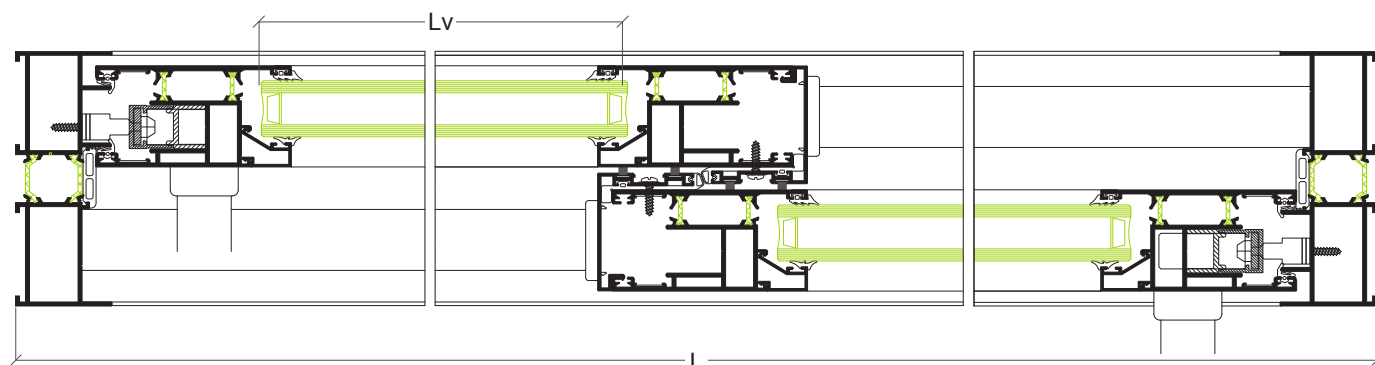

Porta 3 folhas correr elevável tri-rail

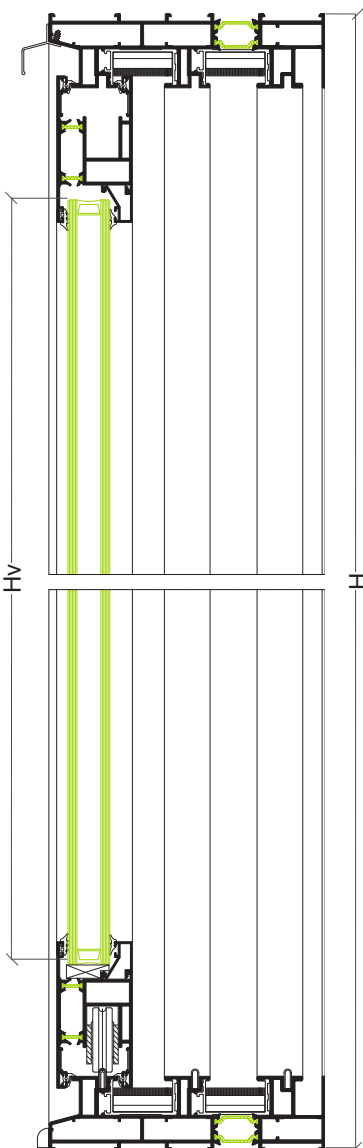
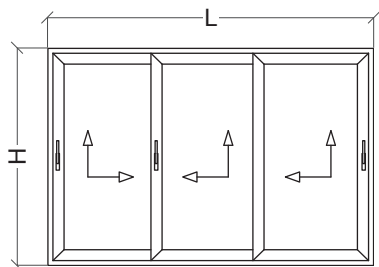

Perfis

Desenho	Ref	Descrição	Corte	Quant	Medida
	CTe-15	Aro fixo tri-rail perimetral		2	L
				2	H
	CTe-17	Aro móvel perimetral		6	L/3+33 mm
				6	H-83 mm
	CTe-18	Tampa de cruzamento		4	H-83 mm
	CTe-03	Perfil guia		3	L-83 mm
	CT-07	Pingadeira		1	L
	-----	Bite recto		6	L/3-123 mm
				6	H-279 mm
	CTe-16'	Tampa aro perimetral PVC		4	L-47 mm
				4	H-47 mm
	KL-04	Tampa para CTe-18		4	H-83 mm

* cortar juntamente com o perfil CTe-15

Acessórios e Juntas

Referência	Descrição	Quantidade
-----	Kit elevável	3
30 94 50 10	Esquadro	24
30 94 50 35	Tampa guia lateral	8
30 92 01 35	Esquadro alinhamento	24
30 94 50 41	Corta ventos	4
30 92 01 02	Goteira com válvula (cor preto)	diversas
30 95 00 50	Pelúcia 7x6 mm Fin-seal	8H
30 94 50 95	Junta central CTe-Recta	4H
30 94 50 90	Junta aro móvel perimetral	4L+4H
-----	Junta para vidro (interior)	2L+6H
-----	Junta para vidro (exterior)	2L+6H
30 94 51 95	Kit suplementar (folha com 301kg-400kg)	3 (opcional)
30 94 50 50	Prolongador (Hf -> 2790 mm-3225 mm)	3 (opcional)
30 94 50 20	Limitador de abertura	2

Vidro

Hv = H-253 mm	Lv = L/3-137 mm
---------------	-----------------

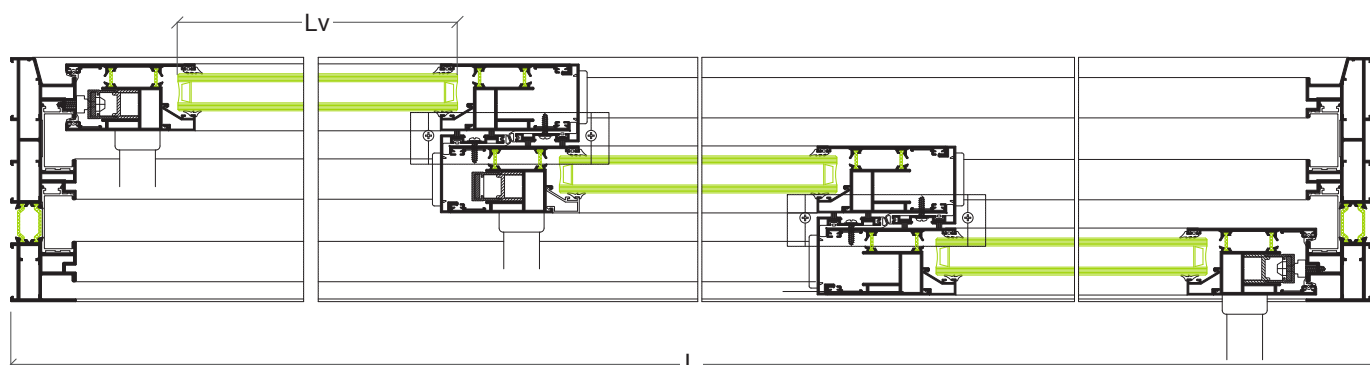

Porta 4 folhas correr elevável

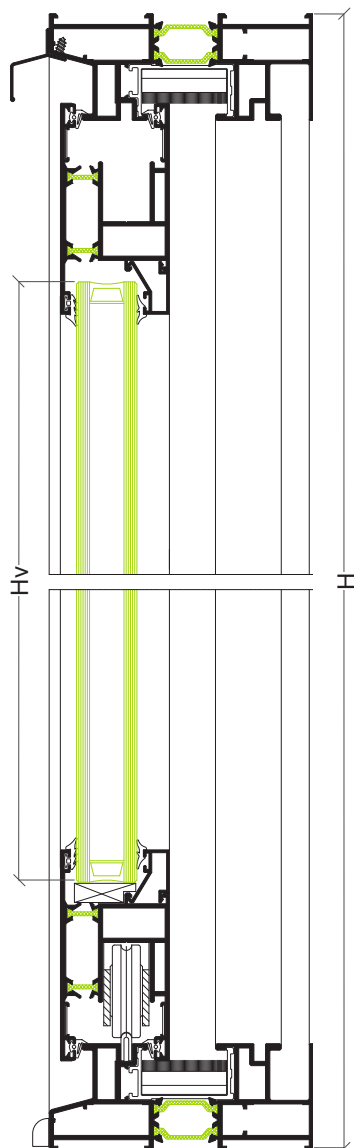
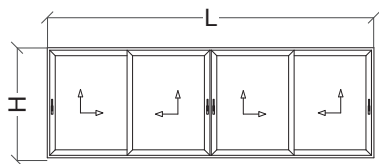

Perfis

Desenho	Ref	Descrição	Corte	Quant	Medida
	CTe-14	Aro fixo perimetral		2	L
				2	H
	CTe-17	Aro móvel perimetral		8	L/4+23 mm
				8	H-83 mm
	CTe-18	Tampa de cruzamento		4	H-83 mm
	CTe-03	Perfil guia		2	L-83 mm
	CT-07	Pingadeira		1	L
	CTe-09	União 3/4F		1	H-83 mm
	-----	Bite recto		8	L/4-133 mm
				8	H-279 mm
	CTe-16*	Tampa aro perimetral PVC		2	L-47 mm
				2	H-47 mm
	KL-04	Tampa para CTe-18		4	H-83 mm

* cortar juntamente com o perfil CTe-14

Acessórios e Juntas

Referência	Descrição	Quantidade
-----	Kit elevável	4
30 94 50 10	Esquadro	24
30 94 50 35	Tampa guia lateral	8
30 92 01 35	Esquadro alinhamento	32
30 94 50 41	Corta ventos	6
30 92 01 02	Goteira com válvula (cor preto)	diversas
30 95 00 50	Pelúcia 7x6 mm Fin-seal	8H
30 94 50 95	Junta central CTe-Recta	4H
30 94 50 90	Junta aro móvel perimetral	4L+6H
-----	Junta para vidro (interior)	2L+8H
-----	Junta para vidro (exterior)	2L+8H
30 94 51 95	Kit suplementar (folha com 301kg-400kg)	4 (opcional)
30 94 50 50	Prolongador (Hf -> 2790 mm-3225 mm)	4 (opcional)
30 94 50 20	Limitador de abertura	2

335

Vidro

Hv = H-253 mm	Lv = L/4-147 mm
---------------	-----------------

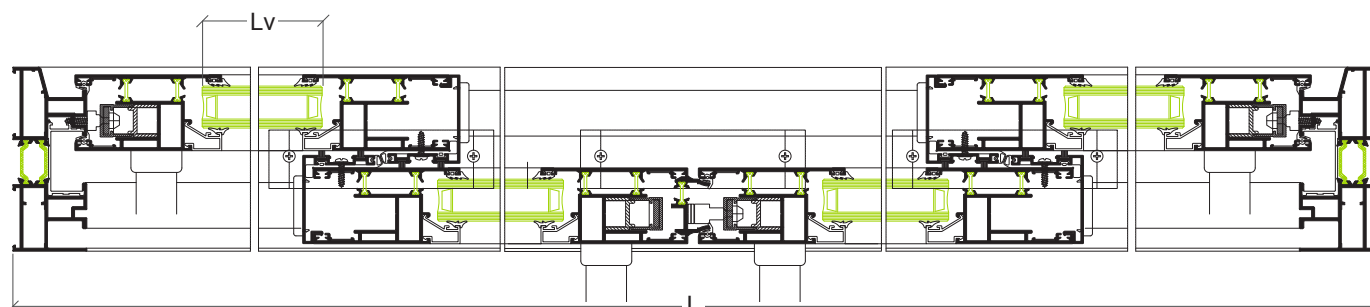

Porta 6 folhas correr elevável tri-rail

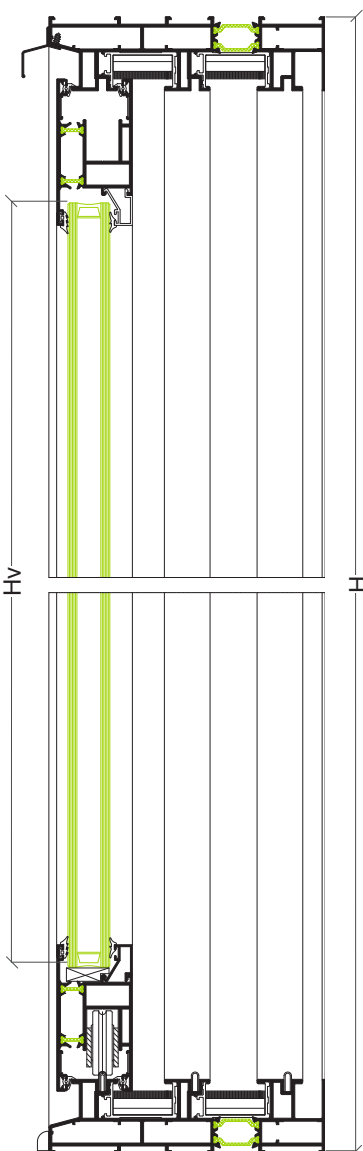
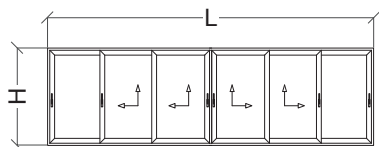

Perfis

Desenho	Ref	Descrição	Corte	Quant	Medida
	CTe-15	Soleira tri-rail		2	L
				2	H
	CTe-17	Aro móvel perimetral		12	L/6+46 mm
				12	H-83 mm
	CTe-18	Tampa de cruzamento		8	H-83 mm
	CTe-09	Perfil para 4 folhas		1	H-83 mm
	CTe-03	Perfil guia		3	L-83 mm
	CT-07	Pingadeira		1	L
	----	Bite recto		12	L/6-110 mm
				12	H-279 mm
	CTe-16'	Tampa aro perimetral PVC		4	L-47 mm
				4	H-47 mm
	KL-04	Tampa para CTe-18		8	H-83 mm

* cortar juntamente com o perfil CTe-15

Acessórios e Juntas

Referência	Descrição	Quantidade
----	Kit elevável	4
30 94 50 10	Esquadro	36
30 94 50 35	Tampa guia lateral	16
30 92 01 35	Esquadro alinhamento	48
30 94 50 41	Corta ventos	10
30 92 01 02	Goteira com válvula (cor preto)	diversas
30 95 00 50	Pelúcia 7x6 mm Fin-seal	16H
30 94 50 95	Junta central CTe-Recta	8H
30 94 50 90	Junta aro móvel perimetral	4L+6H
----	Junta para vidro (interior)	2L+12H
----	Junta para vidro (exterior)	2L+12H
30 94 50 70	Rolamento para folha fixa (250kg máx. folha)	4
30 94 51 95	Kit suplementar (folha com 301kg-400kg)	4 (opcional)
30 94 50 50	Prolongador (Hf -> 2790 mm-3225 mm)	4 (opcional)
30 94 50 20	Limitador de abertura	2

Vidro

Hv = H-253 mm	Lv = L/6-124 mm
---------------	-----------------

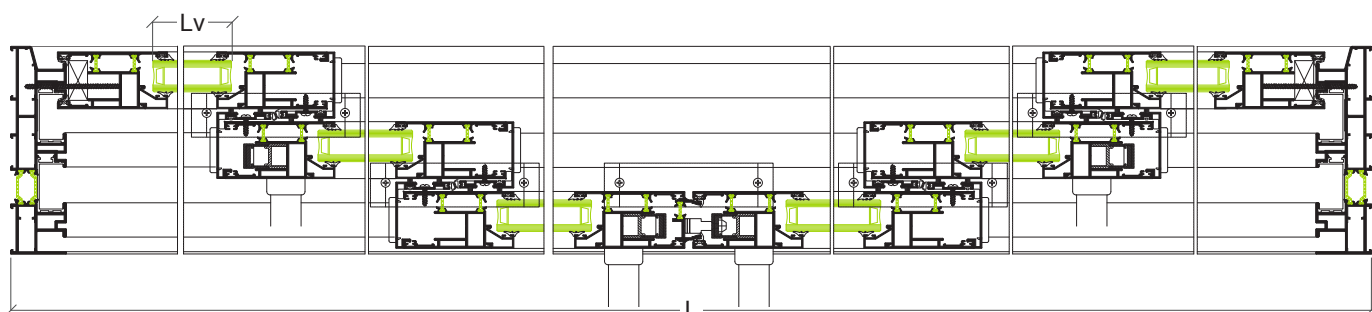

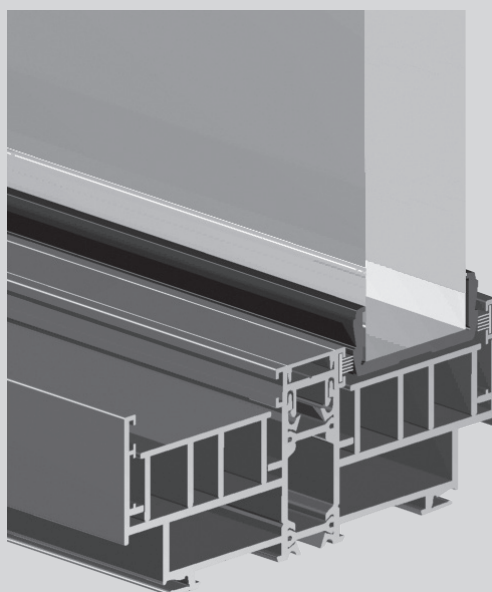
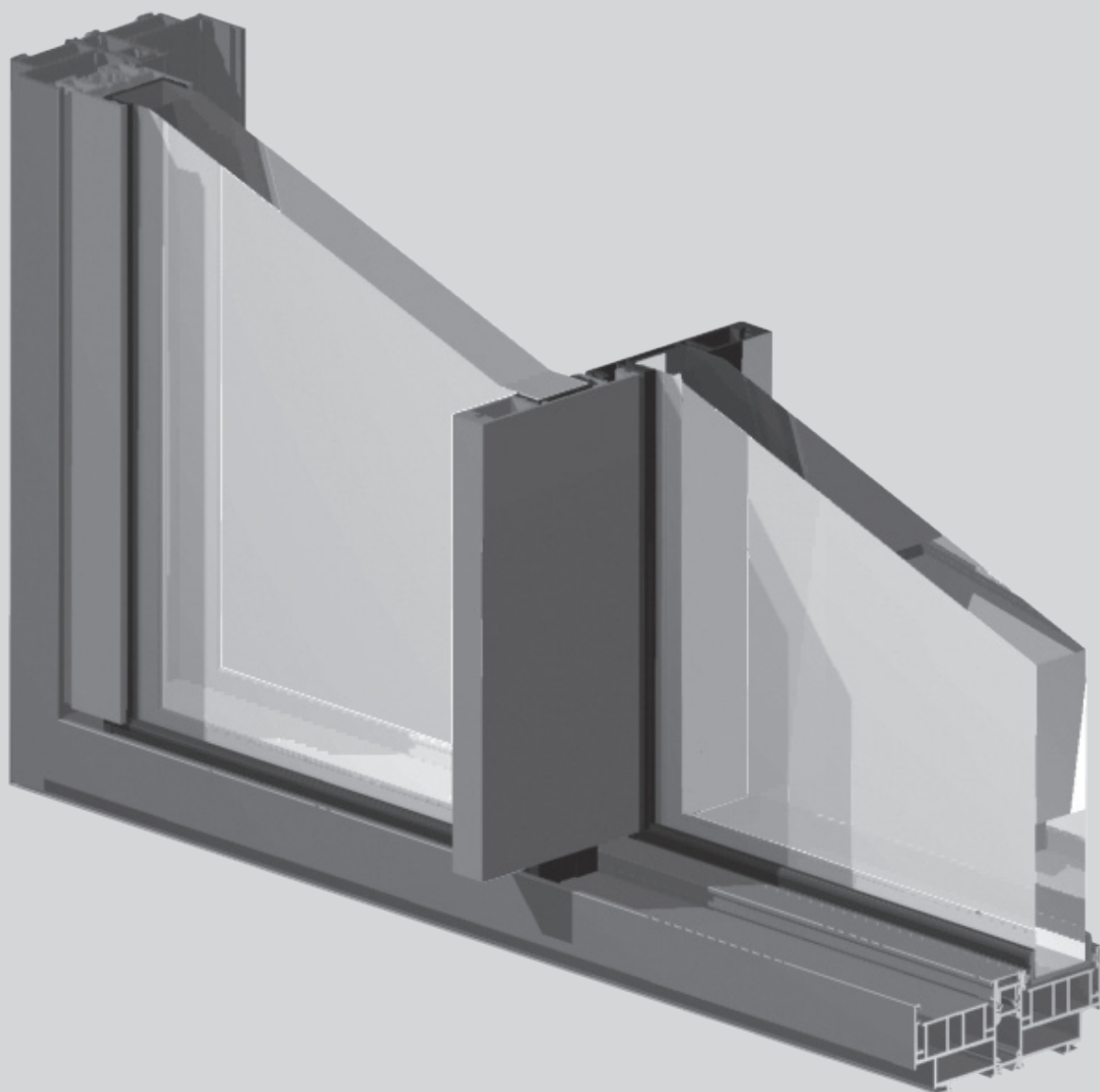

**Sistema
Kristal**

Sistema Kristal

Sistema de correr de conceito minimalista com RPT

Características do sistema

Sistema de alumínio com rotura térmica para executar vãos de correr de conceito minimalista.

Perfis de alumínio

Os perfis de alumínio são extrudidos na liga de alumínio 6060 para arquitetura de acordo com norma NP EN 12020-02.

Perfis com rotura térmica obtida por inserção de varetas isolantes de poliamida de 6.6 mm reforçadas com 25% de fibra de vidro de 14.6 mm nos aros fixos e de 18 mm nos aros móveis.

Espessura média dos perfis de alumínio de 2.0 mm.

Aros fixos

Secção do aro fixo perimetral de 120 mm com bi-rail para montagem a meia esquadria;

Possibilidade de aplicação de remates interior ou exterior;

Perfil guia de deslizamento inferior em alumínio com rolamentos duplos de altas prestações em aço inoxidável 316.

Aros móveis

Secção dos aros móveis de vista muito reduzida de corte recto por montagem por clipagem;

Vidro duplo isolante com selagem secundária de silicone de 32.4 mm a 32.8 mm de espessura total, composto por tipologias de vidro exterior temperado ou termo-endurecido e de vidro interior laminado termo-endurecido ou temperado;

Calha em polímero colada em todo o perímetro do vidro isolante com silicone estrutural preto;

Silicones estruturais recomendados: Dow Corning 791 preto ou Sikasil SG20 preto;

Aros móveis reforçados de linha contemporânea para elevados dimensionamentos.

Dimensionamento e manobralidade

Dimensões mínimas - máximas de folha: 300 mm - 3000 mm (L); 500 mm - 3000 mm (H);

Peso máximo de 300 kg por folha;

Tipologias de 2, 3 ou 4 folhas móveis e/ou fixas;

Possibilidade de abertura em canto;

Sistema de correr de conceito minimalista com deslizamento das folhas sobre o perfil de alumínio efectuado com rolamentos em aço inoxidável de altas prestações para uma fácil abertura do vão mesmo com configurações extremas de peso ou dimensão;

Tipologias dos vãos com mais de 95% de luminosidade;

Permeabilidade ao ar e estanquidade à água asseguradas através de pelúcia de última geração e junta em EPDM de qualidade marítima;

Ferragem multiponto com diversos pontos de fecho e de fácil aplicação e regulação;

Ferragem multiponto com micro-ventilação incluída em todos os pontos de fecho;

Puxador específico para facilitar a manobra de abertura e de fecho do vão;

Existe a opção de puxador com chave para permitir a abertura do vão pelo exterior.

Performances

Sistema certificado por laboratório notificado para Ensaio Tipo Inicial (ITT) de acordo com a norma de produto EN 14351-1 para efeitos de Marcação CE.

Categorias alcançadas na avaliação do sistema Kristal tipologia janela:

1. Permeabilidade ao ar: Classe 4 (norma de ensaio EN 1026)
2. Estanquidade à água: Classe 7A (norma de ensaio EN 1027)
3. Resistência ao vento: Classe C5 (norma de ensaio EN 12211)

Categorias alcançadas na avaliação do sistema Kristal tipologia porta:

1. Permeabilidade ao ar: Classe 3 (norma de ensaio EN 1026)
2. Estanquidade à água: Classe 6A (norma de ensaio EN 1027)
3. Resistência ao vento: Classe C2 (norma de ensaio EN 12211)
4. Permeabilidade ao ar em Micro-ventilação: Classe 1 (norma de ensaio EN 1026)

Categorias alcançadas na avaliação do sistema KRISTAL para determinação das forças de manobra (EN 12046):

1. Libertação da ferragem de fecho: Classe 2
2. Abertura da folha: Classe 1
3. Fecho da folha: Classe 1
4. Engate da ferragem de fecho: Classe 2

Categoria alcançada na determinação da resistência a abertura e fecho repetidos (5000 ciclos): Classe 1 (EN 1191)

Coefficiente de transmissão térmica de vão de 2 folhas com 5.0 m x 3.0 m com vidro $U_g = 1.0 \text{ W/m}^2\text{K}$, com intercalar efeito "Warm Edge":

• $U_w = 1.29 \text{ W/m}^2\text{K}$

Coefficiente de atenuação acústica de vão de 2 folhas com vidro acústico 8/16/44.1:

• $R_w (C; C_{tr}) = 41 \text{ dB} (-1; -5)$

Zonas de aplicação segundo RCCTE (em função do valor U_g): I1, I2, I3, V1, V2, V3.

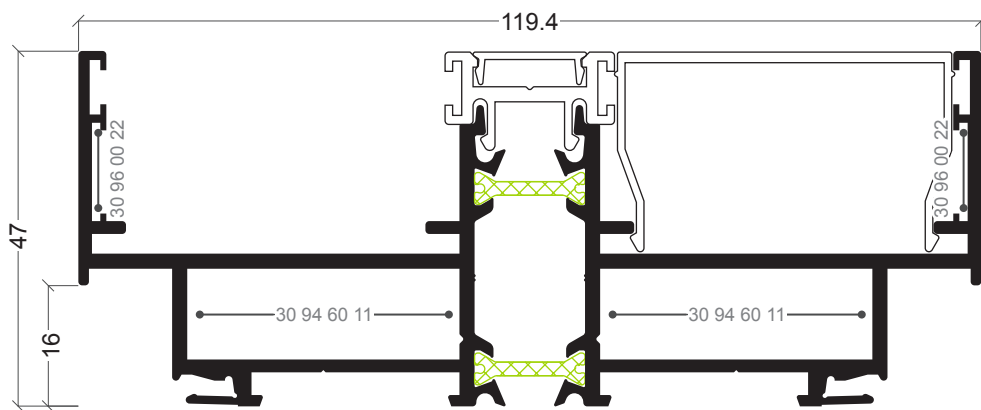

KL-01
Aro fixo perimetral

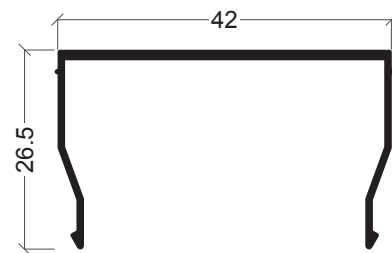

KL-13
Perfil Tampa

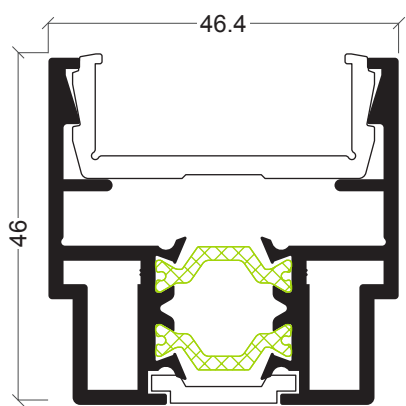

KL-03
Aro móvel lateral

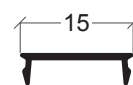

KL-04
Perfil complementar aro fixo

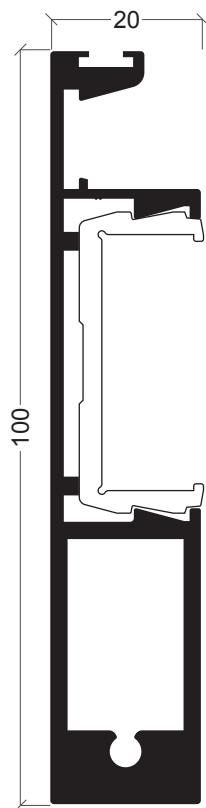

KL-02
Aro móvel central reforçado

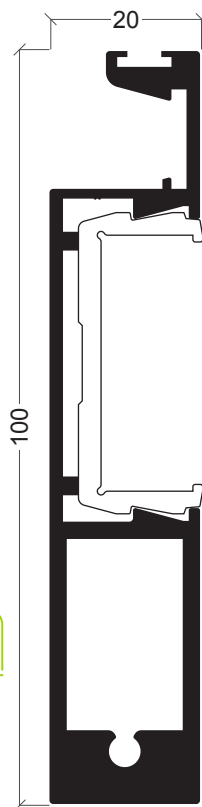

KL-12
Aro móvel central reforçado 3/4 folhas

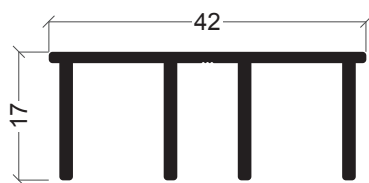

KL-05
Perfil suporte para folha fixa

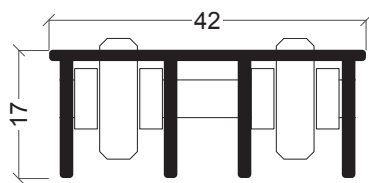

KL-05/RD
Perfil guia para folha móvel
Acetinado 1AC
Acetinado 2AC
Lacado 9005 MT

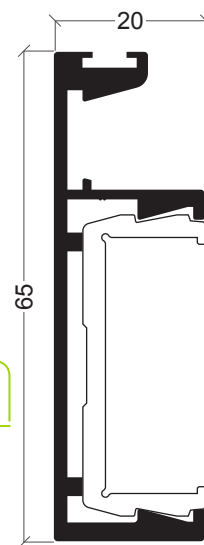

KL-09
Aro móvel central

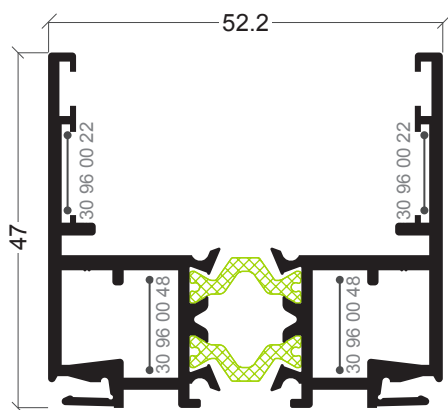

KL-10
Perfil mono-rail e 3º rail

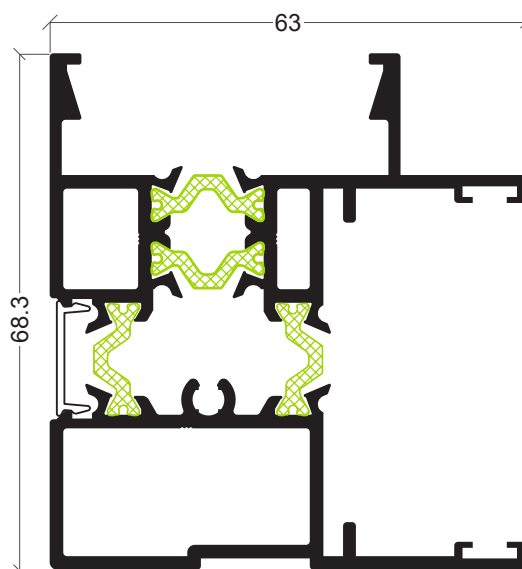

KL-11
Perfil canto

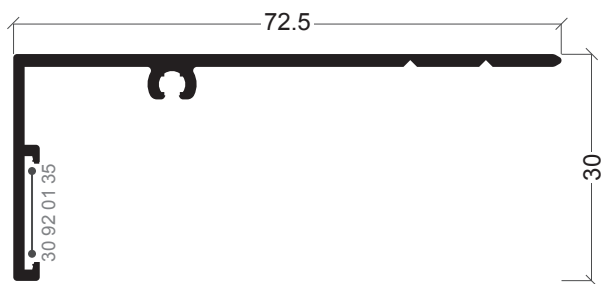

AXi-83
Remate

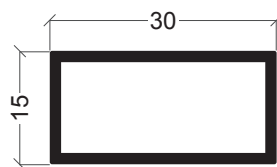

P-02
Complemento para 3ª e 4ª guia

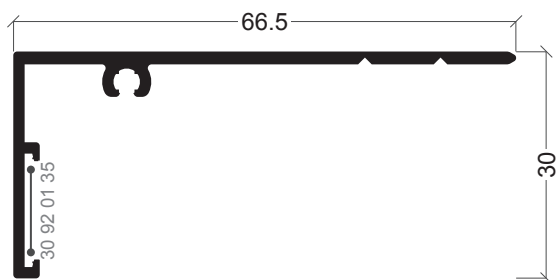

AXi-73
Remate

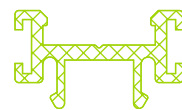

KL-06
Perfil polímero central

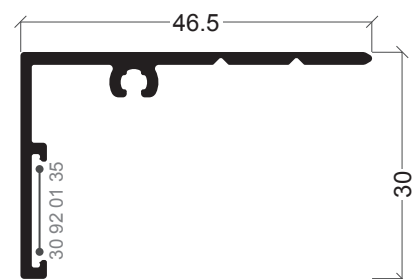

AXi-80
Remate



AXi-88
Complemento remate

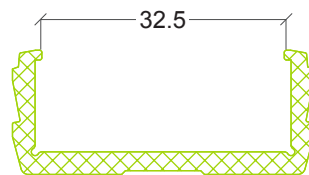

KL-07
Perfil polímero para vidro

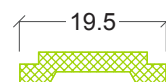

KL-08
Vareta de poliamida

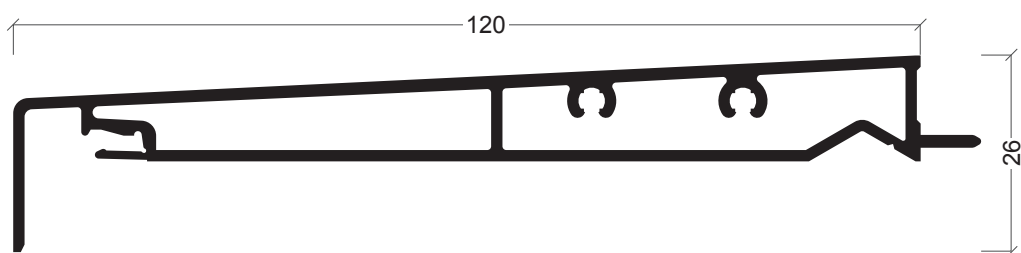

AXi-74
Remate soleira

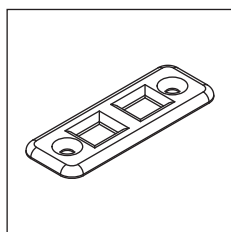

30 24 30 75
Contra-fecho inox
aplicar com fechos lisos

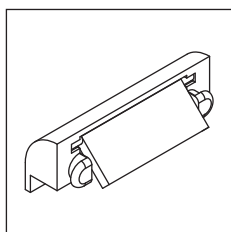

30 92 01 02/03
Goteira com válvula
(preto/branco)

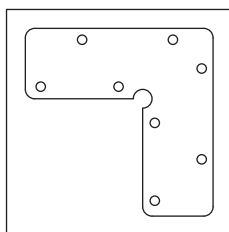

30 92 01 35
Esquadro alinhamento
AXi-73/80/83/88

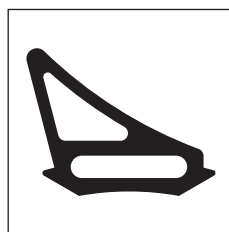

30 93 05 00
Junta central EPDM
KL-02

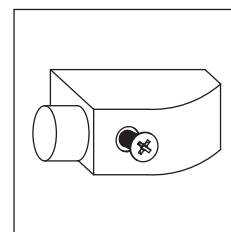

30 94 50 20
Limitador de abertura

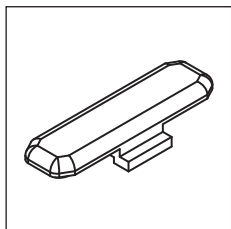

30 94 60 01
União varetas nylon
preto

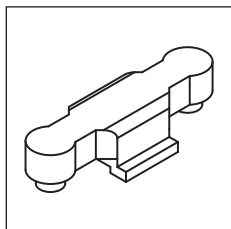

30 94 60 02
União varetas zamack
preto alternativa

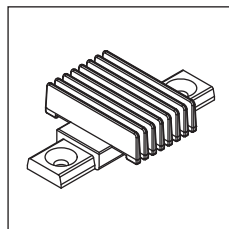

30 94 60 03
Corta-vento Kristal preto

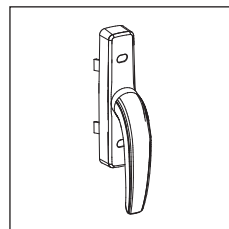

30 94 60 04/05
Cremone exterior lacado
(branco/preto)

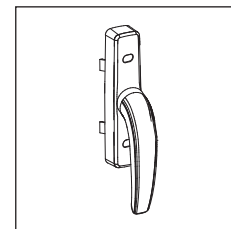

30 94 60 06
Cremone exterior lacado
(cinza 9006)

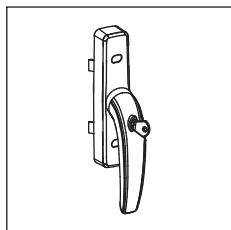

30 94 60 08/09
Cremone exterior com
chave lacado (branco/preto)

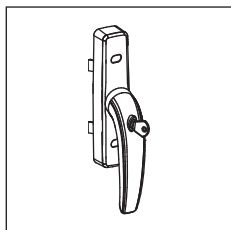

30 94 60 10
Cremone exterior lacado
com chave (cinza 9006)

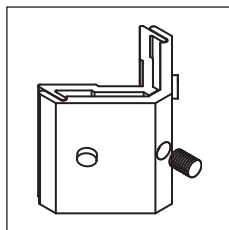

30 94 60 11
Esquadro 36x12 mm
centrado KL-01

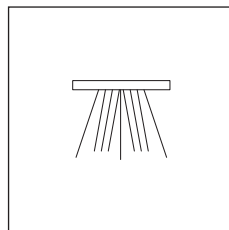

30 94 60 12
Pelúcia tri-fin

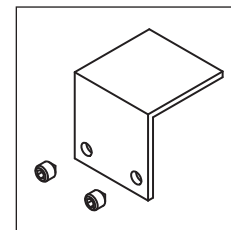

30 94 60 13
Cantoneira de apoio
central preto KL-02

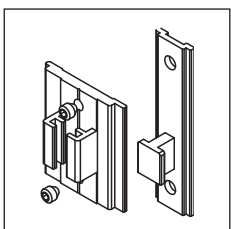

30 94 60 14
Conjunto fecho preto

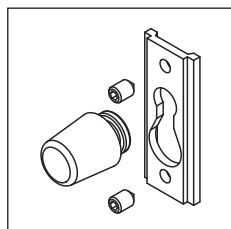

30 94 60 15
Batente preto KL-03

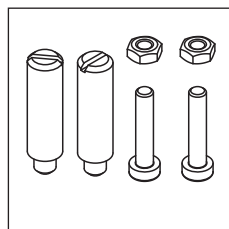

30 94 60 16
Suplemento para fecho
fixação cremone exterior

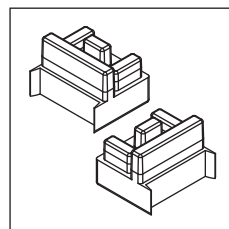

30 94 60 17
Conjunto topo lateral
preto KL-03

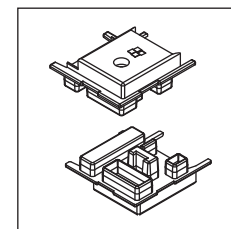

30 94 60 18
Conjunto topo canto
preto KL-11

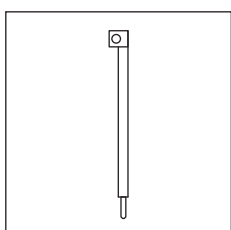

30 94 60 19/21
Fecho liso interior
450 mm (branco/preto)

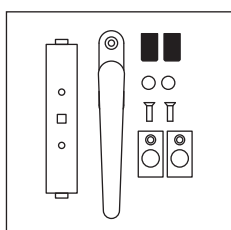

30 94 60 20/22
Conjunto puxadores para
3F/4F ou central

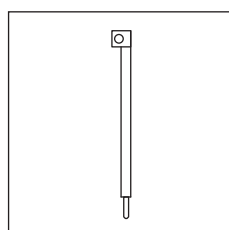

30 94 60 25/26
Fecho liso interior
700 mm (branco/preto)

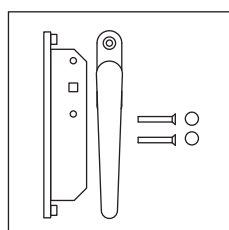

30 94 60 28/29
Puxador lateral baixo
(branco/preto)

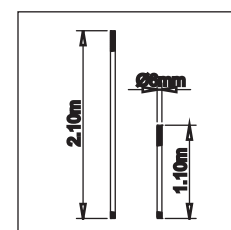

30 94 60 31
Conjunto varão alumínio
3000 mm

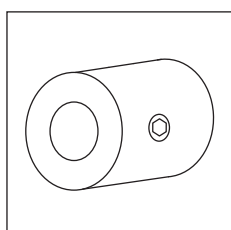

30 94 60 32
Guiador para varão por
cada 500 mm

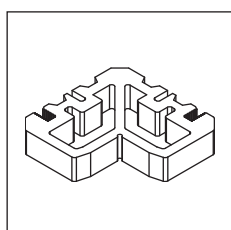

30 94 60 33
Esquadro para canto 90°

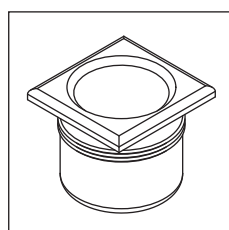

30 94 60 34
Contra-fecho central para
puxador 3/4 F + central (preto)

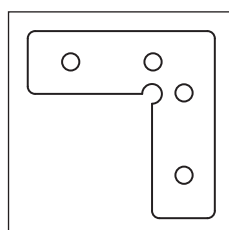

30 96 00 22
Esquadro de
alinhamento KL-01

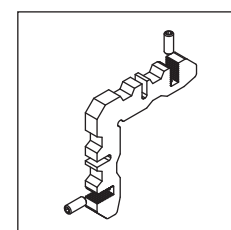

30 96 00 48
Esquadro interior/exterior
KL-10

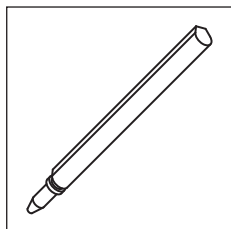

30 96 00 55

Perno para fixação esquadro
30 96 00 48 (opcional)

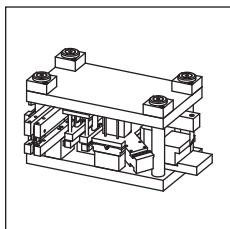

33 93 29 99

Cunho

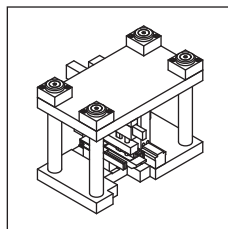

33 96 87 99

Cunho esquadros exteriores
e interiores KL-10

Janela 1 folha correr com fixo lateral

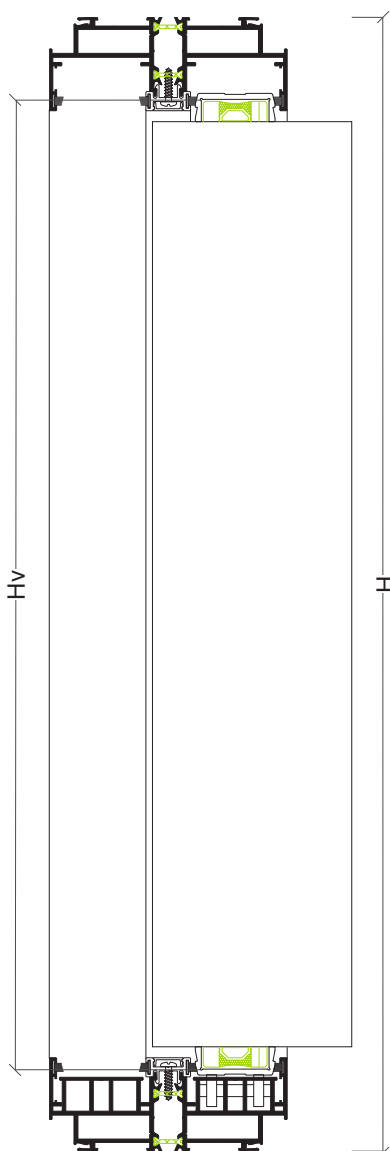
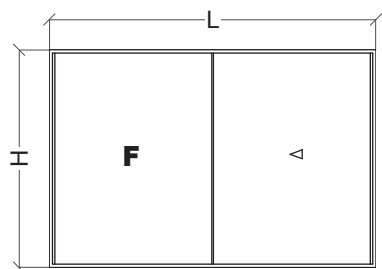

Perfis

Desenho	Ref	Descrição	Corte	Quant	Medida
	KL-01	Aro fixo		2	L
				2	H
	KL-02	Aro central		2	H-105 mm
	KL-03	Aro lateral		2	H-106 mm
	KL-04	Tampa fixa		4	(L/2)-60 mm
				2	H-94 mm
	KL-05/RD	Guia com rolamentos		1	L (a dividir)
	KL-05	Perfil suporte folha fixa		1	L-50 mm
	KL-06*	Separador fixo		2	L-68 mm
				2	H-68 mm
	KL-07	Perfil para colar no vidro		4	(L/2)-62 mm
				4	H-77 mm
	KL-08	Vareta poliamida		1	H-400 mm
	KL-13	Perfil tampa		1	H-62 mm
				1	H-49 mm

* preferencialmente cortar juntamente com o perfil KL-01

Acessórios e Juntas

Referência	Descrição	Quantidade
30 94 60 11	Esquadro aro fixo	8
30 96 00 22	Esquadro de alinhamento	8
30 94 60 0X	Cremona	1
30 94 60 16	Suplemento para fecho	1
30 94 60 15	Batente Kristal	4
30 94 60 14	Conjunto fecho Kristal**	2 ou 4
30 94 60 02	União vareta***	2 ou 6
30 94 60 17	Conjunto topo lateral Kristal	2
30 94 60 03	Corta-vento central	2
30 94 60 13	Cantoneira de apoio	2
30 94 50 20	Limitador de abertura	1
30 93 05 00	Junta central Kristal	2H
30 94 60 12	Pelúcia tri-fin	8L+6H

** vãos até altura de 1600 mm considerar 4 conjuntos e 4 uniões

*** vãos com altura >1600 mm considerar 8 conjuntos e 12 uniões

Vidro

+0 -1 mm	+0 -1 mm
Hv = H-84 mm	Lv = (L/2)-70 mm

Altura Hv e largura Lv dos vidros com tolerância de +0/-1 mm

Selagem secundária do vidro duplo em silicone

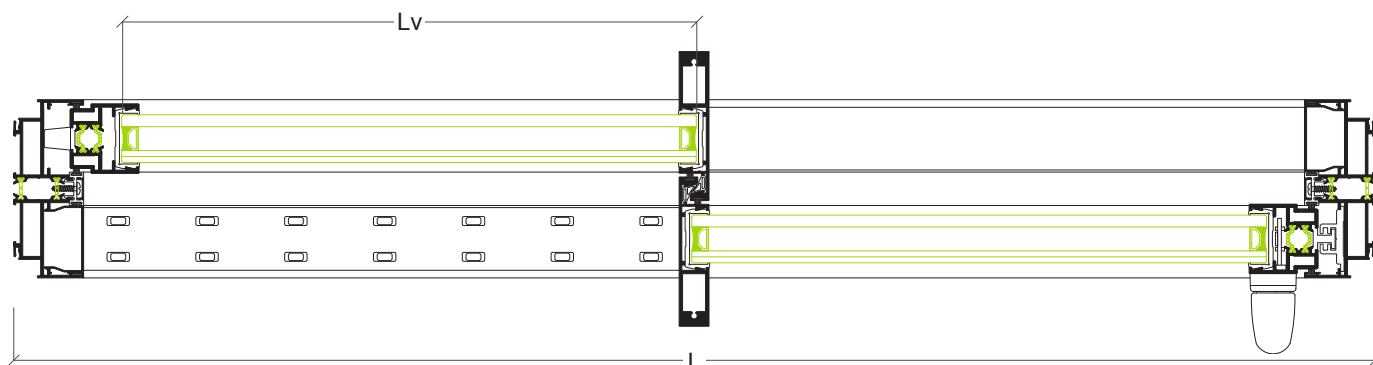

Aplicar vidro duplo com bordos arestados

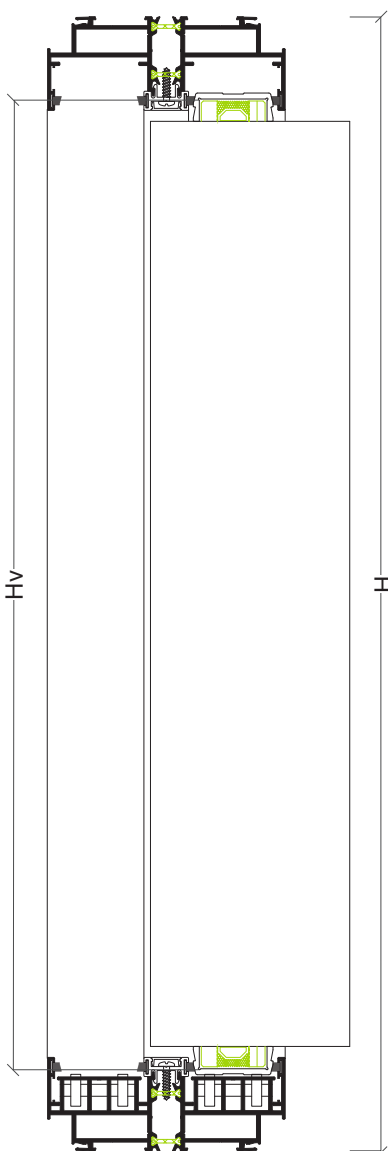
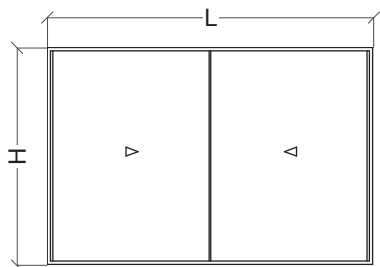

Janela 2 folhas correr



Perfis

Desenho	Ref	Descrição	Corte	Quant	Medida
	KL-01	Aro fixo		2	L
				2	H
	KL-02	Aro central		2	H-105 mm
	KL-03	Aro lateral		2	H-106 mm
	KL-04	Tampa fixa		4	(L/2)-60 mm
				2	H-94 mm
	KL-05/RD	Guia com rolamentos		2	L (a dividir)
	KL-06*	Separador fixo		2	L-68 mm
				2	H-68 mm
	KL-07	Perfil para colar no vidro		4	(L/2)-62 mm
				4	H-77 mm
	KL-08	Vareta poliamida		1	H-400 mm
	KL-13	Perfil tampa		1	H-49 mm

* preferencialmente cortar juntamente com o perfil KL-01

Acessórios e Juntas

Referência	Descrição	Quantidade
30 94 60 11	Esquadro aro fixo	8
30 96 00 22	Esquadro de alinhamento	8
30 94 60 0X	Cremona	2
30 94 60 16	Suplemento para fecho	2
30 94 60 15	Batente Kristal	4
30 94 60 14	Conjunto fecho Kristal**	4 ou 8
30 94 60 02	União vareta***	4 ou 12
30 94 60 17	Conjunto topo lateral Kristal	2
30 94 60 03	Corta-vento central	2
30 94 60 13	Cantoneira de apoio	2
30 94 50 20	Limitador de abertura	2
30 93 05 00	Junta central Kristal	2H
30 94 60 12	Pelúcia tri-fin	8L+6H

** vãos até altura de 1600 mm considerar 4 conjuntos e 4 uniões

*** vãos com altura >1600 mm considerar 8 conjuntos e 12 uniões

Vidro

+0 -1 mm	+0 -1 mm
Hv = H-84 mm	Lv = (L/2)-70 mm

Altura Hv e largura Lv dos vidros com tolerância de +/-1 mm

Selagem secundária do vidro duplo em silicone

Aplicar vidro duplo com bordos arestados

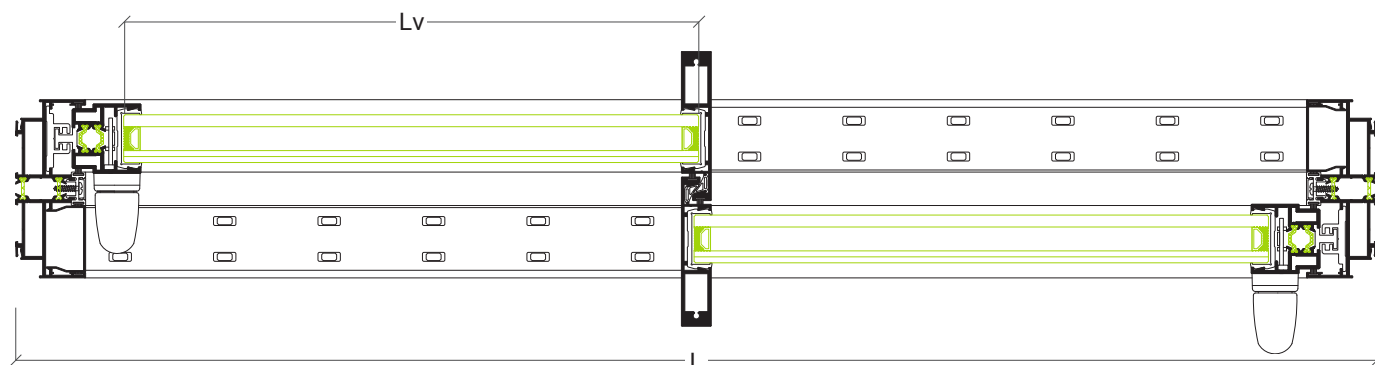

Janela 3 folhas correr

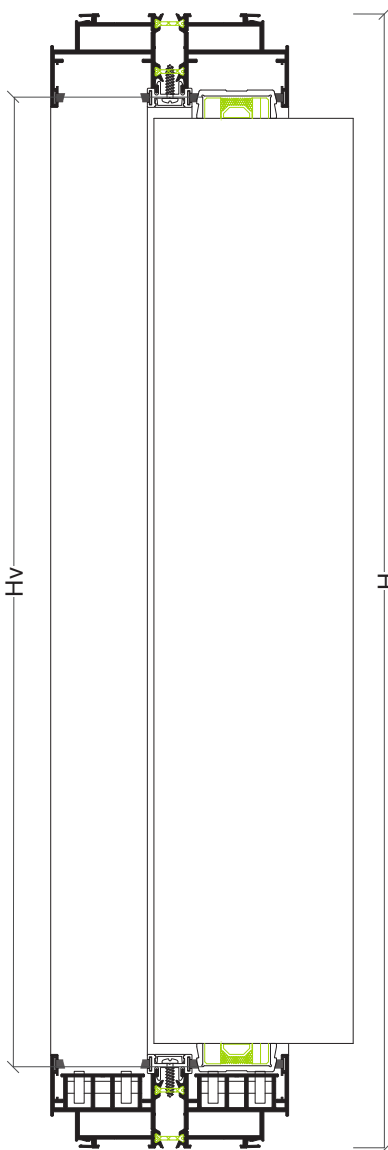
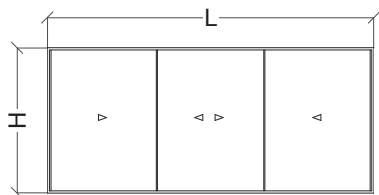

Perfis

Desenho	Ref	Descrição	Corte	Quant	Medida
	KL-01	Aro fixo		2	L
				2	H
	KL-02	Aro central		4	H-105 mm
	KL-03	Aro lateral		2	H-106 mm
	KL-04	Tampa fixa		4	(L/2)-60 mm
				2	H-94 mm
	KL-05/RD	Guia com rolamentos		2	L (a dividir)
	KL-06*	Separador fixo		2	L-68 mm
				2	H-68 mm
	KL-07	Perfil para colar no vidro		6	(L/3)-37.5 mm
				6	H-77 mm
	KL-08	Vareta poliamida		2	H-400 mm
	KL-13	Perfil tampa		2	H-49 mm

* preferencialmente cortar juntamente com o perfil KL-01

Acessórios e Juntas

Referência	Descrição	Quantidade
30 94 60 11	Esquadro aro fixo	8
30 96 00 22	Esquadro de alinhamento	8
30 94 60 0X	Cremona	2
30 94 60 16	Suplemento para fecho	2
30 94 60 15	Batente Kristal	4
30 94 60 14	Conjunto fecho Kristal**	4 ou 8
30 94 60 02	União vareta***	4 ou 12
30 94 60 17	Conjunto topo lateral Kristal	2
30 94 60 03	Corta-vento central	4
30 94 60 13	Cantoneira de apoio	4
30 94 50 20	Limitador de abertura	1
30 93 05 00	Junta central Kristal	4H
30 94 60 12	Pelúcia tri-fin	8L+6H

** vãos até altura de 1600 mm considerar 4 conjuntos e 4 uniões

*** vãos com altura >1600 mm considerar 8 conjuntos e 12 uniões

Vidro

+0 -1 mm Hv = H-84 mm	+0 -1 mm Lv = (L/3)-46 mm
-----------------------------	---------------------------------

Altura Hv e largura Lv dos vidros com tolerância de +0/-1 mm

Selagem secundária do vidro duplo em silicone

Aplicar vidro duplo com bordos arestados

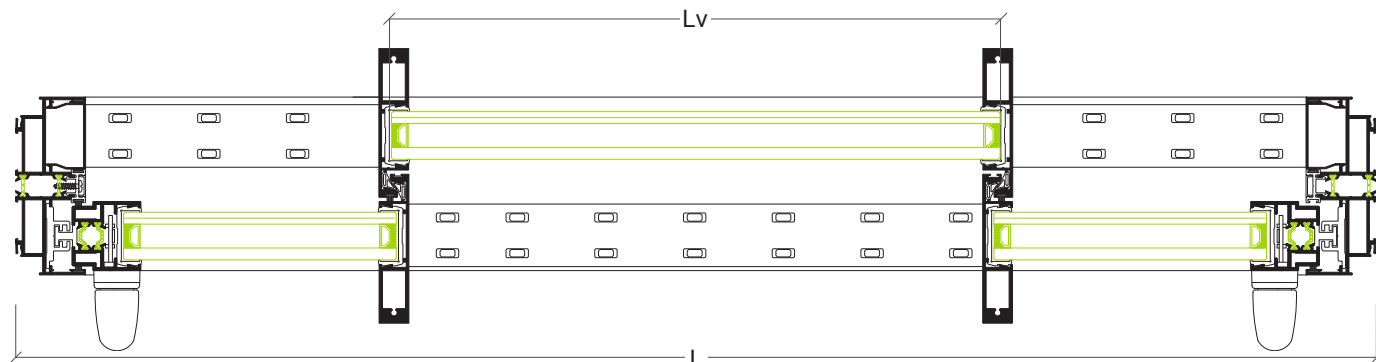

Janela 3 folhas correr tri-rail

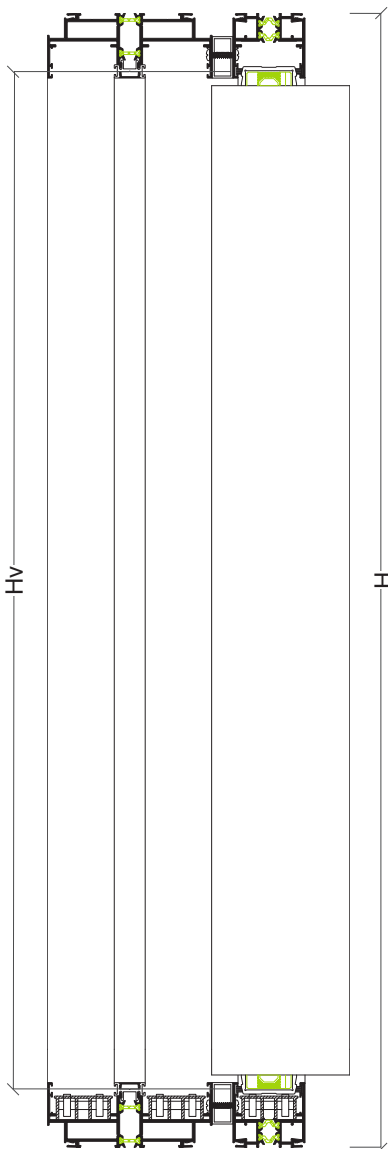
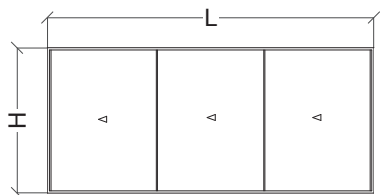

Perfis

Desenho	Ref	Descrição	Corte	Quant	Medida
	KL-01	Aro fixo		2	L
				2	H
	KL-02	Aro central		4	H-105 mm
	KL-03	Aro lateral		2	H-106 mm
	KL-04	Tampa fixa		4	(L/2)-60 mm
				2	H-94 mm
	KL-05/RD	Guia com rolamentos		2	(a dividir)
	KL-06*	Separador fixo		2	L-68 mm
				2	H-68 mm
	KL-07	Perfil para colar no vidro		6	(L/3)-37.5 mm
				6	H-77 mm
	KL-08	Vareta poliamida		2	H-400 mm
	KL-10	Aro fixo		2	L
				2	H
	P-02	Perfil de ligação		2+2	L-7 mm / H-94 mm
	KL-13	Perfil tampa		2	H-49 mm

* preferencialmente cortar juntamente com o perfil KL-01

Acessórios e Juntas

Referência	Descrição	Quantidade
30 94 60 11	Esquadro aro fixo	8
30 96 00 22	Esquadro de alinhamento	8
30 94 60 0X	Cremone	2
30 94 60 16	Suplemento para fecho	2
30 94 60 15	Batente Kristal	4
30 94 60 14	Conjunto fecho Kristal**	4 ou 8
30 94 60 02	União vareta***	4 ou 12
30 94 60 17	Conjunto topo lateral Kristal	2
30 94 60 03	Corta-vento central	4
30 94 60 13	Cantoneira de apoio	4
30 93 05 00	Junta central Kristal	4H
30 94 60 12	Pelúcia tri-fin	8L+8H
30 94 50 20	Limitador de abertura	1
30 96 00 48	Esquadro aro fixo KL-10	8
30 96 00 55	Perno para esquadro KL-10 (opcional)	8

** vãos até altura de 1600 mm considerar 4 conjuntos e 4 uniões
*** vãos com altura >1600 mm considerar 8 conjuntos e 12 uniões

Vidro

+0 -1 mm Hv = H-84 mm	+0 -1 mm Lv = (L/3)-46 mm
-----------------------------	---------------------------------

Altura Hv e largura Lv dos vidros com tolerância de +/-1 mm

Selagem secundária do vidro duplo em silicone
Aplicar vidro duplo com bordos arestados

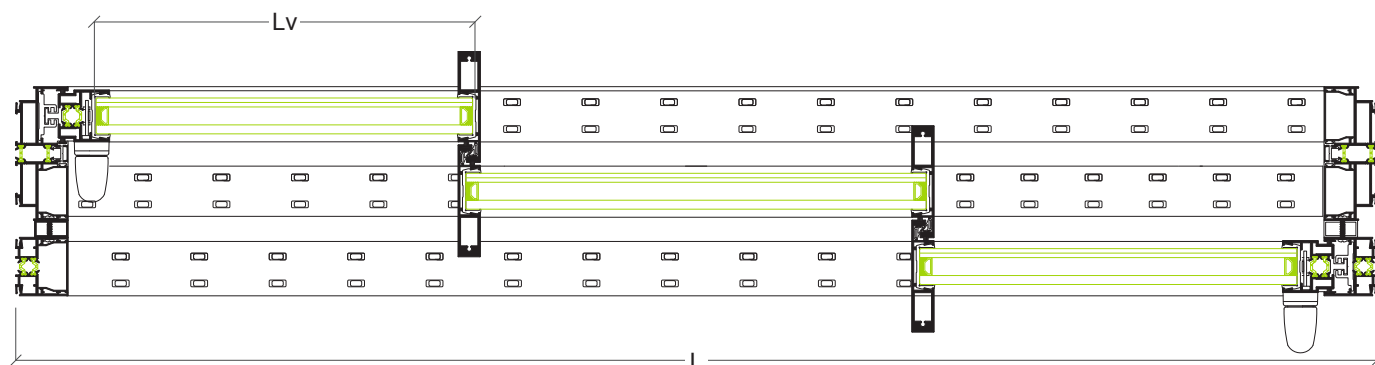

Janela 4 folhas correr

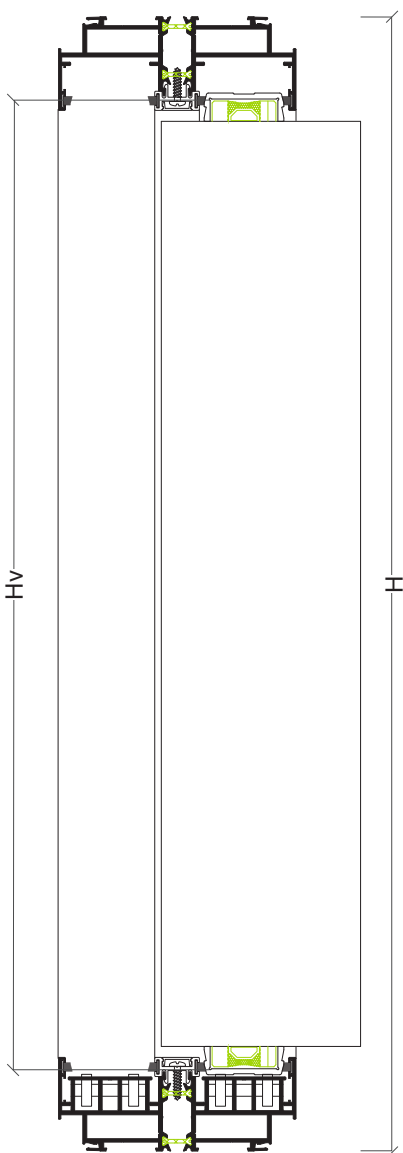
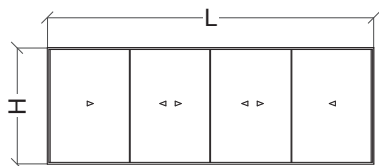

Perfis

Desenho	Ref	Descrição	Corte	Quant	Medida
	KL-01	Aro fixo		2	L
				2	H
	KL-02	Aro central		4	H-105 mm
	KL-12	Aro central 3/4 folhas		2	H-105 mm
	KL-03	Aro lateral		2	H-106 mm
	KL-04	Tampa fixa		4	(L/2)-60 mm
				2	H-94 mm
	KL-05/RD	Guia com rolamentos		2	L (a dividir)
	KL-06*	Separador fixo		2	L-68 mm
				2	H-68 mm
	KL-07	Perfil para colar no vidro		8	(L/4)-25 mm
				8	H-77 mm
	KL-08	Vareta poliamida		2	H-400 mm
	KL-13	Perfil tampa		2	H-49 mm

* preferencialmente cortar juntamente com o perfil KL-01

Acessórios e Juntas

Referência	Descrição	Quantidade
30 94 60 11	Esquadro aro fixo	8
30 96 00 22	Esquadro de alinhamento	8
30 94 60 0X	Cremona	2
30 94 60 16	Suplemento para fecho	2
30 94 60 15	Batente Kristal	4
30 94 60 14	Conjunto fecho Kristal**	4 ou 8
30 94 60 02	União vareta***	4 ou 12
30 94 60 17	Conjunto topo lateral Kristal	2
30 94 60 03	Corta-vento central	6
30 94 60 13	Cantoneira de apoio	6
30 94 50 20	Limitador de abertura	2
30 93 05 00	Junta central Kristal	6H
30 94 60 12	Pelúcia tri-fin	8L+10H
30 94 60 XX	Fecho liso interior	2
30 24 30 75	Contra fecho inox	2
30 94 60 2X	Conjunto puxador de 3/4 folhas	1
30 94 60 31	Conjunto varão alumínio 3 mts	1
30 94 60 34	Contra-fecho central	2

** vãos até altura de 1600 mm considerar 4 conjuntos e 4 uniões

*** vãos com altura >1600 mm considerar 8 conjuntos e 12 uniões

Vidro

+0	+0
-1 mm	-1 mm
Hv = H-84 mm	Lv = (L/4)-34 mm

Altura Hv e largura Lv dos vidros com tolerância de +/-1 mm

Selagem secundária do vidro duplo em silicone



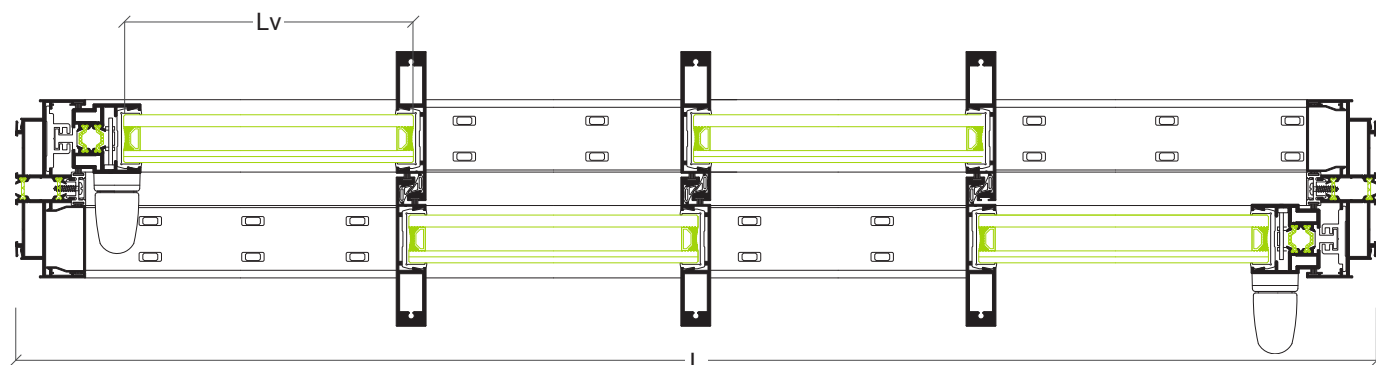



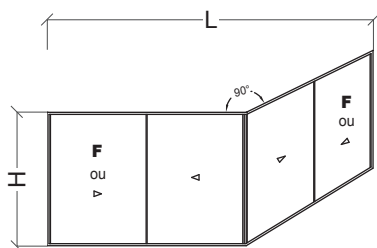



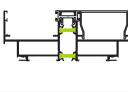



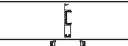











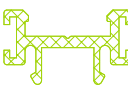





Aplicar vidro duplo com bordos arestados



Janela 2+2 folhas canto 90°

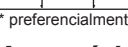

Perfis

Desenho	Ref	Descrição	Corte	Quant	Medida
	KL-01	Aro fixo		1	L1
				1	L2
				2	H
	KL-02	Aro central		4	H-105 mm
	KL-03	Aro lateral		3	H-106 mm
	KL-04	Tampa fixa		2	(L1/2)-65 mm
				2	(L1/2)-56 mm
				2	(L2/2)-65 mm
				2	(L2/2)-56 mm
	KL-05/RD	Guia com rolamentos		2	L1 (a dividir)
				2	L2 (a dividir)
	KL-06*	Separador fixo		2	L1-88 mm
				2	H-68 mm
				2	H-68 mm
	KL-07	Perfil para colar no vidro		8	(L1/2)-71.5 mm
				4	(L2/2)-54mm
				4	H-77 mm
	KL-08	Vareta poliamida		3	H-400 mm
	KL-11	Perfil canto		2	H-106 mm
	KL-04	Tampa fixa		1	H-106 mm
	KL-13	Perfil tampa		2	H-49 mm

* preferencialmente cortar juntamente com o perfil KL-01

Acessórios e Juntas

Referência	Descrição	Quantidade
30 94 60 11	Esquadro aro fixo	8
30 96 00 22	Esquadro de alinhamento	8
30 94 60 0X	Cremone	3
30 94 60 16	Suplemento para fecho	3
30 94 60 15	Batente Kristal	6
30 94 60 14	Conjunto fecho Kristal**	6 ou 12
30 94 60 02	União vareta***	6 ou 18
30 94 60 17	Conjunto topo lateral Kristal	3
30 94 60 03	Corta-vento central	4
30 94 60 13	Cantoneira de apoio	4
30 93 05 00	Junta central Kristal	4H
30 94 60 12	Pelúcia tri-fin	8L1+8L2+10H
30 94 50 20	Limitador de abertura	2
30 94 60 18	Conjunto topo canto 90°	1
30 94 60 33	Esquadro para canto 90°	4

** vãos até altura de 1600 mm considerar 4 conjuntos e 4 uniões

*** vãos com altura >1600 mm considerar 8 conjuntos e 12 uniões

Vidro

+0 -1 mm Hv = H-84 mm	+0 -1 mm L1v = (L1/2)-80 mm L2v = (L2/2)-62 mm
-----------------------------	---

Altura Hv e largura Lv dos vidros com tolerância de +/-1 mm

Selagem secundária do vidro duplo em silicone

Aplicar vidro duplo com bordos arestados

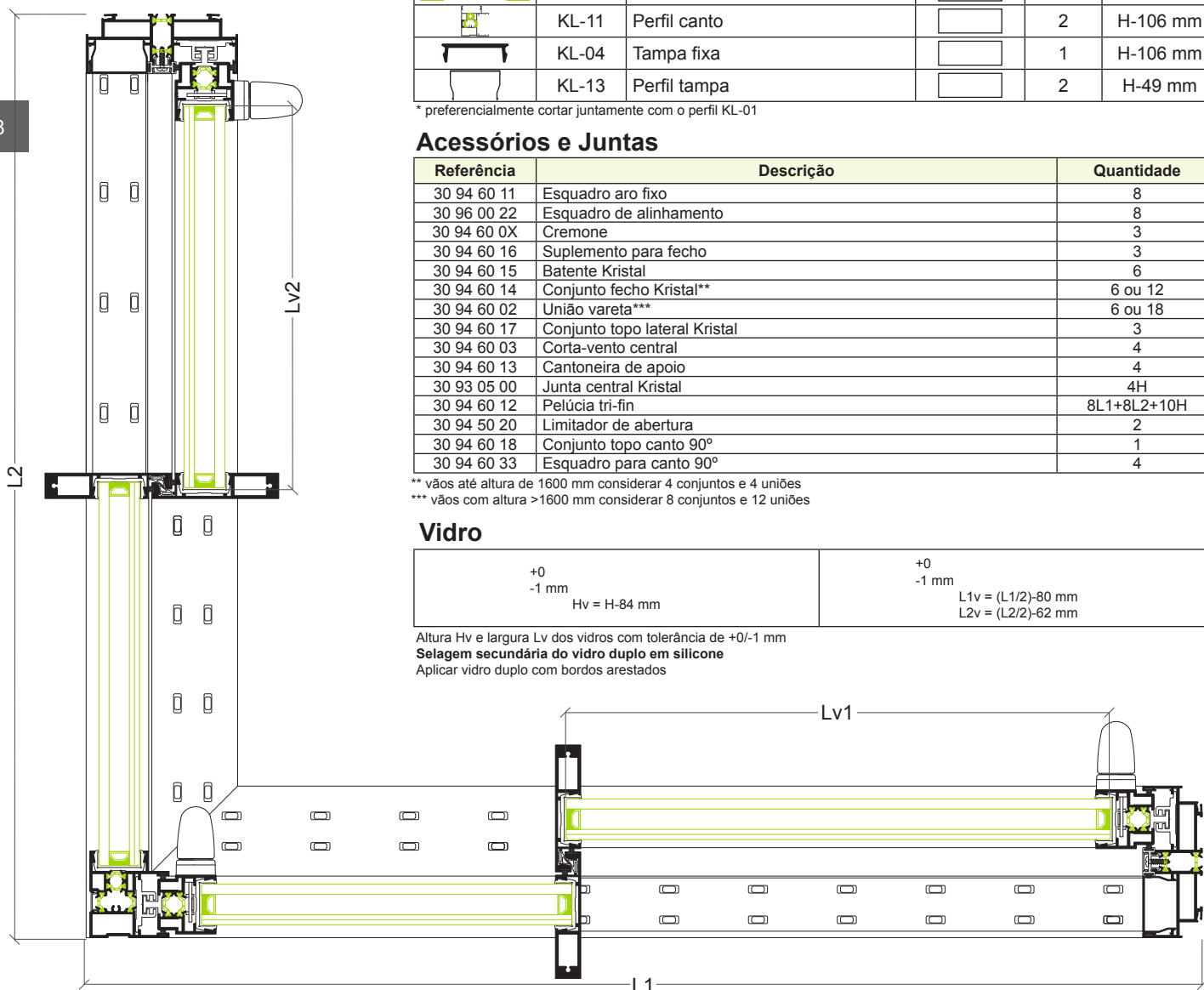

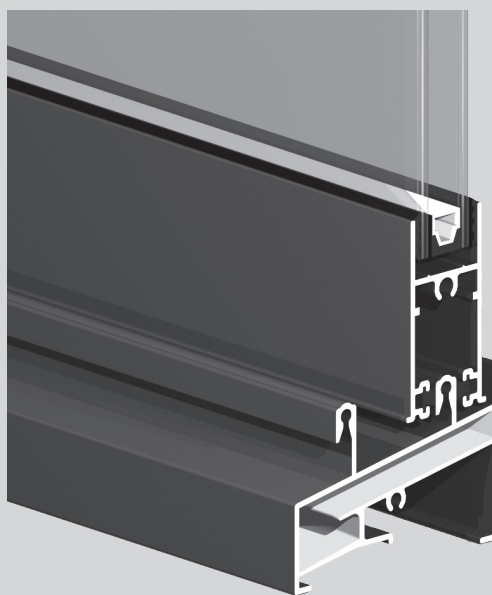

Sistema
CL

Sistema CL

Sistema de correr - 78 mm

Características dos sistemas CL/CL Plus

Sistemas de alumínio para execução de vãos de correr ou janelas duplas com rotura térmica.

Perfis de alumínio

Os perfis de alumínio são extrudidos na liga de alumínio 6060 para arquitetura de acordo com norma NP EN 12020-02.

Aros fixos

Secção do aro fixo de 2 guias de 70 mm para montagem a corte recto;
Secção do aro fixo janela dupla de 196 mm para montagem a corte recto.

Aros móveis

Secção dos aros móveis de 28 mm com montagem a corte recto;
Enchimento de 4 mm a 18 mm;
Estanquidade assegurada através de pelúcia tipo Fin-Seal.

Dimensionamento e manobralidade

Peso máximo de 80 kg por folha (com 2 rolamentos duplos);
Possibilidades de abertura: 2, 3 e 4 folhas, com folhas móveis e/ou fixas;
Rolamento duplo com regulação.

Performances

Sistema certificado por laboratório notificado do ensaio tipo inicial (ITT) de acordo com a norma de produto EN 14351-1 para efeitos de Marcação CE.

Categorias alcançadas na avaliação do sistema CL tipologia janela:

1. Permeabilidade ao ar: Classe 3 (norma de ensaio EN 1026)
2. Estanquidade à água: Classe 7A (norma de ensaio EN 1027)
3. Resistência ao vento: Classe C3 (norma de ensaio EN 12211)

Categorias alcançadas na avaliação do sistema CL tipologia porta:

1. Permeabilidade ao ar: Classe 3 (norma de ensaio EN 1026)
2. Estanquidade à água: Classe 7A (norma de ensaio EN 1027)
3. Resistência ao vento: Classe B2 (norma de ensaio EN 12211)

Coefficiente de transmissão térmica de vão de 2 folhas com 1.80 m x 2.20m com vidro $U_g = 1.8 \text{ W/m}^2\text{K}$ com intercalar efeito "Warm Edge":

- $U_w = 2.98 \text{ W/m}^2\text{K}$

Coefficiente de atenuação acústica de vão de 2 folhas com vidro 4/10/4 acústico:

- $R_w (C; C_{tr}) = 28 \text{ dB} (-1; -1)$

Zonas de aplicação segundo RCCTE (em função do valor U_g): I1, I2, I3, V1, V2, V3;

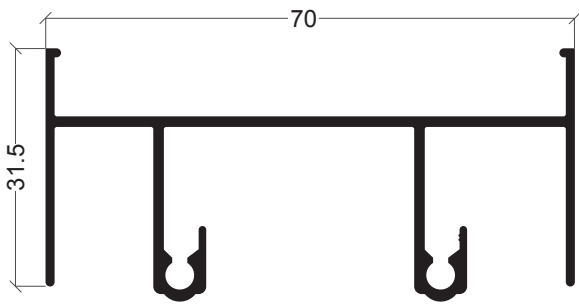

CL-05
Padeira

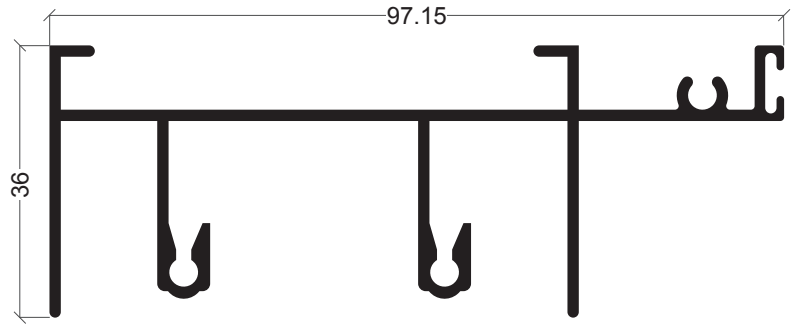

CL-15
Padeira

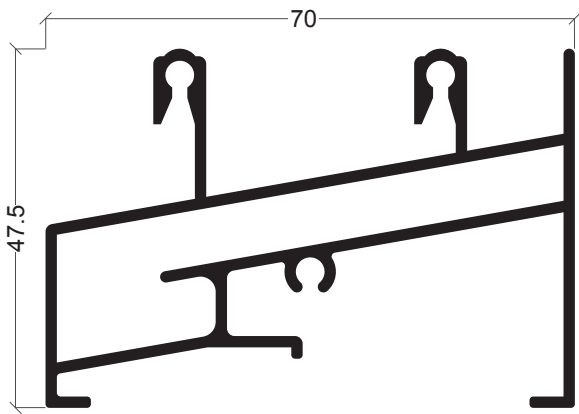

CL-01
Soleira

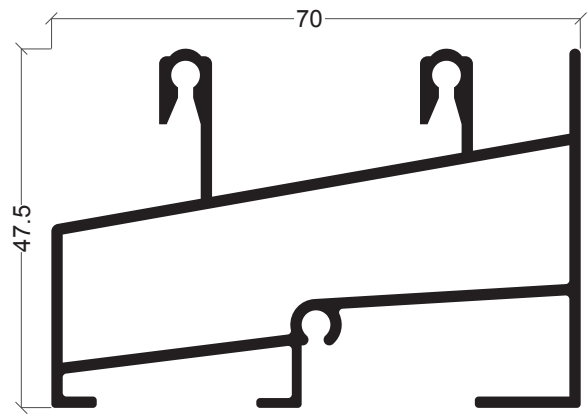

CL-03
Soleira

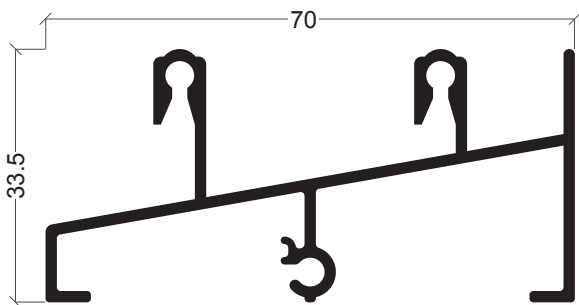

CL-61
Soleira

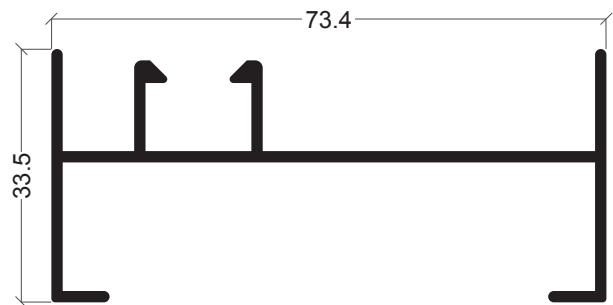

CL-06
Ombreira

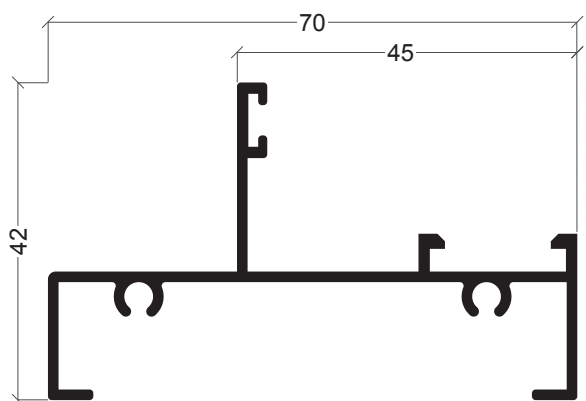

CL-58
Complemento fixo

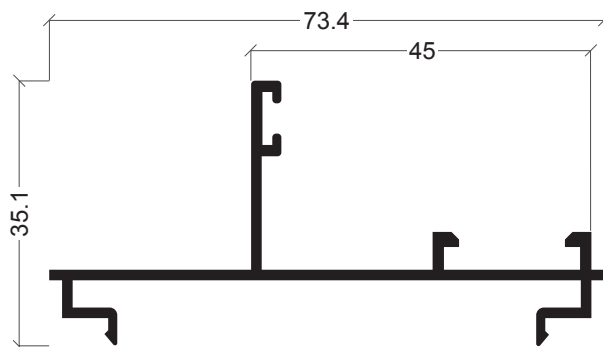

CL-39
Complemento fixo

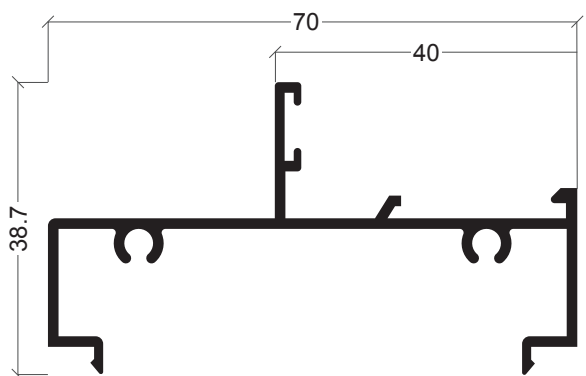

CL-18
Complemento fixo

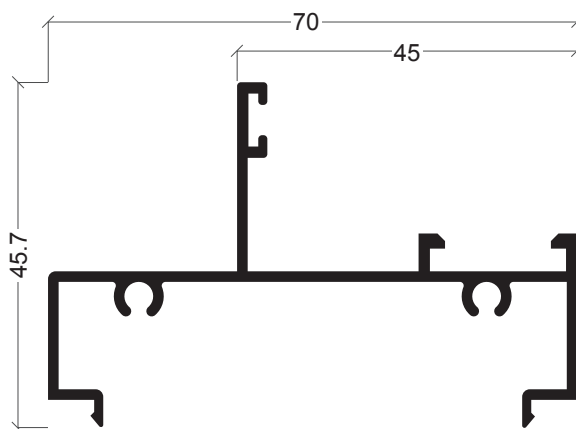

CL-08
Complemento fixo

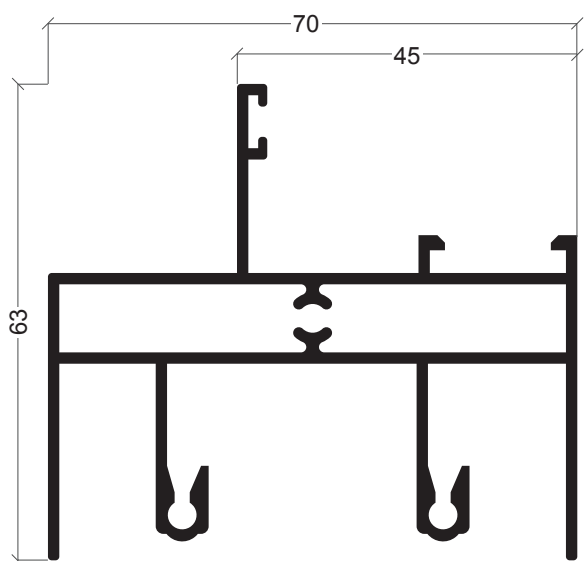

CL-55
Padeira fixo superior

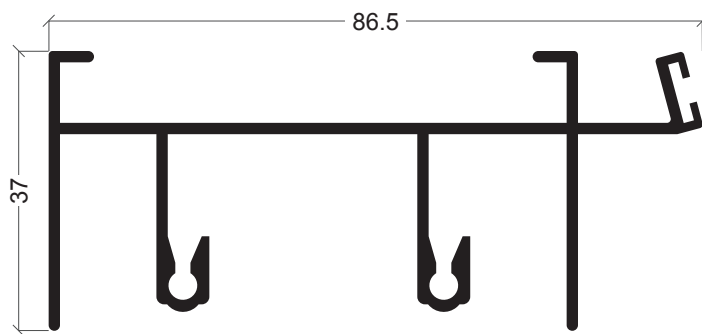

CL-75
Padeira janela dupla

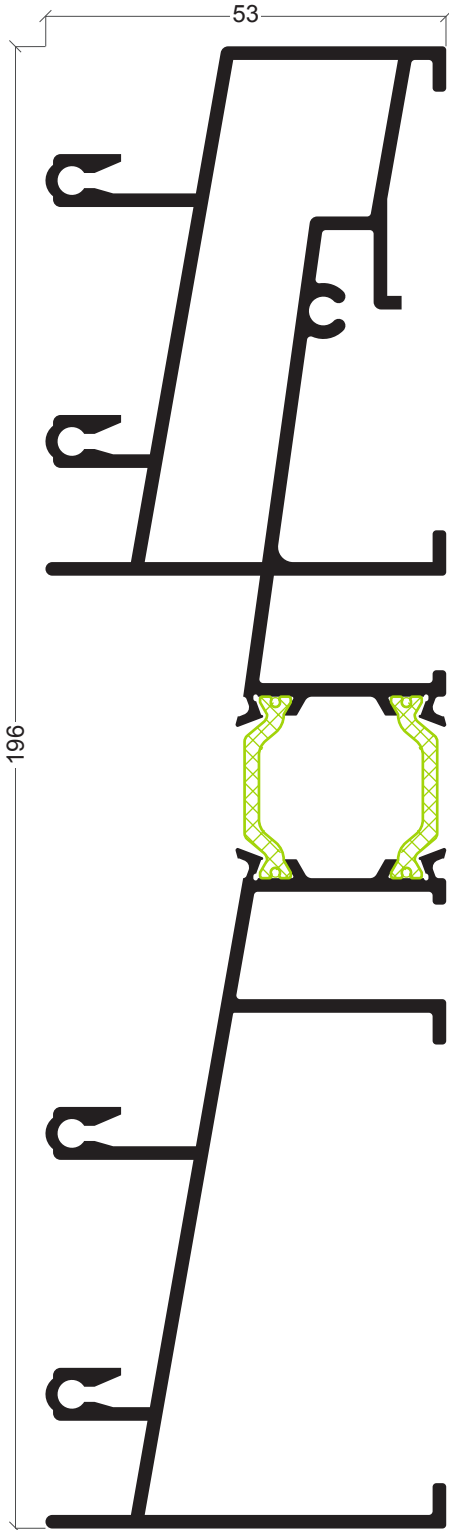

CL-71
Soleira janela dupla

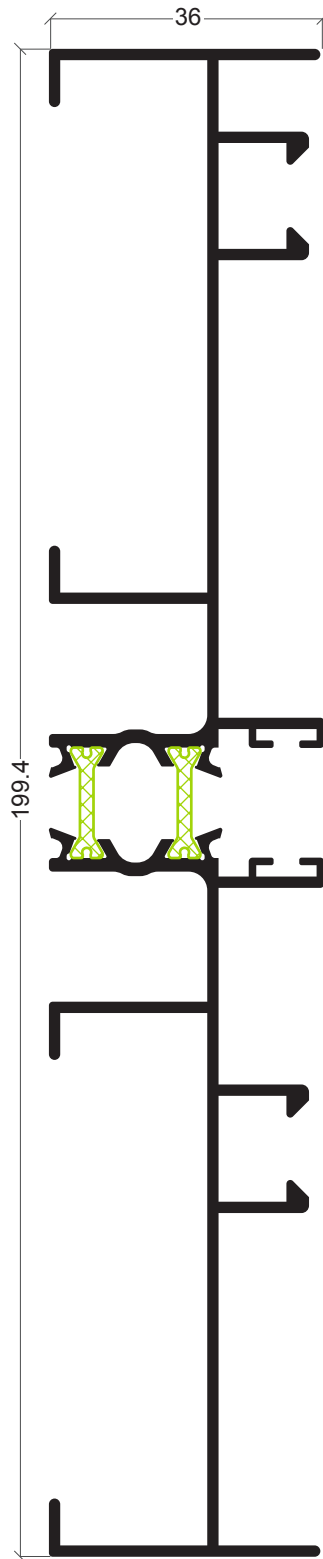

CL-76
Ombreira janela dupla

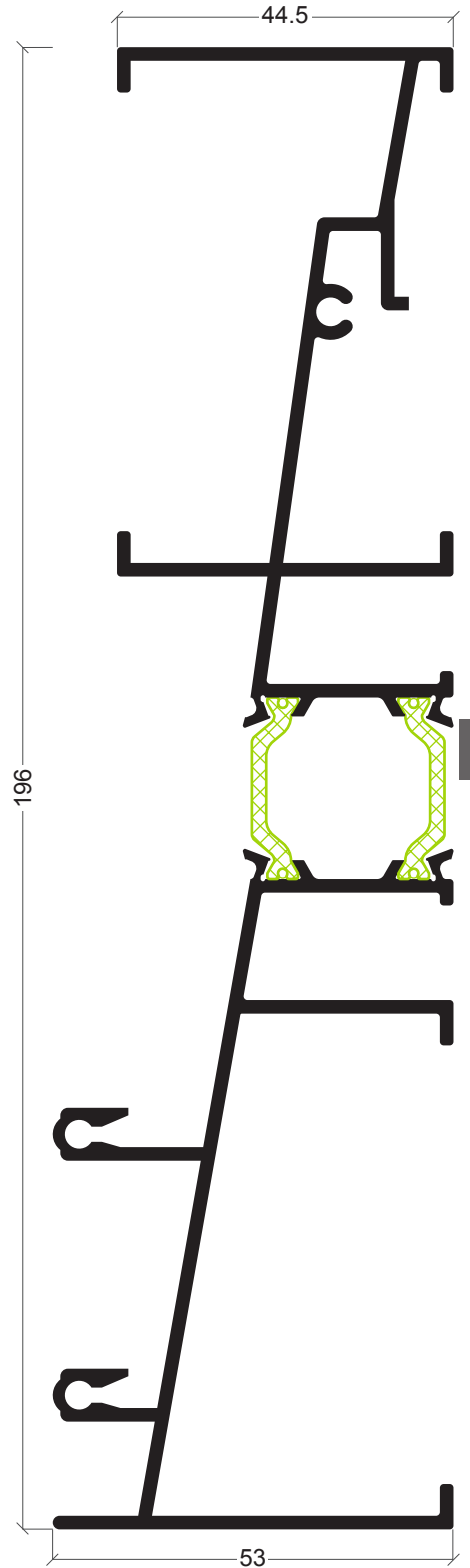

CL-78
Soleira janela dupla

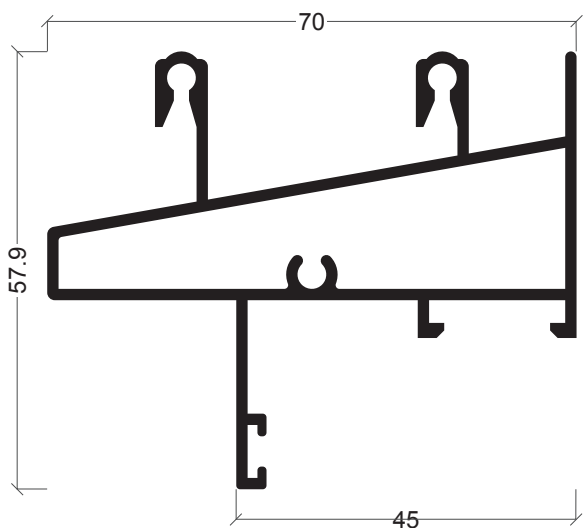

CL-51
Soleira fixo inferior

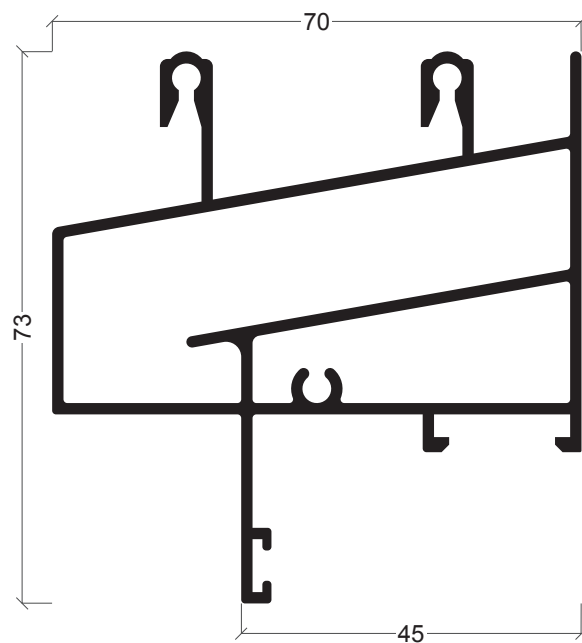

CL-81
Soleira fixo inferior

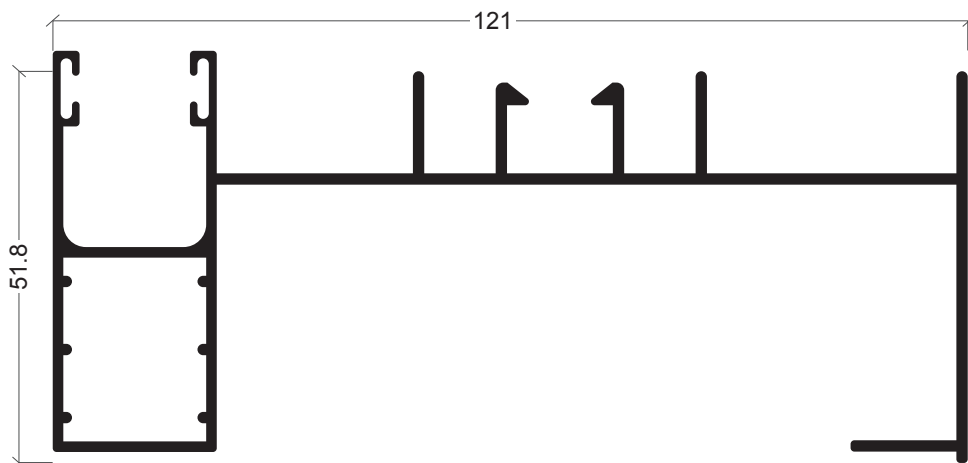

CL-91
Ombreira com calha persiana

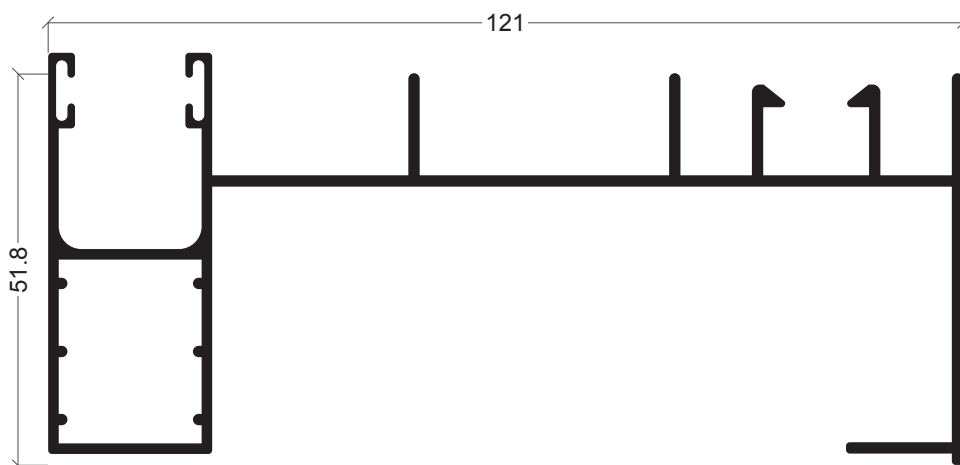

CL-92
Ombreira com calha persiana

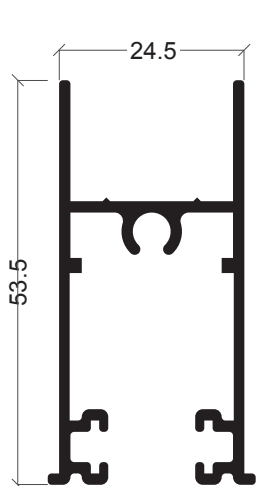

CL-10
Móvel carrinho

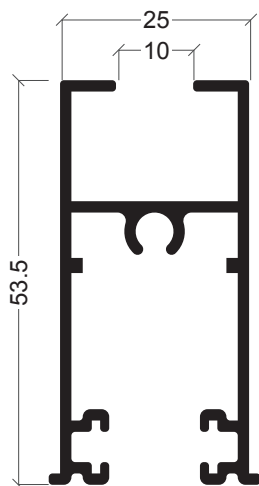

CL-12
Móvel carrinho

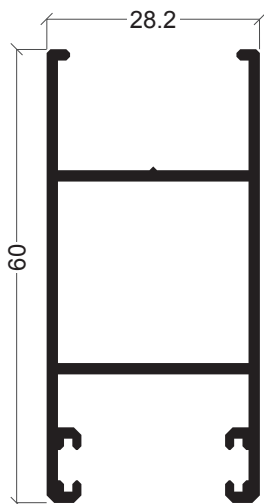

CL-90
Móvel lateral

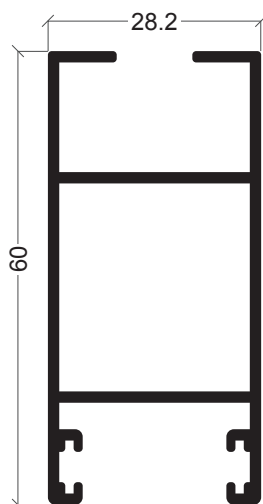

CL-19
Móvel lateral

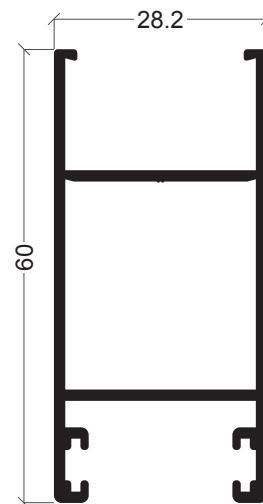

CL-20
Móvel lateral

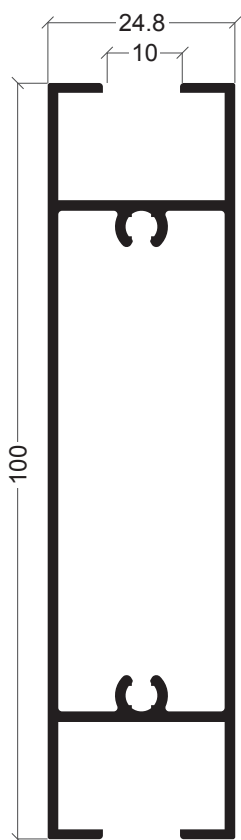

CL-25
Travessa

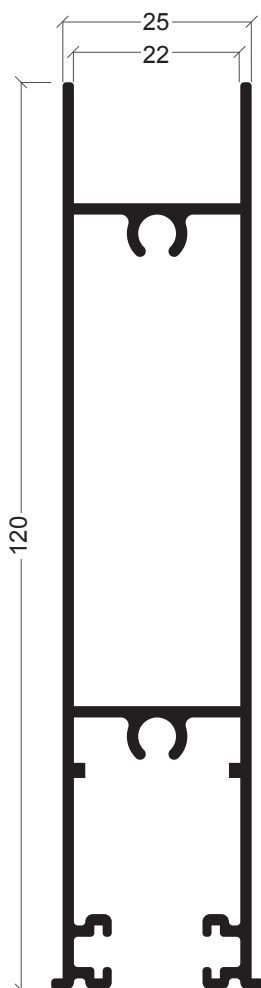

CL-52
Almofada carrinho

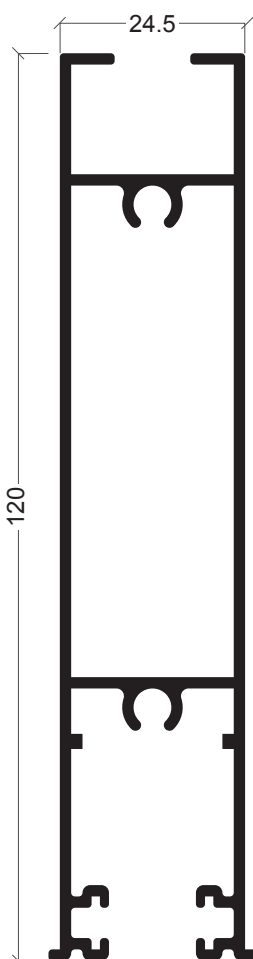

CL-72
Almofada carrinho

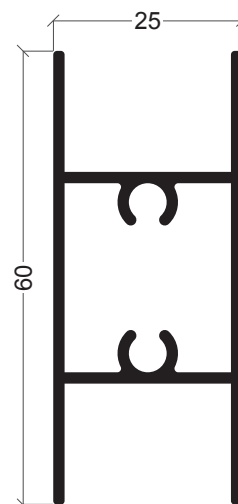

CL-53
Travessa

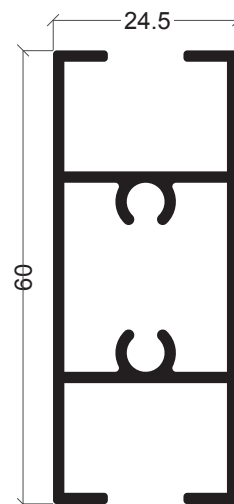

CL-73
Travessa

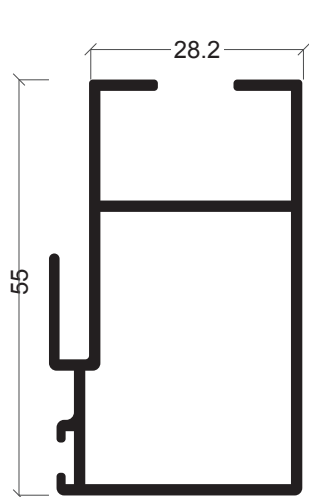

CL-17
Móvel central

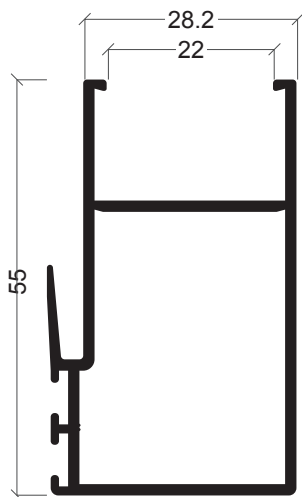

CL-09
Móvel central

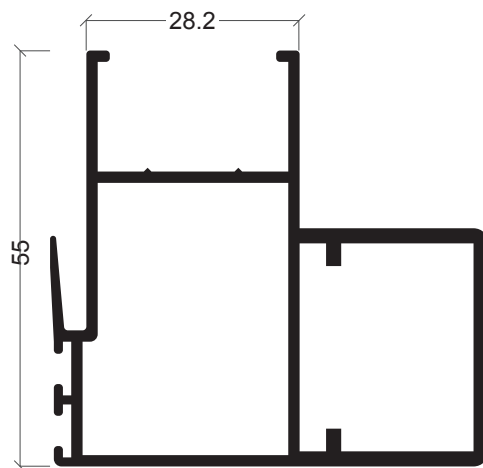

CL-27
Móvel central com reforço

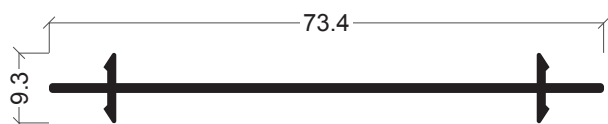

CL-31
União de aros

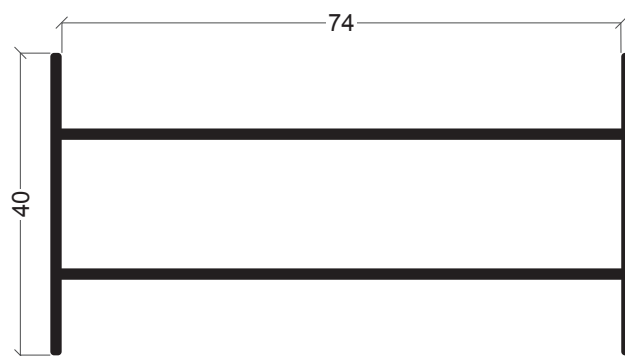

CL-32
União de aros

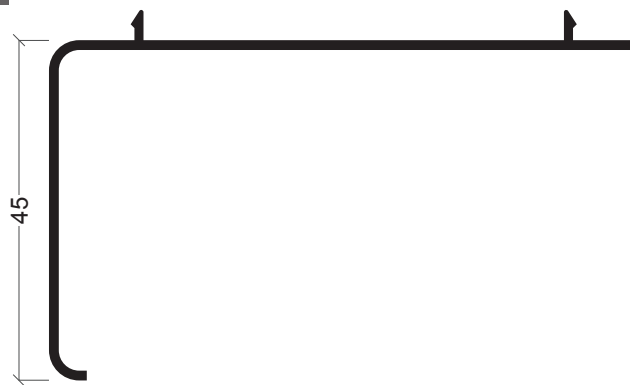

CL-26
Remate

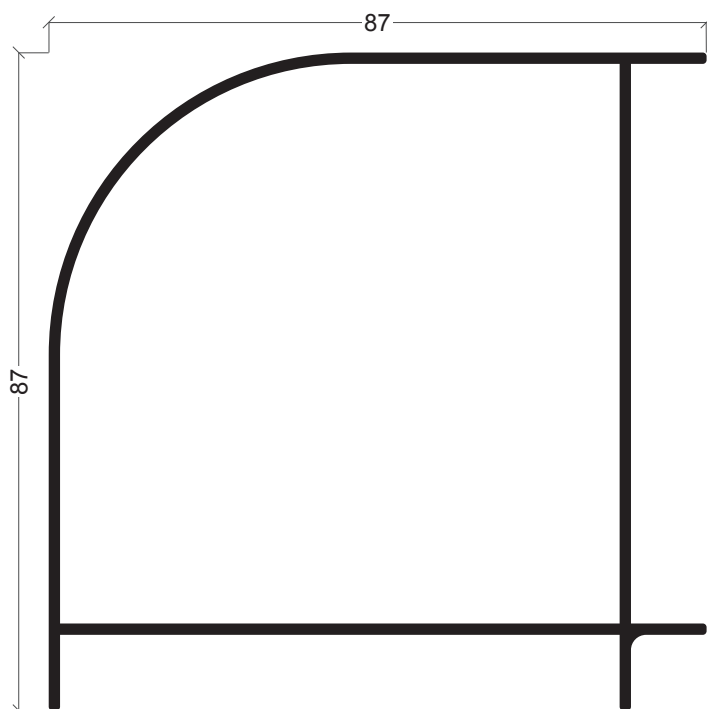

CL-30
Esquina

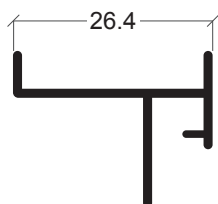

CL-57
Remate persiana

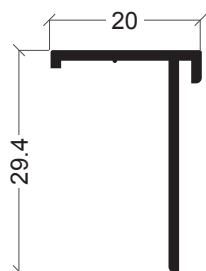

Y-24
Remate p/ apainelado

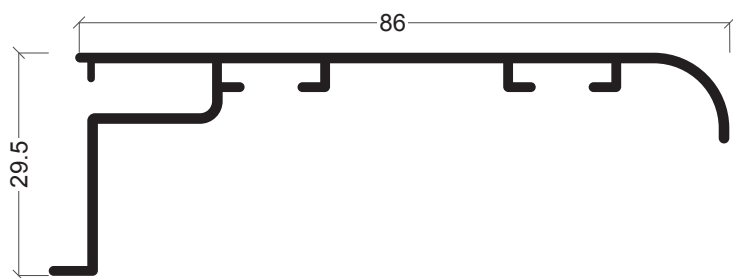

CL-54
Tapa juntas

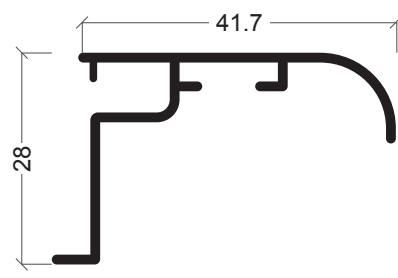

CL-56
Tapa juntas

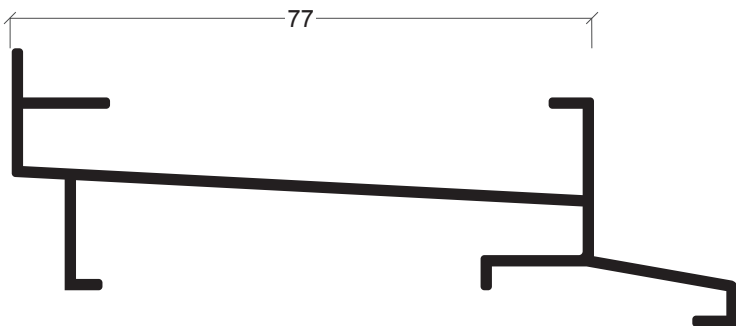

CL-02
Soleira de condensação

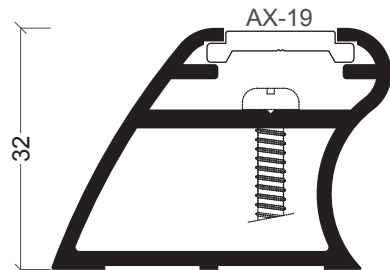

CT-27
Reforço

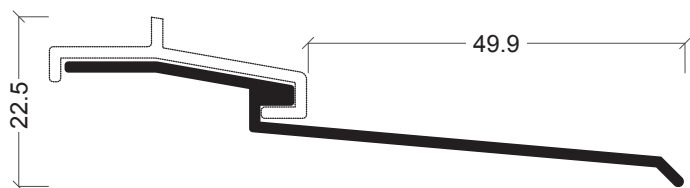

CL-22
Pingadeira

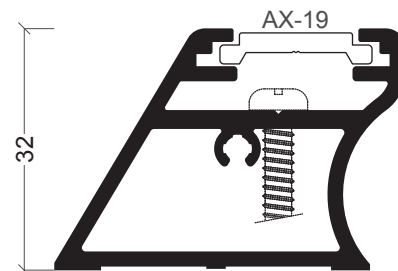

CT-28
Reforço



CL-11
Pingadeira

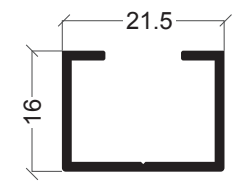

CL-29
Redutor



CL-21
Pingadeira

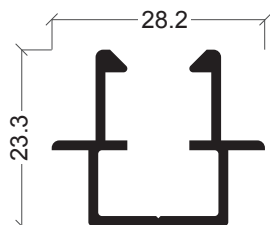

CL-28
União 3/4F



CL-23
Pingadeira



AX-19
Vareta

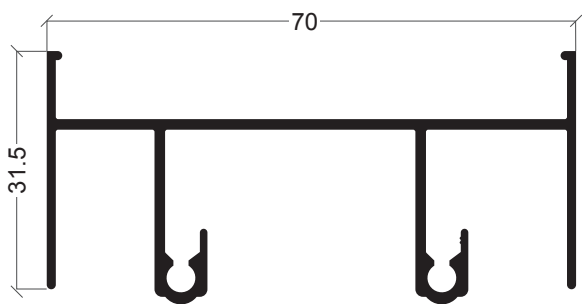

CL-05
Padieira

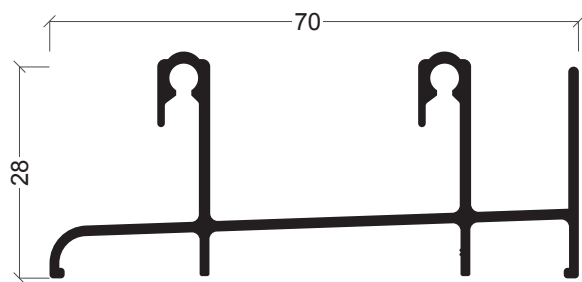

CL-42
Soleira

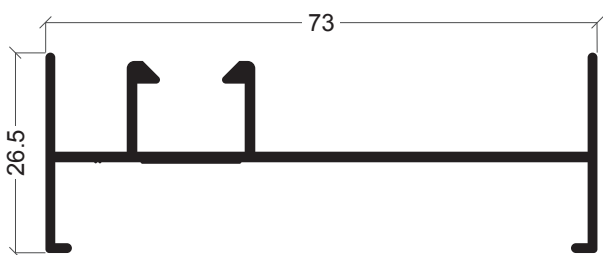

CL-43
Ombreira

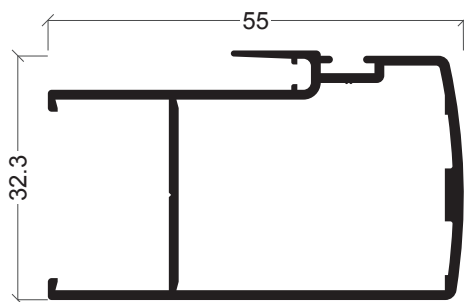

CL-48
Móvel central porta

358

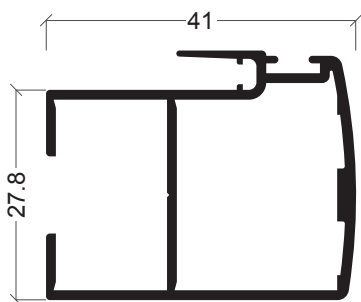

CL-33
Móvel central janela

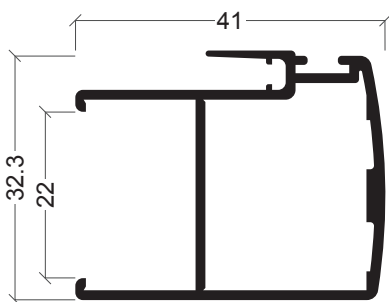

CL-45
Móvel central janela

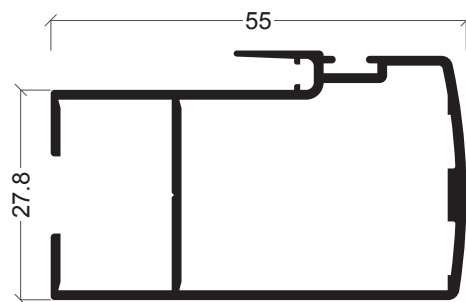

CL-59
Móvel central porta

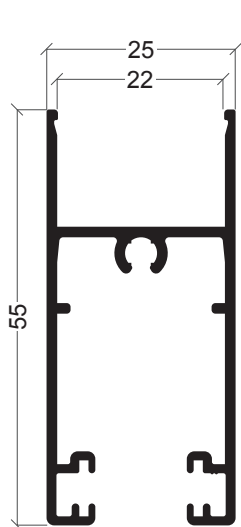

CL-47
Móvel carrinho

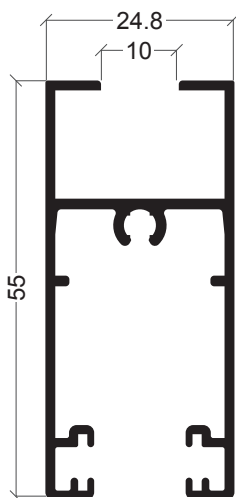

CL-40
Móvel carrinho

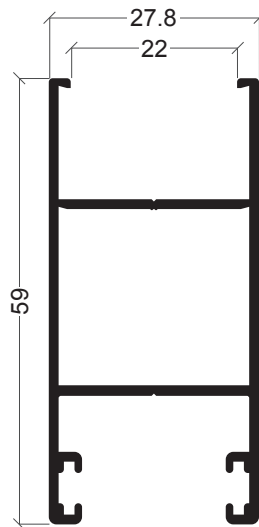

CL-44
Móvel lateral

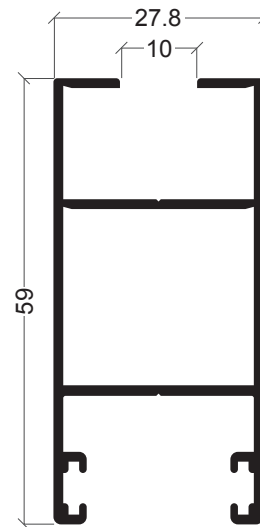

CL-34
Móvel lateral

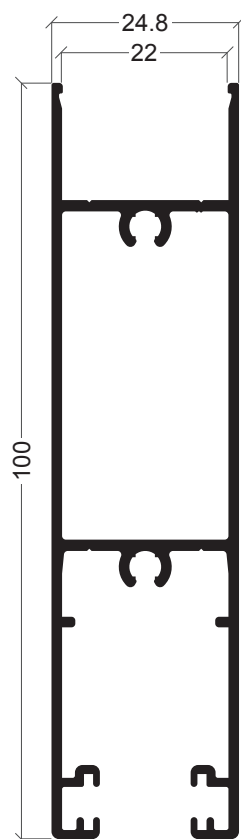

CL-49
Travessa

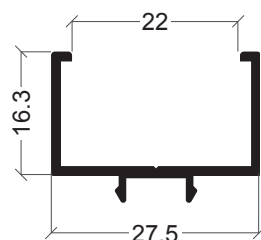

CL-50
Redutor

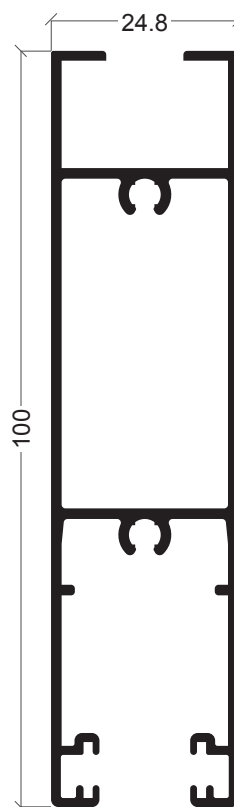

CL-24
Almofada

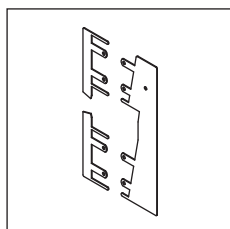

30 20 50 01

Jogo juntas estanquidade janela dupla

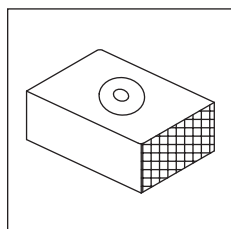

30 91 41 10

Taco anti-levantamento preto

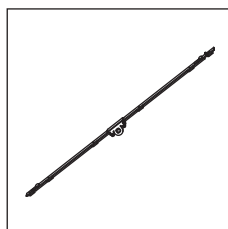

30 91 41 31

Barra 2 pontos com apoios (600 mm)

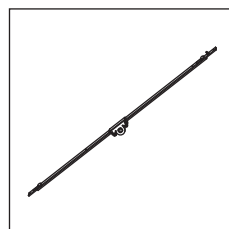

30 91 41 32

Barra 3 pontos com apoios (1670 mm)

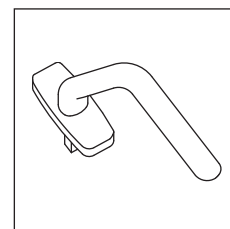

30 91 41 45/46

Cremona desviado direita branco/preto

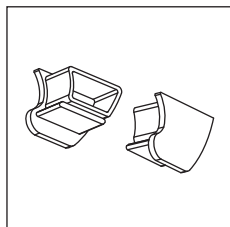

30 91 41 63/64

Jogo topos CT-27 (branco/preto)

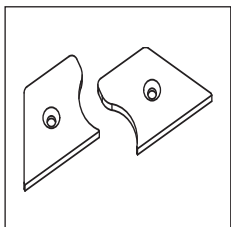

30 91 41 65/66

Jogo topos CT-28 (branco/preto)

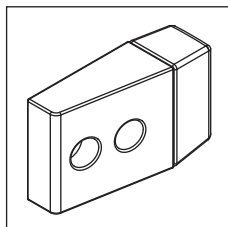

30 91 41 71

Topo limitador de abertura

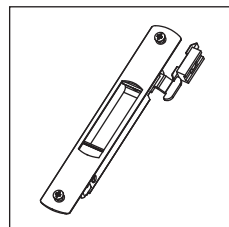

30 91 50 09/10

Fecho lateral (branco/preto)

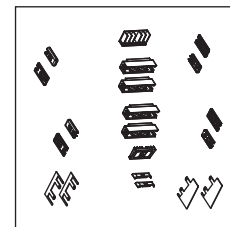

30 91 50 11

Kit CL 2 folhas

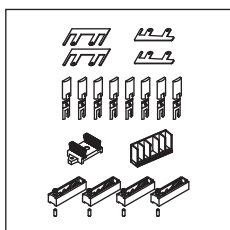

30 91 50 15

Kit correr janela 2 folhas CL-42

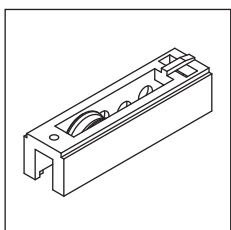

30 91 50 20

Rolamento simples CL-10/12/52/72

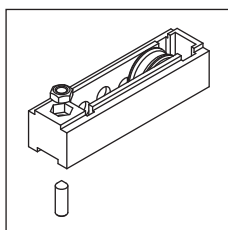

30 91 50 21

Rolamento simples CL Plus (40Kg por folha)

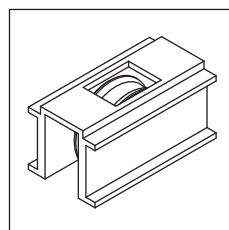

30 91 50 22

Rolamento simples CL-10/12/52/72

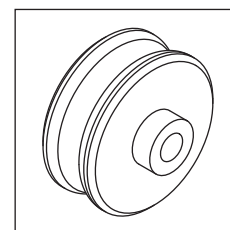

30 91 50 23

Rolamento suplementar (+20Kg por folha)

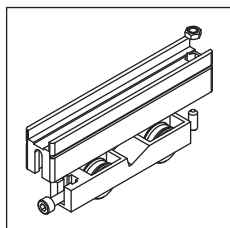

30 91 50 24

Rolamento duplo regulável (80Kg por folha)

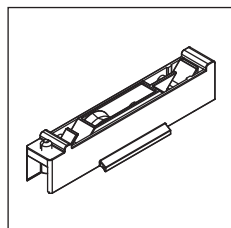

30 91 50 25

Rolamentos simples

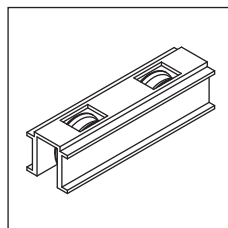

30 91 50 27

Rolamento duplo CL-10/12/52/72

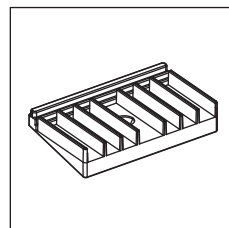

30 91 50 30

Corta-vento inferior CL

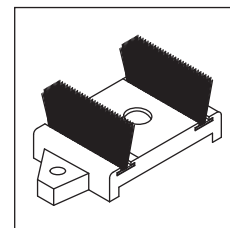

30 91 50 31

Corta ventos inferior CL-42

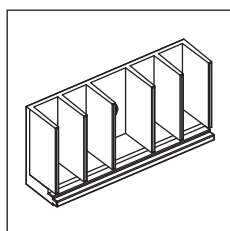

30 91 50 40

Corta-vento superior CL-05/15/75

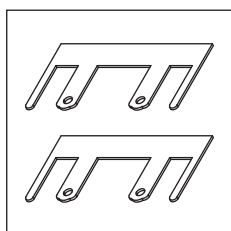

30 91 50 61

Junta estanquidade superior CL-05

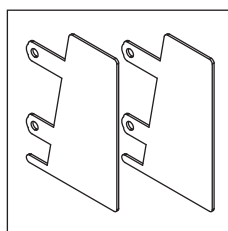

30 91 50 70

Junta estanquidade sup. CL-01/03/63

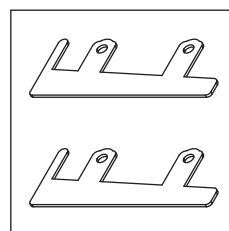

30 91 50 71

Junta estanquidade superior CL-42

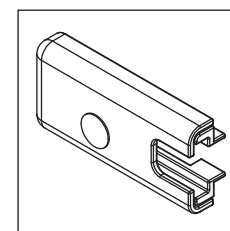

30 91 50 80

Tampa guia lateral CL

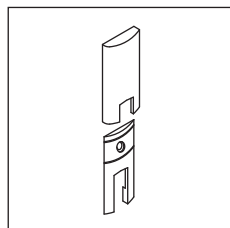

30 91 50 81

Jogo guias lateral CL Plus

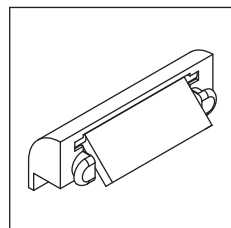

30 92 01 02/03

Goteiras preto / branco

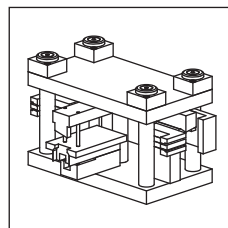





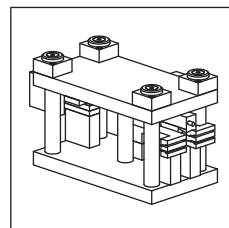





33 21 50 01

Cunho CL dupla



33 95 99 99







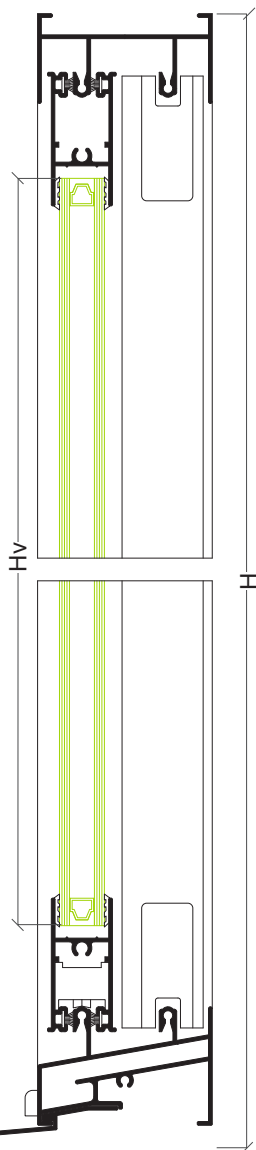
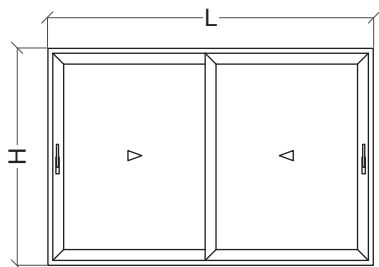







Cunho CL

Referência	Desenho	Descrição
30 91 50 86		Junta central
30 91 50 90		Junta U CL/CL Plus vidro 18 mm
30 93 00 65		Junta interior para vidro (5 mm)
30 93 00 66		Junta interior para vidro (4 mm)
30 93 00 67		Junta interior para vidro (2 mm)
30 93 00 68		Junta interior para vidro (6/7 mm)
30 93 00 69		Junta interior para vidro (8/9 mm)
30 95 00 40		Pelúcia 7x5.5 mm
30 95 00 70		Pelúcia 7x3.5 mm
30 95 00 80		Pelúcia 7x5 mm

Janela 2 folhas correr



Perfis

Desenho	Ref	Descrição	Corte	Quant	Medida
	CL-05	Padieira		1	L-40 mm
	CL-01	Soleira		1	L-40 mm
	CL-06	Ombreira		2	H
	CL-10	Móvel carrinho		4	L/2-12 mm
	CL-20	Móvel lateral		2	H-64 mm
	CL-09	Móvel central		2	H-64 mm
	CL-22	Pingadeira		1	L

Acessórios e Juntas

Referência	Descrição	Quantidade
30 91 50 09/10	Fecho lateral	2
30 91 50 22	Rolamentos	4
30 91 50 30	Corta ventos inferior	1
30 91 50 40	Corta ventos superior	1
30 91 50 61	Junta estanquidade superior	1
30 91 50 70	Junta estanquidade inferior	1
30 91 50 80	Tampa guia lateral	4
30 92 01 00	Goteiras	2
30 95 00 40	Pelúcia 7x5.5 mm	8L/2
30 95 00 70	Pelúcia 7x3.5 mm (lateral)	4H
30 95 00 80	Pelúcia 7x5 mm (central)	4H

Vidro



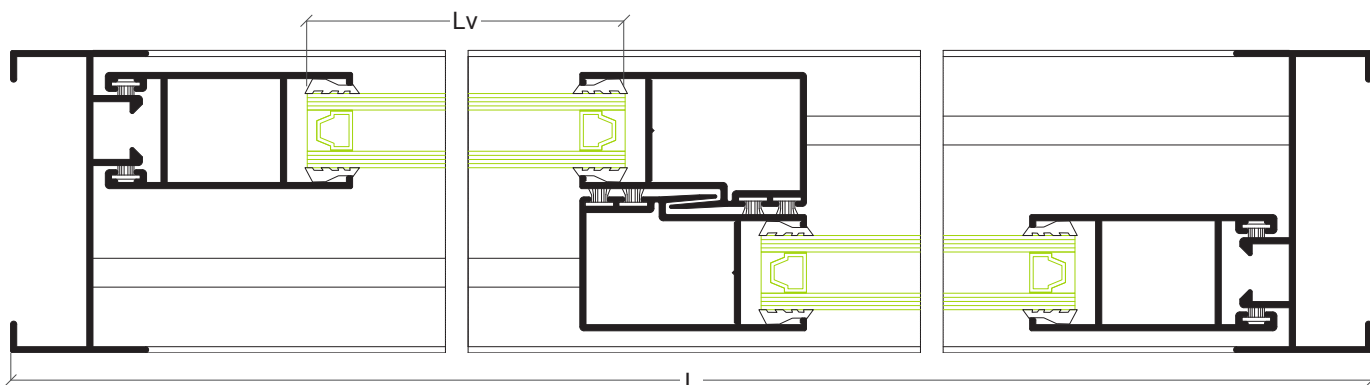



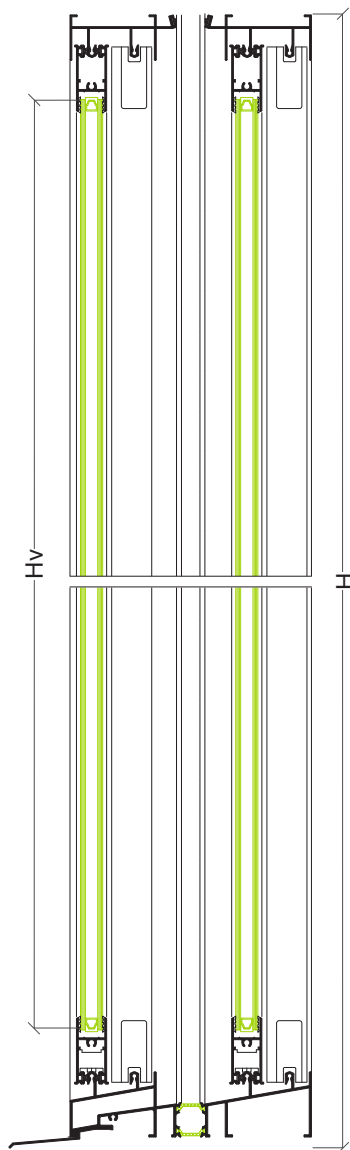
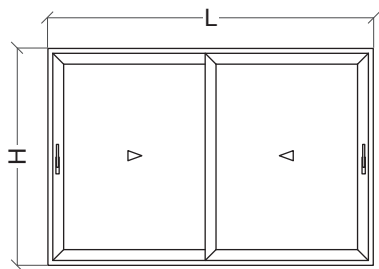



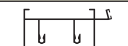

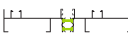

Hv = H-146 mm	Lv = L/2-89 mm
---------------	----------------



Janela 2 folhas dupla correr



Perfis

Desenho	Ref	Descrição	Corte	Quant	Medida
	CL-75	Padieira		2	L-46 mm
	CL-71	Soleira		1	L-46 mm
	CL-76	Ombreira		2	H
	CL-10	Móvel carrinho		8	L/2-15 mm
	CL-20	Móvel lateral		4	H-71 mm
	CL-09	Móvel central		4	H-71 mm
	CL-22	Pingadeira		1	L

Acessórios e Juntas

Referência	Descrição	Quantidade
30 20 50 01	Jogo juntas estanquidade janela dupla	1
30 91 50 09/10	Fecho lateral	4
30 91 50 22	Rolamentos	8
30 91 50 30	Corta ventos inferior	2
30 91 50 40	Corta ventos superior	2
30 91 50 80	Tampa guia lateral	8
30 91 50 85	Guia de persiana	2
30 92 01 00	Goteiras	2
30 95 00 40	Pelúcia 7x5.5 mm	16L/2 2L
30 95 00 70	Pelúcia 7x3.5 mm (lateral)	8H
30 95 00 80	Pelúcia 7x5 mm (central)	8H

363

Vidro



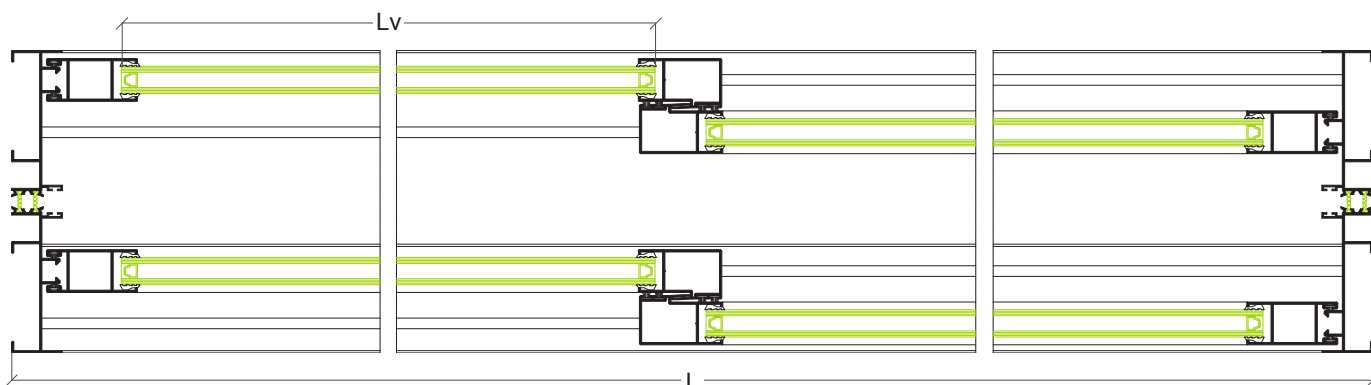



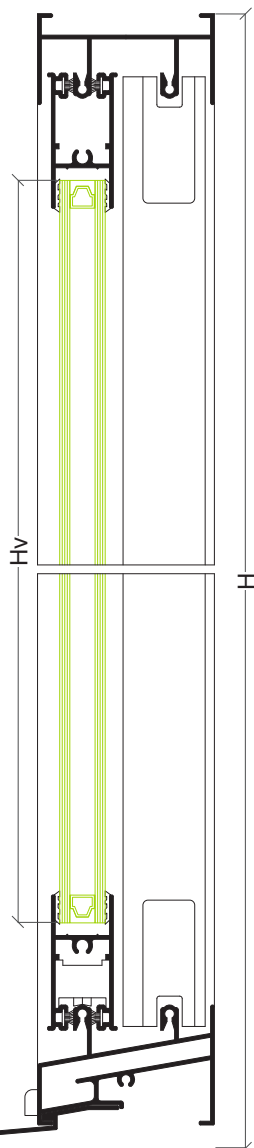
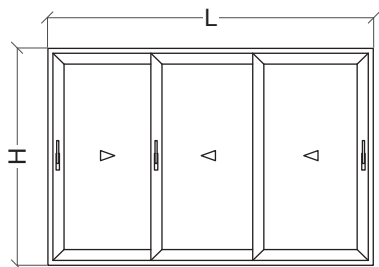







Hv = H-153 mm	Lv = L/2-92 mm
---------------	----------------



Janela 3 folhas correr



Perfis

Desenho	Ref	Descrição	Corte	Quant	Medida
	CL-05	Padieira		1	L-40 mm
	CL-01	Soleira		1	L-40 mm
	CL-06	Ombreira		2	H
	CL-10	Móvel carrinho		4	L/3+7 mm
				2	L/3+15 mm
	CL-20	Móvel lateral		2	H-64 mm
	CL-09	Móvel central		4	H-64 mm
	CL-22	Pingadeira		1	L

Acessórios e Juntas

Referência	Descrição	Quantidade
30 91 50 09/10	Fecho lateral	2
30 91 50 22	Rolamentos	6
30 91 50 30	Corta ventos inferior	2
30 91 50 40	Corta ventos superior	2
30 91 50 60	Junta estanquidade superior	1
30 91 50 70	Junta estanquidade inferior	1
30 91 50 80	Tampa guia lateral	8
30 92 01 00	Goteiras	2
30 95 00 40	Pelúcia 7x5.5 mm	12L/3
30 95 00 70	Pelúcia 7x3.5 mm (lateral)	4H
30 95 00 80	Pelúcia 7x5 mm (central)	4H

Vidro

Hv = H2-85 mm	Lv = L/2-89 mm
Hv = H1-166 mm	Lv = L/2-89 mm

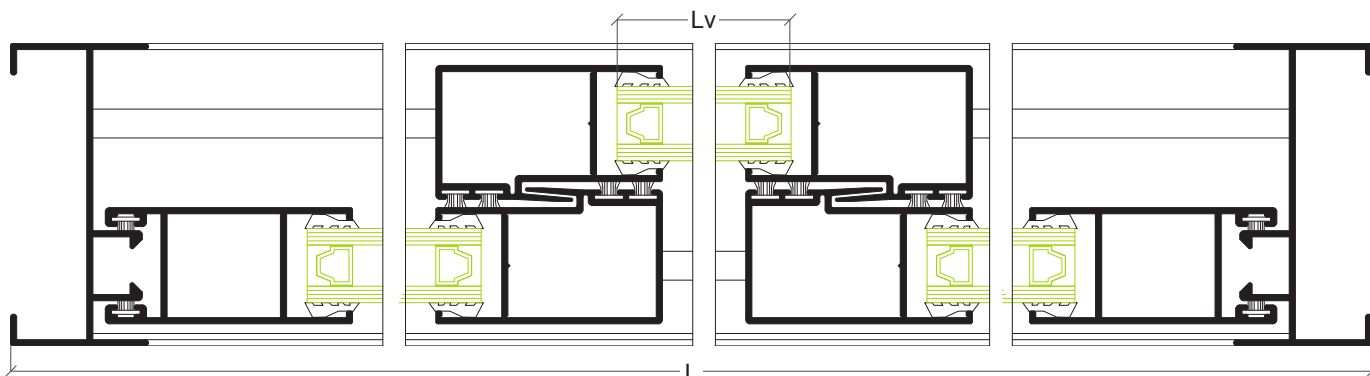

Janela 4 folhas correr

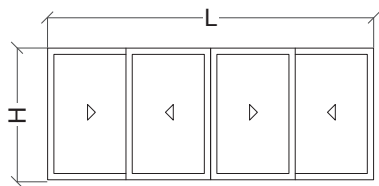

Perfis

Desenho	Ref	Descrição	Corte	Quant	Medida
	CL-05	Padieira		1	L-40 mm
	CL-01	Soleira		1	L-40 mm
	CL-06	Ombreira		2	H
	CL-10	Móvel carrinho		8	L/4-2 mm
	CL-20	Móvel lateral		4	H-64 mm
	CL-09	Móvel central		4	H-64 mm
	CL-28	União de 4 folhas		1	H-64 mm
	CL-22	Pingadeira		1	L

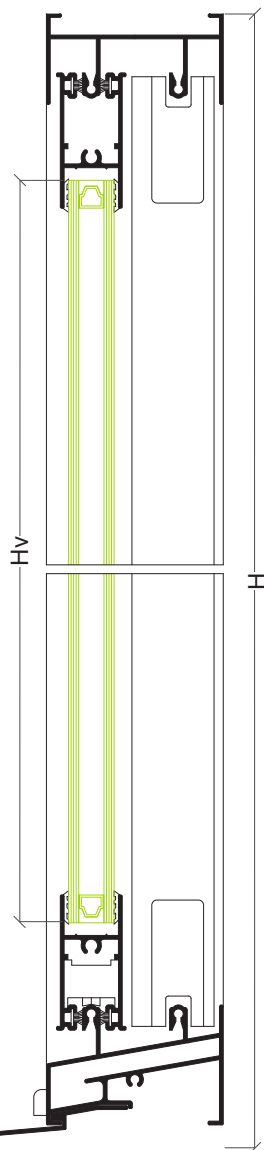

Acessórios e Juntas

Referência	Descrição	Quantidade
30 91 50 09/10	Fecho lateral	3
30 91 50 22	Rolamentos	8
30 91 50 30	Corta ventos inferior	3
30 91 50 40	Corta ventos superior	3
30 91 50 60	Junta estanquidade superior	1
30 91 50 70	Junta estanquidade inferior	1
30 91 50 80	Tampa guia lateral	8
30 92 01 00	Goteiras	3
30 95 00 40	Pelúcia 7x5.5 mm	16L/4
30 95 00 70	Pelúcia 7x3.5 mm (lateral)	6H
30 95 00 80	Pelúcia 7x5 mm (central)	8H

365

Vidro

Hv = H-146 mm	Lv = L/4-78 mm
---------------	----------------

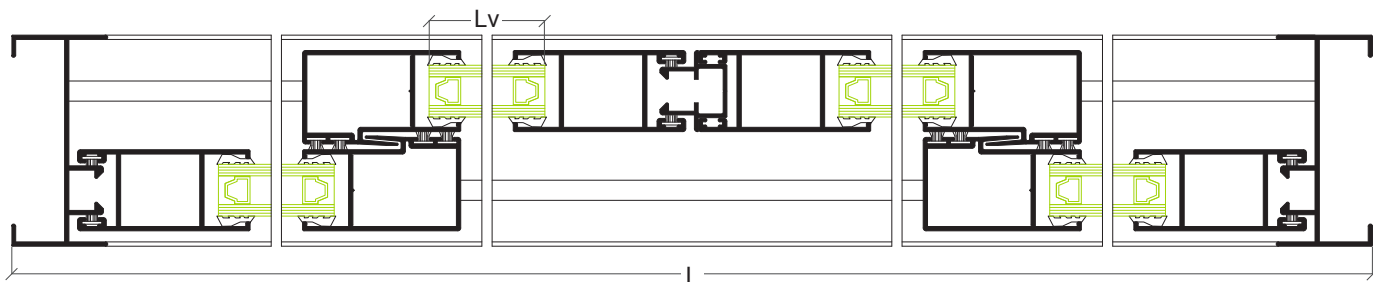

Porta 2 folhas correr

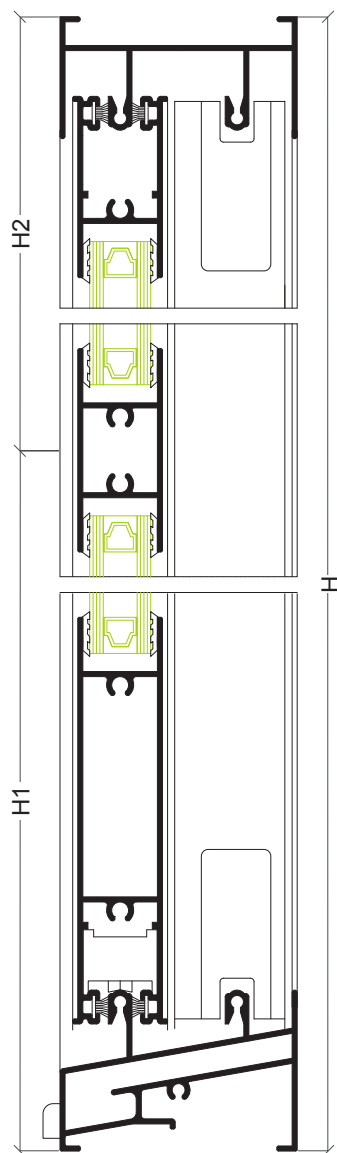
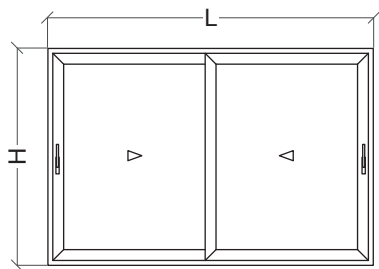

Perfis

Desenho	Ref	Descrição	Corte	Quant	Medida
	CL-05	Padieira		1	L-40 mm
	CL-01	Soleira		1	L-40 mm
	CL-06	Ombreira		2	H
	CL-10	Móvel carrinho		4	L/2-12 mm
	CL-20	Móvel lateral		2	H-64 mm
	CL-27	Móvel central		2	H-64 mm
	CL-52	Almofada		2	L/2-12 mm
	CL-53	Travessa		2	L/2-12 mm

Acessórios e Juntas

Referência	Descrição	Quantidade
30 91 50 09/10	Fecho lateral	2
30 91 50 27	Rolamentos	4
30 91 50 30	Corta ventos inferior	1
30 91 50 40	Corta ventos superior	1
30 91 50 60	Junta estanquidade superior	1
30 91 50 70	Junta estanquidade inferior	1
30 91 50 80	Tampa guia lateral	4
30 92 01 00	Goteiras	2
30 95 00 40	Pelúcia 7x5.5 mm	8L/2
30 95 00 70	Pelúcia 7x3.5 mm (lateral)	4H
30 95 00 80	Pelúcia 7x5 mm (central)	4H

Vidro



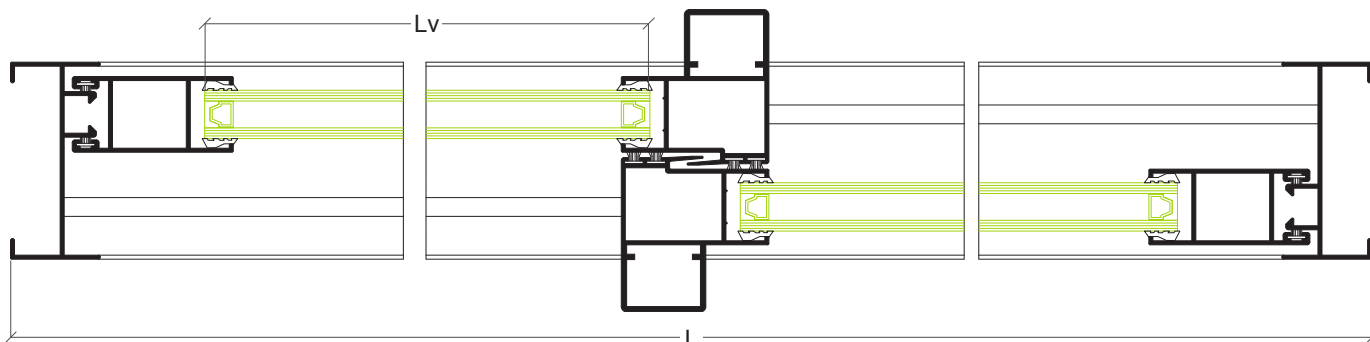



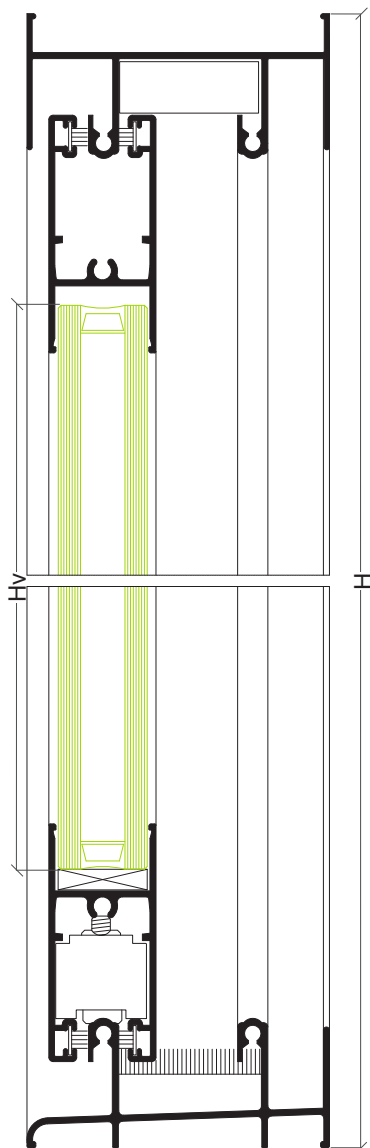
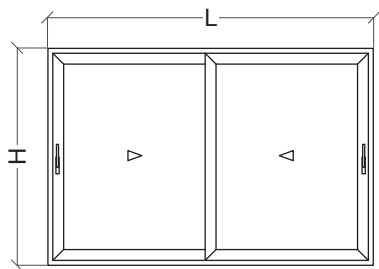





Hv = H2-85 mm	Lv = L/2-89 mm
Hv = H1-166 mm	Lv = L/2-89 mm

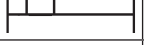

Janela 2 folhas correr



Perfis

Desenho	Ref	Descrição	Corte	Quant	Medida
	CL-05	Padieira		1	L-28 mm
	CL-42	Soleira		1	L-28 mm
	CL-43	Ombreira		2	H
	CL-47	Móvel carrinho		4	L/2-16 mm
	CL-44	Móvel lateral		2	H-43.5 mm
	CL-45	Móvel central		2	H-43.5 mm

Acessórios e Juntas

Referência	Descrição	Quantidade
30 91 50 09/10	Fecho lateral	2
30 91 50 21	Rolamentos simples	4
30 91 50 31	Corta ventos inferior	1
30 91 50 40	Corta ventos superior	1
30 91 50 61	Junta estanquidade superior	1
30 91 50 71	Junta estanquidade inferior	1
30 91 50 81	Jogo guias lateral	8
30 95 00 40	Pelúcia 7x5.5 mm	4L+2H
30 95 00 70	Pelúcia 7x3.5 mm (lateral)	4H
30 91 50 86	Junta central	2H

367

Vidro



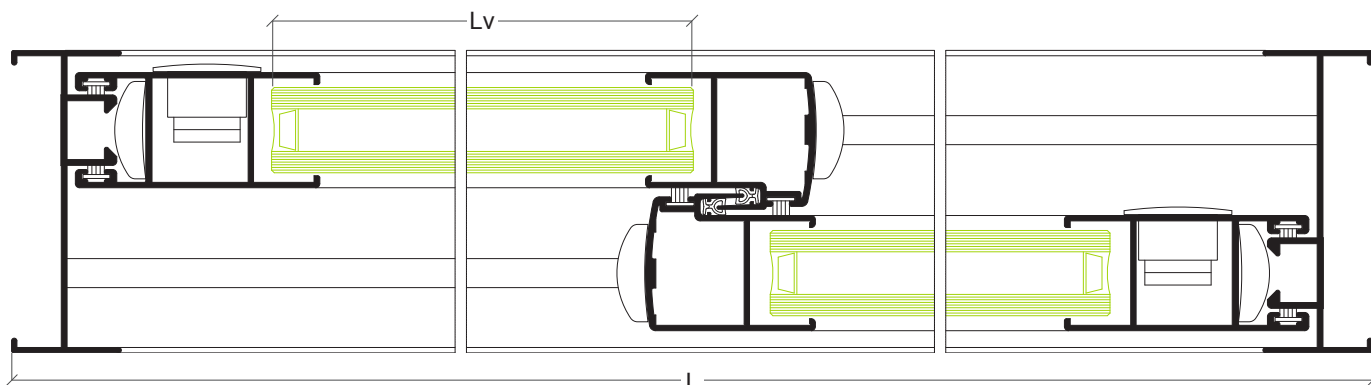



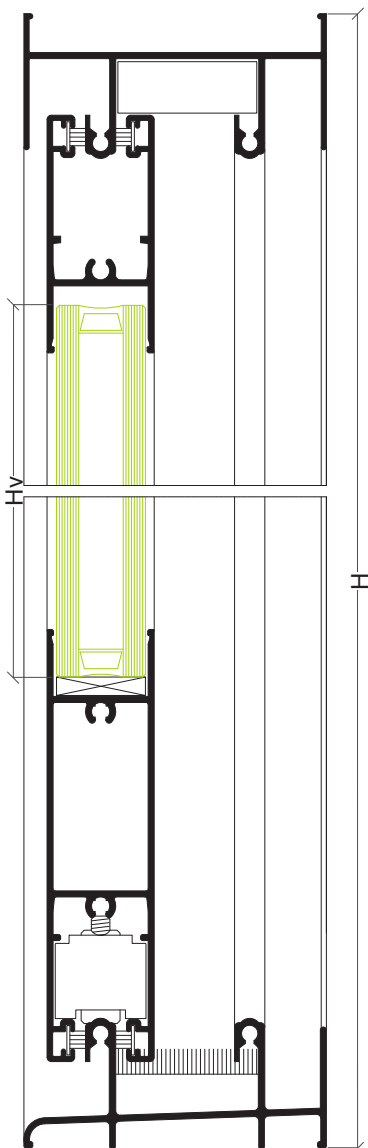
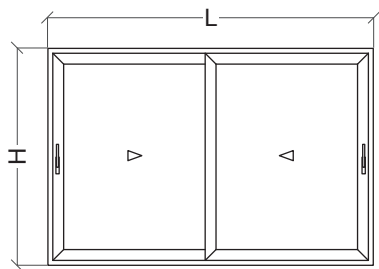





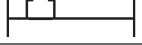

Hv = H-132 mm	Lv = L/2-73 mm
---------------	----------------



Porta 2 folhas correr



Perfis

Desenho	Ref	Descrição	Corte	Quant	Medida
	CL-05	Padieira		1	L-28 mm
	CL-42	Soleira		1	L-28 mm
	CL-43	Ombreira		2	H
	CL-47	Móvel carrinho		4	L/2-9 mm
	CL-44	Móvel lateral		2	H-43.5 mm
	CL-48	Móvel central		2	H-43.5 mm
	CL-49	Travessa		2	L/2-9 mm

Acessórios e Juntas

Referência	Descrição	Quantidade
30 91 50 09/10	Fecho lateral	2
30 91 50 21	Rolamentos simples	4
30 91 50 23	Rolamentos suplementares	4
30 91 50 31	Corta ventos inferior	1
30 91 50 40	Corta ventos superior	1
30 91 50 61	Junta estanquidade superior	1
30 91 50 71	Junta estanquidade inferior	1
30 91 50 81	Jogo guias lateral	8
30 95 00 40	Pelúcia 7x5.5 mm	4L+2H
30 95 00 70	Pelúcia 7x3.5 mm (lateral)	4H
30 91 50 86	Junta central	2H

Vidro

Hv = H-177 mm	Lv = L/2-80 mm
---------------	----------------

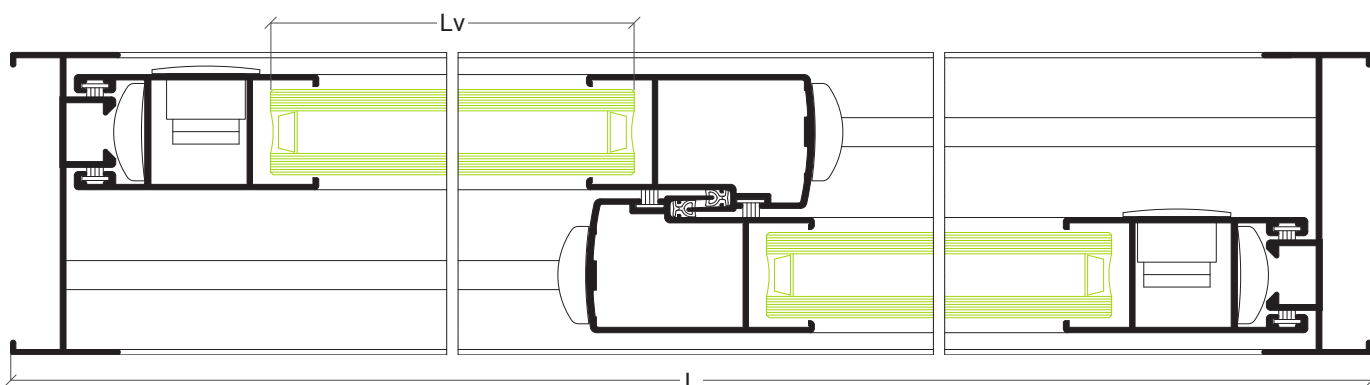

Janela 4 folhas correr

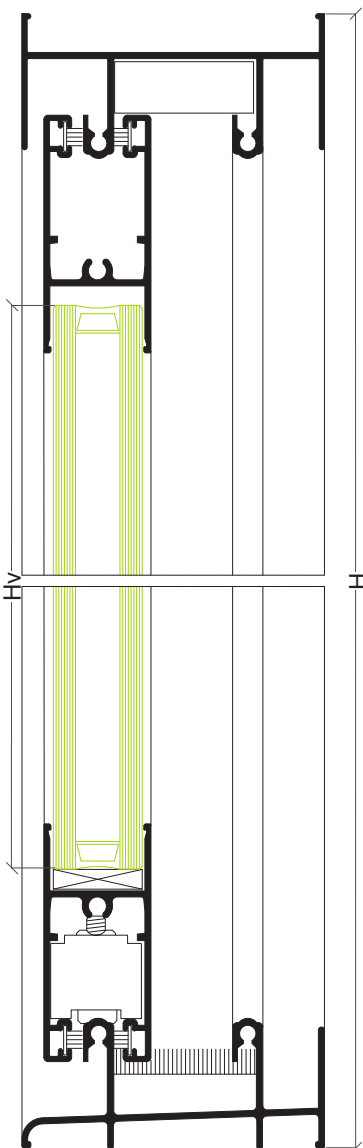
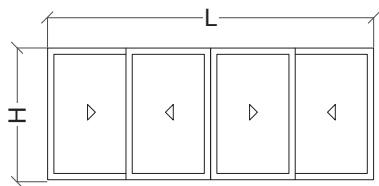

Perfis

Desenho	Ref	Descrição	Corte	Quant	Medida
	CL-05	Padieira		1	L-28 mm
	CL-42	Soleira		1	L-28 mm
	CL-43	Ombreira		2	H
	CL-47	Móvel carrinho		8	L/4-9 mm
	CL-44	Móvel lateral		4	H-43.5 mm
	CL-45	Móvel central		4	H-43.5 mm
	CL-28	União 3/4F		1	H-43.5 mm

Acessórios e Juntas

Referência	Descrição	Quantidade
30 91 50 09/10	Fecho lateral	3
30 91 50 21	Rolamentos simples	8
30 91 50 31	Corta ventos inferior	3
30 91 50 40	Corta ventos superior	3
30 91 50 61	Junta estanquidade superior	1
30 91 50 71	Junta estanquidade inferior	1
30 91 50 81	Jogo guias lateral	14
30 95 00 40	Pelúcia 7x5.5 mm	4L+4H
30 95 00 70	Pelúcia 7x3.5 mm	6H
30 91 50 86	Junta central	4H

369

Vidro

Hv = H-132 mm	Lv = L/4-66 mm
---------------	----------------

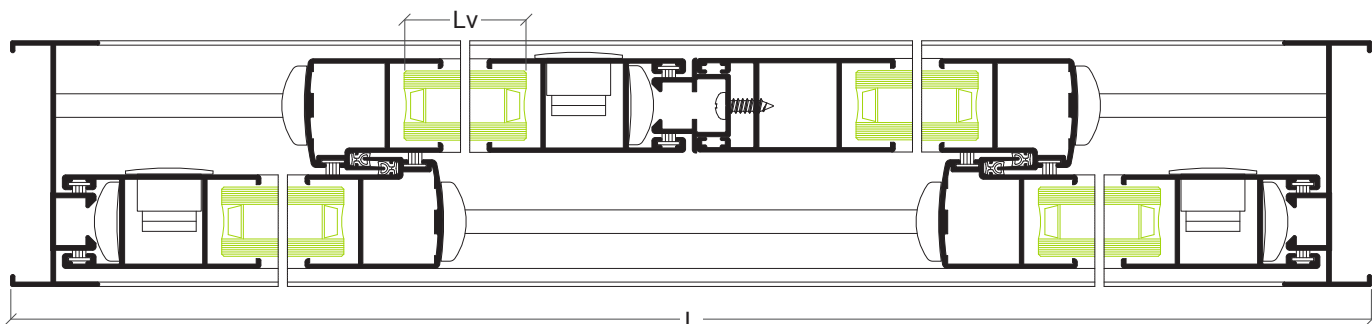

Porta 4 folhas correr

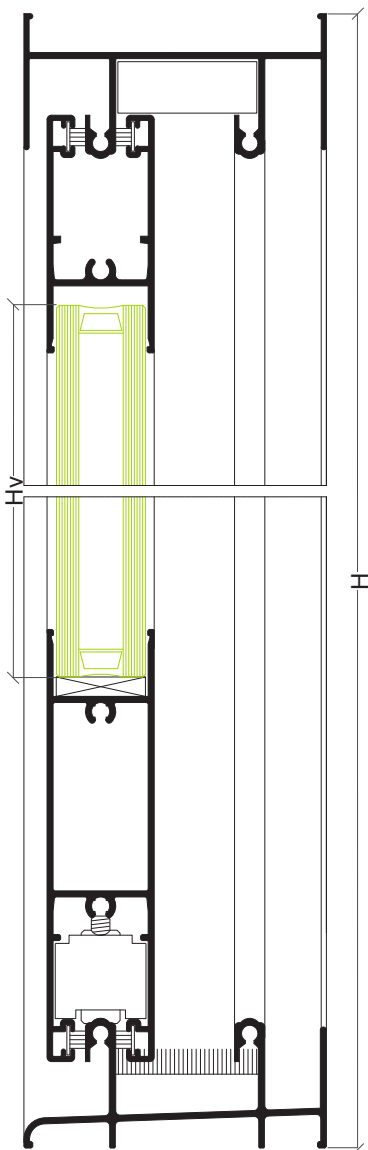
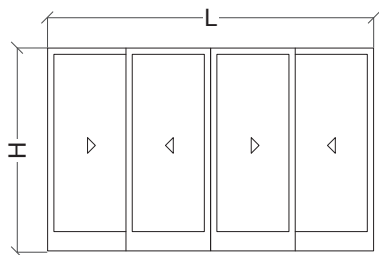

370

Perfis

Desenho	Ref	Descrição	Corte	Quant	Medida
	CL-05	Padieira		1	L-28 mm
	CL-42	Soleira		1	L-28 mm
	CL-43	Ombreira		2	H
	CL-47	Móvel carrinho		4	L/4-2 mm
	CL-44	Móvel lateral		4	H-43.5 mm
	CL-48	Móvel central		4	H-43.5 mm
	CL-49	Travessa		4	L/4-2 mm
	CL-28	União 3/4F		1	H-43.5 mm

Acessórios e Juntas

Referência	Descrição	Quantidade
30 91 50 09/10	Fecho lateral	3
30 91 50 21	Rolamentos simples	4
30 91 50 23	Rolamentos suplementares	4
30 91 50 31	Corta ventos inferior	3
30 91 50 40	Corta ventos superior	3
30 91 50 61	Junta estanquidade superior	1
30 91 50 71	Junta estanquidade inferior	1
30 91 50 81	Jogo guias lateral	14
30 95 00 40	Pelúcia 7x5.5 mm	4L+4H
30 95 00 70	Pelúcia 7x3.5 mm	6H
30 91 50 86	Junta central	4H

Vidro

Hv = H-177 mm	Lv = L/4-73 mm
---------------	----------------

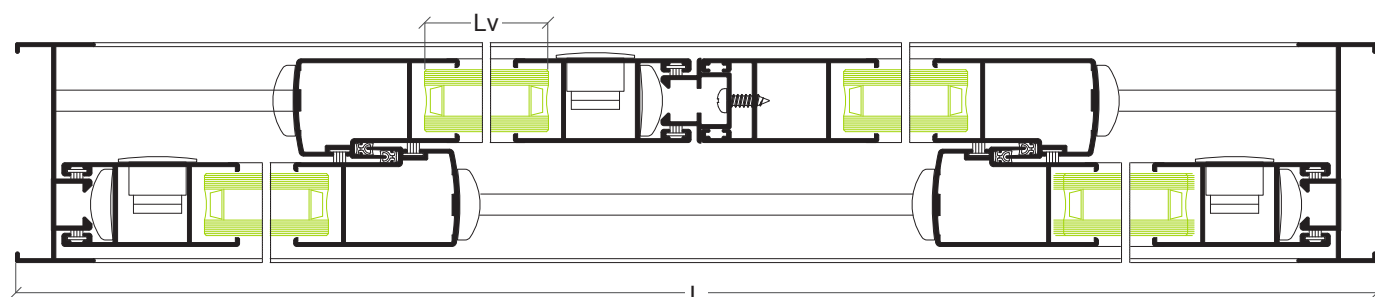

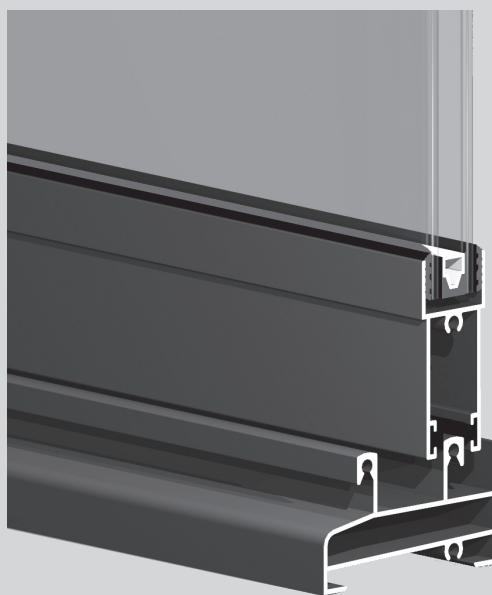

Sistema

CM

Sistema CM

Sistema de correr - 60 mm

Características do sistema

Sistemas de alumínio para execução de vãos de correr ou vãos de correr com janela dupla.

Perfis de alumínio

Os perfis de alumínio são extrudidos na liga de alumínio 6060 para arquitetura de acordo com norma NP EN 12020-02.

Aros fixos

Secção do aro fixo de 2 guias de 60 mm para montagem a corte recto;
Secção do aro fixo de 3 guias de 90 mm para montagem a corte recto;
Secção do aro fixo janela dupla de 176.5 mm para montagem a corte recto.

Aros móveis

Secção dos aros móveis de 22 mm com montagem a corte recto;
Enchimento de 4 mm a 16 mm;
Estanquidade assegurada através de pelúcia tipo Fin-Seal.

Dimensionamento e manobralidade

Peso máximo 80 kg por folha (com 2 rolamentos duplos);
Possibilidades de abertura: 1, 2, 3, 4 e 6 folhas, com folhas móveis e/ou fixas;
Rolamento duplo com regulação.

Performances

Sistema certificado por laboratório notificado do ensaio tipo inicial (ITT) de acordo com a norma de produto EN 14351-1 para efeitos de Marcação CE.

Categorias alcançadas na avaliação do sistema CM:

1. Permeabilidade ao ar: Classe 3 (norma de ensaio EN 1026)
2. Estanquidade à água: Classe 6A (norma de ensaio EN 1027)
3. Resistência ao vento: Classe C1 (norma de ensaio EN 12211)

Coefficiente de transmissão térmica de vão de 2 folhas com 1.60 m x 2.00 m com vidro $U_g = 2.1 \text{ W/m}^2\text{K}$:

• $U_w = 3.32 \text{ W/m}^2\text{K}$

Coefficiente de atenuação acústica de vão de 2 folhas com vidro 4/8/4:

• $R_w (C; C_{tr}) = 28 \text{ dB} (-1; -1)$

Zonas de aplicação segundo RCCTE (em função do valor U_g): I1, I2, I3, V1, V2, V3;

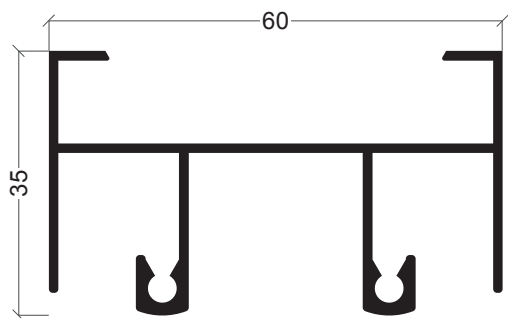

CM-05
Padieira

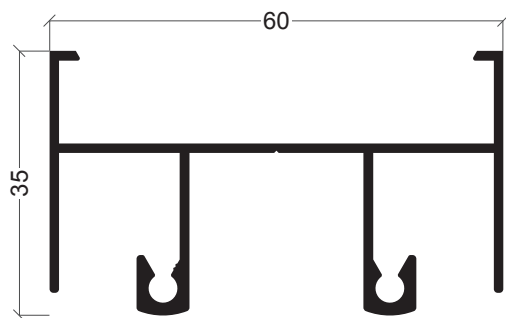

CM-15
Padieira

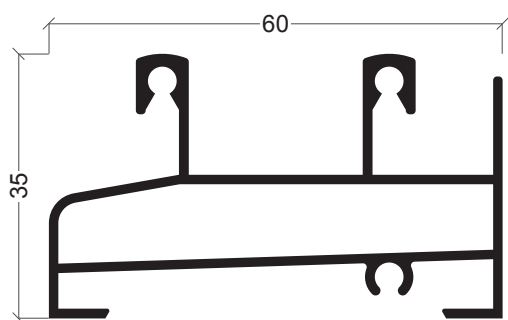

CM-01
Soleira

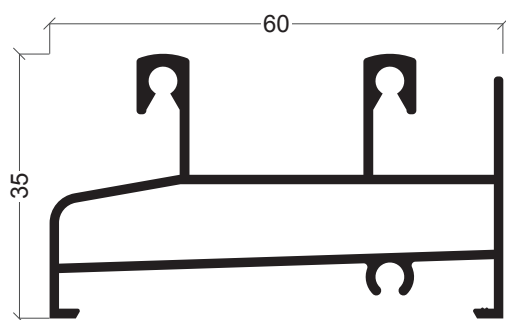

CM-11
Soleira

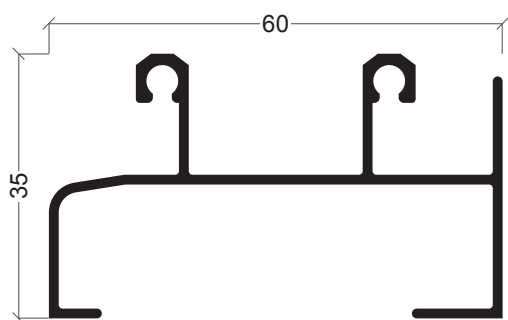

CM-71
Soleira

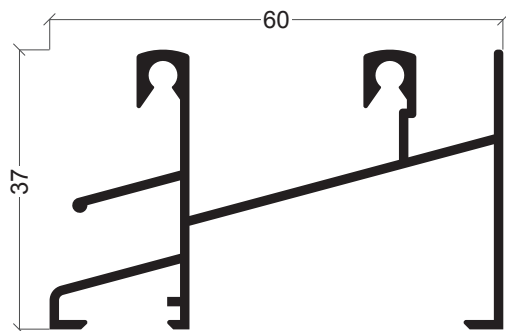

CM-31
Soleira

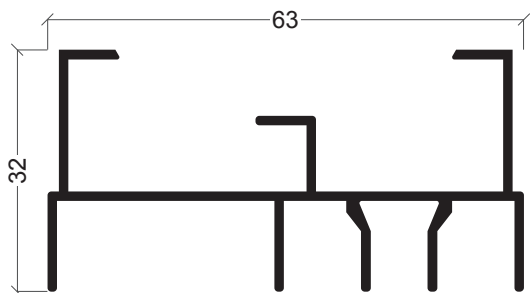

CM-06
Ombreira

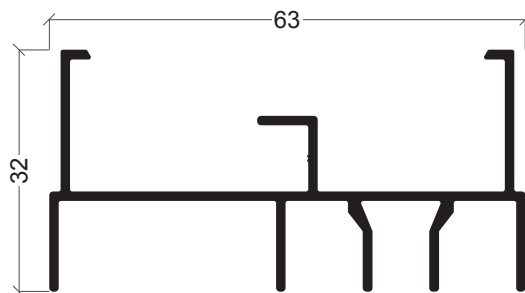

CM-26
Ombreira

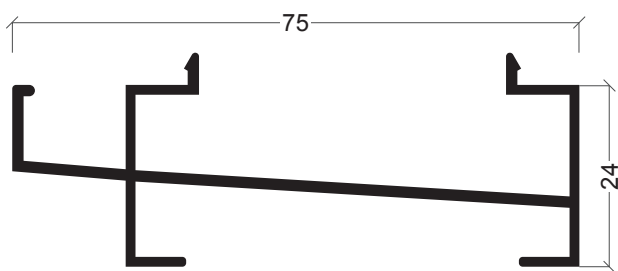

CM-38
Soleira



CM-20
Remate

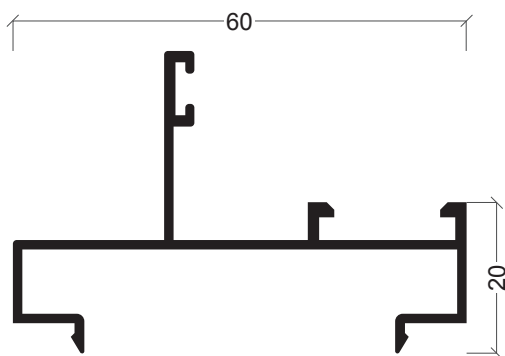

CM-18
Complemento fixo

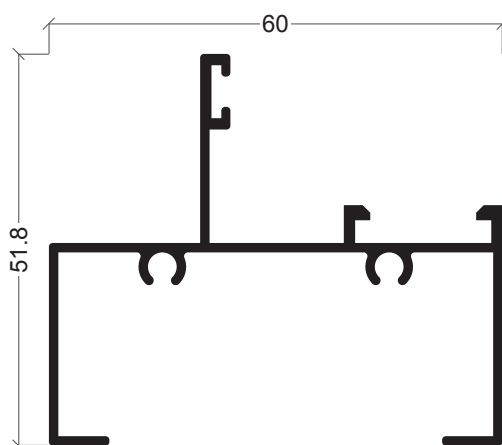

CM-08
Complemento fixo

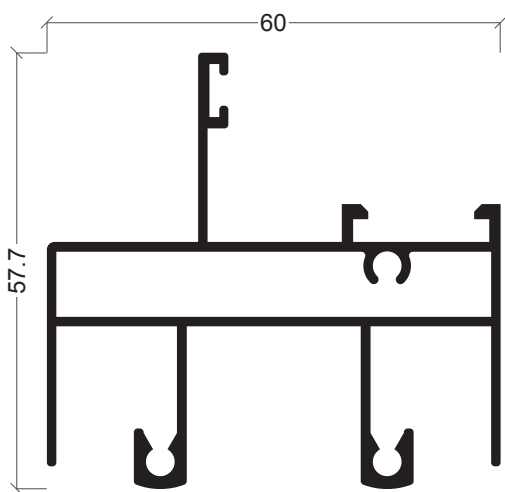

CM-55
Padieira com fixo superior

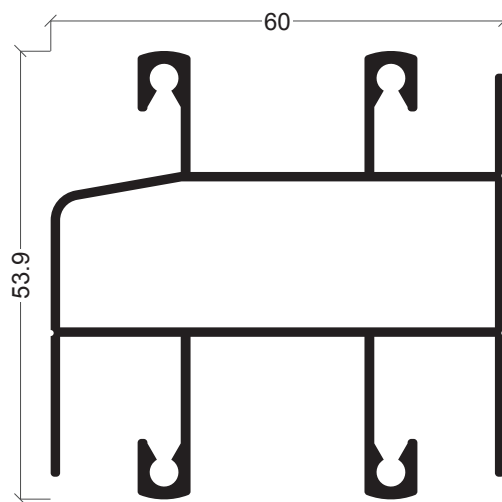

CM-04
Aro duplo

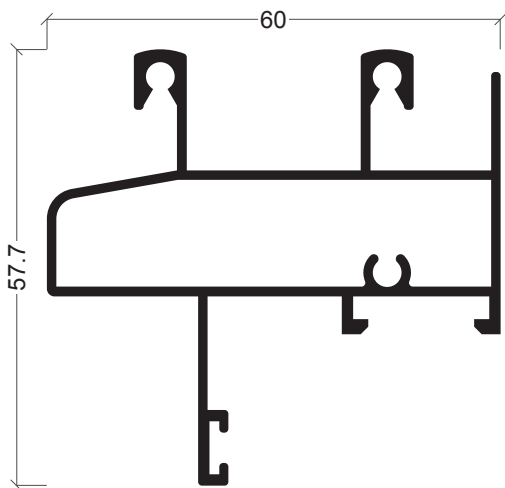

CM-51
Soleira com fixo inferior

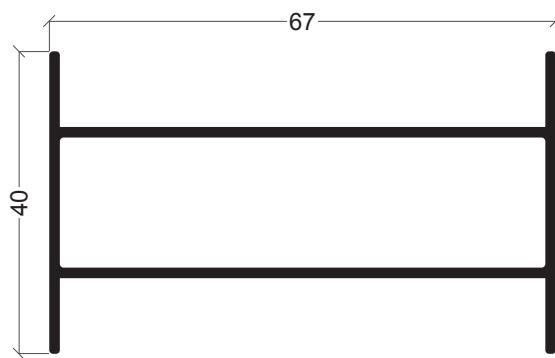

CM-32
União de aros

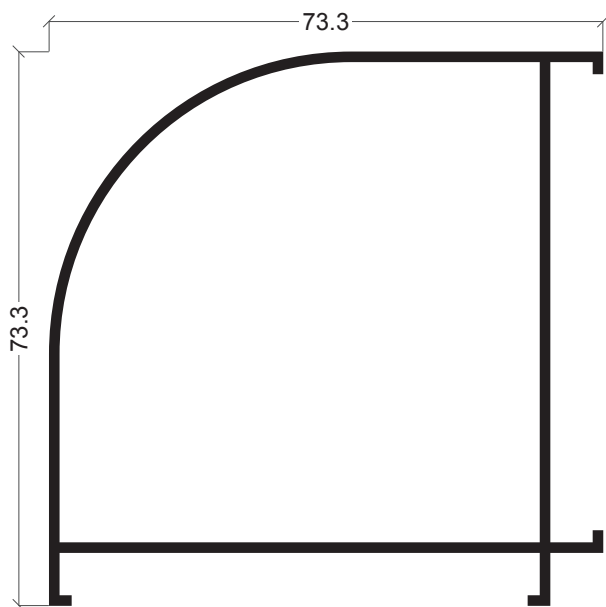

CM-35
Esquina

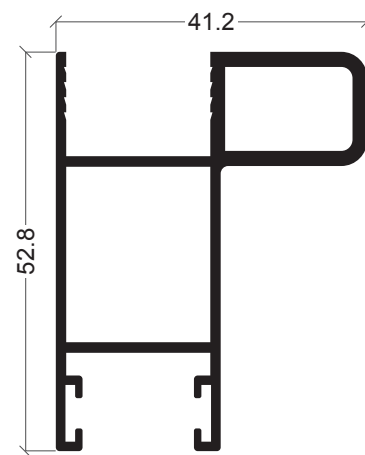

CM-81
Aro móvel lateral com reforço

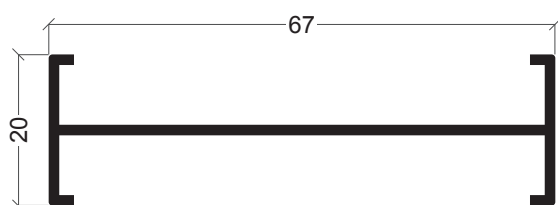

CM-49
União de aros

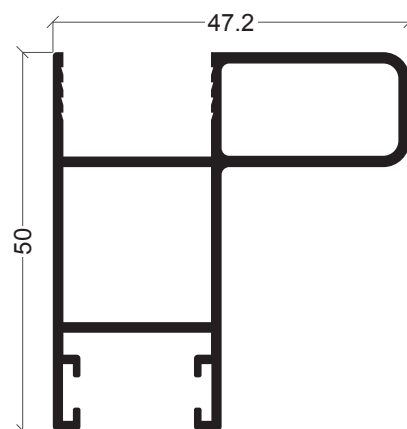

CM-30
Aro móvel lateral com reforço

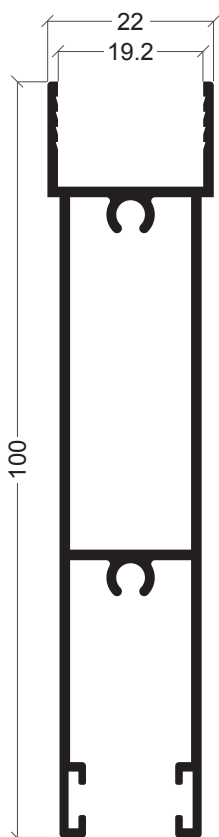

CM-52
Almofada carrinho

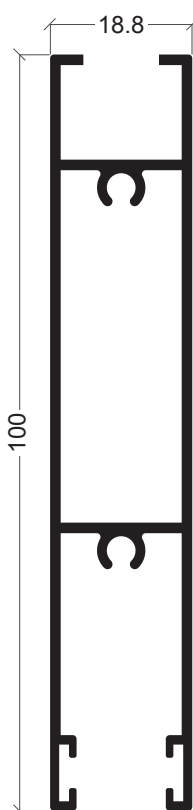

CM-53
Almofada carrinho

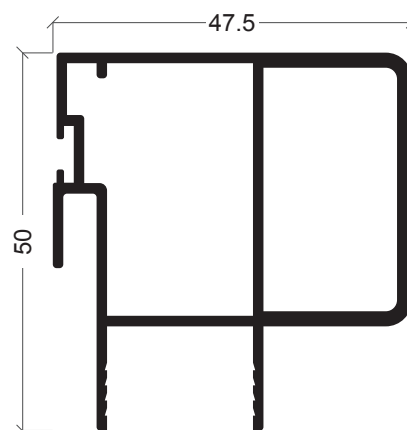

CM-29
Aro móvel central com reforço

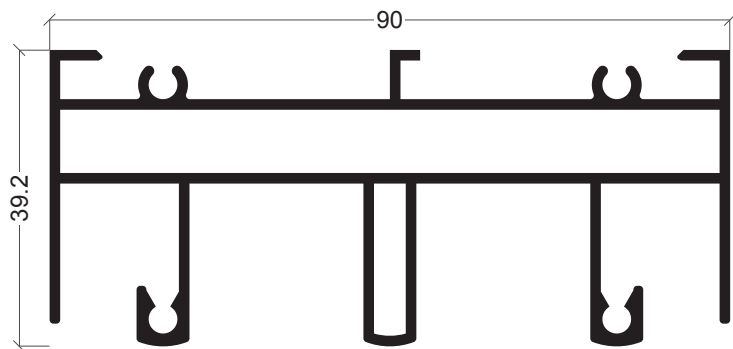

CM-45
Padieira tri-rail

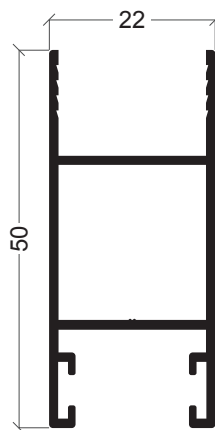

CM-10
Aro móvel lateral

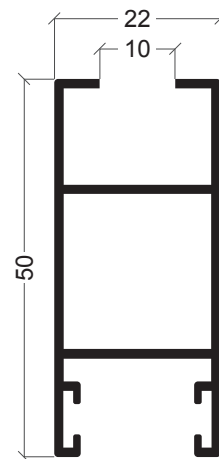

CM-16
Aro móvel lateral

376

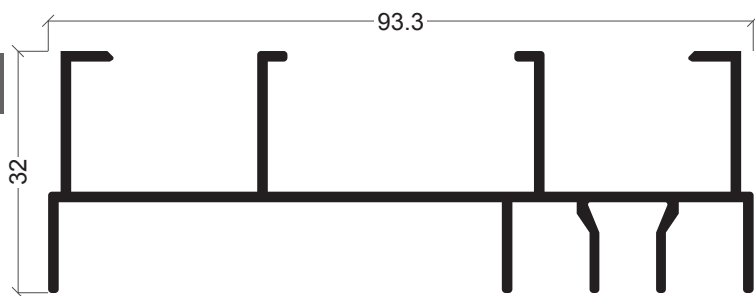

CM-46
Ombreira tri-rail

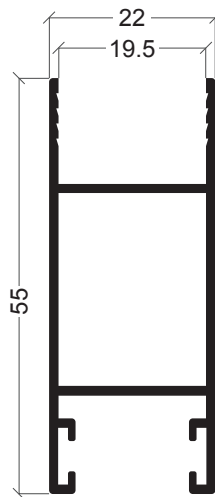

CM-80
Aro móvel lateral

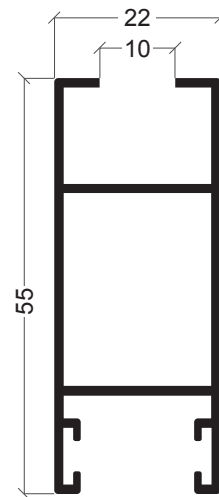

CM-76
Aro móvel lateral

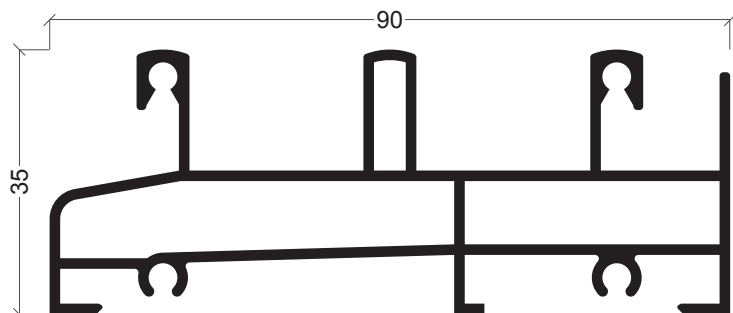

CM-41
Soleira tri-rail

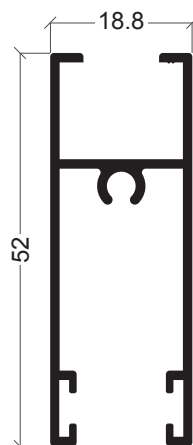

CM-12
Aro móvel carrinho

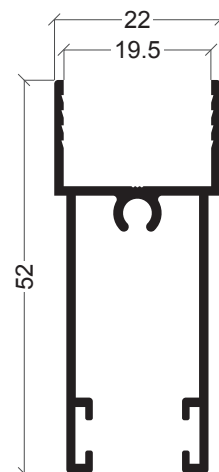

CM-02
Aro móvel carrinho

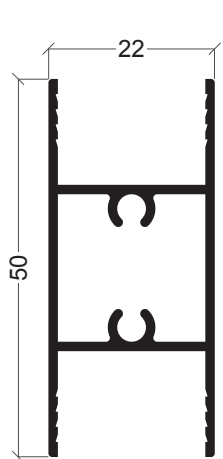

CM-54
Travessa

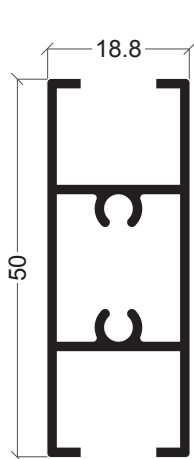

CM-56
Travessa

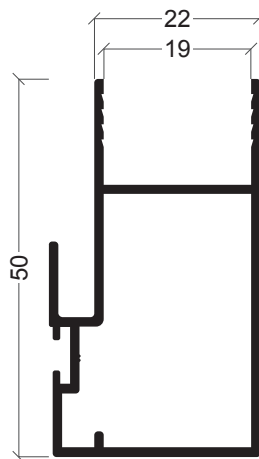

CM-09
Aro móvel central

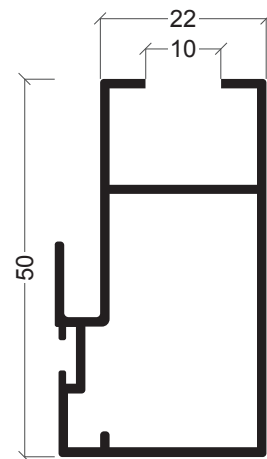

CM-17
Aro móvel central

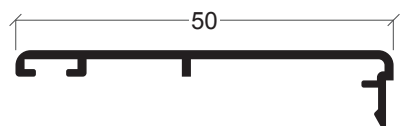

CM-25
Remate

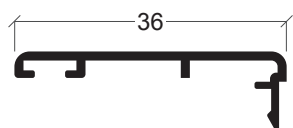

CM-24
Remate

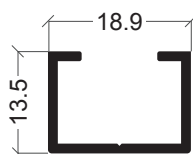

CM-83
Redutor

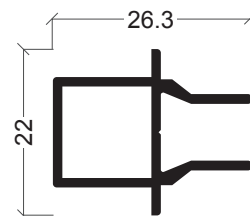

CM-28
União 3/4F

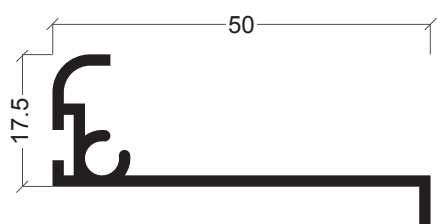

CM-34
Guia persiana

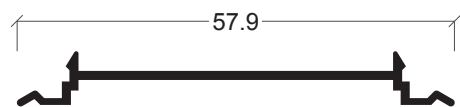

CM-23
Clip de pingadeira/remate

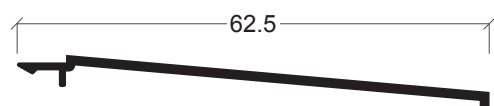

CM-21
Pingadeira

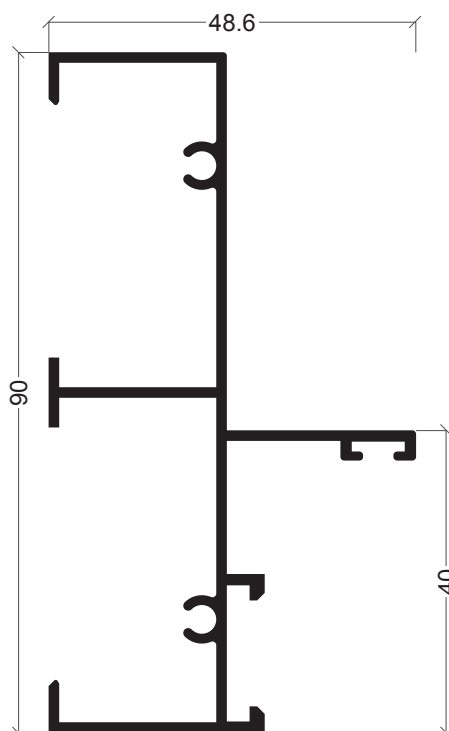

CM-58
Pingadeira

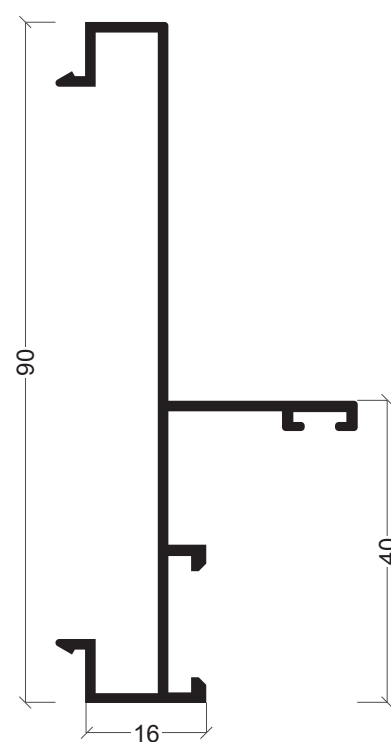

CM-48
Pingadeira

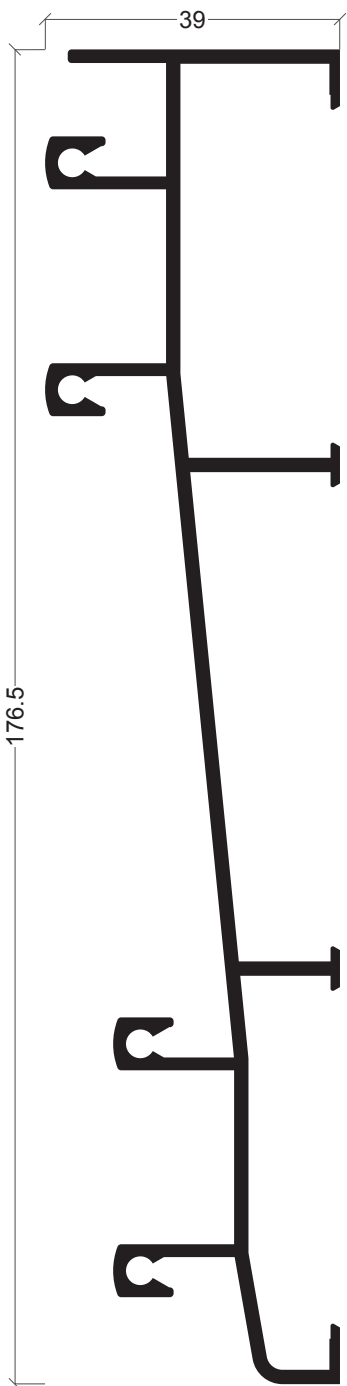

CM-61
Soleira janela dupla

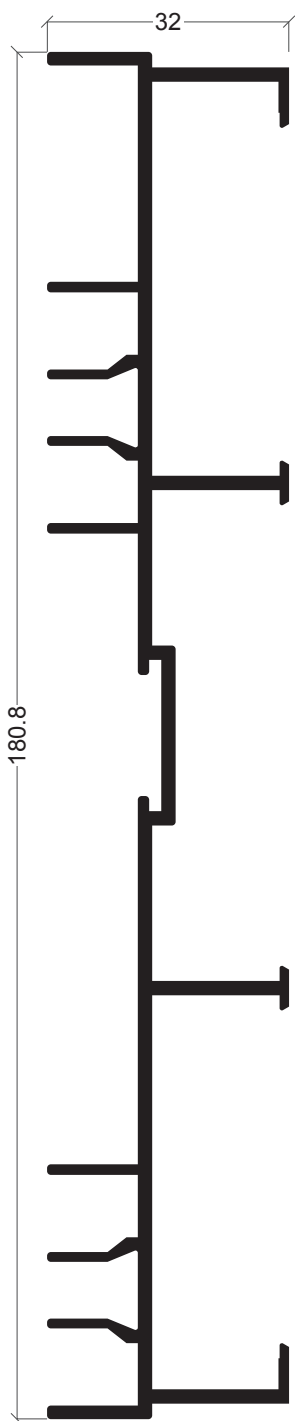

CM-66
Ombreira janela dupla

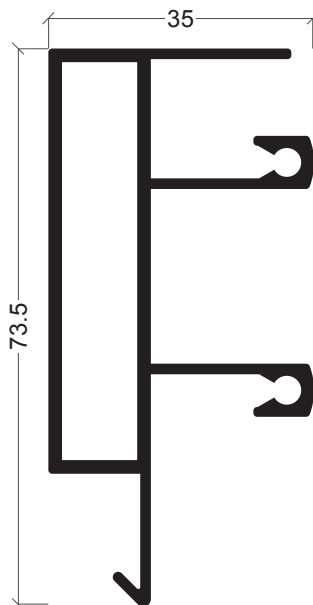

CM-82
Padieira janela dupla

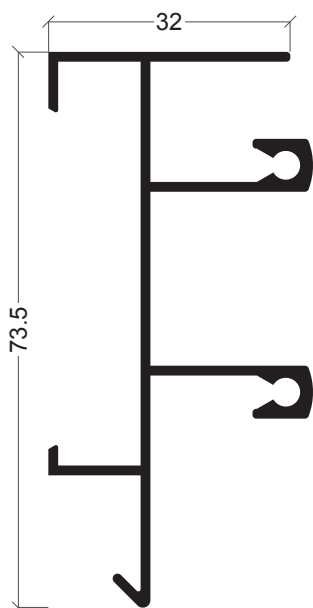

CM-65
Padieira janela dupla

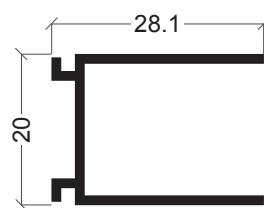

CM-64
Guia persiana janela dupla

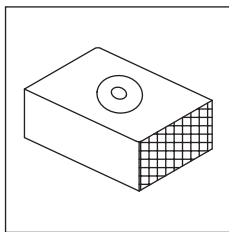

30 91 41 10

Taco anti-levantamento
preto

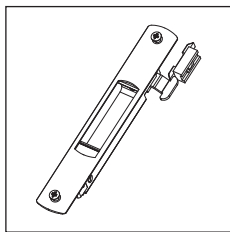

30 97 00 02/03

Fecho lateral branco/
preto

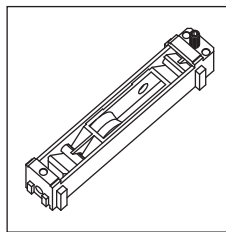

30 97 00 05

Rolamento

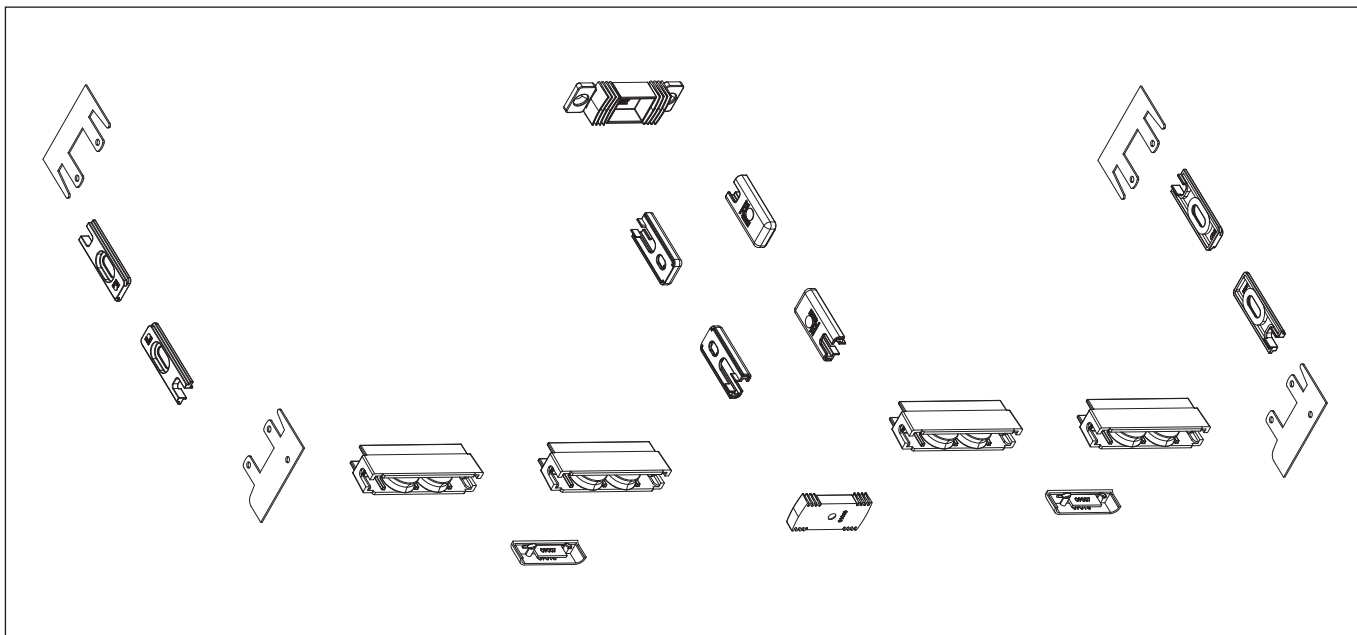

30 97 00 01

Kit correr CM 2 folhas

30 97 00 04

Kit correr CM 3 folhas

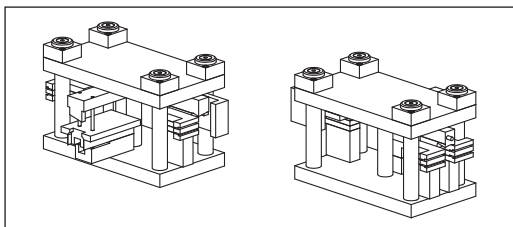

33 96 22 99

Cunho CM dupla

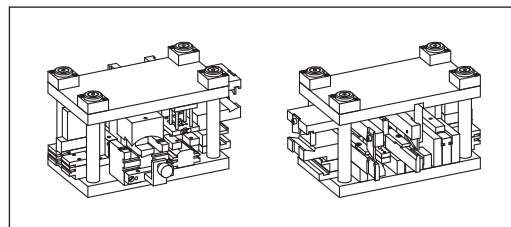

33 96 29 99

Cunho CM

Referência	Desenho	Descrição
30 93 00 65		Junta interior para vidro (5 mm)
30 93 00 66		Junta interior para vidro (4 mm)
30 93 00 67		Junta interior para vidro (2 mm)
30 93 00 68		Junta interior para vidro (6/7 mm)
30 93 00 69		Junta interior para vidro (8/9 mm)
30 95 00 40		Pelúcia 7x5.5 mm

Janela 2 folhas correr

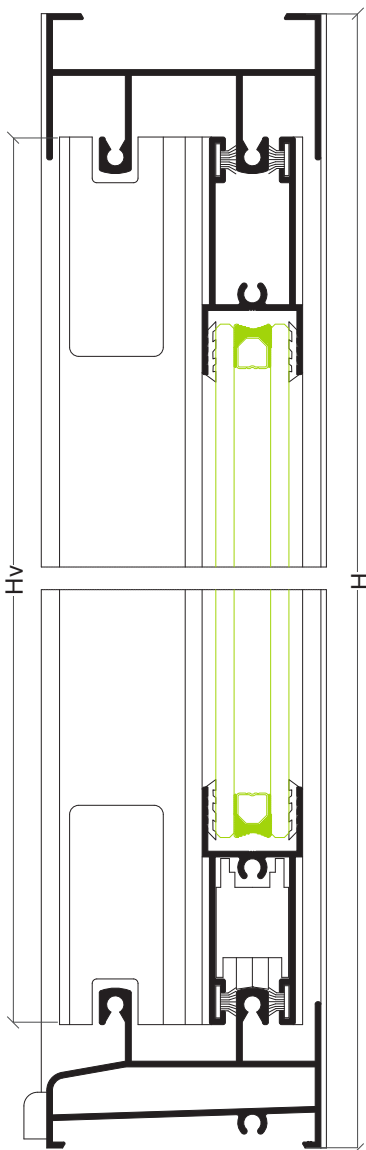
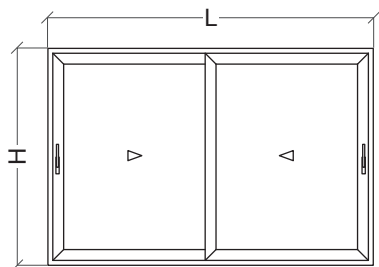

Perfis

Desenho	Ref	Descrição	Corte	Quant	Medida
	CM-15	Padieira		1	L-40 mm
	CM-11	Soleira		1	L-40 mm
	CM-26	Ombreira		2	H
	CM-02	Móvel carrinho		4	L/2-14 mm
	CM-10	Móvel lateral		2	H-54 mm
	CM-09	Móvel central		2	H-54 mm

Acessórios e Juntas

Referência	Descrição	Quantidade
30 97 00 01	Kit correr CM 2 folhas	1
30 97 00 02	Fecho lateral	2
30 91 41 10	Taco anti-levantamento	2
30 95 00 40	Pelúcia 7x5.5 mm	2L

Vidro







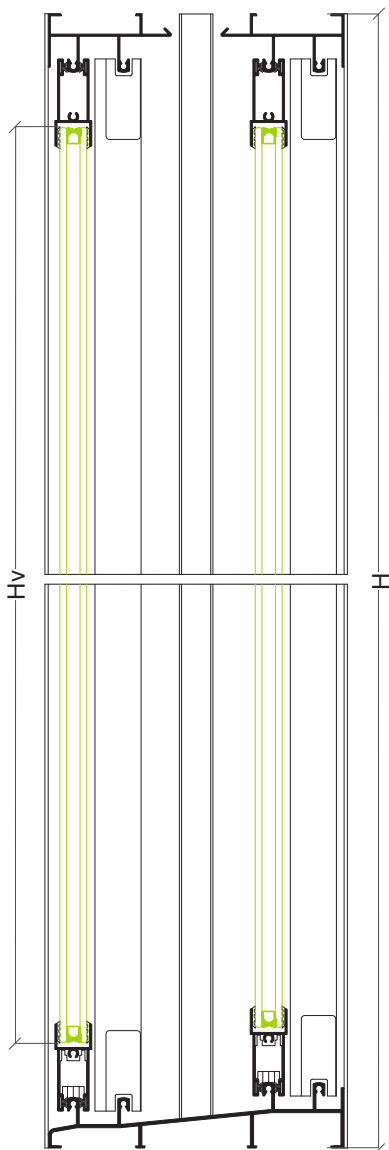
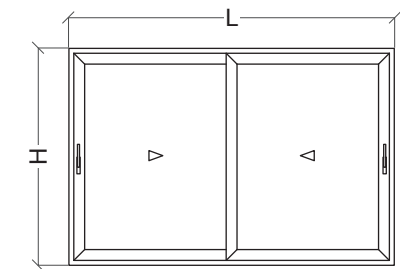









Hv = H-134 mm	Lv = L/2-77 mm
---------------	----------------



Janela 2 folhas dupla correr



Perfis

Desenho	Ref	Descrição	Corte	Quant	Medida
	CM-65	Padieira		2	L-40 mm
	CM-61	Soleira		1	L-40 mm
	CM-66	Ombreira		2	H
	CM-02	Móvel carrinho		8	L/2-14 mm
	CM-10	Móvel lateral		2	H-58 mm
				2	H-49 mm
	CM-09	Móvel central		2	H-58 mm
				2	H-49 mm
	CM-64	Guia		2	H+10 mm

Acessórios e Juntas

Referência	Descrição	Quantidade
30 97 00 01	Kit correr CM 2 folhas	2
30 97 00 02	Fecho lateral	4
30 91 41 10	Taco anti-levantamento	4
30 95 00 40	Pelúcia 7x5.5 mm	4L+6H

381

Vidro

Folha interior	Hv = H-140 mm	Lv = L/2-77 mm
Folha exterior	Hv = H-132 mm	Lv = L/2-77 mm

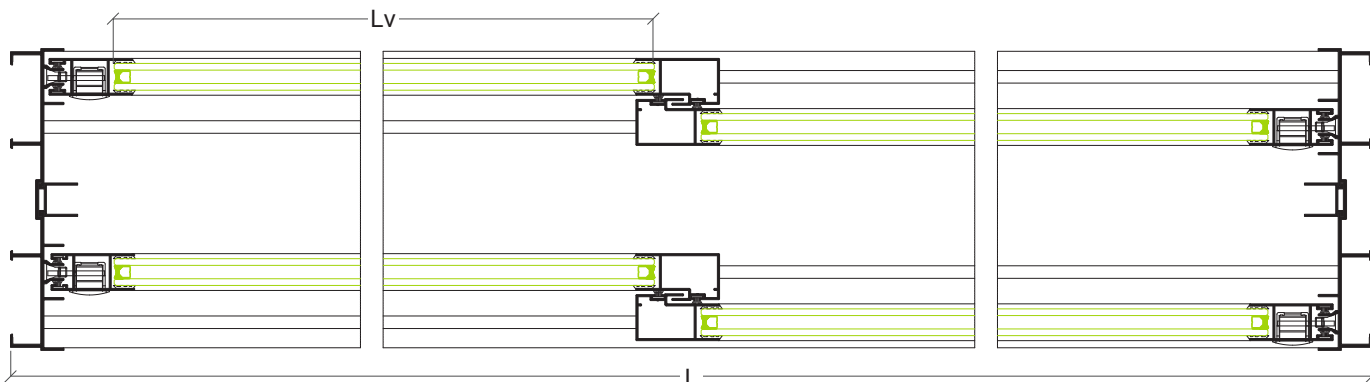

Janela 3 folhas correr tri-rail

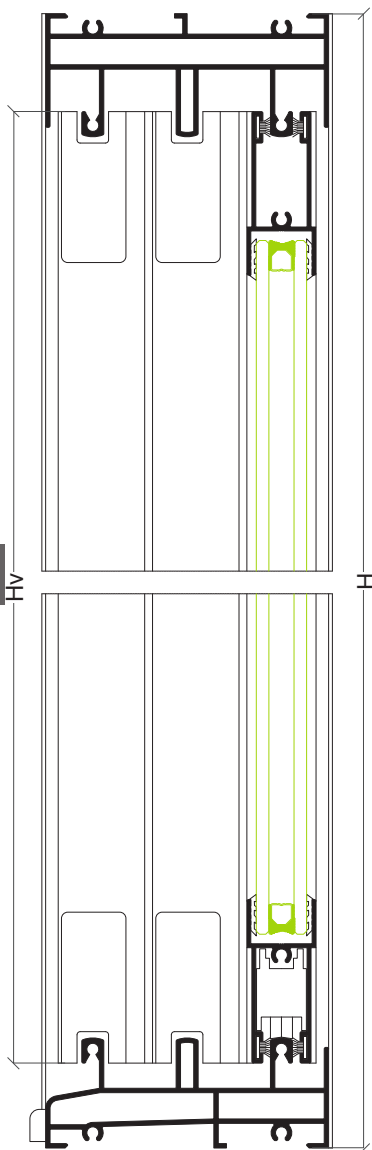
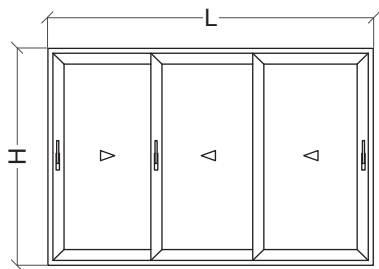

Perfis

Desenho	Ref	Descrição	Corte	Quant	Medida
	CM-45	Padeieira tri-rail		1	L-40 mm
	CM-41	Soleira tri-rail		1	L-40 mm
	CM-46	Ombreira tri-rail		2	H
	CM-02	Móvel carrinho		4	L/3+2 mm
				2	L/3+15 mm
	CM-10	Móvel lateral		2	H-58 mm
	CM-09	Móvel central		4	H-58 mm

Acessórios e Juntas

Referência	Descrição	Quantidade
30 97 00 04	Kit correr CM 3 folhas	1
30 97 00 02	Fecho lateral	2
30 91 41 10	Taco anti-levantamento	2
30 95 00 40	Pelúcia 7x5.5 mm	2L+8H

Vidro

Hv = H-138 mm	Lv = L/3-60 mm
---------------	----------------

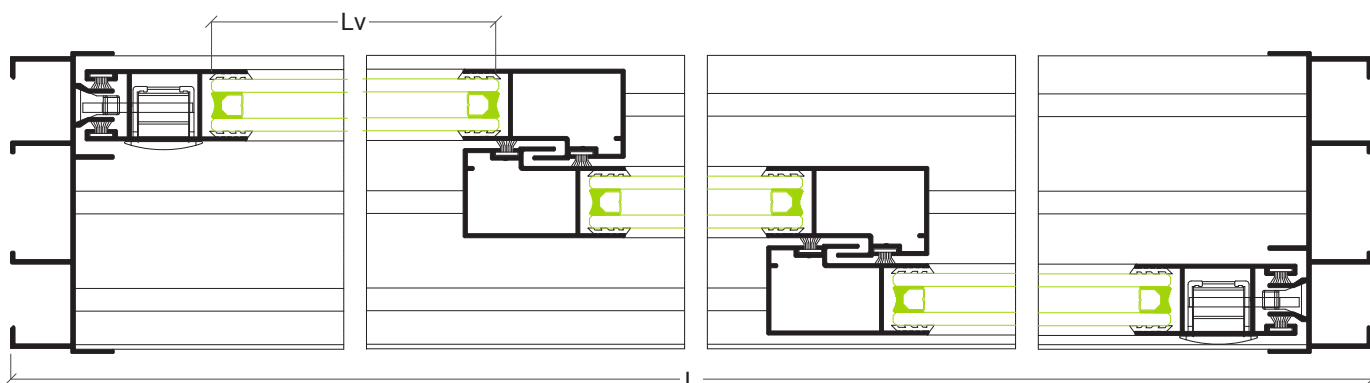

Janela 4 folhas correr

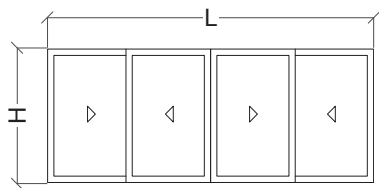

Perfis

Desenho	Ref	Descrição	Corte	Quant	Medida
	CM-15	Padieira		1	L-40 mm
	CM-11	Soleira		1	L-40 mm
	CM-26	Ombreira		2	H
	CM-02	Móvel carrinho		8	L-4-3 mm
	CM-10	Móvel lateral		4	H-54 mm
	CM-09	Móvel central		4	H-54 mm
	CM-28	União 3/4F		1	H-54 mm

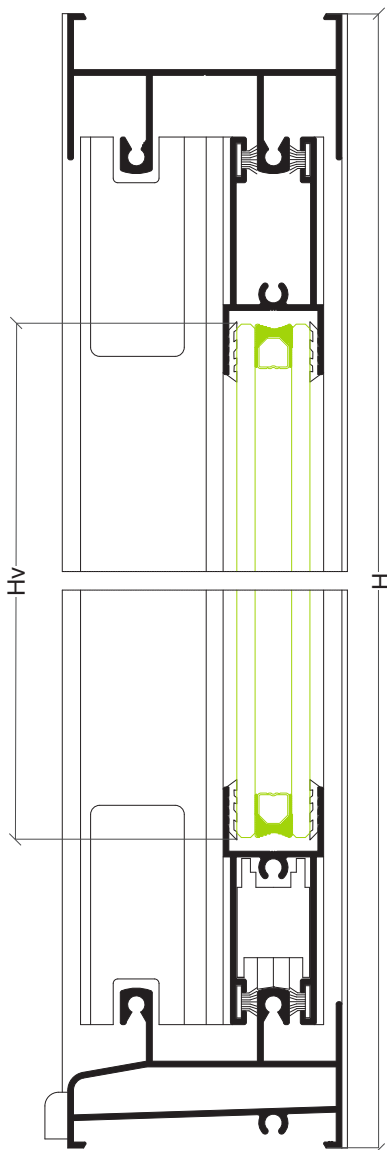

Acessórios e Juntas

Referência	Descrição	Quantidade
30 97 00 01	Kit correr CM 2 folhas	2
30 97 00 02	Fecho lateral	3
30 91 41 10	Taco anti-levantamento	3
30 95 00 40	Pelúcia 7x5.5 mm	4L+10H

383

Vidro



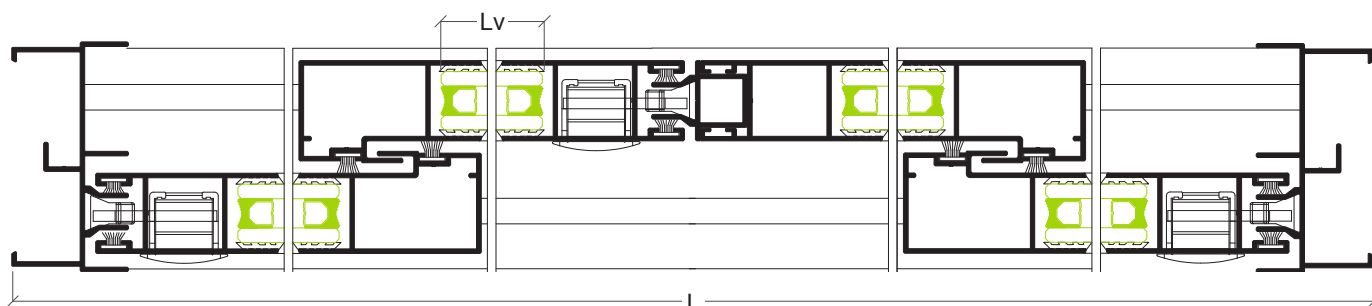



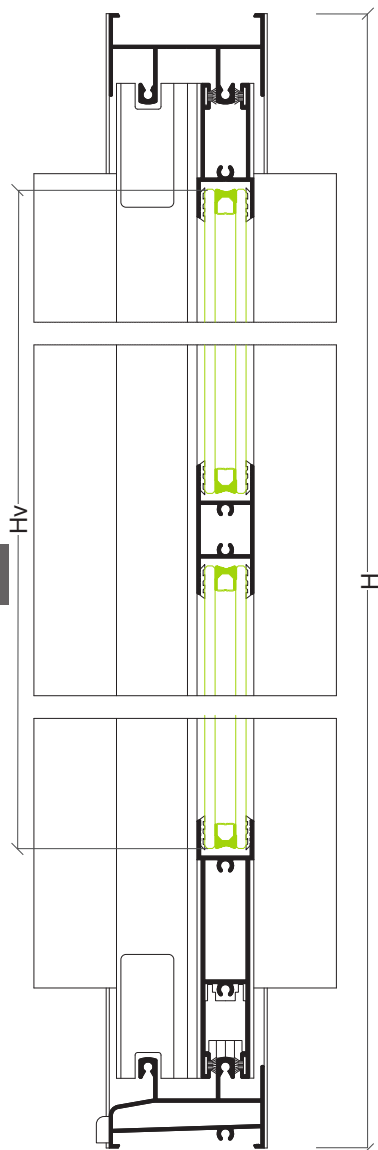
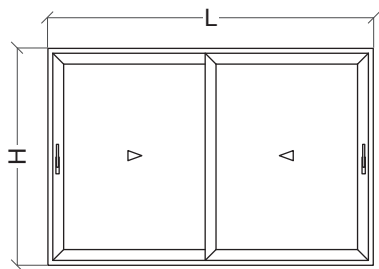













Hv = H-134 mm	Lv = L/4-66 mm
---------------	----------------



Porta 2 folhas correr



Perfis

Desenho	Ref	Descrição	Corte	Quant	Medida
	CM-15	Padieira		1	L-40 mm
	CM-11	Soleira		1	L-40 mm
	CM-26	Ombreira		2	H
	CM-02	Móvel carrinho		2	L/2-16 mm
	CM-10	Móvel lateral		2	H-54 mm
	CM-09	Móvel central		2	H-54 mm
	CM-54	Travessa		2	L/2-70 mm
	CM-52	Almofada carrinho		2	L/2-16 mm
	CT-27	Reforço		2	H-124 mm
	AX-19	Vareta		2	H-124 mm

Acessórios e Juntas

Referência	Descrição	Quantidade
30 97 00 01	Kit correr CM 2 folhas	1
30 97 00 02	Fecho lateral	2
30 91 41 35	Jogo tampas CT-27	2
30 91 41 10	Taco anti-levantamento	2
30 95 00 40	Pelúcia 7x5.5 mm	4L+6H

Vidro

Hv = H1-131 mm	Lv = L/2-77 mm
Hv = H2-83 mm	Lv = L/2-77 mm

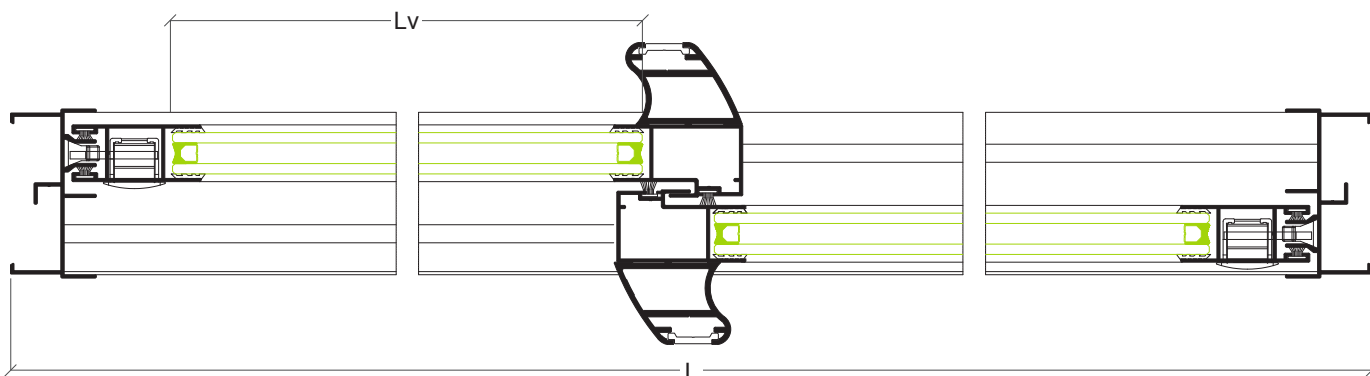

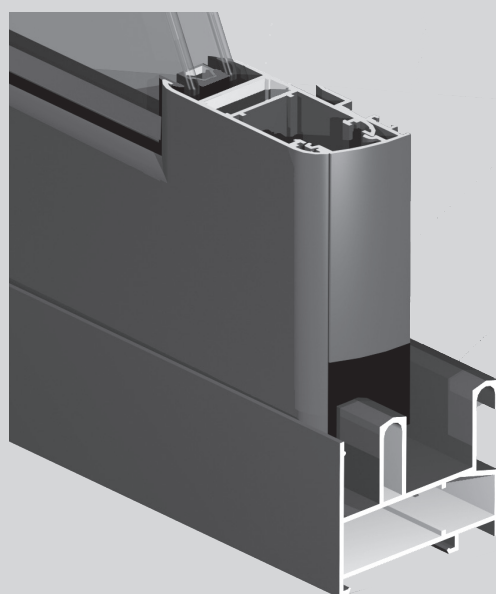
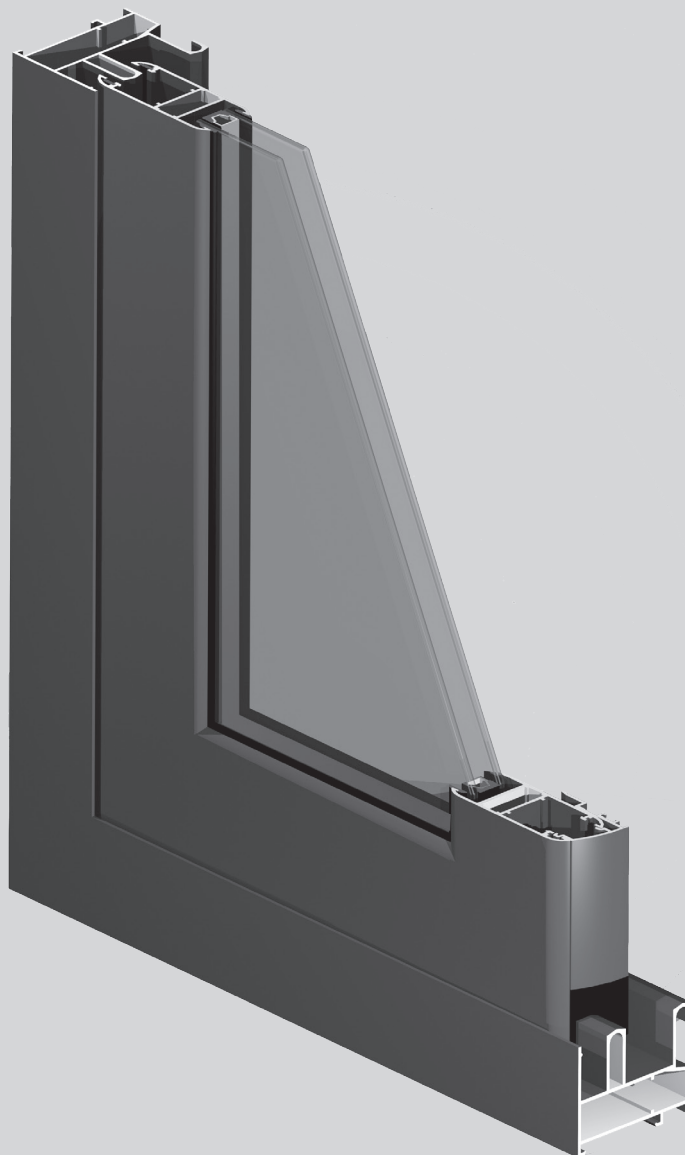

Sistema

CP

Sistema CP

Sistema de correr - 45 mm

Características do sistema

Sistemas de alumínio para execução de vãos de correr.

Perfis de alumínio

Os perfis de alumínio são extrudidos na liga de alumínio 6060 para arquitetura de acordo com norma NP EN 12020-02.

Espessura média dos perfis de alumínio de 1.5 mm.

Aros fixos

Secção do aro fixo perimetral de 2 guias de 40, 45 ou 60 mm para montagem a meia esquadria;

Secção do aro fixo perimetral de 3 guias de 80 mm para montagem a meia esquadria.

Aros móveis

Secção dos aros móveis perimetrais de 26 ou 27.5 mm para montagem a meia esquadria;

Enchimento de 4 mm a 18 mm;

Aros móveis de linha recta ou curva;

Estanquidade assegurada através de pelúcia tipo Fin-Seal.

Dimensionamento e manobralidade

Peso máximo de 100 kg por folha (com 2 rolamentos duplos);

Possibilidades de abertura: 2, 3, 4 e 6 folhas, com folhas móveis e/ou fixas;

Sistema compatível com os sistemas de batente AZ e AX.

Performances

Sistema certificado por laboratório notificado do ensaio tipo inicial (ITT) de acordo com a norma de produto EN 14351-1 para efeitos de Marcação CE.

Categorias alcançadas na avaliação do sistema CP tipologia janela:

1. Permeabilidade ao ar: Classe 3 (norma de ensaio EN 1026)
2. Estanquidade à água: Classe 7A (norma de ensaio EN 1027)
3. Resistência ao vento: Classe C3 (norma de ensaio EN 12211)

Categorias alcançadas na avaliação do sistema CP tipologia porta:

1. Permeabilidade ao ar: Classe 4 (norma de ensaio EN 1026)
2. Estanquidade à água: Classe 7A (norma de ensaio EN 1027)
3. Resistência ao vento: Classe C1 (norma de ensaio EN 12211)

Coefficiente de transmissão térmica de vão de 2 folhas com 1.20 m x 2.20 m com vidro $U_g = 1.8 \text{ W/m}^2\text{K}$:

• $U_w = 3.34 \text{ W/m}^2\text{K}$

Coefficiente de atenuação acústica de vão de 2 folhas com vidro 4/10/4:

• $R_w (C; C_{tr}) = 28 \text{ dB} (-1; -1)$

Zonas de aplicação segundo RCCTE (em função do valor U_g): I1, I2, I3, V1, V2, V3;

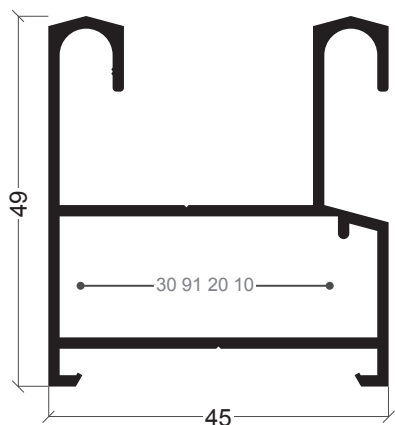

CP-01
Aro fixo

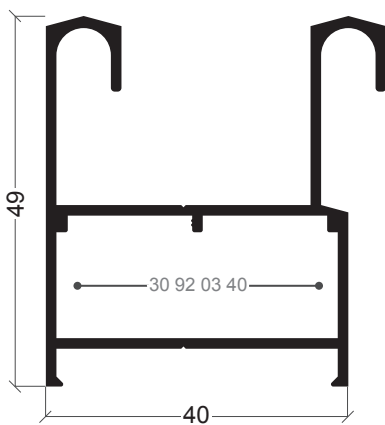

CP-17
Aro fixo

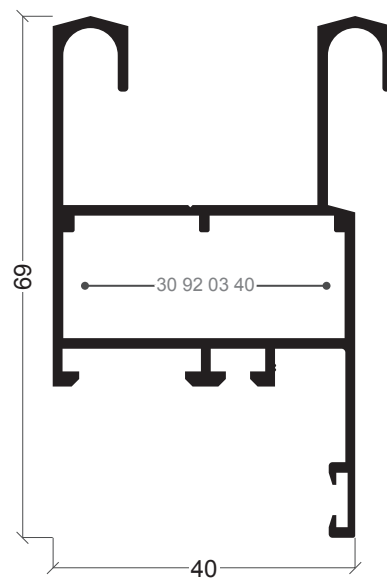

CP-18
Aro fixo

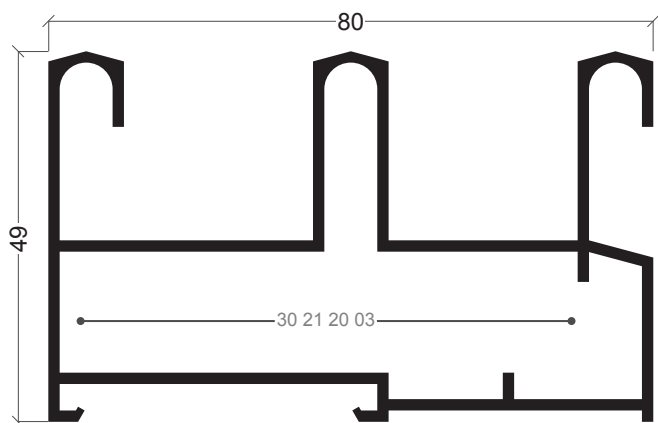

CP-05
Aro fixo

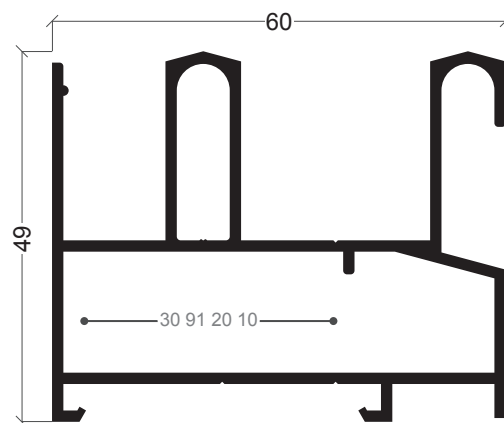

CP-10
Aro fixo

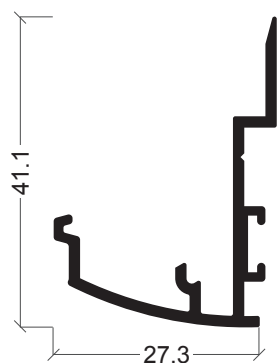

CP-12
Tampa cruzamento CP-11/20

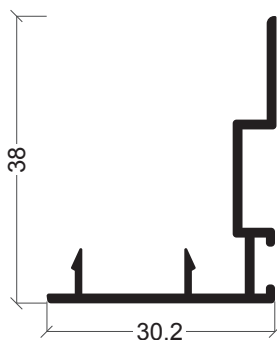

CP-15
Tampa cruzamento CP-13

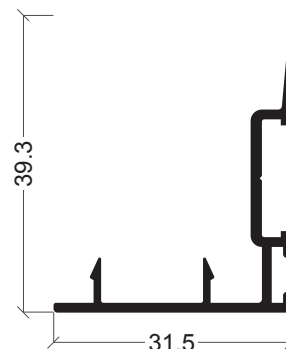

CP-03
Tampa cruzamento CP-02/04/07

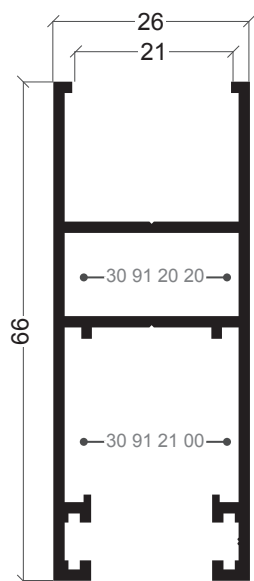

CP-02
Aro móvel

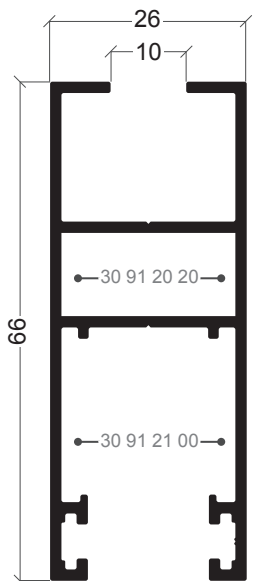

CP-04
Aro móvel

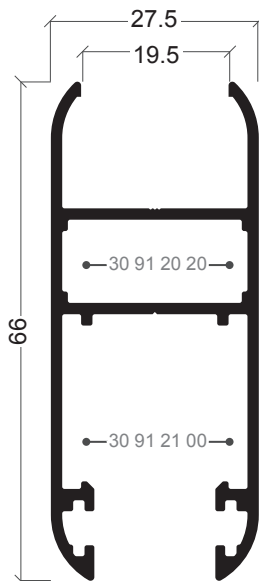

CP-11
Aro móvel

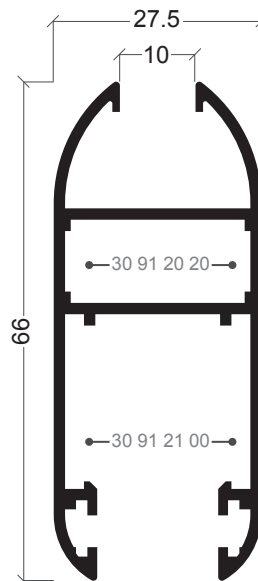

CP-20
Aro móvel

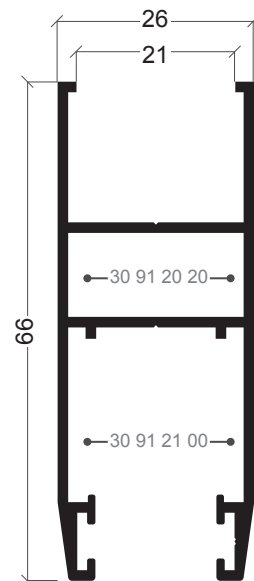

CP-13
Aro móvel

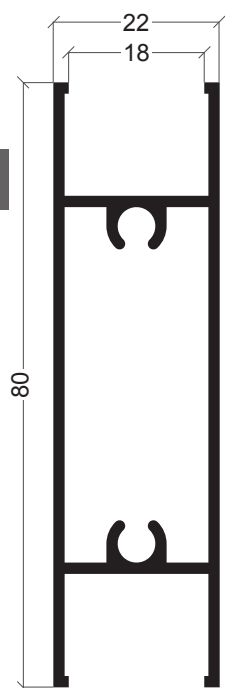

CP-08
Travessa

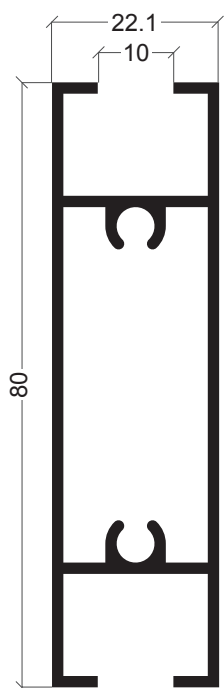

CP-09
Travessa

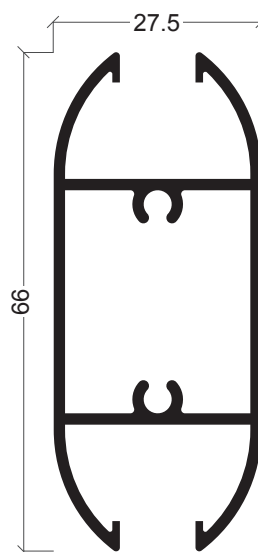

CP-22
Travessa

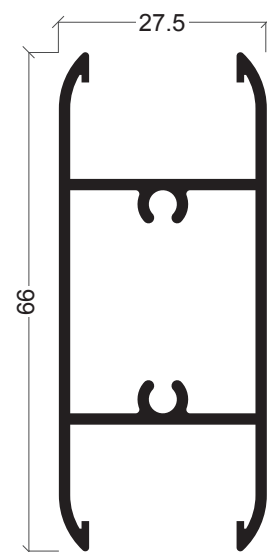

CP-23
Travessa

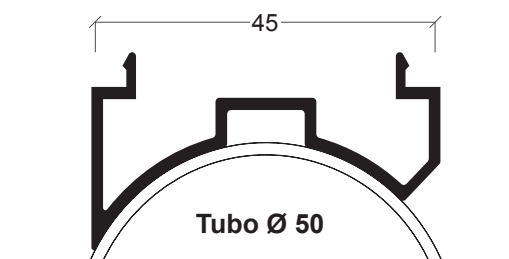

CP-16
Comp. p/ ângulo

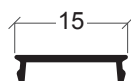

KL-04
Tampa

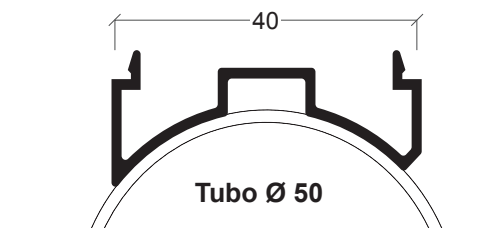

CP-19
Comp. p/ ângulo

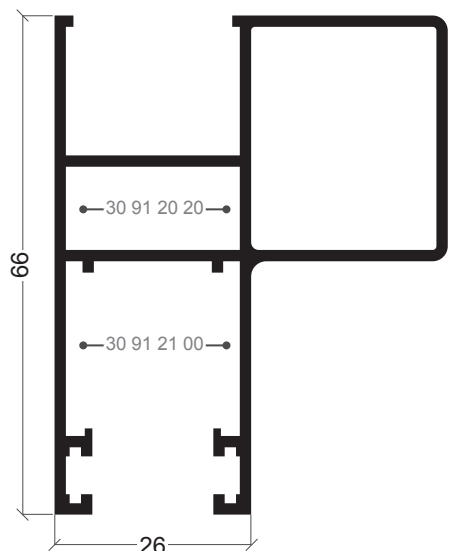

CP-07
Aro móvel com reforço

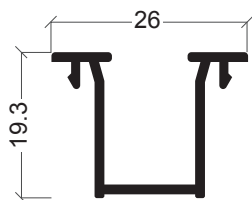

CP-14
Redutor vidro simples



AX-19
Vareta

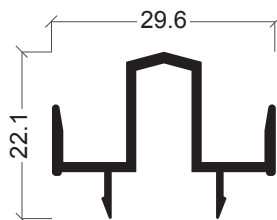

CP-06
União 3/4 F

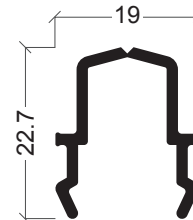

CP-21
União 3/4 F

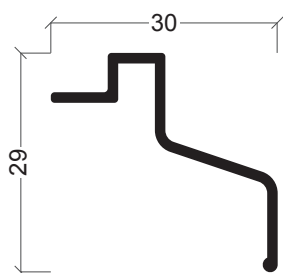

AXi-45
Pingadeira superior

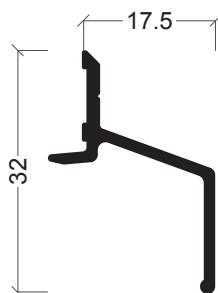

CT-29
Pingadeira superior

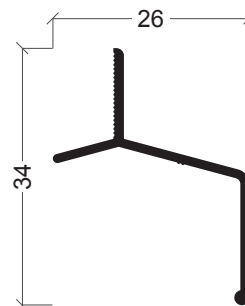

CT-07
Pingadeira superior

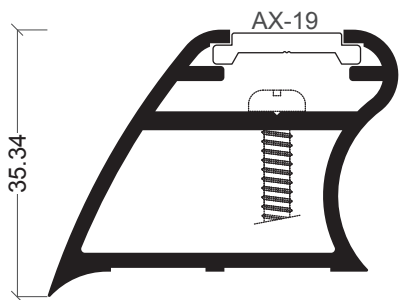

CT-03
Reforço

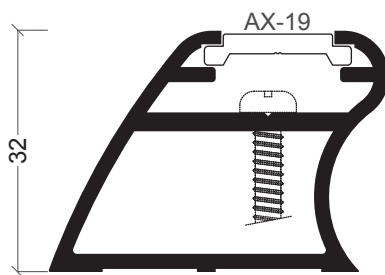

CT-27
Reforço

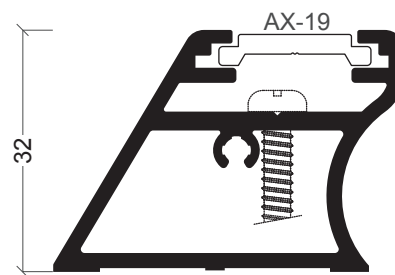

CT-28
Reforço

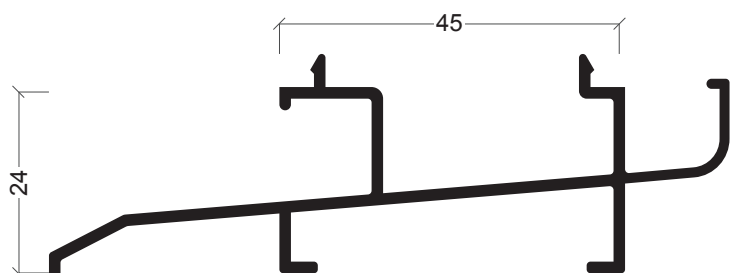

AX-17
Soleira condensação

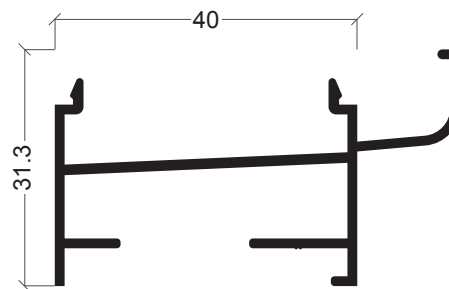

AZ-19
Soleira condensação

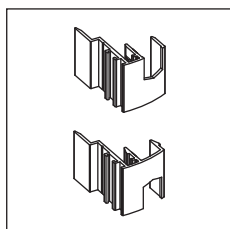

30 20 20 02

Jogo tampas centrais
CP-12

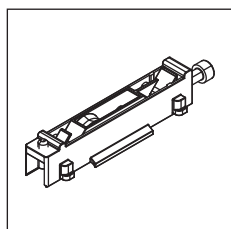

30 20 20 03

Rolamentos simples
(25 kg)

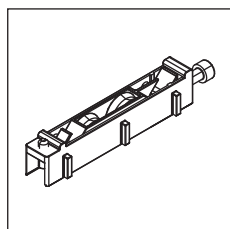

30 20 20 05

Rolamentos duplos
(25 kg)

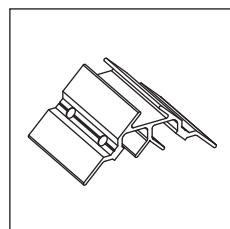

30 21 20 03

Esquadro CP-05

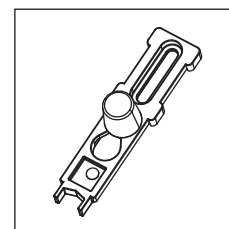

30 21 20 04

Guia lateral batente

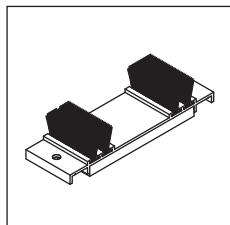

30 21 20 05

Corta-ventos CP-05/10

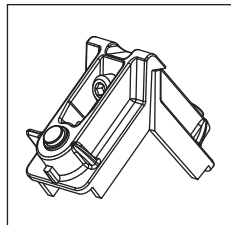

30 91 20 10

Esquadro CP-01/10

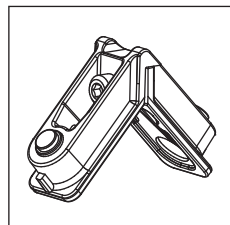

30 91 20 20

Esquadro aro móvel

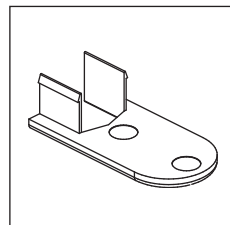

30 91 20 40

Tampa guia lateral

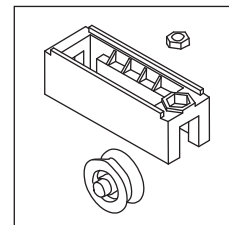

30 91 20 50

Rolamentos (20 kg)

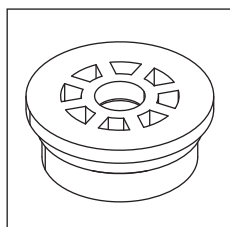

30 91 20 60

Canal

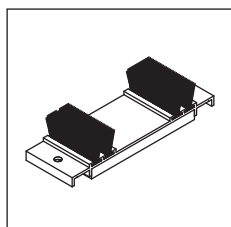

30 91 20 70

Corta-ventos
CP-01/05/17/18

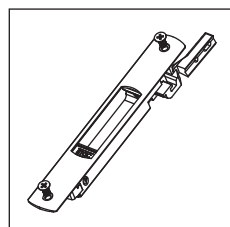

30 91 20 80/81

Fecho lateral branco/
preto

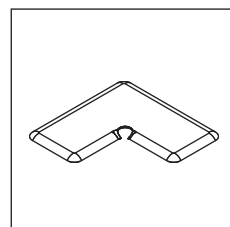

30 91 21 00

Esquadro alinhamento
móvel

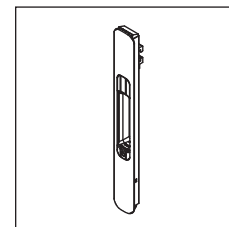

30 91 40 39/40/41

Fecho lateral manual
natural/branco/preto

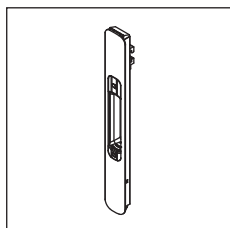

30 91 40 42/43

Fecho lateral automatico
branco/preto

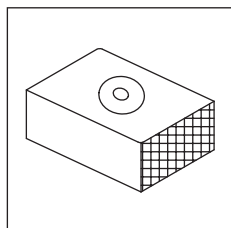

30 91 41 10

Taco anti-levantamento
preto

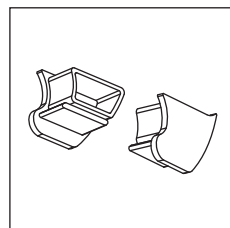

30 91 41 35

Jogo tampas CT-03

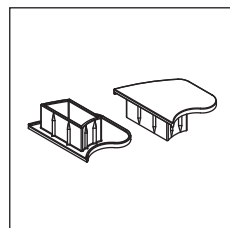

30 91 41 63/64

Jogo topos CT-27
branco/preto

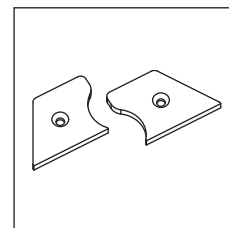

30 91 41 65/66

Jogo topos CT-28
branco/preto

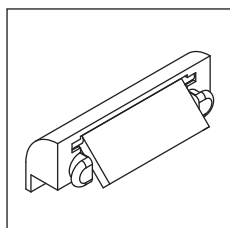

30 92 01 02/03

Goteiras branco/preto

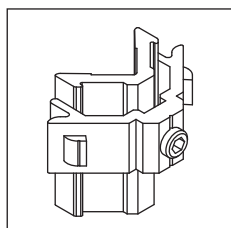

30 92 03 40

Esquadro janela
CP-17/18

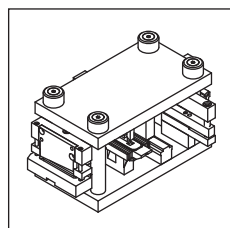

33 92 99 99

Cunho CP

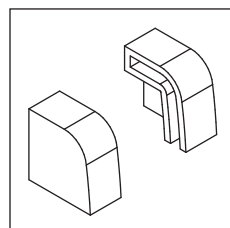

30 96 00 12

Jogo topos condensação

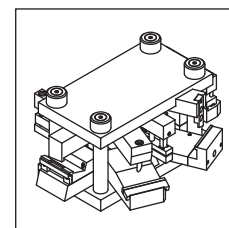

33 96 79 99







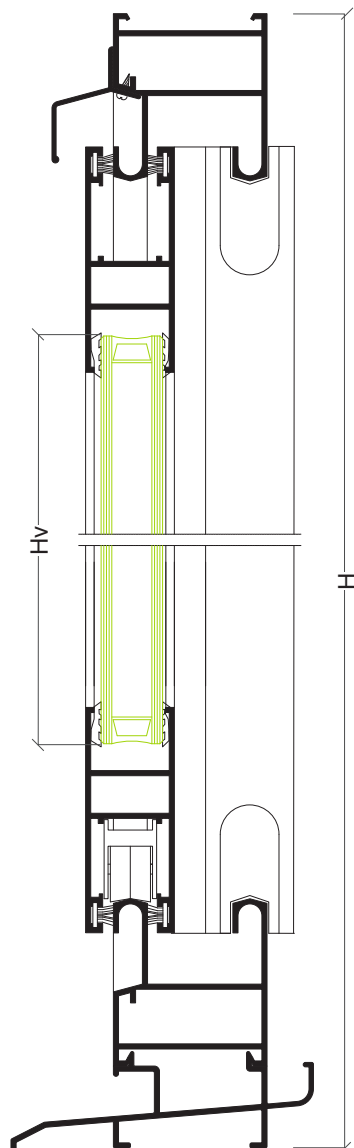
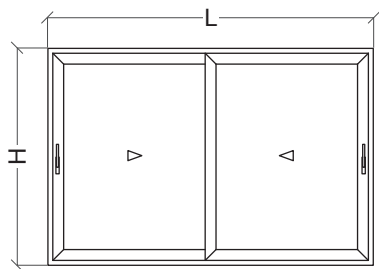







Cunho CE para
CP-17/18

Referência	Desenho	Descrição
30 93 00 65		Junta interior para vidro (5 mm)
30 93 00 66		Junta interior para vidro (4 mm)
30 93 00 67		Junta interior para vidro (2 mm)
30 93 00 68		Junta interior para vidro (6/7 mm)
30 93 00 69		Junta interior para vidro (8/9 mm)
30 95 00 30		Pelúcia 7x7 mm

Janela 2 folhas correr



Perfis

Desenho	Ref	Descrição	Corte	Quant	Medida
	CP-01	Aro fixo		2	L
				2	H-24 mm
	CP-02	Aro móvel		4	L/2-6 mm
				4	H-103 mm
	CP-03	Tampa de cruzamento CP-02		1	H-103 mm
	CT-07	Pingadeira		1	L
	AX-17	Soleira de condensação		1	L
	KL-04	Tampa		2	H-103 mm

Acessórios e Juntas

Referência	Descrição	Quantidade
30 21 20 04	Guia lateral batente	4
30 91 20 10	Esquadro CP-01	4
30 91 20 20	Esquadro aro móvel	8
30 91 20 40	Tampa guia lateral	4
30 91 20 50	Rolamentos	4
30 91 20 60	Canal	2
30 91 20 70	Corta ventos superior/inferior	2
30 91 20 80	Fecho lateral	2
30 91 21 00	Esquadros alinhamento	16
30 96 00 12	Jogo topos condensação	1
30 92 01 02	Goteira com válvula	2
30 91 41 10	Taco anti-levantamento	2
30 95 00 30	Pelúcia 7x7 mm	4L/6H
-----	Junta para vidro	4L/8H

391

Vidro

Hv = H-208 mm	Lv = L/2-111 mm
---------------	-----------------

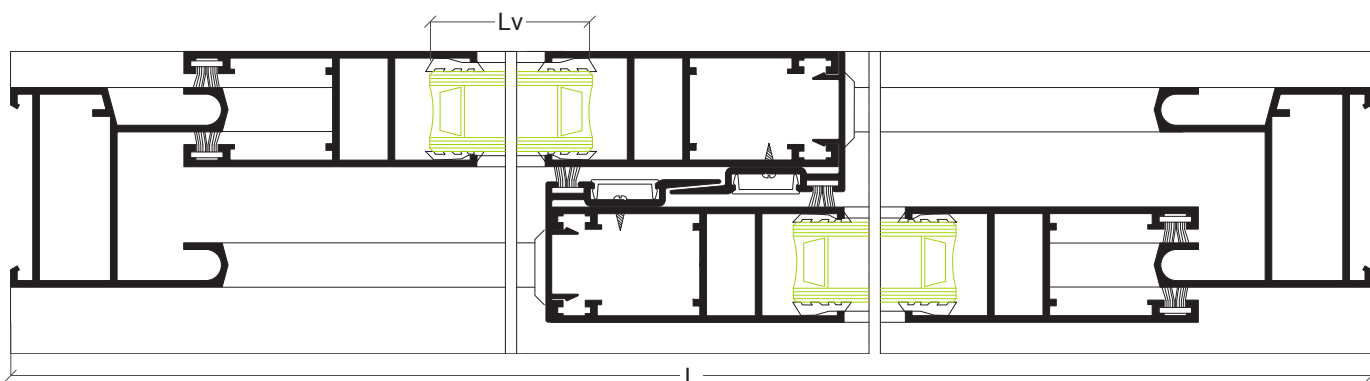

Janela 3 folhas correr tri-rail

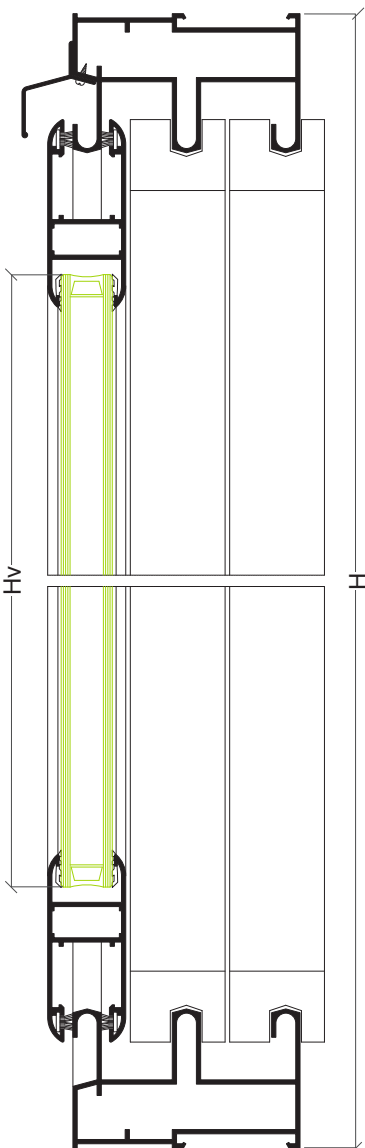
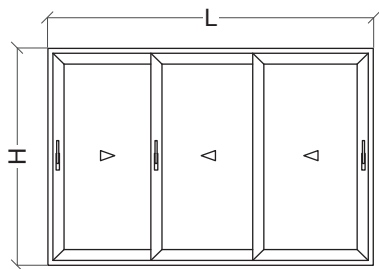

Perfis

Desenho	Ref	Descrição	Corte	Quant	Medida
	CP-05	Aro fixo		2	L
				2	H
	CP-11	Aro móvel		6	L/3+15 mm
				6	H-75 mm
	CP-12	Tampa de cruzamento CP-11		4	H-125 mm
	CT-07	Pingadeira		1	L

Acessórios e Juntas

Referência	Descrição	Quantidade
30 20 20 02	Jogo tampas centrais	4
30 21 20 03	Esquadro aro fixo	4
30 21 20 04	Guia lateral batente	4
30 21 20 05	Corta-ventos superior/inferior	2
30 91 20 20	Esquadro aro móvel	12
30 91 20 50	Rolamentos	6
30 91 20 60	Canal	4
30 91 20 70	Corta-ventos superior/inferior	2
30 91 20 80	Fecho lateral	2
30 91 21 00	Esquadros alinhamento	24
30 92 01 02	Goteira com válvula	3
30 91 41 10	Taco anti-levantamento	2
30 95 00 30	Pelúcia 7x7 mm	4L/6H
----	Junta para vidro	4L/12H

Vidro



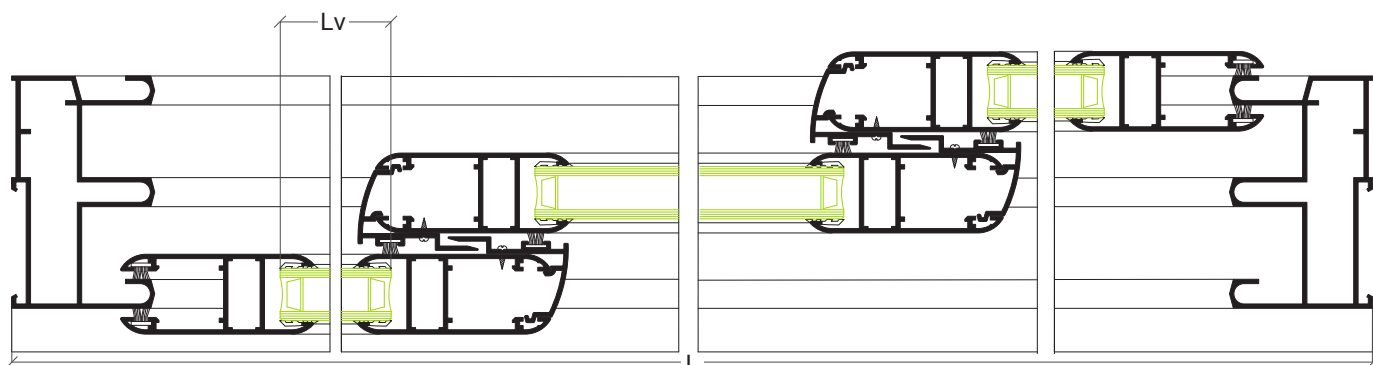



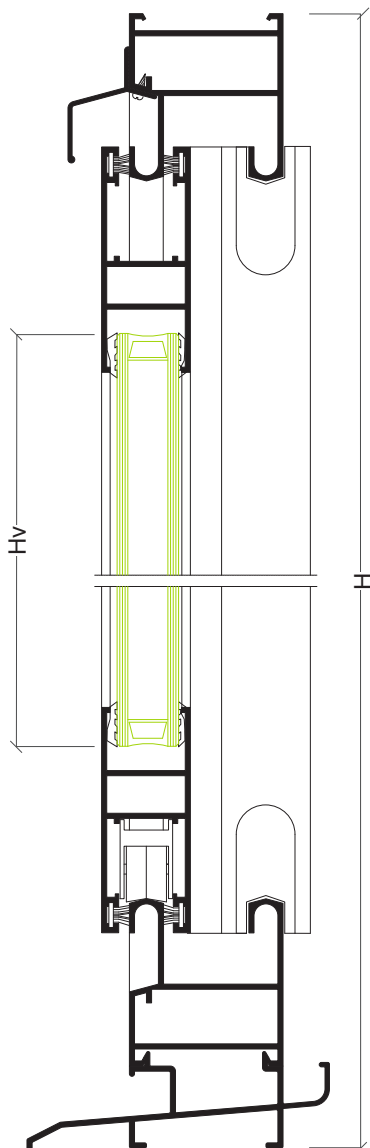
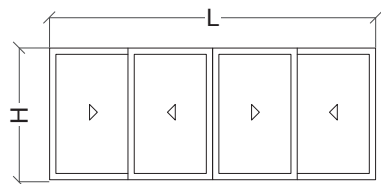









Hv = H-184 mm	Lv = L/3-94 mm
---------------	----------------



Janela 4 folhas correr

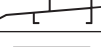

Perfis

Desenho	Ref	Descrição	Corte	Quant	Medida
	CP-01	Aro fixo		2	L
				2	H-24 mm
	CP-02	Aro móvel		8	L/4+11.5 mm
				8	H-103 mm
	CP-03	Tampa de cruzamento CP-02		4	H-103 mm
	CT-07	Pingadeira		1	L
	CP-06	União 4 folhas		1	H-103 mm
	AX-17	Soleira de condensação		1	L
	KL-04	Tampa		4	H-103 mm

Acessórios e Juntas

Referência	Descrição	Quantidade
30 21 20 04	Guia lateral batente	6
30 91 20 10	Esquadro aro fixo	4
30 91 20 20	Esquadro aro móvel	16
30 91 20 40	Tampa lateral	8
30 91 20 50	Rolamentos	8
30 91 20 60	Canal	4
30 91 20 70	Corta ventos superior/inferior	6
30 91 20 80	Fecho lateral	3
30 91 21 00	Esquadro alinhamento	32
30 91 00 12	Jogo topos condensação	1
30 92 01 02	Goteira com válvula	4
30 91 41 10	Taco anti-levantamento	2
30 95 00 30	Pelúcia 7x7 mm	4L/10H
-----	Junta para vidro	4L/16H

393

Vidro

Hv = H-208 mm	Lv = L/4-94 mm
---------------	----------------

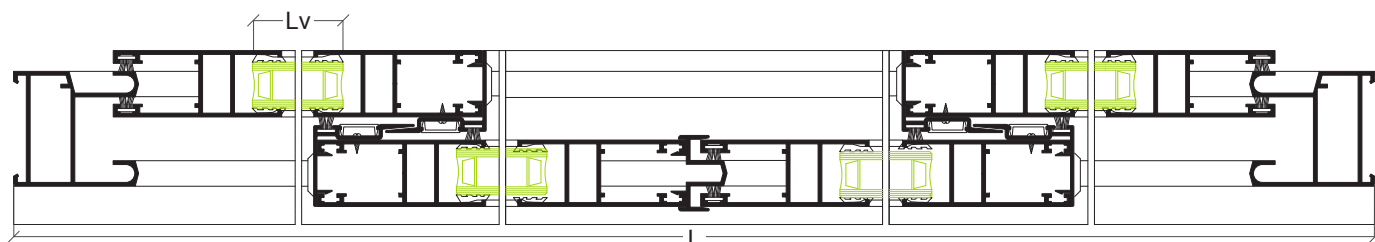

Porta 2 folhas correr

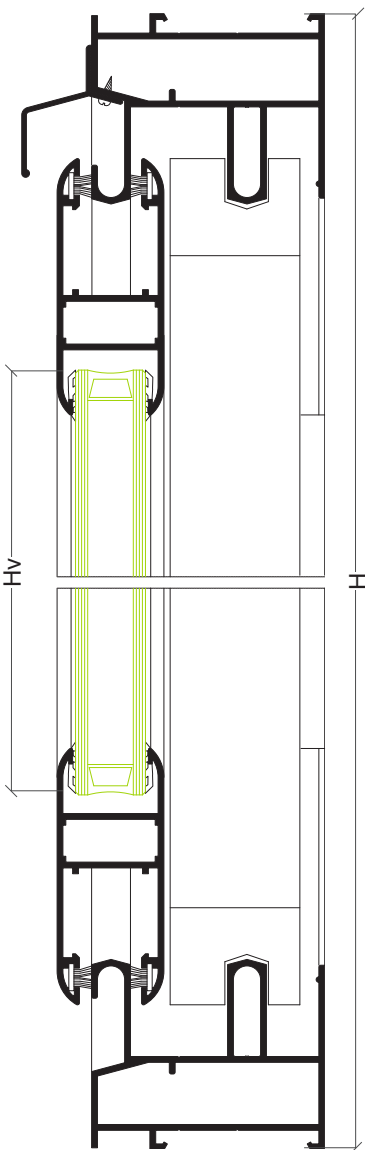
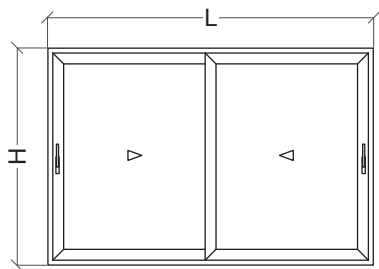

Perfis

Desenho	Ref	Descrição	Corte	Quant	Medida
	CP-10	Aro fixo		2	L
				2	H
	CP-11	Aro móvel		4	L/2-7 mm
				4	H-75 mm
	CP-12	Tampa de cruzamento CP-11		2	H-125 mm
	CT-07	Pingadeira		1	L
	AX-19	Vareta		2	H-206 mm
	CT-03	Reforço		2	H-206 mm

Acessórios e Juntas

Referência	Descrição	Quantidade
30 20 20 02	Jogo tampas centrais	2
30 20 20 04	Rolamentos duplos	4
30 21 20 04	Guia lateral batente	4
30 21 20 05	Corta-ventos superior/inferior	2
30 91 20 10	Esquadro aro fixo	4
30 91 20 20	Esquadro aro móvel	8
30 91 41 35	Jogo tampas CT-03	2
30 91 20 60	Canal	2
30 91 21 80	Fecho lateral	2
30 91 21 00	Esquadro alinhamento	16
30 92 01 02	Goteira com válvula	2
30 91 41 10	Taco anti-levantamento	2
30 95 00 30	Pelúcia 7x7 mm	4L/6H
-----	Junta para vidro	4L/16H

Vidro

Hv = H-184 mm	Lv = L/2-116 mm
---------------	-----------------

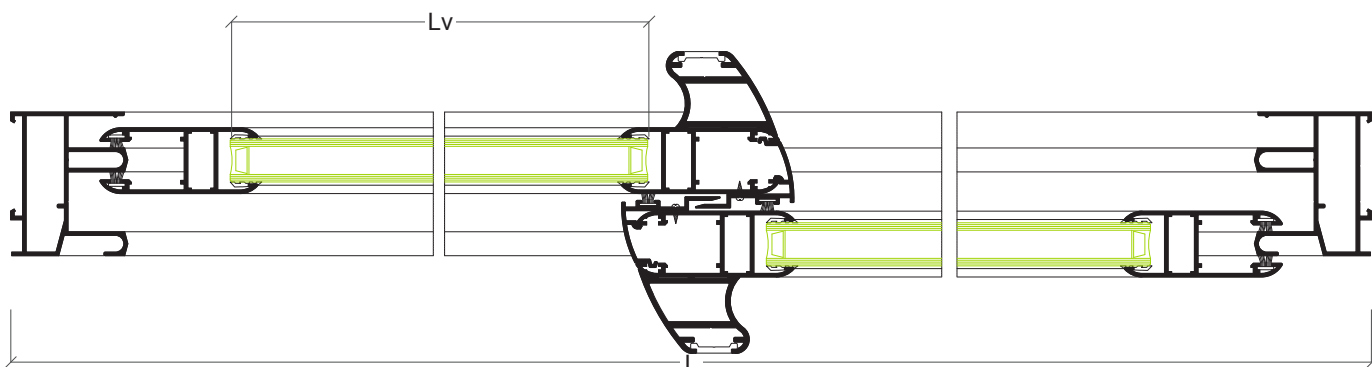

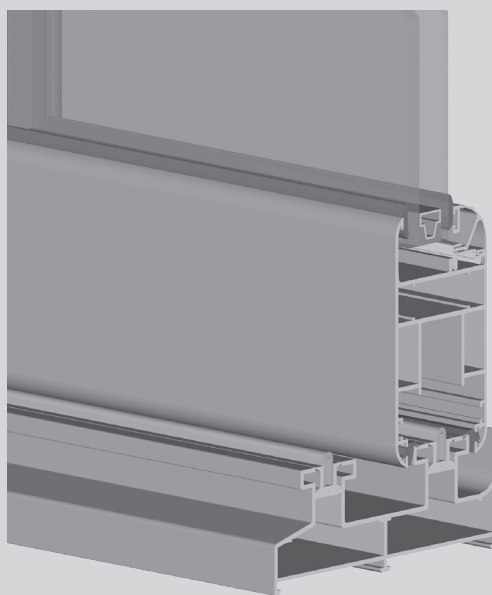
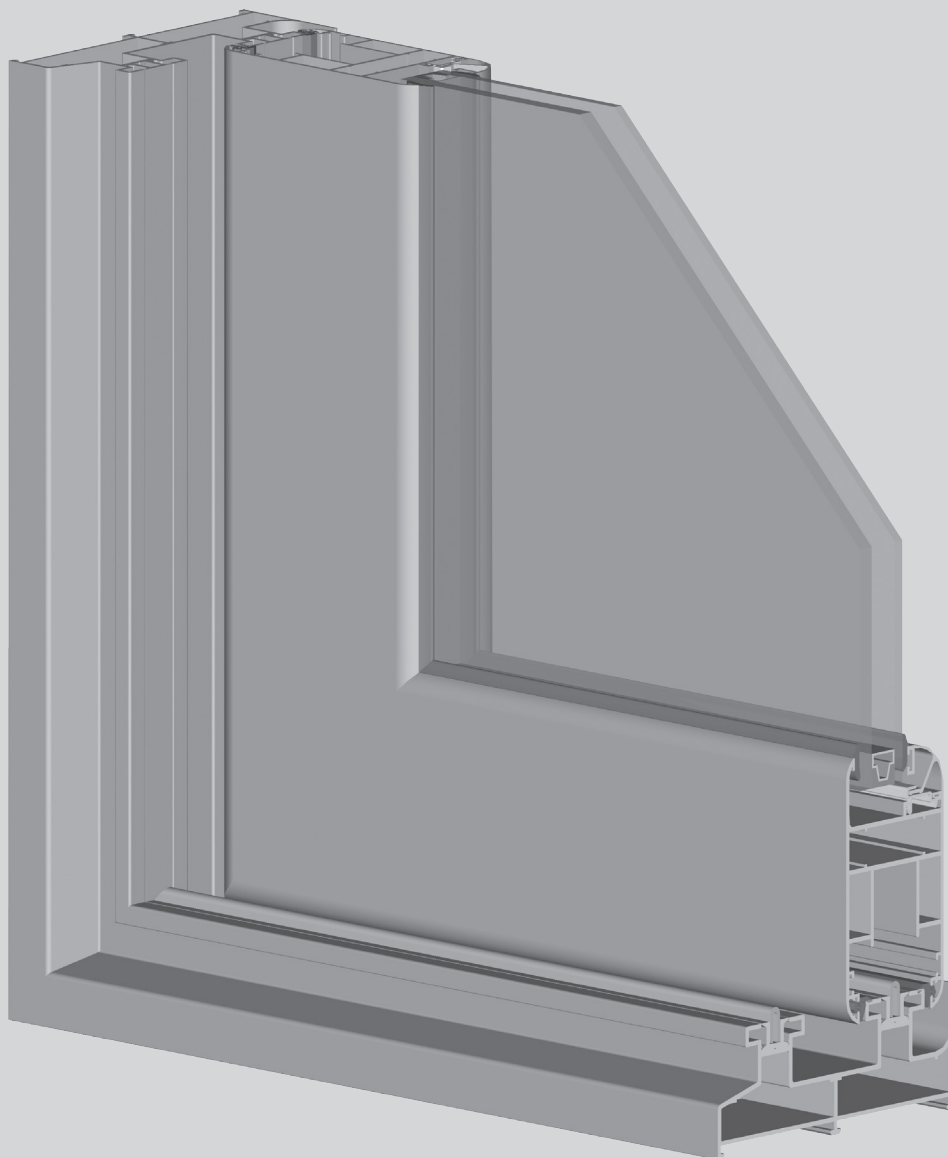

Sistema

CK

Sistema CK

Sistema de correr - 120 mm

Características do sistema

Sistema de alumínio para execução de vãos de correr ou correr/eleváveis.

Perfis de alumínio

Os perfis de alumínio são extrudidos na liga de alumínio 6060 para arquitetura de acordo com norma NP EN 12020-02.

Espessura média dos perfis de alumínio de 1.7 mm.

Aros fixos

Secção do aro fixo perimetral de 2 guias de 122 mm para montagem a meia esquadria;

Secção do aro fixo perimetral de 3 guias (Tri-Rail) de 184 mm para montagem a meia esquadria;

Perfil guia de deslizamento inferior em aço inoxidável 304 para evitar desgaste das peças.

Aros móveis

Secção dos aro móvel perimetral de 50.6 mm com montagem a meia esquadria;

Enchimento de 4 mm a 38 mm;

Bites rectos ou curvos;

Estanquidade assegurada através de juntas em EPDM e pelúcia tipo Fin-Seal.

Dimensionamento e manobralidade

Dimensões mínimas - máximas de folha: 720 mm – 3350 mm (L); 1190 mm - 2690 mm (H), com possibilidade de, aplicando prolongador, altura máxima = 3325 mm;

Peso máximo de 250 kg por folha com rolamentos duplos reguláveis;

Peso máximo de 300 kg por folha com ferragem elevável base com opção de 400kg por folha com kit suplementar;

Possibilidades de abertura: 2, 3, 4 ou 6 folhas, com folhas móveis e/ou fixas;

Sistema de correr-elevável com funcionamento baseado numa ferragem aplicada em conjunto com as folhas e que permite a elevação destas aquando da sua fácil abertura mesmo com configurações extremas de peso ou de dimensões;

Quando fechada, a folha comprime as juntas de EPDM permitindo uma estanquidade perimetral perfeita;

Ferragem base com 2 pontos de fecho e com possibilidade de acrescentar mais 1 ou 2 pontos suplementares;

Ferragem base com micro-ventilação;

Ferragem constituída com carrinhos de 4 rodas em PVC reforçadas com fibra de vidro e rolamentos de agulha de alta prestação;

Puxador específico para facilitar as manobras de abertura e fecho do vão;

Existe opção com puxador duplo, com colocação de canhão com chave, para permitir abertura pelo exterior.

396

Performances

Sistema certificado por laboratório notificado do ensaio tipo inicial (ITT) de acordo com a norma de produto EN 14351-1 para efeitos de Marcação CE.

Categorias alcançadas na avaliação do sistema CK:

1. Permeabilidade ao ar: Classe 3 (norma de ensaio EN 1026)
2. Estanquidade à água: Classe 6A (norma de ensaio EN 1027)
3. Resistência ao vento: Classe C2 (norma de ensaio EN 12211)

Coeficiente de transmissão térmica de vão de 2 folhas com 5.0 m x 2.50 m com vidro $U_g = 0.7 \text{ W/m}^2\text{K}$ com intercalar efeito "Warm Edge":

• $U_w = 1.90 \text{ W/m}^2\text{K}$

Coeficiente de atenuação acústica de vão de 2 folhas com vidro 6/16/44.1 acústico:

• $R_w (C; C_{tr}) = 41 \text{ dB} (-1; -5)$

Zonas de aplicação segundo RCCTE (em função do valor U_g): I1, I2, I3, V1, V2, V3;

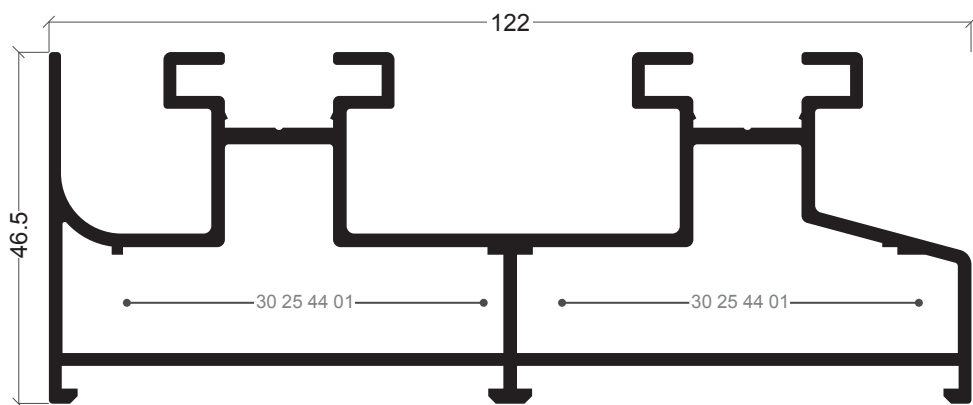

CK-01
Aro fixo perimetral

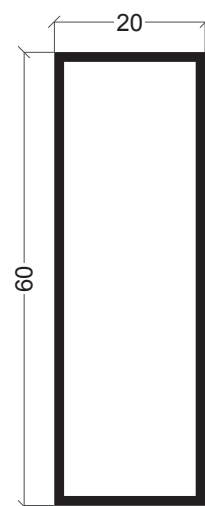

P-08
Tubo 60x20

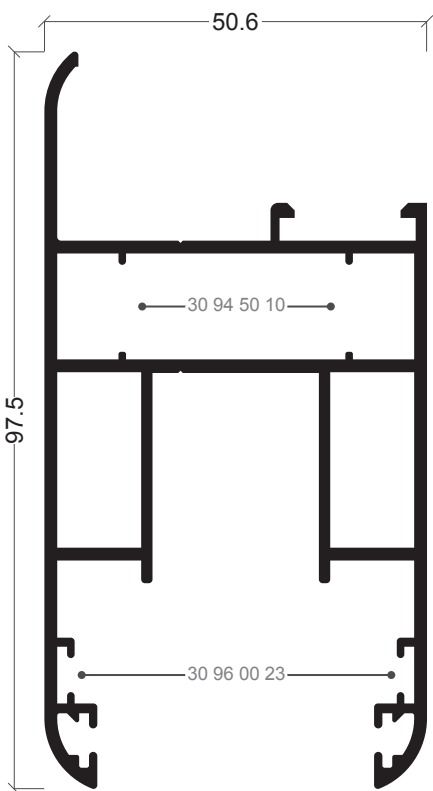

CK-02
Aro móvel perimetral

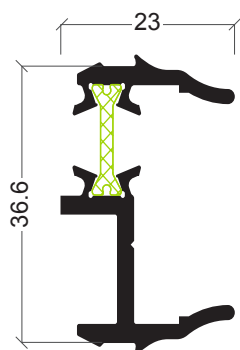

CTe-09
União 3/4 Folhas

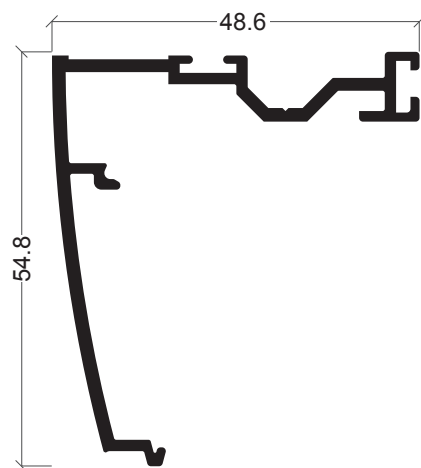

CK-06
Tampa cruzamento aro móvel



KL-04
Tampa



CTe-03
Guia Inox 304

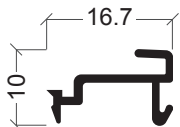

AX-33
Mola Bite

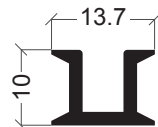

CK-04
Adaptador de guia

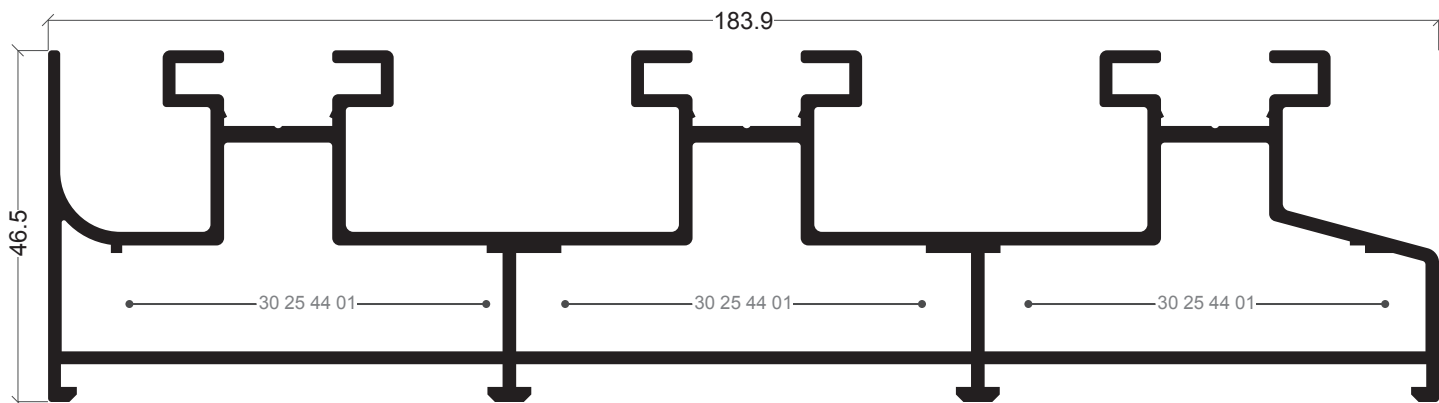

CK-05
Aro fixo perimetral tri-rail

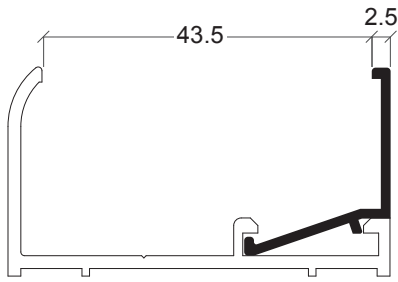

AX-69

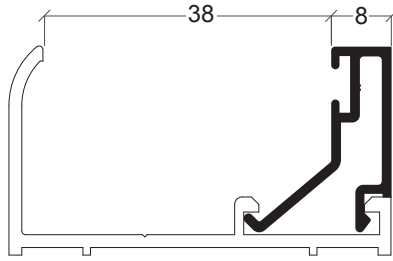

AX-74

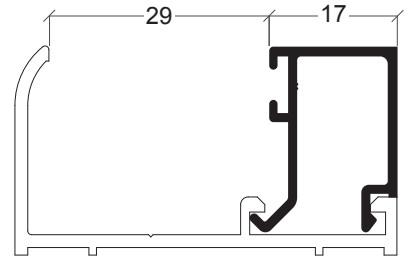

AX-46

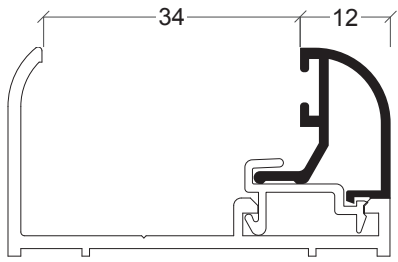

AX-37

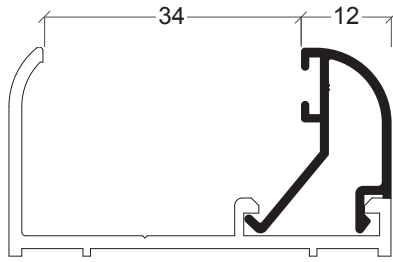

AZ-08

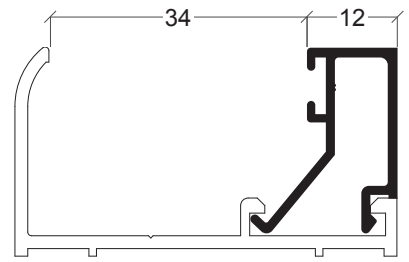

AX-36

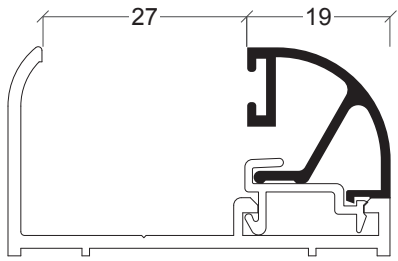

AX-30

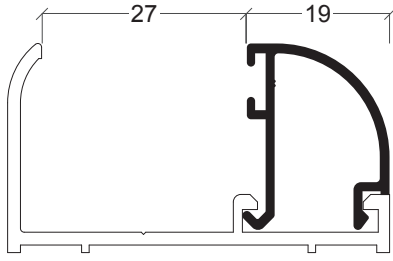

AZ-07

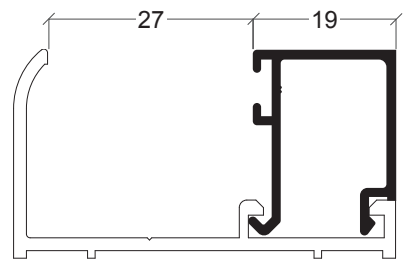

AX-35

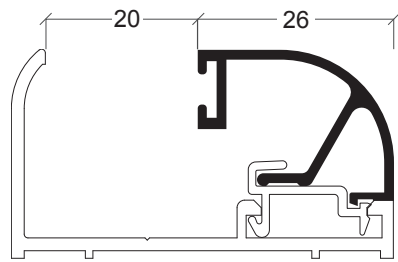

AX-29

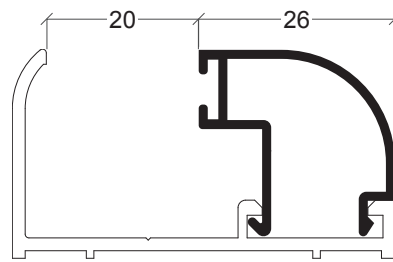

AZ-06

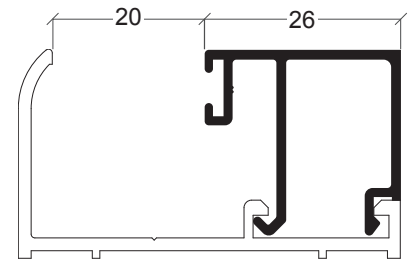

AX-31

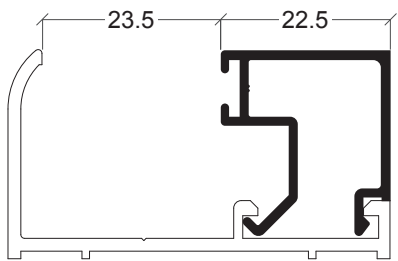

AX-78

398

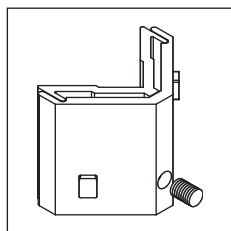

30 25 44 01

Esquadro aro fixo

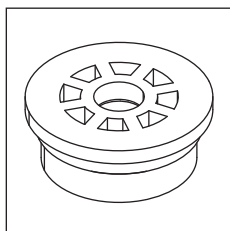

30 91 20 60

Canal para drenagem

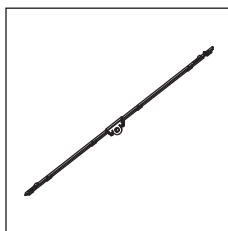

30 91 41 31

Barra 2 pontos com apoios (600 mm)

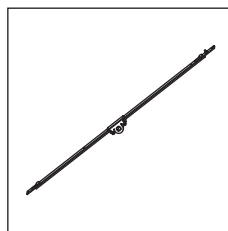

30 91 41 32

Barra 3 pontos com apoios (1670 mm)

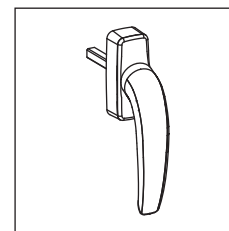

30 91 41 47/48

Cremone multi-ponto branco/preto

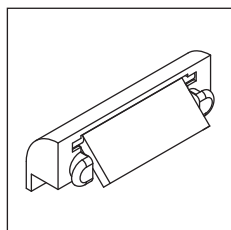

30 92 01 02/03

Goteira preto/branco

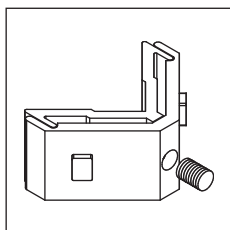

30 94 50 10

Esquadro

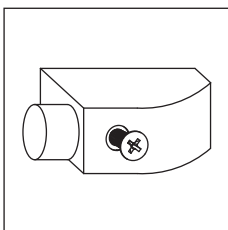

30 94 50 20

Limitador abertura

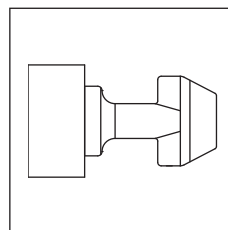

30 94 50 22

Ponto de fecho nº 1

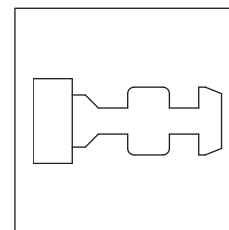

30 94 50 23

Ponto de fecho nº 2

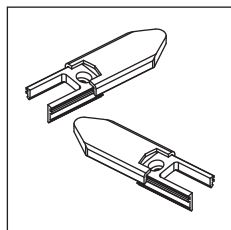

30 94 50 30

Jogo guia móvel

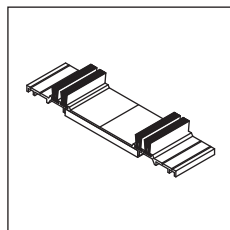

30 94 50 41

Corta-vento inferior/superior

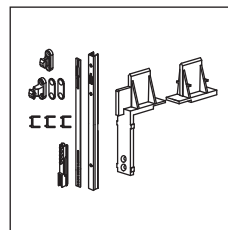

30 94 50 50

Prolongador

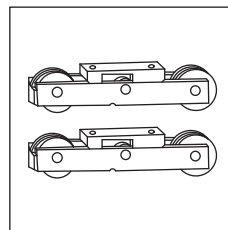

30 94 50 70

Jogo rolamento para folha móvel ou fixa 225 kg

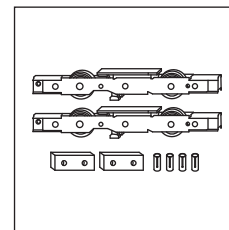

30 94 51 95

Kit elevável 400kg

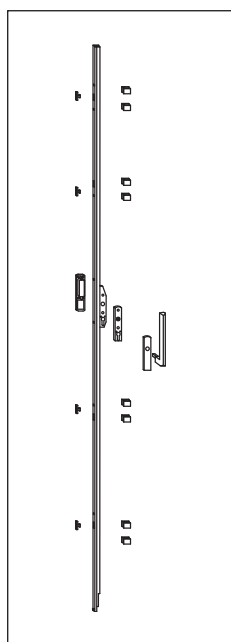

Ver tabela

Kit multiponto

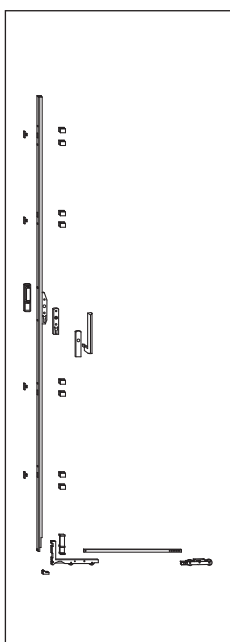

Ver tabela

Kit elevável

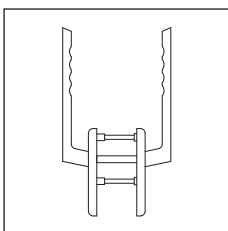

30 94 52 00

Puxador duplo para correr-elevatória

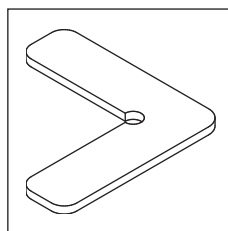



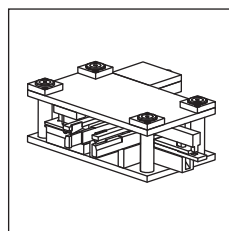

30 96 00 23

Esquadro alinhamento



33 10 01 50

Cunho CK

Referência	Desenho	Descrição
30 95 00 30		Pelúcia 7x7 mm
30 95 00 50		Pelúcia 7x6 mm
30 93 00 65		Junta interior para vidro (5 mm)
30 93 00 66		Junta interior para vidro (4 mm)
30 93 00 67		Junta interior para vidro (2 mm)
30 93 00 68		Junta interior para vidro (6/7 mm)
30 93 00 69		Junta interior para vidro (8/9 mm)
30 93 01 20		Junta central
30 94 50 90		Junta aro móvel para o perfil CK-02

Kits correr-eleváveis (pelo máximo por folha 300kg)

Largura LM	Altura HM	Cor	Referência	Cor	Referência	Cor	Referência
720/1500	1190/1790	Branco	30 94 51 06	Preto	30 94 51 07	Natural	30 94 51 08
720/1500	1791/2090	Branco	30 94 51 11	Preto	30 94 51 12	Natural	30 94 51 13
720/1500	2091/2390	Branco	30 94 51 16	Preto	30 94 51 17	Natural	30 94 51 18
720/1500	2391/2690	Branco	30 94 51 21	Preto	30 94 51 22	Natural	30 94 51 23
1501/2000	1190/1790	Branco	30 94 51 26	Preto	30 94 51 27	Natural	30 94 51 28
1501/2000	1791/2090	Branco	30 94 51 31	Preto	30 94 51 32	Natural	30 94 51 33
1501/2000	2091/2390	Branco	30 94 51 36	Preto	30 94 51 37	Natural	30 94 51 38
1501/2000	2391/2690	Branco	30 94 51 41	Preto	30 94 51 42	Natural	30 94 51 43
2011/2500	1190/1790	Branco	30 94 51 46	Preto	30 94 51 47	Natural	30 94 51 48
2011/2500	1791/2090	Branco	30 94 51 51	Preto	30 94 51 52	Natural	30 94 51 53
2011/2500	2091/2390	Branco	30 94 51 56	Preto	30 94 51 57	Natural	30 94 51 58
2011/2500	2391/2690	Branco	30 94 51 61	Preto	30 94 51 62	Natural	30 94 51 63
2501/3350	1190/1790	Branco	30 94 51 66	Preto	30 94 51 67	Natural	30 94 51 68
2501/3350	1791/2090	Branco	30 94 51 71	Preto	30 94 51 72	Natural	30 94 51 73
2501/3350	2091/2390	Branco	30 94 51 76	Preto	30 94 51 77	Natural	30 94 51 78
2501/3350	2391/2690	Branco	30 94 51 81	Preto	30 94 51 82	Natural	30 94 51 83

Kits multiponto

Altura folha	Cor	Referência	Cor	Referência	Cor	Referência
1190/1790	Branco	30 94 53 06	Preto	30 94 53 07	Natural	30 94 53 08
1800/2090	Branco	30 94 53 11	Preto	30 94 53 12	Natural	30 94 53 13
2100/2390	Branco	30 94 53 16	Preto	30 94 53 17	Natural	30 94 53 18
2400/2690	Branco	30 94 53 21	Preto	30 94 53 22	Natural	30 94 53 23

Porta 2 folhas correr elevável

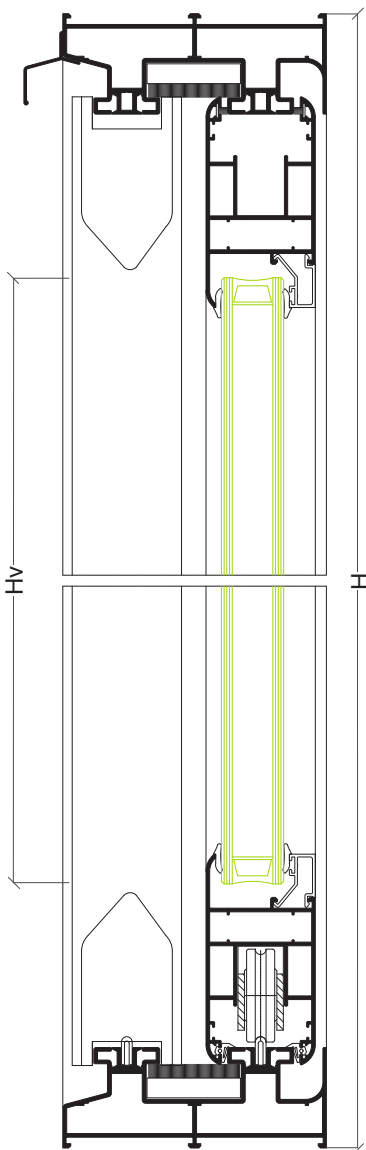
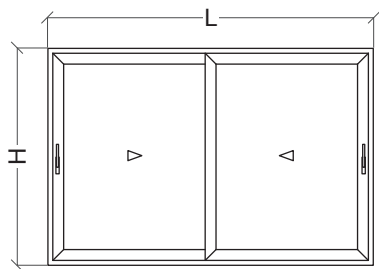

Perfis

Desenho	Ref	Descrição	Corte	Quant	Medida
	CK-01	Aro fixo perimetral		2	L
				2	H
	CK-04	Adaptador guia		4	L/93 mm
				4	H-73 mm
	CTe-03	Guia aço inox		2	L-93 mm
	CK-02	Aro móvel perimetral		4	L/2+6 mm
				4	H-77 mm
	CK-06	Tampa cruzamento aro móvel		2	H-77 mm
	----	Bite		4	L/2-149 mm
				4	H-272 mm
	CT-07	Pingadeira superior		1	L

Acessórios e Juntas

Referência	Descrição	Quantidade
----	Kit elevável	2
30 25 44 01	Esquadro aro móvel	8
30 94 50 10	Esquadro aro fixo	8
30 94 50 30	Tampa guia lateral	2
30 96 00 23	Esquadro alinhamento	16
30 94 50 41	Corta vento	2
30 92 01 02	Goteira com válvula (cor preto)	diversas
30 94 50 20	Limitador de abertura	1
30 91 20 60	Canal	4
30 94 51 95	Kit suplementar (folha com 301kg-400kg)	2 (opcional)
30 94 50 50	Prolongador (Hf -> 2790 mm-3225 mm)	2 (opcional)
30 94 50 90	Junta vedação	2L/4H
30 93 01 20	Junta para cruzamento	2H
30 95 00 30	Pelúcia 7x7 mm	2L
30 95 00 50	Pelúcia 7x6 mm	2H
----	Junta para vidro (exterior)	2L/4H
----	Junta para vidro (interior)	2L/4H

4 0 1

Vidro



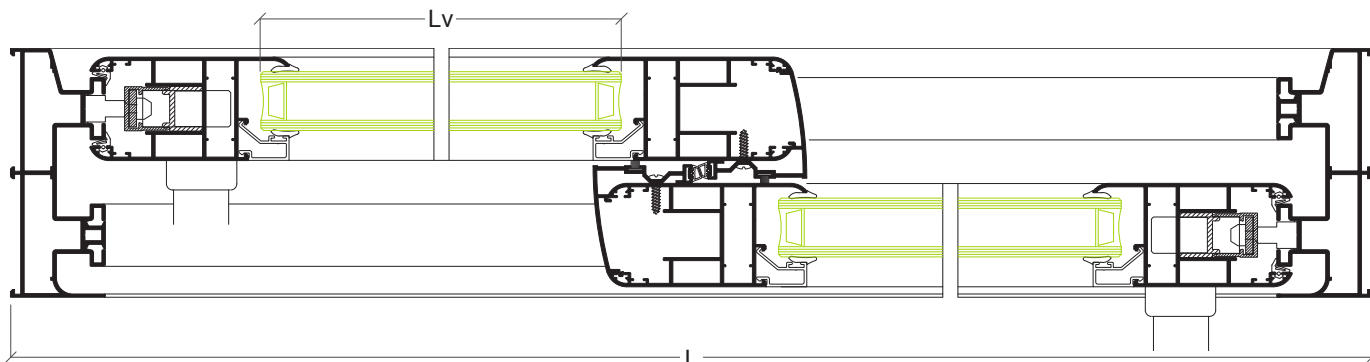



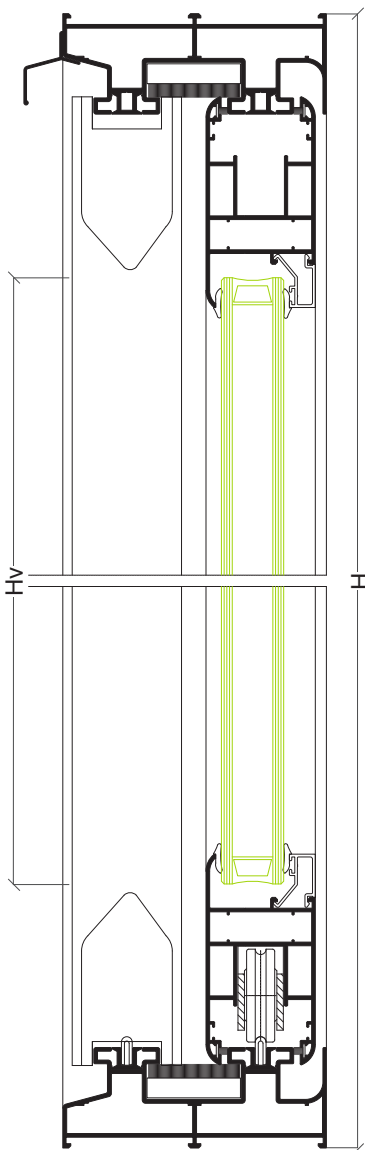
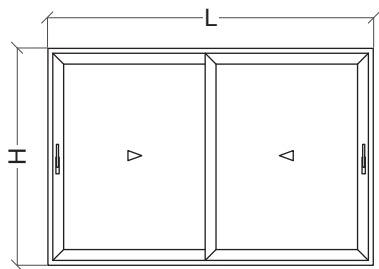



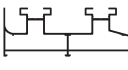







Hv = H-246 mm	Lv = L/2-163 mm
---------------	-----------------



Porta 2 folhas correr multiponto



Perfis

Desenho	Ref	Descrição	Corte	Quant	Medida
	CK-01	Aro fixo perimetral		2	L
				2	H
	CK-04	Adaptador guia		4	L/93 mm
				4	H-73 mm
	CTe-03	Guia aço inox		2	L-93 mm
	CK-02	Aro móvel perimetral		4	L/2+6 mm
				4	H-77 mm
	CK-06	Tampa cruzamento aro móvel		2	H-77 mm
	----	Bite		4	L/2-149 mm
				4	H-272 mm
	CT-07	Pingadeira superior		1	L

Acessórios e Juntas

Referência	Descrição	Quantidade
----	Kit multiponto	2
30 25 44 01	Esquadro aro móvel	8
30 94 50 10	Esquadro aro fixo	8
30 94 50 30	Tampa guia lateral	2
30 96 00 23	Esquadro alinhamento	16
30 94 50 41	Corta vento superior	2
30 92 01 02	Goteira com válvula (cor preto)	diversas
30 94 50 20	Limitador de abertura	1
30 91 20 60	Canal	4
30 94 50 70	Jogo rolamento	2
30 94 50 90	Junta vedação	4H
30 93 01 20	Junta para cruzamento	2H
30 95 00 30	Pelúcia 7x7 mm	4L
30 95 00 50	Pelúcia 7x6 mm	2H
----	Junta para vidro (exterior)	4H
----	Junta para vidro (interior)	4H

Vidro



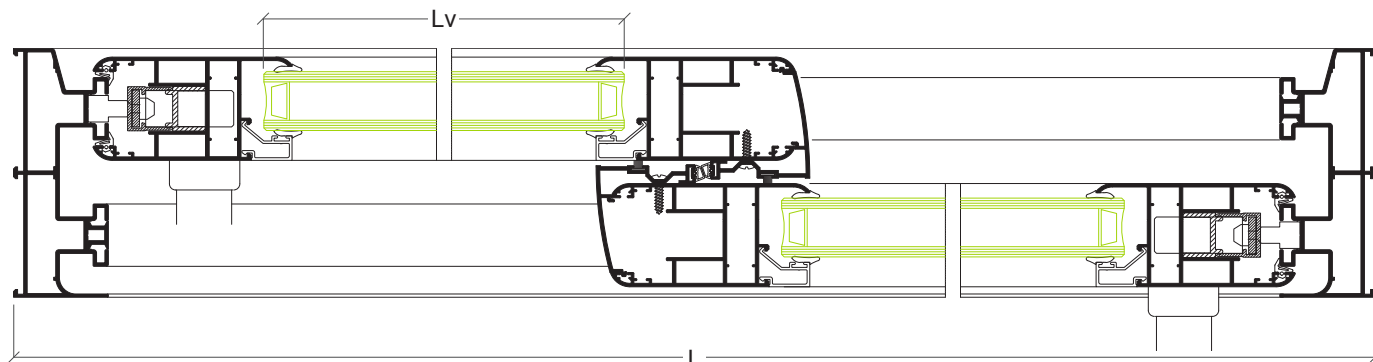



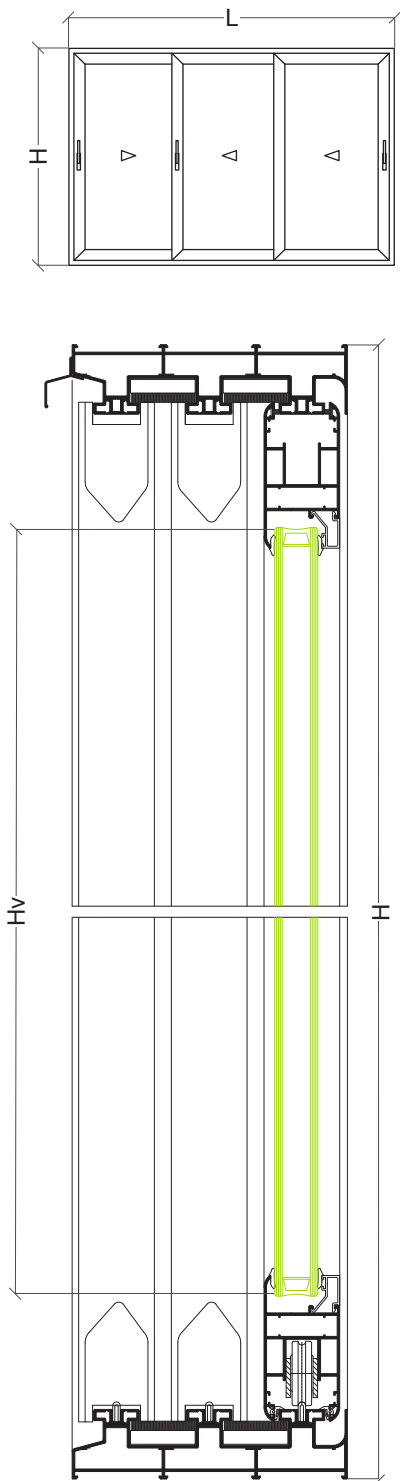











Hv = H-246 mm	Lv = L/2-163 mm
---------------	-----------------



Porta 3 folhas correr elevável tri-rail



Perfis

Desenho	Ref	Descrição	Corte	Quant	Medida
	CK-05	Aro fixo perimetral		2	L
				2	H
	CK-04	Adaptador guia		6	L/93 mm
				6	H-73 mm
	CTe-03	Guia aço inox		3	L-93 mm
	CK-02	Aro móvel perimetral		6	L/3+35 mm
				6	H-77 mm
	CK-06	Tampa cruzamento aro móvel		4	H-77 mm
	----	Bite		6	L/3-120 mm
				6	H-272 mm
	CT-07	Pingadeira superior		1	L

Acessórios e Juntas

Referência	Descrição	Quantidade
----	Kit elevável	3
30 25 44 01	Esquadro aro móvel	12
30 94 50 10	Esquadro aro fixo	12
30 94 50 30	Tampa guia lateral	4
30 96 00 23	Esquadro alinhamento	24
30 94 50 41	Corta vento	4
30 92 01 02	Goteira com válvula (cor preto)	diversas
30 94 50 20	Limitador de abertura	2
30 91 20 60	Canal	8
30 94 51 95	Kit suplementar (folha com 301kg-400kg)	3 (opcional)
30 94 50 50	Prolongador (Hf -> 2790 mm-3225 mm)	3 (opcional)
30 94 50 90	Junta vedação	2L/4H
30 93 01 20	Junta para cruzamento	4H
30 95 00 30	Pelúcia 7x7 mm	2L
30 95 00 50	Pelúcia 7x6 mm	4H
----	Junta para vidro (exterior)	2L/6H
----	Junta para vidro (interior)	2L/6H

403

Vidro

Hv = H-246 mm	Lv = L/3-135 mm
---------------	-----------------

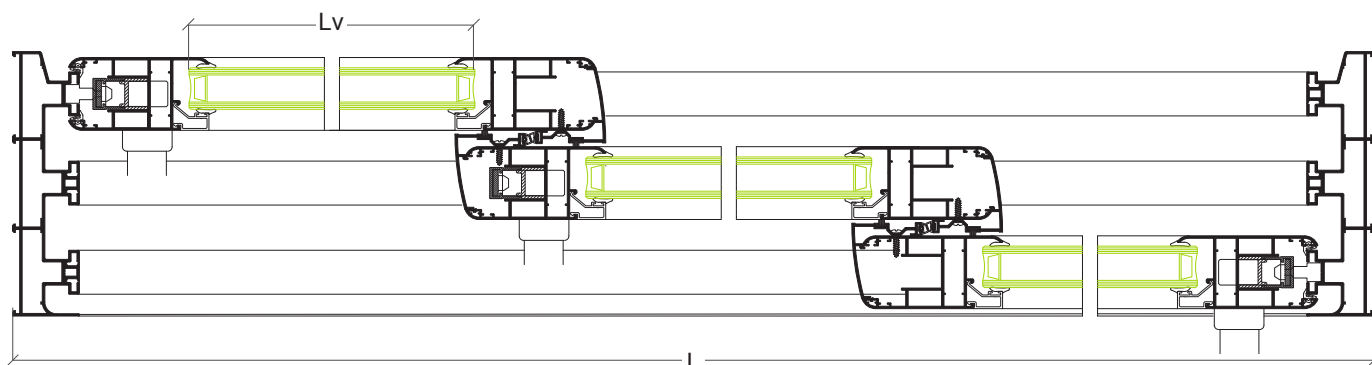

Porta 4 folhas correr elevável

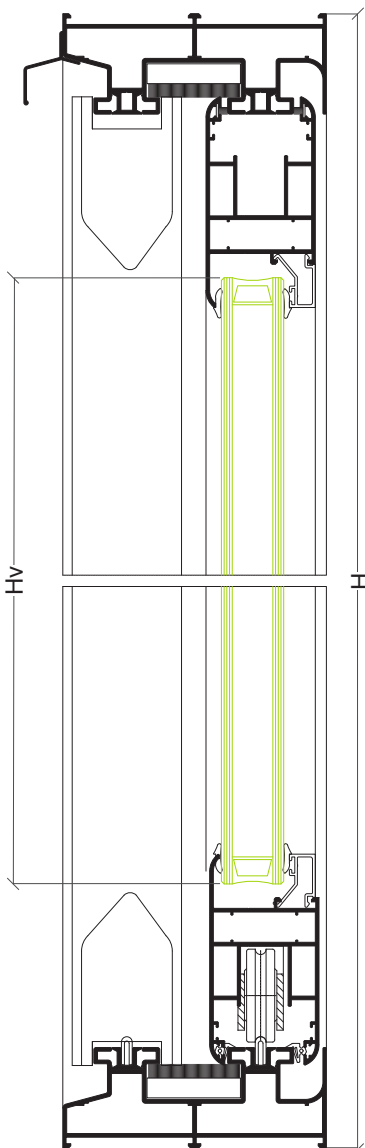
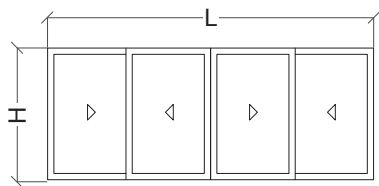

Perfis

Desenho	Ref	Descrição	Corte	Quant	Medida
	CK-01	Aro fixo perimetral		2	L
				2	H
	CK-04	Adaptador guia		4	L/93 mm
				4	H-73 mm
	CTe-03	Guia aço inox		2	L-93 mm
	CK-02	Aro móvel perimetral		8	L/4+24 mm
				8	H-77 mm
	CTe-09	União 3/4 folhas		1	H-77 mm
	CK-06	Tampa cruzamento aro móvel		4	H-77 mm
	----	Bite		8	L/4-131 mm
				8	H-272 mm
	CT-07	Pingadeira superior		1	L

Acessórios e Juntas

Referência	Descrição	Quantidade
----	Kit elevável	3
30 25 44 01	Esquadro aro móvel	16
30 94 50 10	Esquadro aro fixo	8
30 94 50 30	Tampa guia lateral	4
30 96 00 23	Esquadro alinhamento	32
30 94 50 41	Corta vento	6
30 92 01 02	Goteira com válvula (cor preto)	diversas
30 94 50 20	Limitador de abertura	2
30 91 20 60	Canal	8
30 94 50 70	Rolamento	4
30 94 50 90	Junta vedação	2L/6H
30 93 01 20	Junta para cruzamento	4H
30 95 00 30	Pelúcia 7x7 mm	2L
30 95 00 50	Pelúcia 7x6 mm	4H
----	Junta para vidro (exterior)	8H
----	Junta para vidro (interior)	8H

Vidro

Hv = H-246 mm	Lv = L/4-145 mm
---------------	-----------------

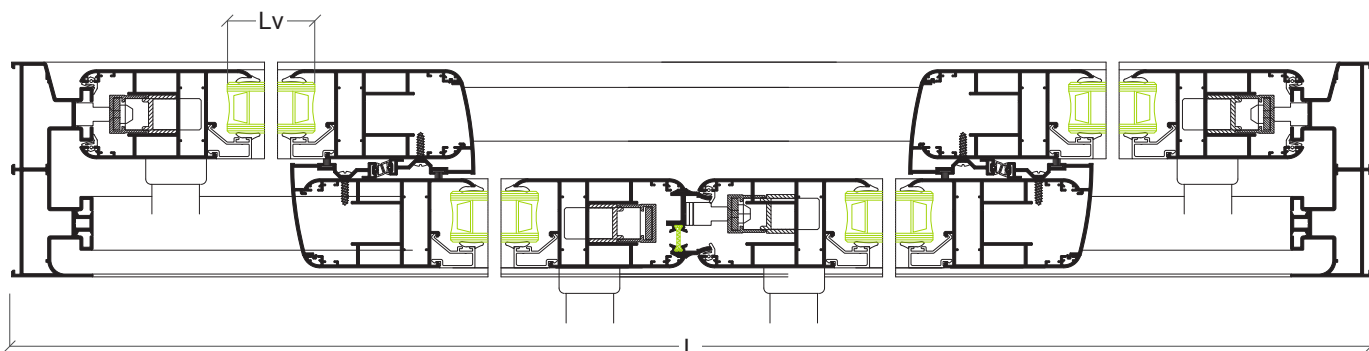

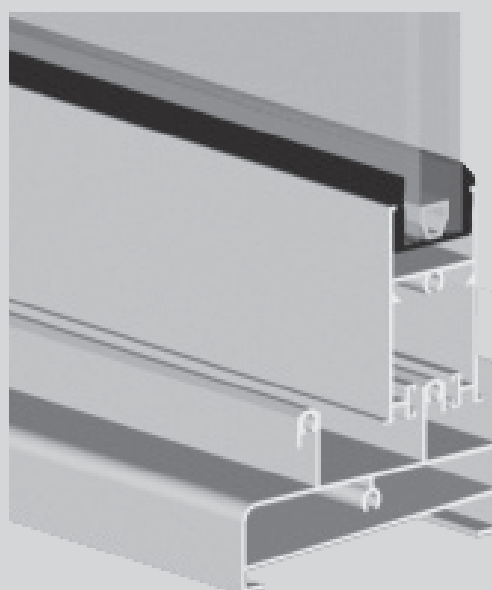
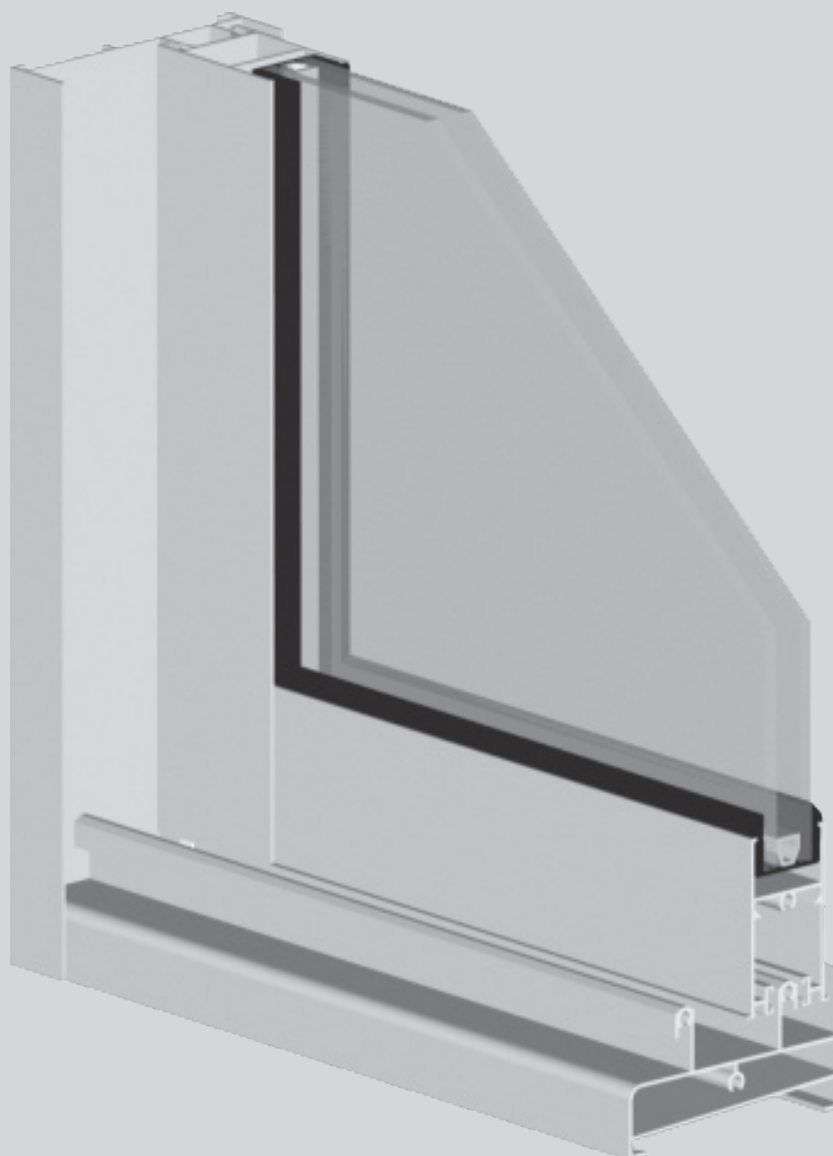

Sistema
CS

Sistema CS

Sistema de correr - 95 mm

Características do sistema

Sistemas de alumínio tradicional e sistema euro para execução de vãos de correr.

Perfis de alumínio

Os perfis de alumínio são extrudidos na liga de alumínio 6060 para arquitetura de acordo com norma NP EN 12020-02.

Espessura média dos perfis de alumínio de 1.4 mm.

Aros fixos

Secção do aro fixo de 1 guia de 47 mm para montagem a corte recto;

Secção do aro fixo de 2 guias de 95 mm para montagem a corte recto;

Secção do aro fixo de 3 guias de 135.5 mm para montagem a corte recto.

Aros móveis

Secção dos aros móveis de 34.6 mm para montagem a corte recto;

Enchimento de 4 mm a 23 mm;

Estanquidade assegurada através de pelúcia tipo Fin-Seal.

Dimensionamento e manobralidade

Peso máximo de 90 kg por folha (com 2 rolamentos duplos);

Possibilidades de abertura: 1, 2, 3, 4 e 6 folhas, com folhas móveis e/ou fixas;

Rolamento duplo com regulação.

Performances

Sistema certificado por laboratório notificado do ensaio tipo inicial (ITT) de acordo com a norma de produto EN 14351-1 para efeitos de Marcação CE.

Categorias alcançadas na avaliação do sistema CS tipologia janela:

1. Permeabilidade ao ar: Classe 3 (norma de ensaio EN 1026)
2. Estanquidade à água: Classe 6A (norma de ensaio EN 1027)
3. Resistência ao vento: Classe C4 (norma de ensaio EN 12211)

Categorias alcançadas na avaliação do sistema CS tipologia porta:

1. Permeabilidade ao ar: Classe 3 (norma de ensaio EN 1026)
2. Estanquidade à água: Classe 6A (norma de ensaio EN 1027)
3. Resistência ao vento: Classe C2 (norma de ensaio EN 12211)

Coefficiente de transmissão térmica de vão de 2 folhas com 1.80 m x 2.20 m com vidro $U_g = 1.4 \text{ W/m}^2\text{K}$:

• $U_w = 2.60 \text{ W/m}^2\text{K}$

Coefficiente de atenuação acústica de vão de 2 folhas com vidro 4/10/4:

• $R_w (C; C_{tr}) = 29 \text{ dB} (-1; -2)$

Zonas de aplicação segundo RCCTE (em função do valor U_g): I1, I2, I3, V1, V2, V3;



CS-01
Padieira

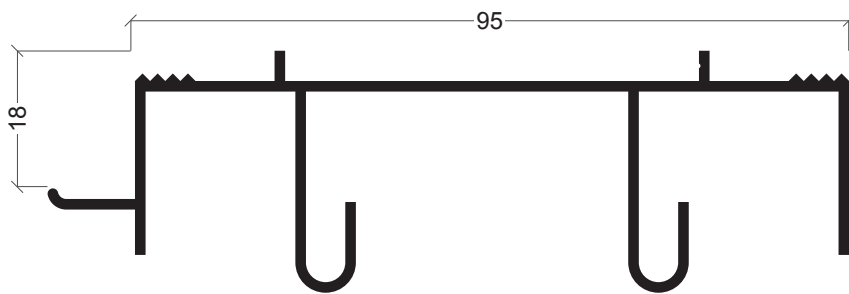

CS-21
Padieira

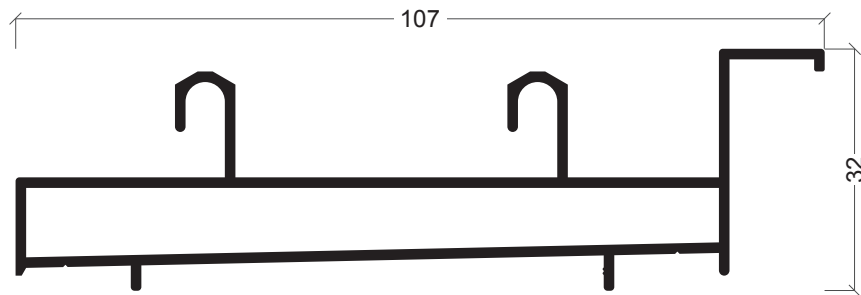

CS-29
Soleira

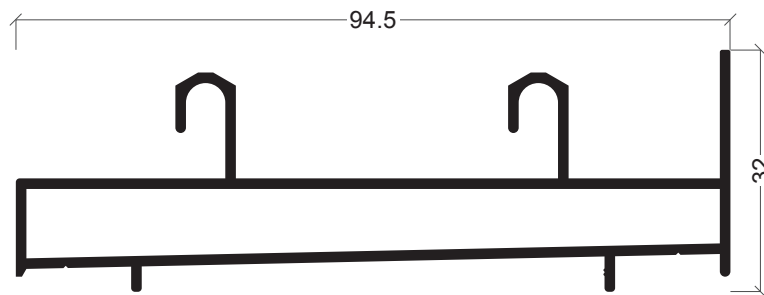

CS-39
Soleira

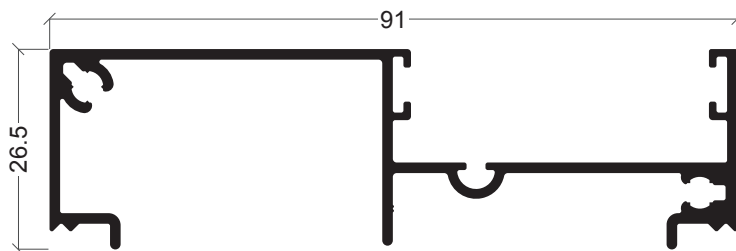

CS-04
Ombreira

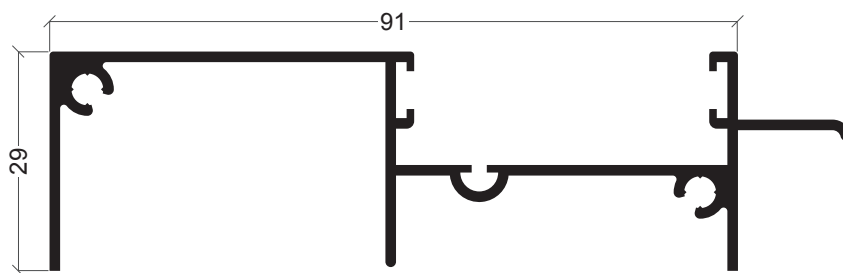

CS-54
Ombreira

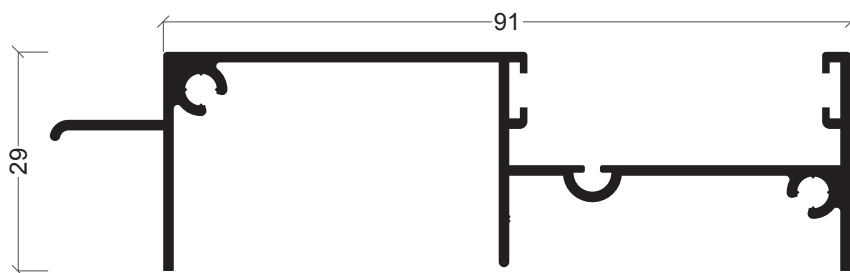

CS-55
Ombreira

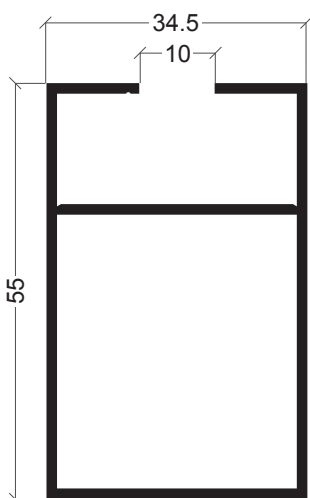

CS-75
Aro móvel lateral

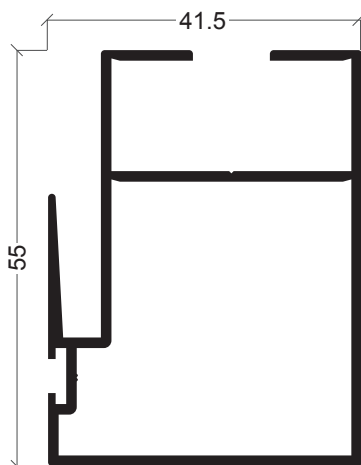

CS-76
Aro móvel central

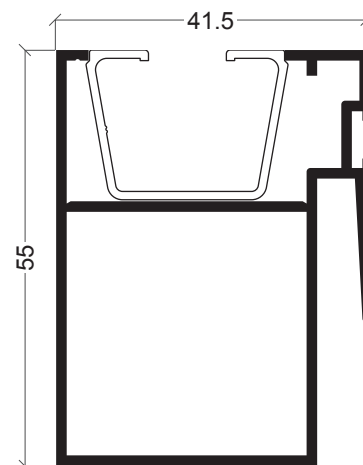

CS-87
Aro móvel central 3F

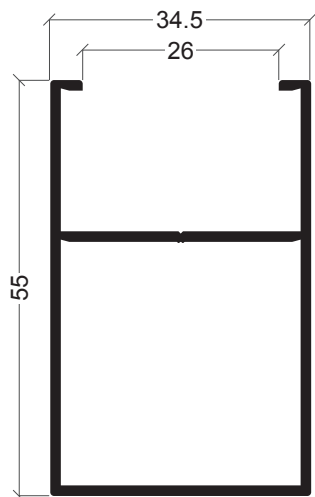

CS-85
Aro móvel lateral

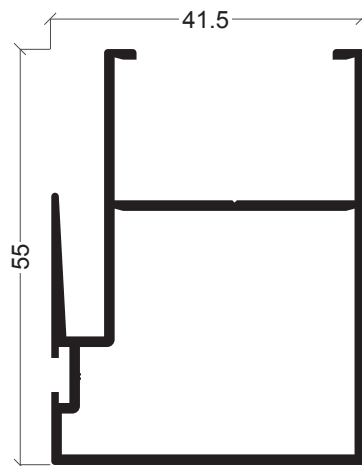

CS-86
Aro móvel central

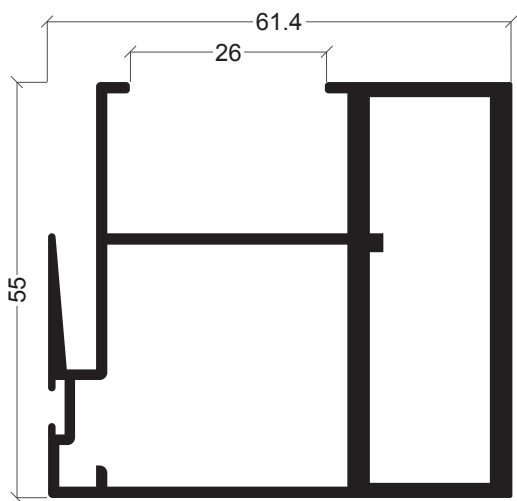

CS-90
Aro móvel central

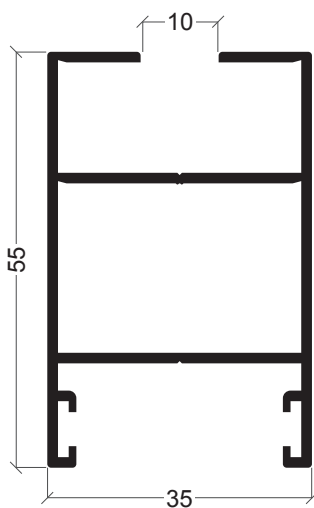

CS-94
Aro móvel lateral

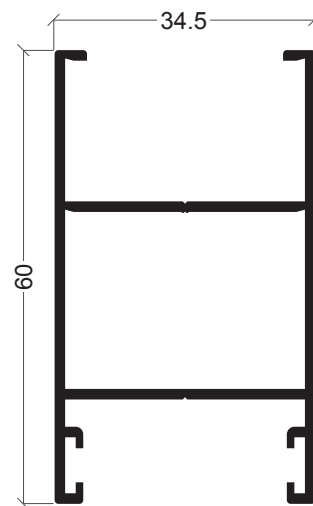

CS-96
Aro móvel lateral

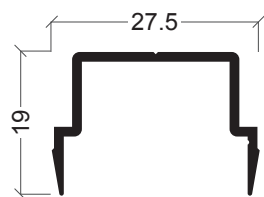

CS-48
União 3/4F

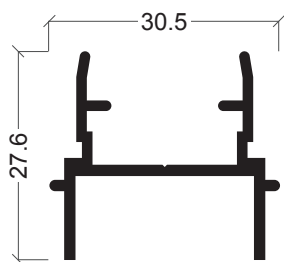

CS-38
União 3/4F

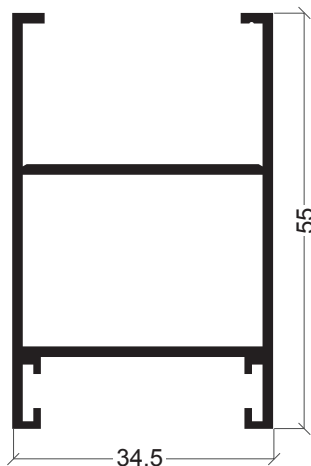

CS-93
Aro móvel lateral

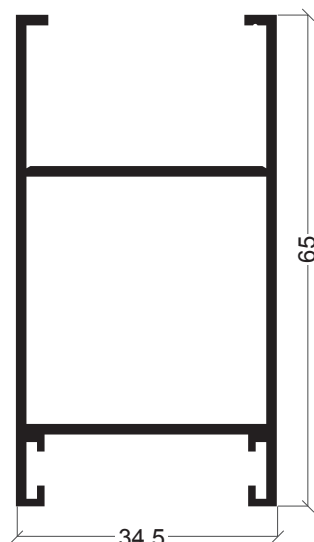

CS-95
Aro móvel lateral

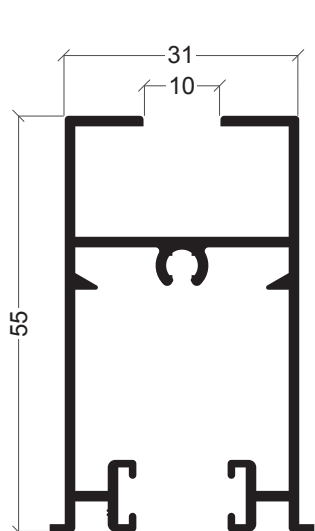

CS-70

Aro móvel carrinho

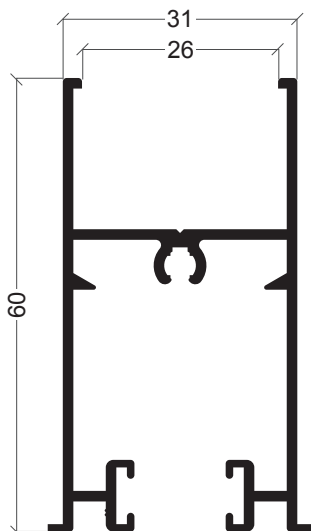

CS-80

Aro móvel carrinho

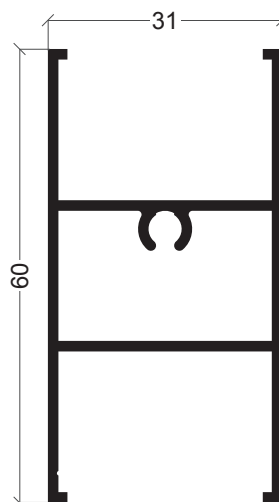

CS-83

Travessa

410

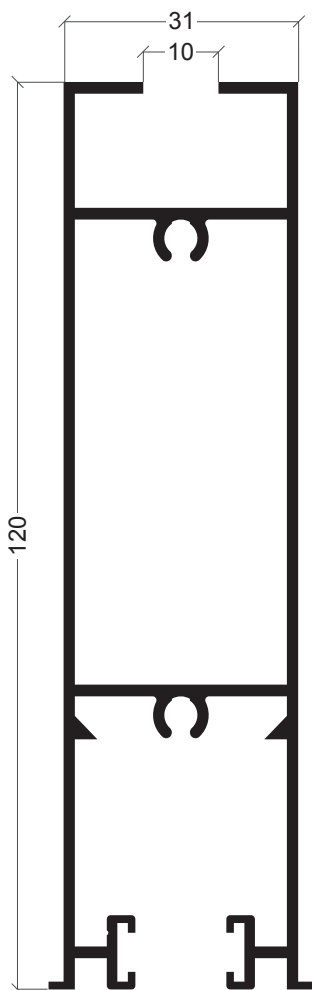

CS-72

Aro móvel carrinho

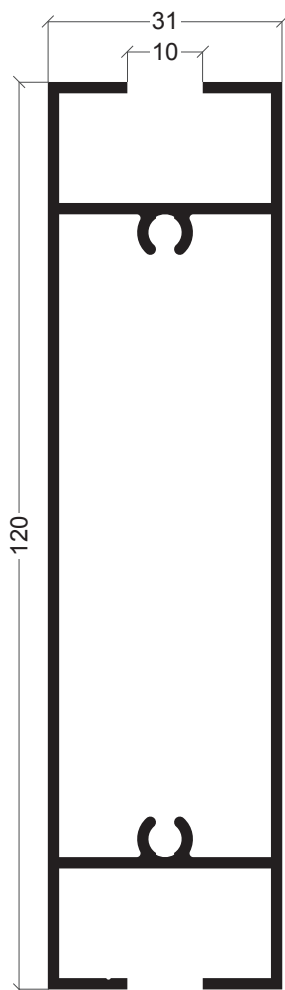

CS-71

Travessa



CS-15

União de aros

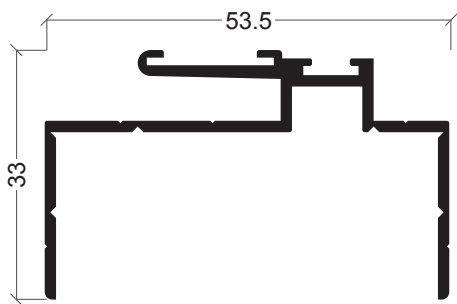

CS-08
Central mono-rail

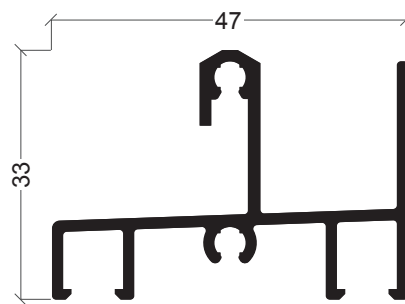

CS-05
Aro fixo sup/inferior mono-rail

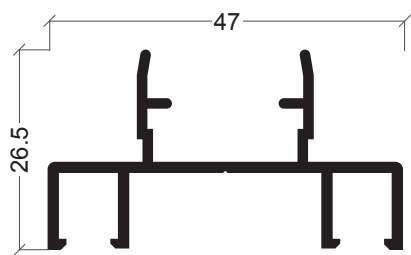

CS-07
Ombreira mono-rail

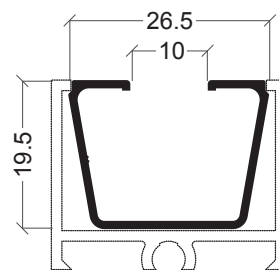

CS-74
Redutor

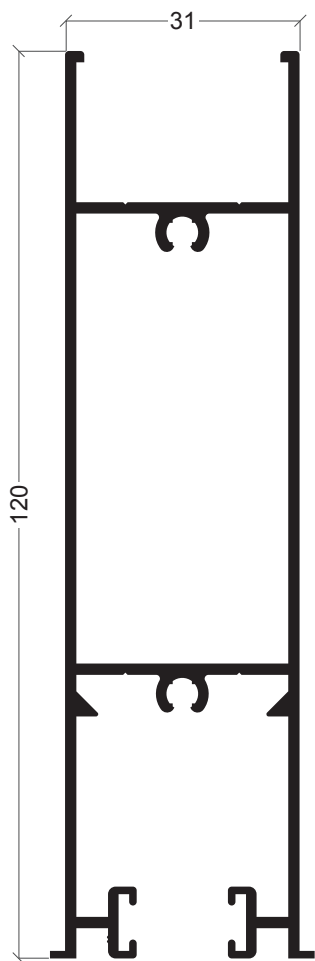

CS-82
Almofada carrinho

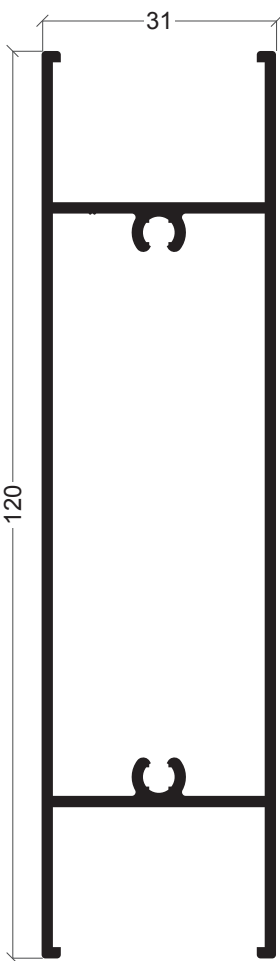

CS-81
Travessa

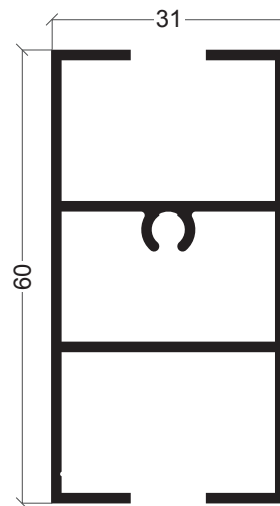

CS-73
Travessa

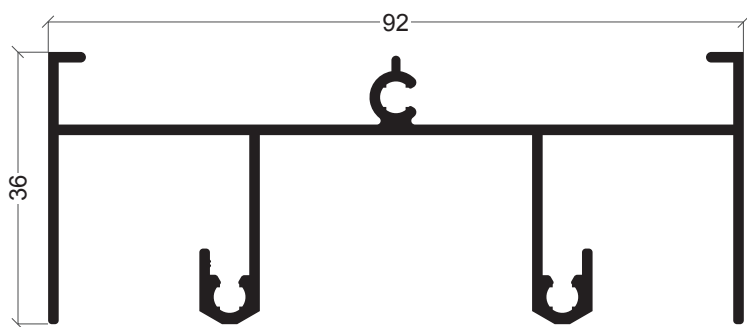

CS-12
Padieira

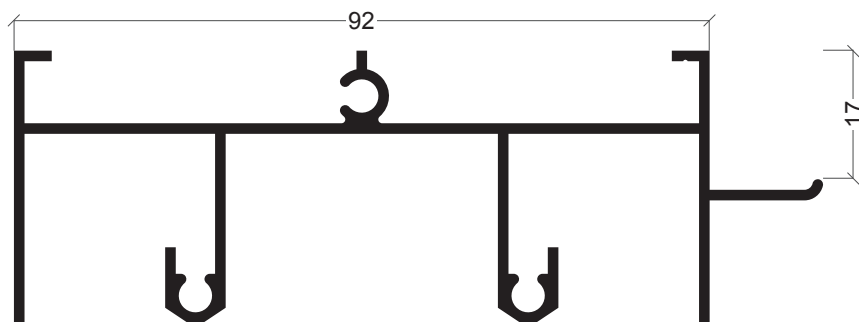

CS-51
Padieira

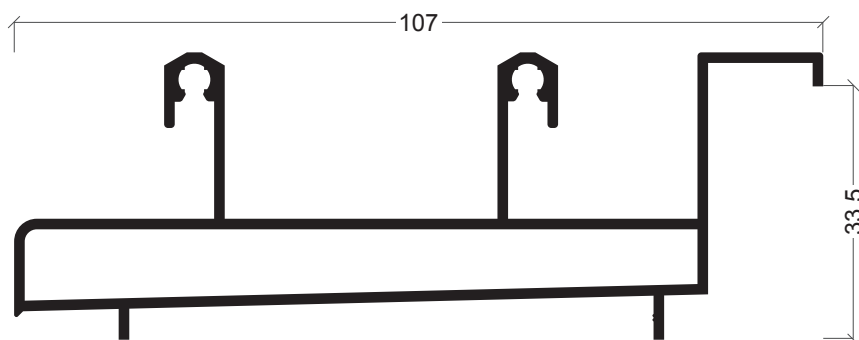

CS-69
Soleira

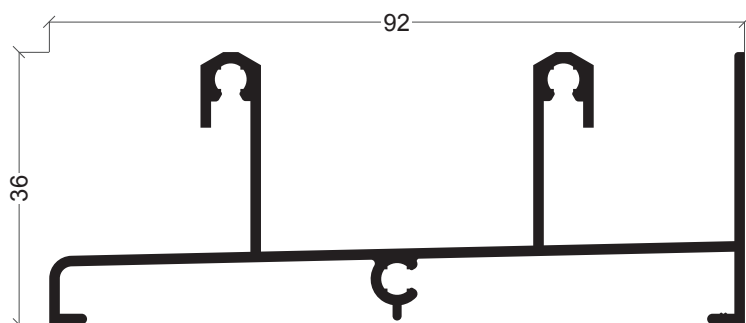

CS-19
Soleira

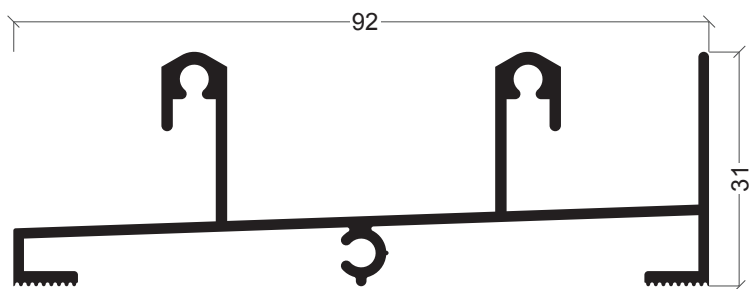

CS-49
Soleira

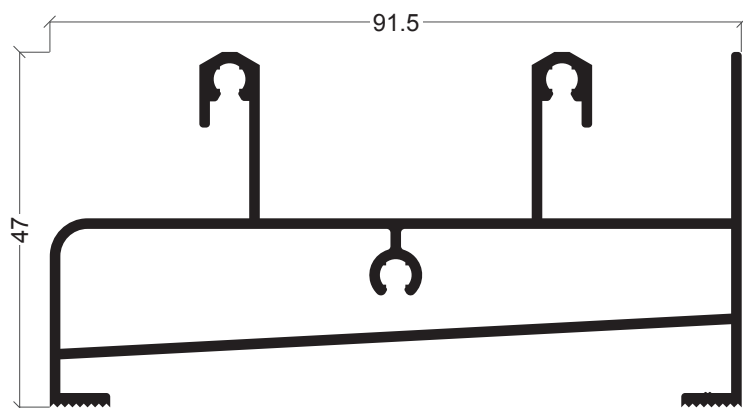

CS-59
Soleira

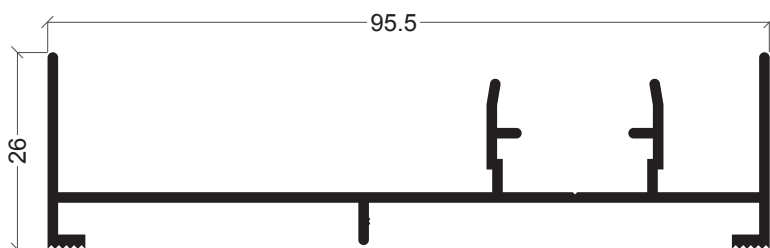

CS-24
Ombreira

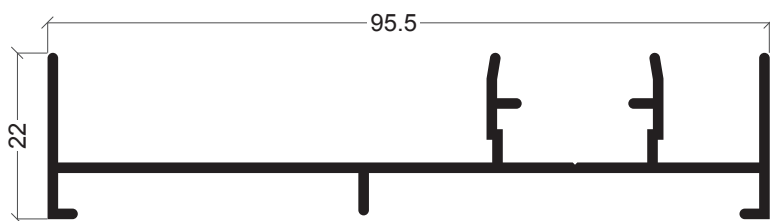

CS-25
Ombreira

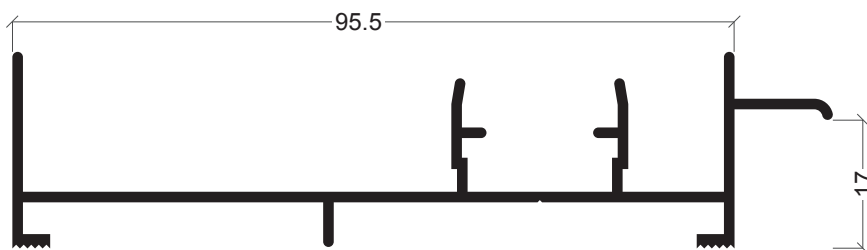

CS-64
Ombreira

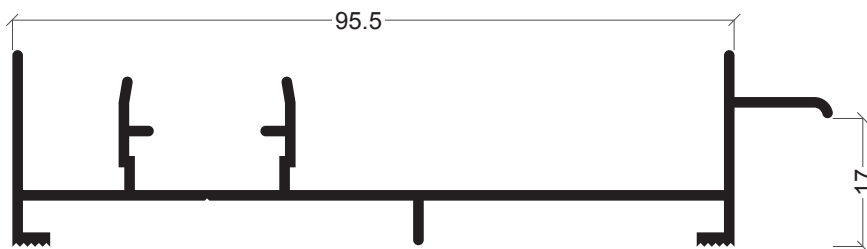

CS-65
Ombreira

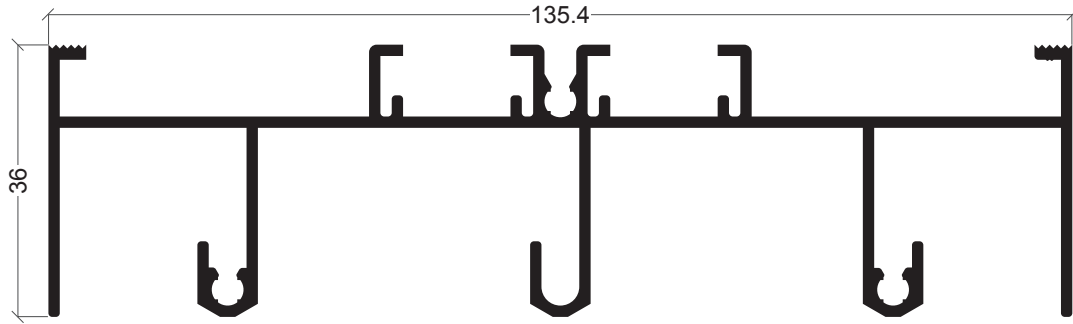

CS-22
Padieira

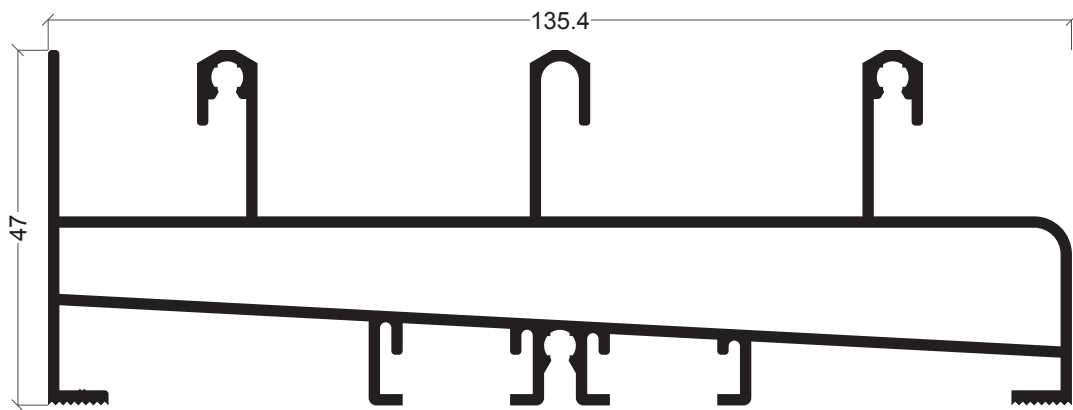

CS-79
Soleira tri-rail

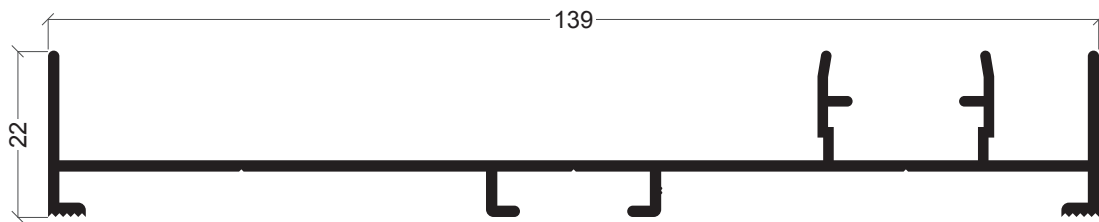

CS-14
Ombreira tri-rail

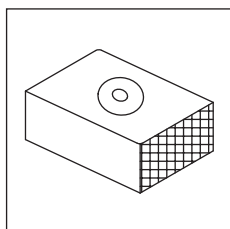

30 91 41 10
taco anti-levantamento

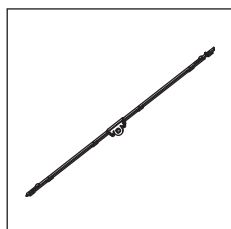

30 91 41 31
Barra 2 pontos com apoios (600 mm)

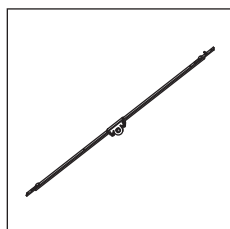

30 91 41 32
Barra 3 pontos com apoios (1670 mm)

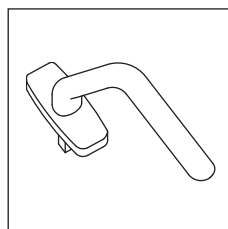

30 91 41 52/53
Cremone desviado direita branco/preto

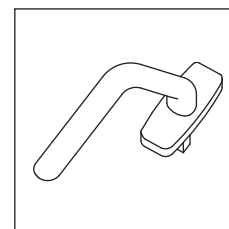

30 91 41 54/55
Cremone desviado esquerda branco/preto

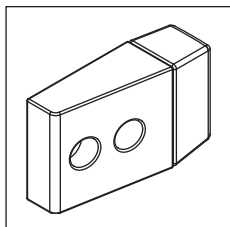

30 91 41 71
Topo limitador de abertura

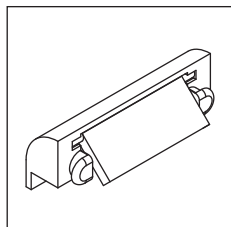

30 92 01 02/03
Goteira com válvula branco/preto

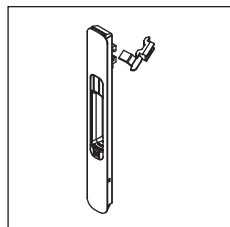

30 97 10 01/02
Fecho lateral automático branco/preto

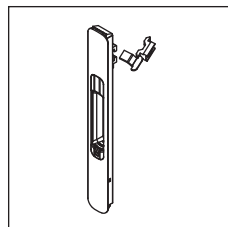

30 97 10 03/04
Fecho lateral manual branco/preto

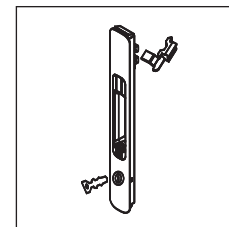

30 97 10 05/06
Fecho lateral com chave branco/preto

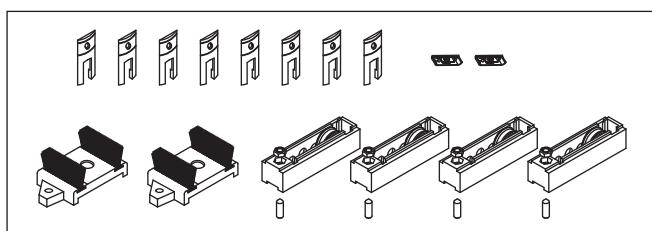

30 97 10 09
Kit janela 2F CS normal

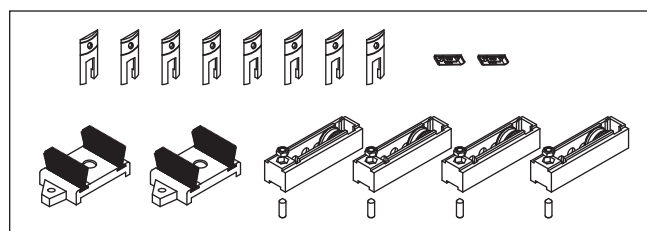

30 97 10 10
Kit janela 2F CS euro

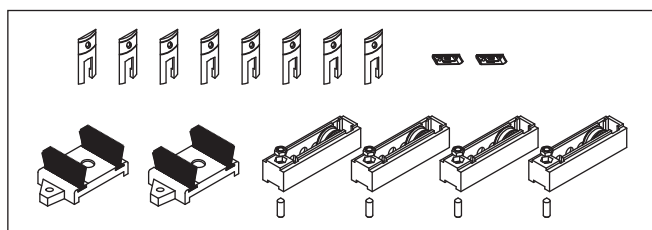

30 97 10 11
Kit porta 2F CS normal

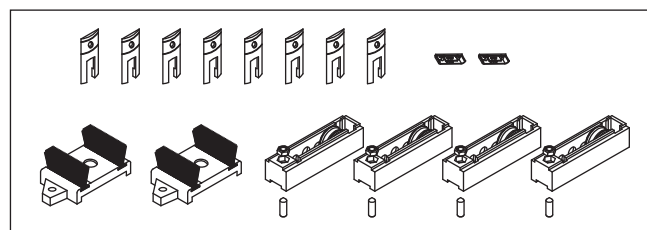

30 97 10 12
Kit porta 2F CS euro

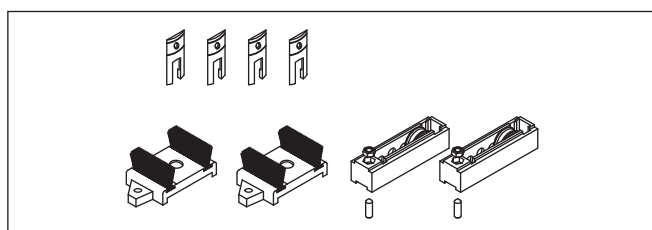

30 97 10 15
Kit janela suplementar 3F CS normal

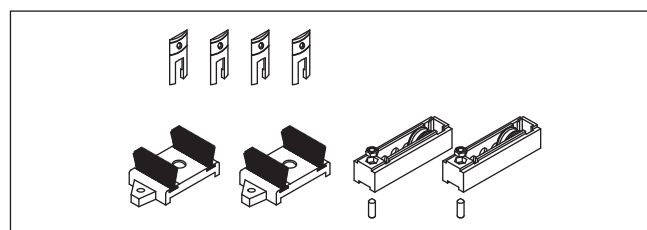

30 97 10 16
Kit janela suplementar 3F CS euro

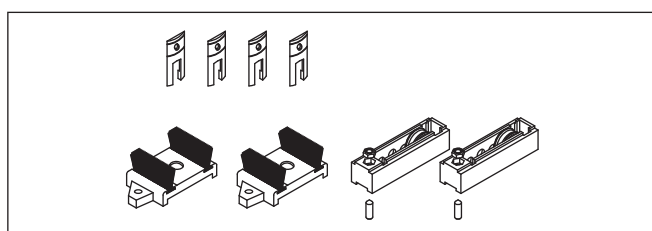

30 97 10 17
Kit porta suplementar 3F F CS normal

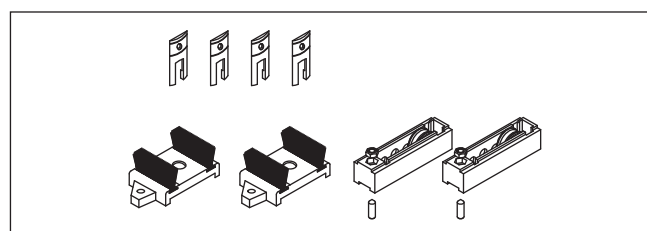

30 97 10 18
Kit porta suplementar 3F F CS euro

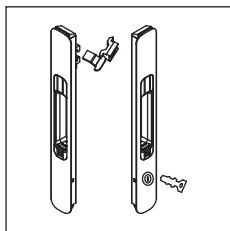

30 97 10 07/08

Fecho lateral duplo com
chave branco/preto

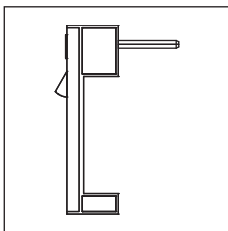

30 97 10 13/14

Fecho central preto/
branco

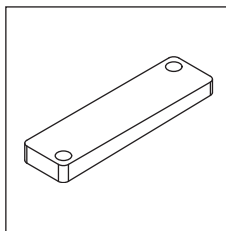

30 97 10 19

Topo de vedação para
soleiras CS-29/39

Referência	Desenho	Descrição
30 95 00 40		Pelúcia 7x5.5 mm
30 97 10 25		Junta U CS vidro 22 mm
30 97 10 26		Junta U CS vidro 20/21 mm
30 95 00 80		Pelúcia 7x5 mm

Janela 2 folhas correr

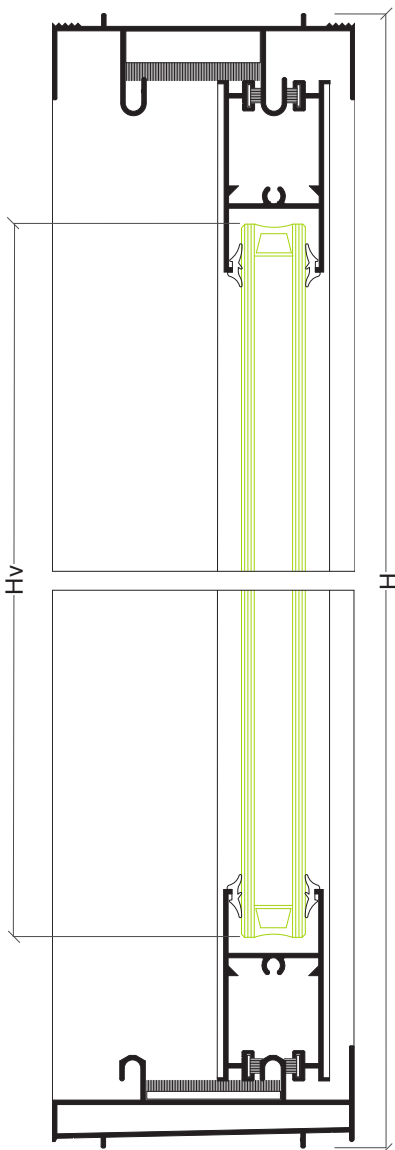
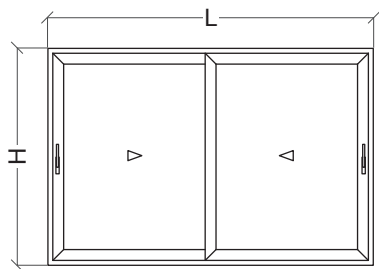

Perfis

Desenho	Ref	Descrição	Corte	Quant	Medida
	CS-01	Padieira		1	L
	CS-39	Soleira		1	L
	CS-24	Ombreira		2	H-20 mm
	CS-80	Móvel carrinho		4	L/2+9 mm
	CS-85	Móvel lateral		2	H-44 mm
	CS-86	Móvel central		2	H-44 mm

Acessórios e Juntas

Referência	Descrição	Quantidade
30 97 10 14	Fecho central branco	1
30 97 10 09	Kit janela 2F CS normal	1
30 97 10 19	Topo para soleira	2
30 95 00 80	Pelúcia 7x5 mm	4L
30 95 00 40	Pelúcia 7x5.5 mm	6H
---	Junta de vidro	4L/8H

4 17

Vidro

Hv = H-132 mm	Lv = L/2-68 mm
---------------	----------------

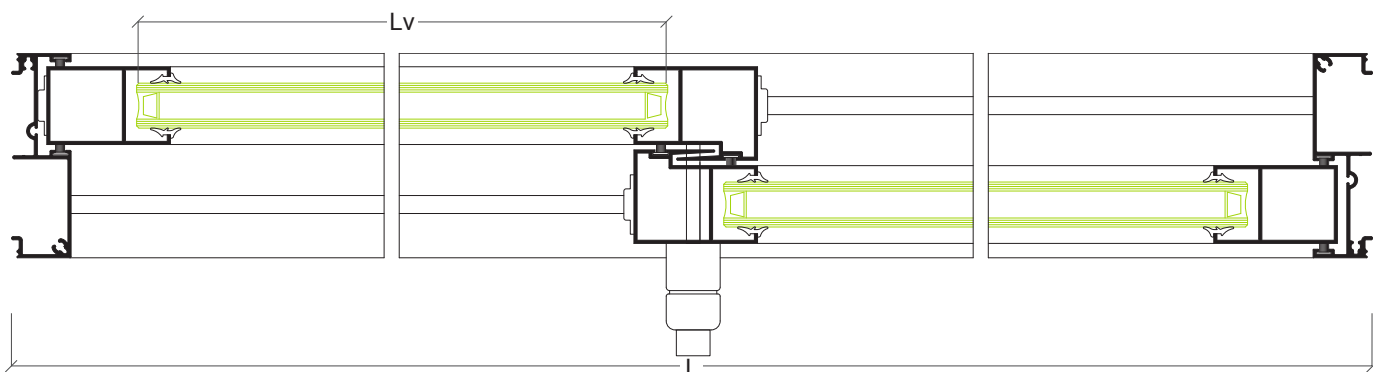

Janela 2 folhas correr

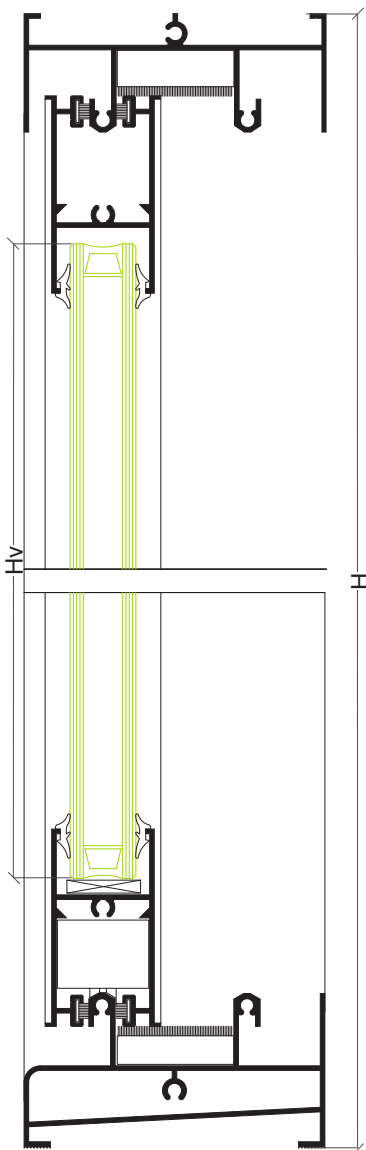
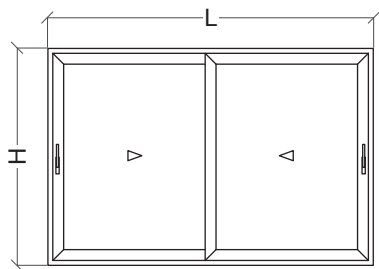

Perfis

Desenho	Ref	Descrição	Corte	Quant	Medida
	CS-12	Padieira		1	L-15 mm
	CS-59	Soleira		1	L-15 mm
	CS-24	Ombreira		2	H
	CS-80	Móvel carrinho		4	L/2+0.5 mm
	CS-96	Móvel lateral		2	H-64 mm
	CS-86	Móvel central		2	H-64 mm

Acessórios e Juntas

Referência	Descrição	Quantidade
30 97 10 01	Fecho lateral automático branco	2
30 97 10 10	Kit janela 2 folhas CS Euro	1
30 91 41 10	Taco anti-levantamento	2
30 95 00 80	Pelúcia 7x5 mm	4L/4H
30 95 00 40	Pelúcia 7x5.5 mm	2H
---	Junta de vidro	4L/8H

Vidro

Hv = H-152 mm	Lv = L/2-68 mm
---------------	----------------

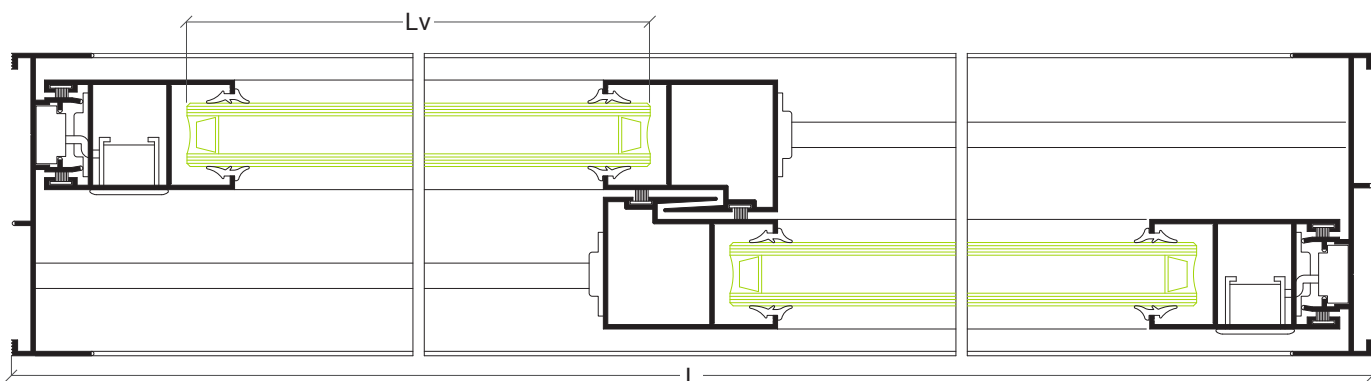

Janela 4 folhas correr

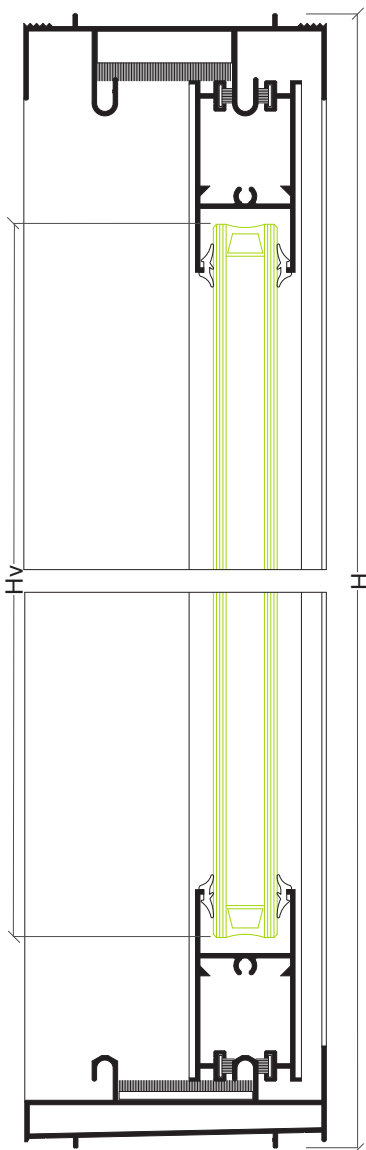
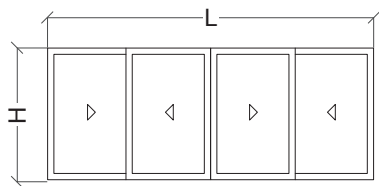

Perfis

Desenho	Ref	Descrição	Corte	Quant	Medida
	CS-01	Padieira		1	L
	CS-39	Soleira		1	L
	CS-04	Ombreira		2	H-20 mm
	CS-80	Móvel carrinho		8	L/4+9.5 mm
	CS-85	Móvel lateral		2	H-44 mm
	CS-86	Móvel central		4	H-44 mm
	CS-96	Móvel central		2	H-44 mm
	CS-38	União 3/4F		1	H-44 mm

Acessórios e Juntas

Referência	Descrição	Quantidade
30 97 10 14	Fecho central branco	2
30 97 10 09	Kit janela 2F CS normal	2
30 97 10 19	Topo para soleira	2
30 95 00 80	Pelúcia 7x5 mm	4L
30 95 00 40	Pelúcia 7x5.5 mm	10H
---	Junta de vidro	4L/16H

4 19

Vidro

Hv = H-132 mm	Lv1 = L/4-68 mm
Hv = H-132 mm	Lv2 = L/4-59 mm

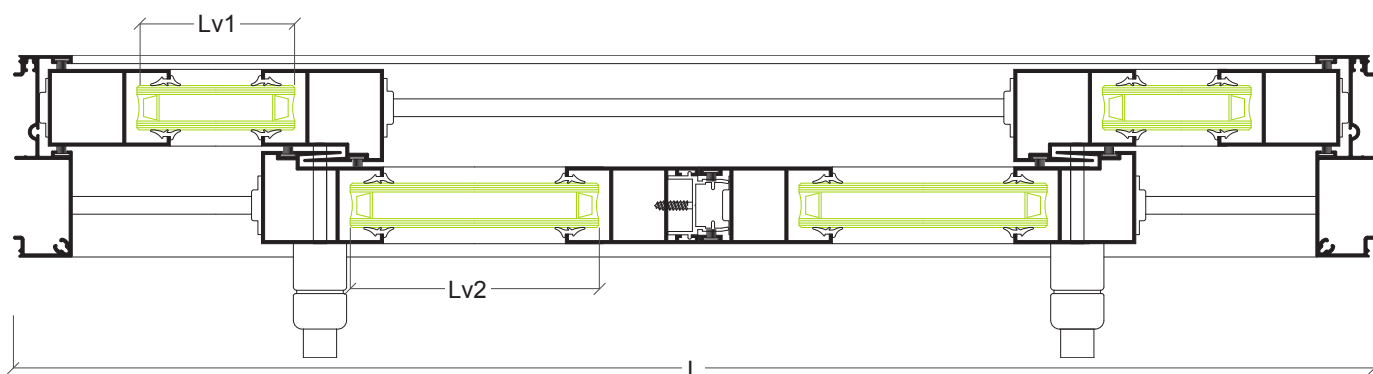

Janela 4 folhas correr

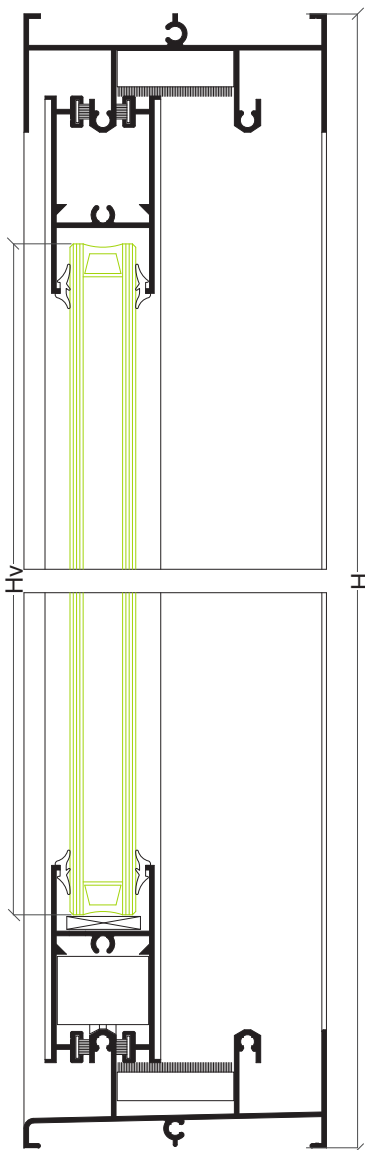
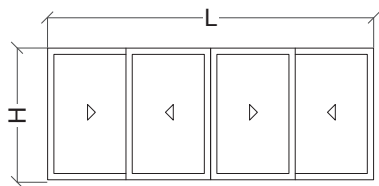

Perfis

Desenho	Ref	Descrição	Corte	Quant	Medida
	CS-12	Padieira		1	L-15 mm
	CS-19	Soleira		1	L-15 mm
	CS-04	Ombreira		2	H
	CS-80	Móvel carrinho		4	L/4+5 mm
	CS-96	Móvel lateral		2	H-53 mm
	CS-86	Móvel central		2	H-53 mm
	CS-38	União 3/4F		1	H-53 mm

Acessórios e Juntas

Referência	Descrição	Quantidade
30 97 10 01	Fecho lateral automático branco	3
30 97 10 10	Kit janela 2 folhas CS Euro	2
30 91 41 10	Taco anti-levantamento	3
30 95 00 80	Pelúcia 7x5 mm	4L/6H
30 95 00 40	Pelúcia 7x5.5 mm	4H
---	Junta de vidro	4L/16H

Vidro



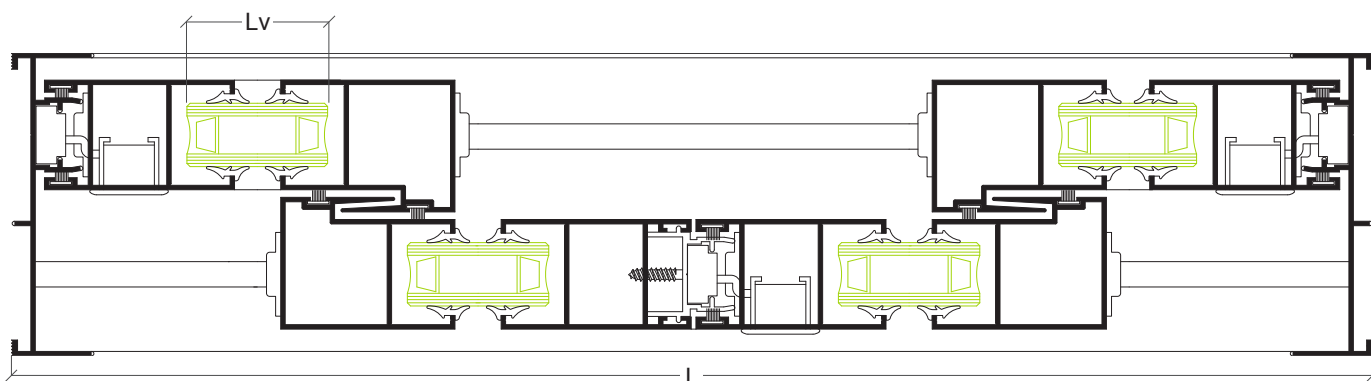



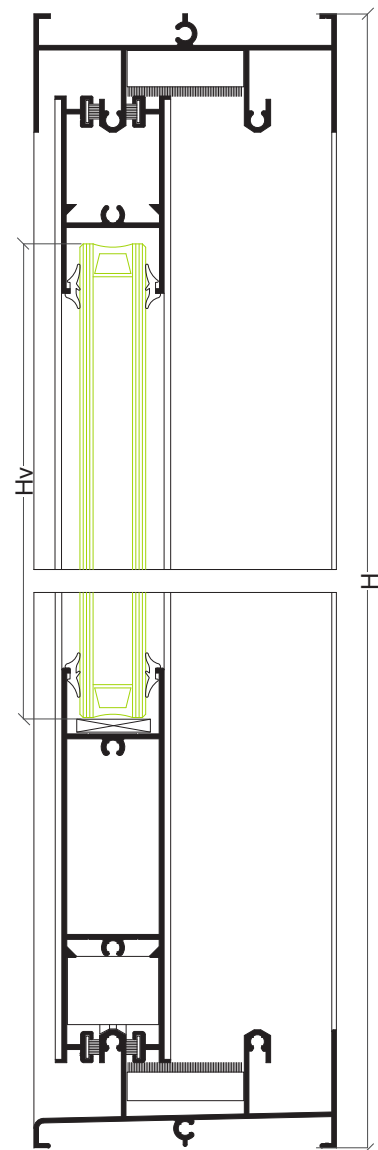
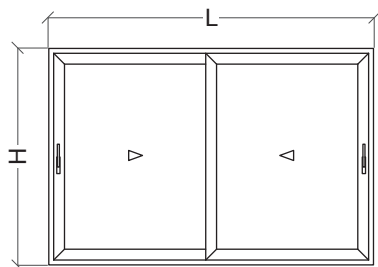



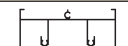

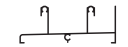

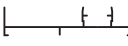
Hv = H-140 mm	Lv = L/4-63 mm
---------------	----------------



Porta 2 folhas correr multiponto



Perfis

Desenho	Ref	Descrição	Corte	Quant	Medida
	CS-12	Padieira		1	L-15 mm
	CS-19	Soleira		1	L-15 mm
	CS-25	Ombreira		2	H
	CS-80	Móvel carrinho		2	L/2-1.5 mm
	CS-82	Almofada		2	L/2-1.5 mm
	CS-96	Móvel lateral		2	H-53 mm
	CS-90	Móvel central		2	H-53 mm

Acessórios e Juntas

Referência	Descrição	Quantidade
30 91 41 32	Barra 3 pontos (1670 mm)	2
30 97 10 12	Kit porta 2 folhas CS Euro	1
30 91 41 71	Topo limitador	1
30 91 41 52	Cremona desviado direito branco	1
30 91 41 54	Cremona desviado esquerdo branco	1
30 95 00 80	Pelúcia 7x5 mm	4L/4H
30 95 00 40	Pelúcia 7x5.5 mm	2H
---	Junta de vidro	4L/8H

4 2 1

Vidro

Hv = H-201 mm	Lv = L/2-70 mm
---------------	----------------

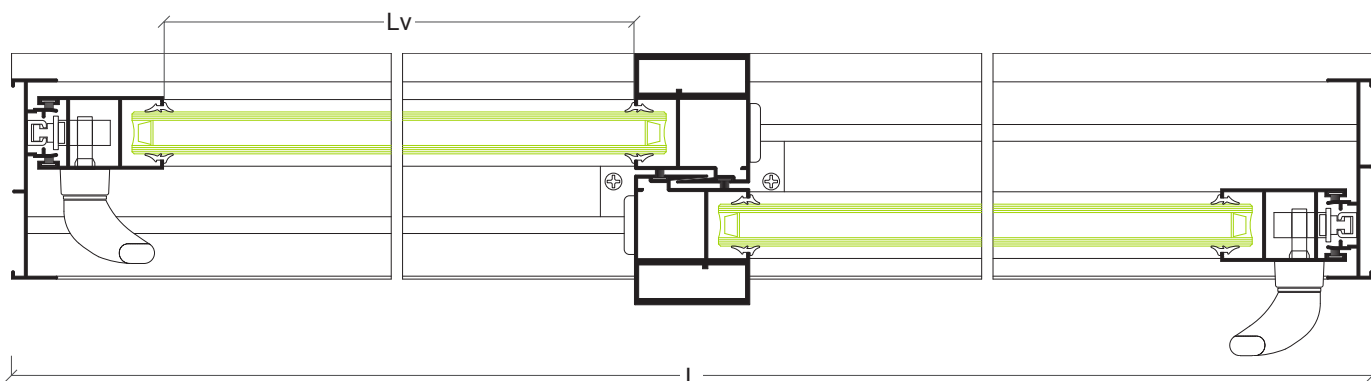

Porta 4 folhas correr multiponto

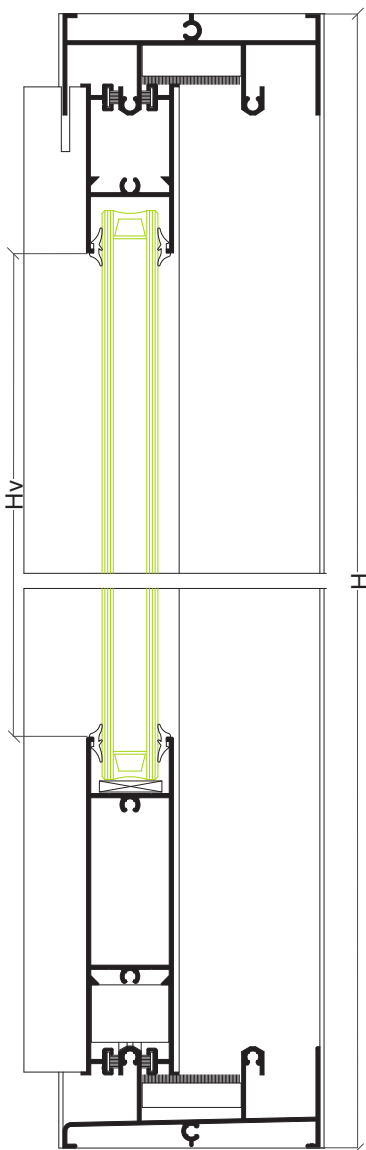
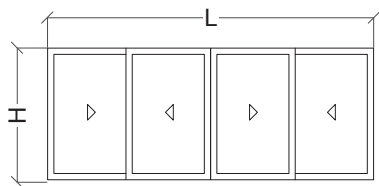

Perfis

Desenho	Ref	Descrição	Corte	Quant	Medida
	CS-12	Padieira		1	L-15 mm
	CS-19	Soleira		1	L-15 mm
	CS-25	Ombreira		2	H
	CS-80	Móvel carrinho		2	L/2+4 mm
	CS-82	Almofada		2	L/2+4 mm
	CS-96	Móvel lateral		2	H-53 mm
	CS-86	Móvel central		2	H-53 mm
	CS-38	União 3/4F		1	H-44 mm

Acessórios e Juntas

Referência	Descrição	Quantidade
30 91 41 32	Barra 3 pontos (1670 mm)	3
30 97 10 12	Kit porta 2 folhas CS Euro	2
30 91 41 71	Topo limitador	2
30 91 41 52	Cremone desviado direito branco	2
30 91 41 54	Cremone desviado esquerdo branco	1
30 95 00 80	Pelúcia 7x5 mm	4L/6H
30 95 00 40	Pelúcia 7x5.5 mm	4H
---	Junta de vidro	4L/16H

Vidro

Hv = H-201 mm	Lv = L/4-65 mm
---------------	----------------

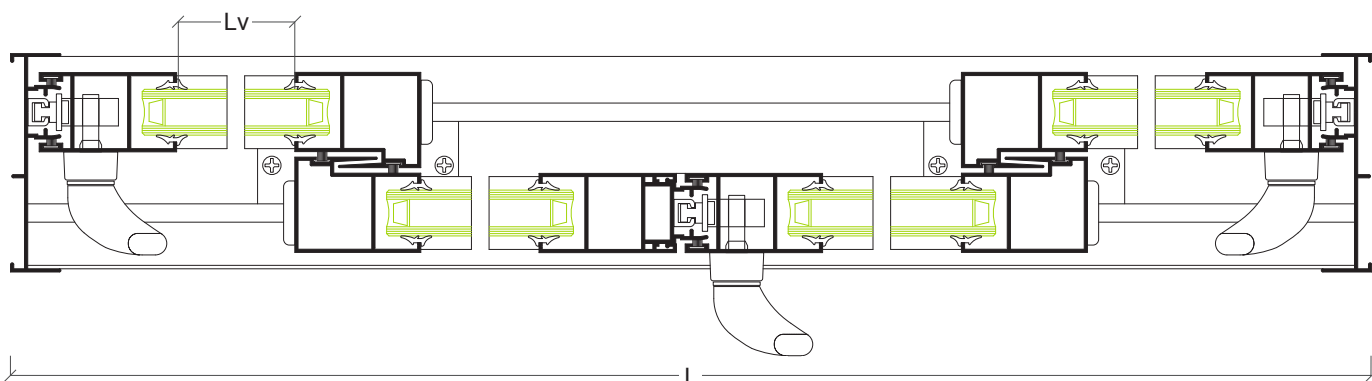

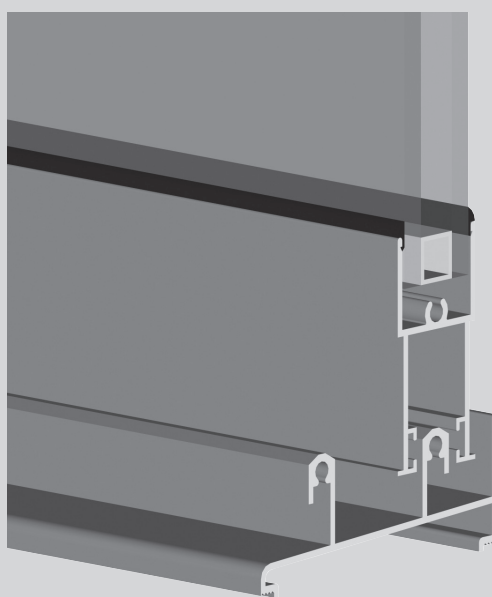
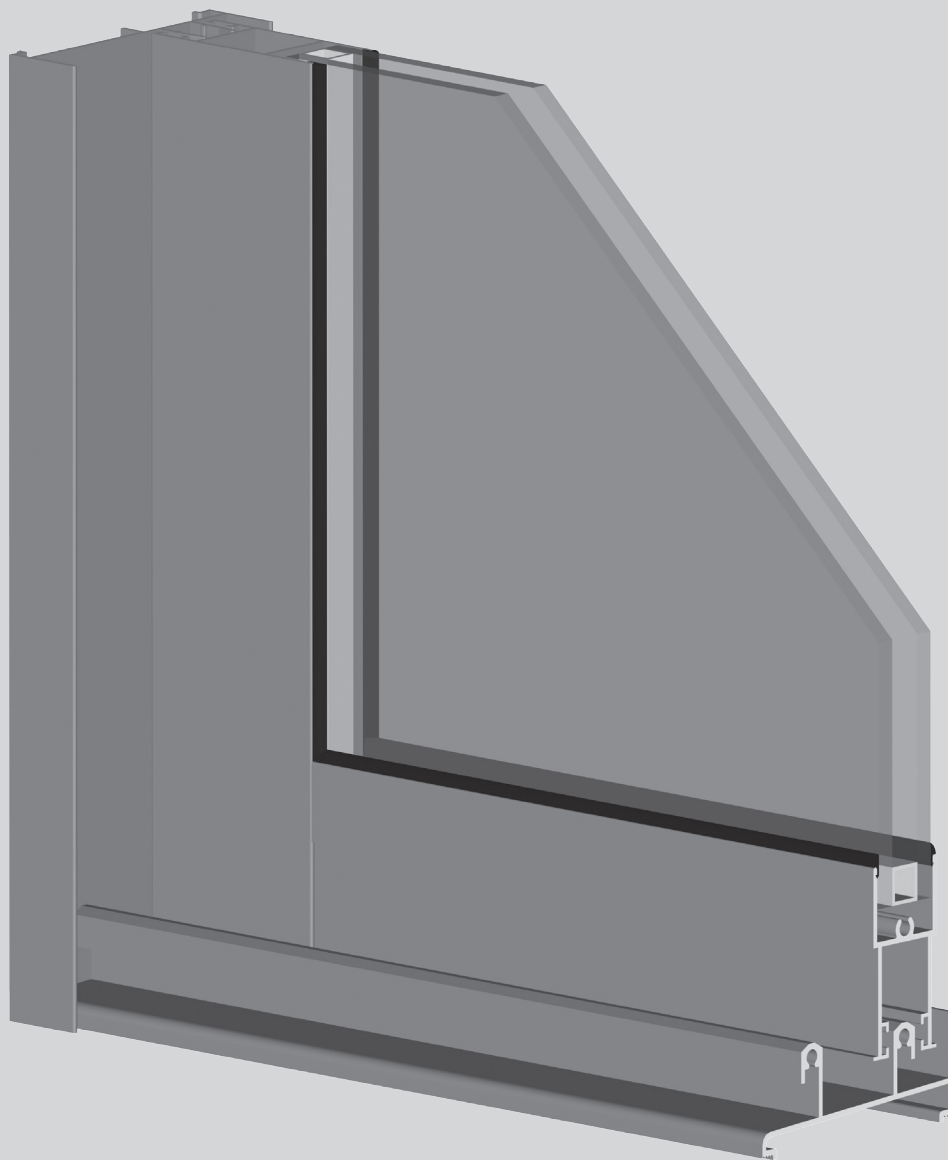

Sistema
SR

Sistema SR

Sistema de correr - 70 mm

Características do sistema

Sistema de alumínio tradicional e sistema Euro para execução de vãos de correr.

Perfis de alumínio

Os perfis de alumínio são extrudidos na liga de alumínio 6060 para arquitetura de acordo com norma NP EN 12020-02.

Espessura média dos perfis de alumínio de 1.4 mm.

Aros fixos

Secção do aro fixo de 2 guias de 72 mm para montagem a corte recto;

Secção do aro fixo de 3 guias de 106.5 mm para montagem a corte recto.

Aros móveis

Secção dos aros móveis de 23.5 mm para montagem a corte recto.

Enchimento de 4 mm a 16 mm;

Dimensionamento e manobralidade

Possibilidades de abertura: 1, 2, 3, 4 e 6 folhas, com folhas móveis e/ou fixas;

Performances

Sistema certificado por laboratório notificado do ensaio tipo inicial (ITT) de acordo com a norma de produto EN 14351-1 para efeitos de Marcação CE.

Categorias alcançadas na avaliação do sistema SR:

1. Permeabilidade ao ar: Classe 3 (norma de ensaio EN 1026)
2. Estanquidade à água: Classe 6A (norma de ensaio EN 1027)
3. Resistência ao vento: Classe C2 (norma de ensaio EN 12211)

Coefficiente de transmissão térmica de vão de 2 folhas com 1.60 m x 2.00 m com vidro $U_g = 2.1 \text{ W/m}^2\text{K}$:

• $U_w = 3.33 \text{ W/m}^2\text{K}$

Coefficiente de atenuação acústica de vão de 2 folhas com vidro 4/8/4:

• $R_w (C; C_{tr}) = 28 \text{ dB} (-1; -1)$

Zonas de aplicação segundo RCCTE (em função do valor U_g): I1, I2, I3, V1, V2, V3;

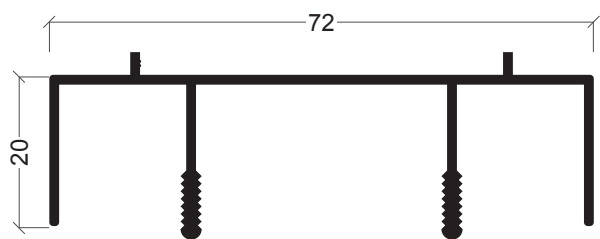

SR-01
Padieira

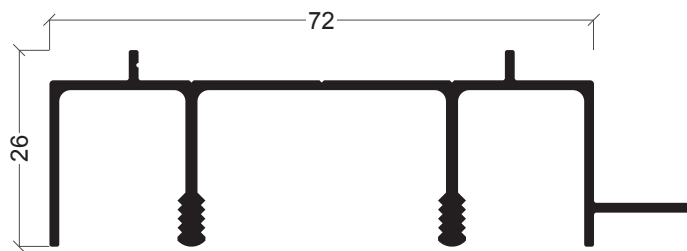

SR-31
Padieira

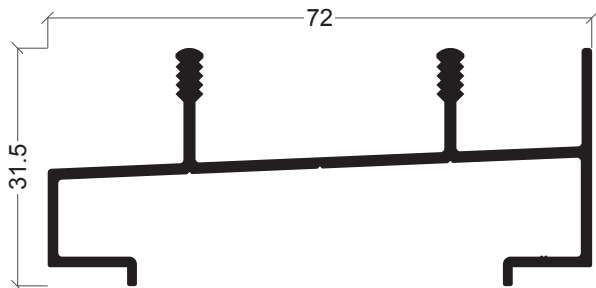

SR-16
Soleira

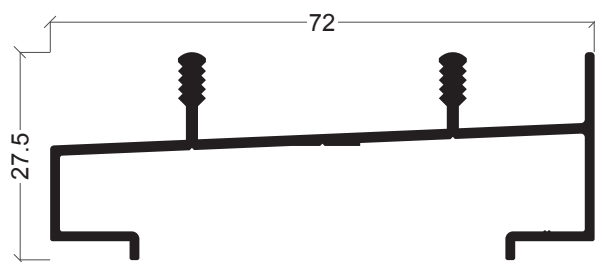

SR-16A
Soleira

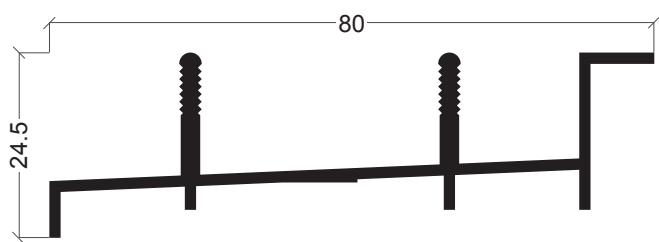

SR-02
Soleira

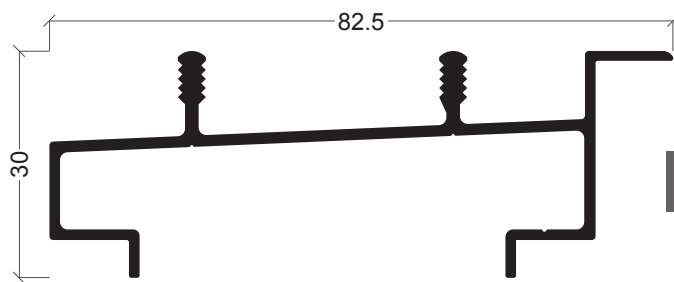

SR-26
Soleira

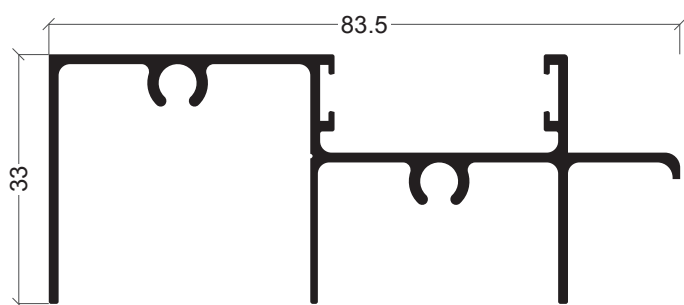

SR-34
Ombreira

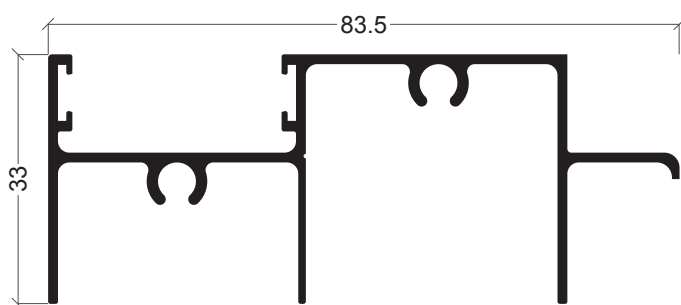

SR-44
Ombreira

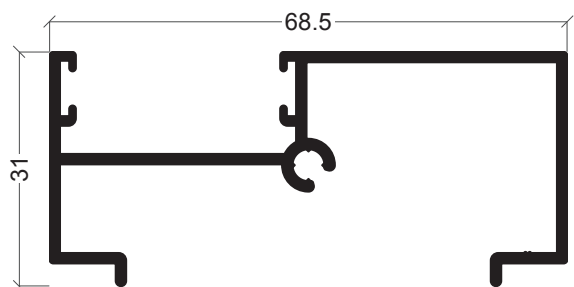

SR-04
Ombreira

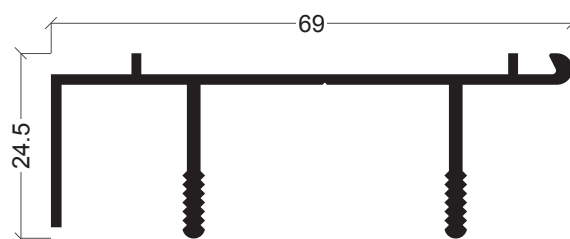

SR-51
Padieira janela dupla

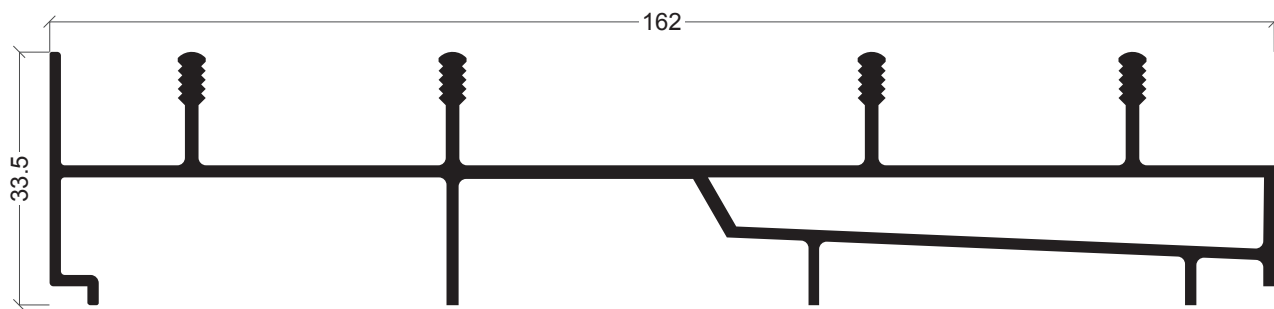

SR-56
Soleira janela dupla

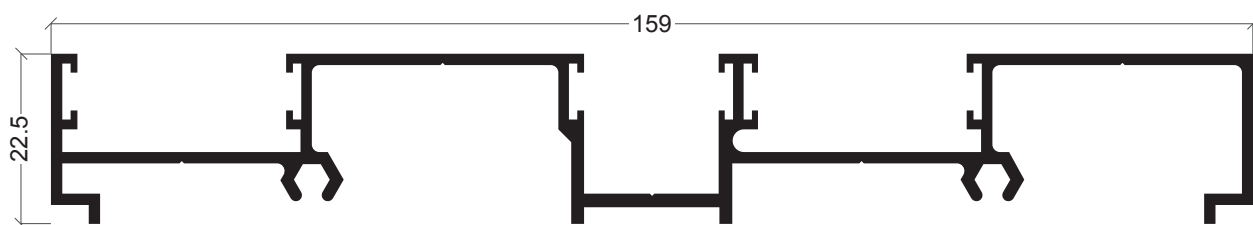

SR-54
Ombreira janela dupla

426

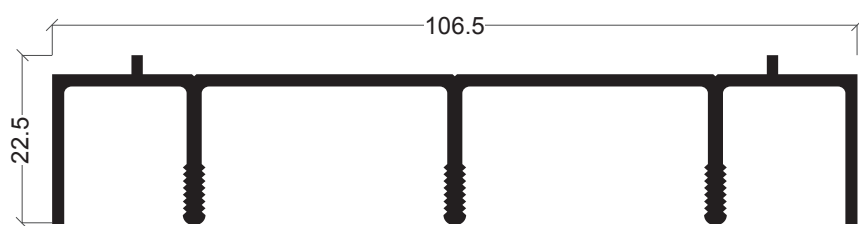

SR-81
Padeira tri-rail

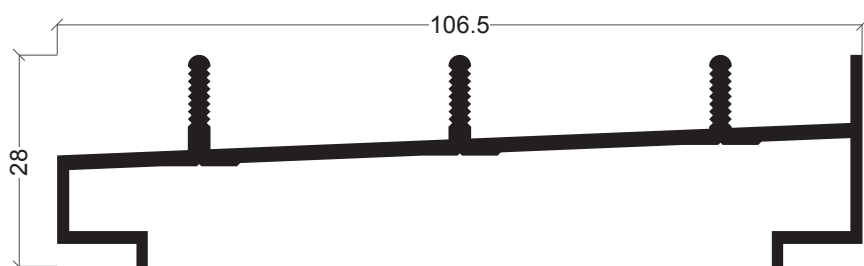

SR-86
Soleira tri-rail

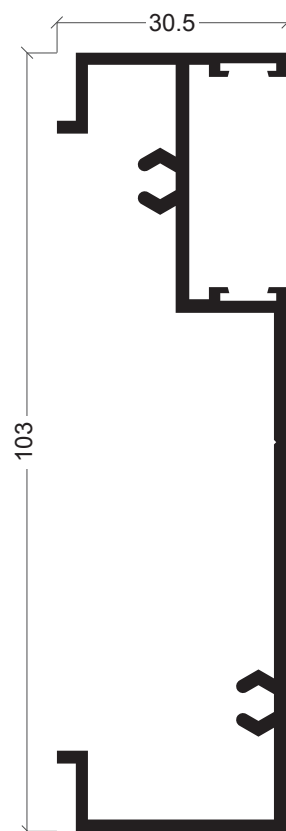

SR-84
Ombreira tri-rail

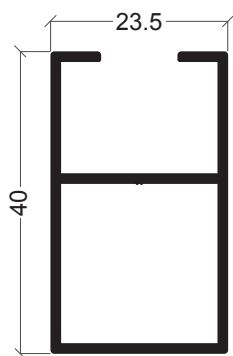

SR-05

Aro móvel lateral

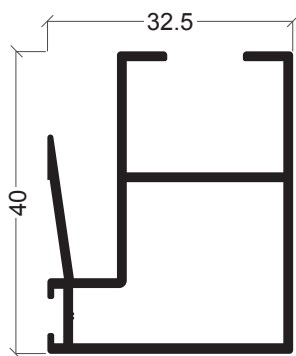

SR-06

Aro móvel central

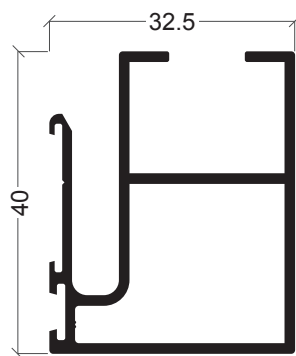

SR-06A

Aro móvel central

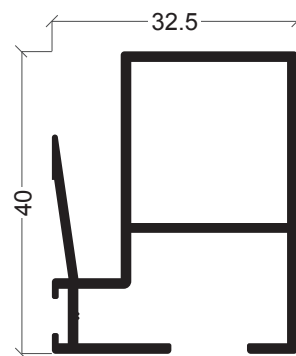

SR-07

Aro móvel central 3F

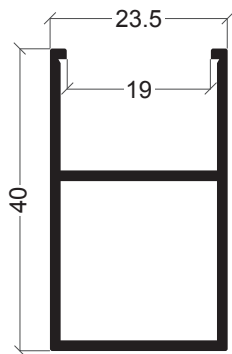

SR-65

Aro móvel lateral

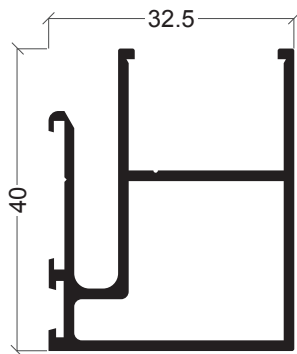

SR-66

Aro móvel central

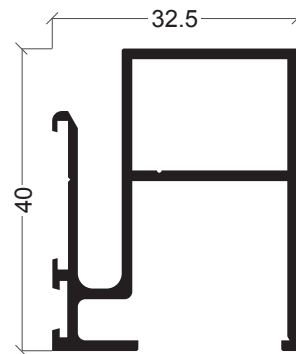

SR-67

Aro móvel central 3F

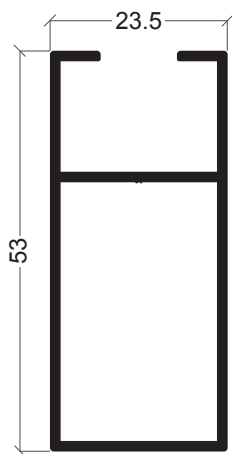

SR-17

Aro móvel lateral

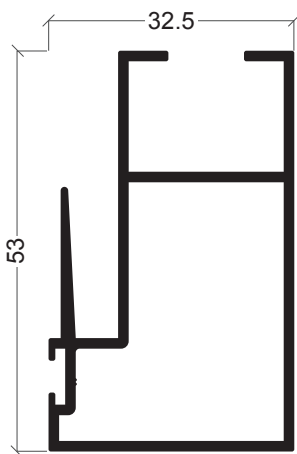

SR-18

Aro móvel central

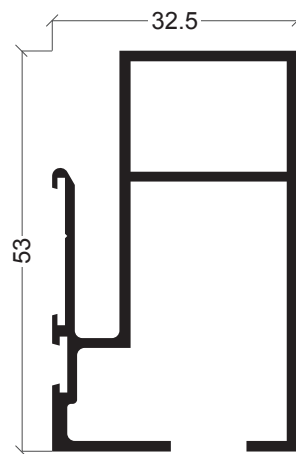

SR-20

Aro móvel central 3F

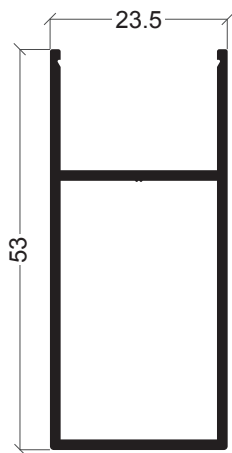

SR-27

Aro móvel lateral

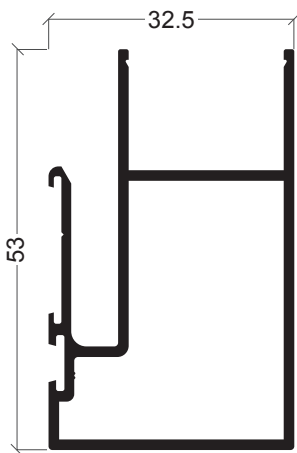

SR-28

Aro móvel central

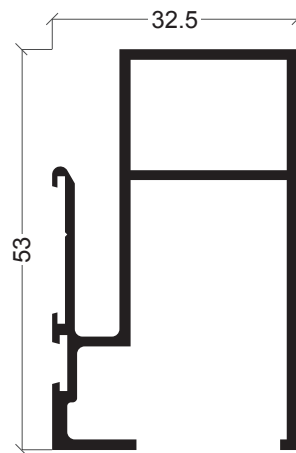

SR-30

Aro móvel central 3F

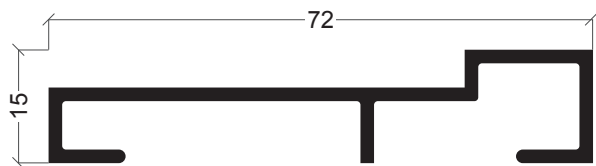

SR-15
União de aros

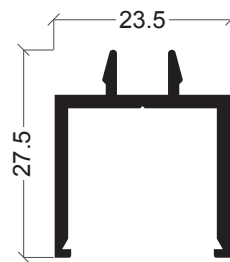

SR-21
Perfil vidro duplo

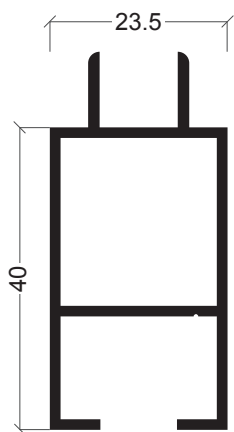

SR-08
Aro móvel

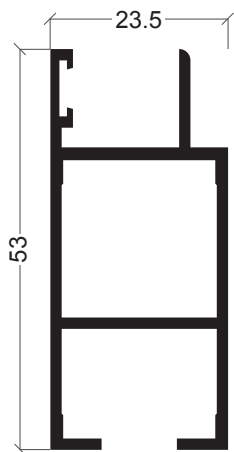

SR-08A
Aro móvel

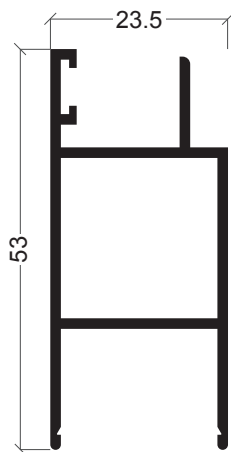

SR-78
Aro móvel

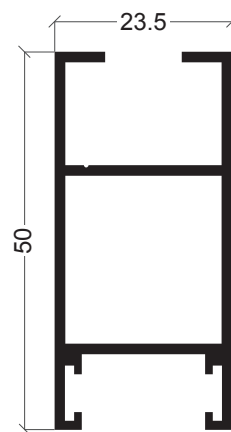

SR-09
Aro móvel

428

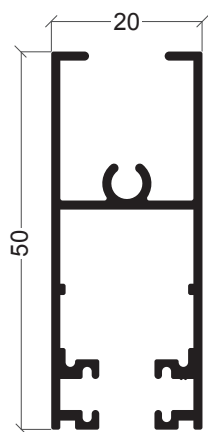

SR-10
Aro móvel carrinho

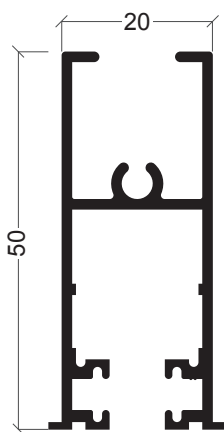

SR-10A
Aro móvel carrinho

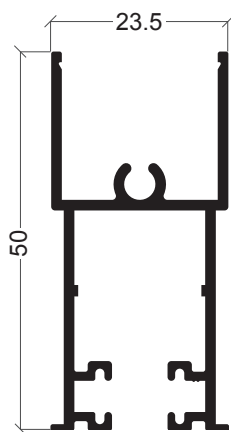

SR-70
Aro móvel carrinho

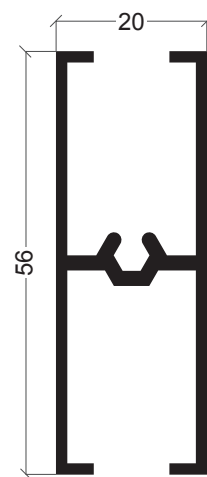

SR-13
Travessa

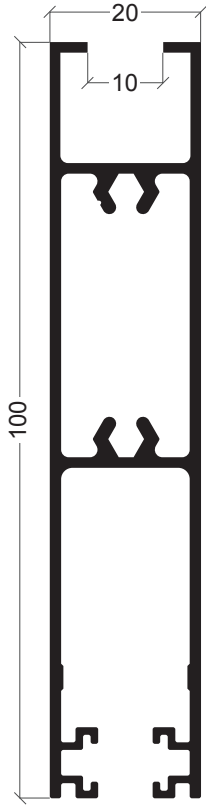

SR-12
Almofoada carrinho

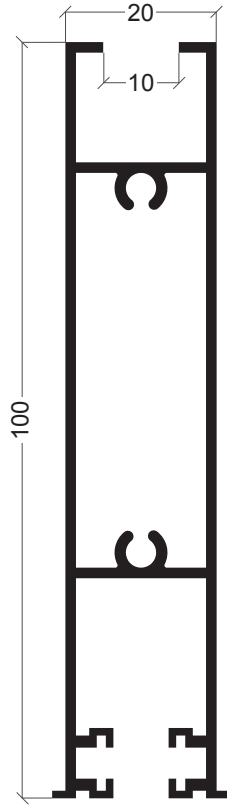

SR-12A
Almofoada carrinho

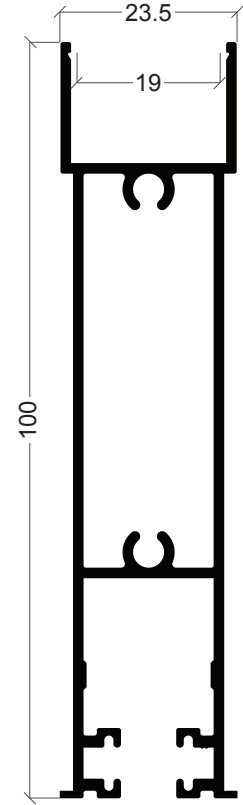

SR-72
Almofoada carrinho

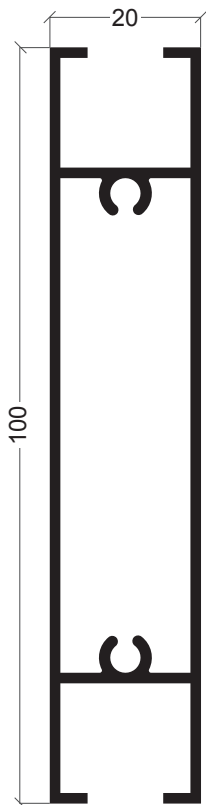

SR-11
Travessa

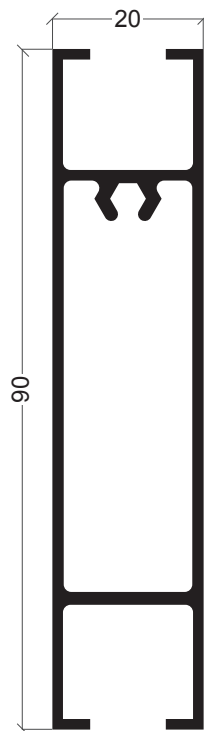

SR-11A
Travessa

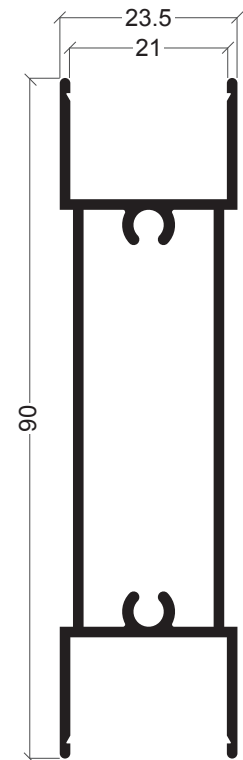

SR-71
Travessa

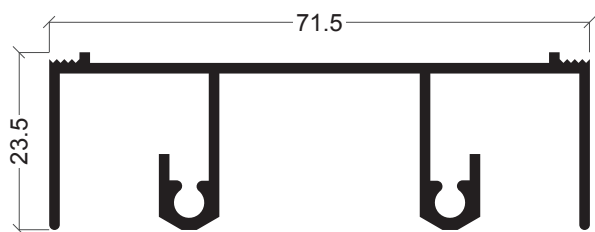

SR-41
Padieira

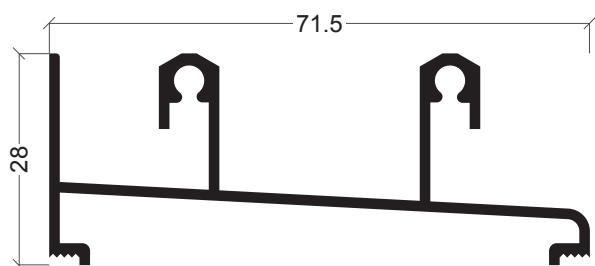

SR-42
Soleira

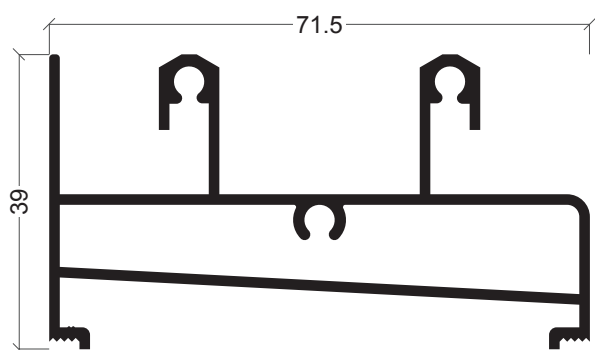

SR-46
Soleira

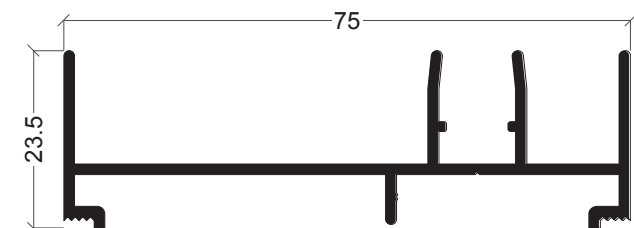

SR-24
Ombreira

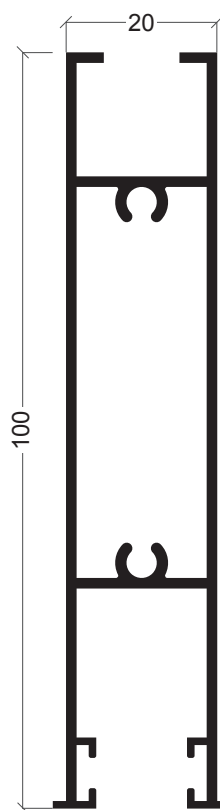

SR-32
Almofada carrinho

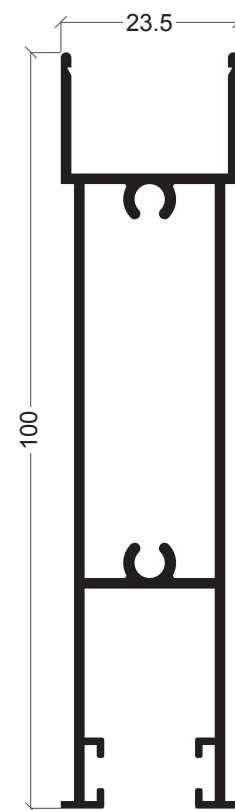

SR-82
Almofada carrinho

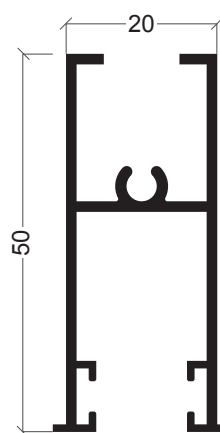

SR-40
Aro móvel carrinho

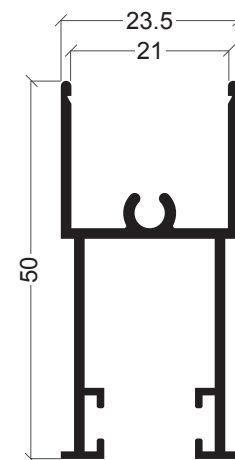

SR-80
Aro móvel carrinho

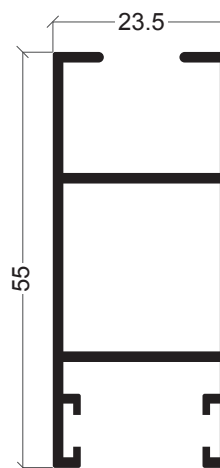

SR-35
Aro móvel lateral

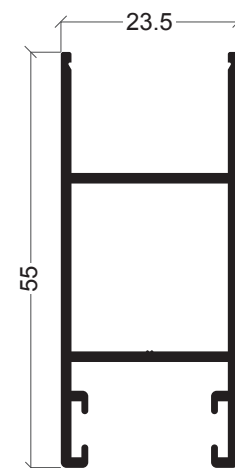

SR-45
Aro móvel lateral

Fachada Estrutural

Fachada Semi-Estrutural

Fachada Muro Invertido

Fachada Milénio

Sistema Ergolux

Lâminas Quebra Sol

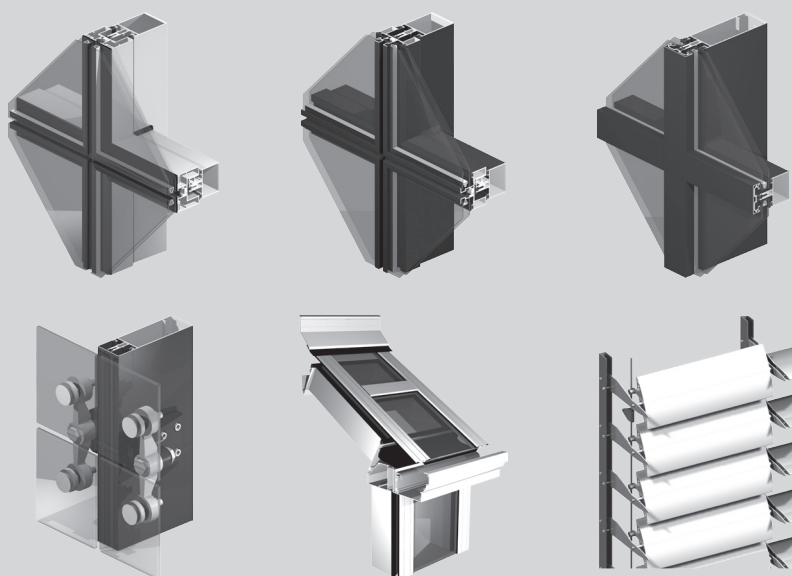

Sistema

FL

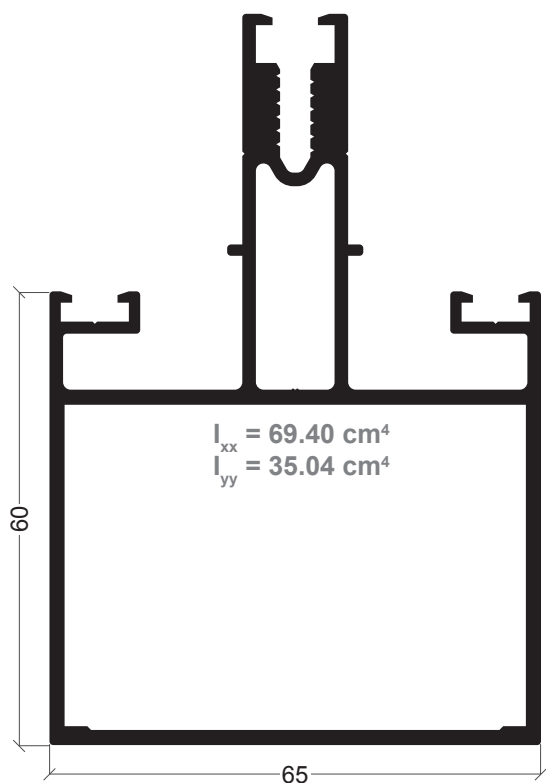

FL-14
Montante de 60 mm

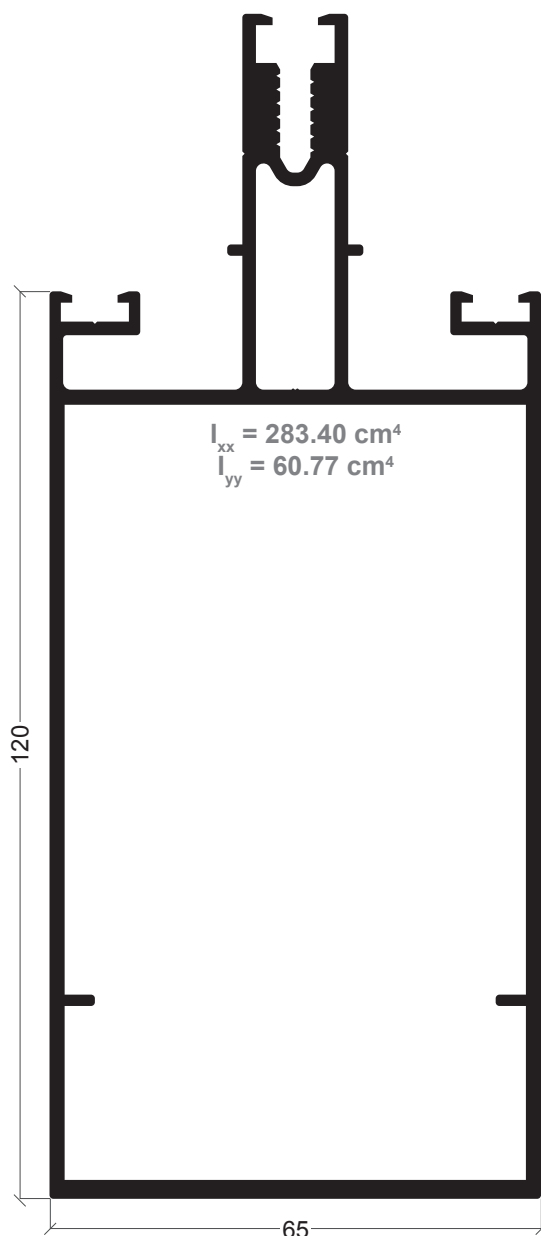

FL-13
Montante de 120 mm

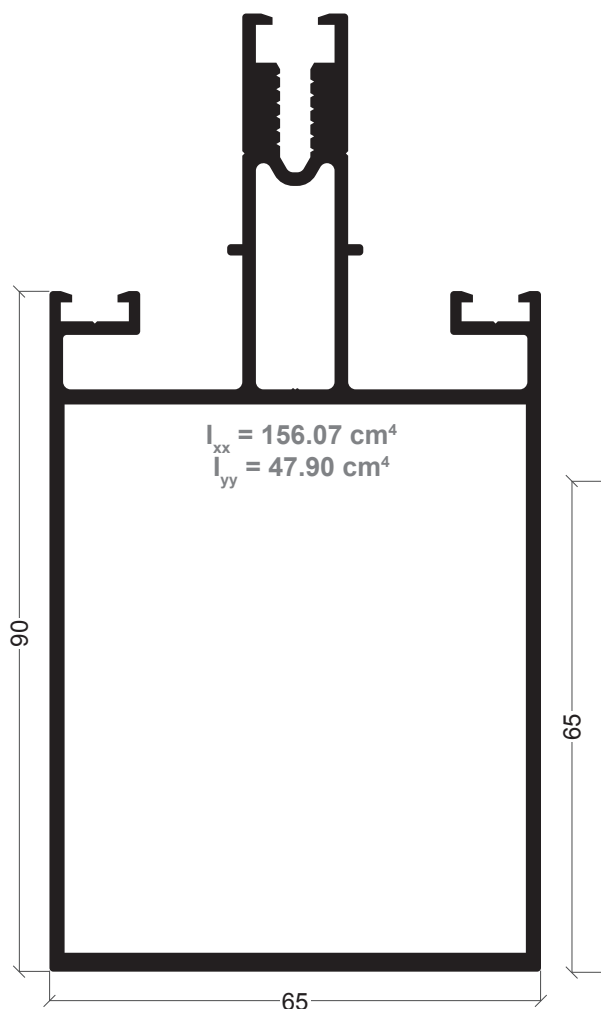

FL-10
Montante de 90 mm

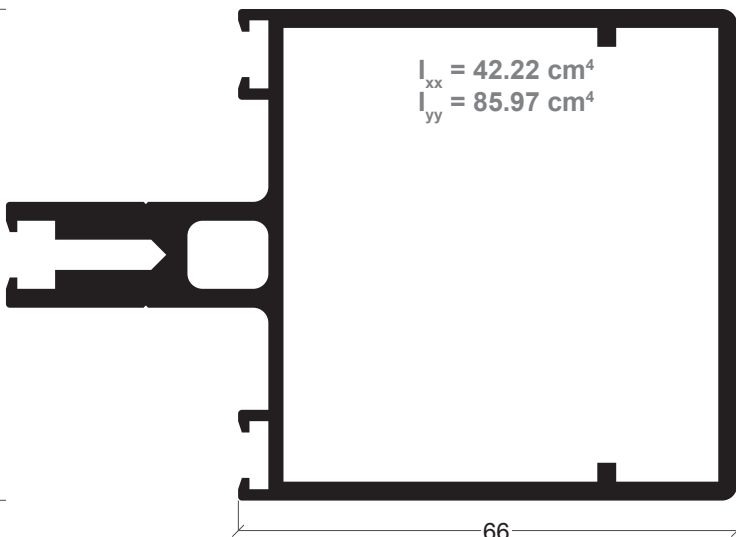

FL-80
Travessa 66 mm

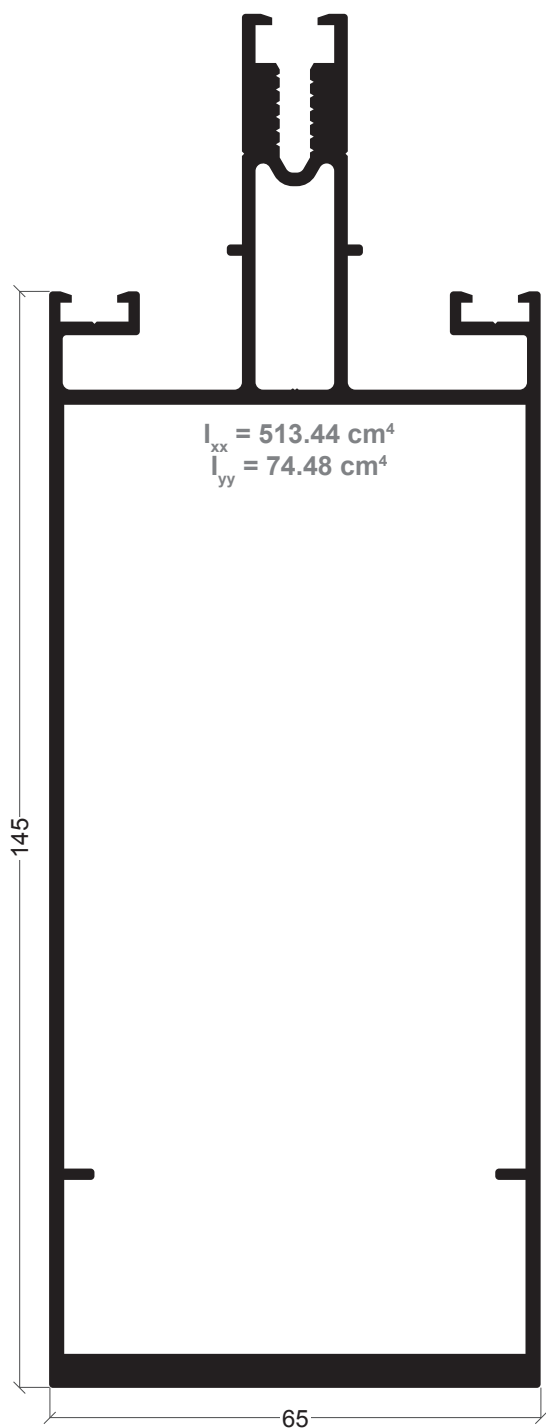

FL-11
Montante de 145 mm

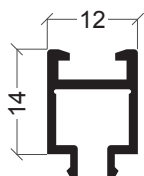

FL-32
Suplemento

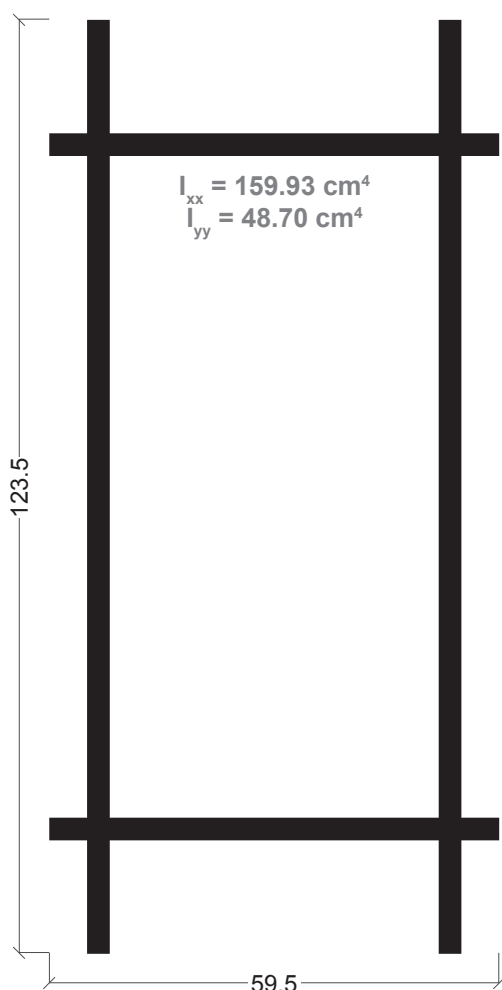

FL-20
União de montantes

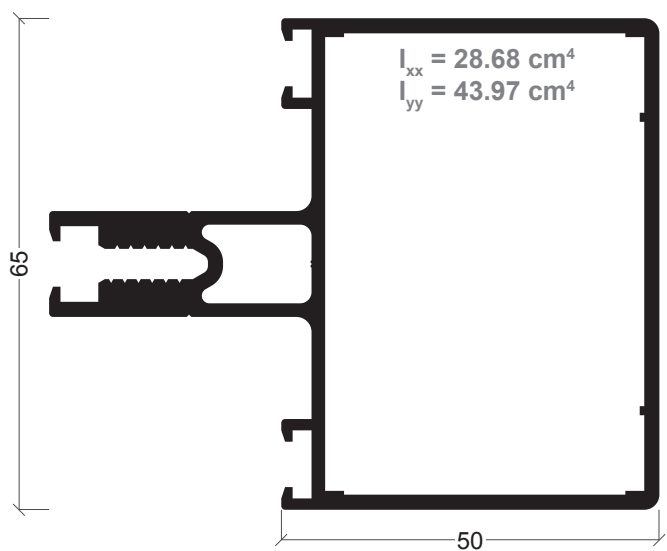

FL-12
Travessa 50 mm

434

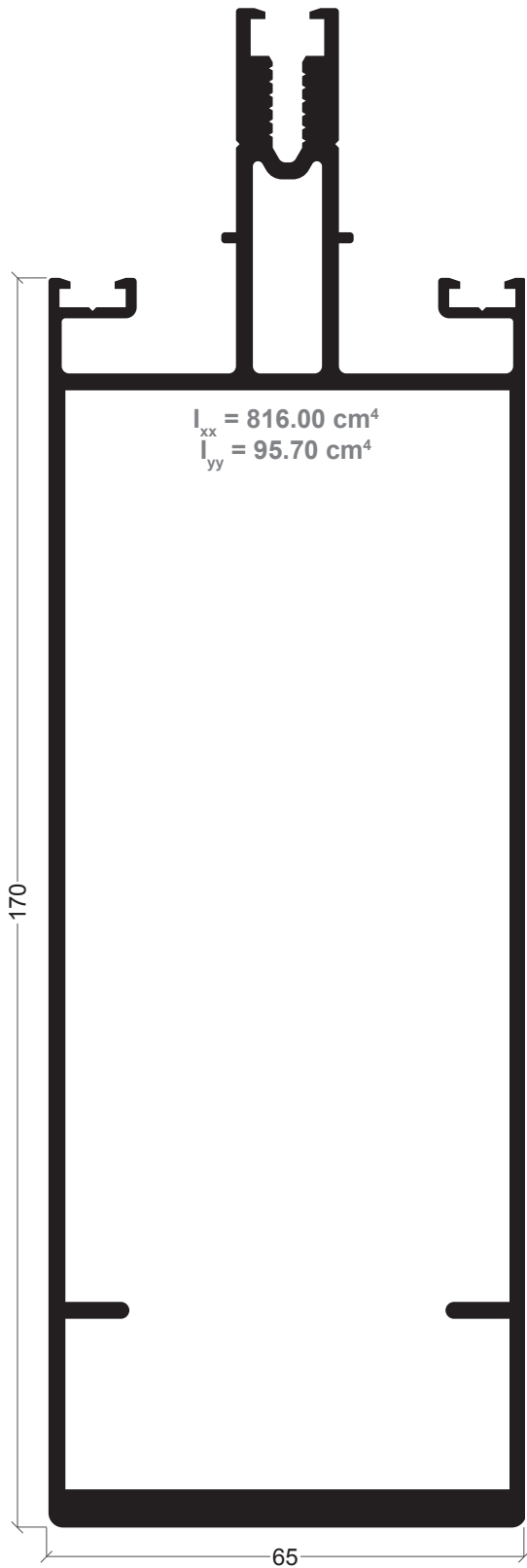

FL-70
Montante de 170 mm

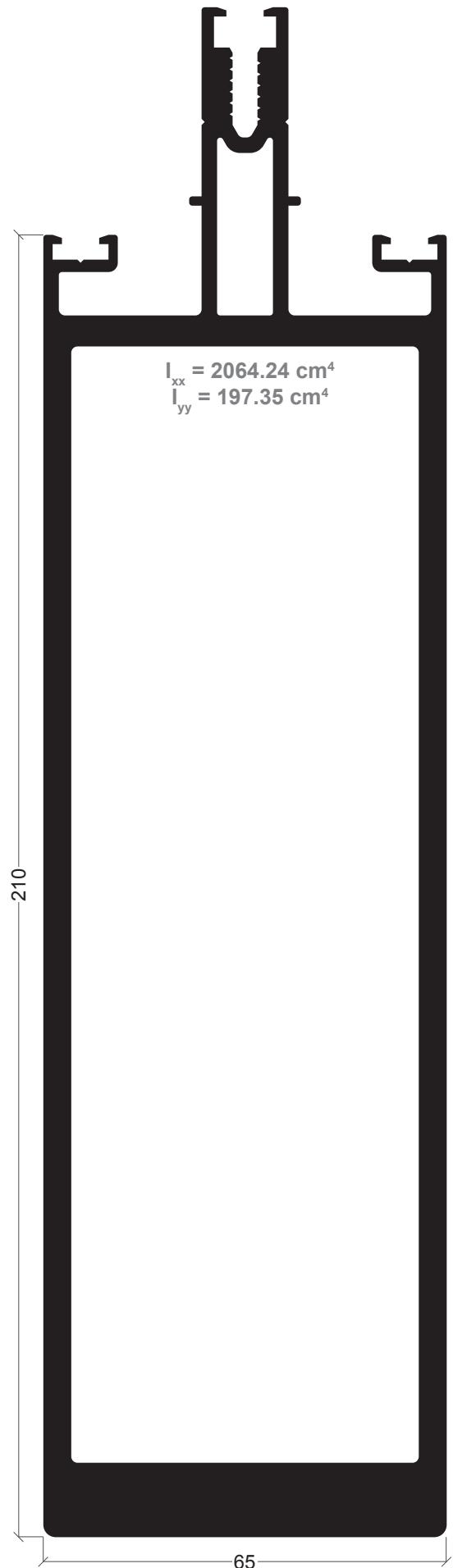

FL-34
Montante de 210 mm

436

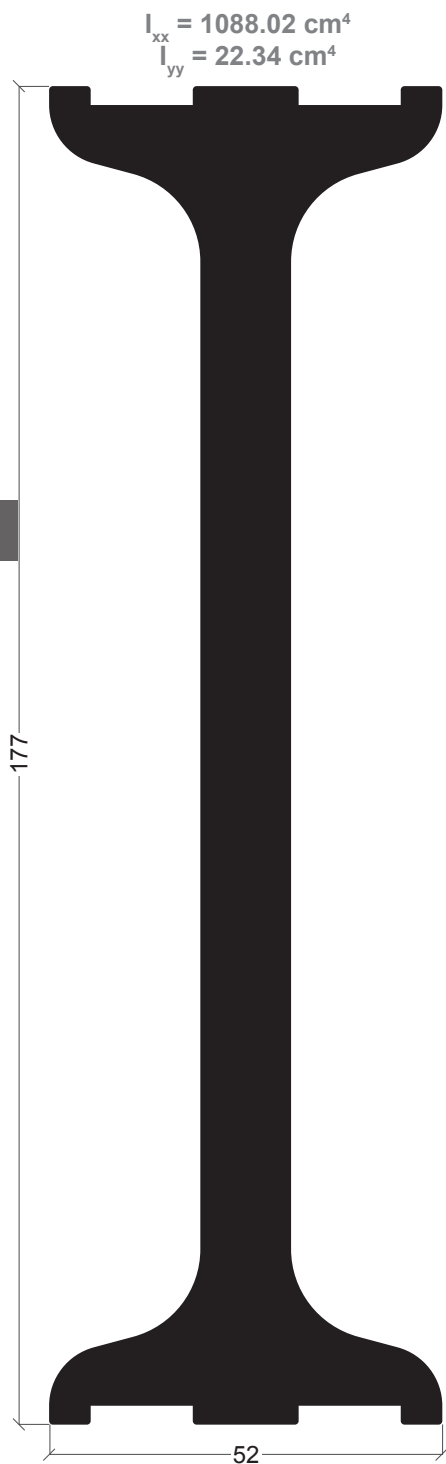

FL-40
IPN de reforço

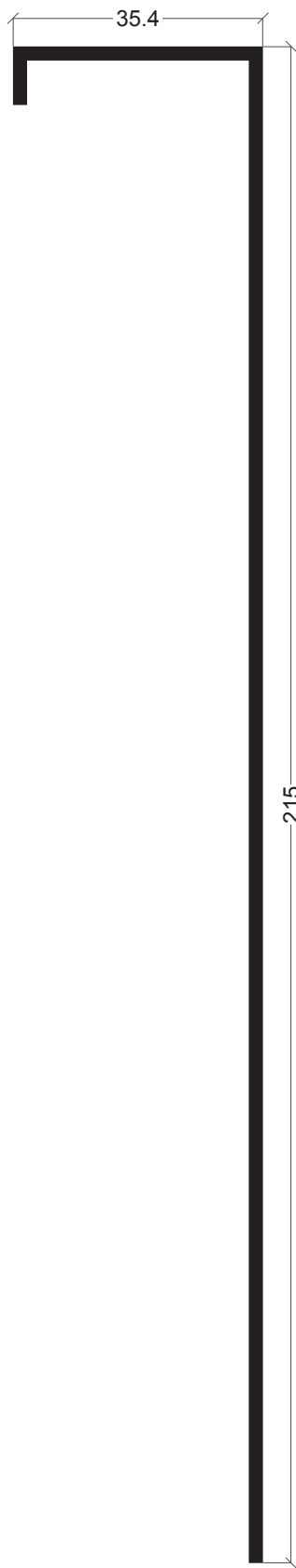

FL-21
Remate

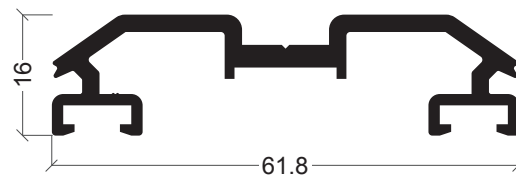

FL-07
Contra tampa

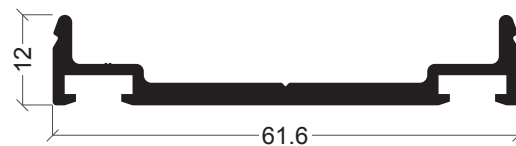

FL-35
Contra tampa

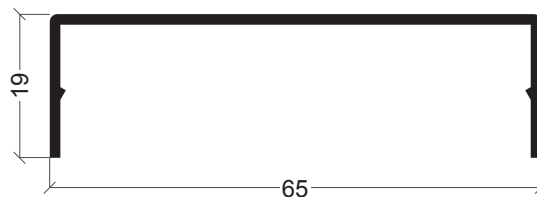

FL-08
Tampa vertical

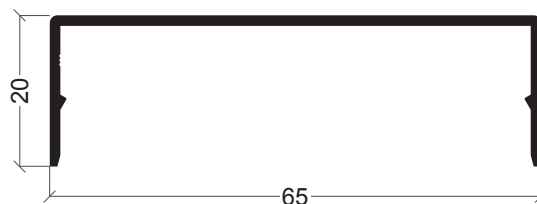

FL-09
Tampa vertical

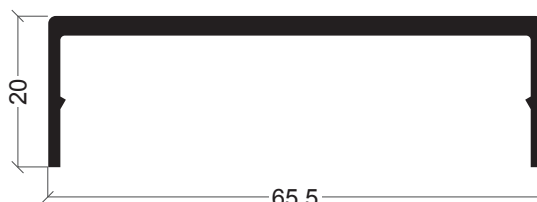

FL-33
Tampa vertical

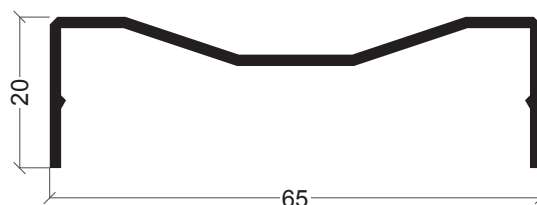

FL-36
Tampa trapezoidal vertical

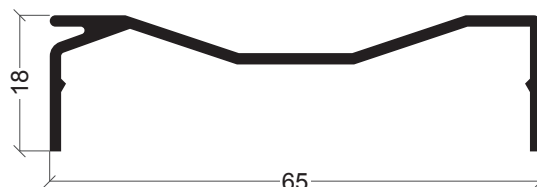

FL-37
Tampa trapezoidal horizontal

FL-05

Montante 60 mm regulável

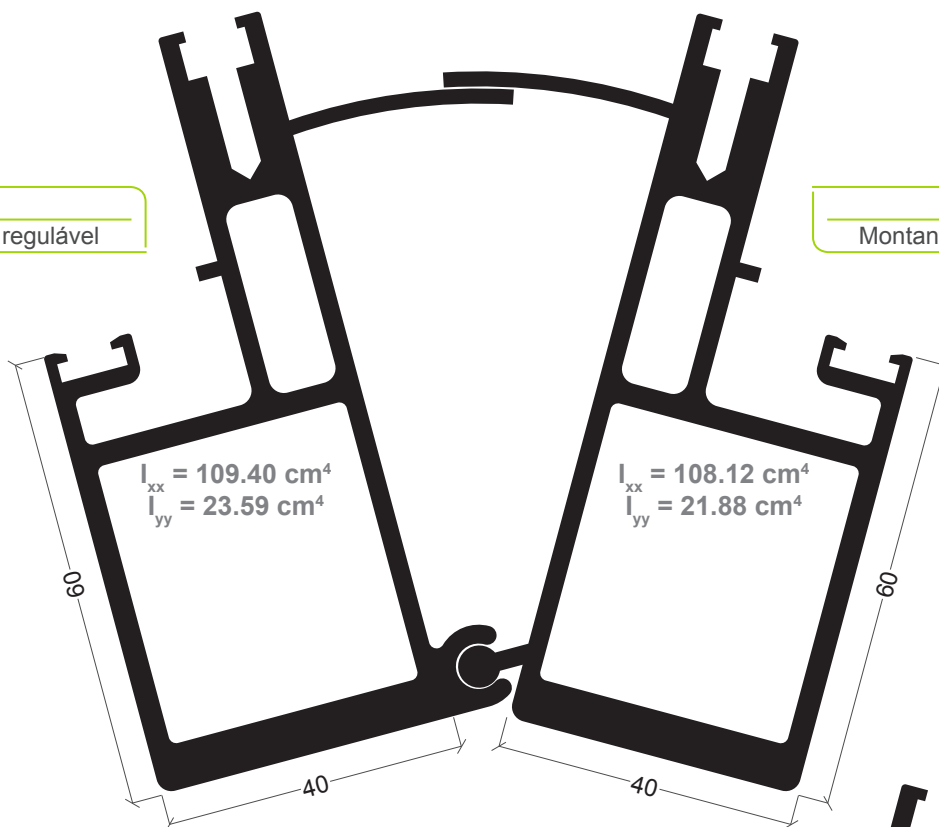

$$I_{xx} = 109.40 \text{ cm}^4$$

$$I_{yy} = 23.59 \text{ cm}^4$$

$$I_{xx} = 108.12 \text{ cm}^4$$

$$I_{yy} = 21.88 \text{ cm}^4$$

FL-04

Montante 60 mm regulável

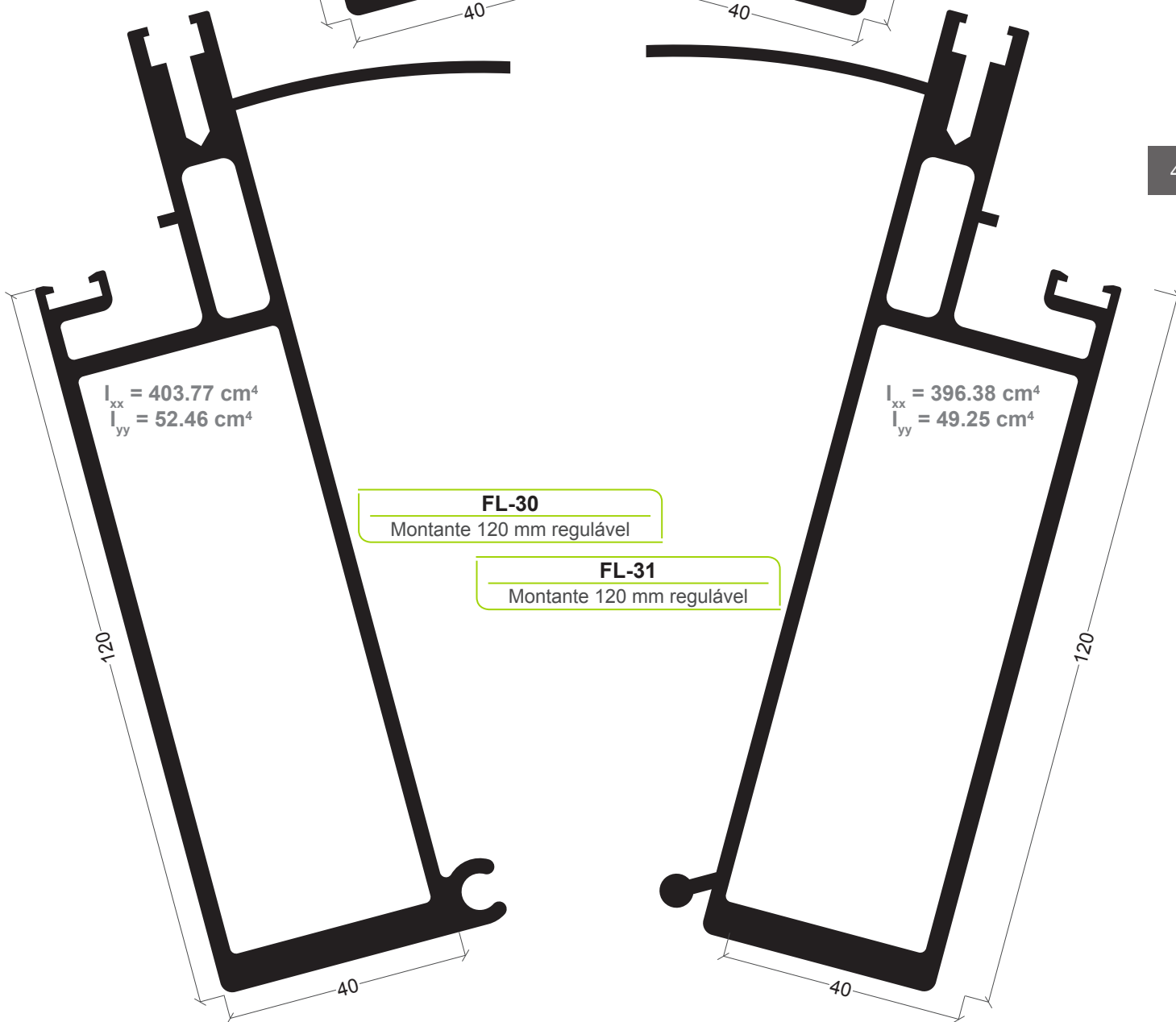

$$I_{xx} = 403.77 \text{ cm}^4$$

$$I_{yy} = 52.46 \text{ cm}^4$$

$$I_{xx} = 396.38 \text{ cm}^4$$

$$I_{yy} = 49.25 \text{ cm}^4$$

FL-30

Montante 120 mm regulável

FL-31

Montante 120 mm regulável

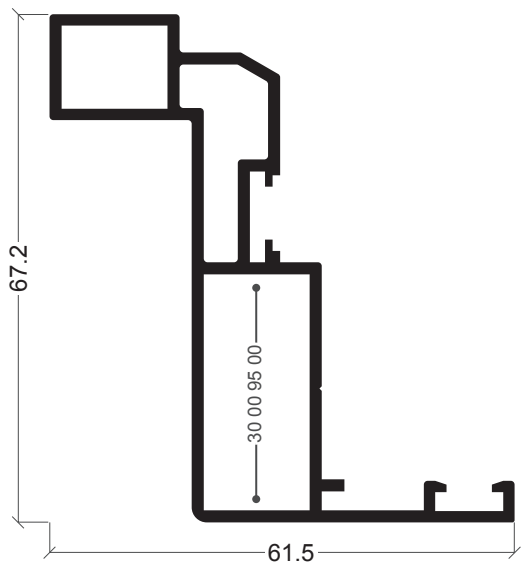

FL-25
Aro fixo projectante

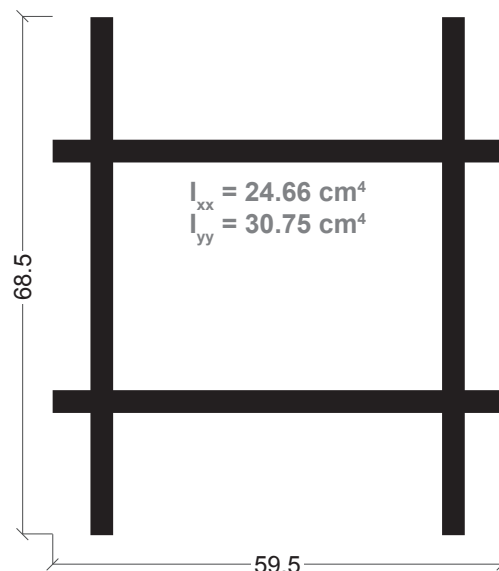

FL-38
União de montantes

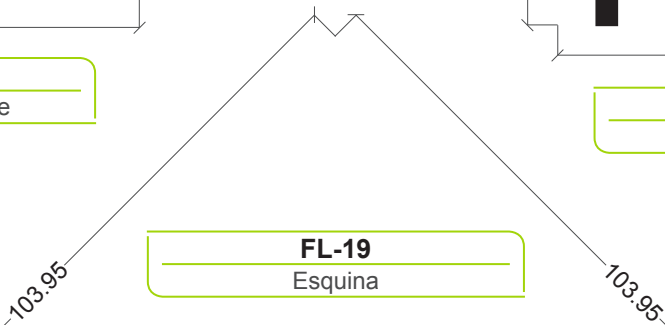

FL-19
Esquina

438

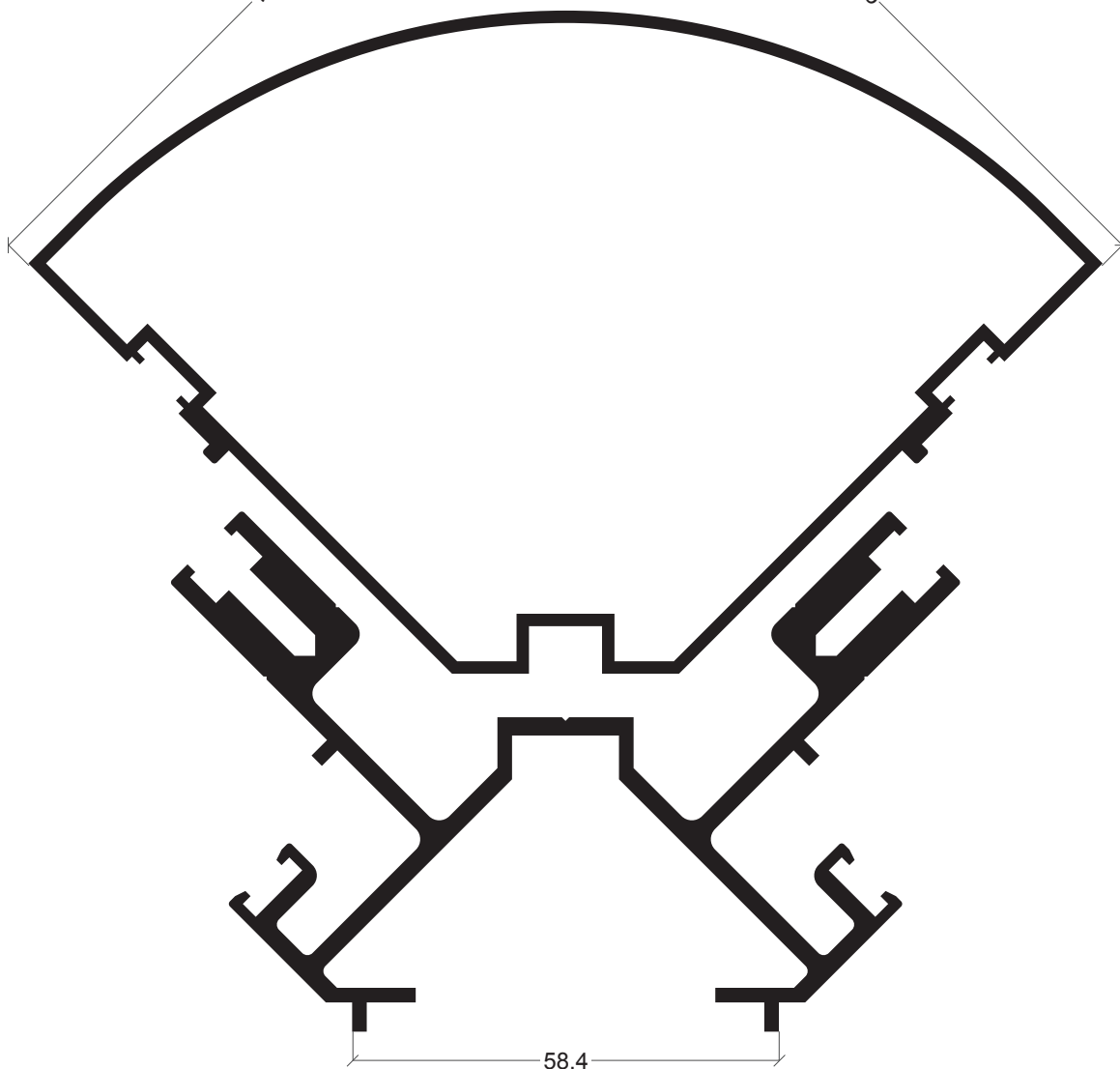

FL-18
Fixador de esquina

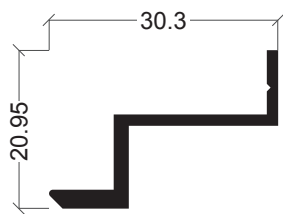

FL-39

Perfil de segurança



AX-19

Vareta

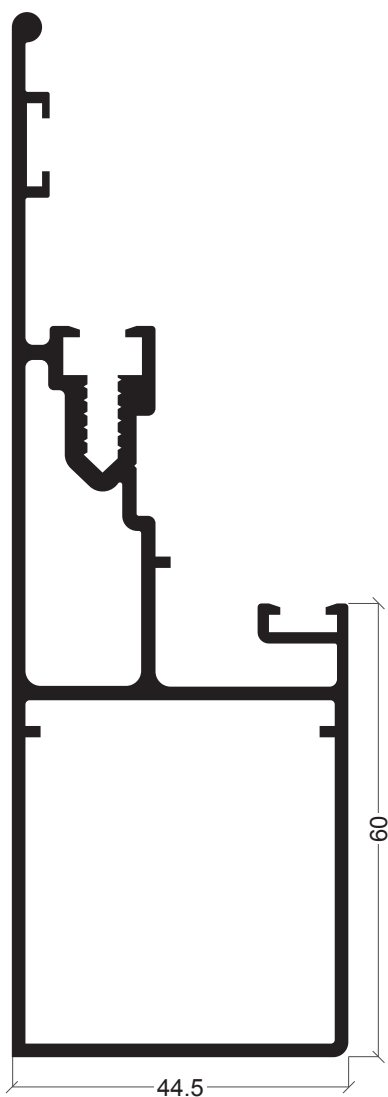

FL-17

Montante remate 60 mm

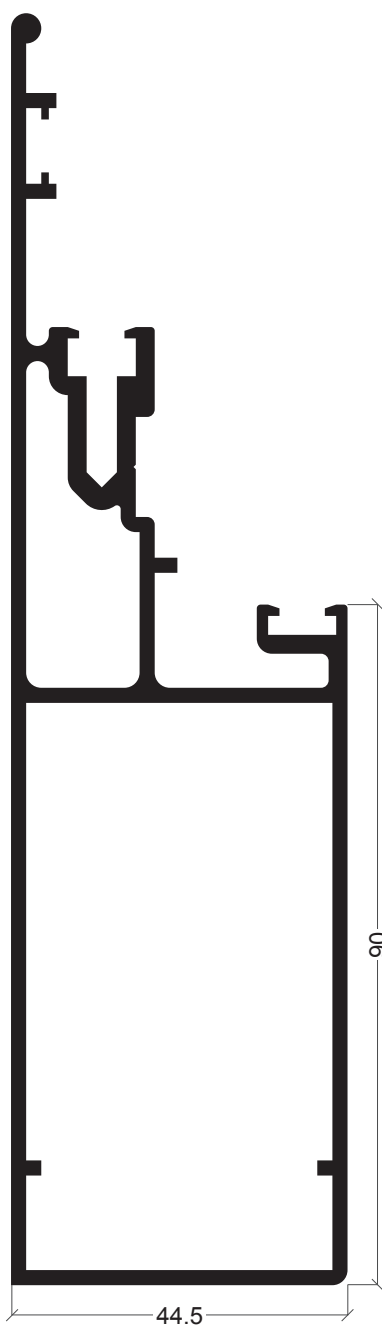

FL-77

Montante remate 90 mm

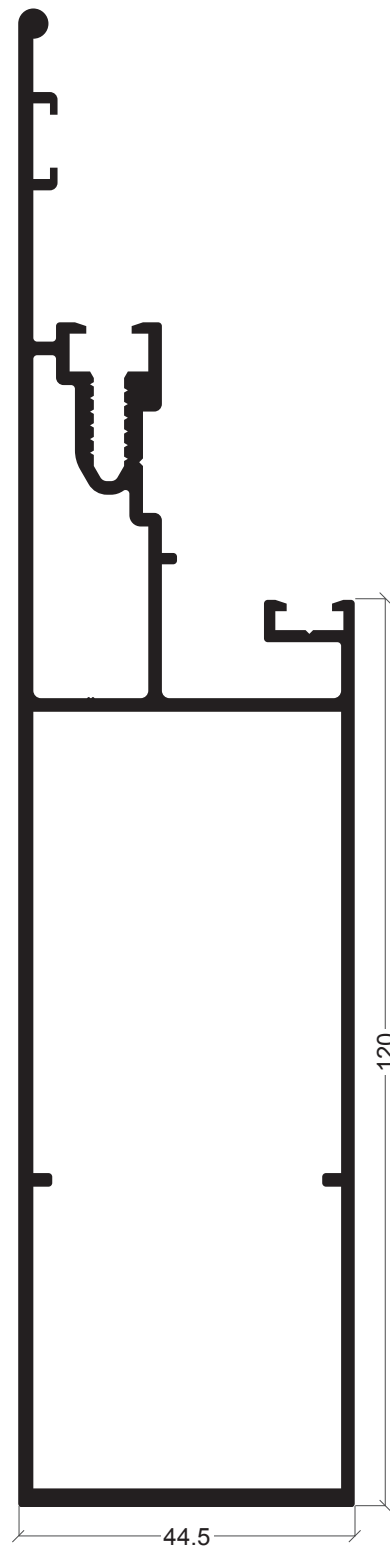

FL-16

Montante remate 120 mm

440

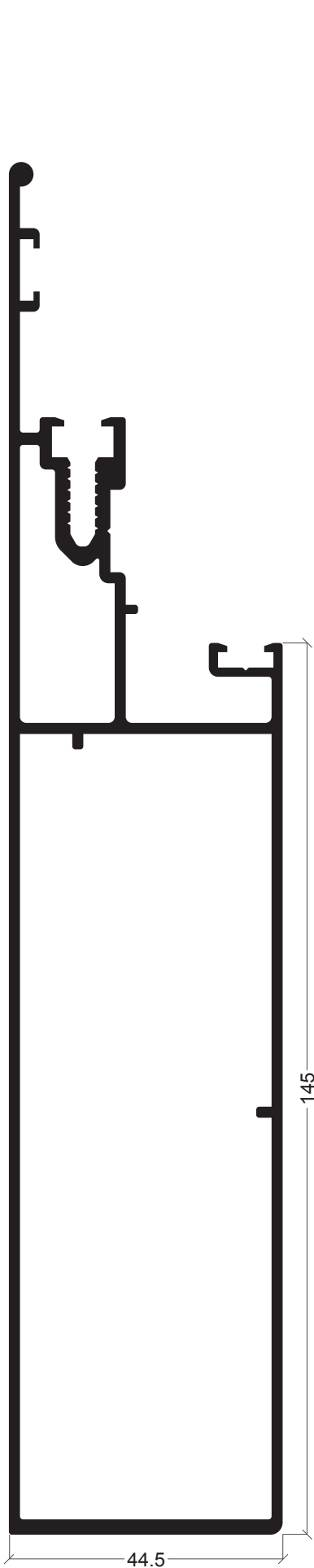

FL-15

Montante remate 140 mm

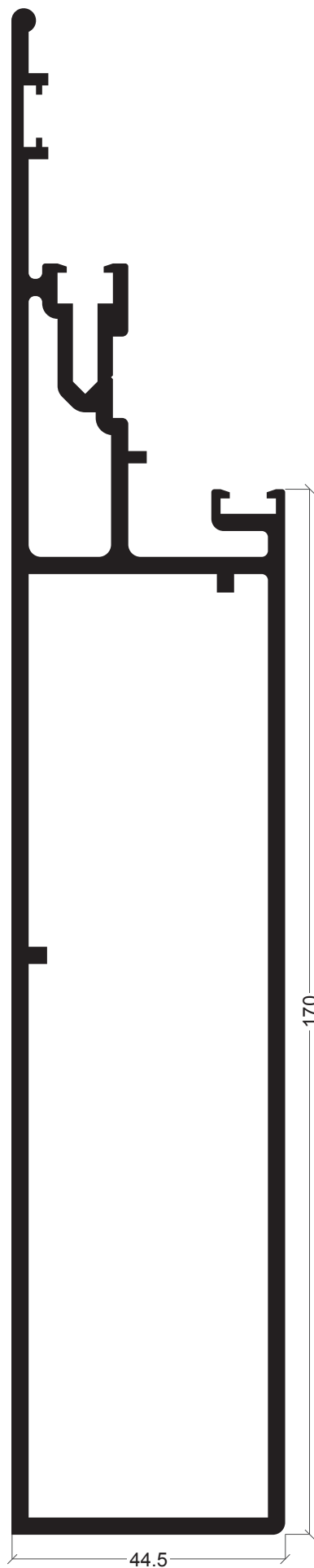

FL-79

Montante remate 170 mm

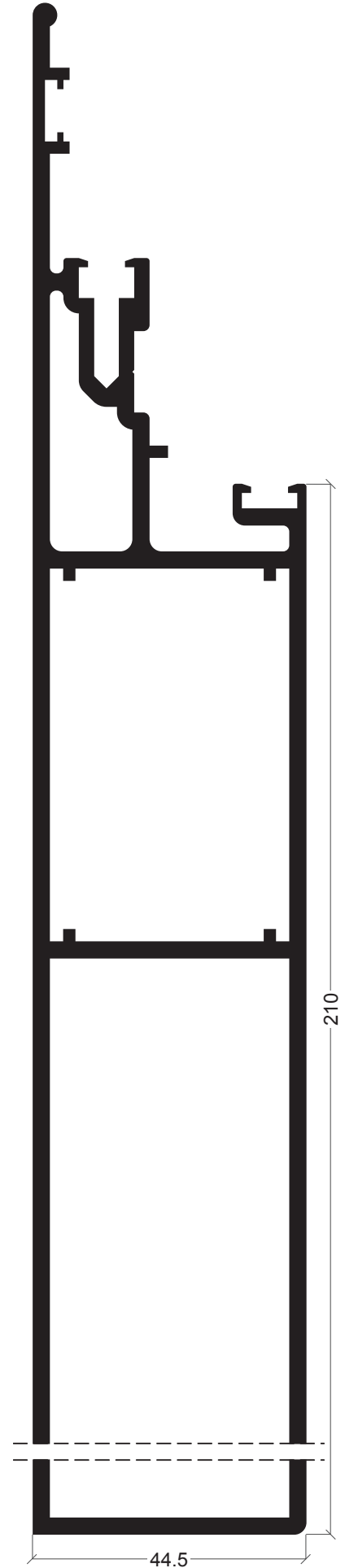

FL-78

Montante remate 210 mm

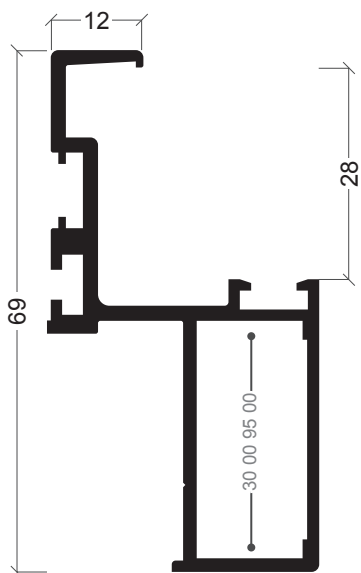

FL-03
Folha semi-estrutural

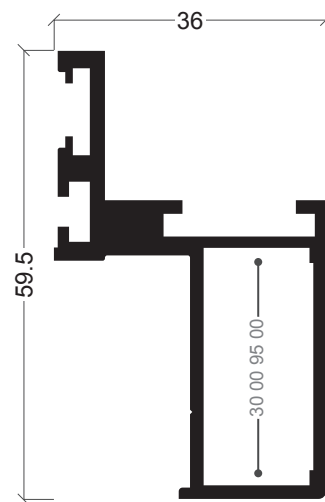

FL-06
Folha estrutural

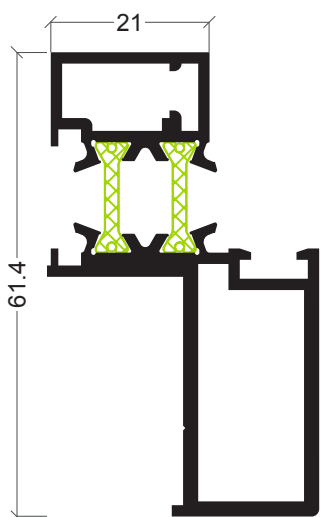

FL-27
Folha estrutural

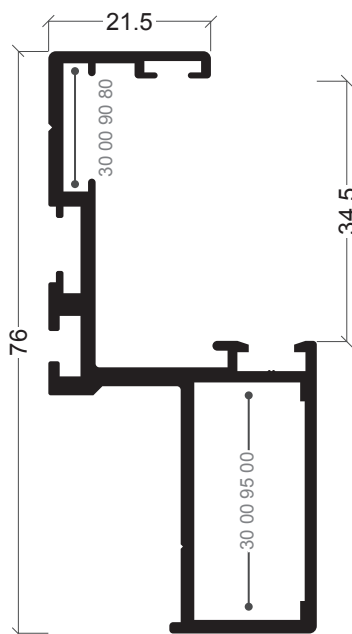

FL-85
Folha semi-estrutural

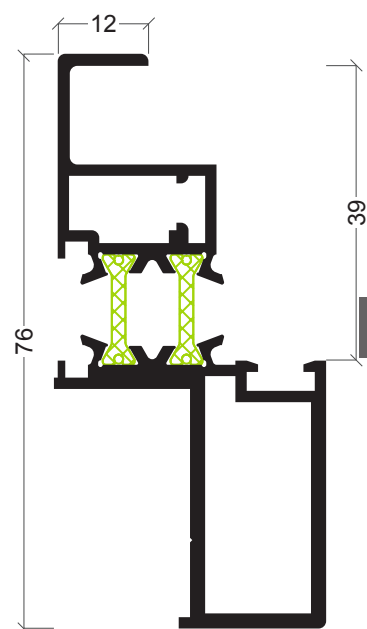

FL-28
Folha semi-estrutural

441

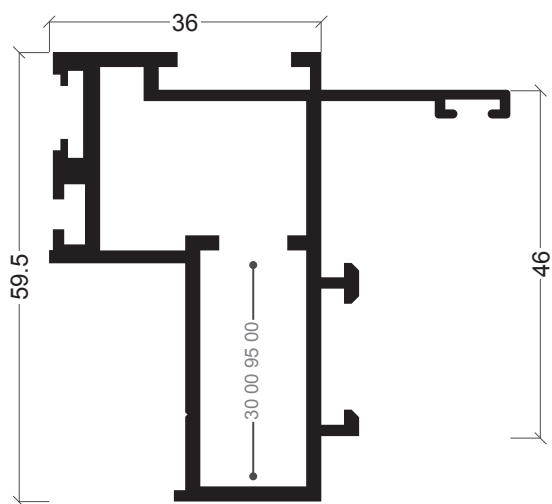

FL-26
Folha estrutural

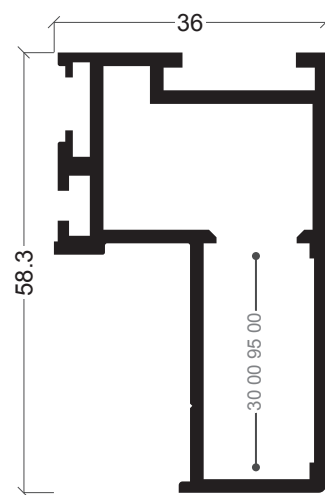

FL-71
Folha estrutural

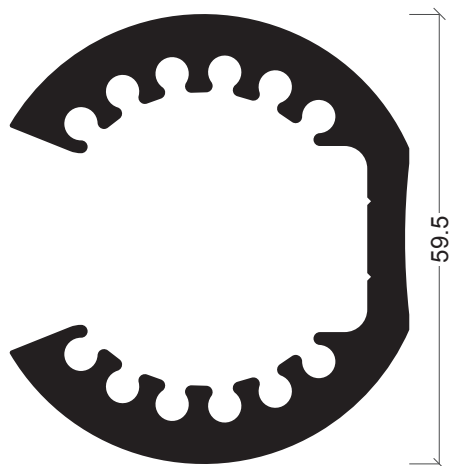

FL-69
Topo de fixação

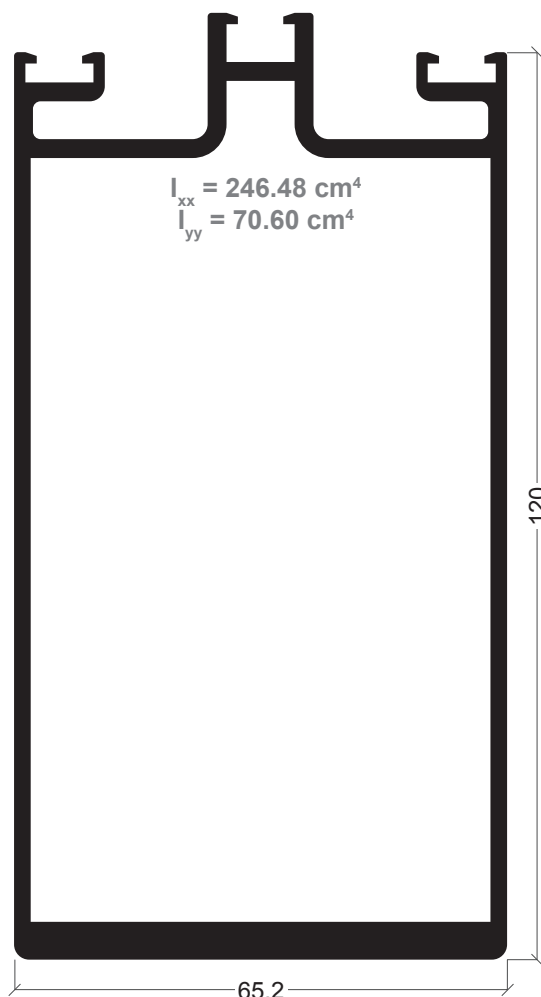

FL-74
Montante 120 mm

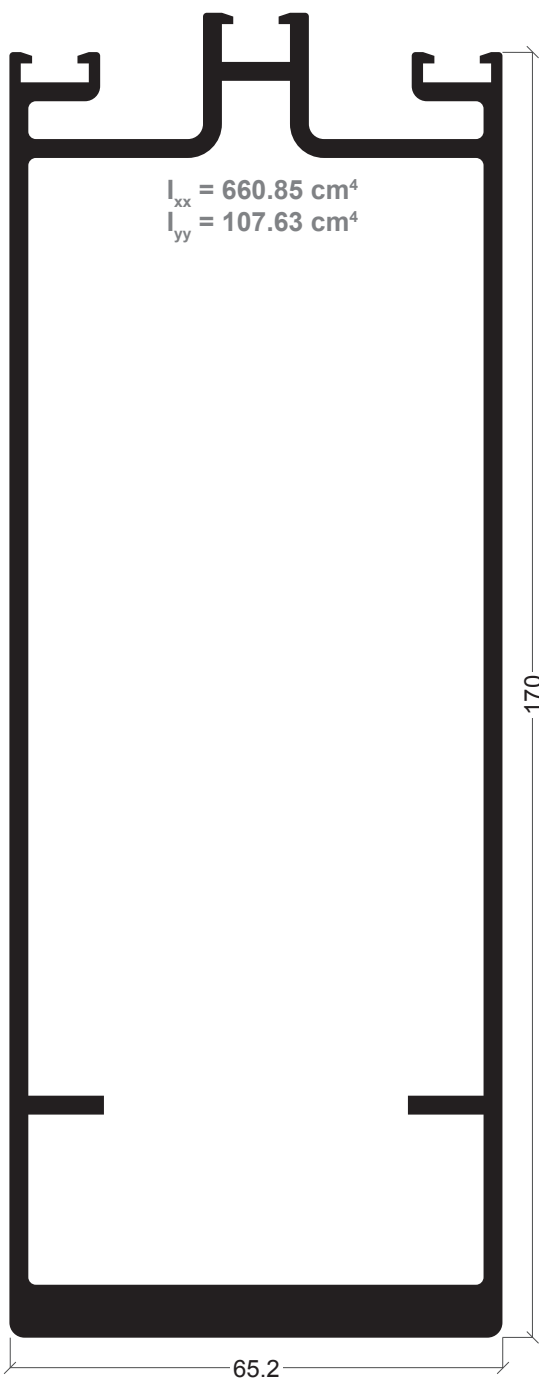

FL-75
Montante 170 mm

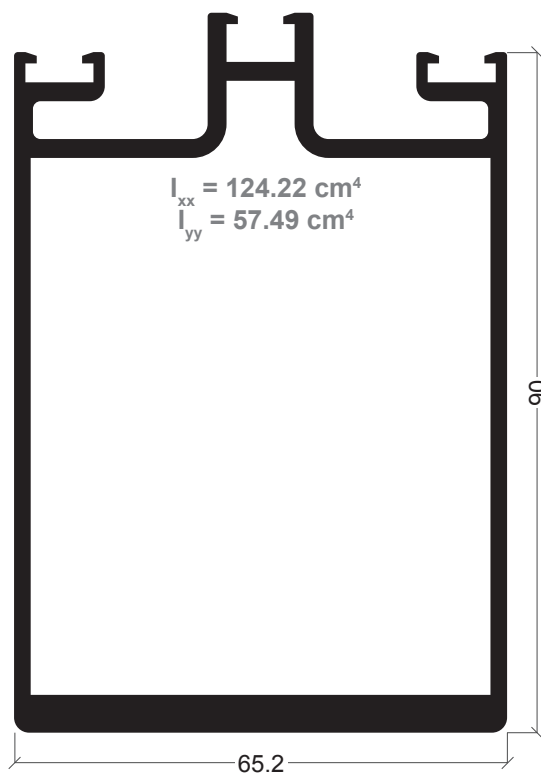

FL-81
Montante 90 mm

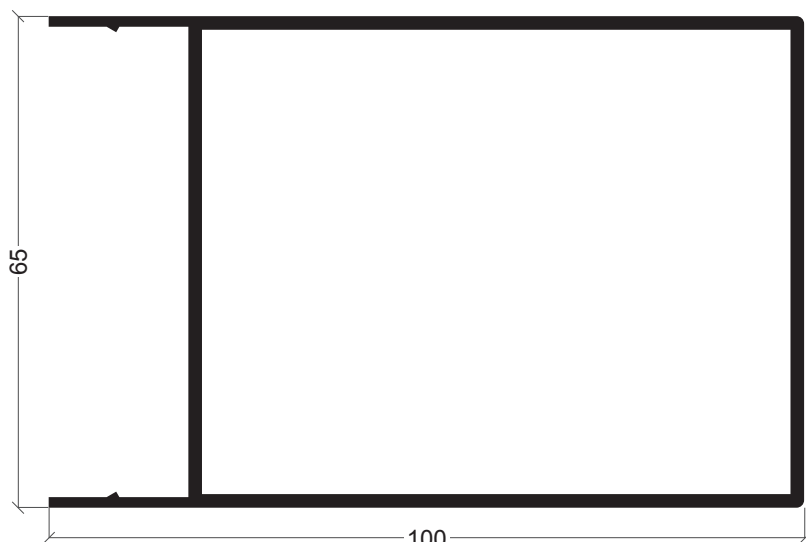

FL-29
Tampa vertical

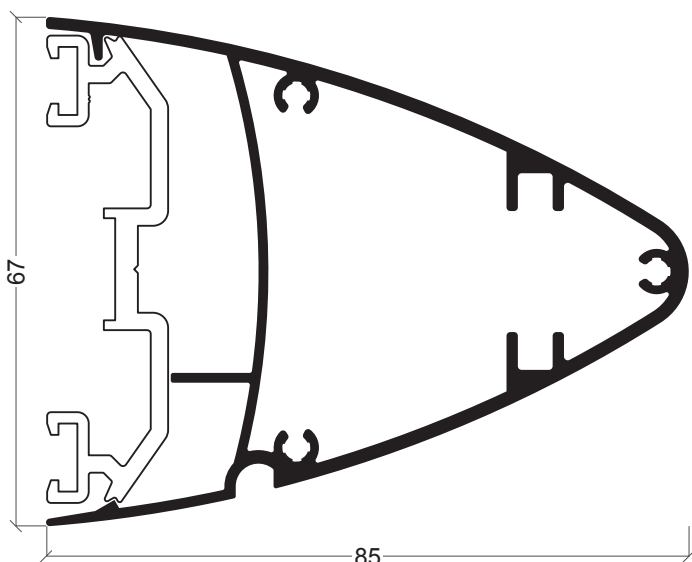

FL-72
Tampa elíptica 85

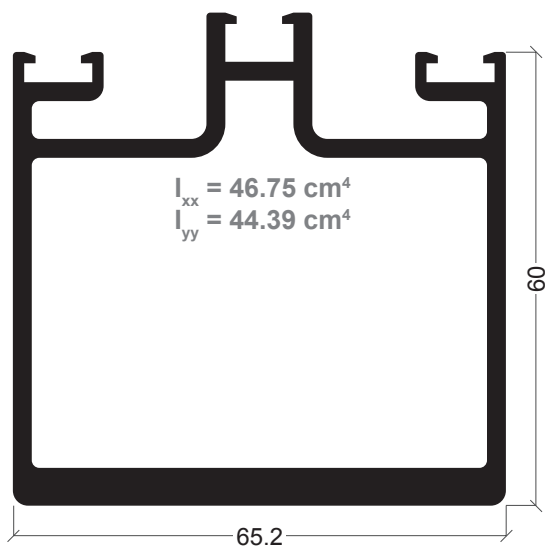

FL-73
Montante 60 mm

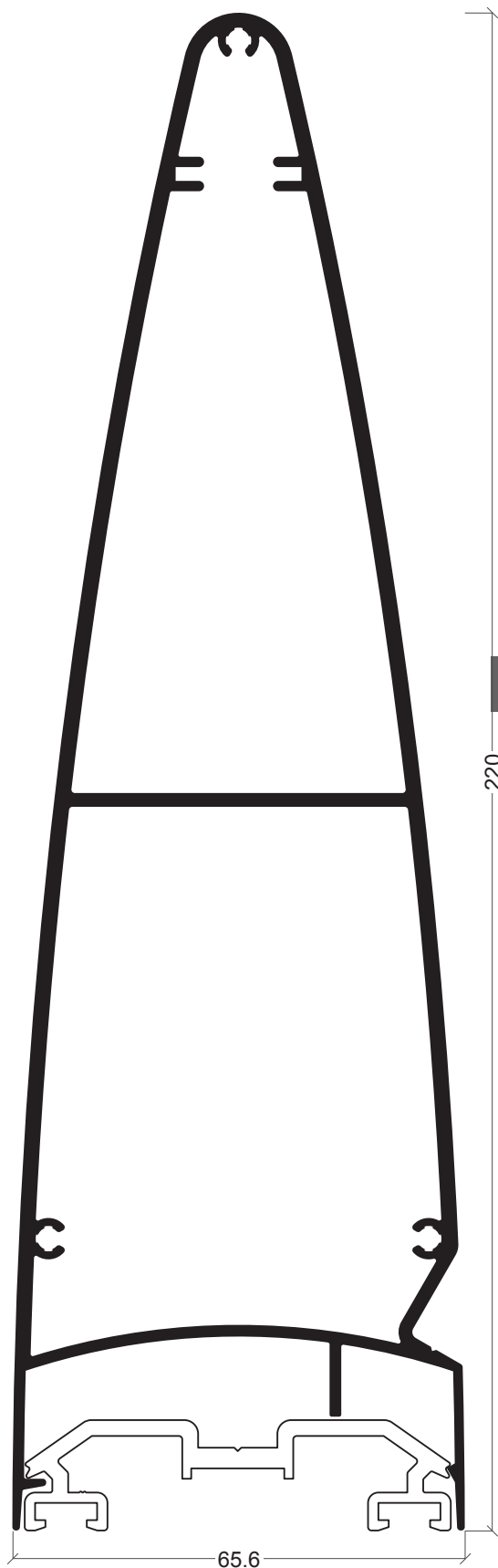

FL-82
Tampa elíptica 220 mm

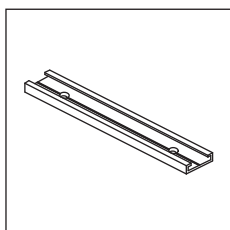

30 00 90 61

Guia fixação lateral

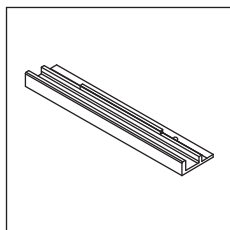

30 00 90 62

Fixação lateral montante

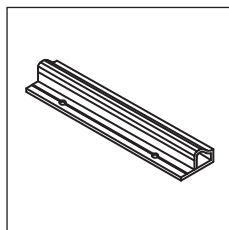

30 00 90 63

Fixação inferior

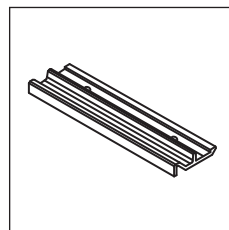

30 00 90 64

Fixação inferior travessa

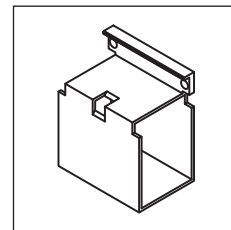

30 00 90 66

Topo travessas /
montante travessa

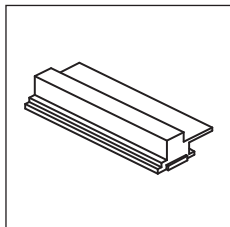

30 00 90 67

Fixação lateral folha

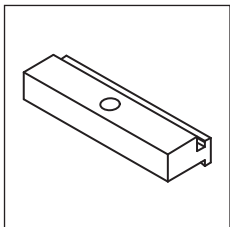

30 00 90 70

Fixação frontal

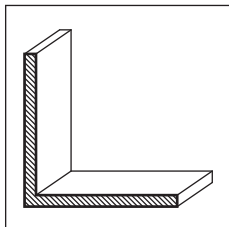

30 00 90 80

Canto de reforço

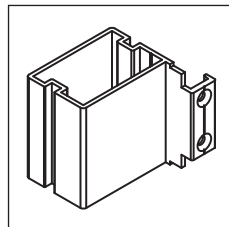

30 00 94 98

União fachada montante /
montante com parafusos

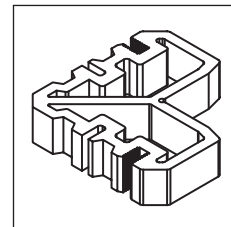

30 00 94 99

Esquadro de
canto 13.7 x 31.6 mm

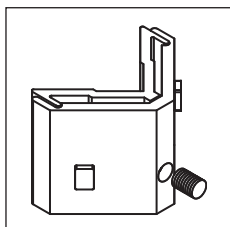

30 00 95 00

Esquadro móvel

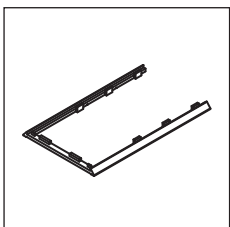

30 00 95 16

Junta de estanquidade
união montantes

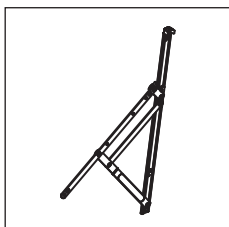

30 00 95 20

Jogo compasso fachada
(120 kg)



30 00 95 21

Jogo compasso fachada
(180 kg)

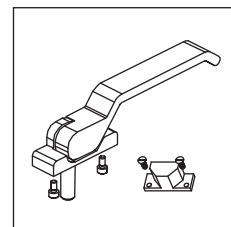

30 00 95 31/41

Kit cremone direito/
esquerdo preto

4 4 4

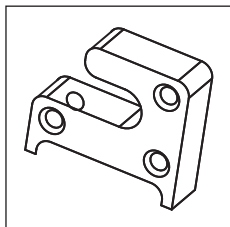

30 00 95 70

Peça fixação da folha

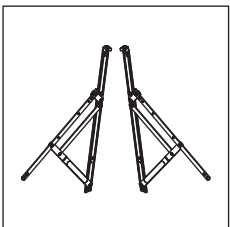

30 00 95 71

Jogo compasso fachada
(60 kg)

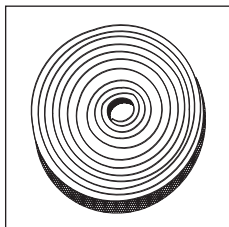

30 00 95 72

Junta isolante

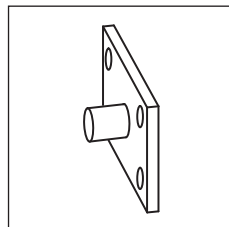

30 20 90 01

Fixação lateral folha

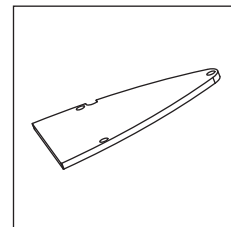

30 23 90 97

Tampa elíptica 85 mm

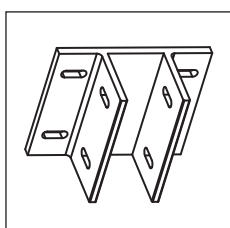

31 00 90 65

Fixador montante

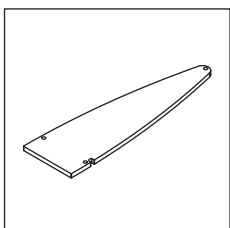





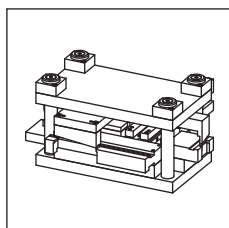









33 00 95 73

Tampa elíptica 220 mm



33 97 79 99

Cunho FL

Referência	Desenho	Descrição
30 00 95 01		Junta interior montante Junta central montante e travessa (muro invertido)
30 00 95 02		Junta interior montante (fxação lateral folhas fixas)
30 00 95 03		Junta central (montante e travessa) Fachada estrutural e semi-estrutural
30 00 95 05		Junta interior de travessa Junta de aro fixo (janela oculta em muro invertido)
30 00 95 06		Junta central montante e travessa
30 00 95 07		Junta central montante e travessa
30 00 95 08		Junta central montante e travessa (segundo vidro)
30 00 95 09		Junta de estanquidade montante FL-11
30 00 95 10		Junta de estanquidade travessa FL-12
30 00 95 13		Junta folha de rotura térmica
30 00 95 76		Junta central montante e travessa
30 20 26 03		Junta exterior Junta interior Junta de vedação
30 90 20 80		Junta exterior para Sistema Ergolux
30 99 95 11		Junta de folha encaixe exterior Junta montante de remate Junta de folha e aro (janela oculta em muro invertido)

Pormenor de fixação do montante

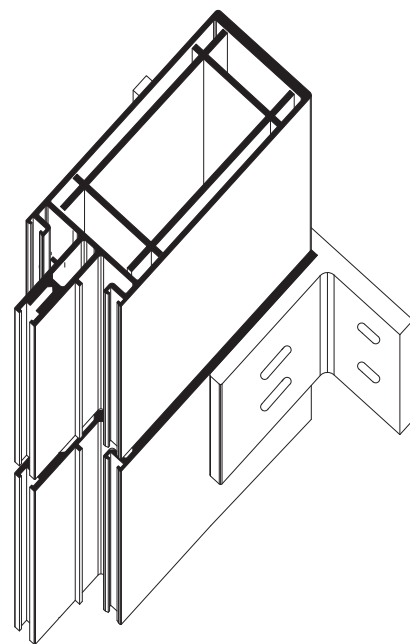
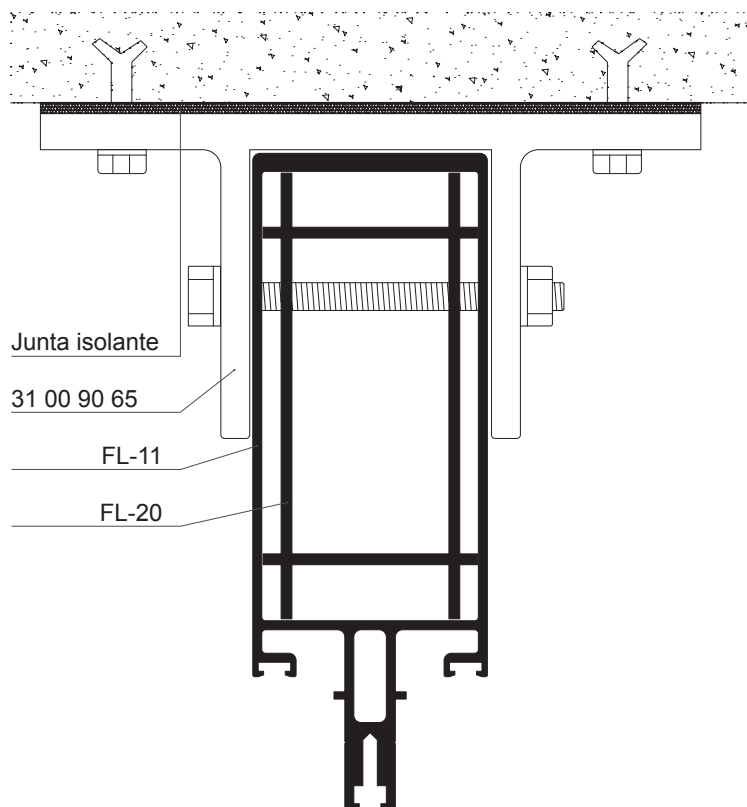

446

União montante travessa

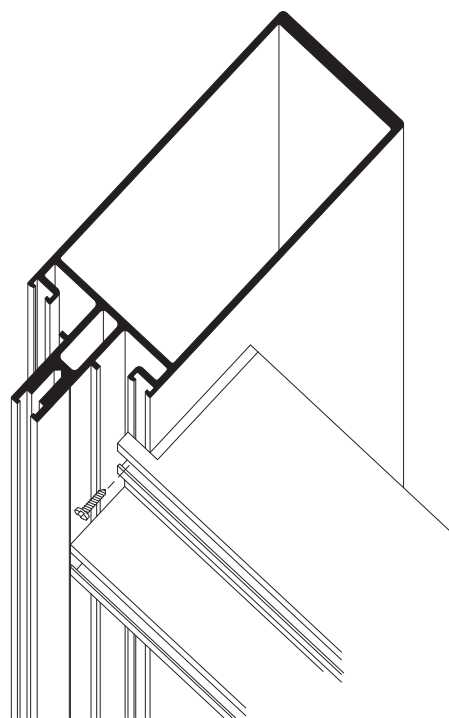
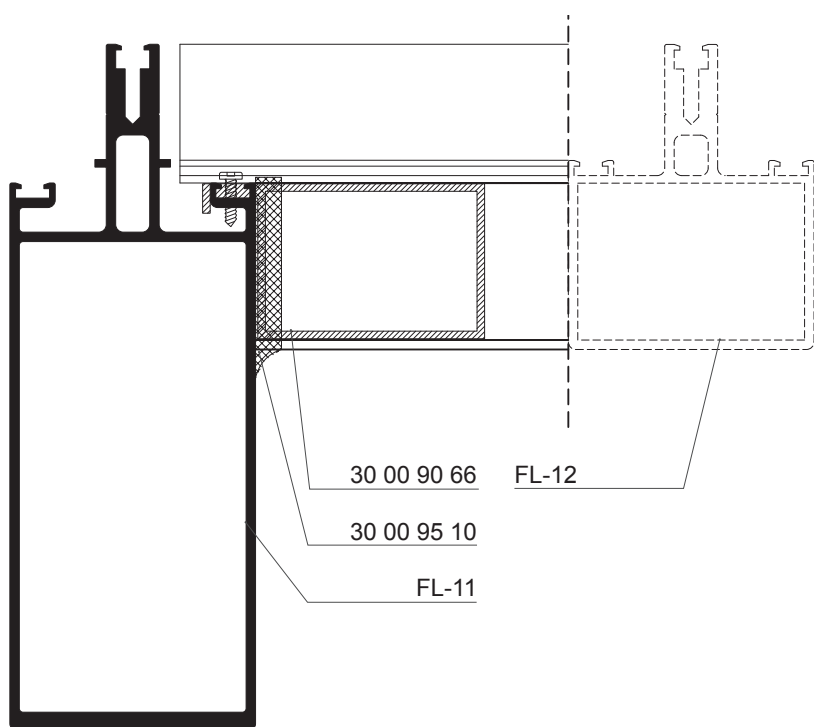

Folha de corte da travessa

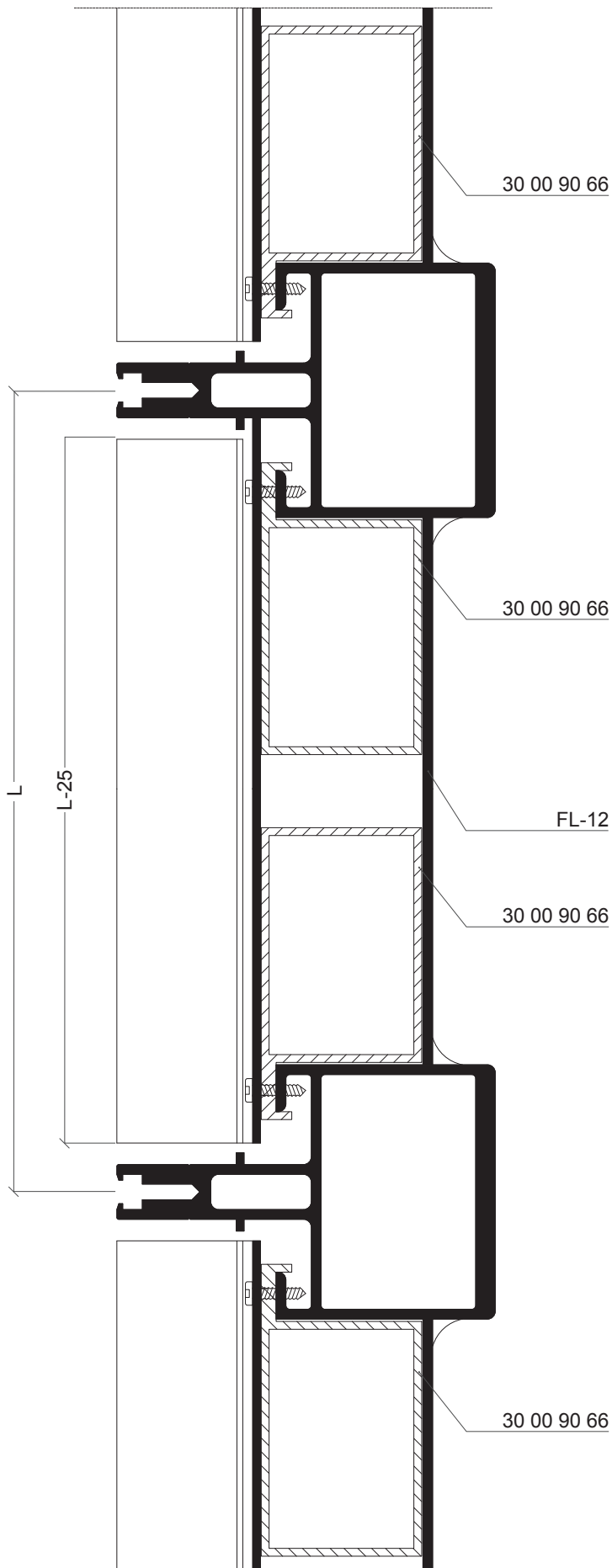

Medidas de corte fachada estrutural e semi-estrutural

Pormenor horizontal e vertical sistema de fixação frontal

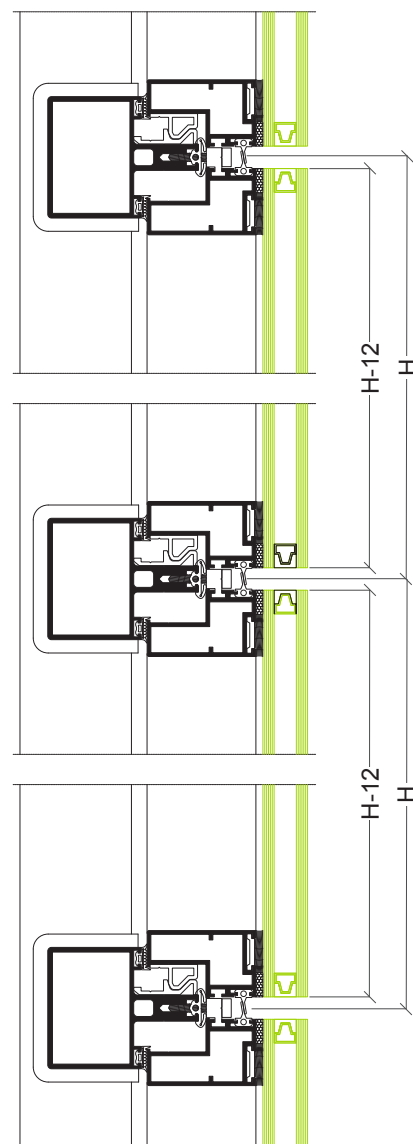
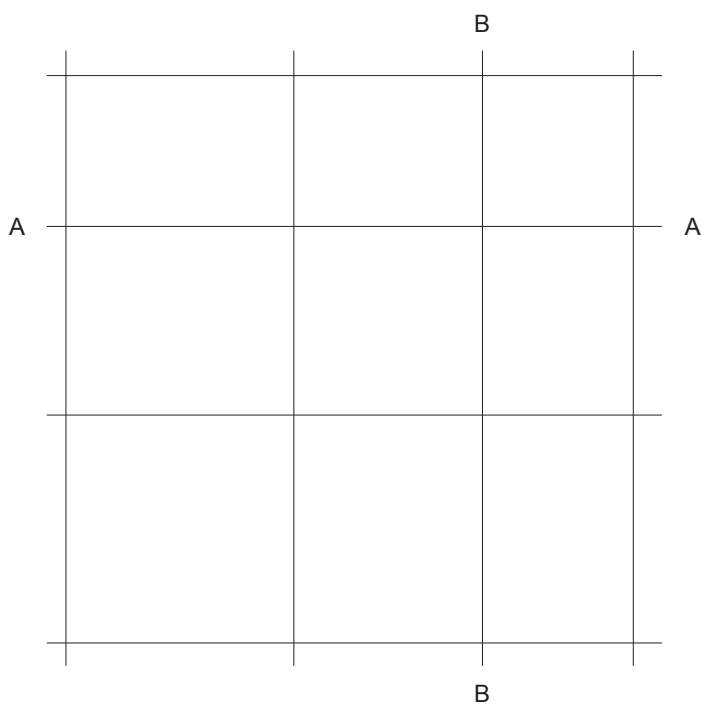

Seção A-A

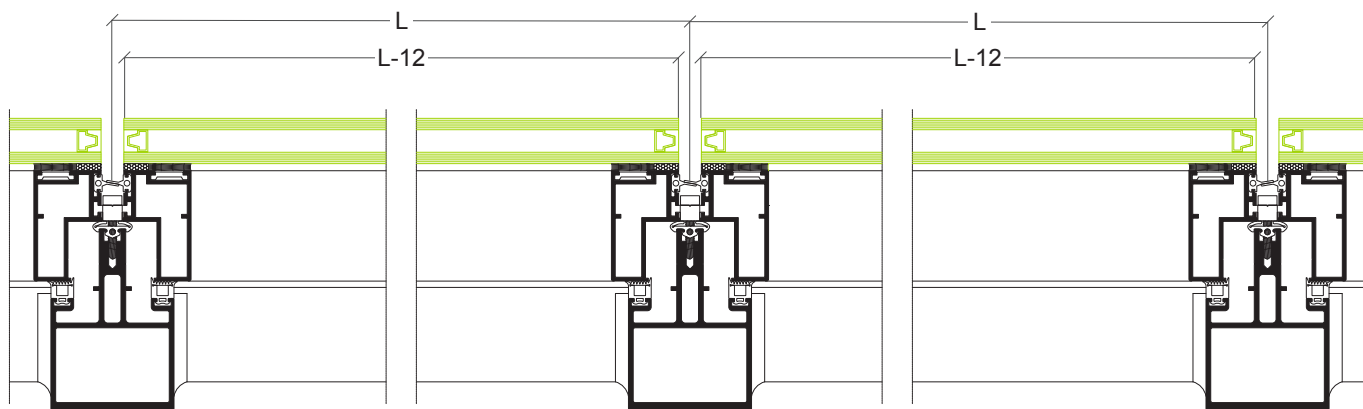

Seção B-B

Montagem da folha fixa

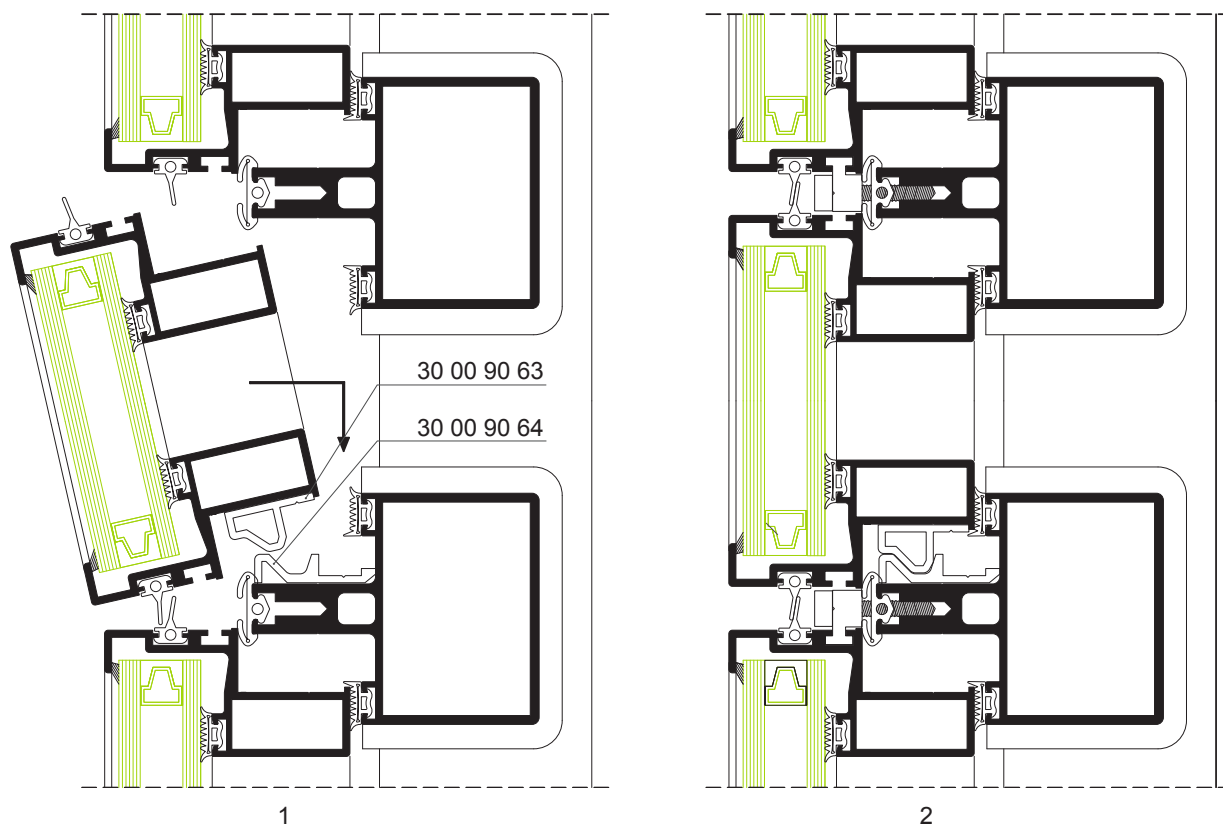

Montagem da folha fixa

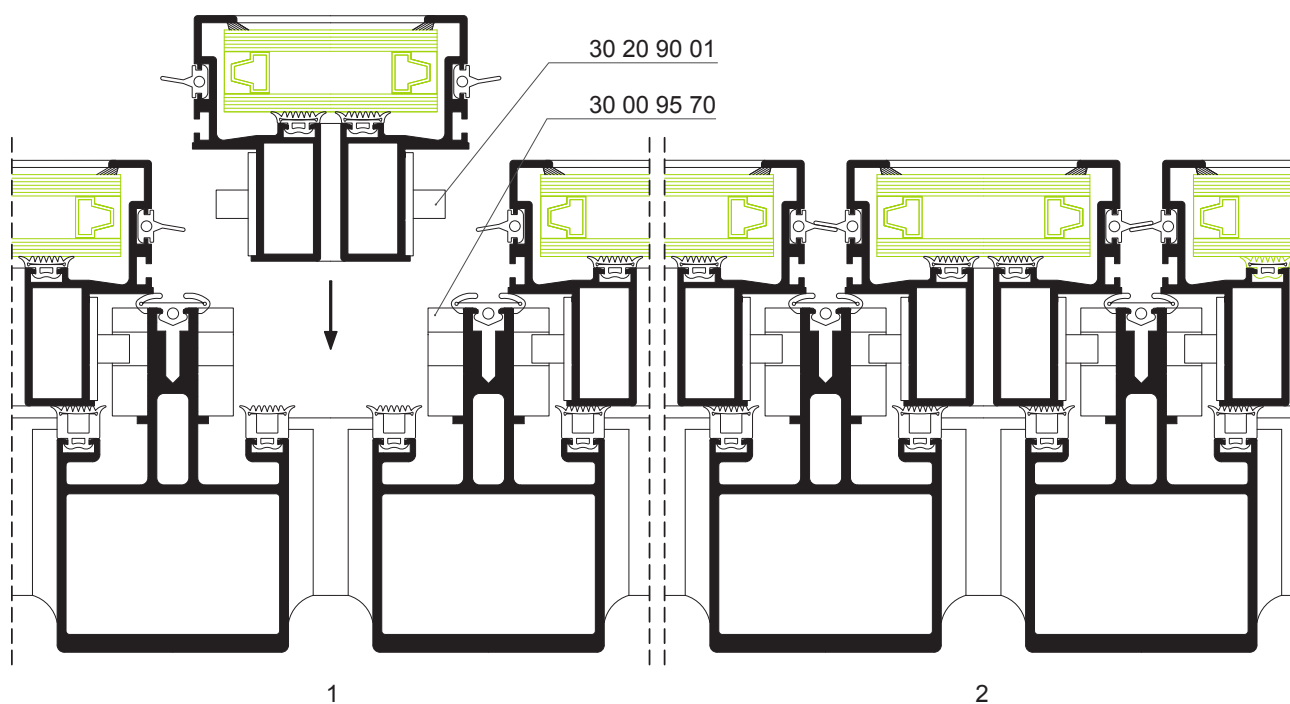

Fachada estrutural e semi-estrutural Sistema de fixação de folhas fixas

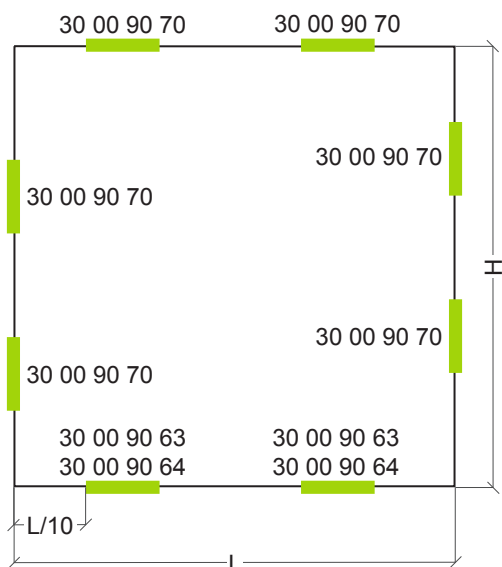

Folha fixa Sistema de fixação frontal

Peça de fixação	L	H	Nº de peças	
			L	H
30 00 90 70	até 1000 mm	até 1000 mm	2	2
	cada 500 mm	cada 500 mm	1	1

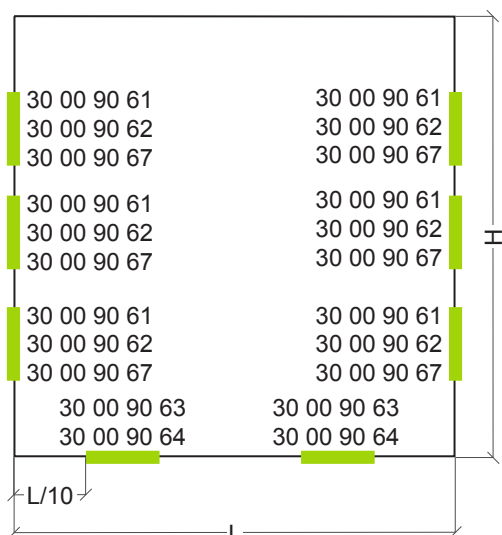

Folha fixa Sistema de fixação interior lateral

Peça de fixação	L	H	Nº de peças	
			L	H
30 00 90 61 30 00 90 62 30 00 90 67	até 1000 mm	até 1000 mm	-	3
	cada 500 mm	cada 500 mm	-	1
30 00 90 63 30 00 90 64	até 1000 mm	até 1000 mm	2	-
	cada 500 mm	cada 500 mm	1	-

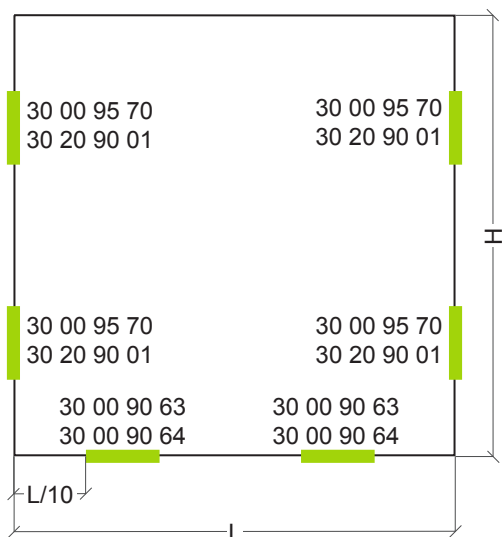

Folha fixa Sistema de fixação exterior lateral

Peça de fixação	L	H	Nº de peças	
			L	H
30 00 95 70 30 20 90 01	-	-	-	2
	-	-	-	-
30 00 90 63 30 00 90 64	até 1000 mm	até 1000 mm	2	-
	cada 500 mm	cada 500 mm	1	-

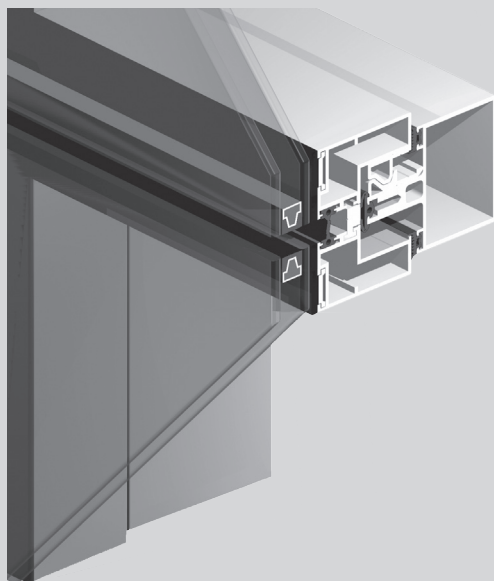
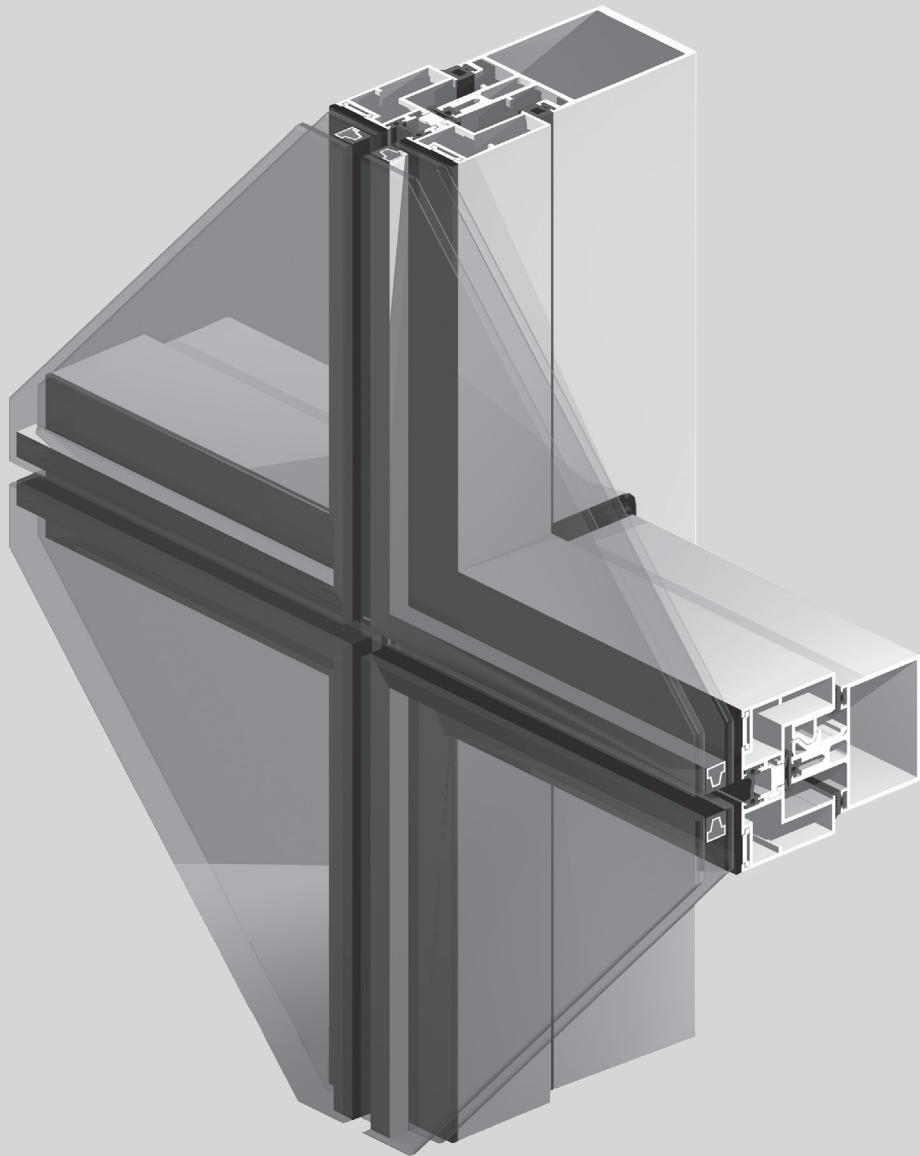

Fachada Estrutural

Fachada Estrutural

Características

Neste sistema a colocação de vidros realiza-se mediante bastidores nos quais se coloca um perfil especialmente anodizado para permitir a colagem da silicone estrutural. Deste modo, o vidro oculta totalmente os perfis, adquirindo este tipo de fachada, uma vista exterior só de vidro, proporcionando assim um efeito tipo VEC - Vidro Exterior Colado.

A secção dos montantes e travessas é de 65 mm, visível apenas do interior.

Ambos os perfis apresentam canais de drenagem e ventilação que garantem, juntamente com o sistema de juntas de EPDM, uma estanquidade e permeabilidade máximas. Opcionalmente, dispõe-se de um perfil especial de segurança que evita o esforço cortante do vidro. Possibilidade de perfis com rotura térmica.

Acabamentos

A barra que recebe o vidro tem que possuir uma anodização especial do perfil perimetral ($>20 \mu\text{m}$), necessária para garantir uma perfeita colagem do vidro com silicone estrutural. A restante perfilaria permite todas as possibilidades de acabamento: lacado, lacado decorativo (madeira) ou anodizado.

Possibilidades de abertura

Abertura projectante realizada por intermédio de compassos em aço inox com uma resistência até 180 kg, Tanto as folhas fixas como as projectantes são fabricadas com o mesmo perfil perimetral, tornando assim imperceptível a sua distinção pelo exterior.

Pormenor horizontal e vertical

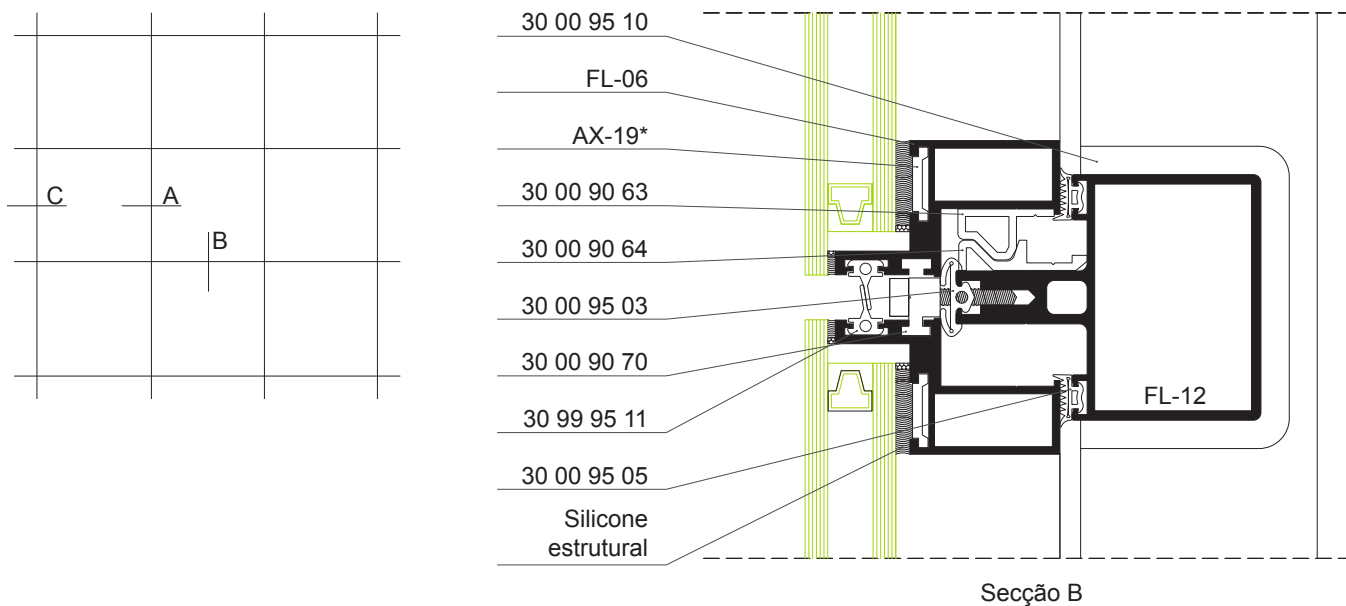

* Perfil anodizado com classe 20, colagem especial com silicone estrutural

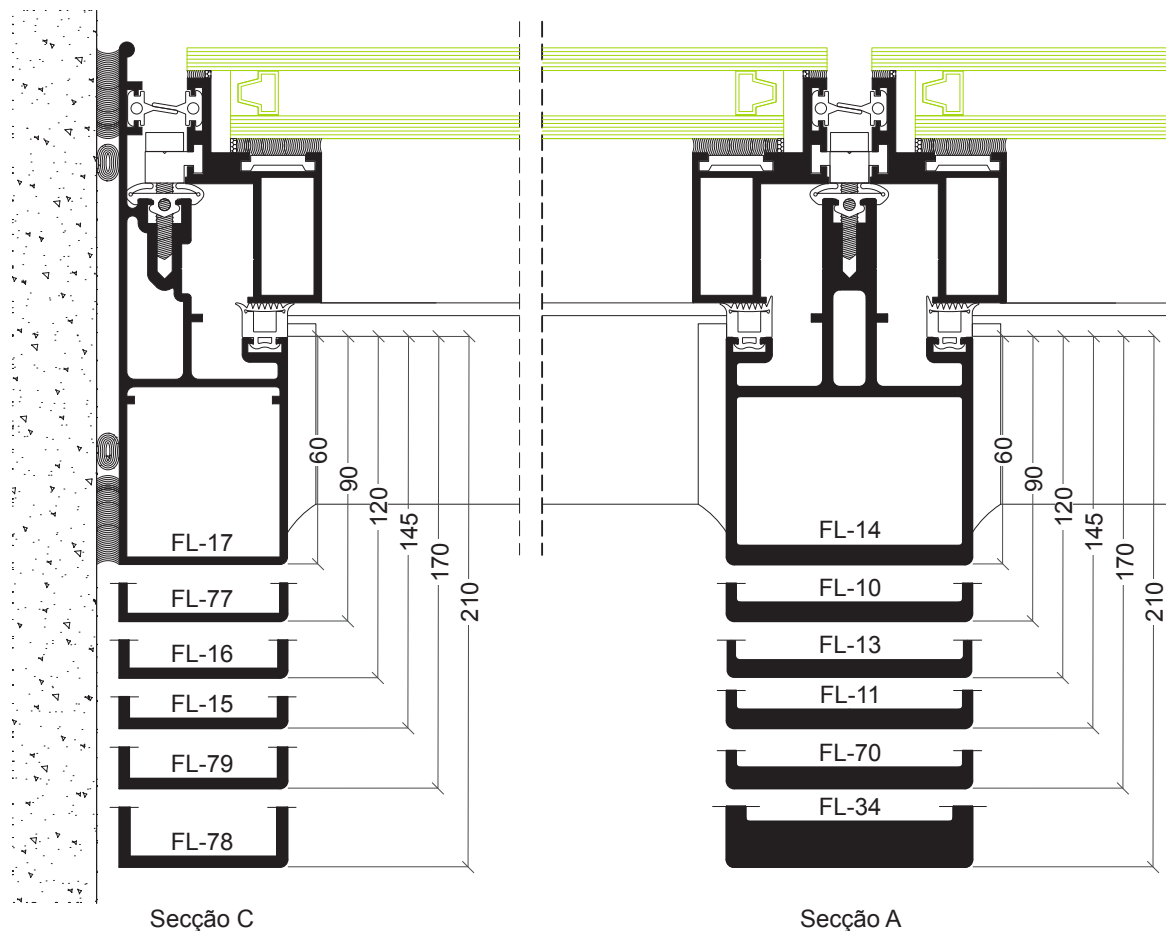

Pormenor canto 90°

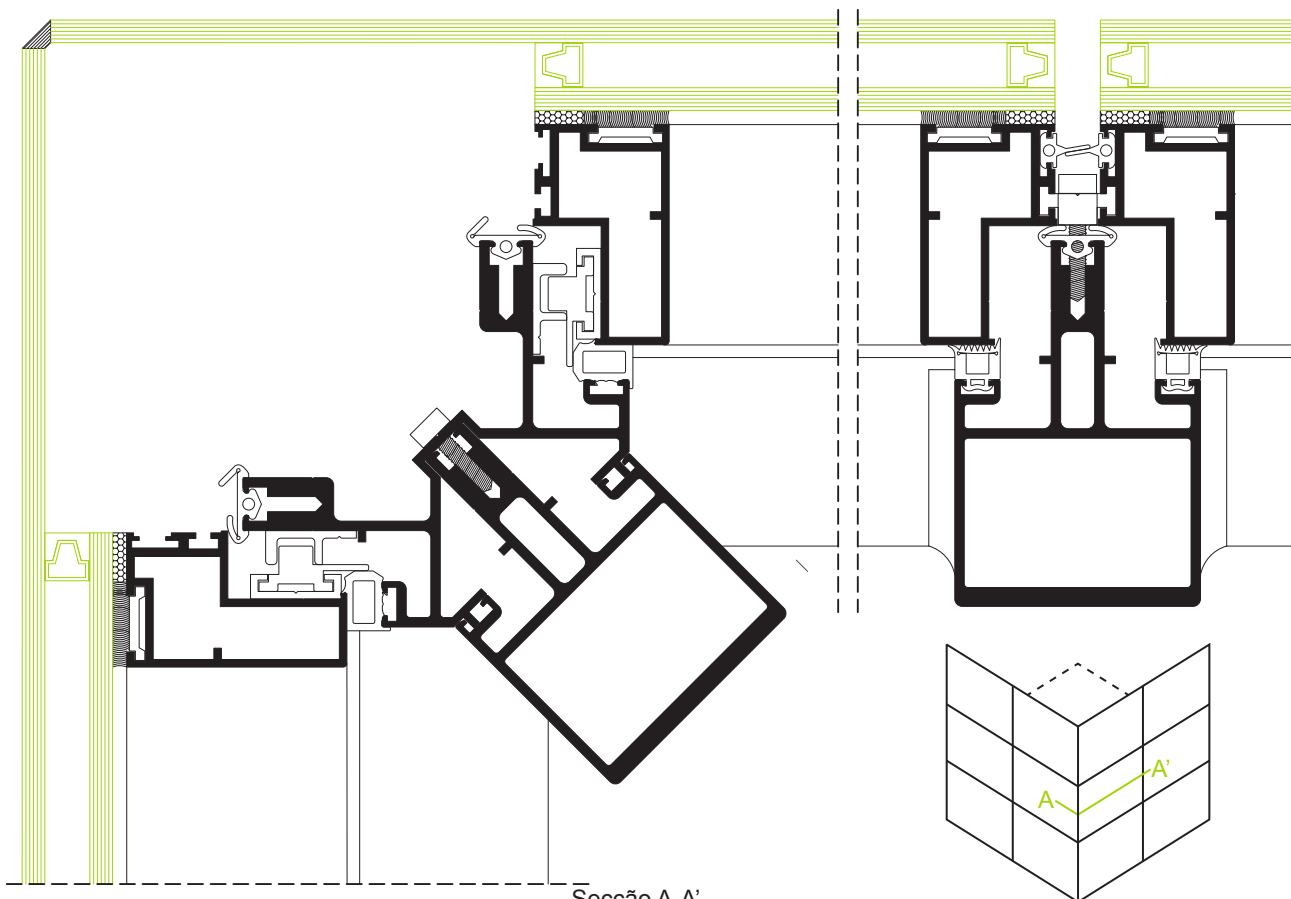

Secção A-A'

Pormenor canto 90°

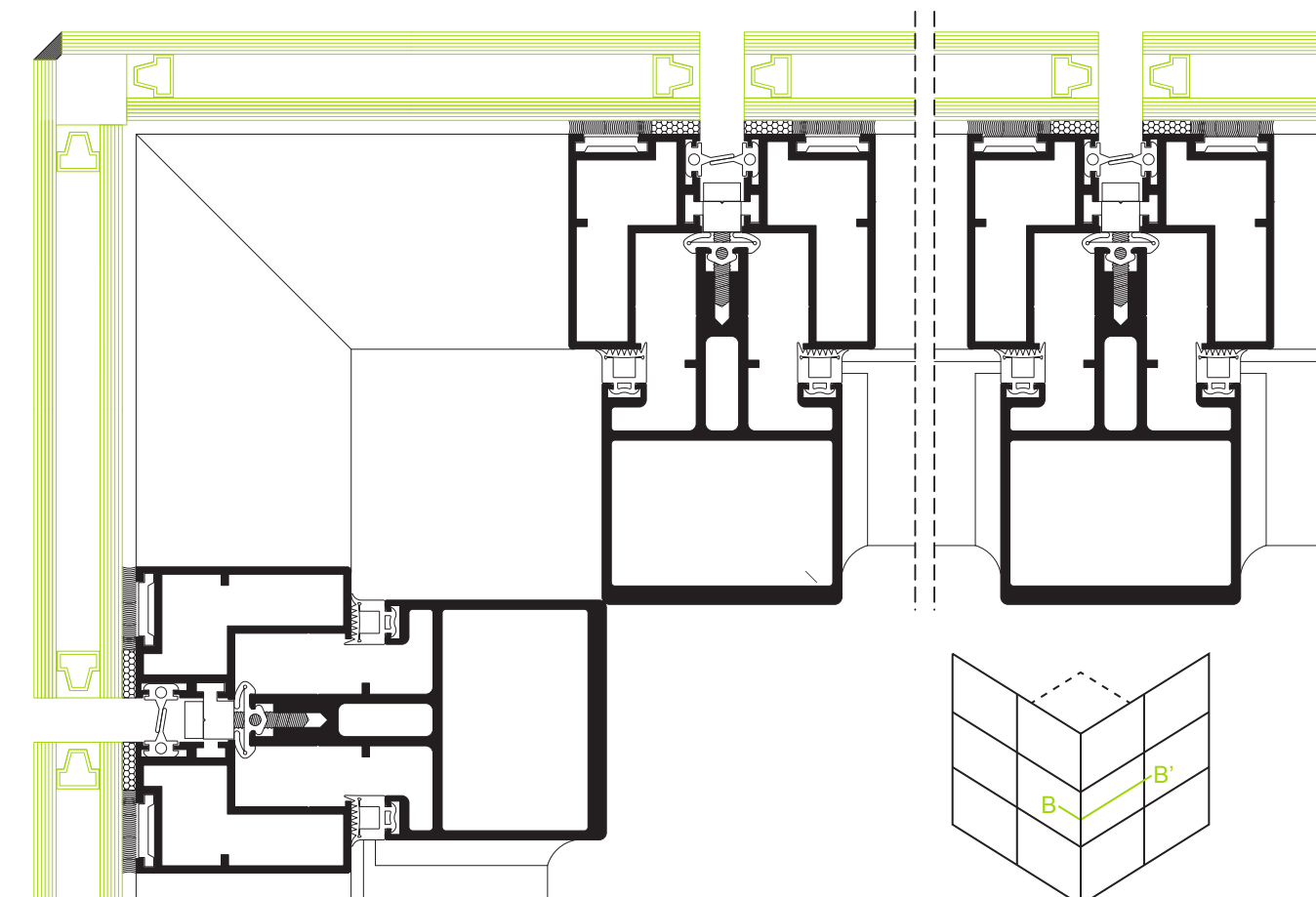

Secção B-B'

Pormenor canto 90°

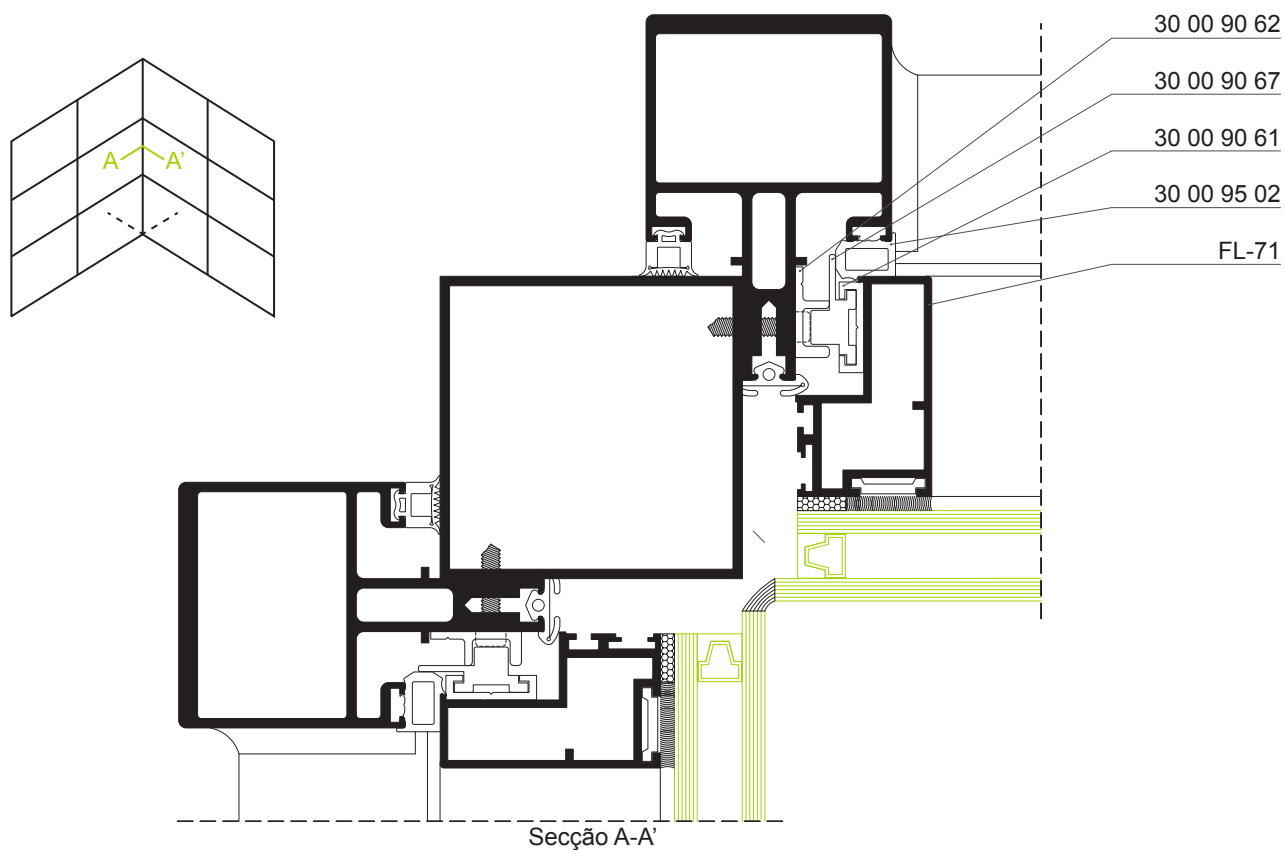

Pormenor canto variável de 15° a 30°

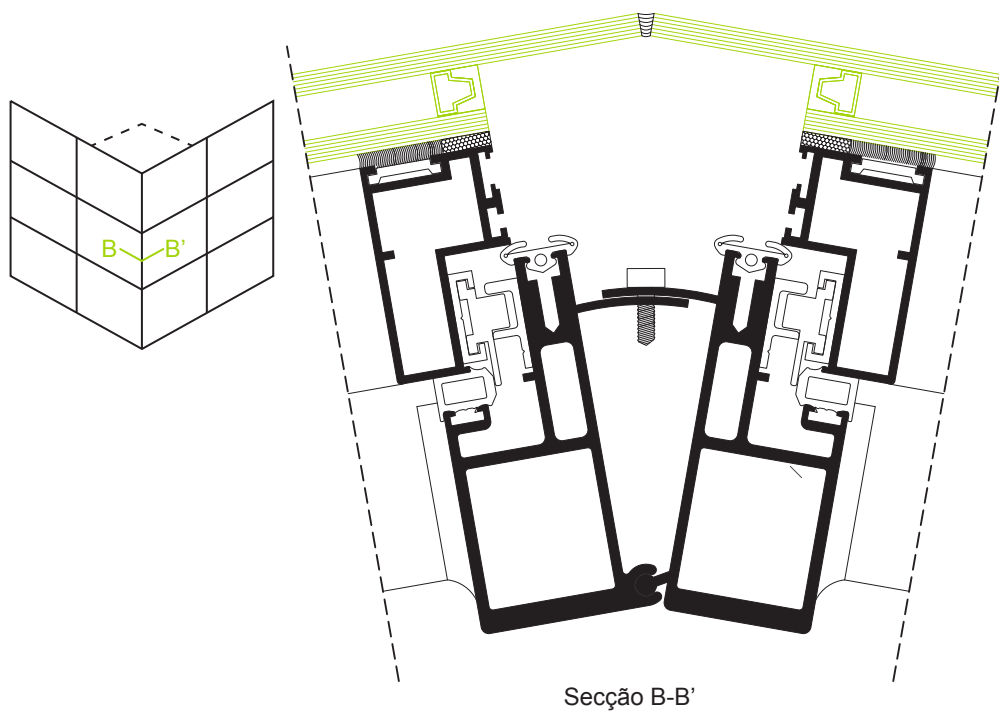

Pormenor horizontal e vertical

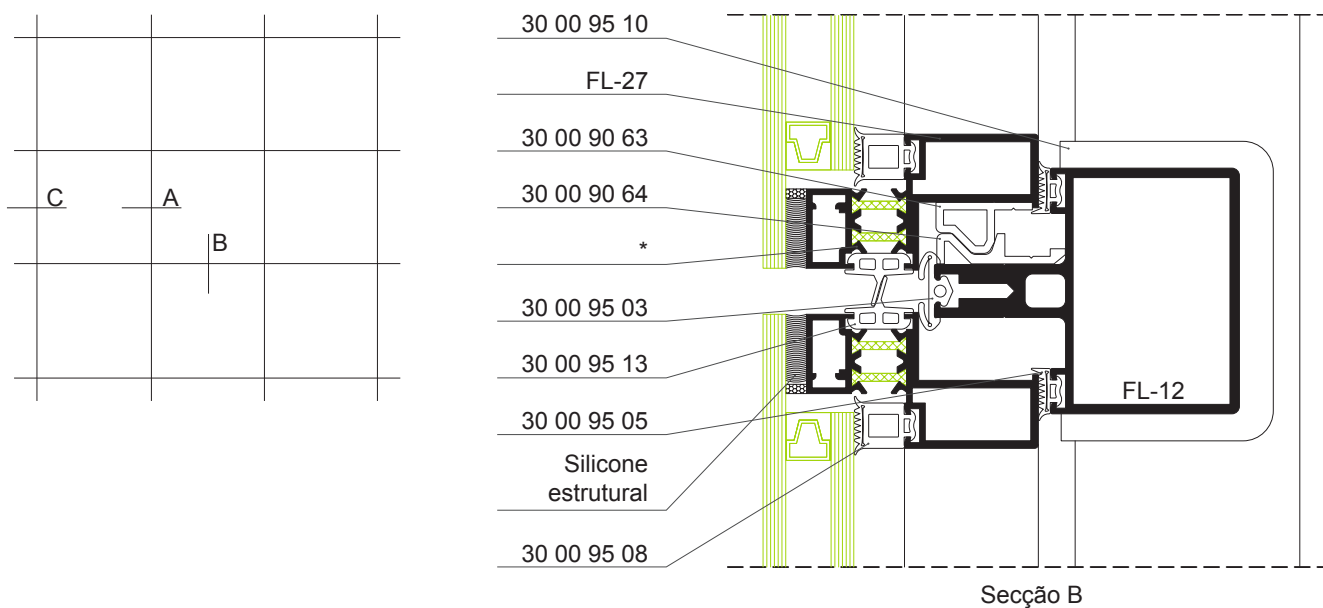

* Perfil anodizado com classe 20, colagem especial com silicone estrutural

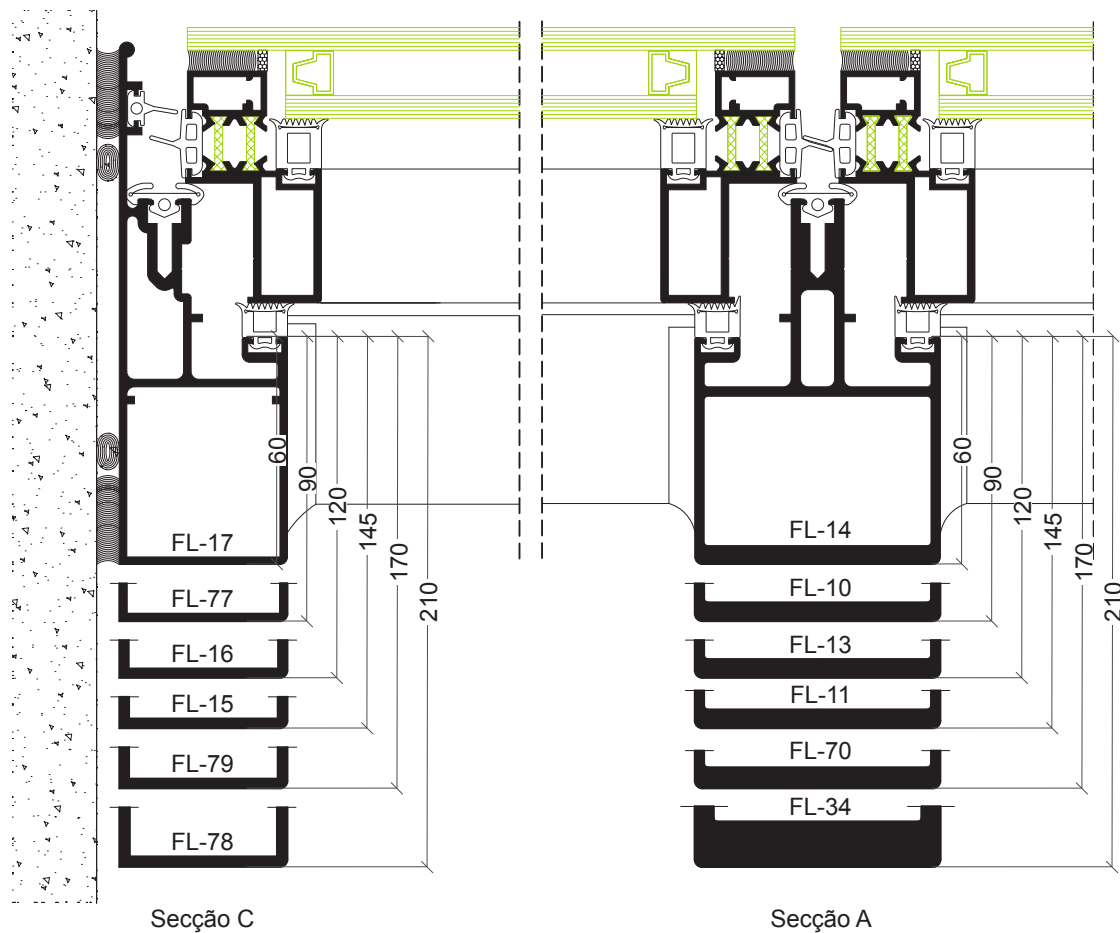

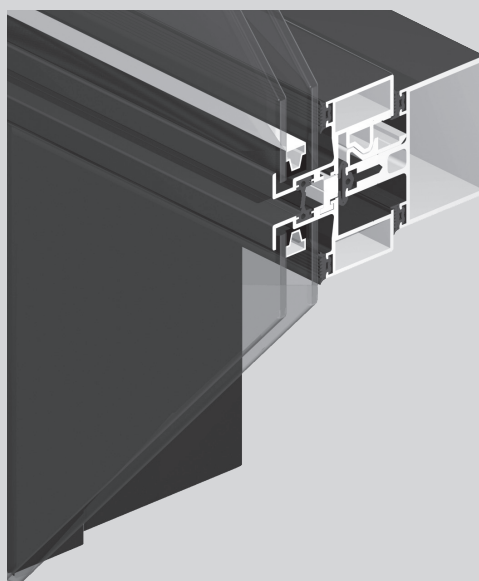
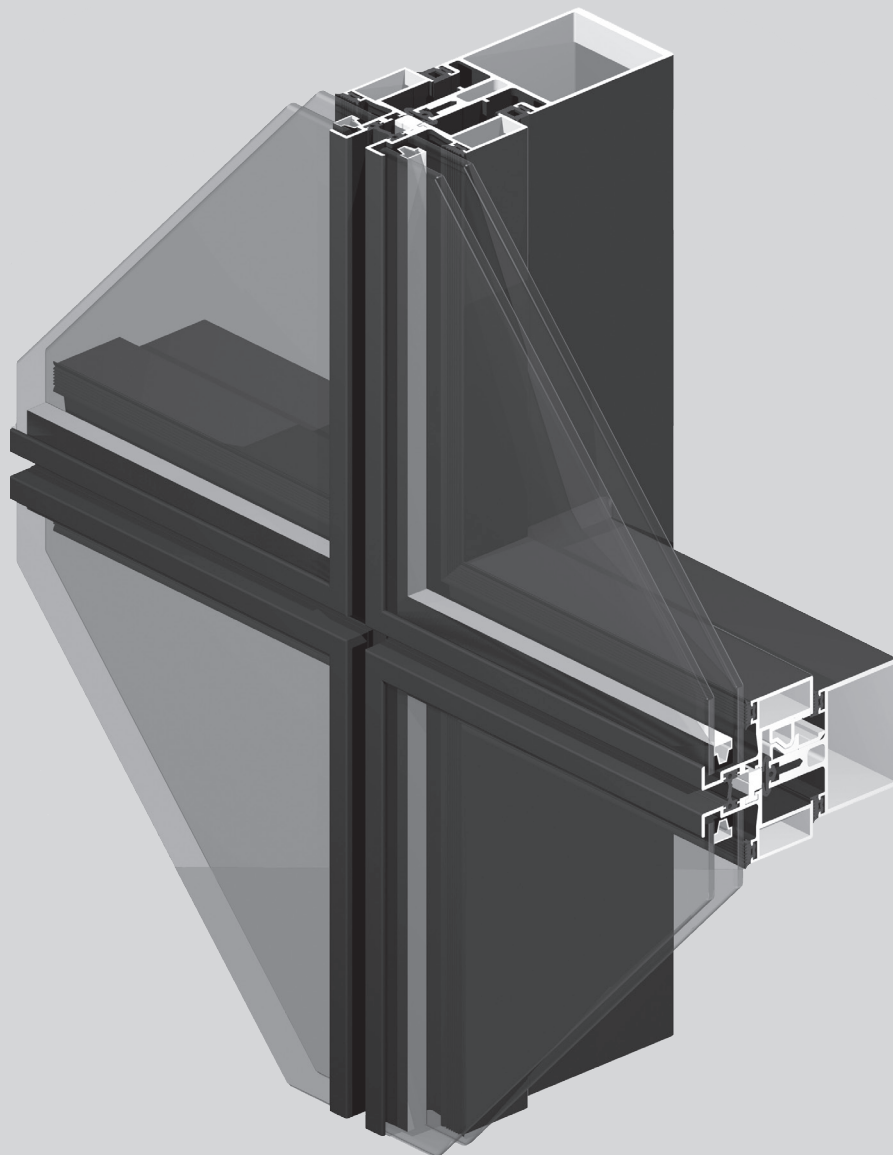

**Fachada
Semi
Estrutural**

Fachada Semi-Estrutural

Características

Sistema de fachada em que se utilizam perfis para o fabrico das folhas, com um aba que fixa o vidro, evitando o uso de silicone estrutural.

A secção da vista exterior deste sistema é de 12 mm ou 21 mm.

A secção dos montantes e travessas é de 65 mm, visíveis apenas do interior. Ambos os perfis apresentam canais de drenagem e ventilação que garantem juntamente com o sistema de juntas em EPDM, uma máxima estanquidade e permeabilidade. Possibilidade de perfis com rotura térmica.

Possibilidades de abertura

Abertura projectante realizada por intermédio de compassos em aço inox com uma resistência até 180 kg, Tanto as folhas fixas como as projectantes são fabricadas com o mesmo perfil perimetral, tornando assim imperceptível a sua distinção pelo exterior.

Pormenor horizontal e vertical

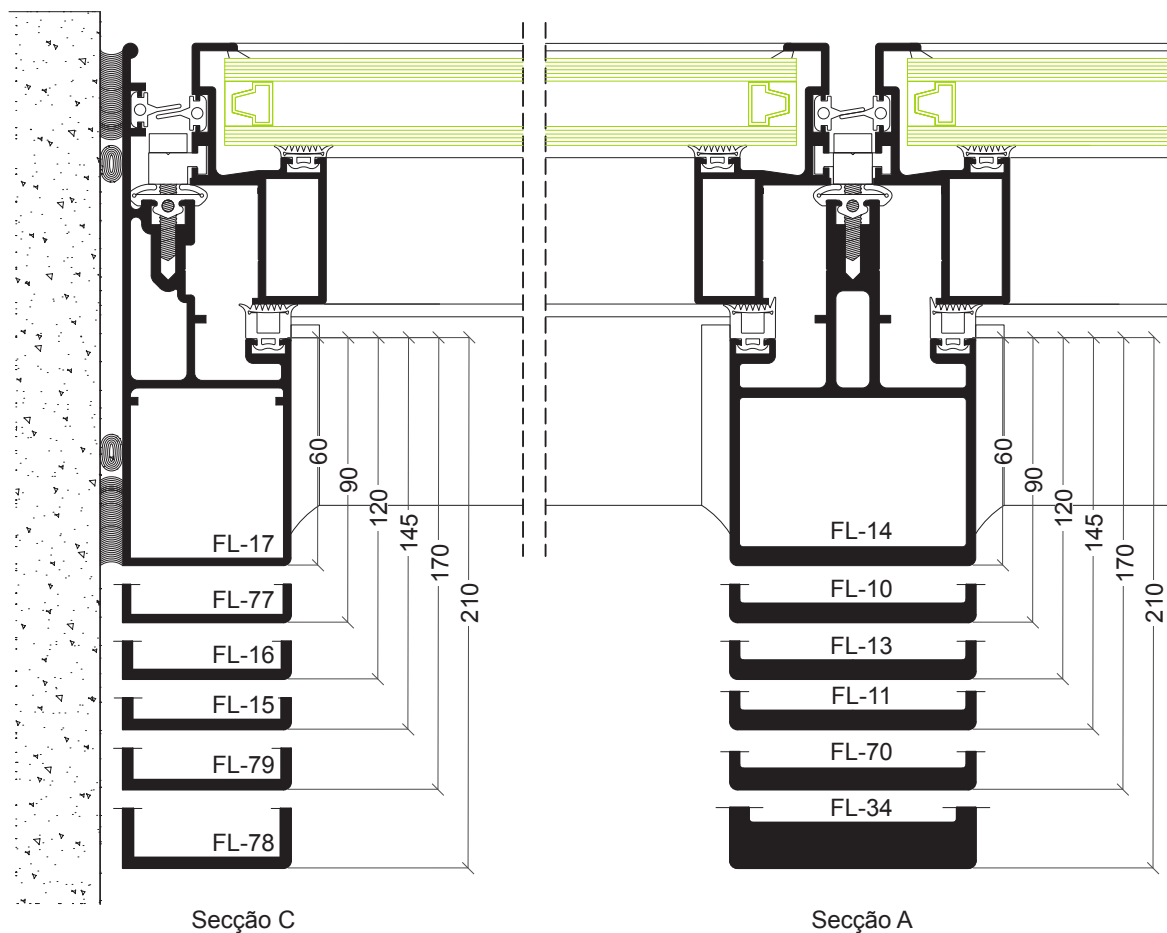
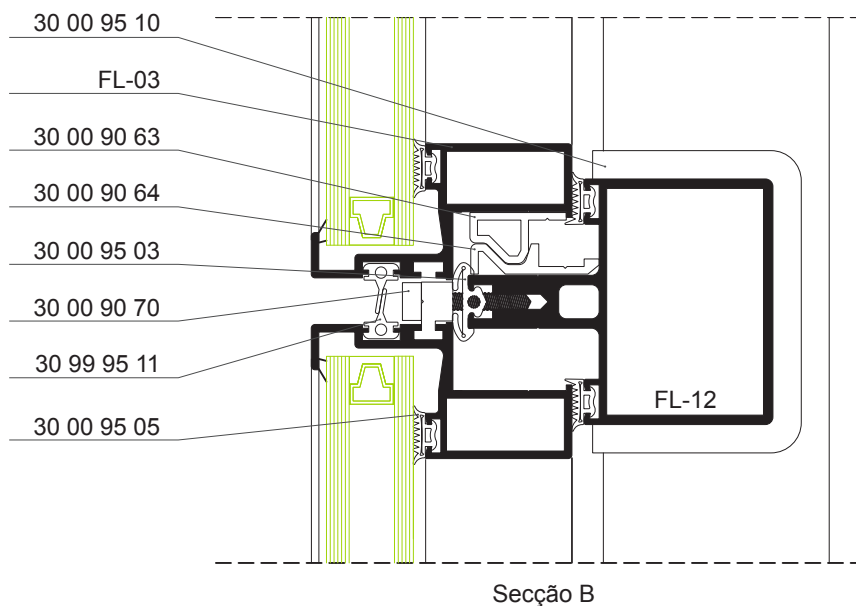
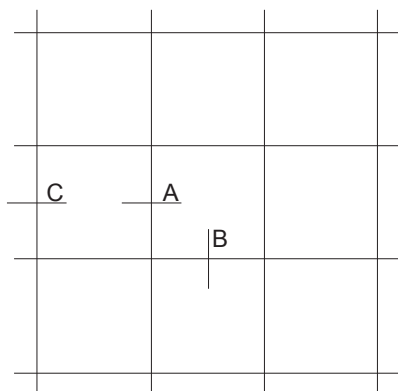

Pormenor canto 90°

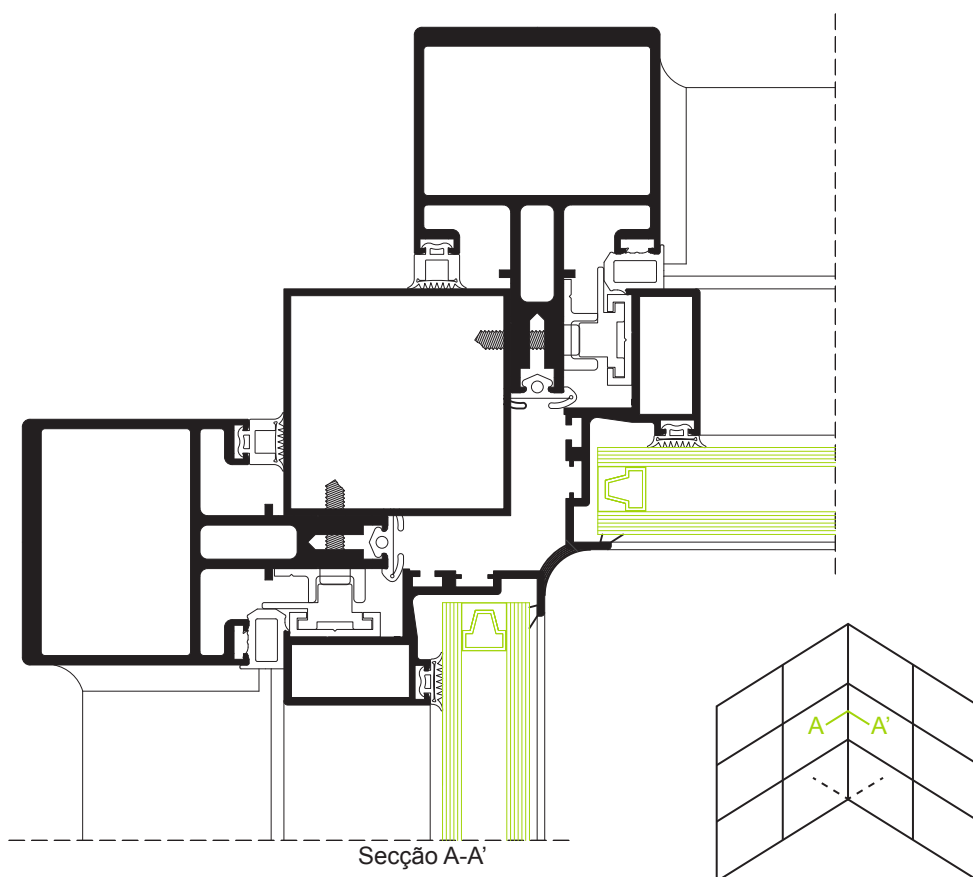

460

Pormenor canto 90°

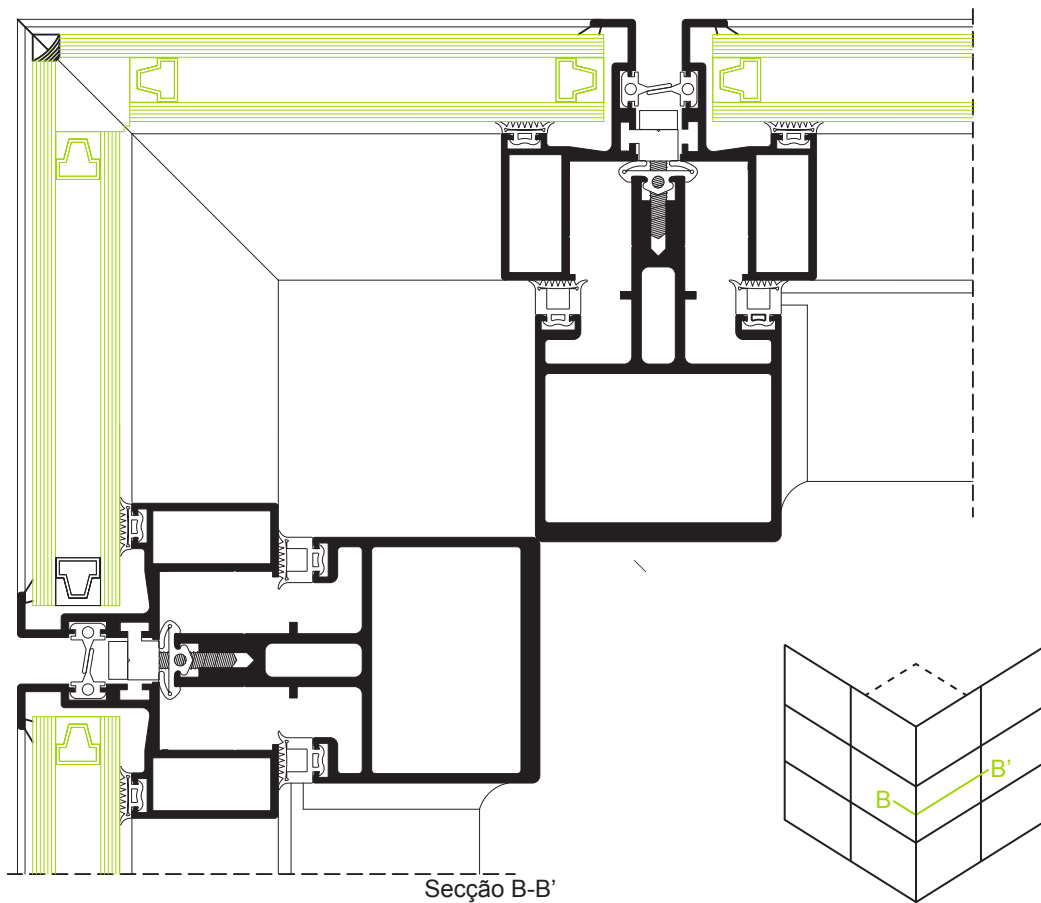

Pormenor canto 90°

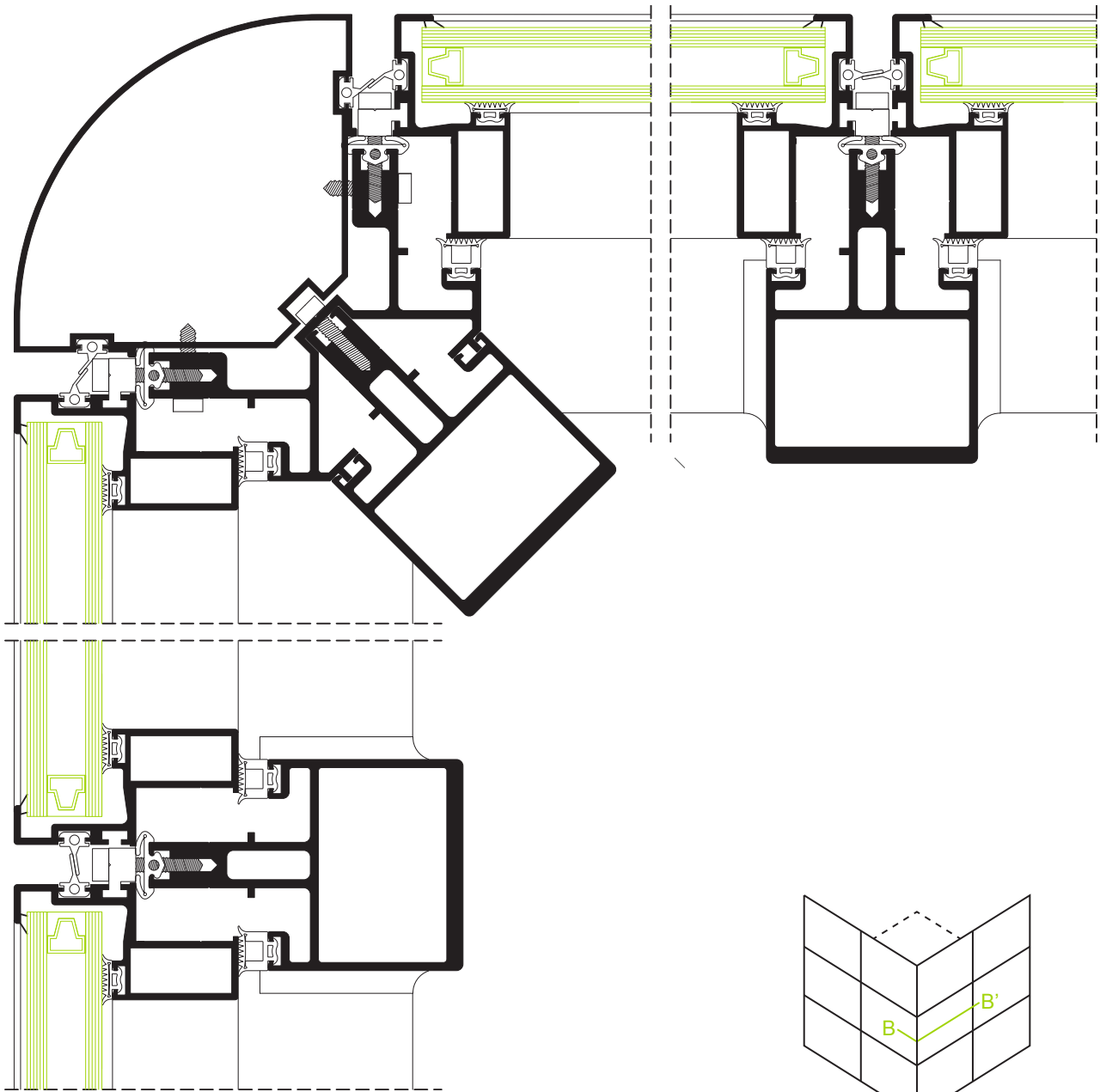

Secção A-A'

Pormenor horizontal e vertical

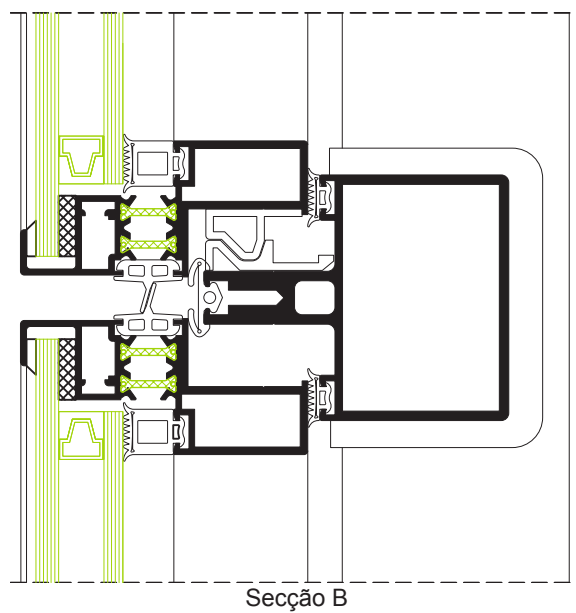
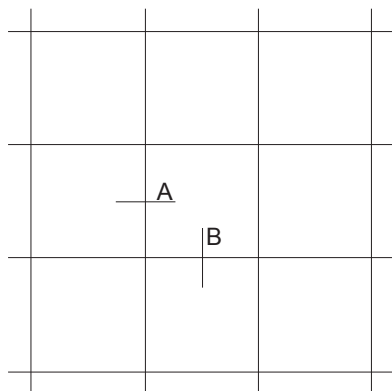

462

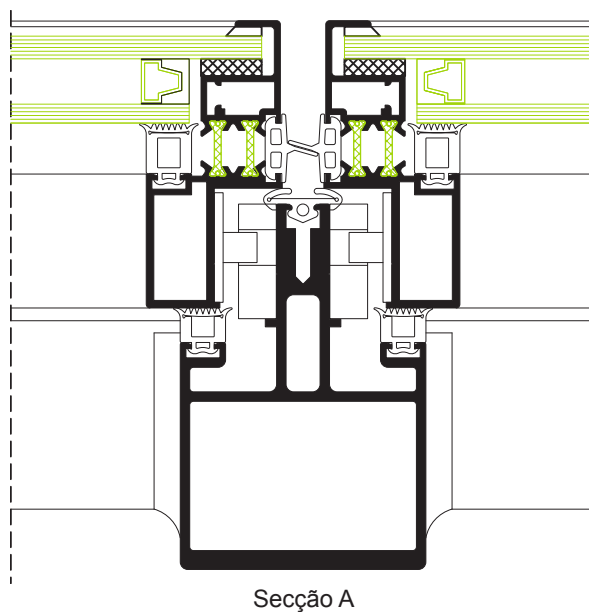

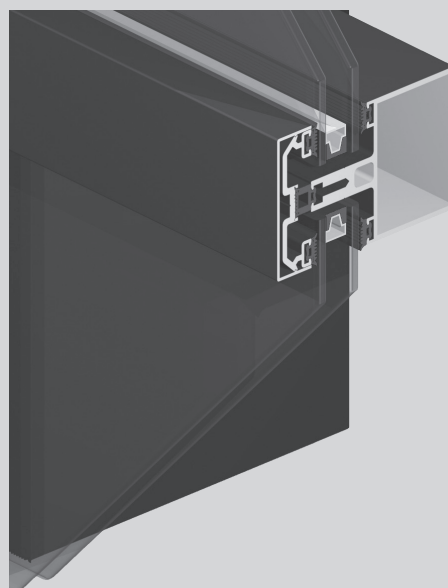
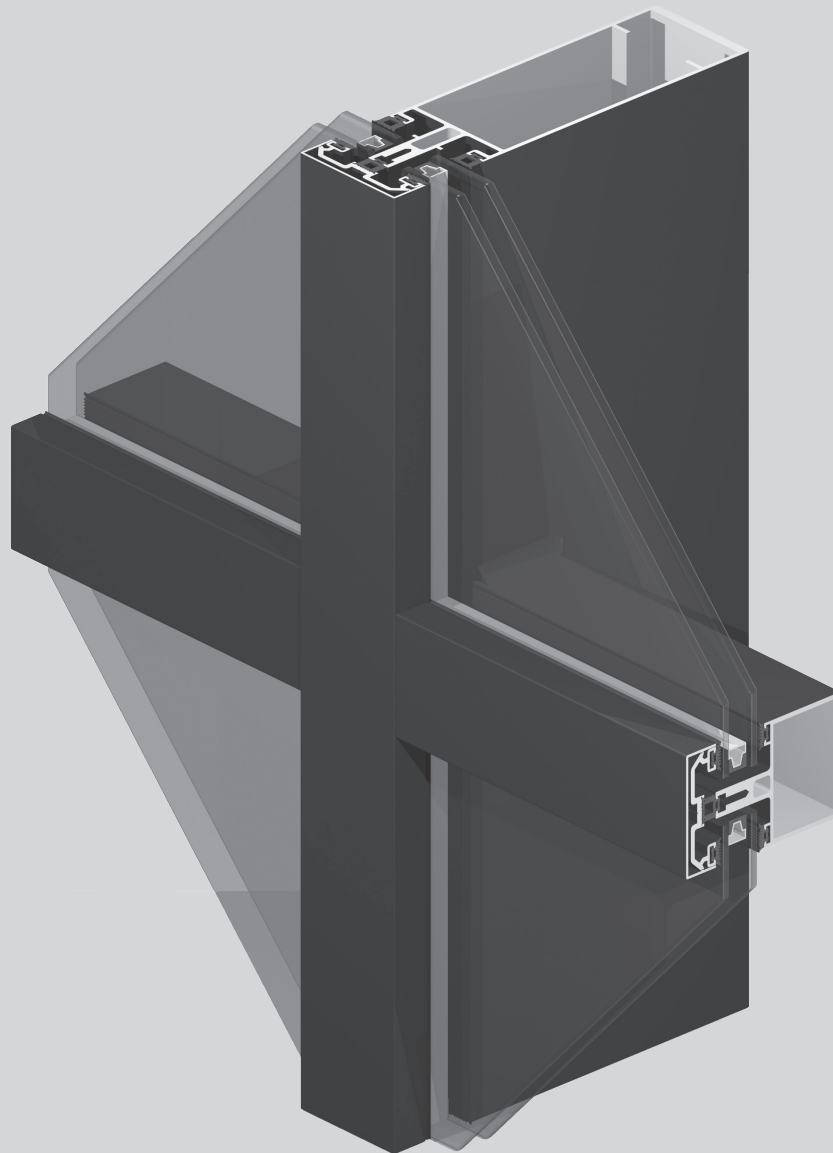

**Fachada
Muro
Invertido**

Fachada Muro Invertido

Características

Neste sistema a colocação de vidros realiza-se mediante uma contra-capa que fixa o vidro à estrutura portante. Sobre este perfil coloca-se uma capa exterior, horizontal e verticalmente, formando assim uma vista exterior nas duas dimensões. A secção visível no interior e exterior dos montantes e travessas é de 65 mm. Ambos os perfis apresentam canais de drenagem e ventilação que garantem juntamente com o sistema de juntas de EPDM, uma estanquidade e permeabilidade máximas.

Possibilidades de abertura

Este tipo de fachada, ao contrário de todos os outros, permite qualquer tipo de abertura proporcionada pelos Sistemas Anicolor. A janela é fixa à estrutura com ajuda do perfil pressionante que fixa o vidro à fachada. Existe também a possibilidade de realizar aberturas projectantes "ocultas", isto é, não visíveis do exterior.

Categorias alcançadas em banco de ensaios:

1. Permeabilidade ao ar: Classe C
2. Estanquidade à água: 600 Pa
3. Resistência ao vento: 2400 Pa
4. Ensaio de segurança: 3600 Pa

Fachada Muro Invertido – Tampa Elíptica

Características

Sistema derivado da Fachada Muro Invertido mas que oferece uma estética exterior distinta. No sentido vertical, os vidros ocultam a estrutura portante, produzindo-se uma união vidro-vidro, enquanto que na horizontal, sobre o perfil pressionante que fixa o vidro, se coloca uma capa com forma elíptica ou redonda, realçando a vista horizontal deste tipo de fachadas. A secção visível, quer no interior, quer no exterior dos montantes e travessas é de 65 mm. Ambos os perfis apresentam canais de drenagem e ventilação que garantem, juntamente com o sistema de juntas de EPDM uma estanquidade e permeabilidade máximas.

Possibilidades de abertura

Este tipo de fachada, ao contrário de todos os outros, permite qualquer tipo de abertura proporcionada pelos Sistemas Anicolor. A janela é fixa à estrutura com ajuda do perfil pressionante que fixa o vidro à fachada. Existe também a possibilidade de realizar aberturas projectantes "ocultas", isto é, não visíveis do exterior.

Pormenor horizontal e vertical

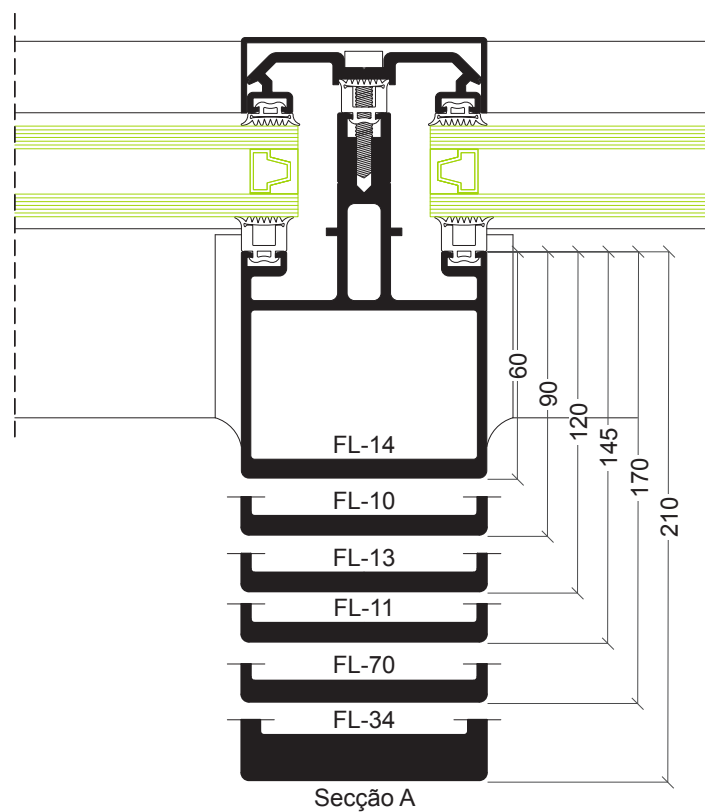
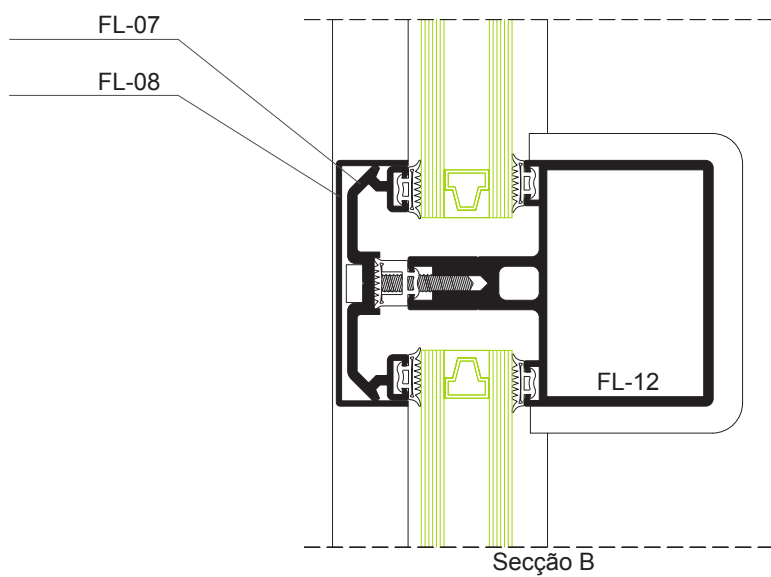
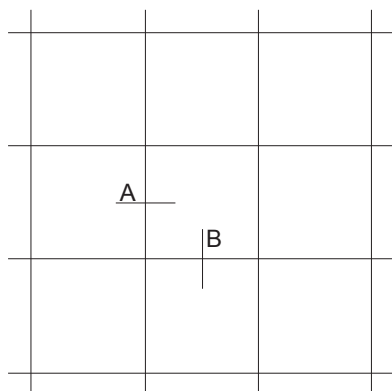

Pormenor horizontal e vertical Janela projectante-deslizante (AXi)

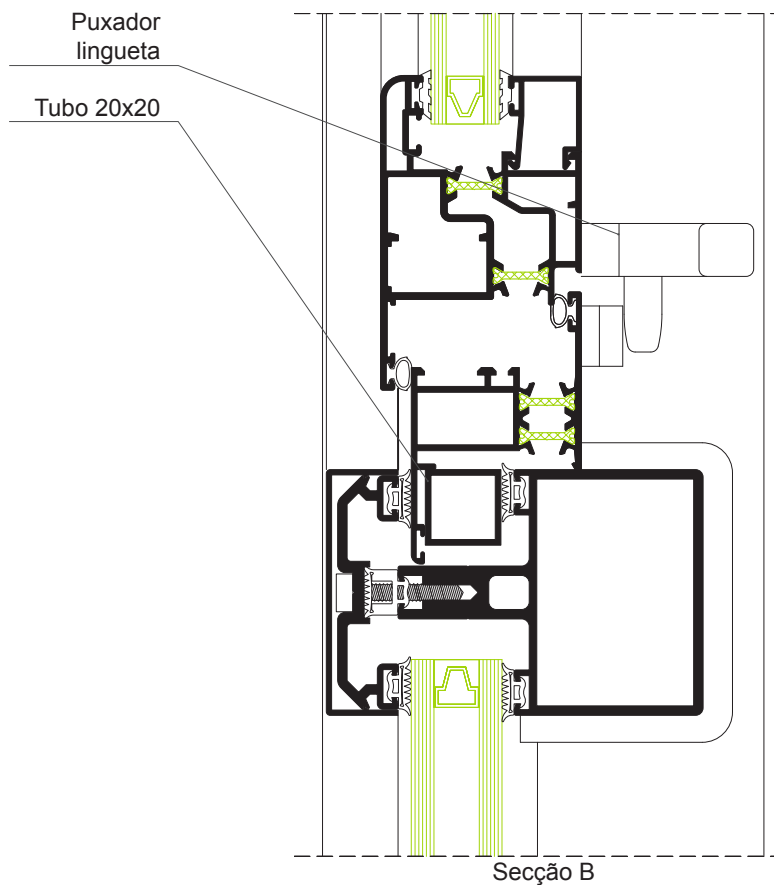
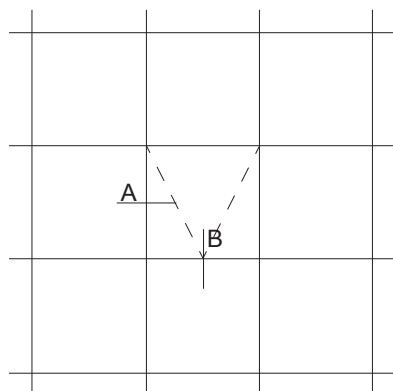

466

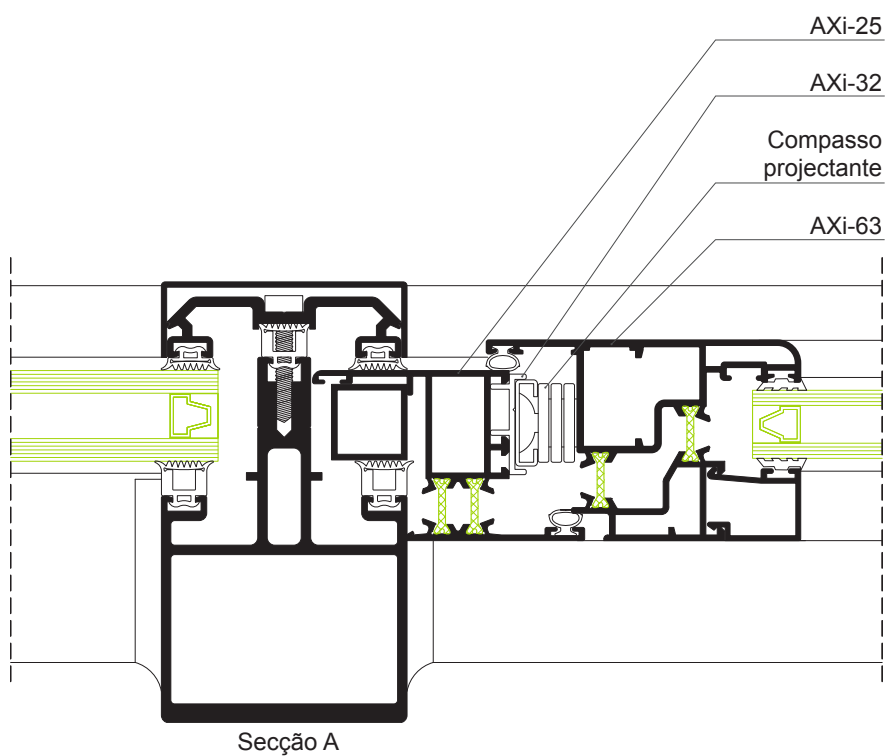

**Pormenor horizontal e vertical
Janela projectante-deslizante (folha oculta)**

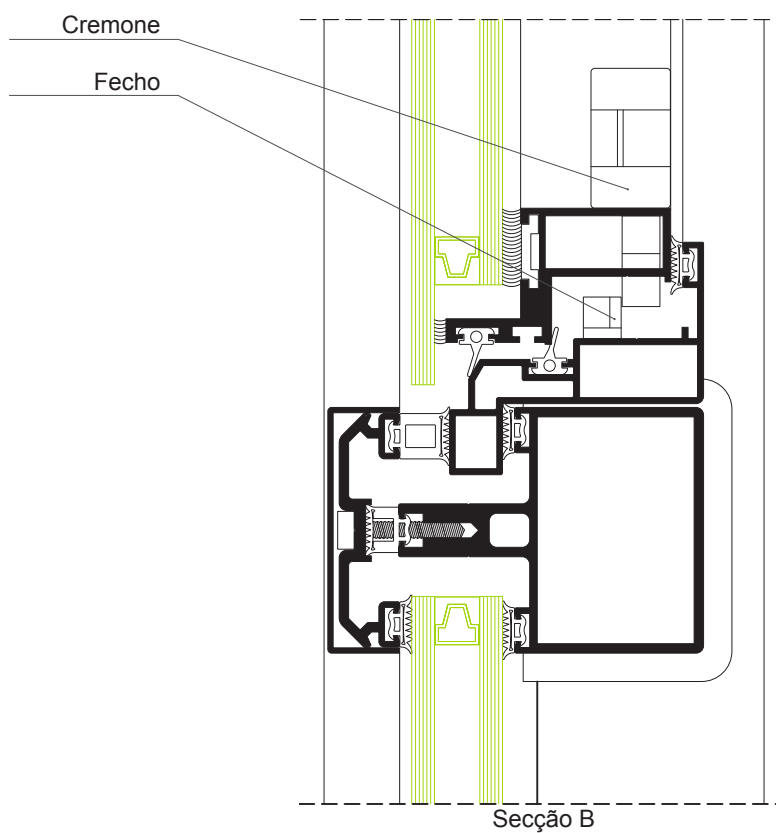
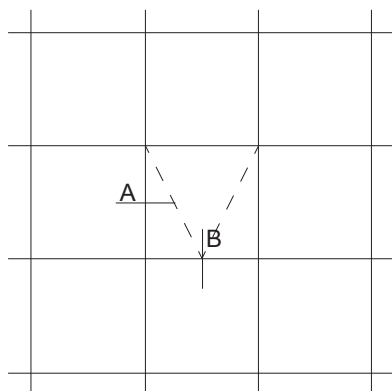

467

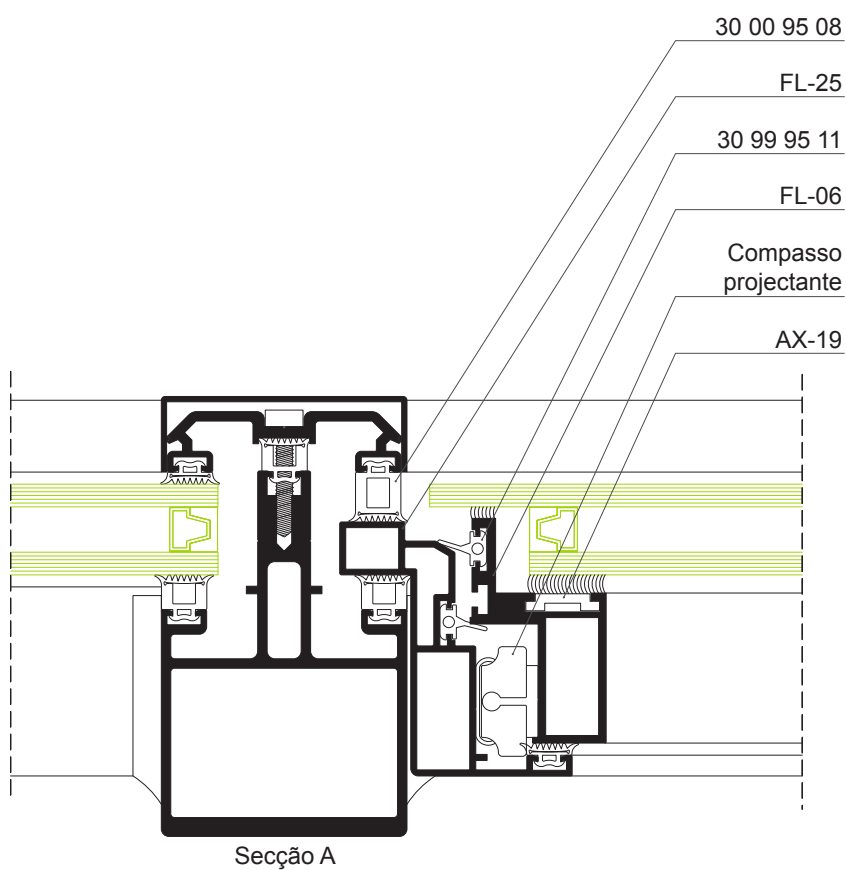

Pormenor canto 90°

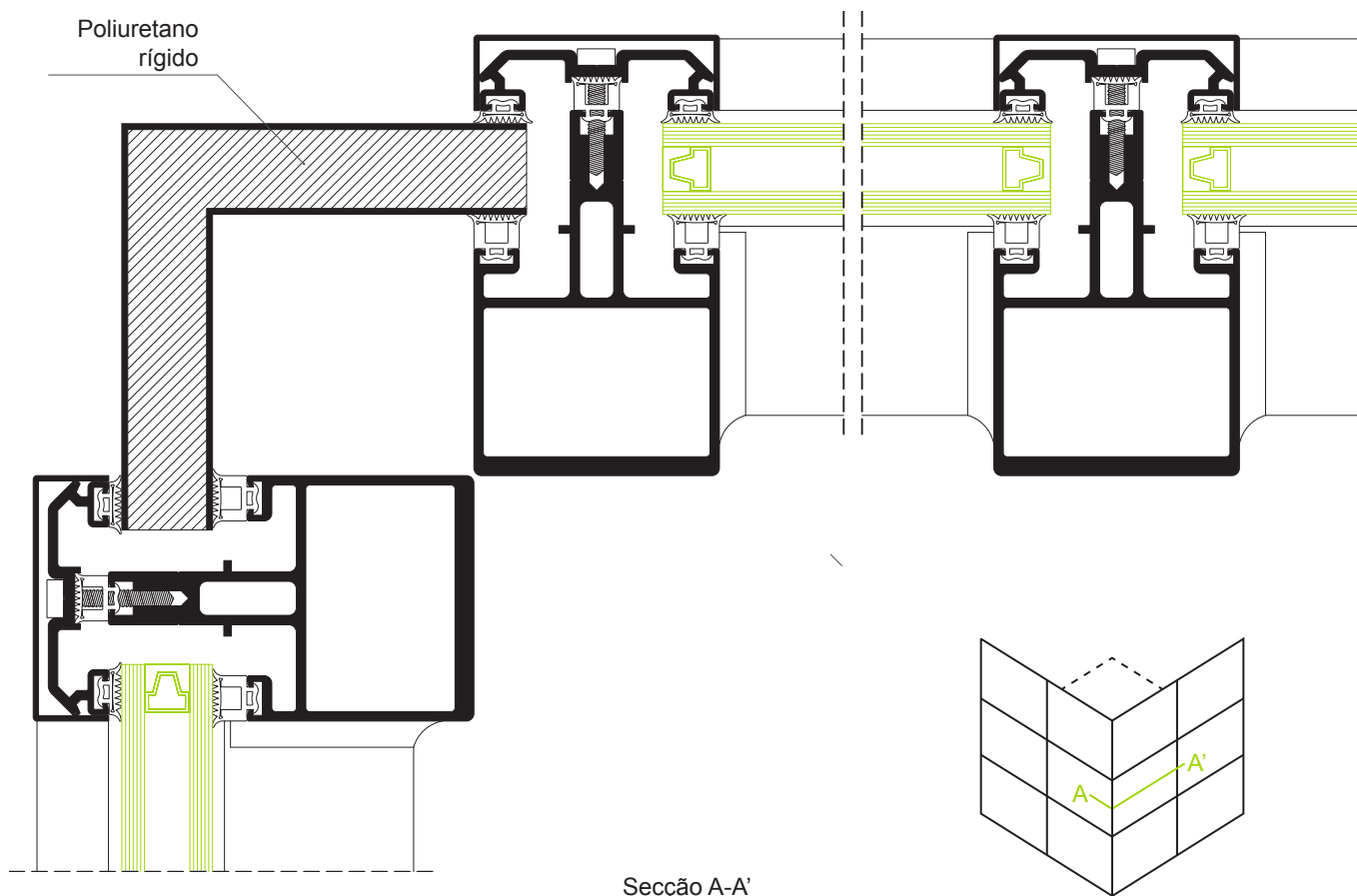

468

Pormenor canto 90°

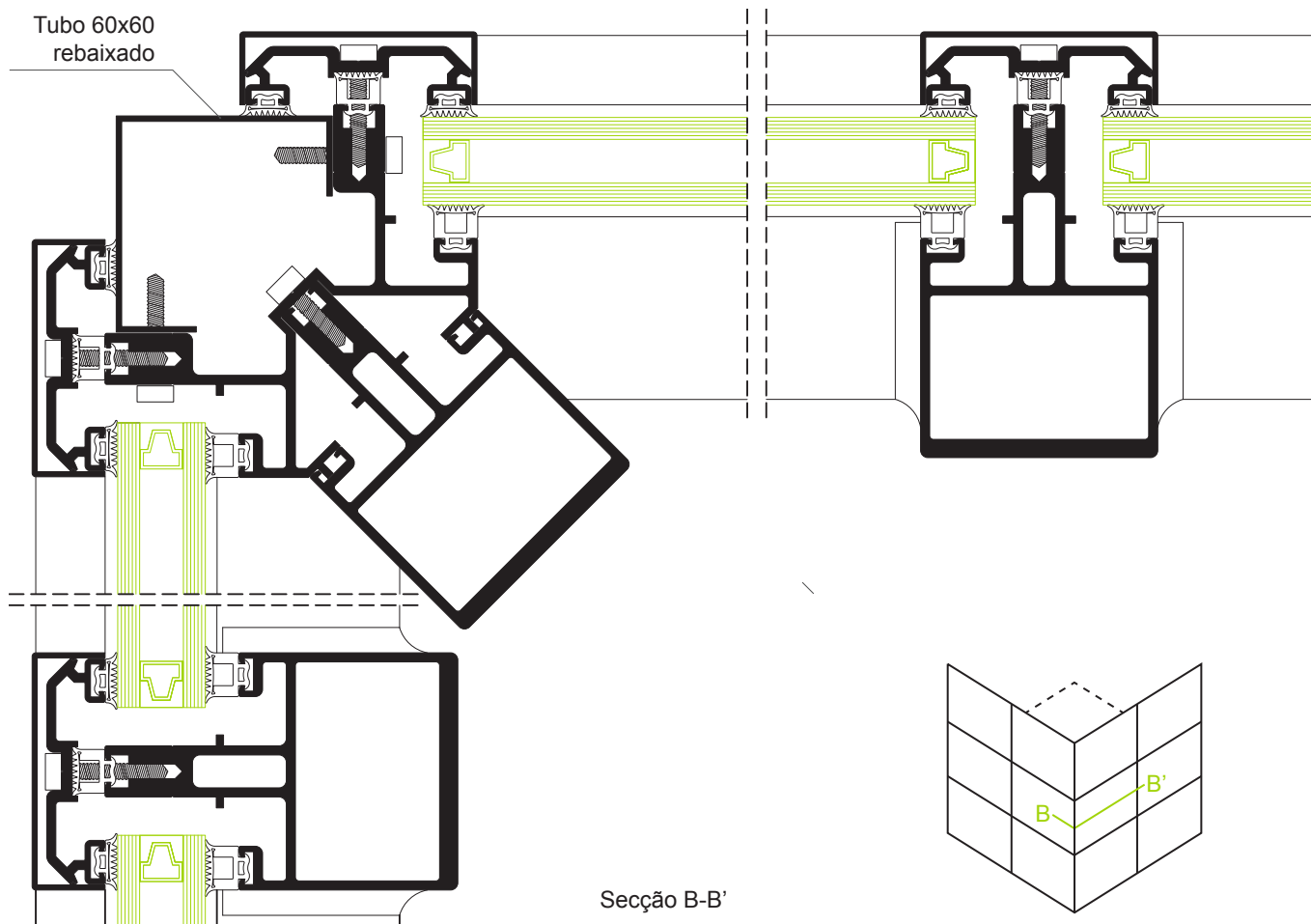

Pormenor canto 90°

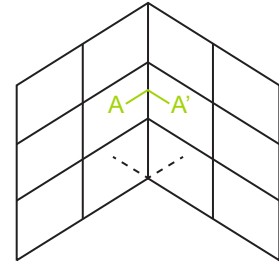
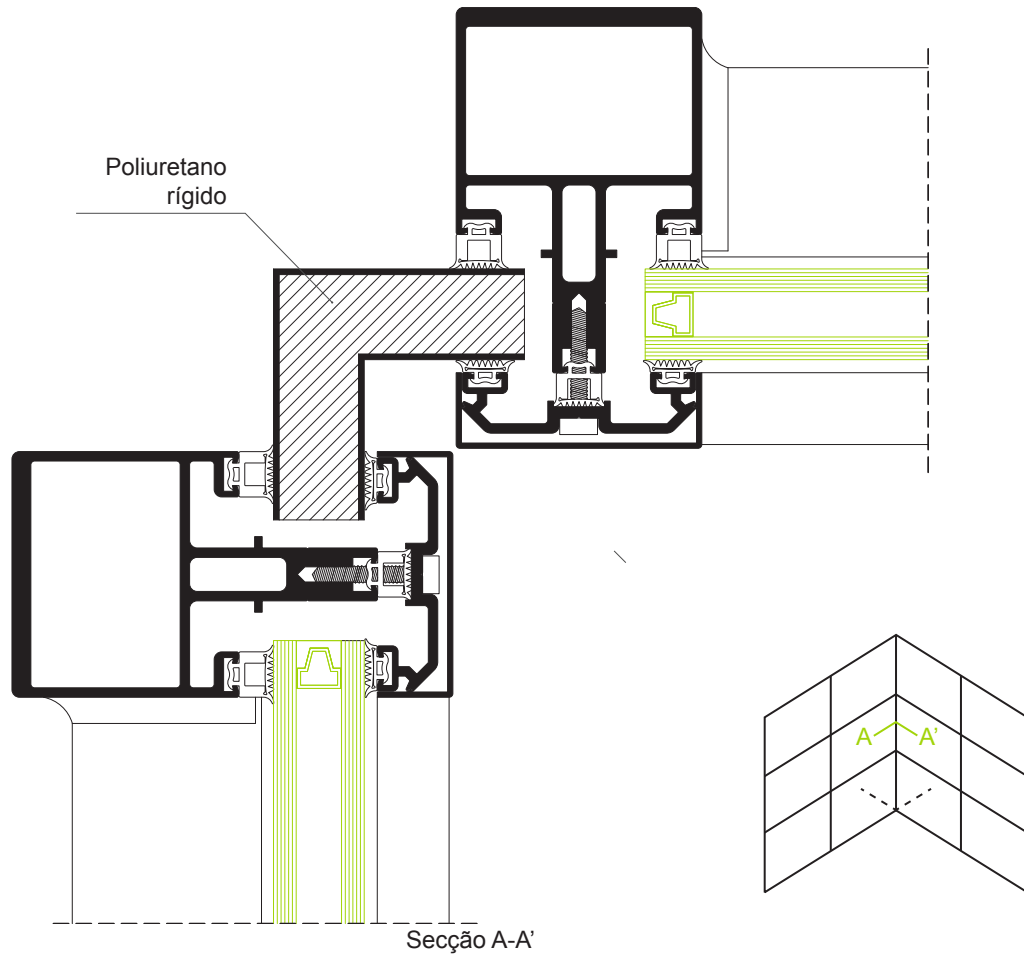



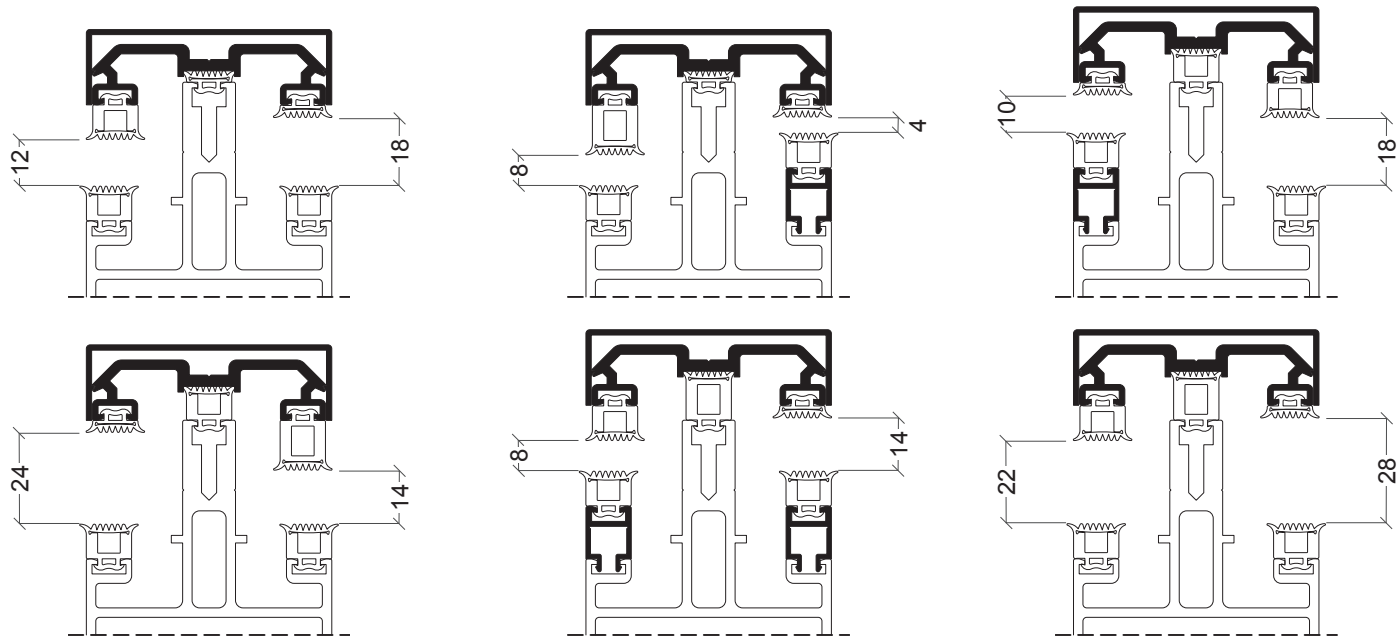

Caixas de vidro

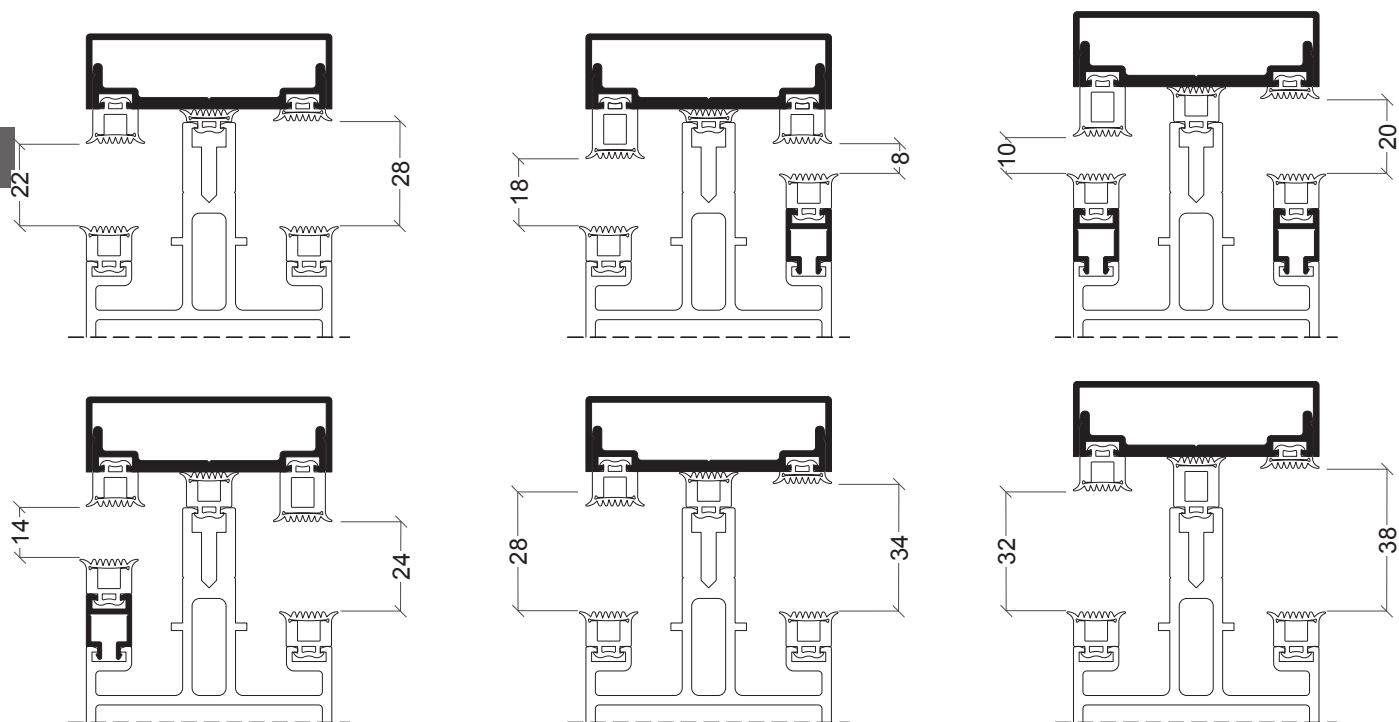

Caixas de vidro



Referência	Desenho	Descrição
FL-32		Suplemento de muro invertido
30 00 95 01	 ↕ 11	Junta interior montante Junta central montante e travessa (muro invertido)
30 00 95 05	 ↕ 5	Junta interior de travessa
30 00 95 08	 ↕ 15	Junta central montante e travessa

Pormenor horizontal e vertical

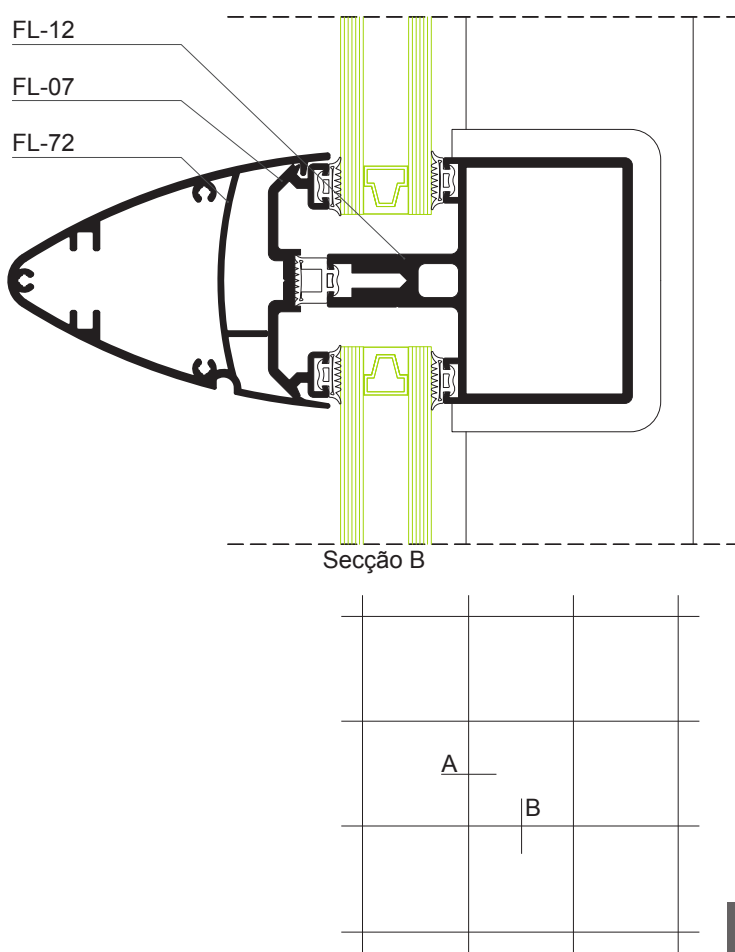
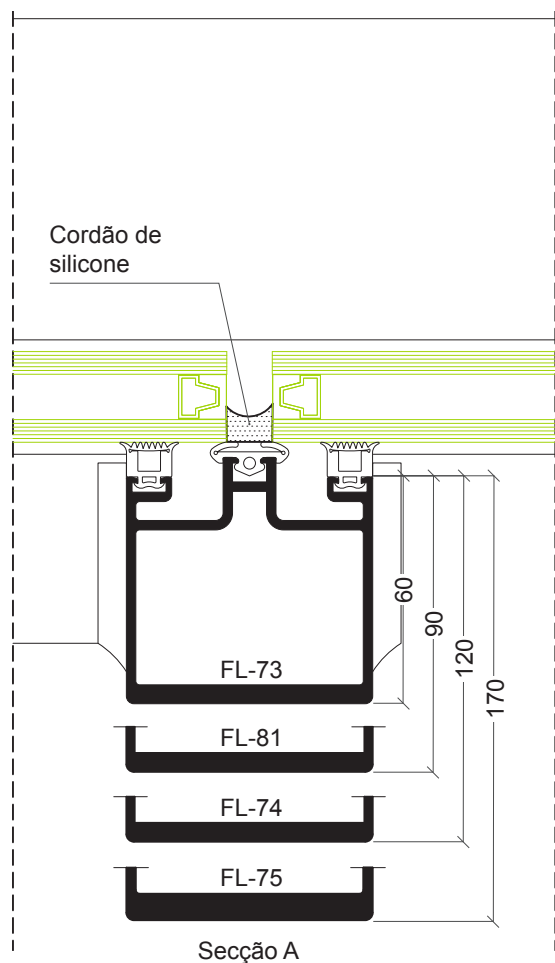

Pormenor horizontal e vertical
Janela projectante

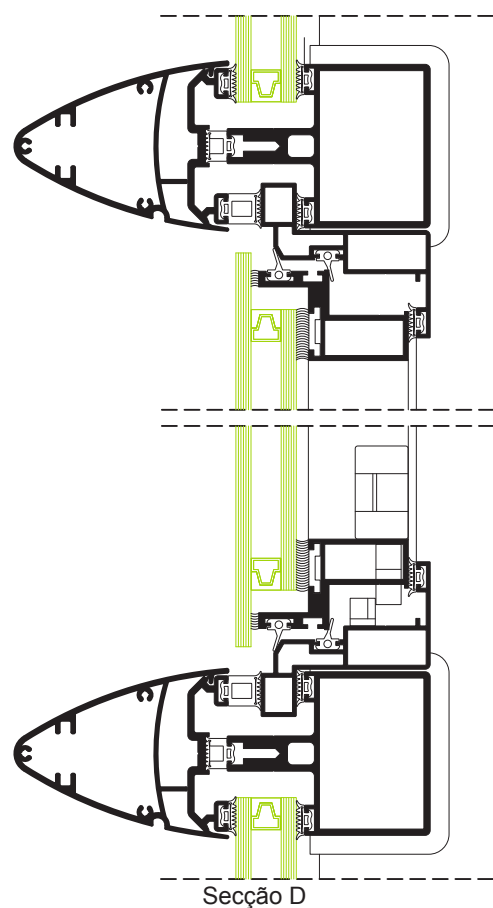
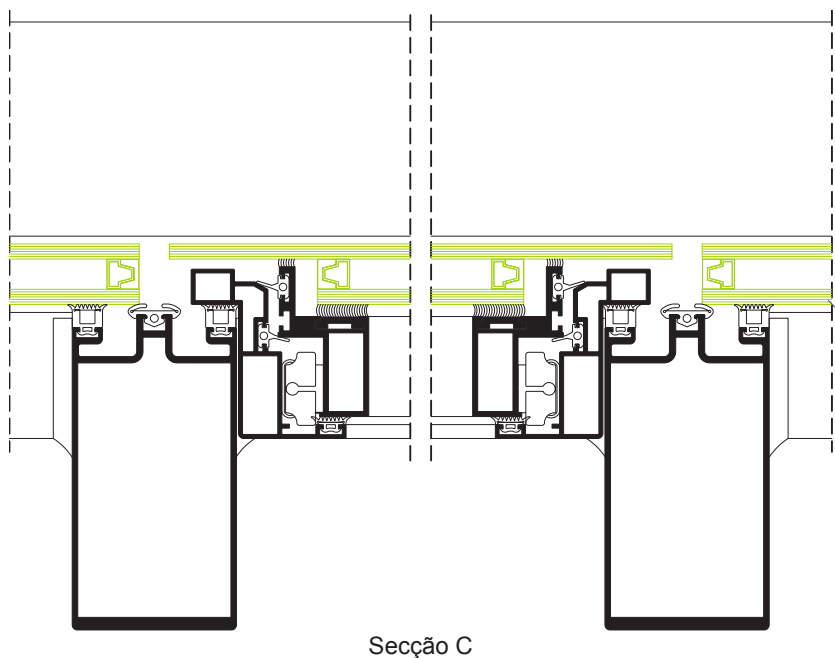
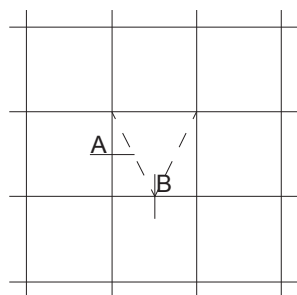

Pormenor canto 90°

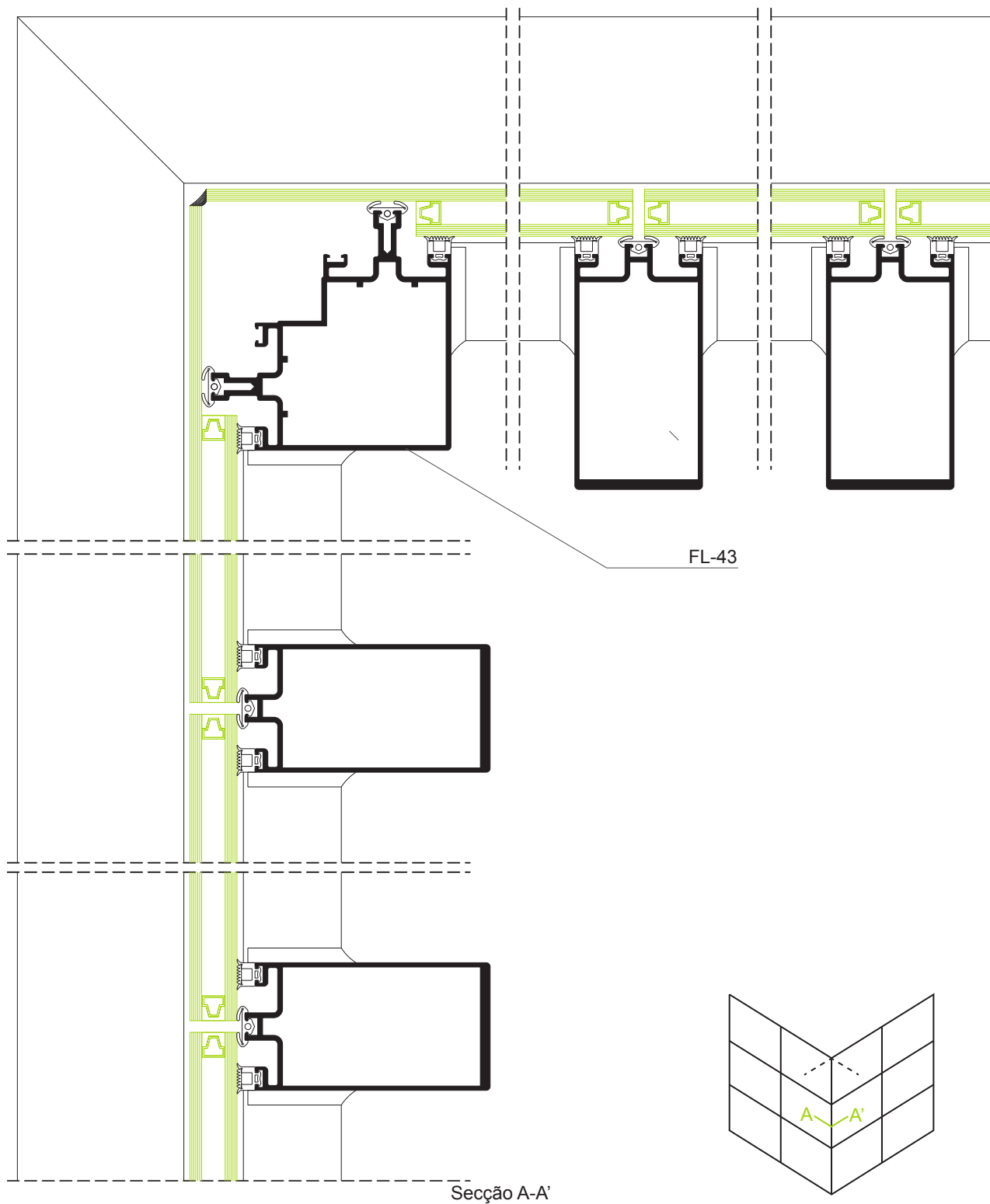

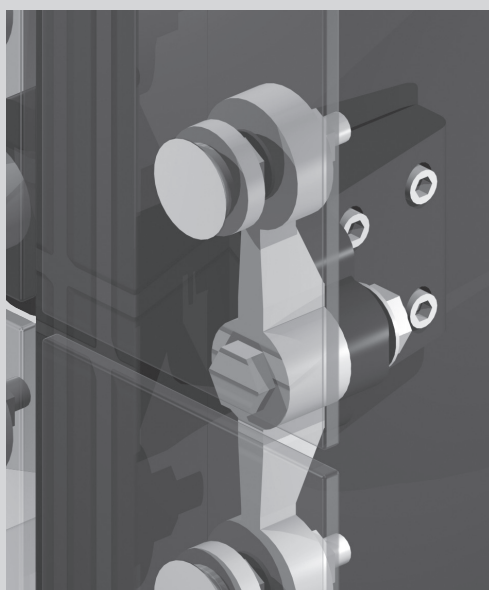
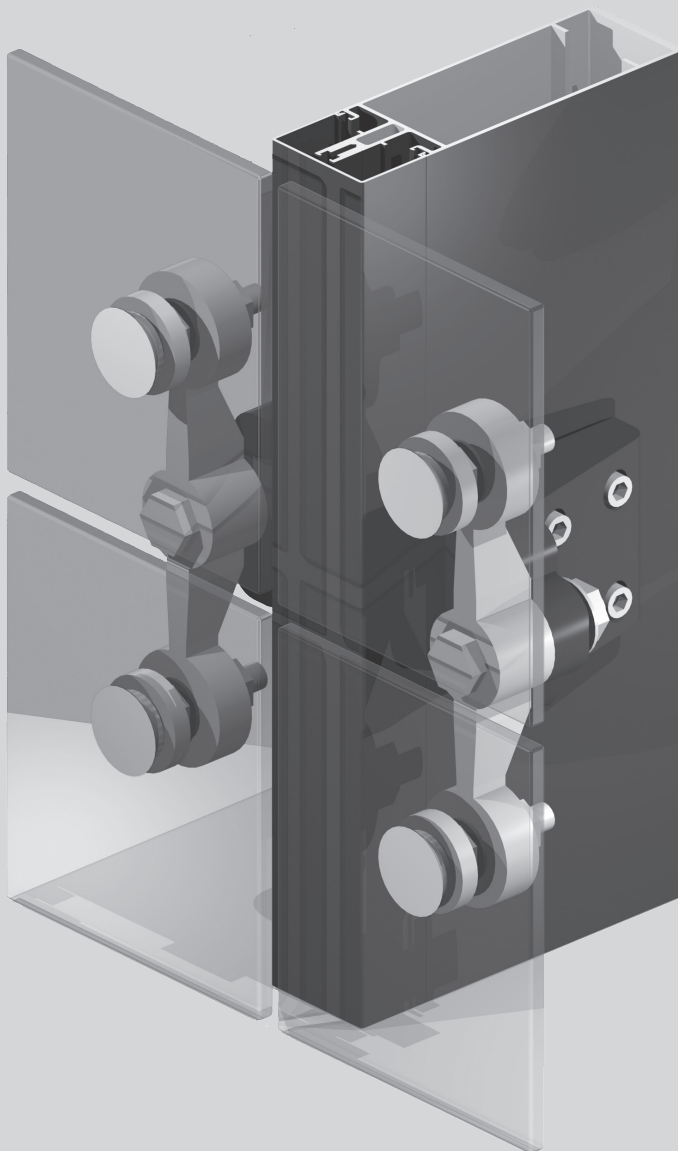

**Fachada
Milénio**

Fachada Milénio

Características

Sistema de fachada ligeira, onde o vidro exterior é fixo mediante grampos e peças de fixação, fixas ou com rótulas. Os grampos, fabricados em aço inoxidável são fixos às peças de suporte do vidro. O vidro, temperado e/ou laminado é previamente mecanizado para permitir a sua fixação à estrutura. As peças de fixação apresentam as seguintes vantagens:

- facilitam a colocação do vidro;
- amortecem as deformações produzidas no vidro (pressão do vento, dilatações, ...);
- permitem corrigir defeitos construtivos.

A estrutura portante sobre a qual se fixam os grampos é formada por perfis verticais de alumínio com a elevada espessura de 65 mm de secção visível. Tal espessura confere a estes perfis um elevado momento de inércia, permitindo construções com grandes distâncias entre apoios. Este sistema complementa-se com outros perfis e juntas que permitem realizar as mais variadas soluções construtivas.

Possibilidades de abertura

Este sistema não oferece possibilidade de abertura.

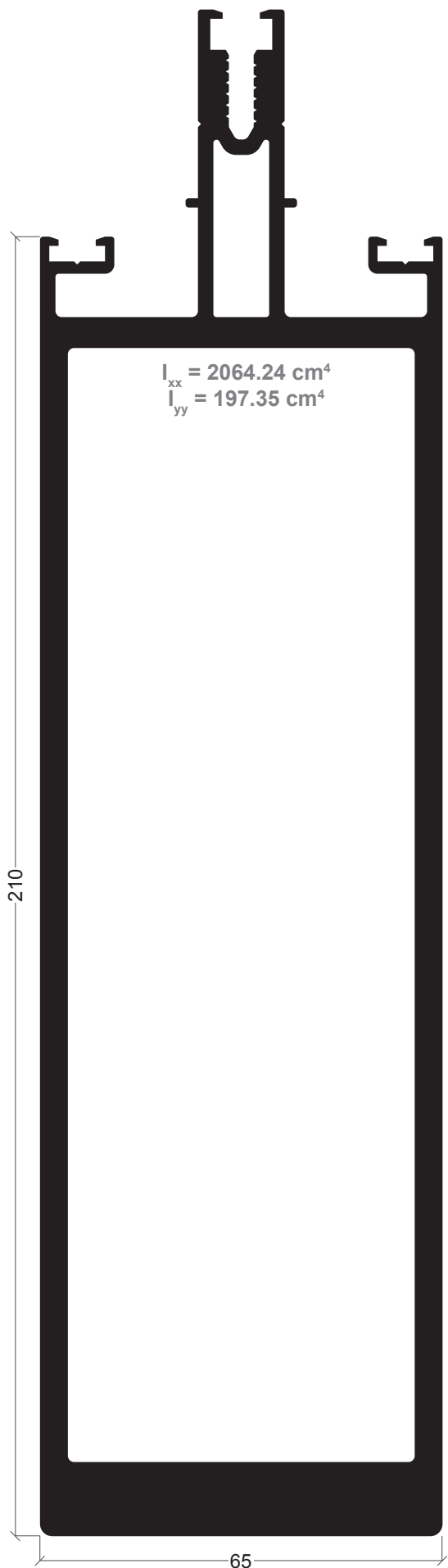

FL-34
Montante de 210 mm



FL-53
Remate topo de montante

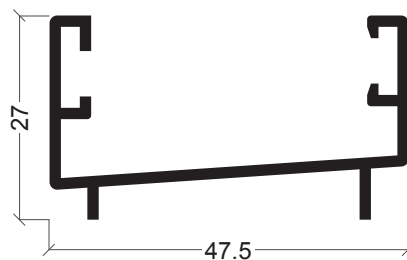

FL-54
Remate

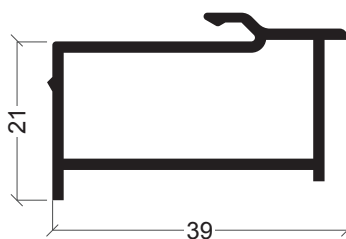

FL-55
Porta-vedante

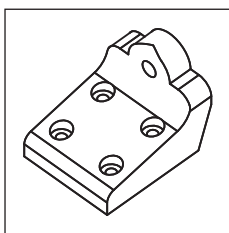

30 20 96 01

Suporte do vidro

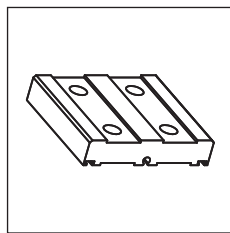

30 20 96 02

Contra-placa

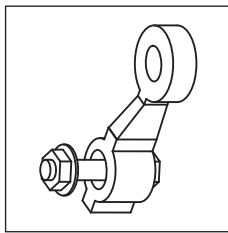

30 20 96 03

Grampo 1 (0°) (peso vidro máx. 300 kg)

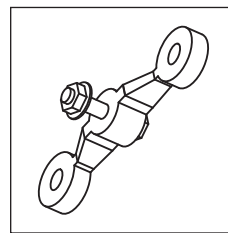

30 20 96 04

Grampo 2 (180°) (peso vidro máx. 300 kg)

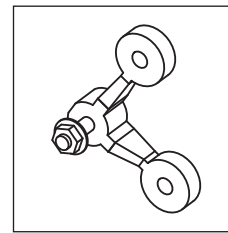

30 20 96 05

Grampo 3 (90°) (peso vidro máx. 300 kg)

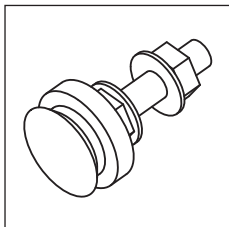

30 20 96 06

Rótula
(vidro monolítico 8-12 mm)
(vidro laminado 8-12 mm / 6-15 mm)

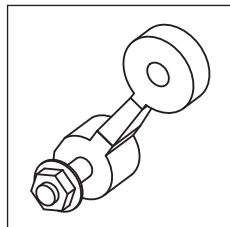

30 20 96 09

Grampo 4 (45°) (peso vidro máx. 300 kg)

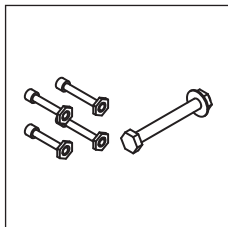

30 27 96 01

Kit de fixação

Referência	Desenho	Descrição
30 20 96 07		Junta de remate
30 20 96 08		Junta entre vidros

Pormenor horizontal

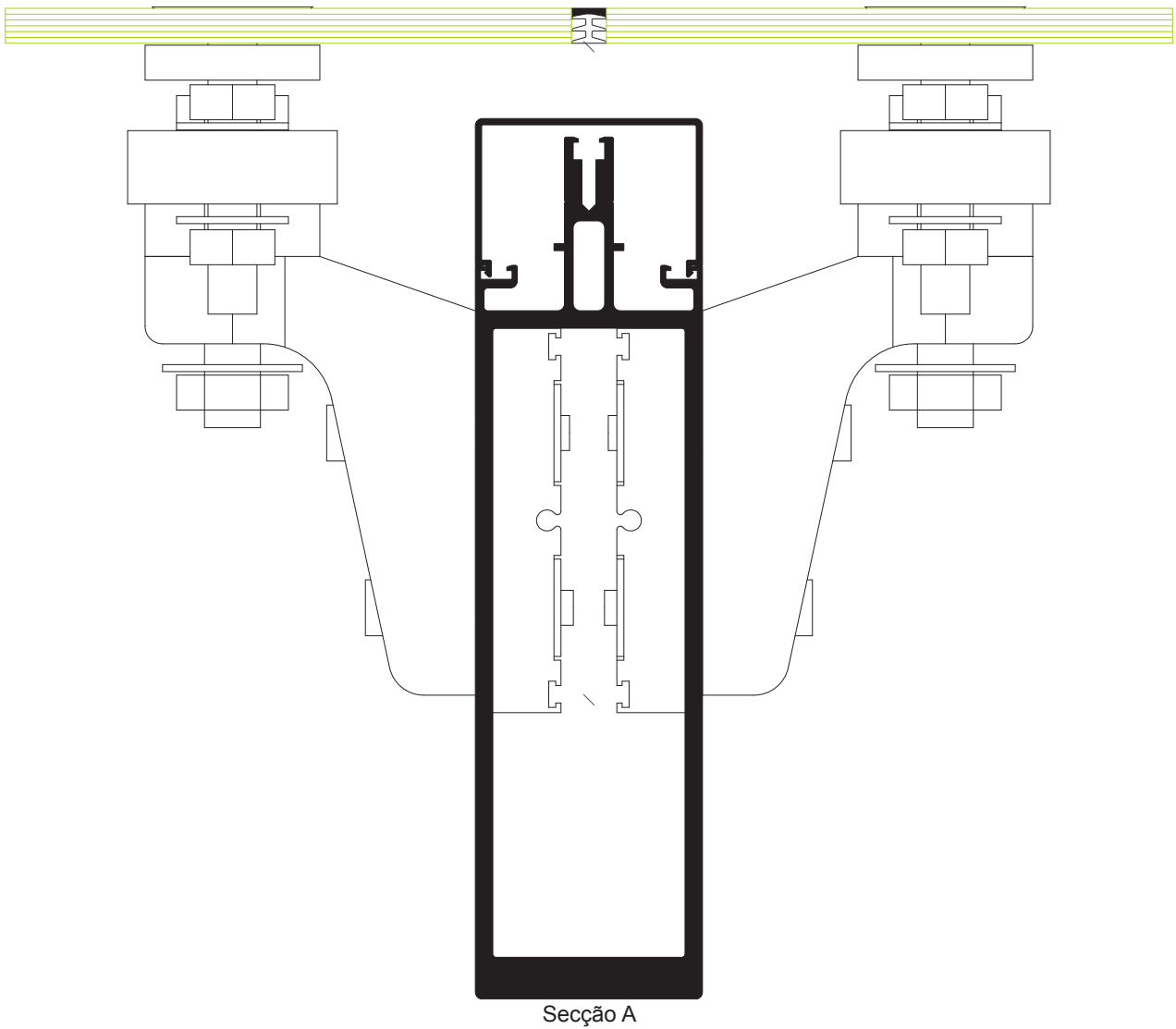
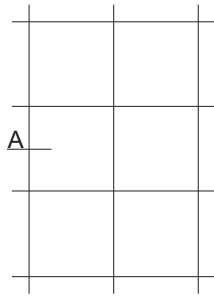

Pormenor vertical

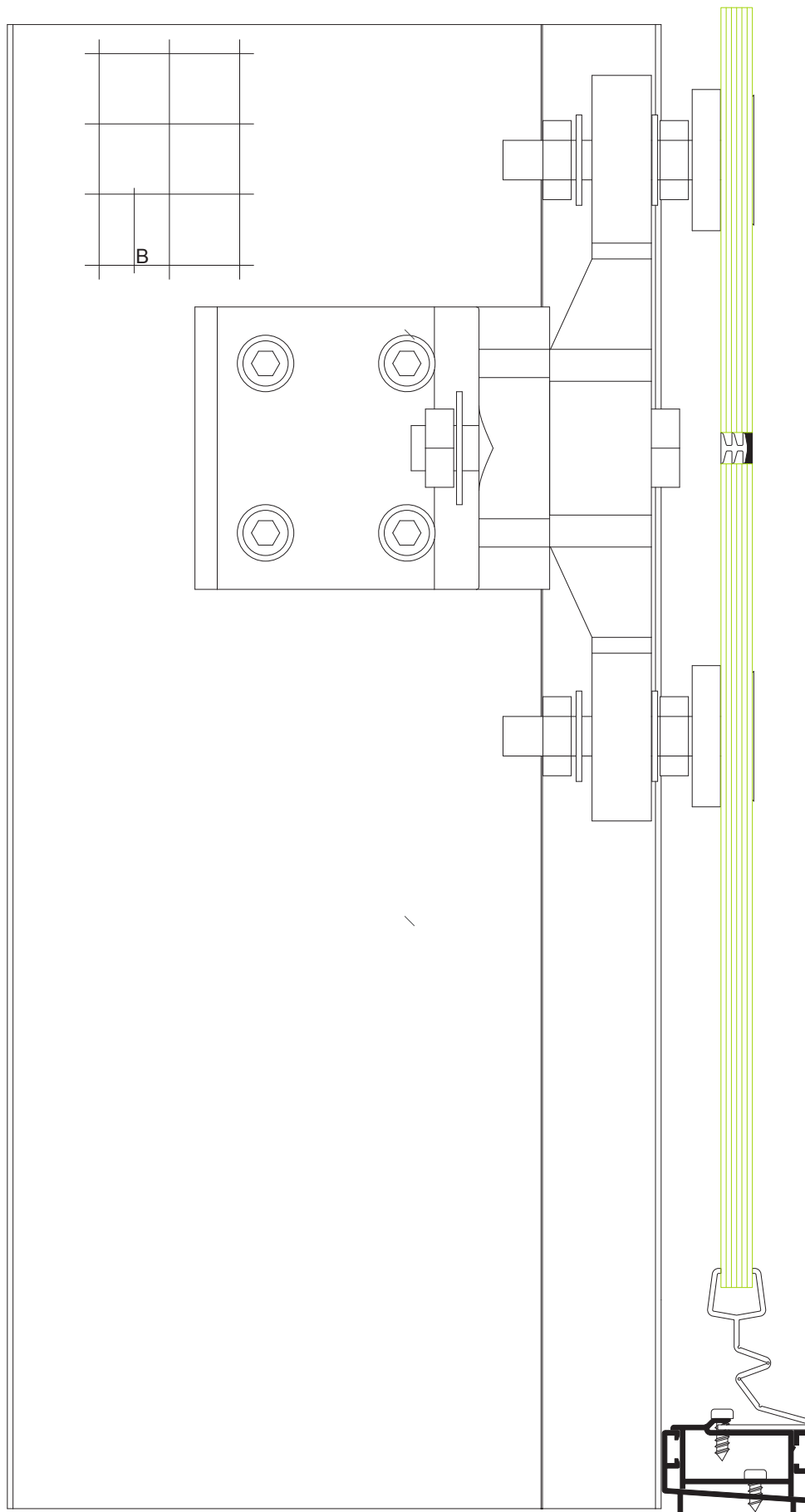

478

Secção B

Pormenor canto 90°

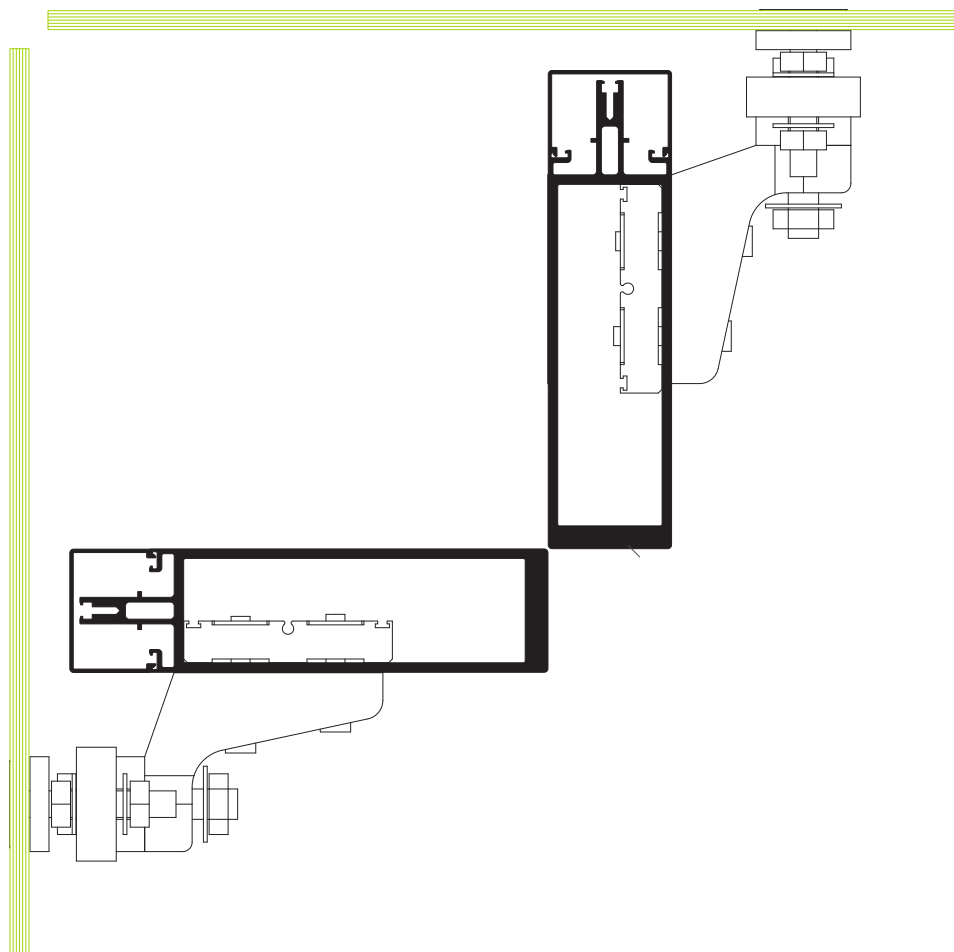
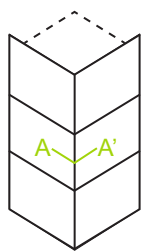

Secção A-A'

Pormenor canto 90°

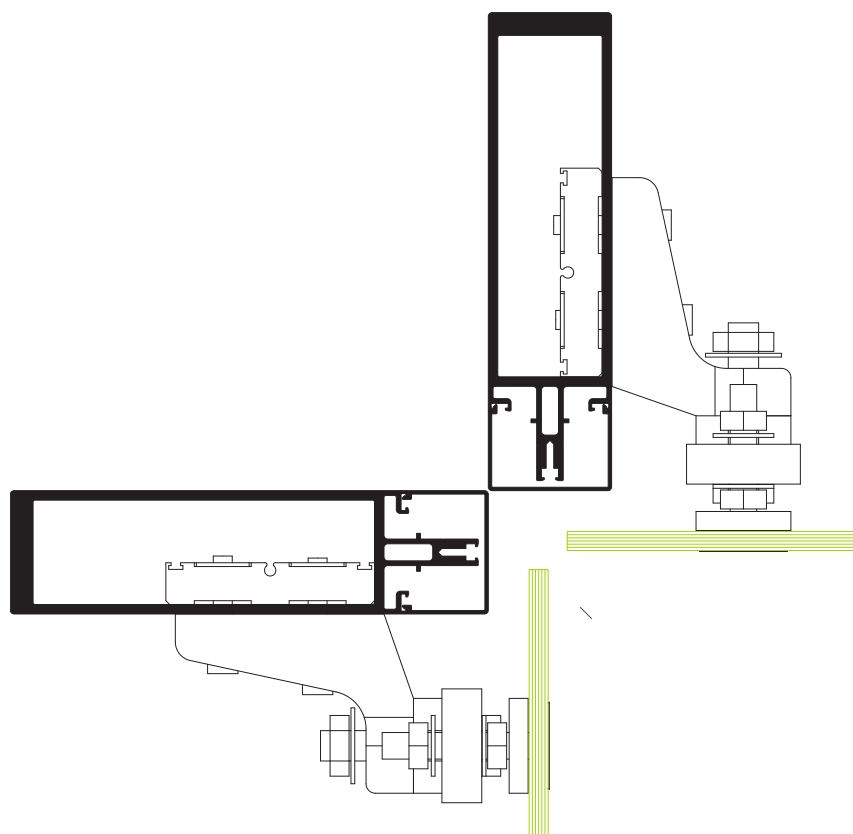
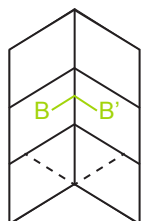

Secção B-B'

Pormenor horizontal

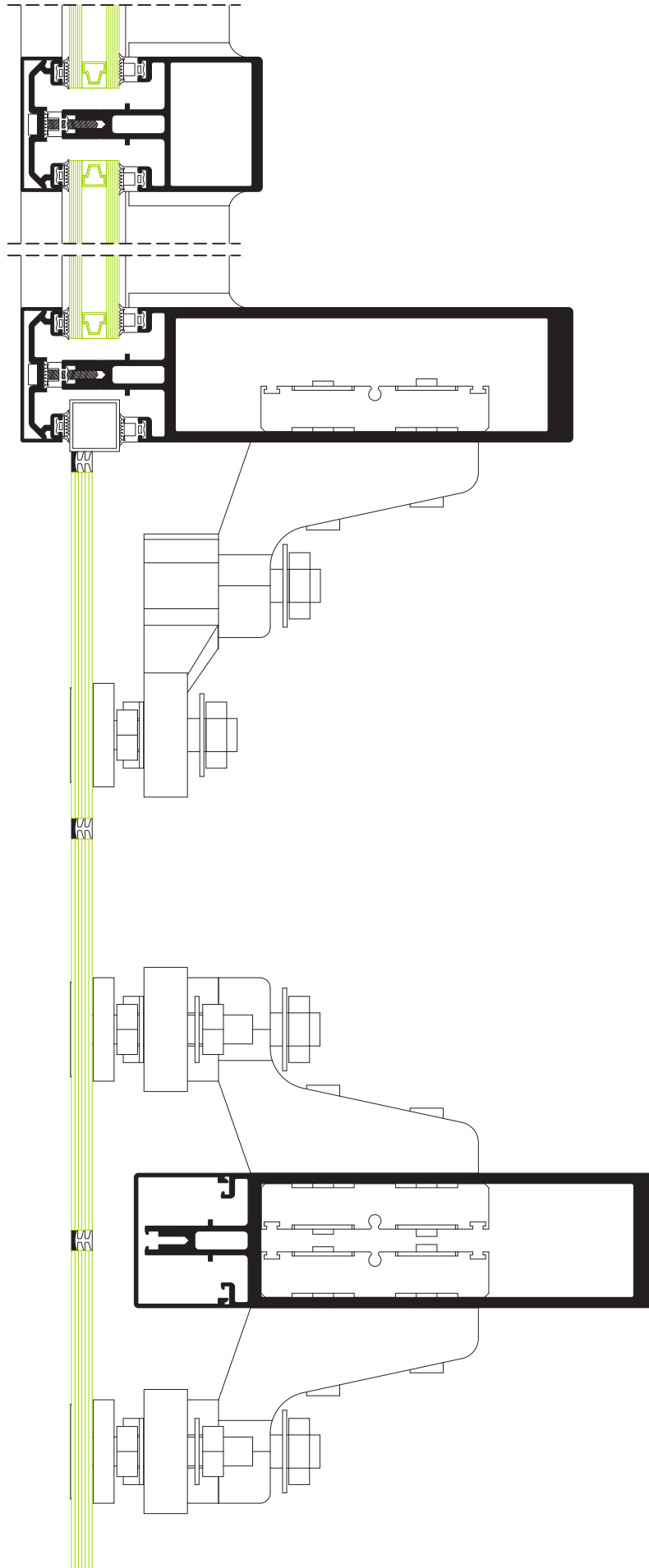

480

Secção A-A'



**Sistema
Ergolux**

Sistema Ergolux

Características

Este sistema utiliza o princípio fundamental de canais de drenagem e ventilação dos sistemas de fachada. Complementa-se com perfis que permitem adoptar distintas soluções, tanto em clarabóias como em varandas. Podem assim gerar-se novos espaços com grande luminosidade.

Os perfis deste sistema têm uma secção visível interior de 65 mm, enquanto que a sua profundidade varia segundo as necessidades do cálculo estático (estrutura portante, carga de neve, zona eólica, etc.) Do mesmo modo, existe uma grande gama de capas pressionantes do vidro com várias possibilidades de ajuste, permitindo assim que se consigam os ângulos necessários para cada caso. Este sistema, aplicado em coberturas ou solários, contém perfis de ligação com e sem rotura térmica, que permitem a utilização de qualquer tipo de abertura. A total estanquidade do sistema é garantida pelo conjunto de juntas em EPDM, resistentes aos agentes atmosféricos.

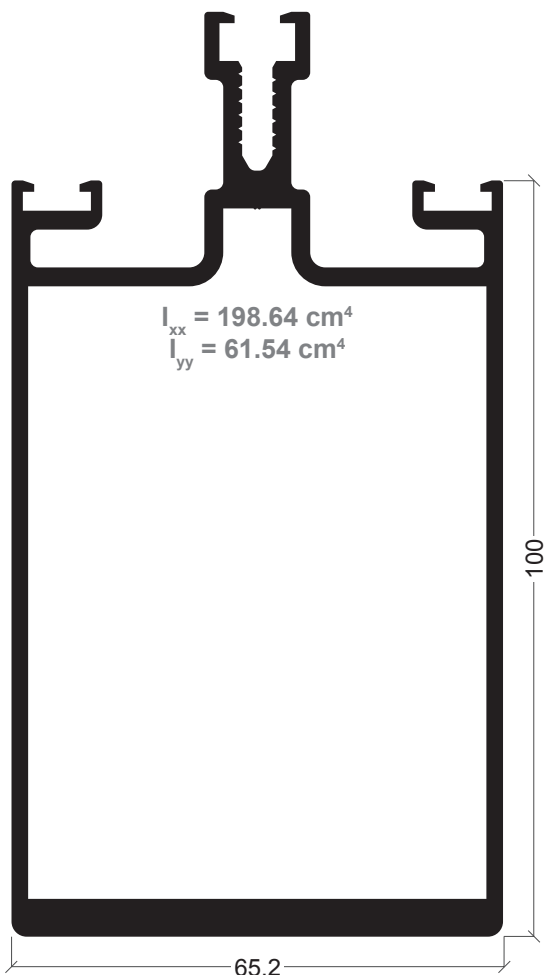

FL-41
Montante 100 mm

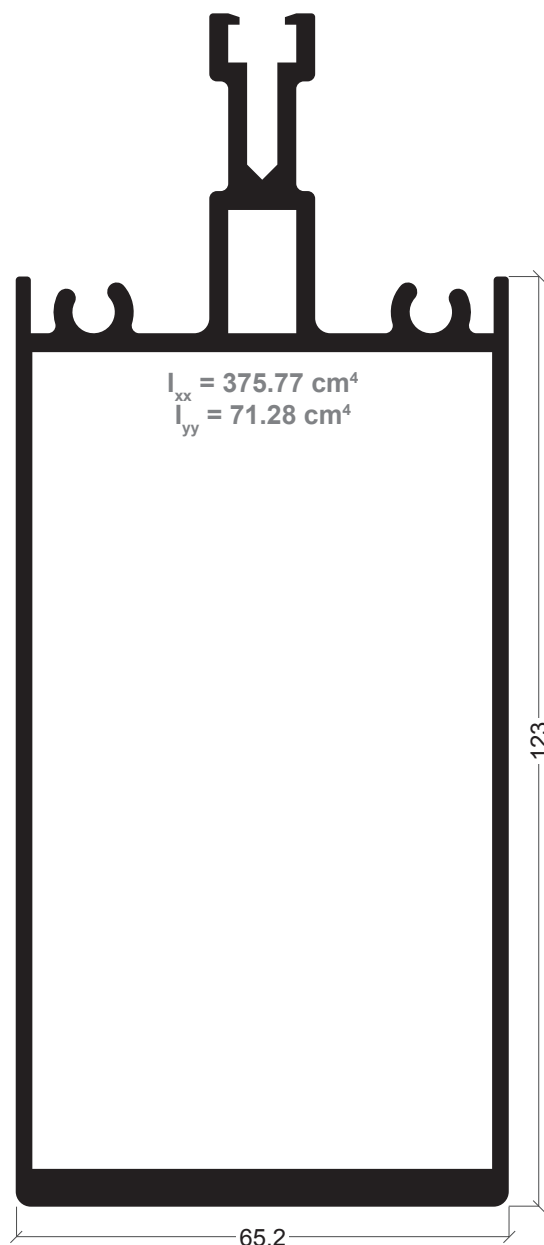

FL-56
Montante regulável

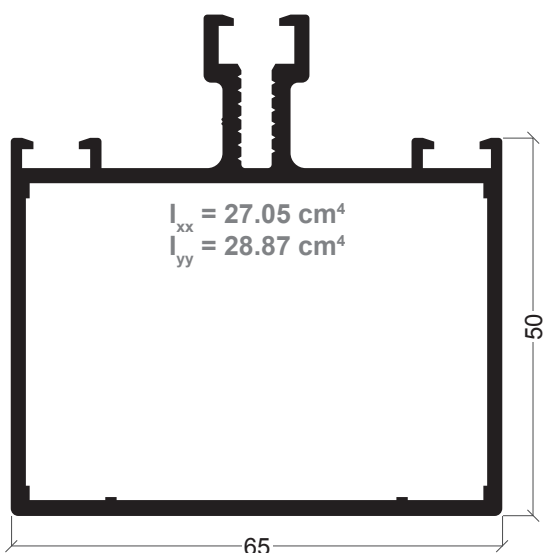

FL-42
Travessa

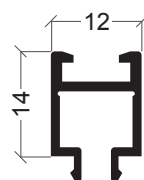

FL-32
Suplemento

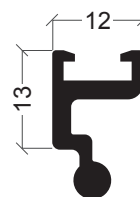

FL-23
Porta vedante regulável

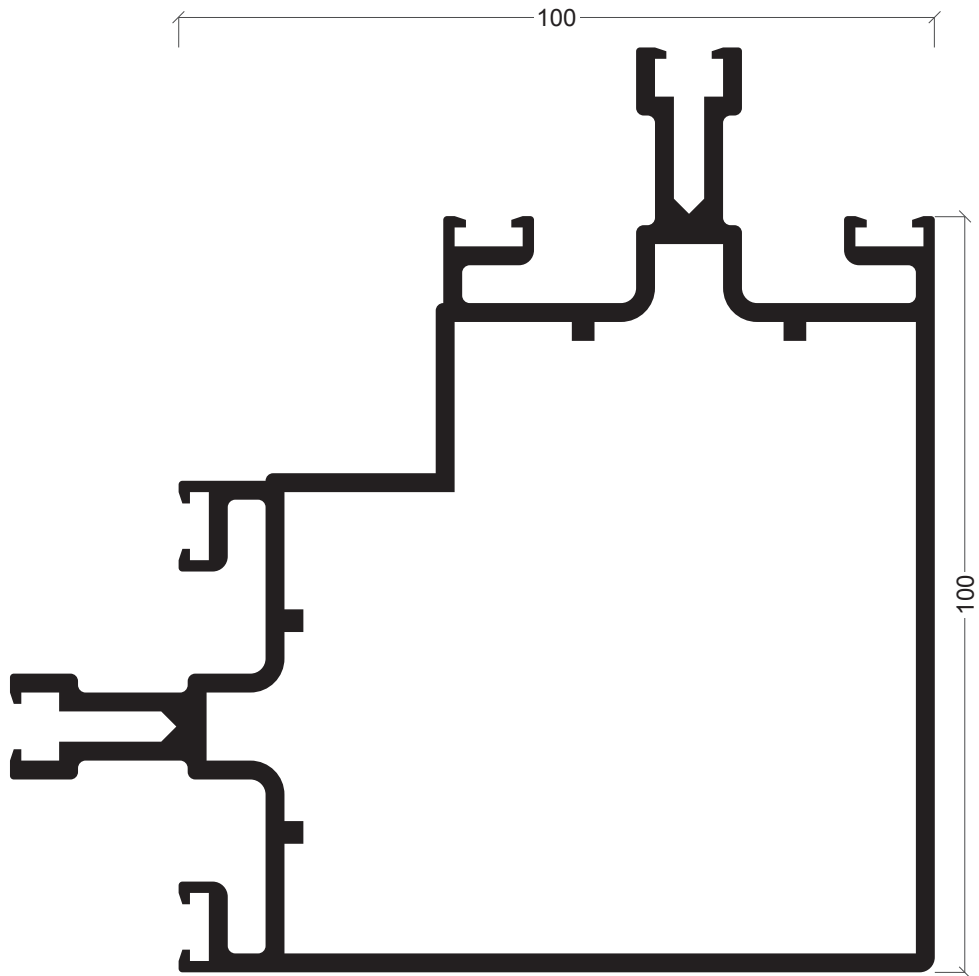

484

FL-43
Esquina 90°

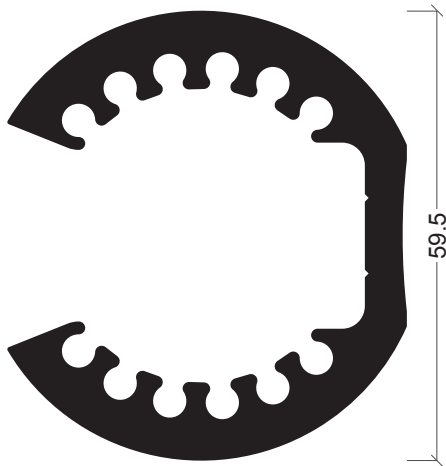

FL-69
Topo de fixação

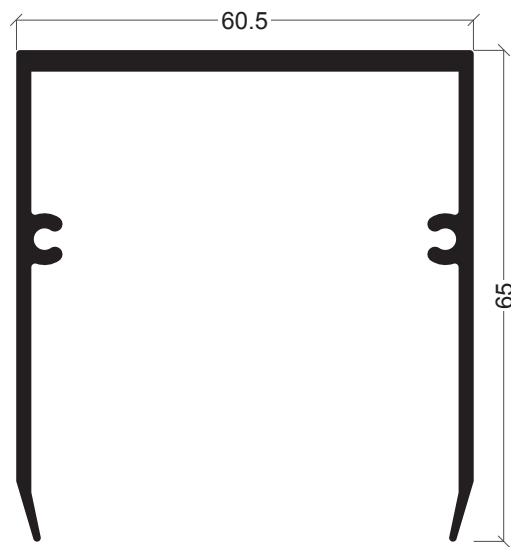

FL-68
Topo de travessa

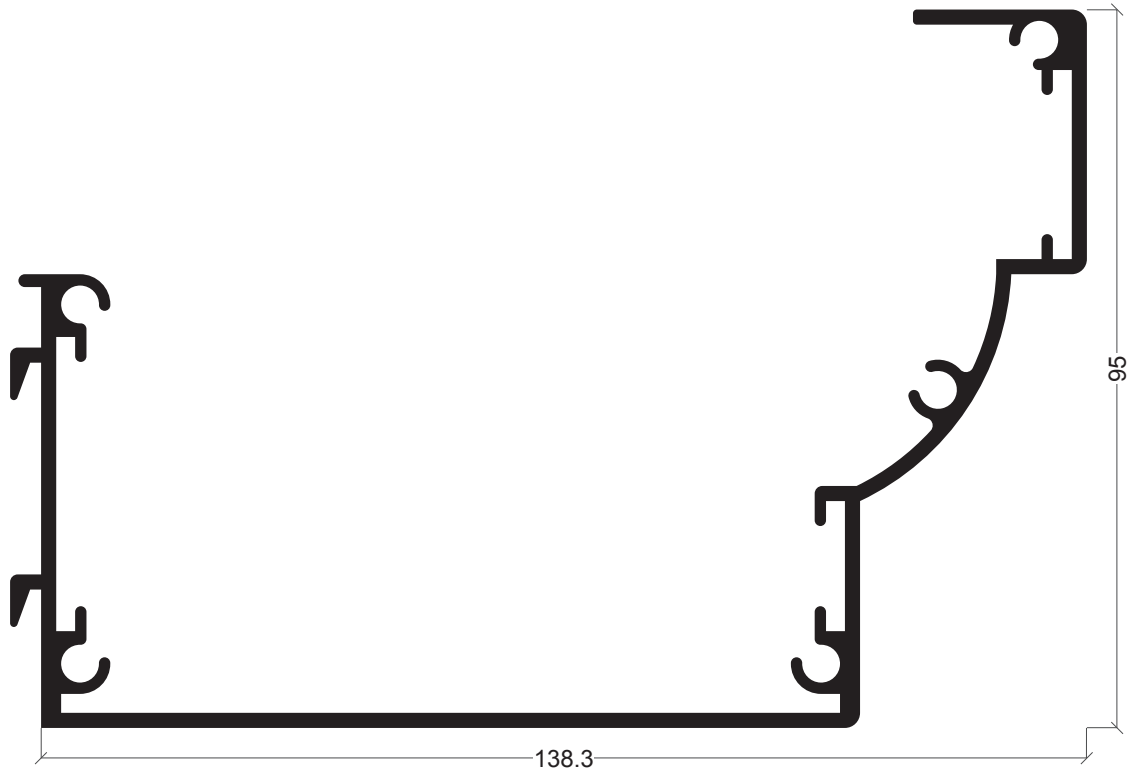

FL-57
Caleira

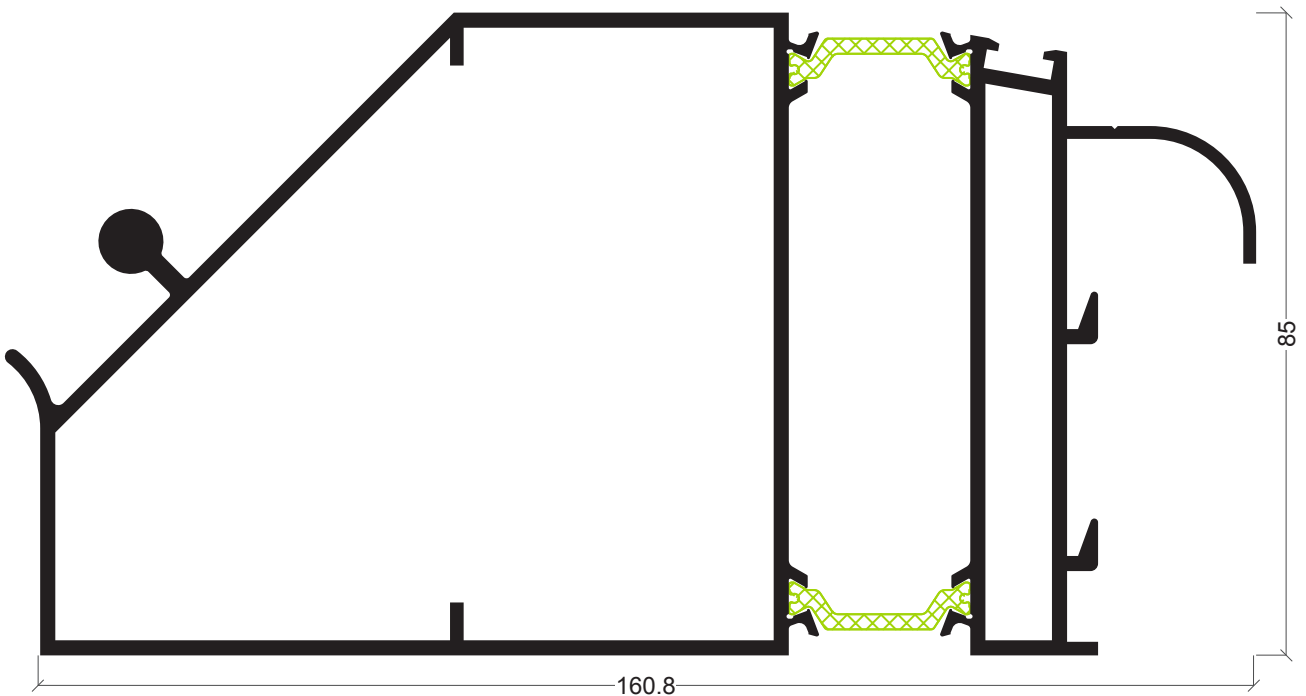

FL-60
Porta basculante inferior

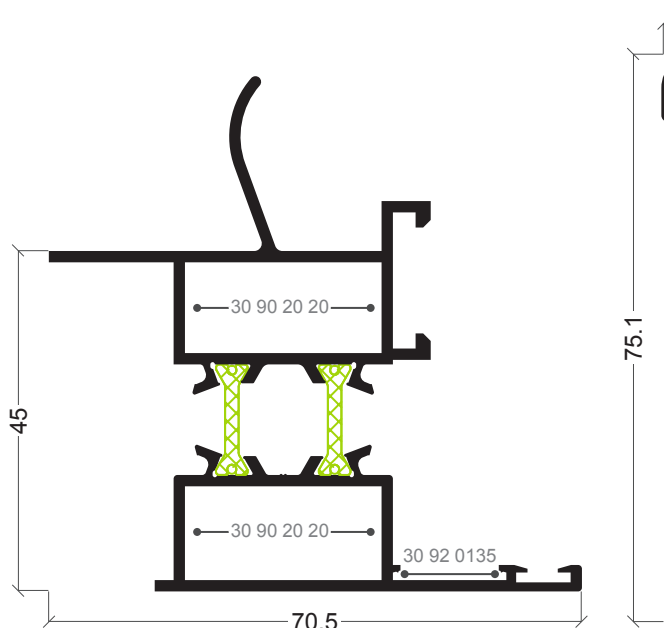

FL-65
Aro fixo claraboia

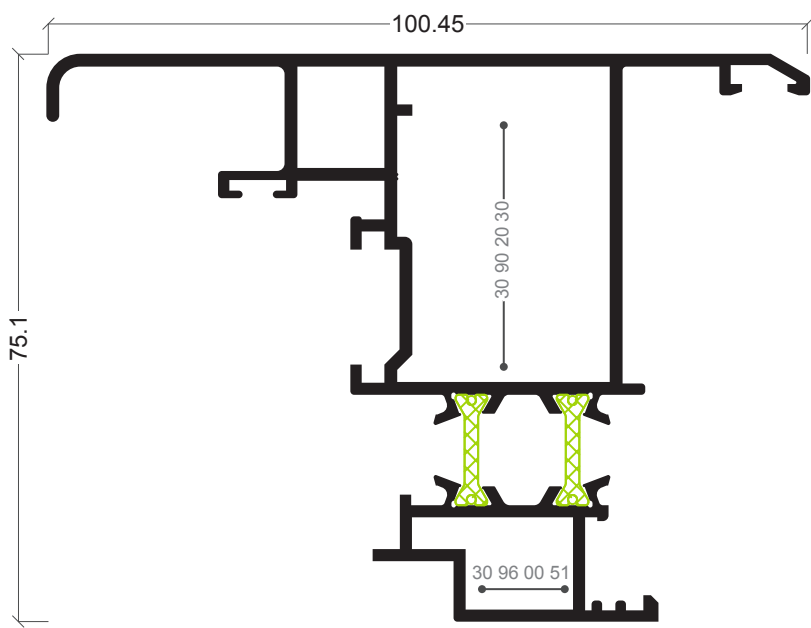

FL-64
Aro móvel claraboia

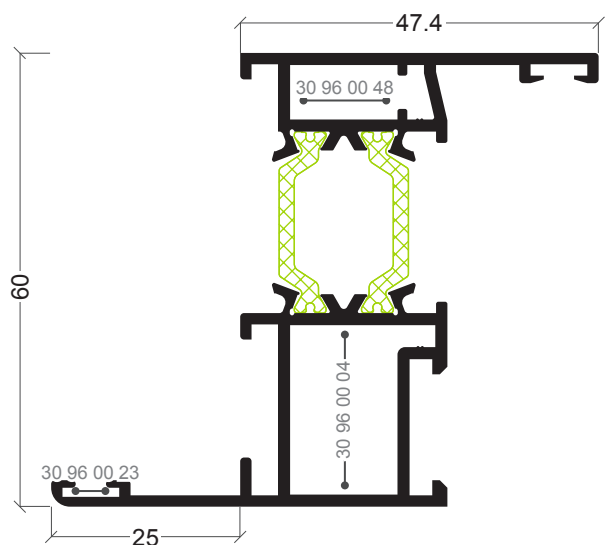

ARi-35
Aro fixo com remate 25 mm

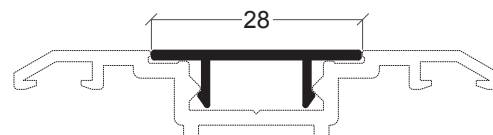

FL-66
Tampa

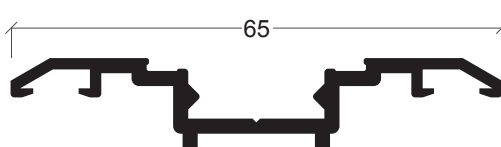

FL-44
Contra tampa

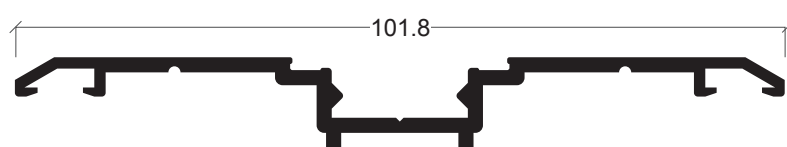

FL-59
Contra tampa (quinar em bruto)

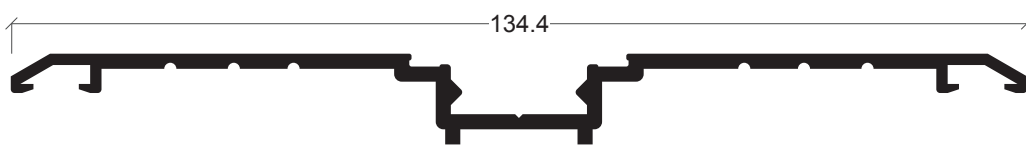

FL-67
Contra tampa (quinar em bruto)

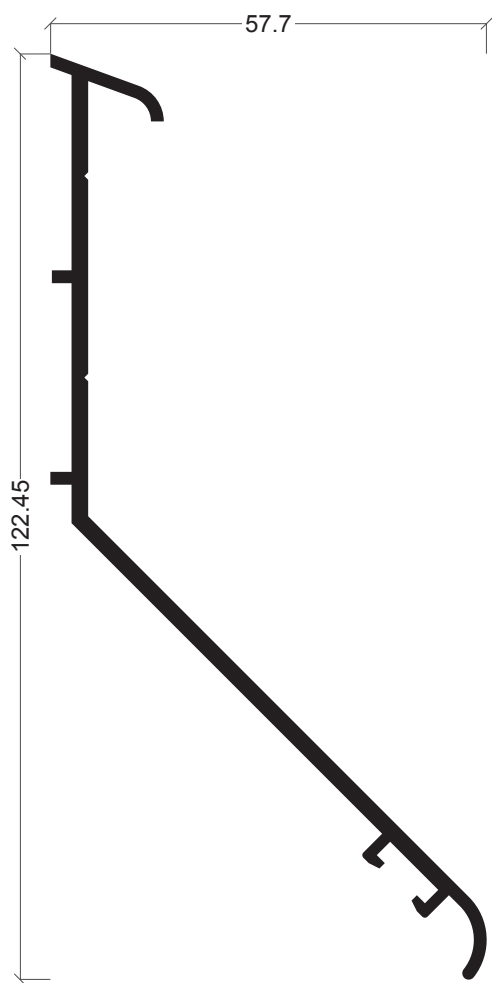

FL-63
Pingadeira superior



FL-62
Suporte montante basculante

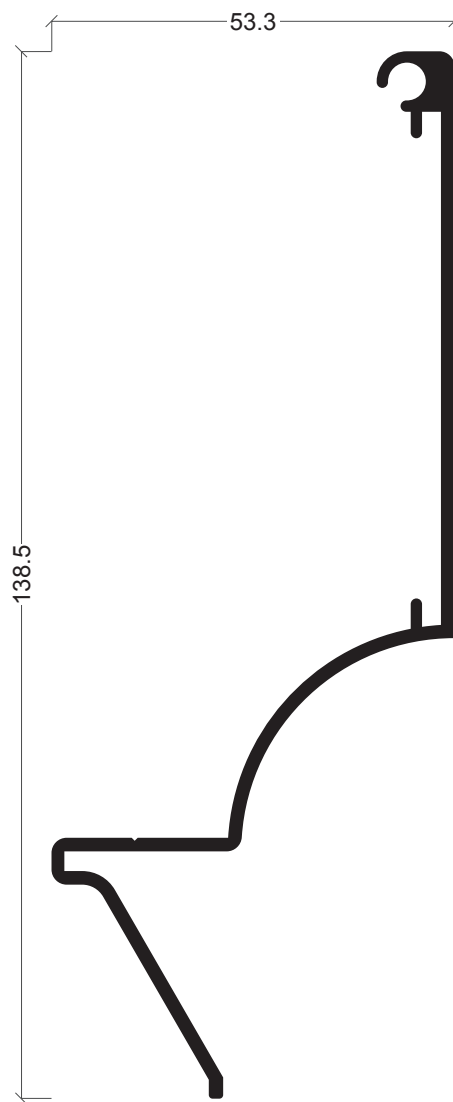

FL-58
Suplemento caleira

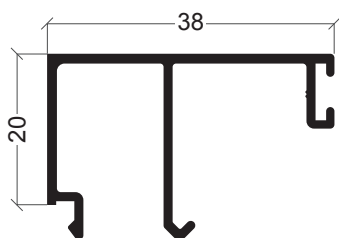

AX-32
Bite

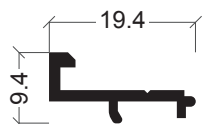

ARi-29
Apoio bite



FL-61
Porta basculante superior

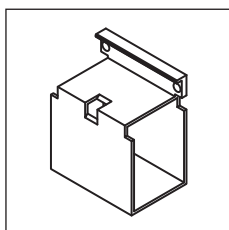

30 00 90 66

Topo travessas

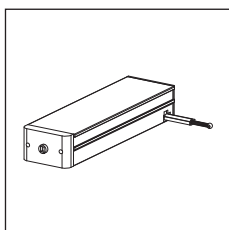

30 00 95 75

Motor abertura exterior
(60 kg - L < 1.4 mt)

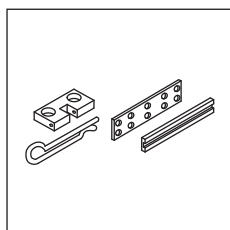

30 00 95 77

Conjunto de transmissão
projectante

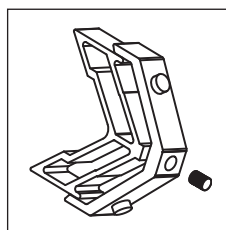

30 90 20 20

Esquadro aro fixo
claraboia

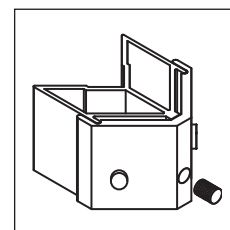

30 90 20 30

Esquadro aro móvel
claraboia

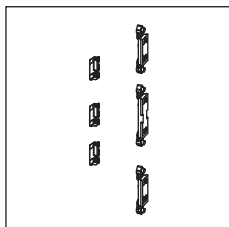

30 90 20 40

Transmissão abertura
claraboia

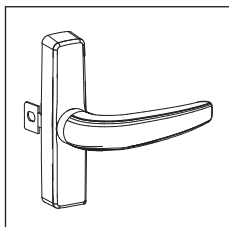

30 90 20 50

Puxador claraboia

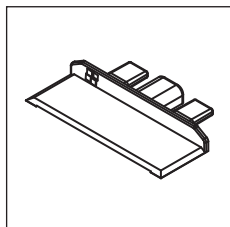

30 90 20 61

Topo de remate Ergolux
preto

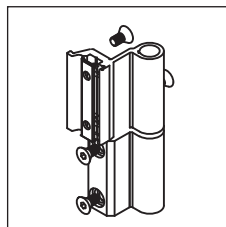

30 92 00 20/21

Dobradiça C.E. branco/
preto

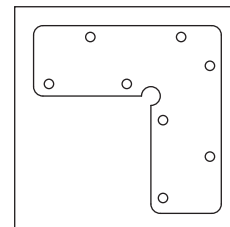

30 92 01 35

Esquadro alinhamento

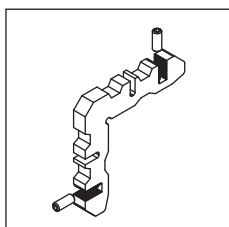

30 96 00 51

Esquadro de alinhamento
11.9 x 14 c/ parafusos

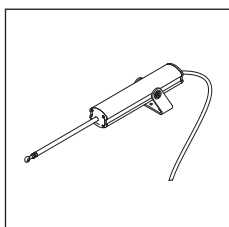

31 15 10 84

Motor eléctrico pistão
(80 kg - L < 1.5 mt)

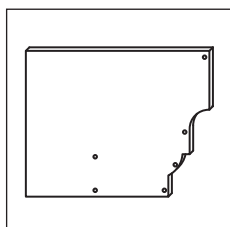

31 90 20 10

Topo para caleira em
alumínio

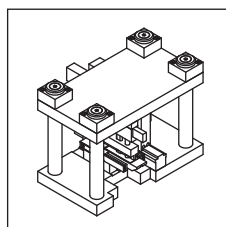

33 23 19 99

Cunho XP

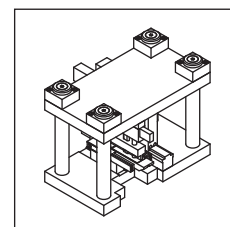

33 96 87 99

Cunho esquadro interior
e exterior ARI/AKi

Referência	Desenho	Descrição
30 00 95 01	11	Junta interior montante Junta central montante e travessa
30 00 95 03		Junta central (montante e travessa)
30 00 95 05	5	Junta interior de travessa
30 00 95 06	7	Junta central montante e travessa
30 00 95 07	13	Junta central montante e travessa
30 00 95 08	15	Junta central montante e travessa
30 00 95 10		Junta de estanquidade travessa FL-42
30 00 95 76	9	Junta central montante e travessa
30 90 20 80		Junta exterior sistema ergolux
30 90 20 90		Junta remate superior seccionável
30 96 00 18		Junta para FL-65

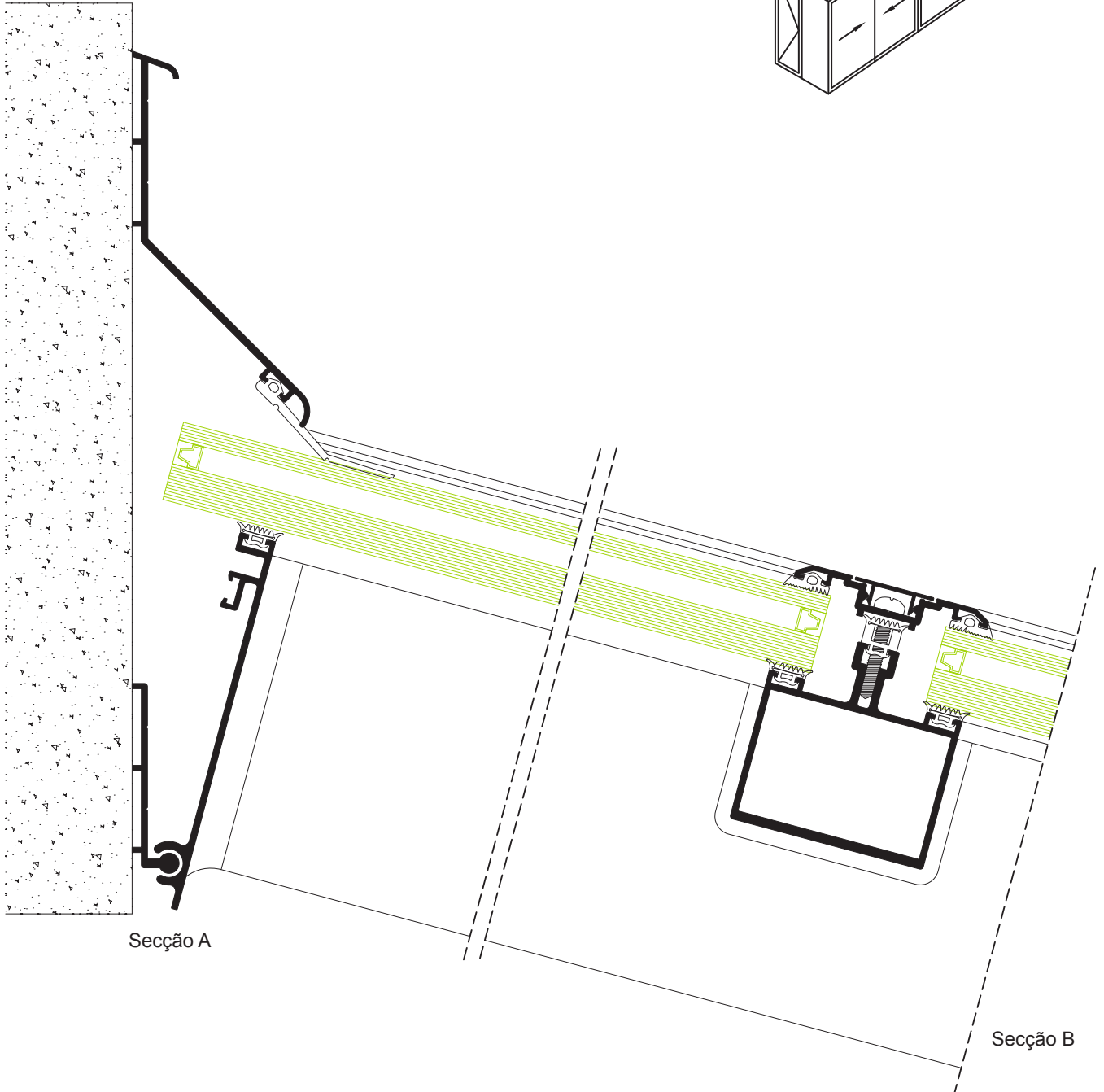
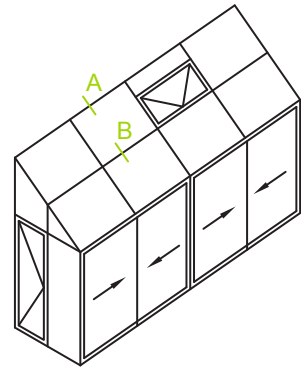

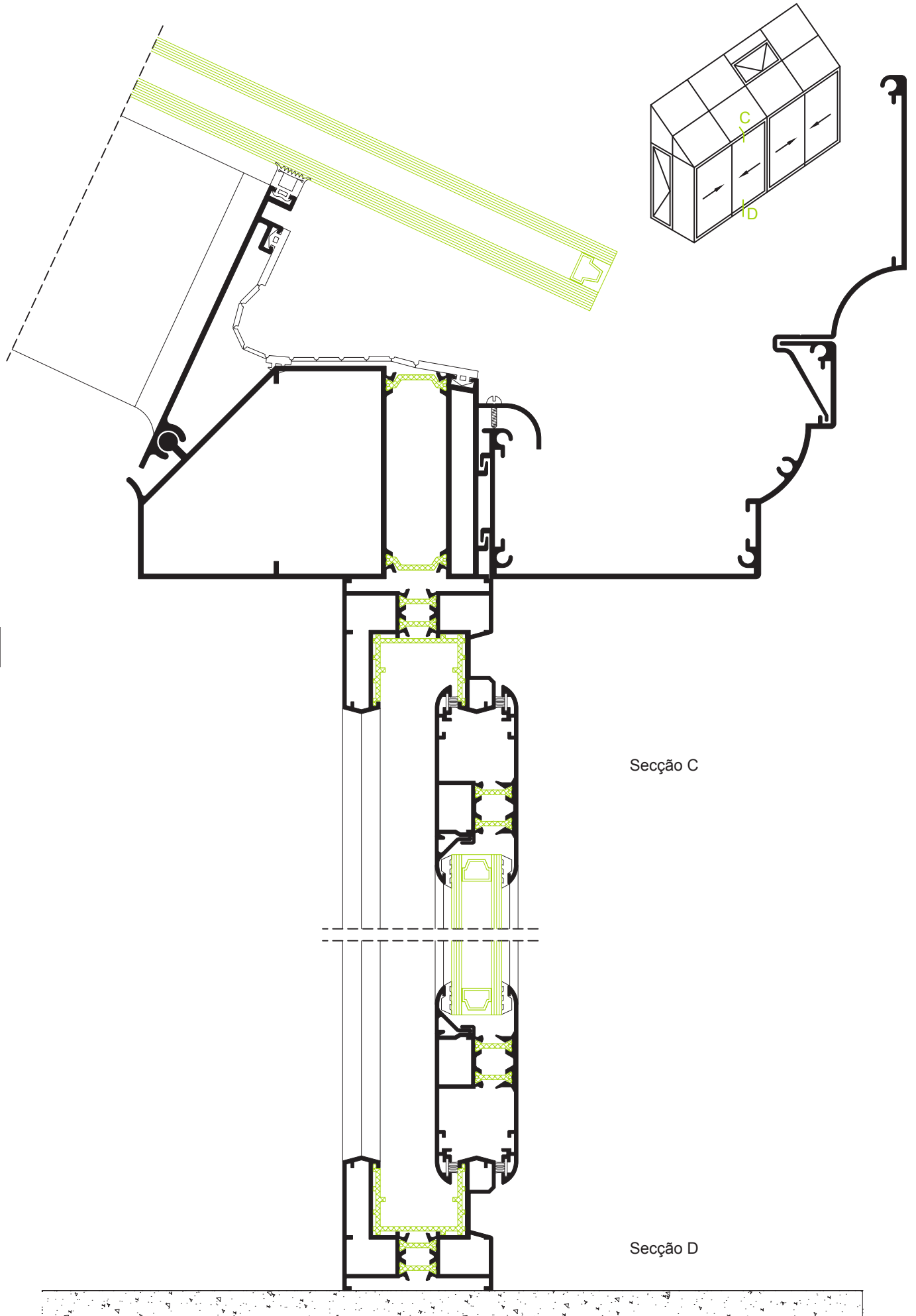

Seção C

Seção D

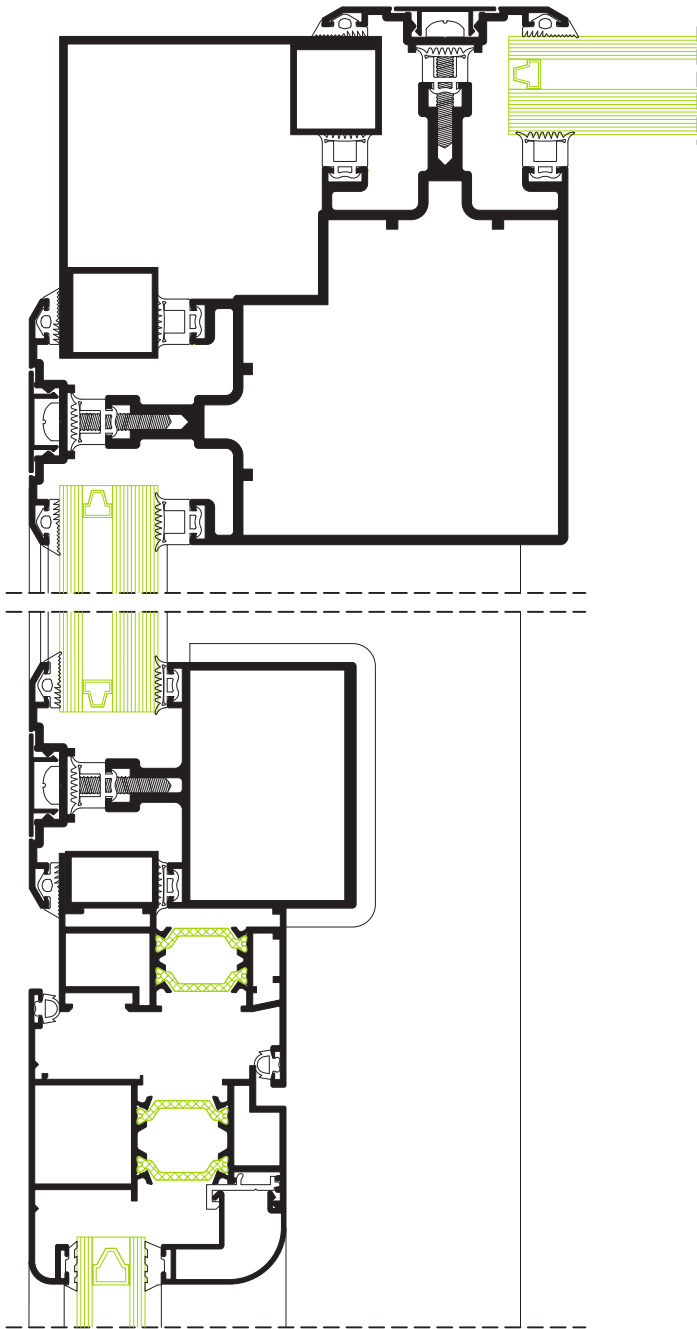

Secção E

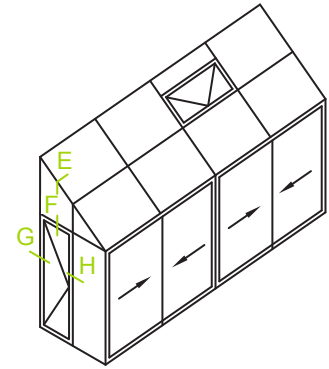

Secção F

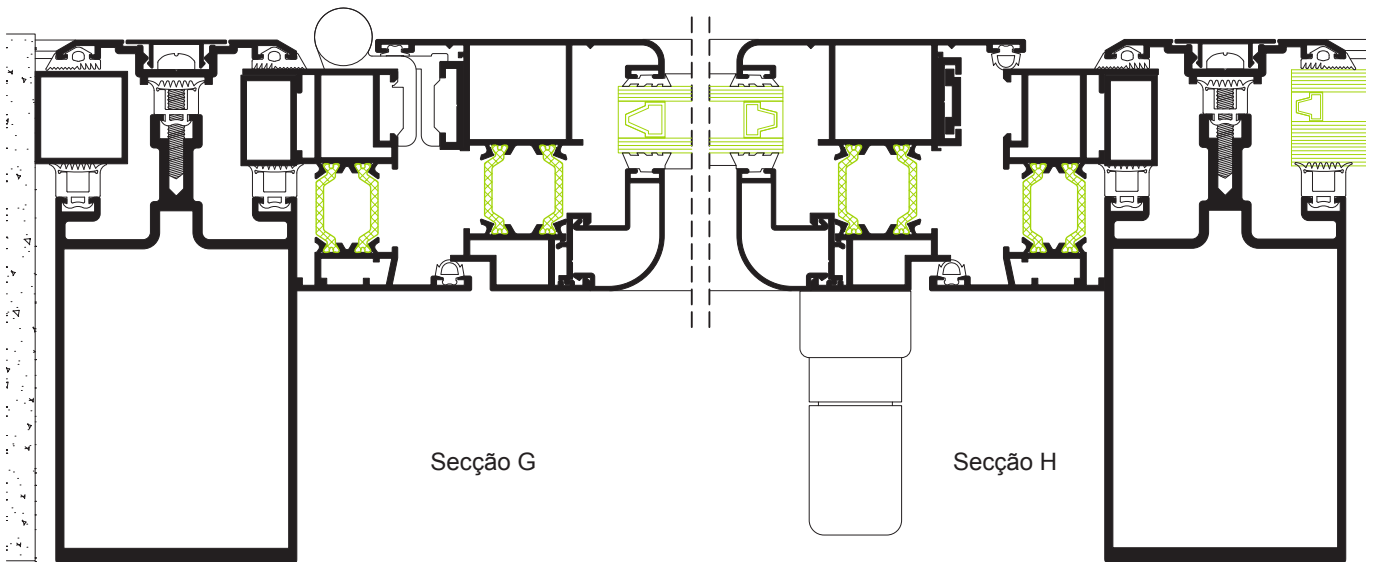

Secção G

Secção H

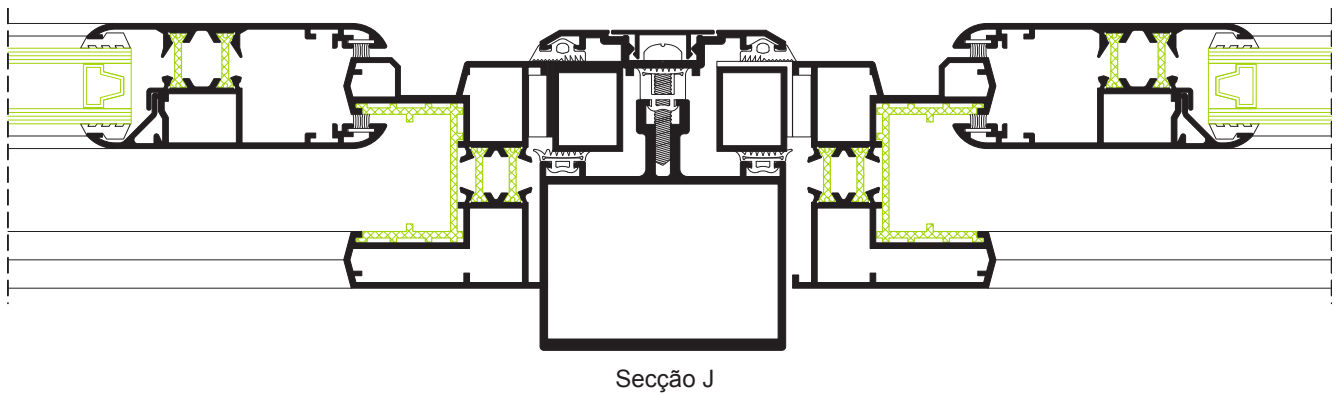
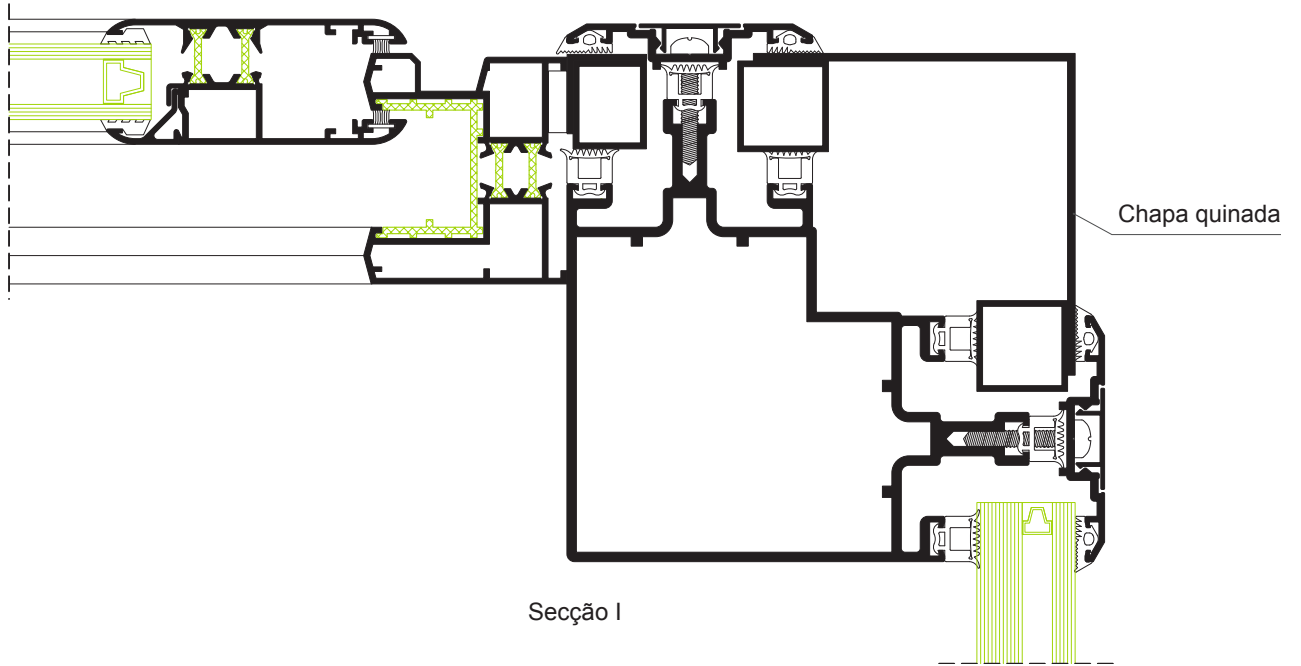
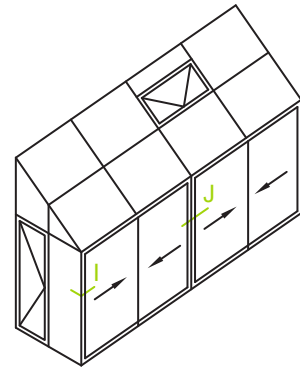

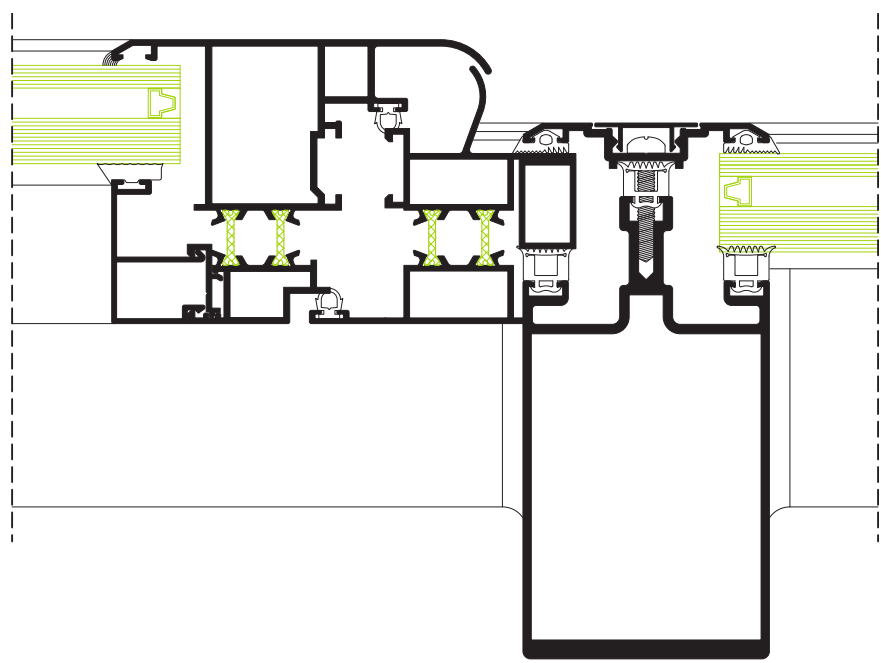
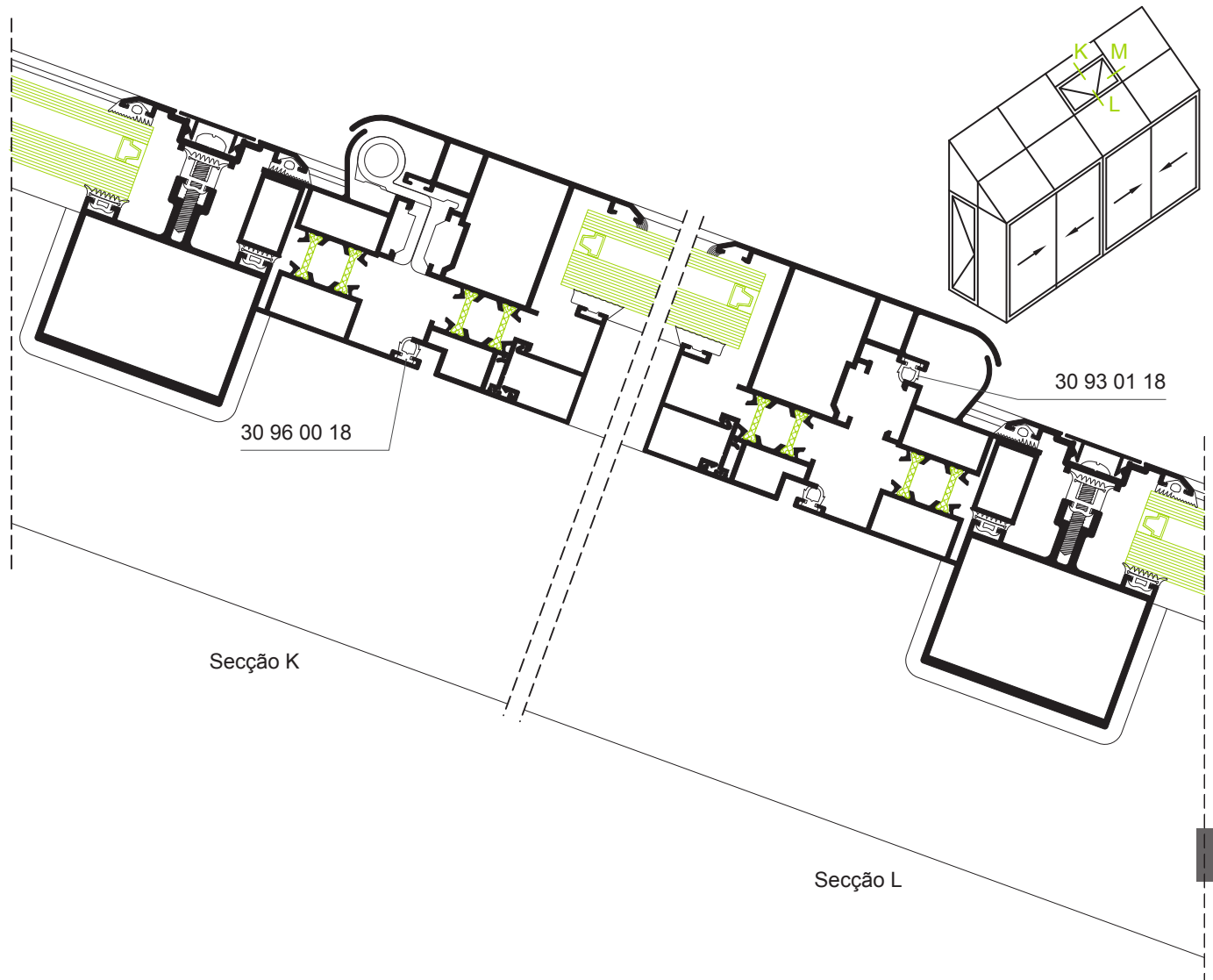

Secção M

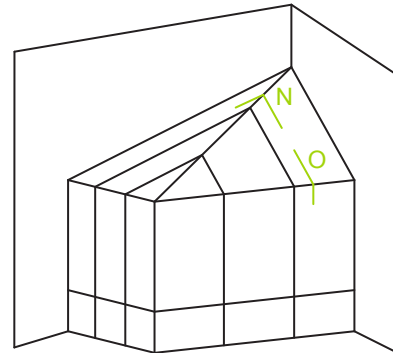

494

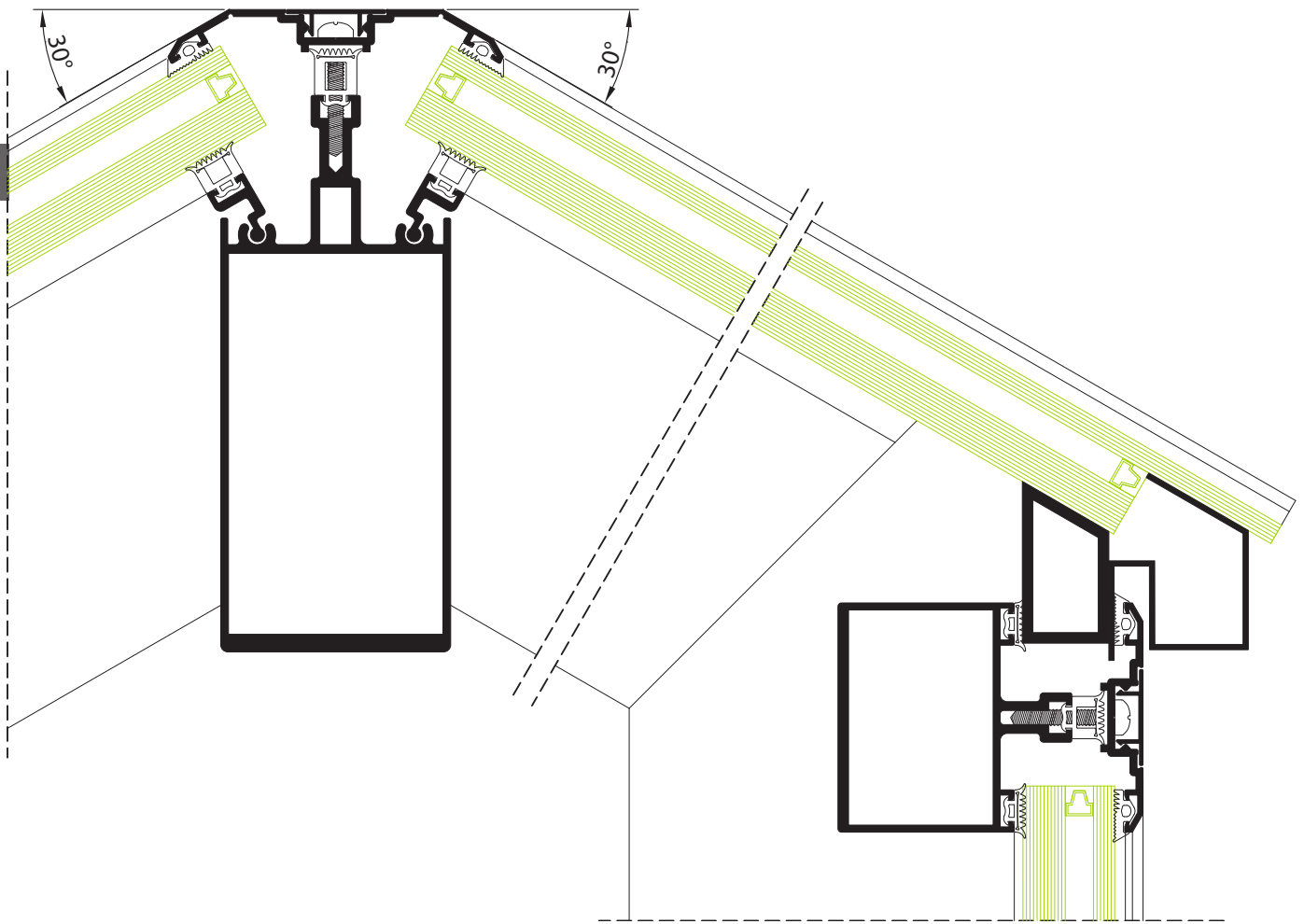

Secção N

Secção O

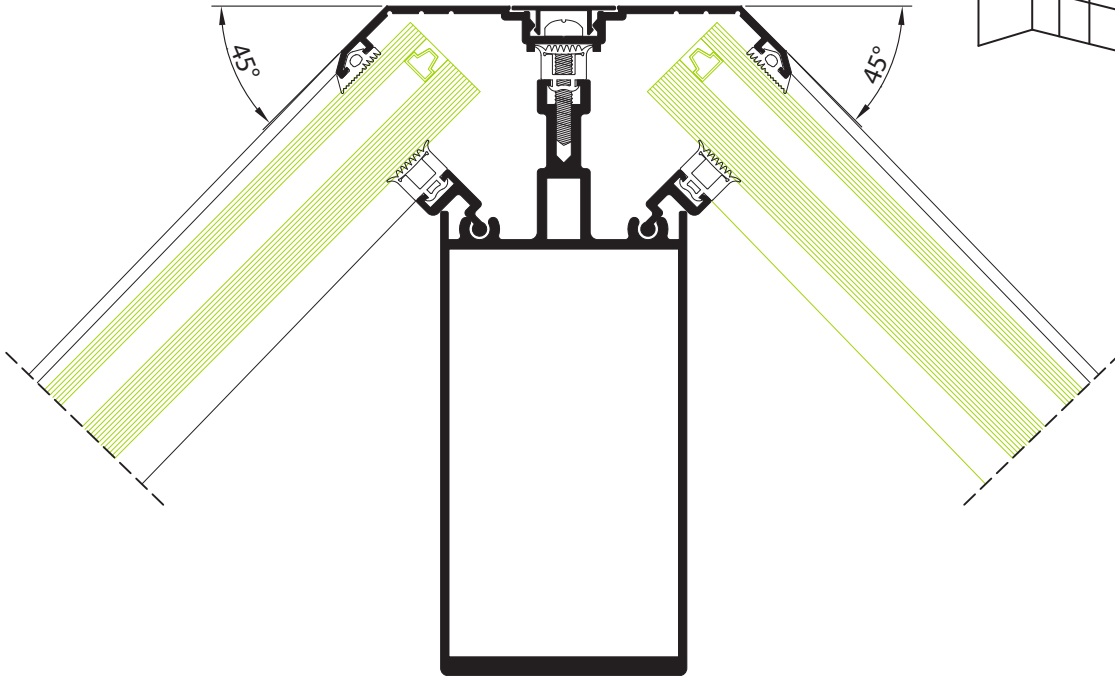
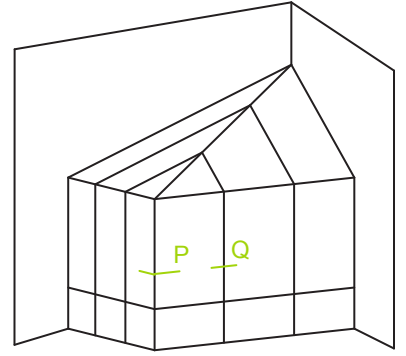

Secção P

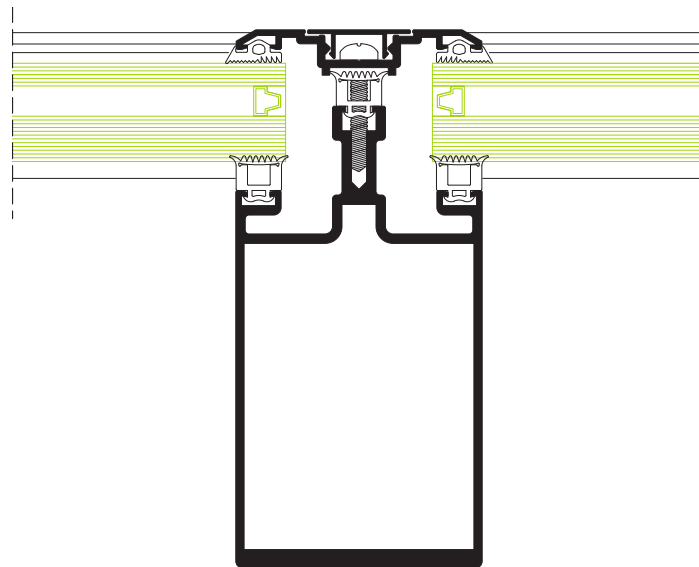

Secção Q

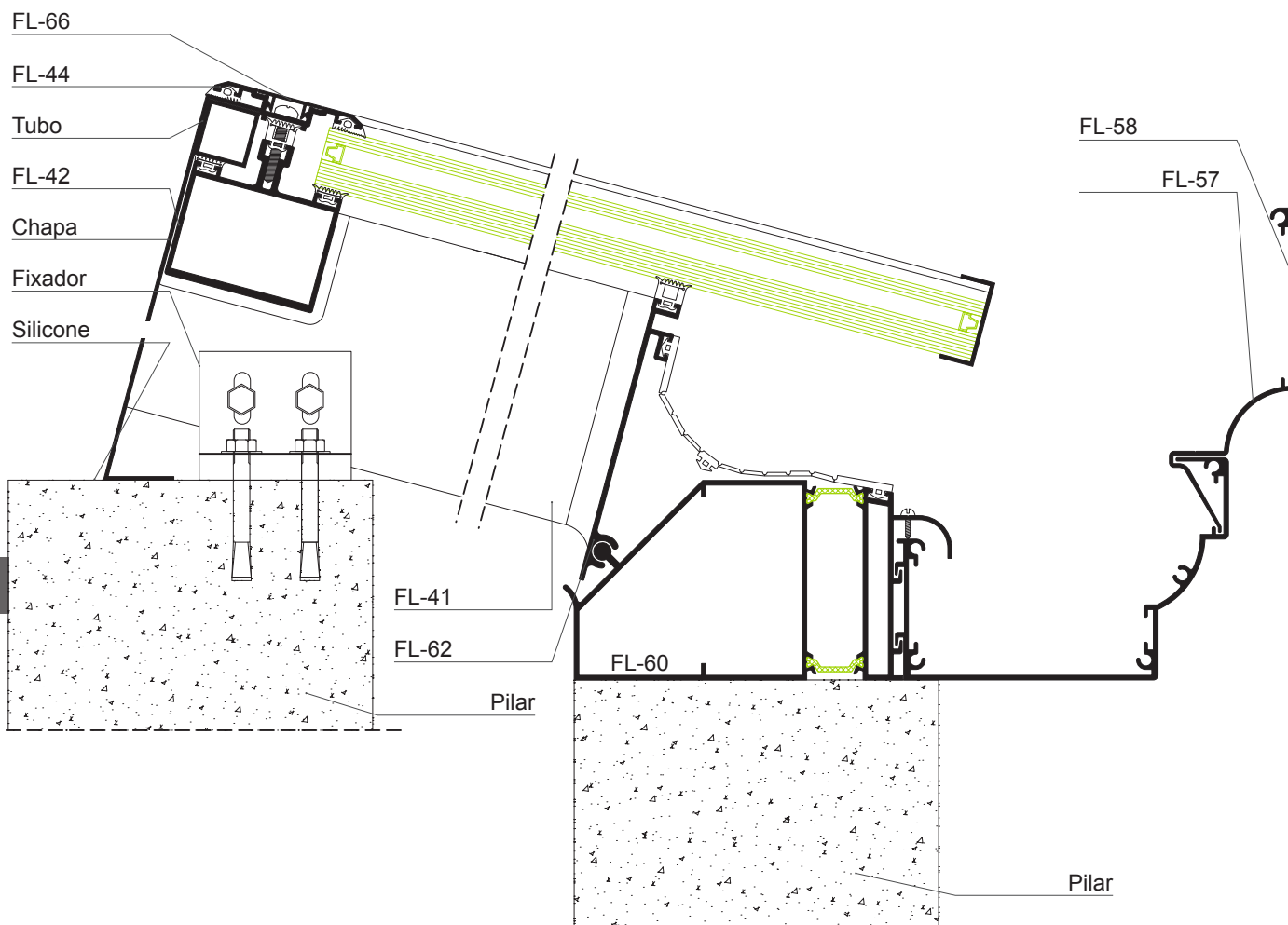

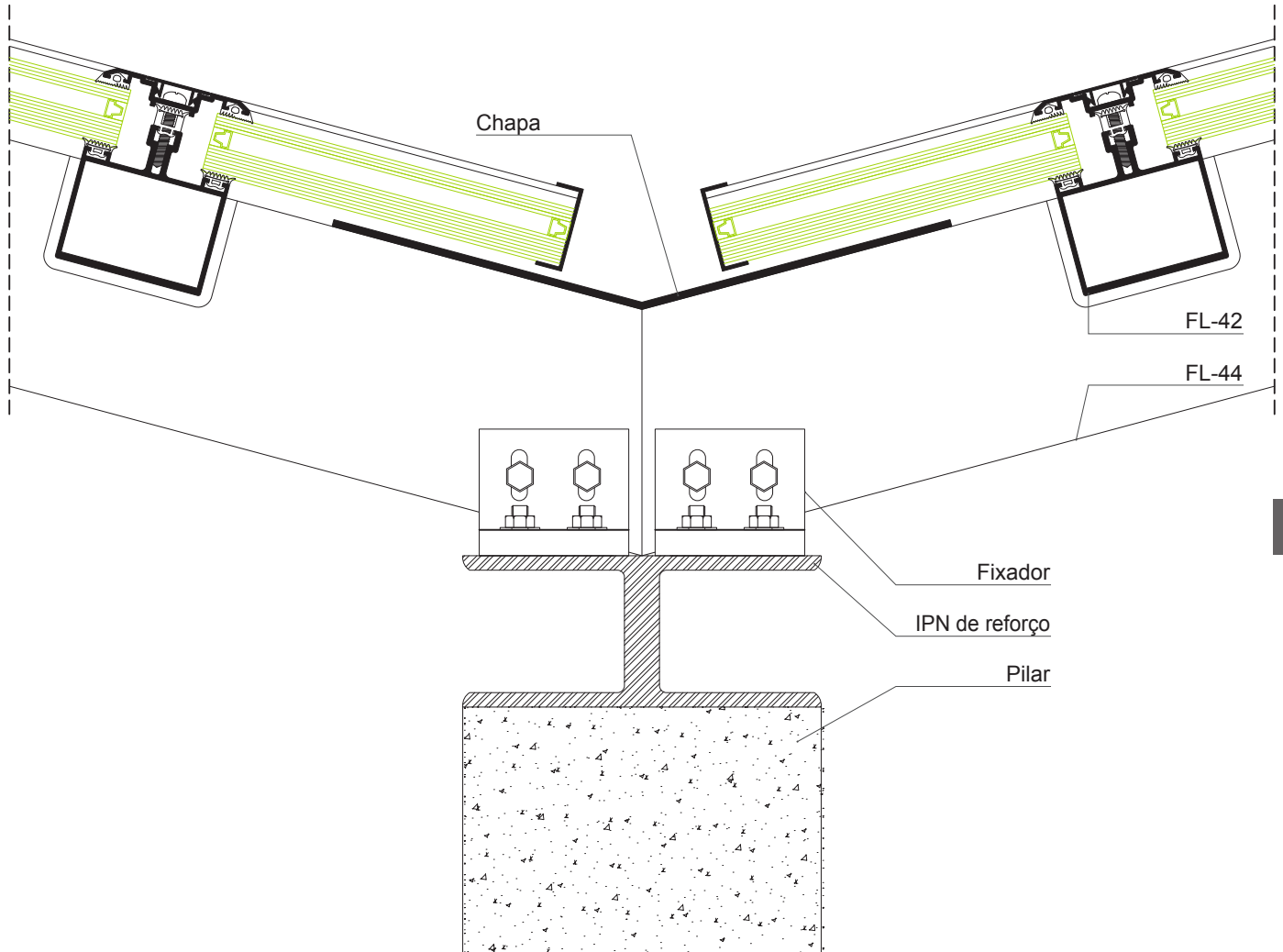

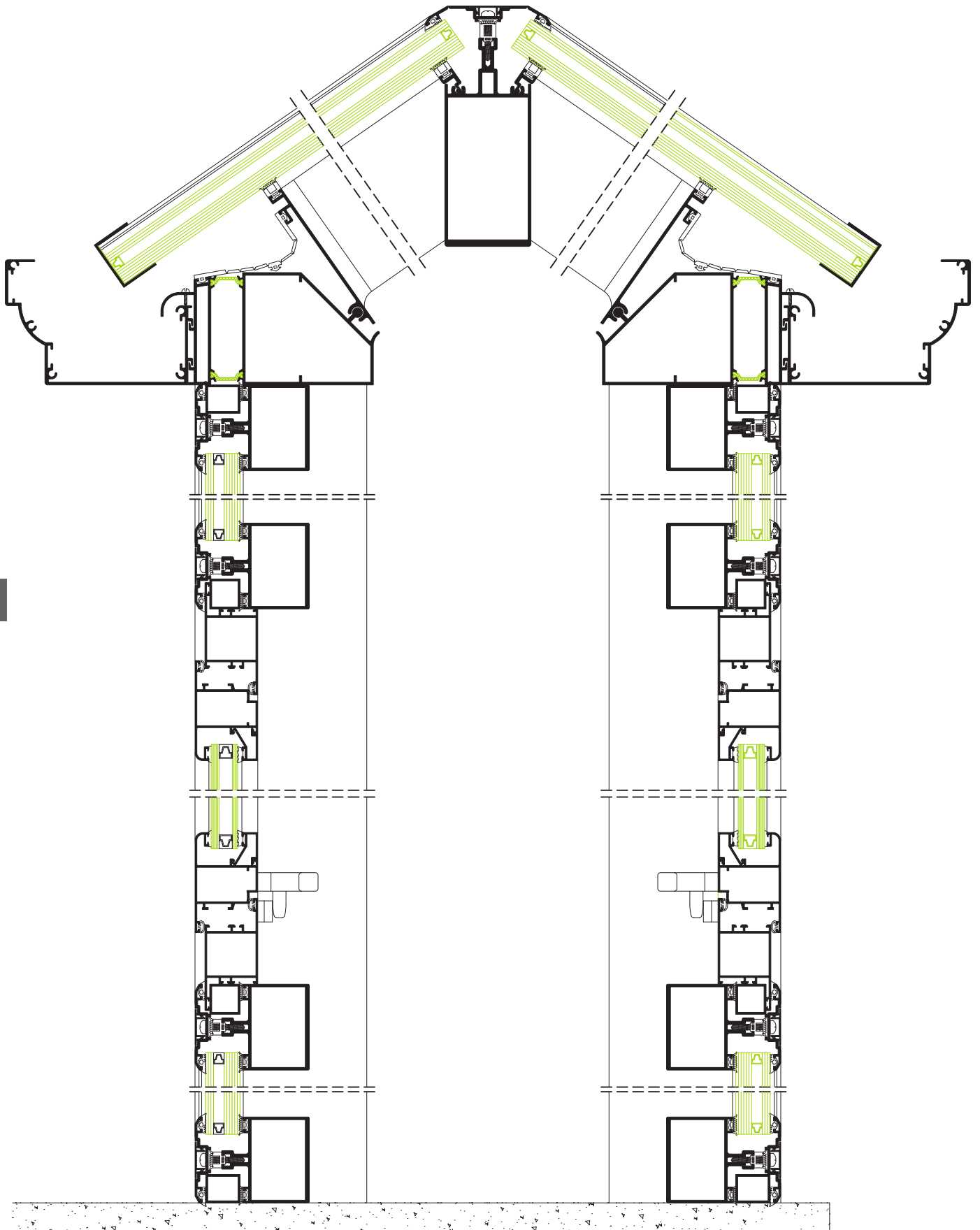

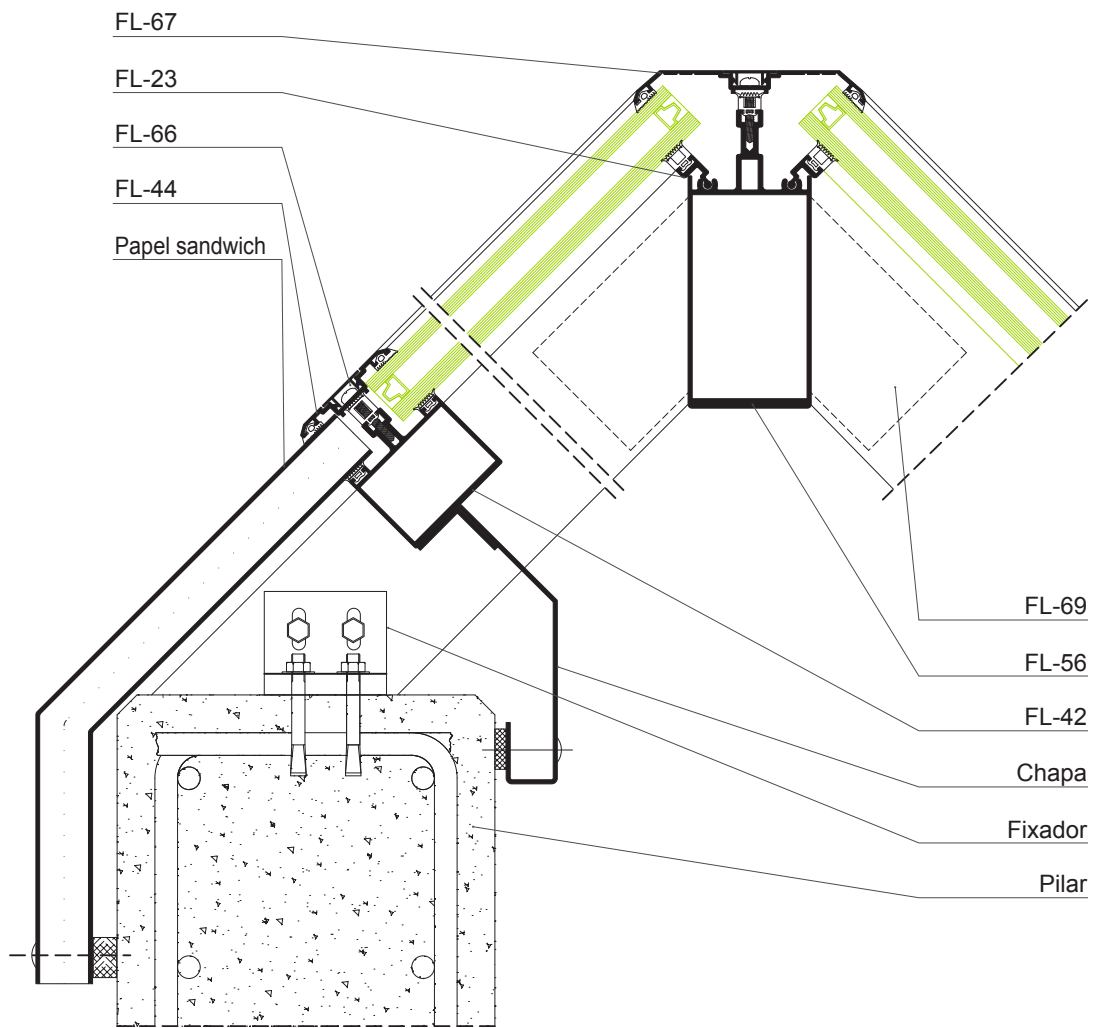

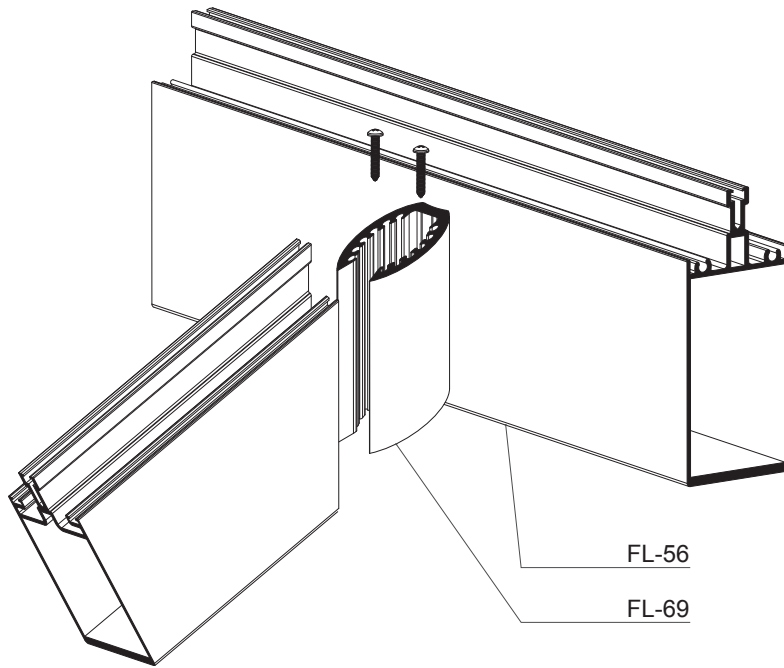

Pormenor I

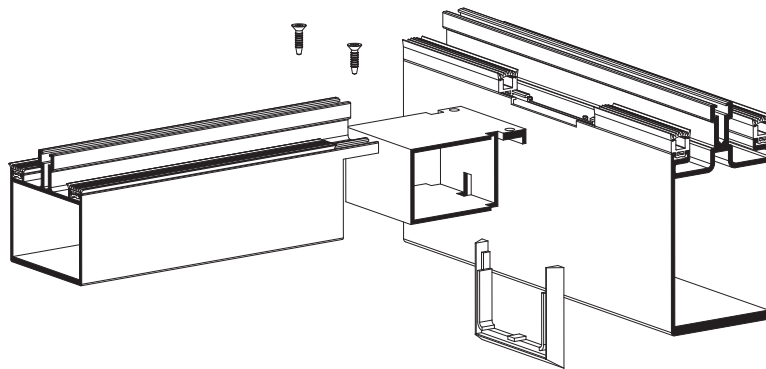

Pormenor II

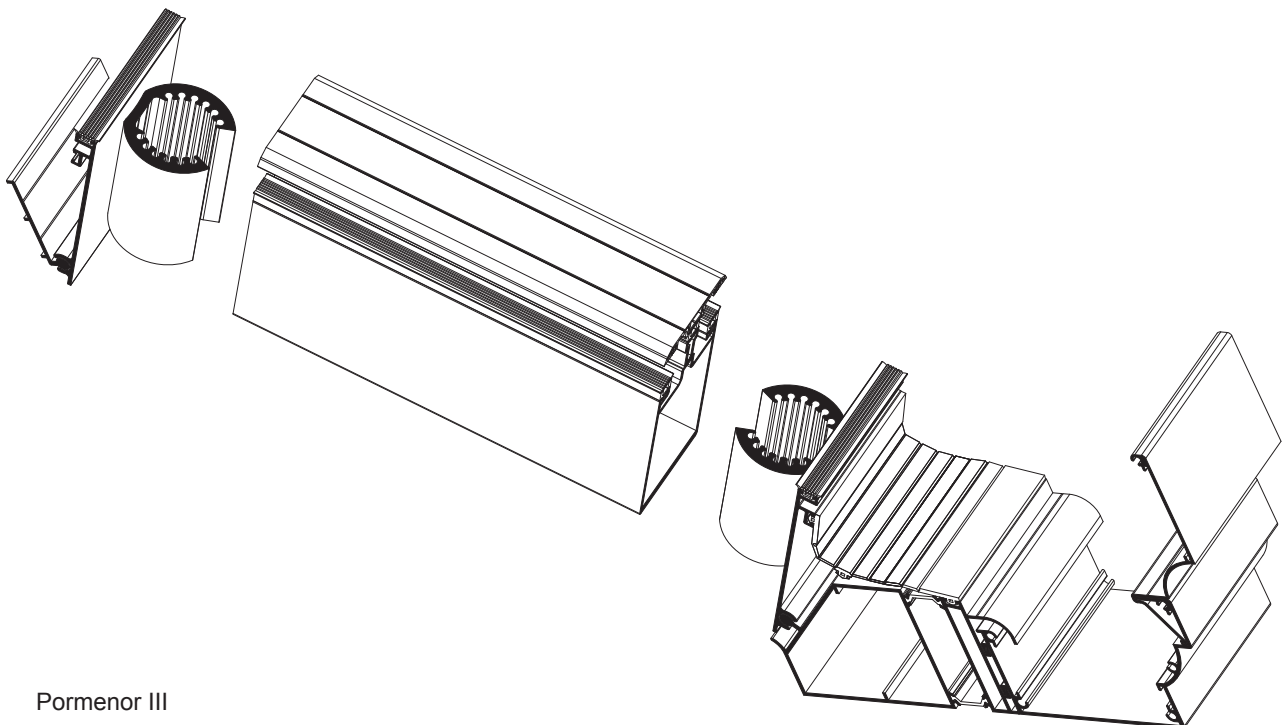

Pormenor III

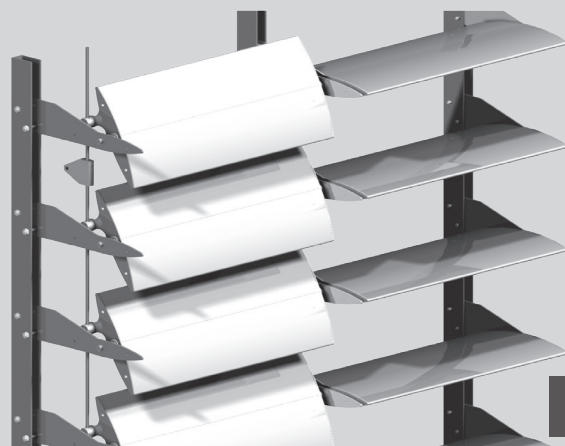
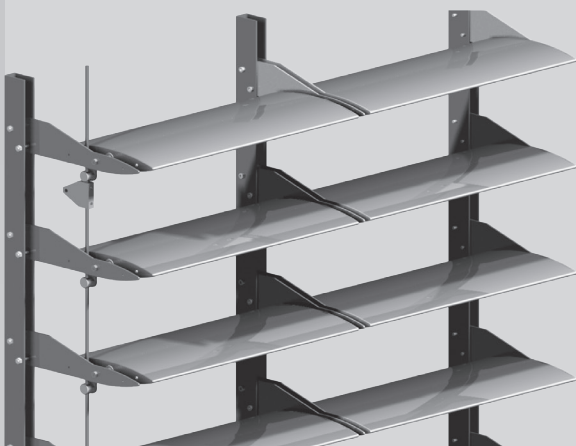
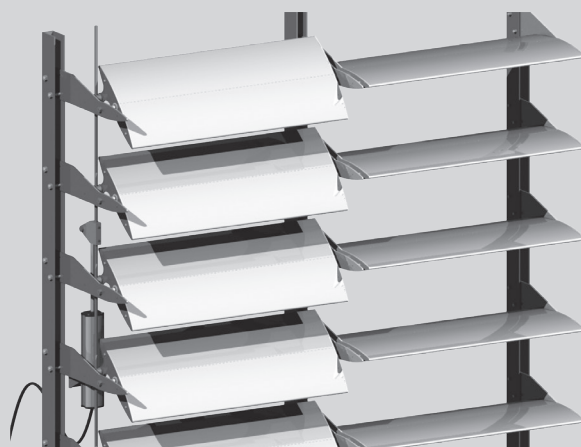
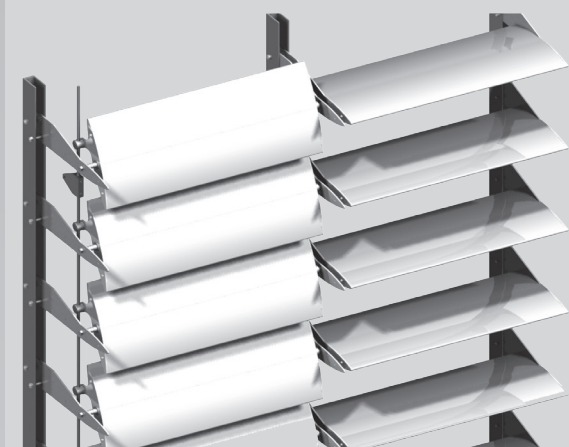

501

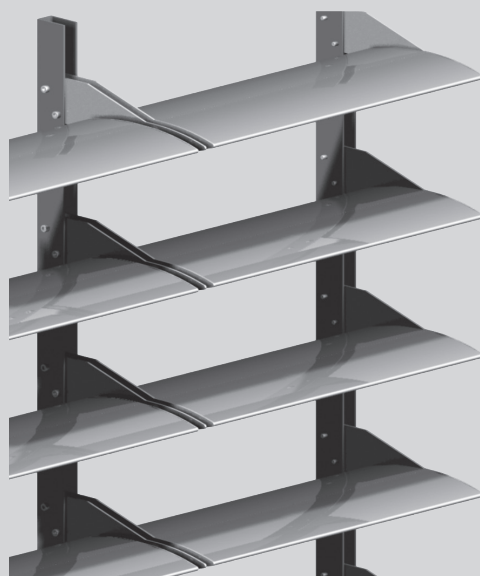

**Lâminas
Quebra Sol**

Lâminas Quebra Sol

Características

Sistemas de alumínio preparados para montagem sobre fachadas que visam fazer o efeito quebra sol apresentando ao mesmo tempo uma forma estética.

Permitem a montagem nas seguintes formas:

- lâminas fixas;
- lâminas móveis.

Os sistemas de lâminas móveis permitem um controle sobre a sua orientação através de um mecanismo manual ou motorizado em que ambos poderão ser comandados à distância. As lâminas quebra sol existem com as secções transversais de 120, 165, 250 e 345 mm com uma espessura média dos perfis de alumínio de 1.5 mm.

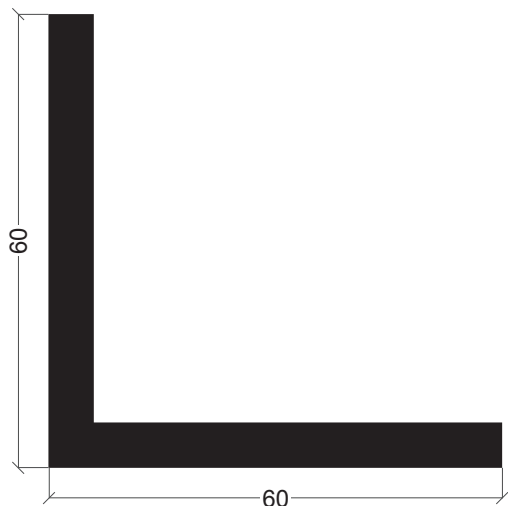

L-25



G-01

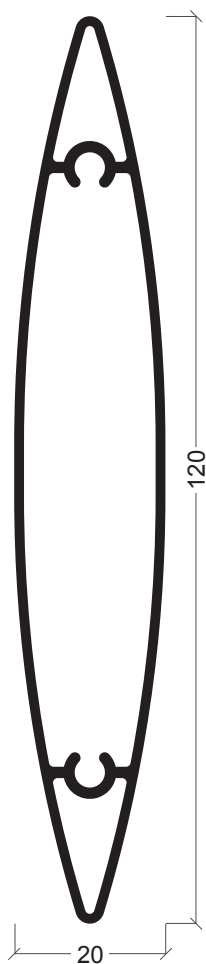

Z-58

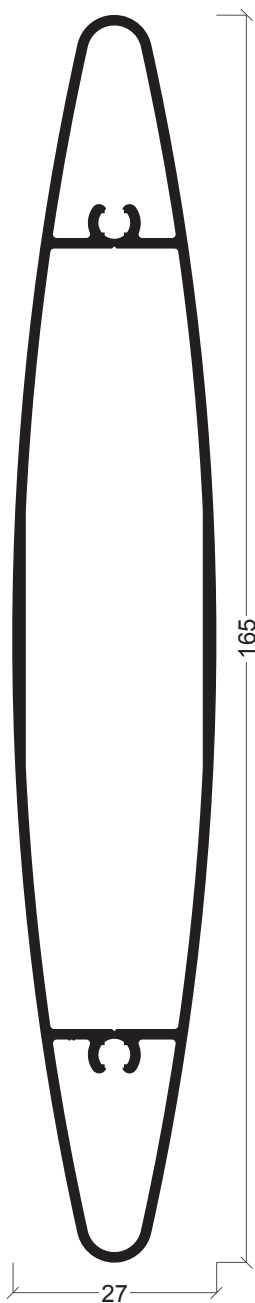

Z-68

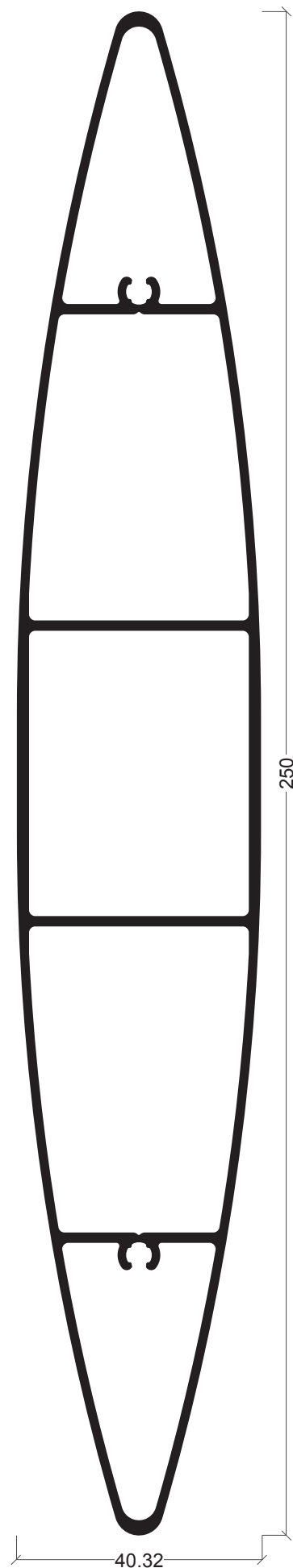

Z-62

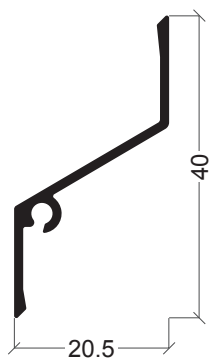

Z-26

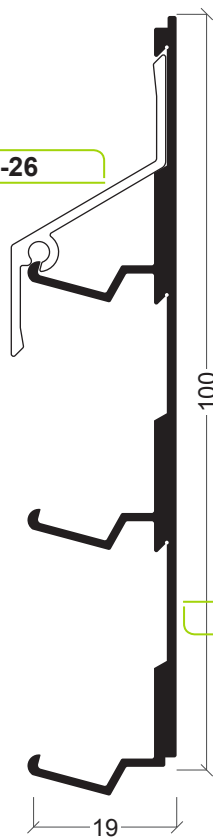

Z-25 + Z-26

Z-26

Z-25

504

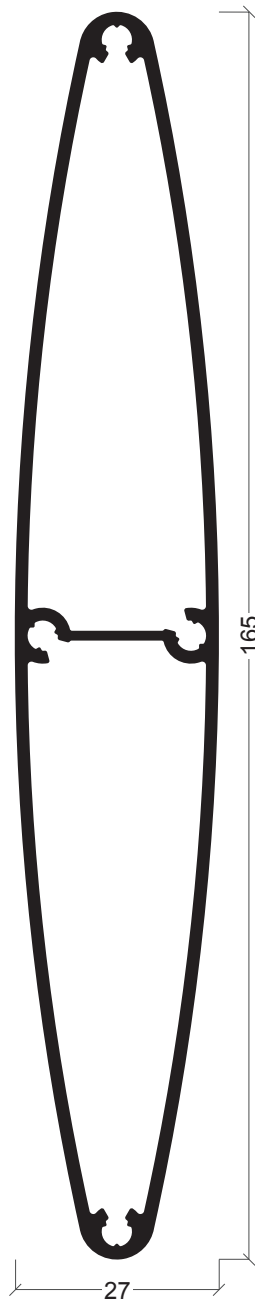

Z-64 (lâmina fixa)



Z-65 + Z-65

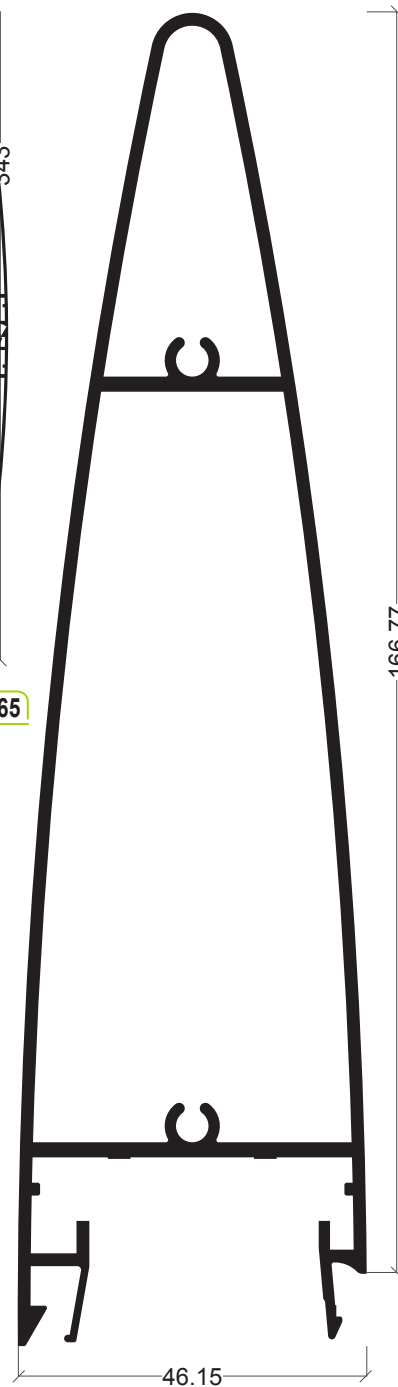

Z-65

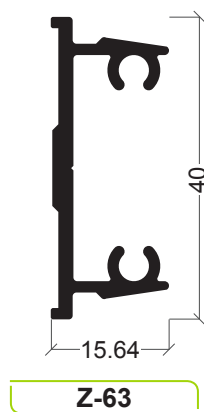
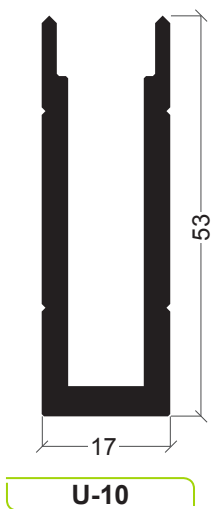
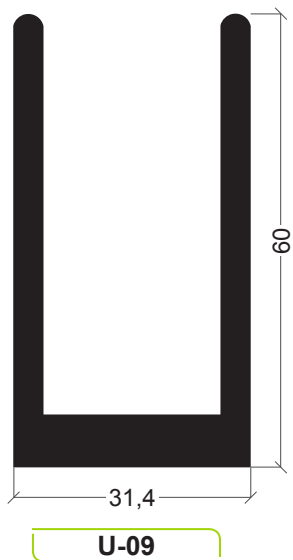
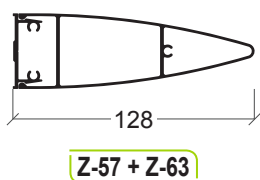
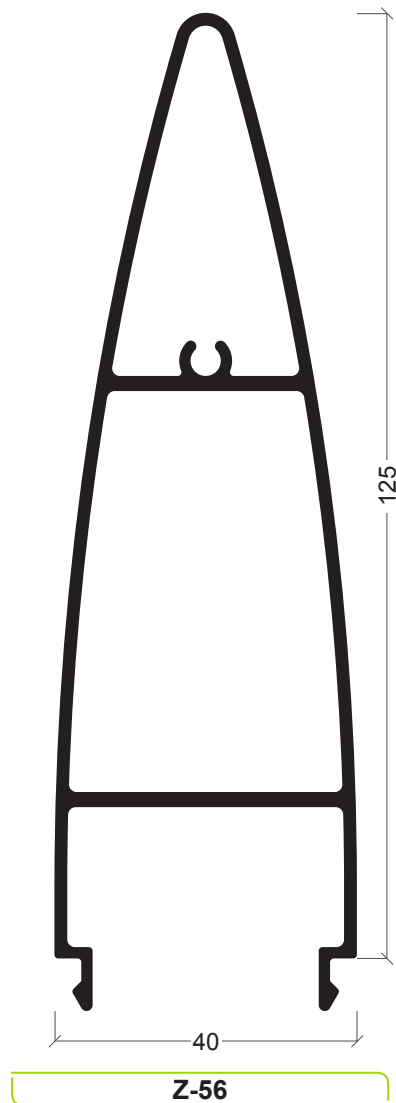
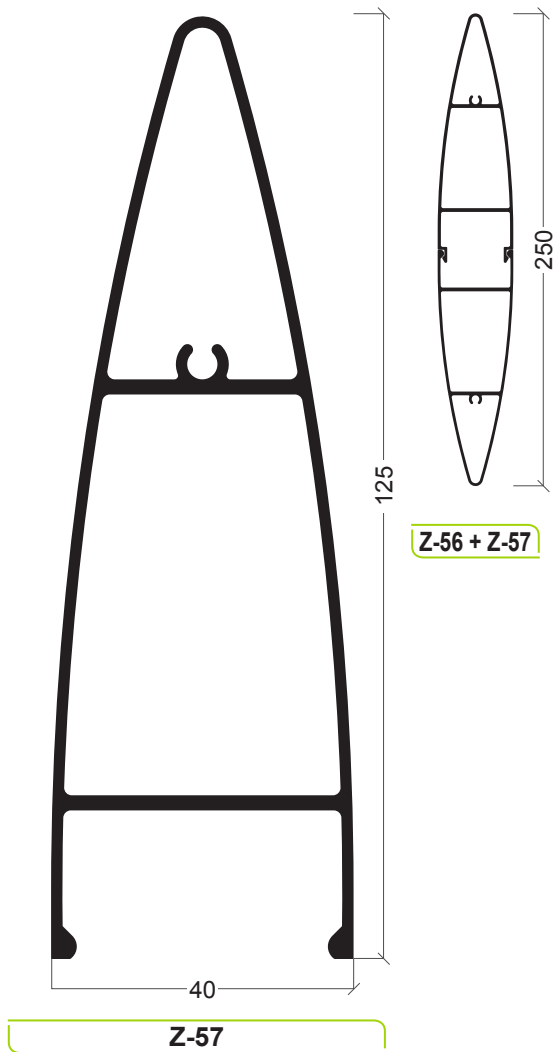

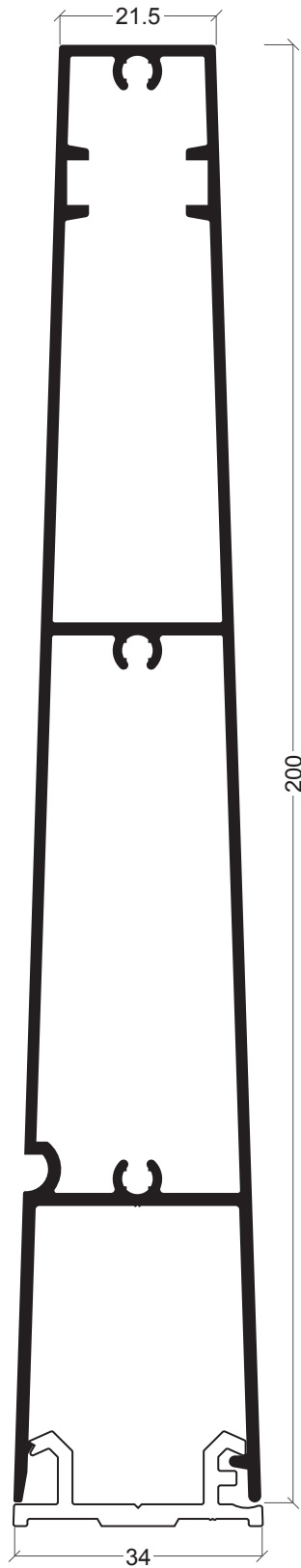

Z-67

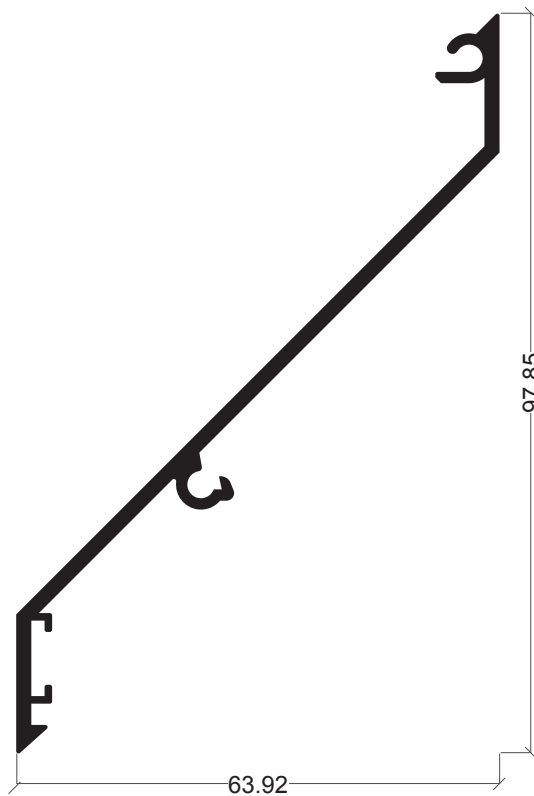

Z-24

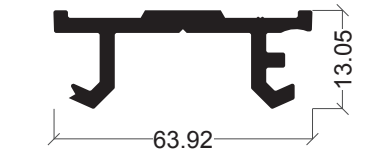

Z-66

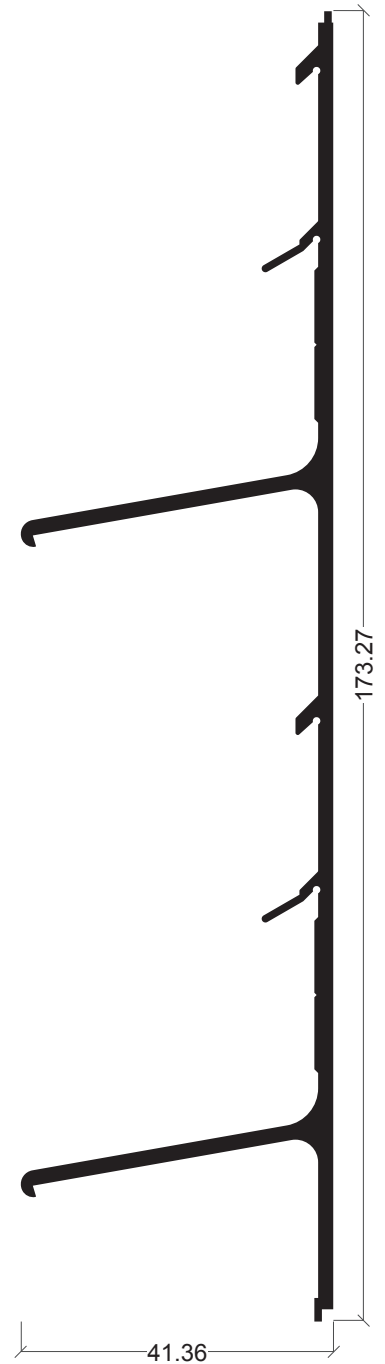

Z-23

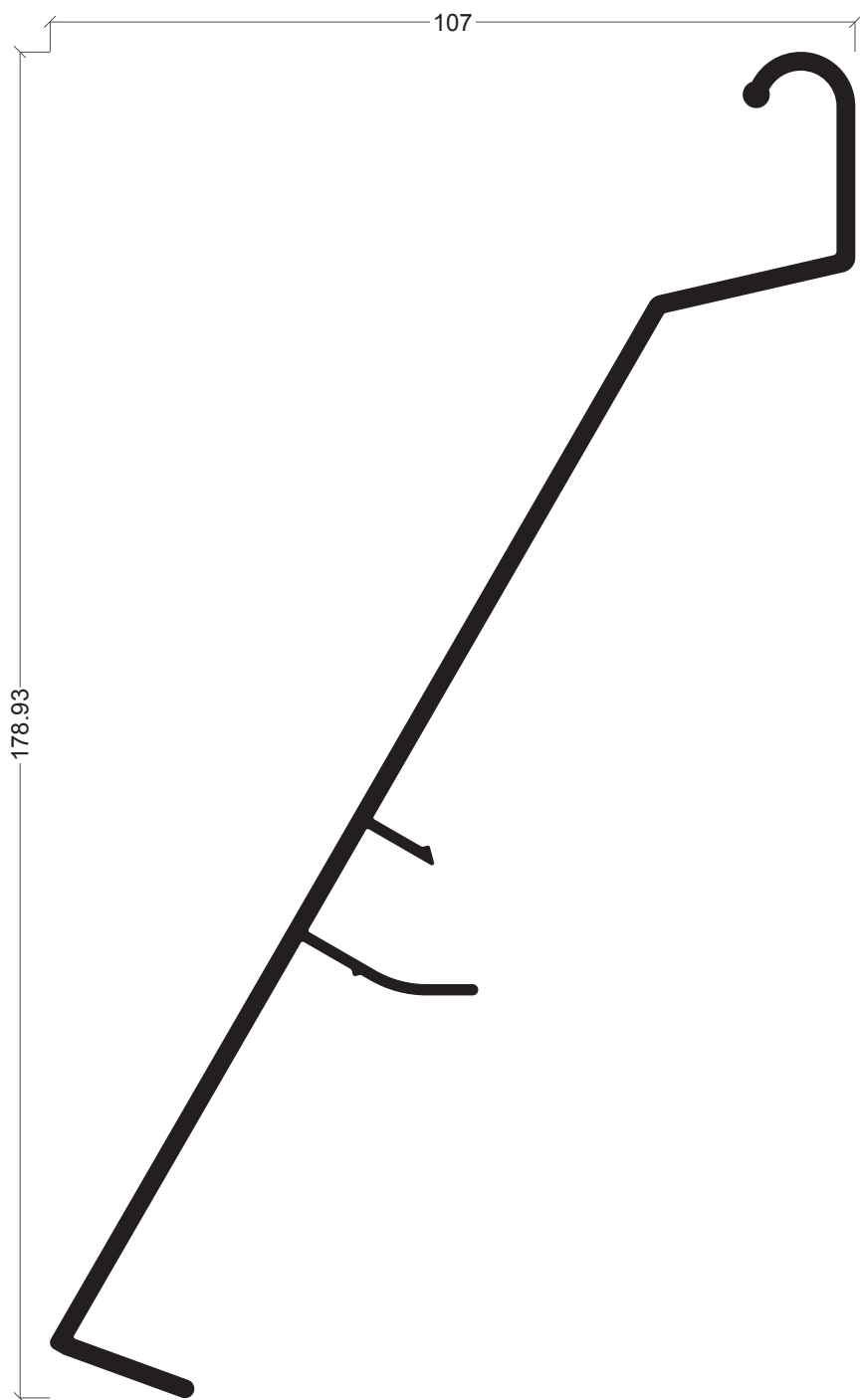

Z-43

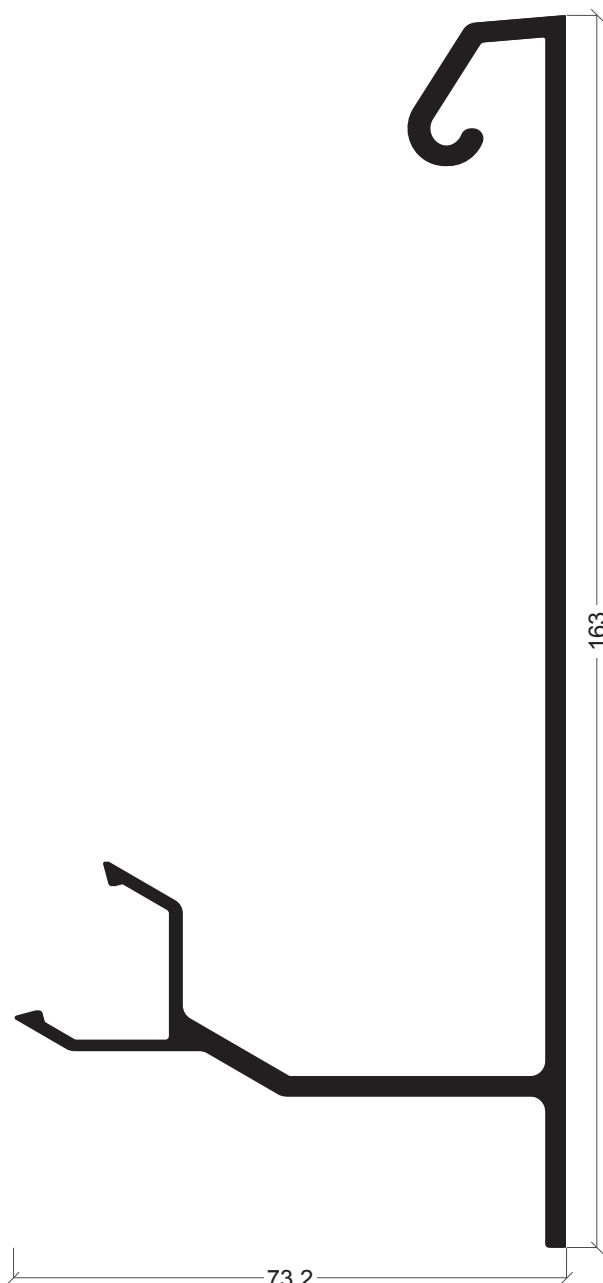

Z-42

507

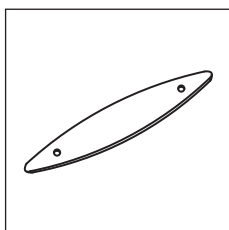

31 15 00 40
Topo simples 250 mm

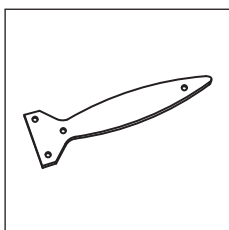

31 15 00 42
Topo fixação 120 mm

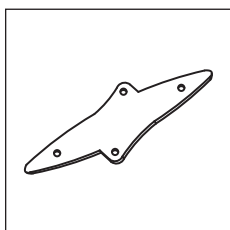

31 15 00 63
Topo fixação central 120 mm

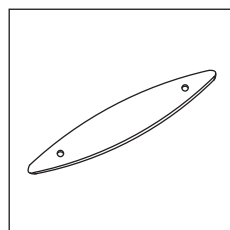

31 15 00 67
Topo simples 120 mm

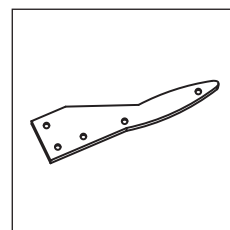

31 15 00 71
Topo fixação alongado 120 mm

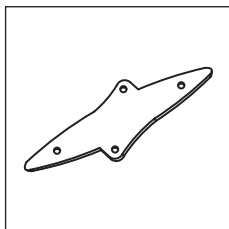

31 15 00 75
Topo fixação central 250 mm

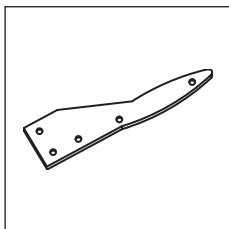

31 15 00 79
Topo fixação alongado 250 mm

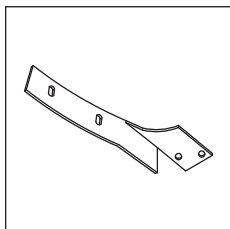

31 15 00 84
Suporte central 250 mm direito

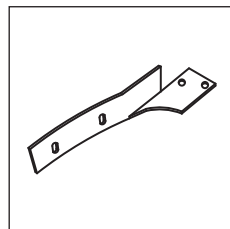

31 15 00 85
Suporte central 250 mm esquerdo

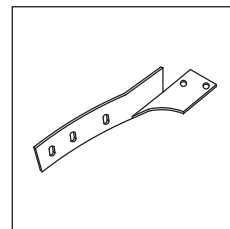

31 15 00 86
Suporte central 343 mm esquerdo

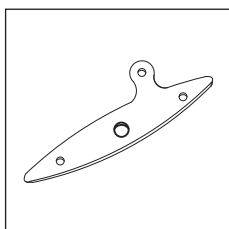

31 15 01 01
Topo lateral lâmina móvel 120 mm

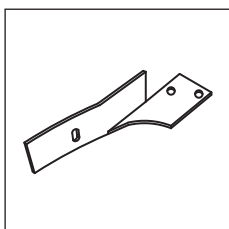

31 15 01 08
Suporte central 120 mm esquerdo

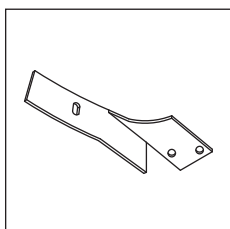

31 15 01 09
Suporte central 120 mm direito

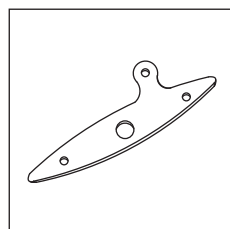

31 15 01 12
Topo lateral lâmina móvel 250 mm

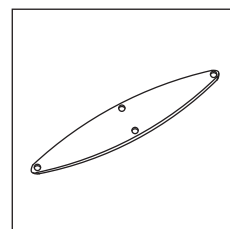

31 15 01 15
Topo simples 165 mm (Z-64)

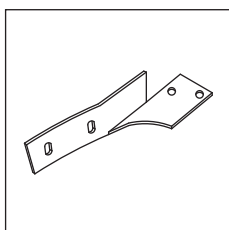

31 15 01 16
Suporte central 165 mm esquerdo

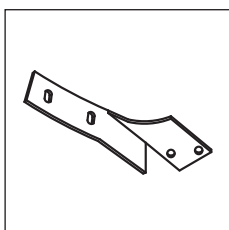

31 15 01 17
Suporte central 165 mm direito

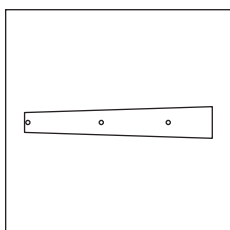

31 15 01 35
Topo para lâmina Z-67

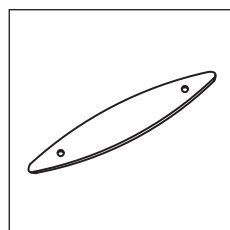

31 15 01 36
Topo simples 343 mm

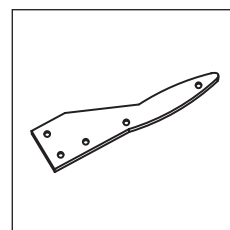

31 15 01 40
Topo fixação alongado 343 mm

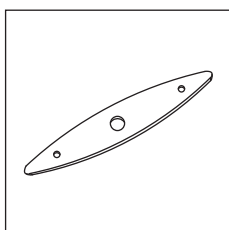

31 15 01 42
Topo lateral lâmina móvel 120 mm

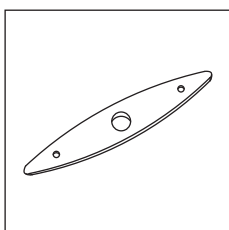

31 15 01 43
Topo lateral lâmina móvel 343 mm

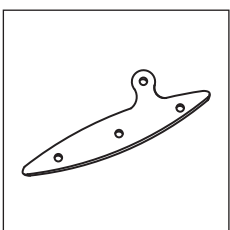

31 15 01 44
Topo lateral lâmina móvel 343 mm

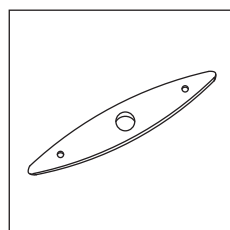

31 15 01 46
Topo lateral lâmina móvel 250 mm

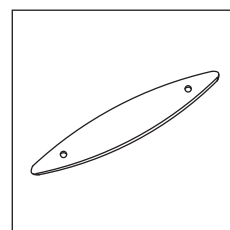

31 15 01 51
Topo simples 165 mm (Z-68)

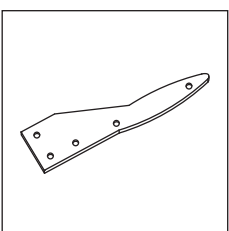

31 15 01 56
Topo fixação alongado 165 mm (Z-68)

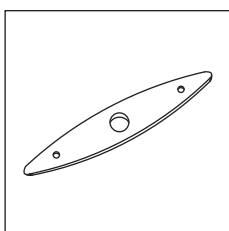

31 15 01 60
Topo lateral lâmina móvel 165 mm (Z-68)

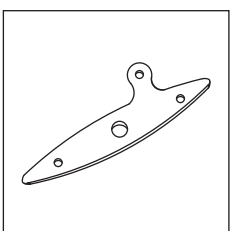

31 15 01 61
Topo lateral lâmina móvel com aba 165 mm (Z-68)

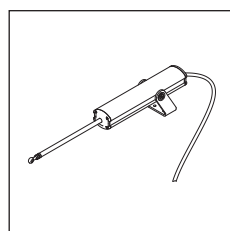

31 15 10 84
Motor eléctrico

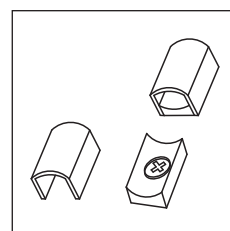

31 15 11 00
Presilha

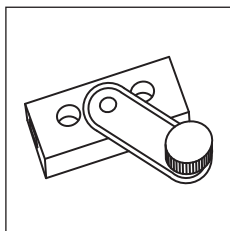

31 15 11 02

Manivela comando manual

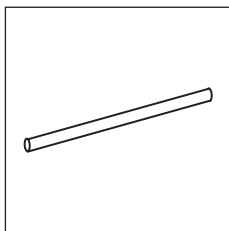

31 15 11 03

Tubo alumínio (3 mts)

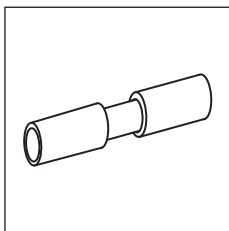

31 15 11 04

União de tubos

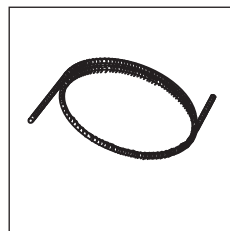

31 15 11 12

Bicha comando manual

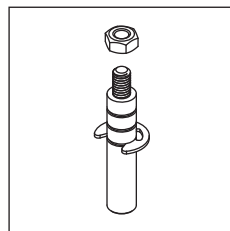

31 15 11 24

Eixo superior lâmina (Z-58 ou Z-68)

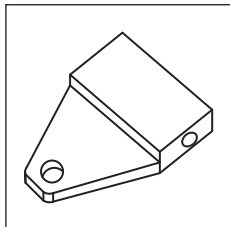

31 15 11 25

Ligação sistema eléctrico ou manual

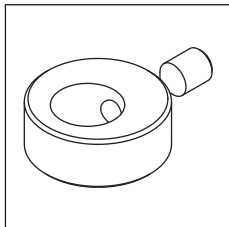

31 15 11 26

Anel freio lâmina (Z-58 ou Z-68)

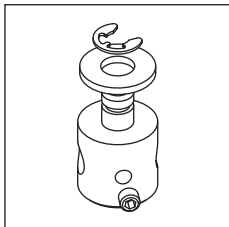

31 15 11 28

Eixo de ligação (Z-58 ou Z-68)

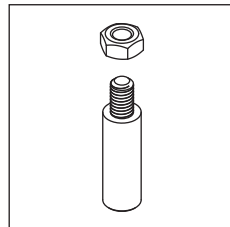

31 15 11 29

Eixo inferior (Z-58 ou Z-68)

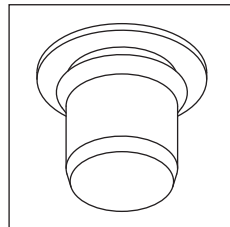

31 15 11 30

Casquilho inferior (Z-58 ou Z-68)

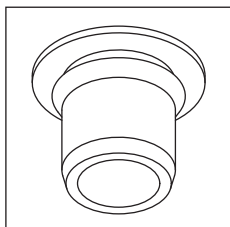

31 15 11 31

Casquilho superior (Z-58 ou Z-68)

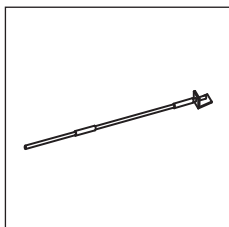

31 15 11 36

Accionador telescópico

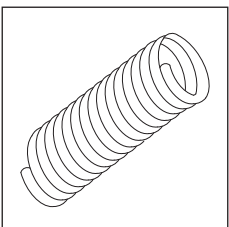

31 15 11 96

Mola fim de curso

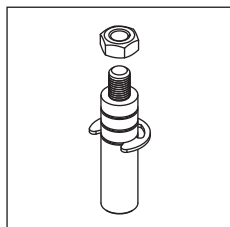

31 15 12 24

Eixo superior lâmina (Z-62 ou Z-65)

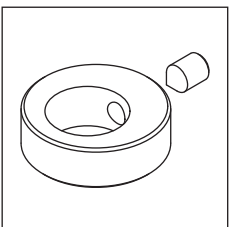

31 15 12 26

Anel freio lâmina (Z-62 ou Z-65)

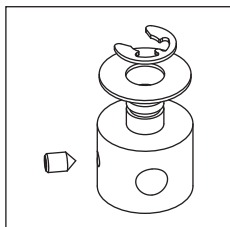

31 15 12 28

Eixo ligação lâmina (Z-62 ou Z-65)

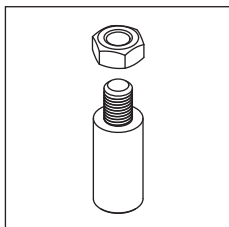

31 15 12 29

Eixo inferior lâmina (Z-62 ou Z-65)

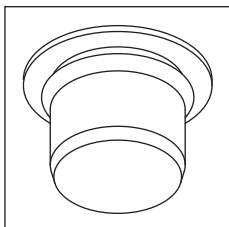

31 15 12 30

Casquilho inferior lâmina (Z-62 ou Z-65)

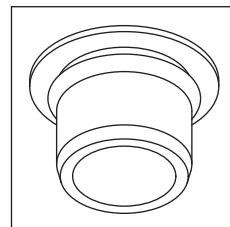

31 15 12 31

Casquilho superior lâmina (Z-62 ou Z-65)

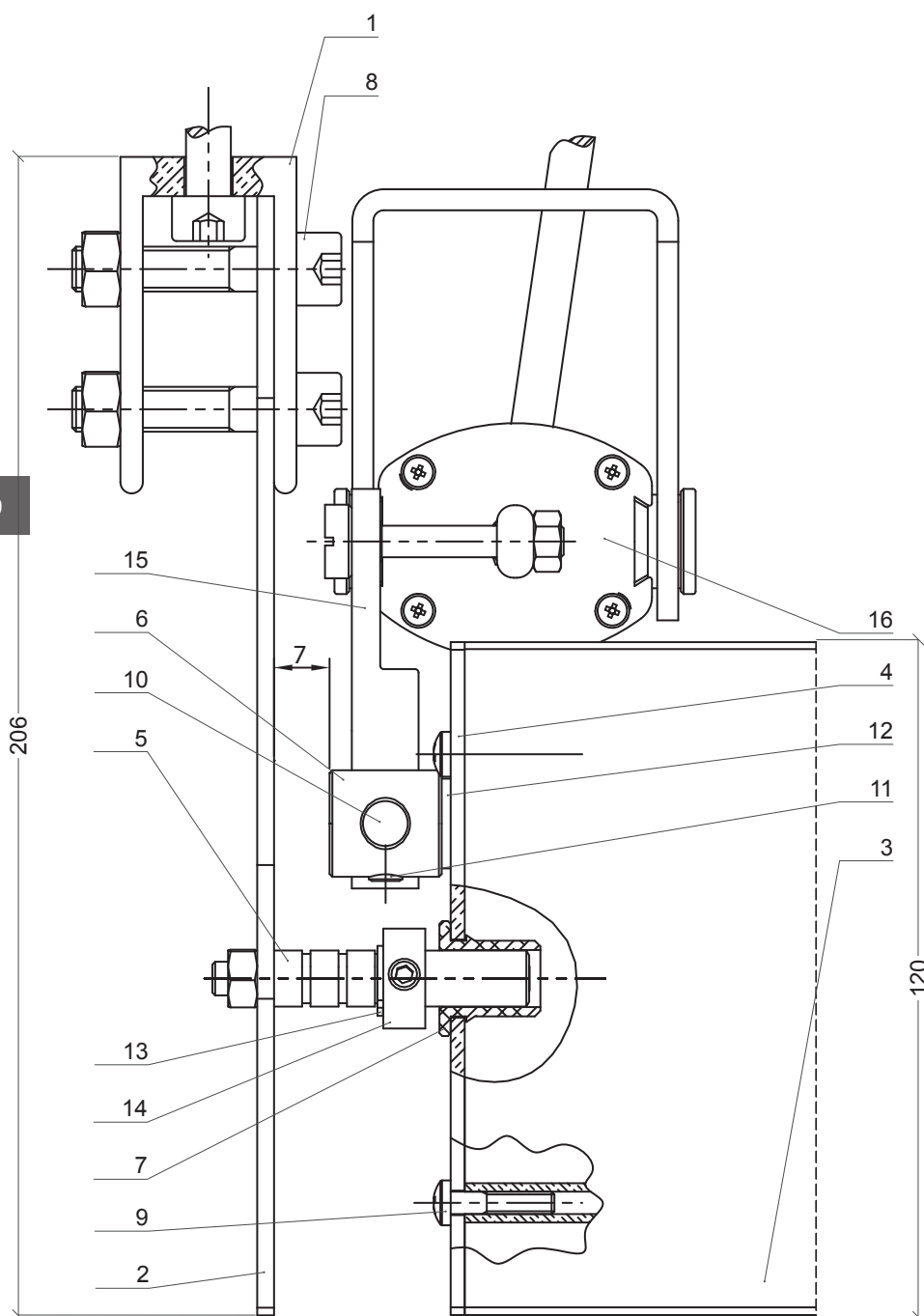
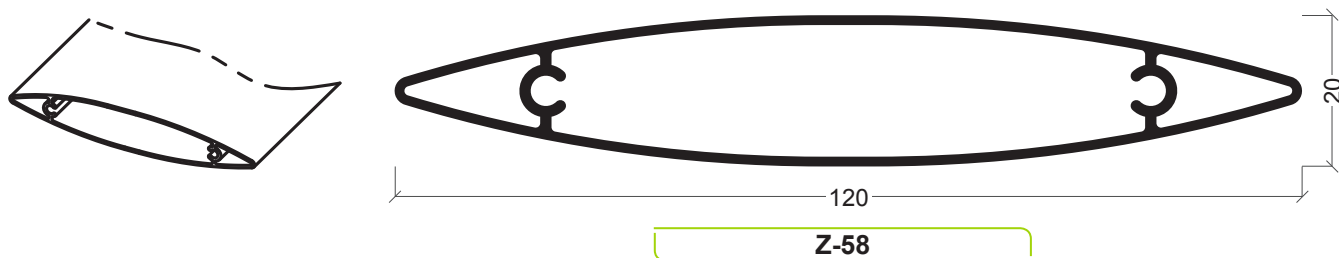

- 1 **U-09** (calha suporte U-09)
- 2 **31 15 00 71** (topo fixação alongado Z-58)
- 3 **Z-58** (lâmina 120 mm)
- 4 **31 15 01 01** (topo móvel)
- 5 **31 15 11 24** (eixo para móvel de rotação)
- 6 **31 15 11 28** (eixo de ligação lâmina)
- 7 **31 15 11 31** (casquilho em nylon para eixo)
- 8 **Parafuso DIN 912 M8x40**
- 9 **Parafuso ISO 7045 M4x16**
- 10 **G-01** (varão 8 mm)
- 11 **Perno DIN 913 M6x6**
- 12 **Anilha em nylon 16x1.6**
- 13 **Freio TRUARC**
- 14 **31 15 11 26** (anel excêntrico de ajustamento)
- 15 **31 15 11 25** (ligação ao motor/ comando manual)
- 16 **31 15 10 84** (motor eléctrico)

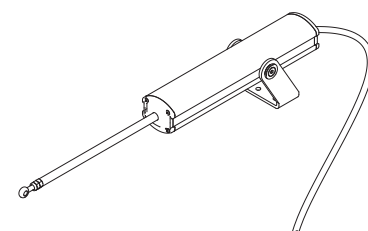

Montagem do motor sempre com o pistão virado para baixo

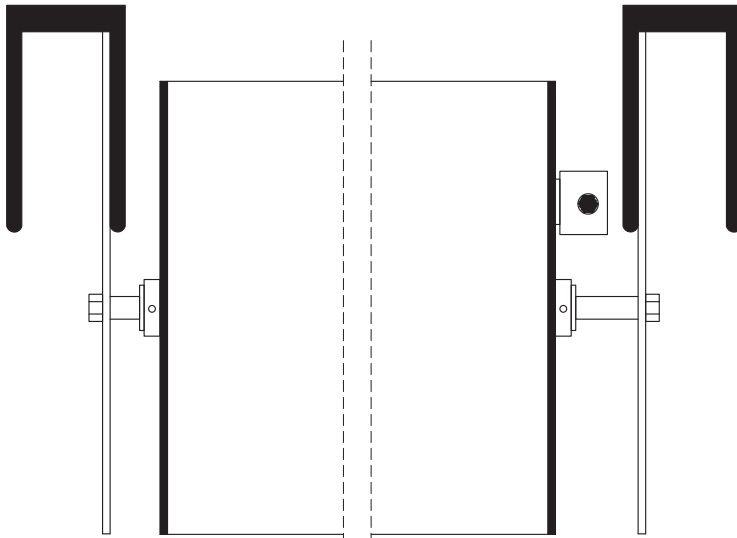

Secção B - B

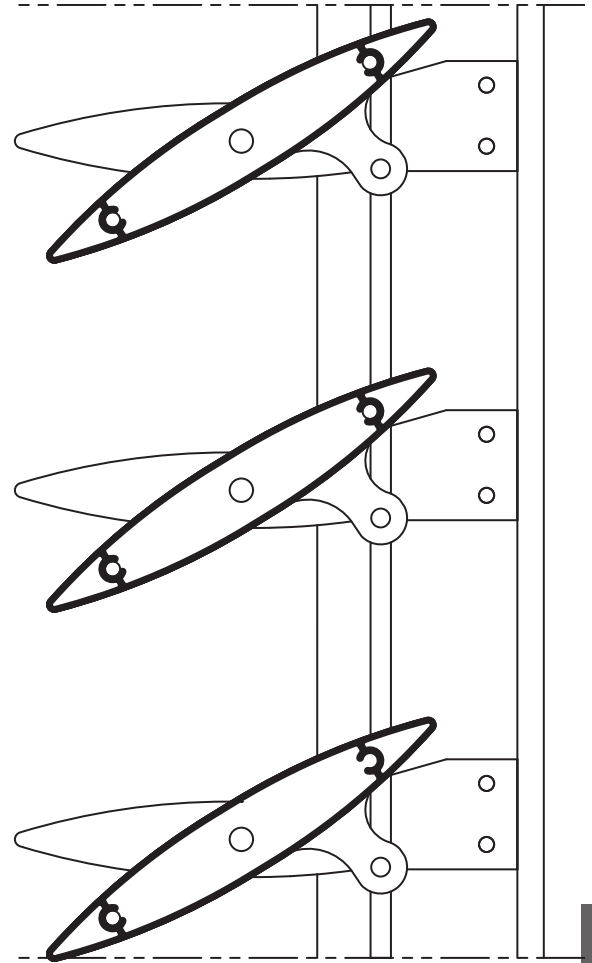
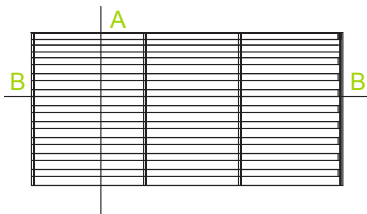

Secção A - A

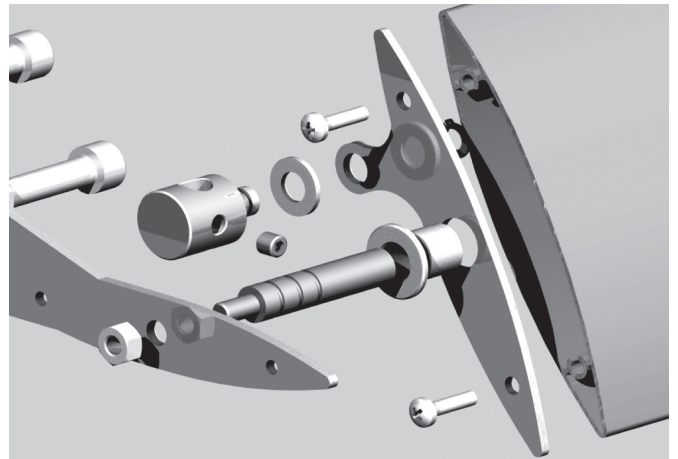
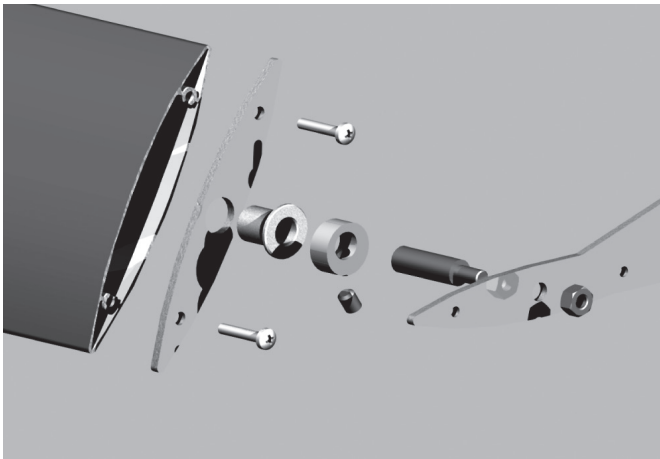

- 1 **U-09** (calha suporte U-09)
- 2 **31 15 00 79** (topo fixação alongado 250 mm)
- 3 **Z-62** (lâmina 250 mm)
- 4 **31 15 01 12** (topo móvel)
- 5 **31 15 12 24** (eixo para móvel de rotação)
- 6 **31 15 12 28** (eixo de ligação lâmina)
- 7 **31 15 12 31** (casquilho em nylon para eixo)
- 8 **Parafuso DIN 912 M8x40**
- 9 **Parafuso ISO 7045 M4x16**
- 10 **G-01** (varão 8 mm)
- 11 **Perno DIN 913 M6x6**
- 12 **Anilha em nylon 16x1.6**
- 13 **Freio TRUARC**
- 14 **31 15 11 26** (anel excêntrico de ajustamento)
- 15 **31 15 11 25** (ligação ao motor/comando manual)
- 16 **31 15 10 84** (motor eléctrico)

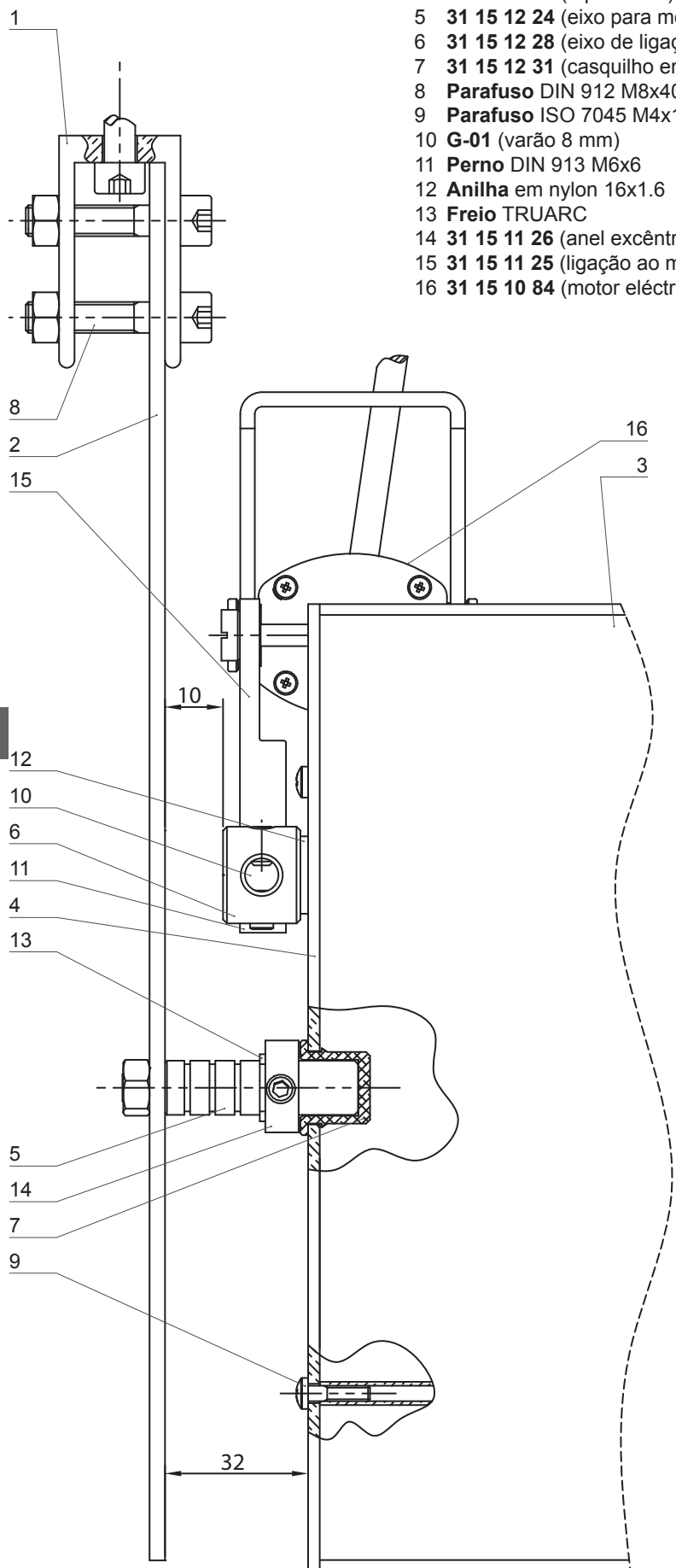

512

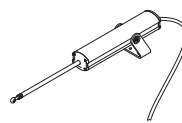

Montagem do motor sempre com o pistão virado para baixo

Z-62

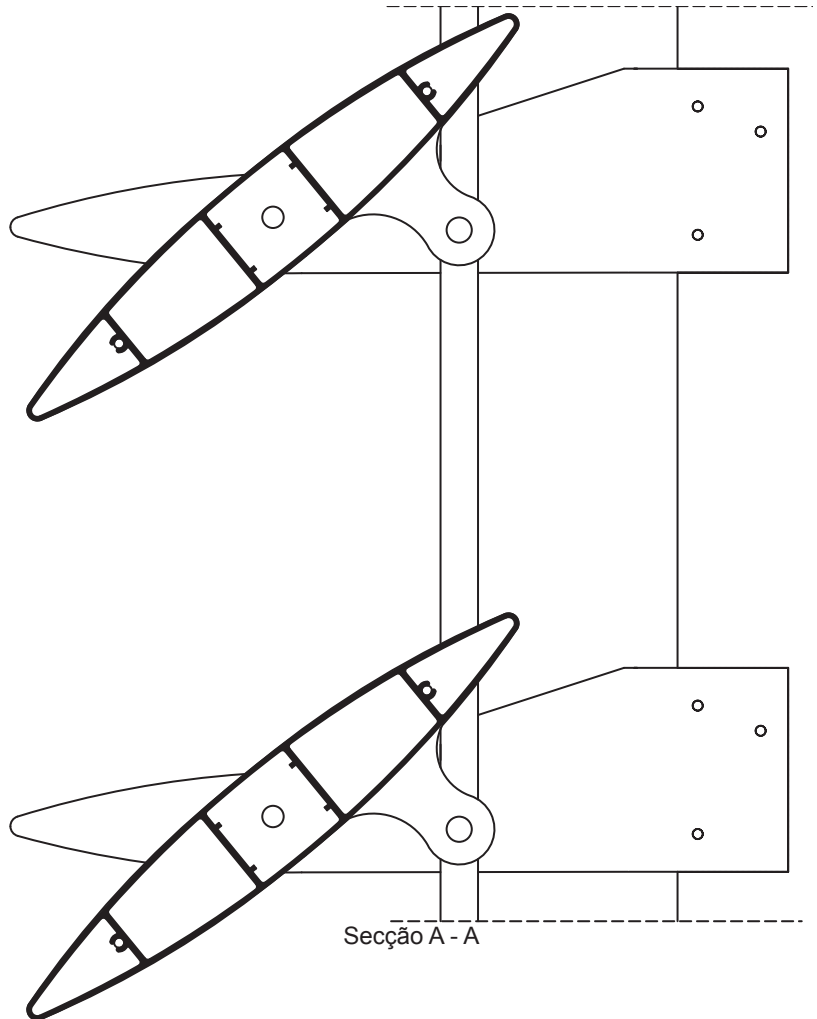
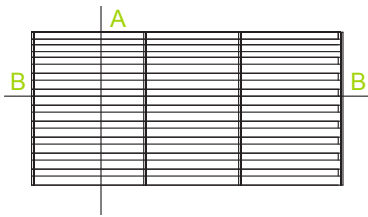
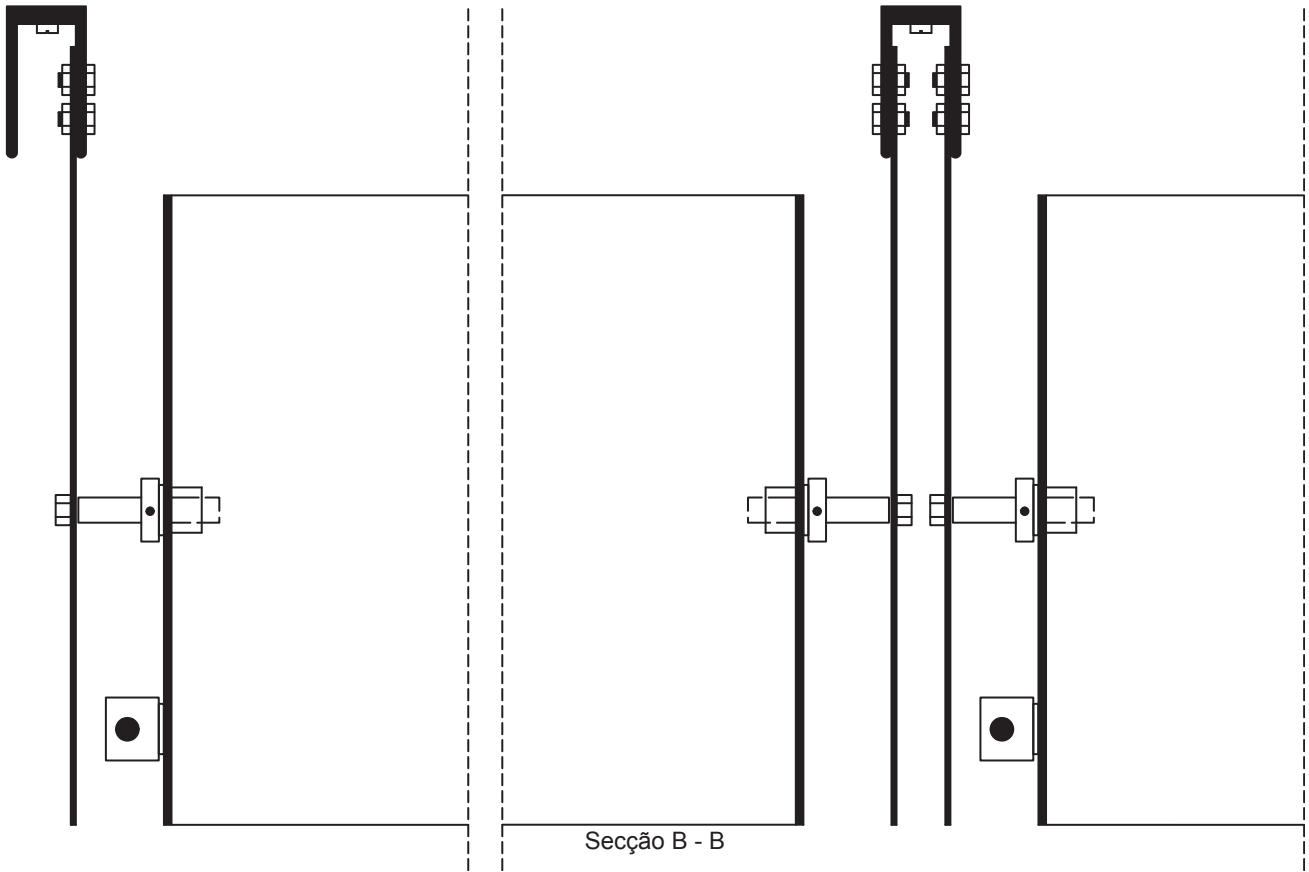

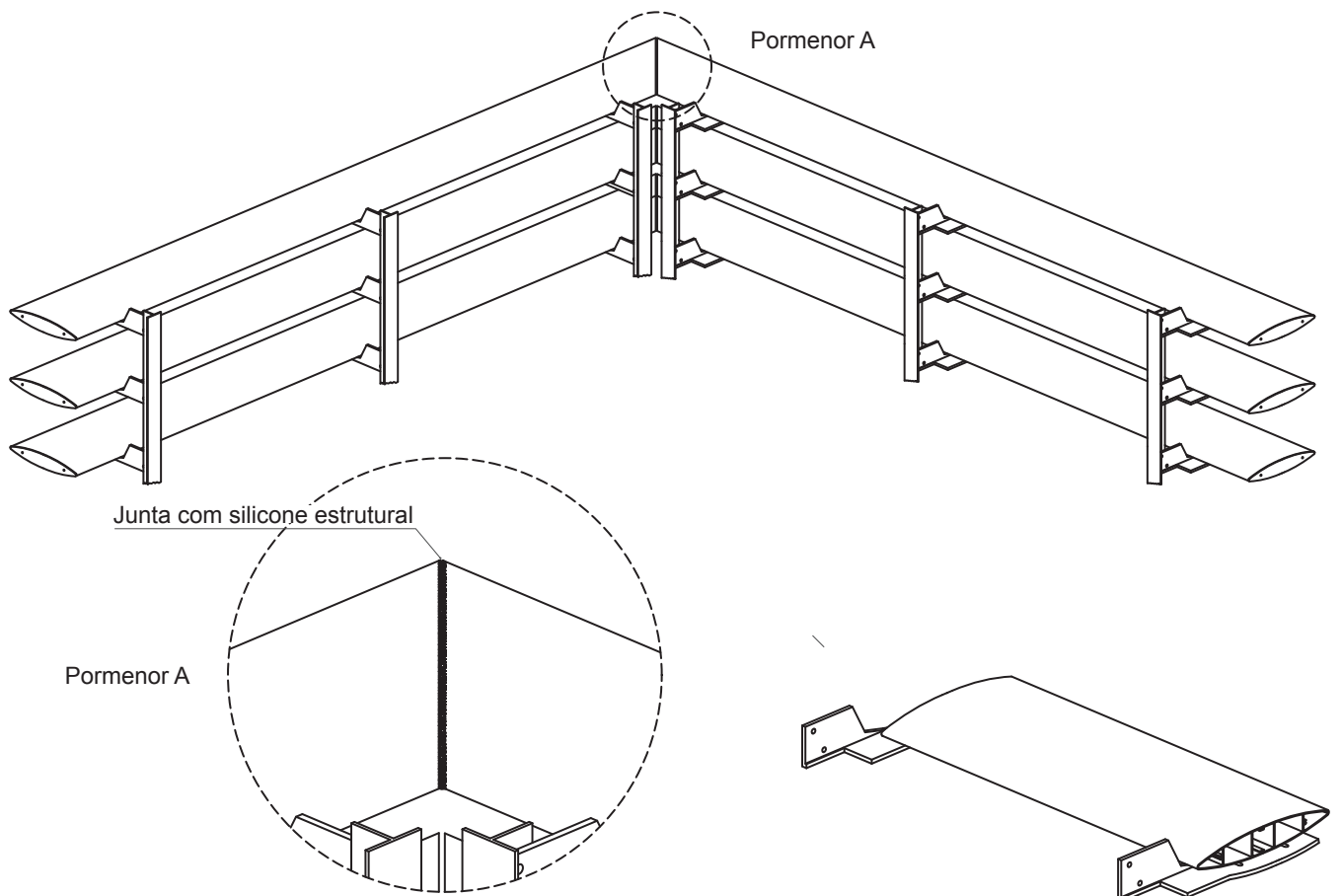
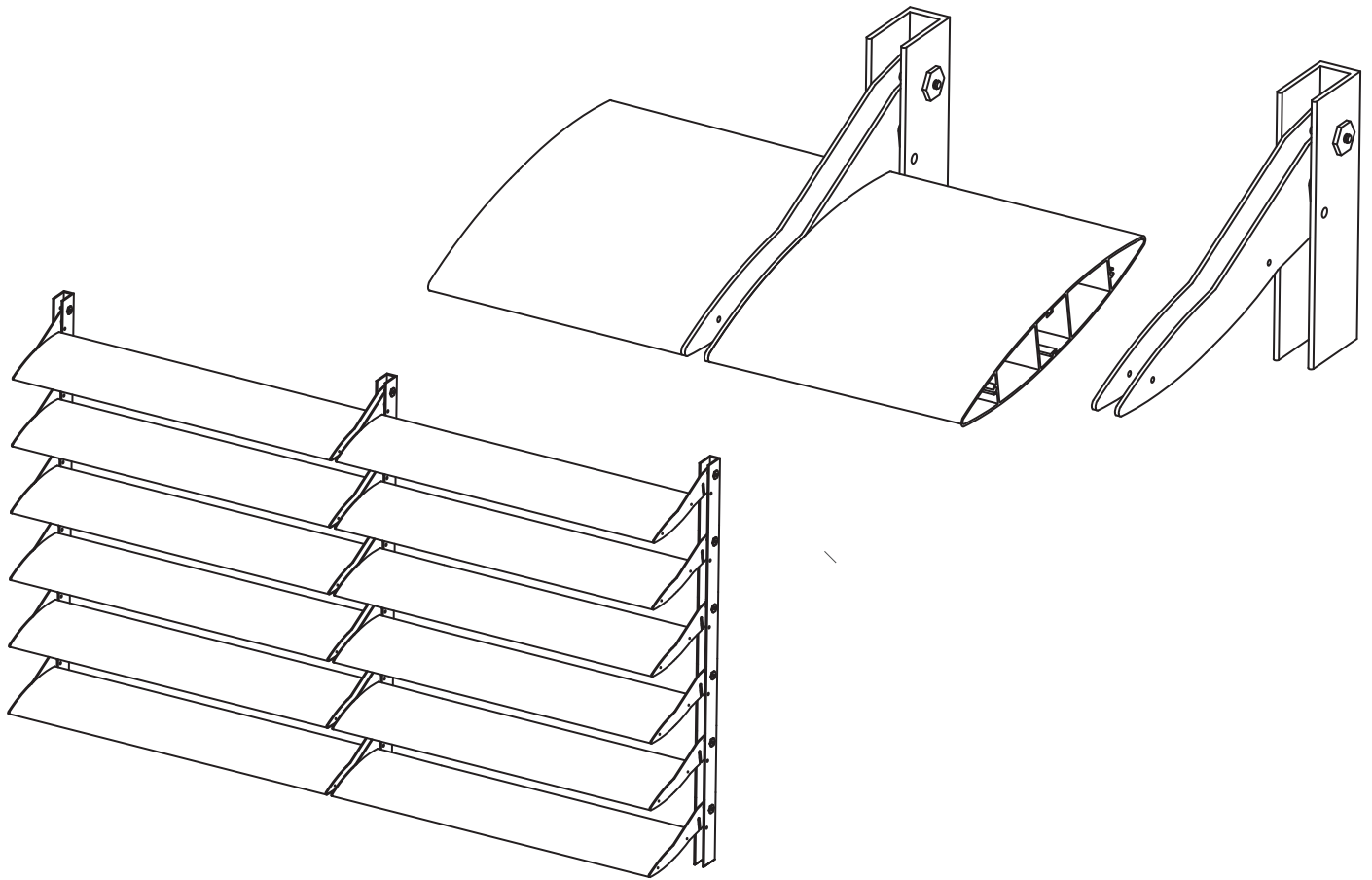

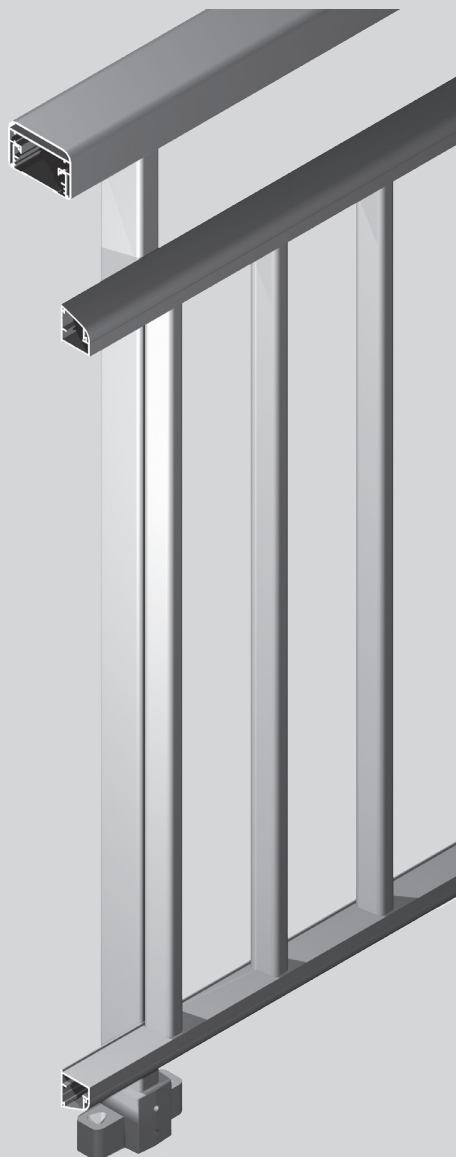

Sistema

BL

Sistema BL

Sistema de corrimão que oferece quatro possibilidades distintas:

- Corrimão só com vidro;
- Corrimão de vidro com superfície superior livre;
- Corrimão com prumo total;
- Corrimão com prumo e superfície superior livre.

Esteticamente apresenta dois tipos de perfil para corrimão:

- Corrimão quadrado 60 mm;
- Corrimão circular com diâmetro de 67 mm;
- Corrimão elíptico com 80 mm de medida exterior.

Este sistema complementa-se com uma extensa gama de acessórios que permitem contemplar um elevado leque de soluções.

Sistema BL-Vidro

Sistema de alumínio minimalista para executar guardas ou corrimões de vidro.

Características do sistema

Sistema BL-Vidro é um produto inovador, elegante com design minimalista e de alta qualidade que serve de apoio ao longo de escadas ou de barreiras de segurança promovendo a protecção dos utilizadores.

Este produto oferece uma solução de transparência, estética durável e sem necessidade de manutenção.

De fácil montagem e com varias soluções de montagem para uma maior facilidade de integração em cada projecto.

O sistema foi concebido para servir com segurança em habitações privadas, publicas, edifícios comerciais ou de serviços tais como:

- Locais de actividade residencial: salas e quartos de edifícios de habitação privados, quartos e enfermarias de edifícios hospitalares, quartos de edifícios hoteleiros, cozinhas, lavabos. etc.
- Locais de acolhimento de publico: igrejas, teatros, cinemas, salas de conferência, salas de aulas, salas de reunião, salas de espera, salas de exposições, salões de dança, ginásios, palcos, acessos de publico a edifício administrativo, hospitalares e hoteleiros, átrios de estações de transportes públicos, grandes armazéns comerciais, zonas comerciais em geral, escritórios, cafés, restaurantes, salas de leitura, recepções etc.

O sistema BL-Vidro permite a execução de 3 versões:

- Versão minimalista superior;
- Versão minimalista embutida;
- Versão minimalista lateral;

O sistema BL-Vidro foi concebido para receber vidros laminados-temperados ou laminados de espessura 8+8 ou 10+10 com um mínimo 2 camadas de polivinil butiral (PVB) entre as 2 chapas de vidro. Os vidros devem ter as arestas quebradas.

O sistema está de acordo com as normas de construção nacionais ou internacionais e satisfaz todas as normas de segurança tendo sido certificado segundo a norma NP 4491:2009.

- Perfil base BL-20 em alumínio com 120 mm x 43 mm;
- Altura mínima da guarda de 1100 mm;
- Largura máxima recomendada para o vidro: 2100 mm;
- Fixação do perfil base em versão superior ou lateral em intervalos de 400mm;
- Disponibilidade de perfil suplementar BL-21 para a versão de minimalista lateral;
- Disponível diversos perfis de remate superior para efeito de passa-mão;
- Juntas de vedação em SEBS cinza;
- Juntas de enchimento em EPDM de qualidade marítima.

Perfis de alumínio

- Os perfis de alumínio são extrudidos na liga de alumínio 6060 para arquitetura de acordo com norma NP EN 12020-02.

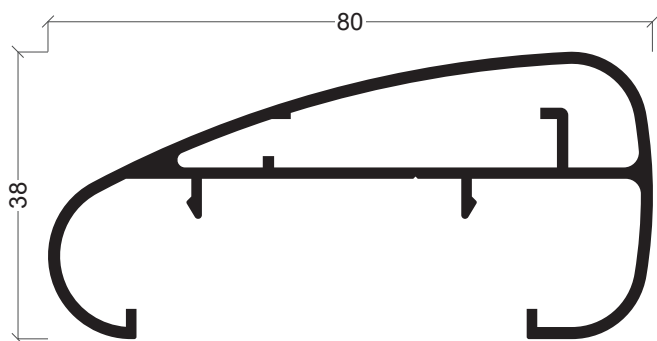

BL-02

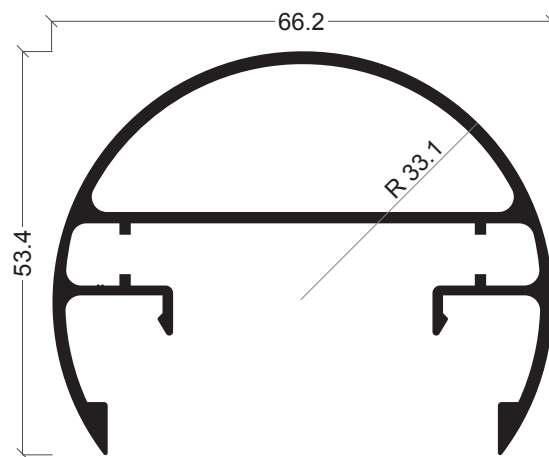

BL-12

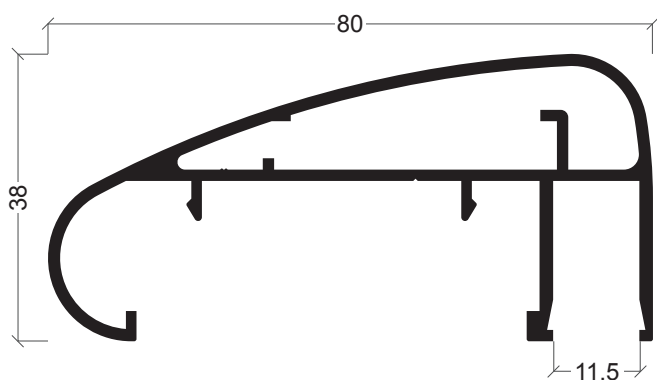

BL-11

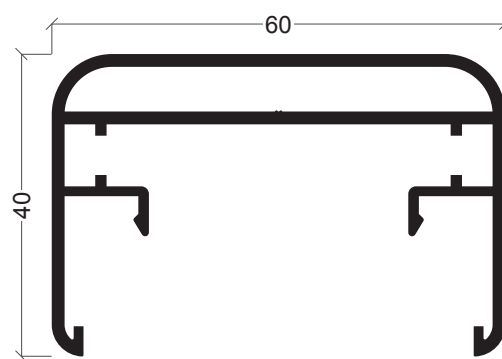

BL-14

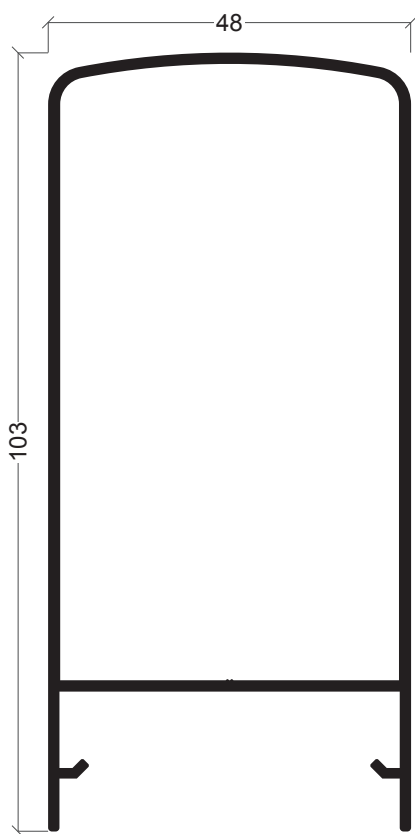

BL-15

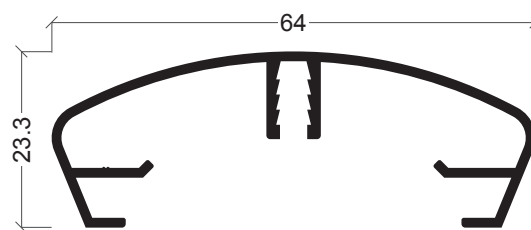

BL-04

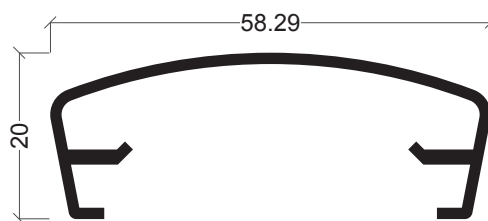

BL-16

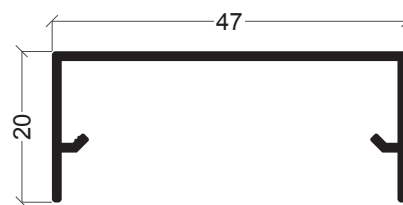

BL-17

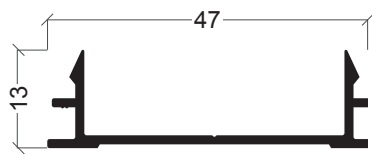

BL-18

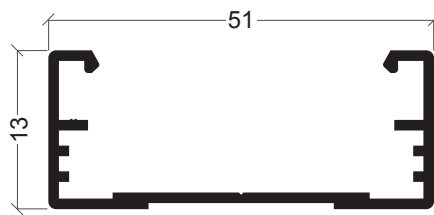

BL-03



BL-05

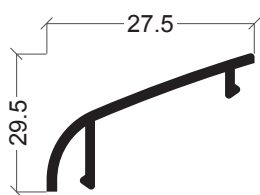

BL-08

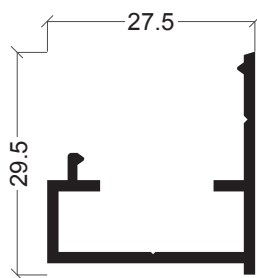

BL-06

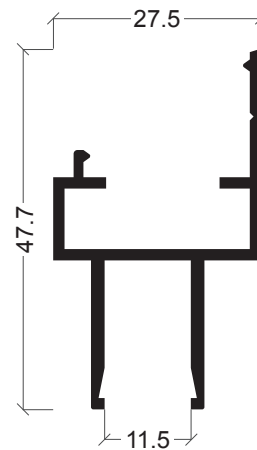

BL-07

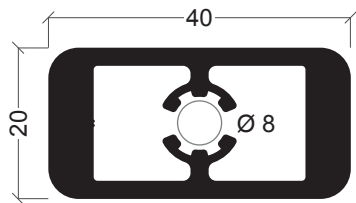

BL-09

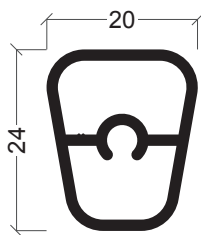

BL-10

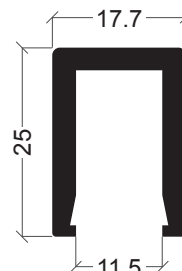

BL-13

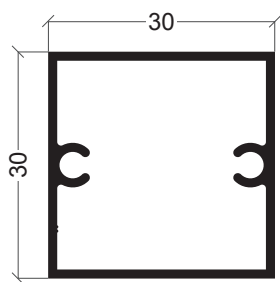

F1-05

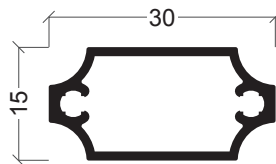

F1-09

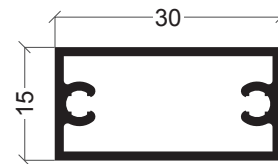

F1-04

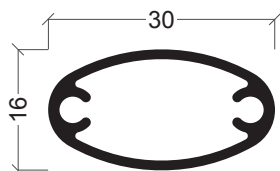

BL-19

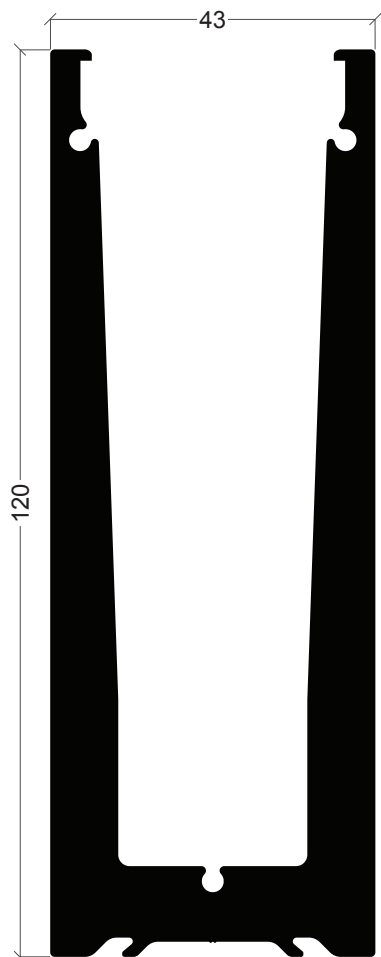

BL-20

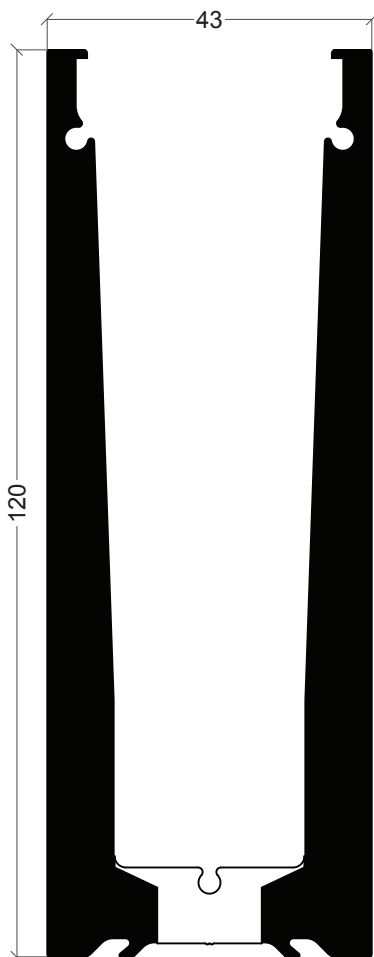

BL-20/FV
(com furação vertical) em intervalos de 400 mm

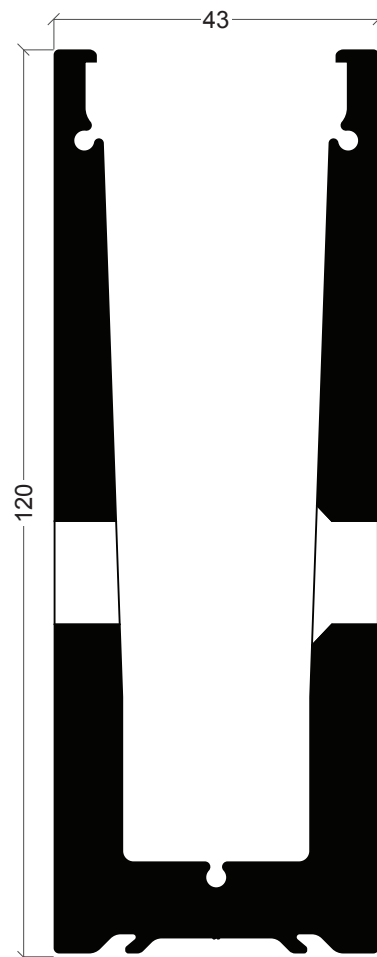

BL-20/FH
(com furação horizontal) em intervalos de 400 mm

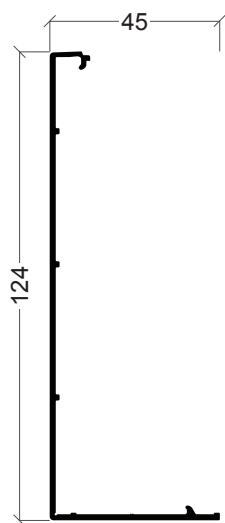

BL-21

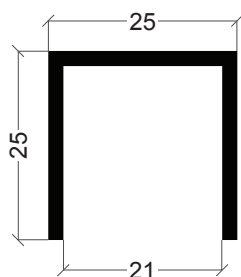
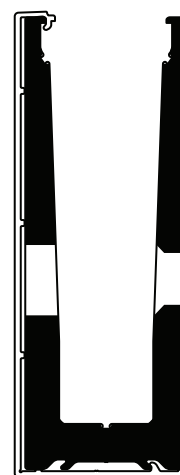
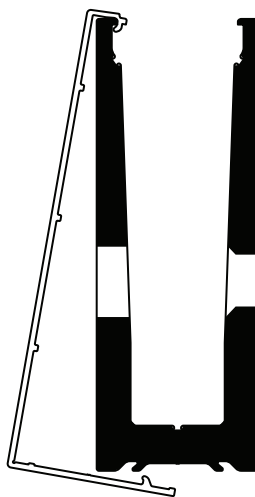

U-11
para vidro 1010.2

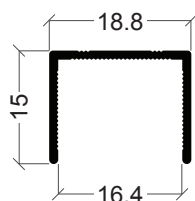

S-19
para vidro 88.2 ou 88.4

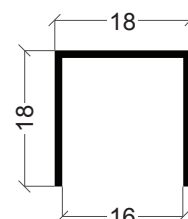

U-02
(recomendamos aplicação do perfil U-02 anodizado) para vidro 88.2

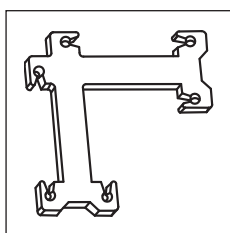

30 90 85 04

Esquadro fixo 90°

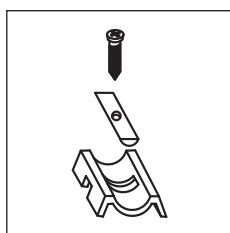

30 90 85 05

Fixação montante inclinado

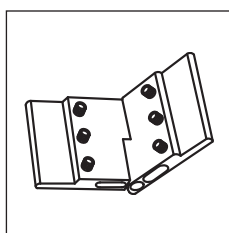

30 90 85 06

Esquadro ângulo variável BL-03

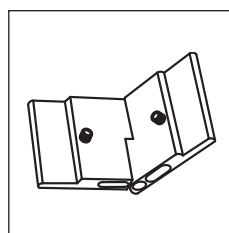

30 90 85 07

Esquadro ângulo variável BL-06

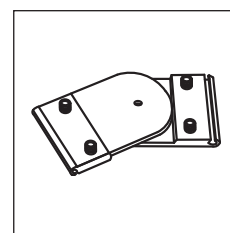

30 90 85 08

Esquadro regulável BL-03

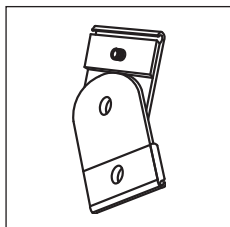

30 90 85 09

Esquadro regulável BL-06

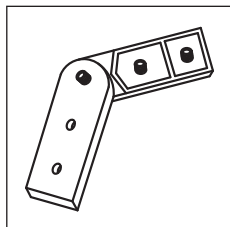

30 90 85 10

Esquadro regulável BL-02

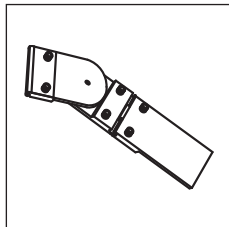

30 90 85 11

Esquadro duplo regulável

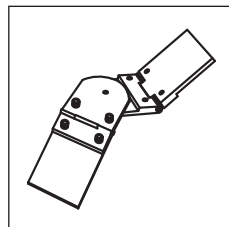

30 90 85 12

Esquadro triplo regulável

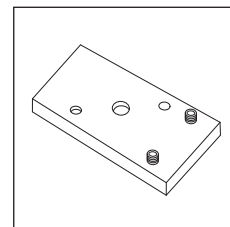

30 90 85 13

União de passamãos

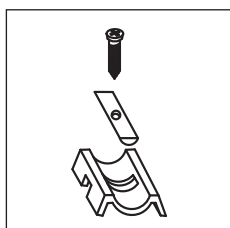

30 90 85 14

Fixação prumo inclinado

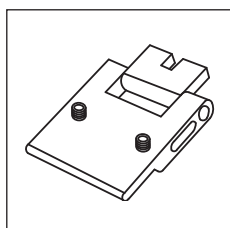

30 90 85 23

União travessa inferior regulável

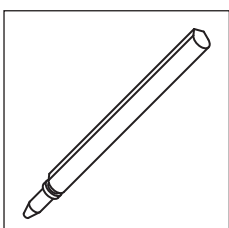

30 96 00 55

Perno para fixação de topo

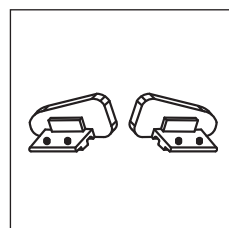

31 90 85 01*

Jogo tampas laterais BL-02

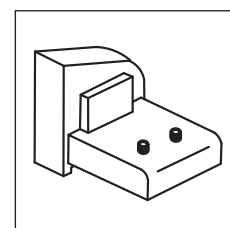

31 90 85 02*

Jogo tampas laterais BL-06

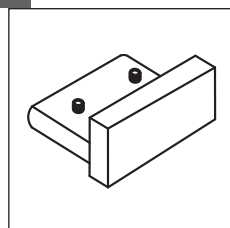

31 90 85 03*

Tampa BL-03

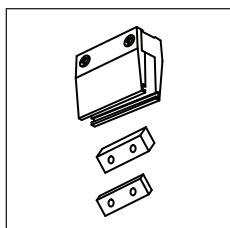

31 90 85 05

Apoio lateral com calços BL-Vidro (lacado ou anodizado)

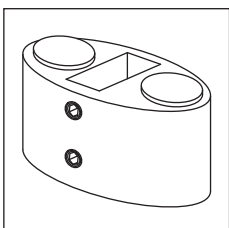

31 90 85 14

Sapata elíptica (tampas cromadas)

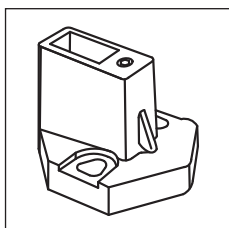

31 90 85 15*

Fixador ao pavimento

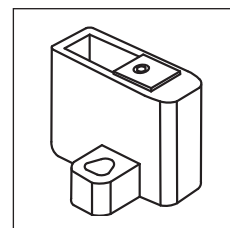

31 90 85 16

Fixador ao pavimento extrudido

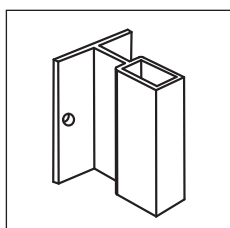

31 90 85 17

Fixador alto

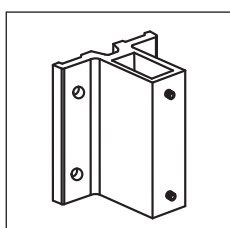

31 90 85 18

Fixador baixo

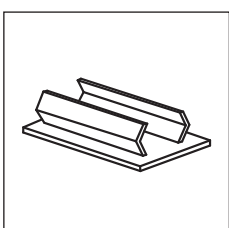

31 90 85 19

Tampão do fixador

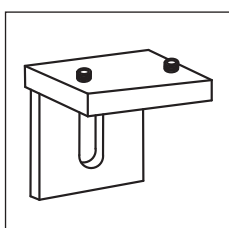

31 90 85 20

Terminal fixação muro

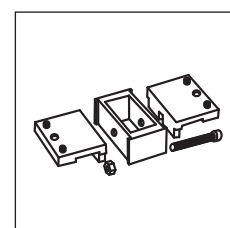

31 90 85 21

União travessa inferior recta

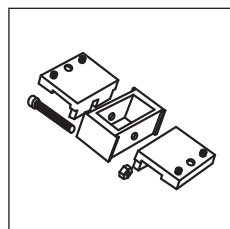

31 90 85 22

União travessa inferior 30°

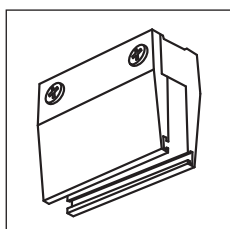

31 90 85 24

Suporte porta-vidro recto

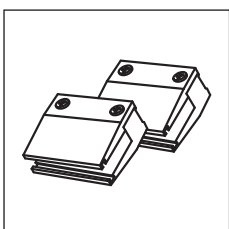

31 90 85 25

Suporte porta-vidro 30°

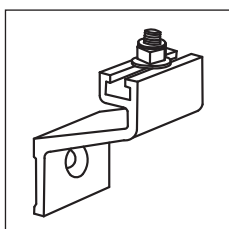

31 90 85 26

Suporte passamãos muro

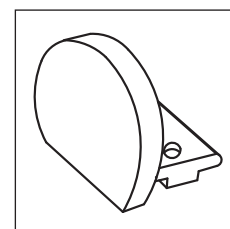

31 90 85 27

Tampa de passamãos BL-12

* Só para lacar

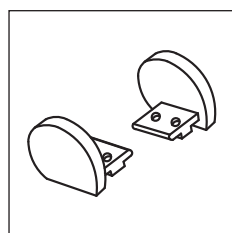

31 90 85 28
Conjunto tampas BL-12 a 30°

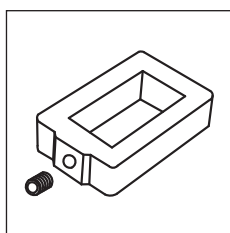

31 90 85 29
Remate pavimento BL-09

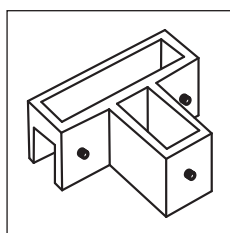

31 90 85 30
Suporte remate vidro

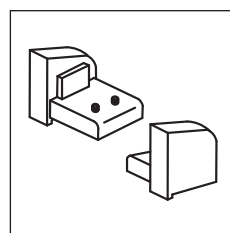

31 90 85 31*
Conjunto tampa lateral BL-06 direito 30°

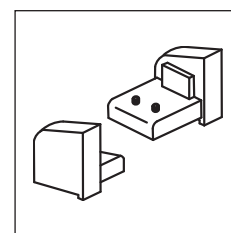

31 90 85 32
Conjunto tampa lateral BL-06 esquerdo 30°

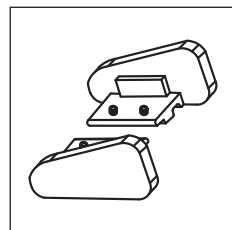

31 90 85 33*
Conjunto tampa corrimão direito 30°

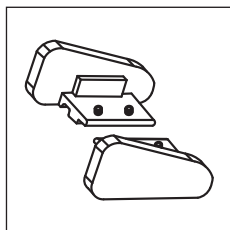

31 90 85 34*
Conjunto tampa corrimão esquerdo 30°

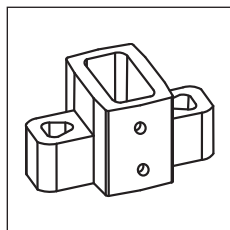

31 90 85 36
Fixador de muro

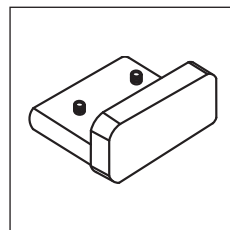

31 90 85 37
Tampa lateral BL-14

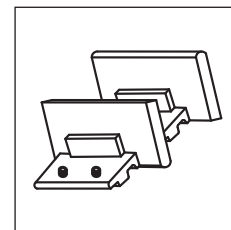

31 90 85 38
Jogo tampas laterais BL-14 30°

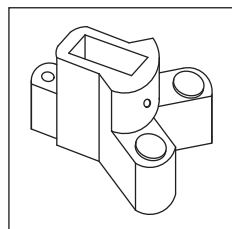

31 90 85 39
Fixador ao pavimento para BL-09 (tampas pretas)

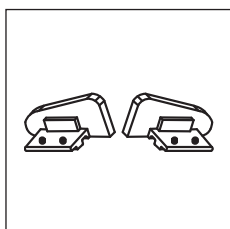

31 90 85 40*
Jogo tampas laterais BL-11

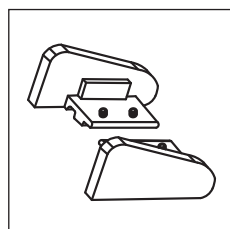

31 90 85 41
Conjunto tampa corrimão para BL-11 esquerdo 30°

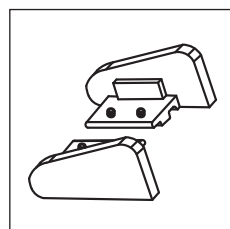

31 90 85 42
Conjunto tampa corrimão para BL-11 direito 30°

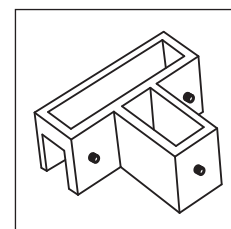

31 90 85 43
Suporte remate vidro esquerdo 30°

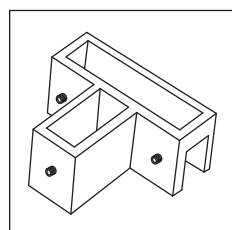

31 90 85 44
Suporte remate vidro direito 30°

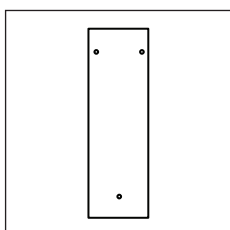

31 90 85 45
Topo para BL-20 (anodizado ou lacado)

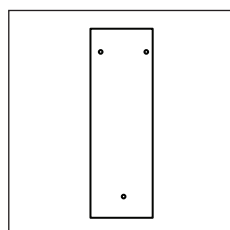

31 90 85 46
Topo para BL-20 + BL-21 (anodizado ou lacado)

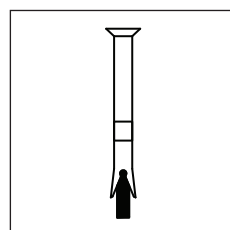

31 90 85 47
Buchca zincada M8

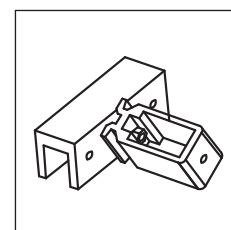

31 90 85 50
Suporte vidro regulável

Referência	Desenho	Descrição
30 90 85 60		Junta para vidro 44.1
30 90 85 62		Junta para vidro 44.2
30 90 85 63		Junta BL nº 1 cinza (rolo 150 mts)
30 90 85 64		Junta BL nº 2 cinza (rolo 100 mts)
30 90 85 65		Junta BL nº 4 cinza (rolo 100 mts)
30 90 85 66		Junta BL nº 5 cinza (rolo 100 mts)
30 90 85 67		Junta BL nº 6 preto (rolo 50 mts)
30 90 85 68		Junta em U BL nº 1 preto (rolo 50 mts)
30 90 85 69		Junta em U BL nº 2 preto (rolo 45 mts)

* Só para lacar

Corrimão vidro

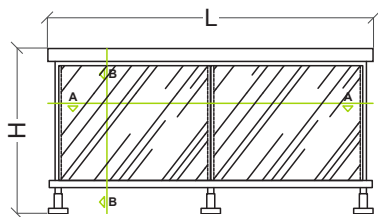

Perfis

Desenho	Ref	Descrição	Corte	Quant	Medida
	BL-03	Encaixe para passamãos		1	L
	BL-09	Prumo		$\leq L / 1000 = A$	H-38 mm
	BL-11	Passamãos com suporte vidro		1	L
	BL-13	Remate vidro		1	L
	31 90 85 15	Fixador ao pavimento	---	Igual A	Opcional
	31 90 85 30	Suporte remate vidro	---	Igual A	---
	30 90 85 60	Junta vidro	---	2	L
---	---	Vidro segurança (4+4)	---	Igual A-1	$(L1-2) \times (H-H1-30)$

522

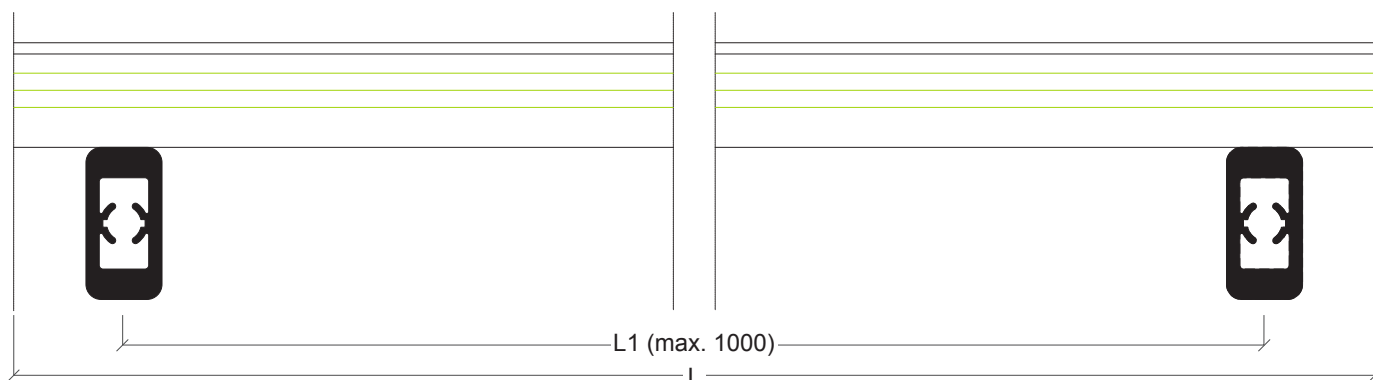
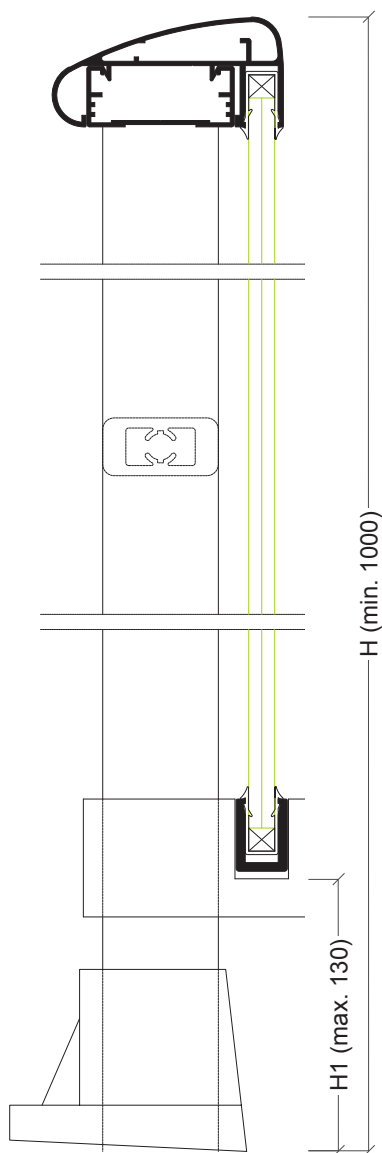

Corrimão vidro com bordo livre

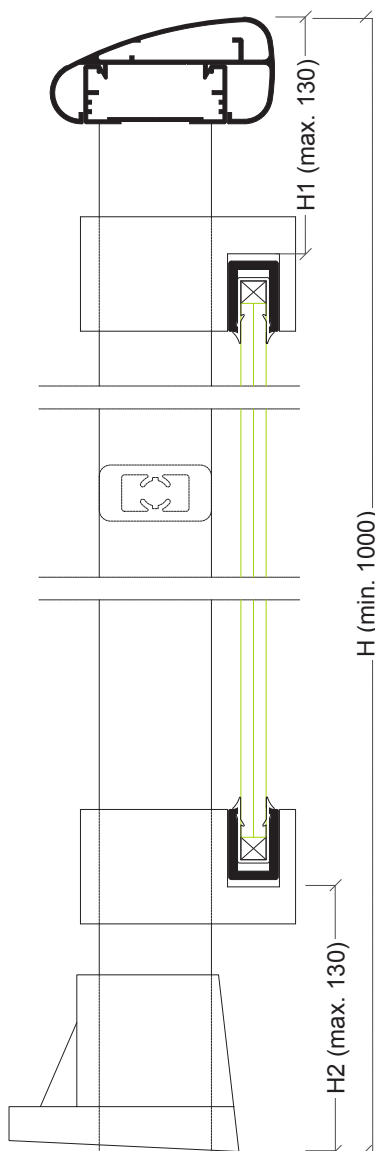
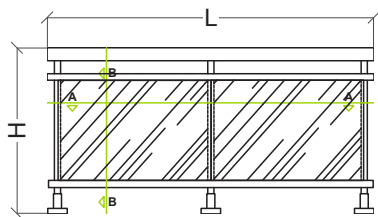

Perfis

Desenho	Ref	Descrição	Corte	Quant	Medida
	BL-02	Passamãos		1	L
	BL-03	Encaixe para passamãos		1	L
	BL-09	Prumo		$\leq L / 1000 = A$	H-38 mm
	BL-13	Remate vidro		2	L
	31 90 85 15	Fixador ao pavimento	---	Igual A	Opcional
	31 90 85 30	Suporte remate vidro	---	Igual A	---
	30 90 85 60	Junta vidro	---	2	L
---	---	Vidro segurança (4+4)	---	Igual A-1	$(L1-2) \times (H-H1-H2-30)$

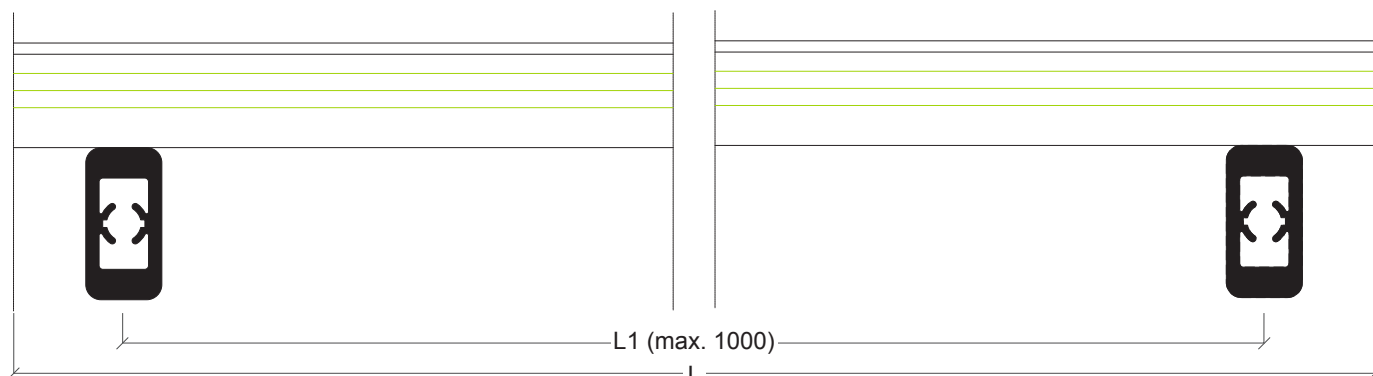

Corrimão prumos

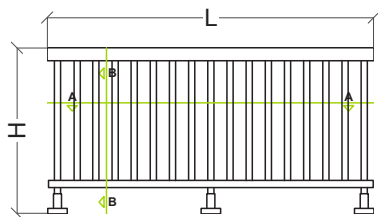

Perfis

Desenho	Ref	Descrição	Corte	Quant	Medida
	BL-02	Passamãos		1	L
	BL-03	Encaixe para passamãos		2	L
	BL-05	Tampa para BL-03		1	L
	BL-09	Prumo		$\leq L / 1000 = A$	H-38 mm
	BL-10	Tubo corrimão		$\leq L1/130-1 \times n^\circ$ de largura	H-H1-38 mm
	31 90 85 15	Fixador ao pavimento	---	Igual A	Opcional

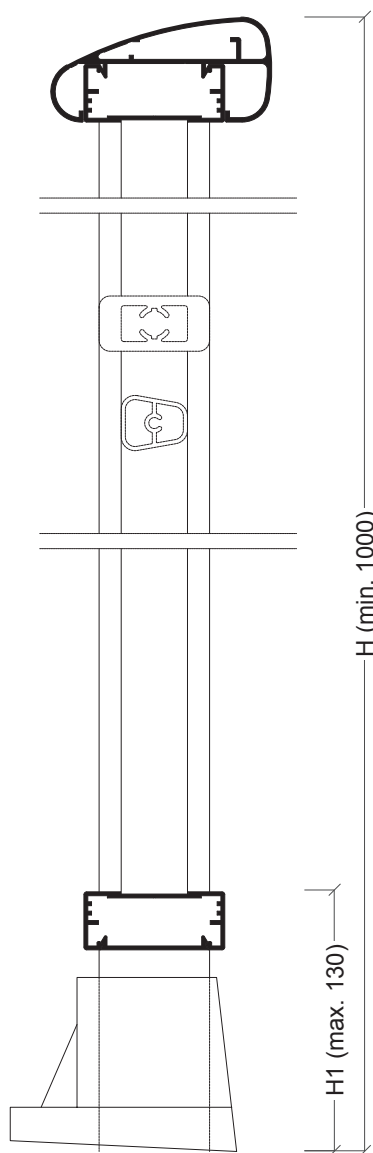

524

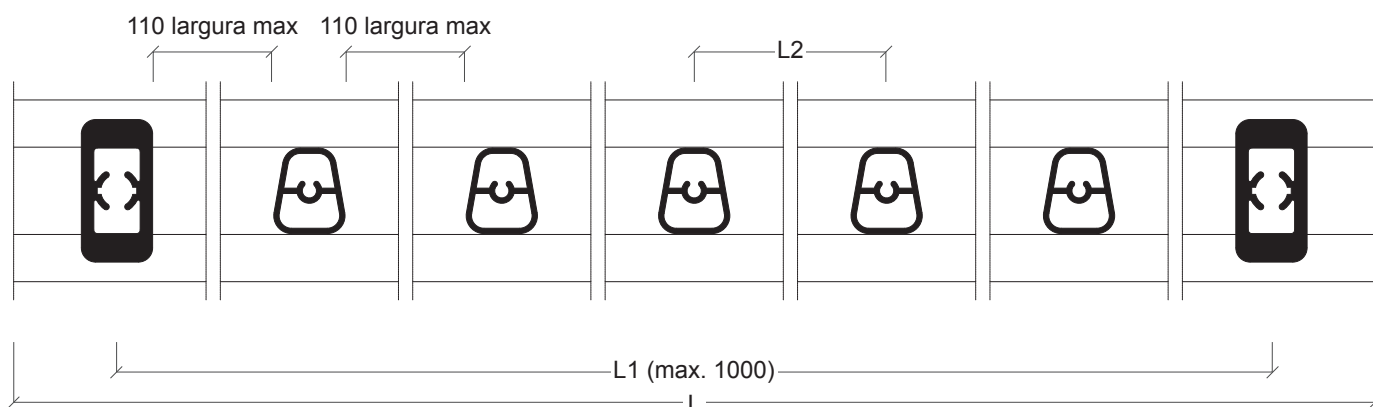

Corrimão prumos com bordo livre

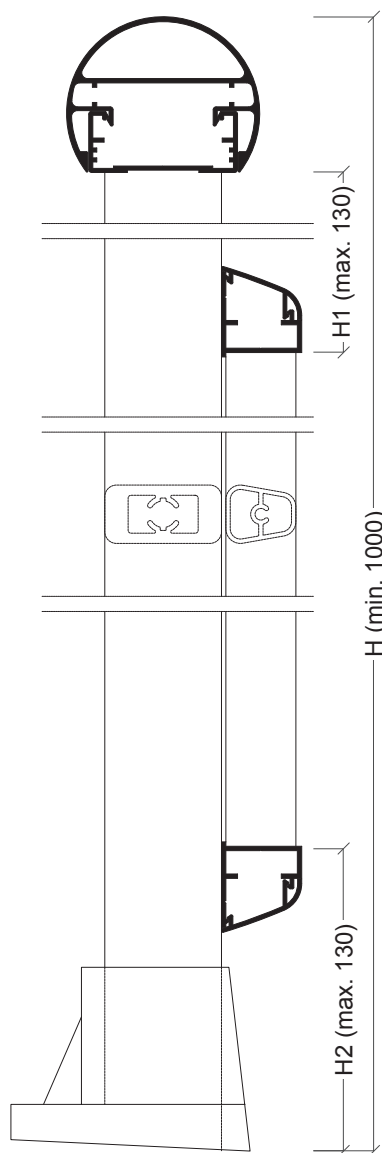
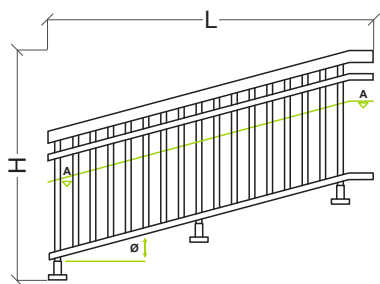

Perfis

Desenho	Ref	Descrição	Corte	Quant	Medida
	BL-08 + BL-06	Tampa para BL-06 Suporte grade	$\emptyset - (\emptyset-2)$	2 (1+1)	L1
	BL-08 + BL-06	Tampa para BL-06 Suporte grade	$\emptyset/2 - 0^\circ$	2 (1+1)	L2
	BL-09	Prumo	$\emptyset - 0^\circ$	$\leq L / 1150$	H-44 mm
	BL-09	Prumo	$0^\circ - 0^\circ$	$\leq L / 1000$	H-38 mm
	BL-10	Tubo corrimão	$\emptyset - \emptyset$	$\leq (L3/150)$ Nº de larguras	H-H1-H2-44 mm
	BL-10	Tubo corrimão	$0^\circ - 0^\circ$	$\leq (L3/130)$	H-H1
	BL-12 + BL-03	Passamãos redondo Encaixe para passamãos	$\emptyset - (\emptyset-2)$	1	L1 (por parte inferior)
	BL-12 + BL-03	Passamãos redondo Encaixe para passamãos	$\emptyset/2 - 0^\circ$	1	L2
	30 90 85 05	Fixação montante inclinado	---	1 x nº perfil BL-09	---
	30 90 85 06	Esquadro ângulo variável BL-03	---	2	---
	30 90 85 07	Esquadro ângulo variável	---	2	---
	30 90 85 14	Fixação prumo inclinado	---	2 x nº perfil BL-10	---
	31 90 85 15	Fixação ao pavimento	---	1 x nº perfil BL-09	---
	31 90 85 28	Conjunto tampas BL-12 a 30°	---	1	---

525

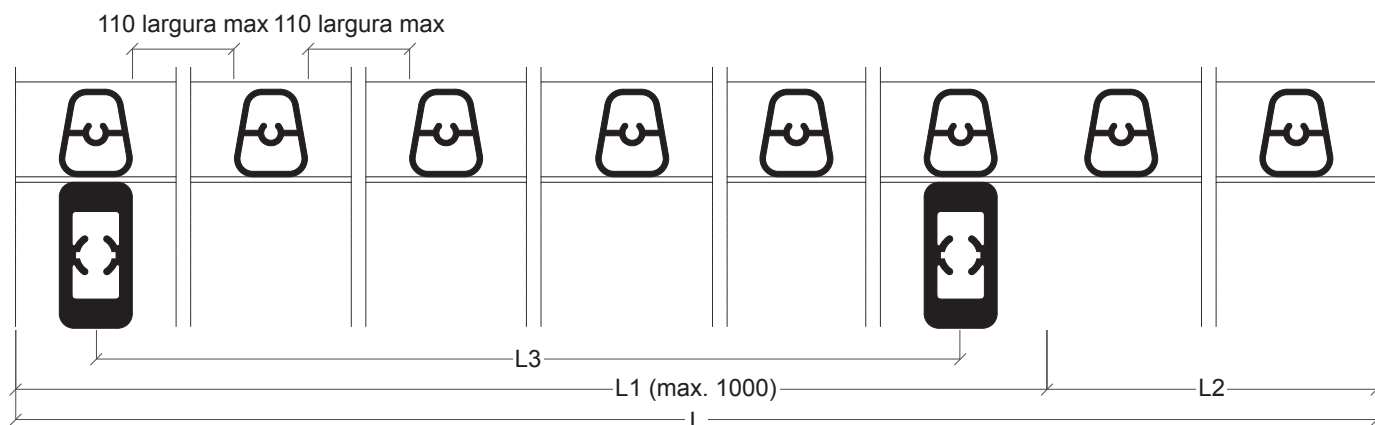

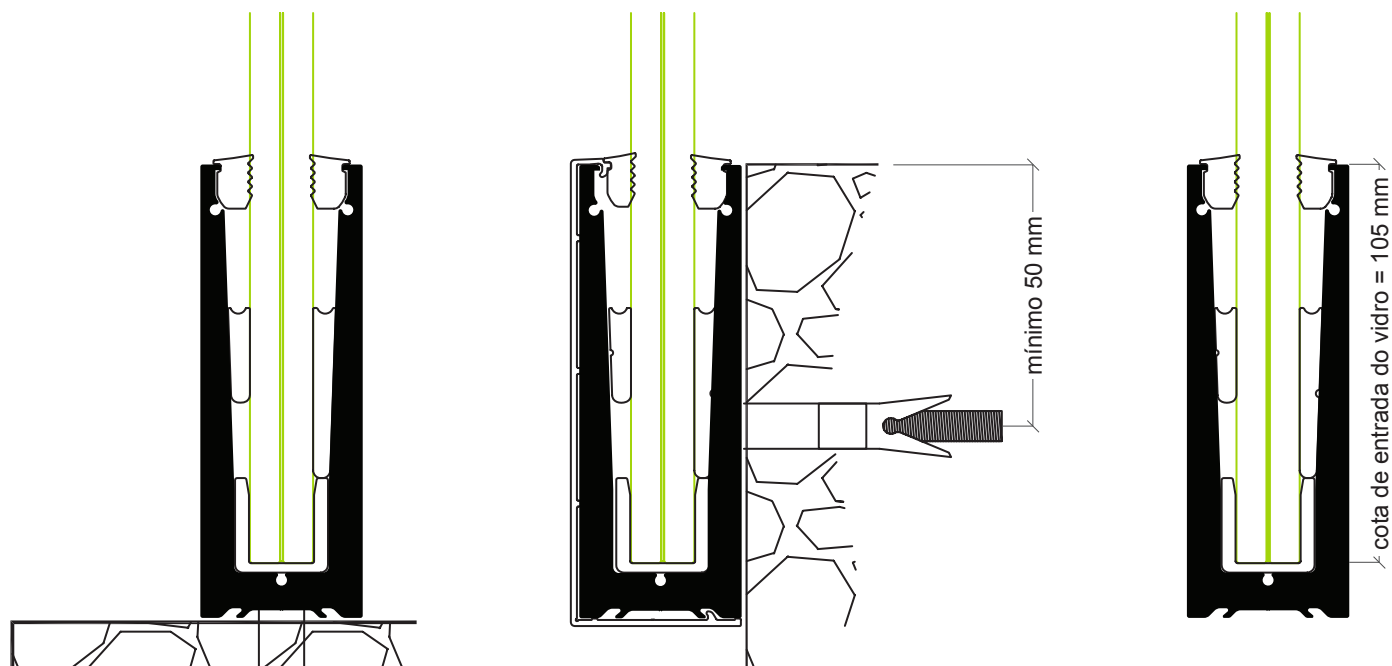

526

mínimo 50 mm

mínimo 50 mm

cota de entrada do vidro = 105 mm

30 90 85 05
Aplicação obrigatória para obras
públicas ou locais públicos

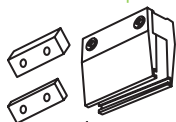

perno 30 96 00 55

ou parafuso M3.5x10 ou
M3.5x8 Tipo DIN 7985 A2

Colar com silicone ou cola-e-veda o perfil superior de remate

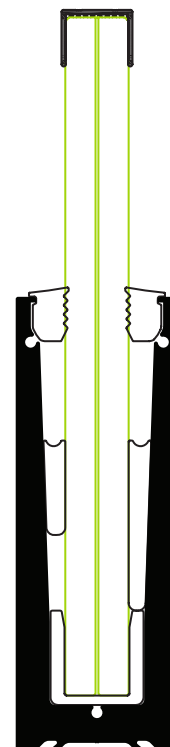
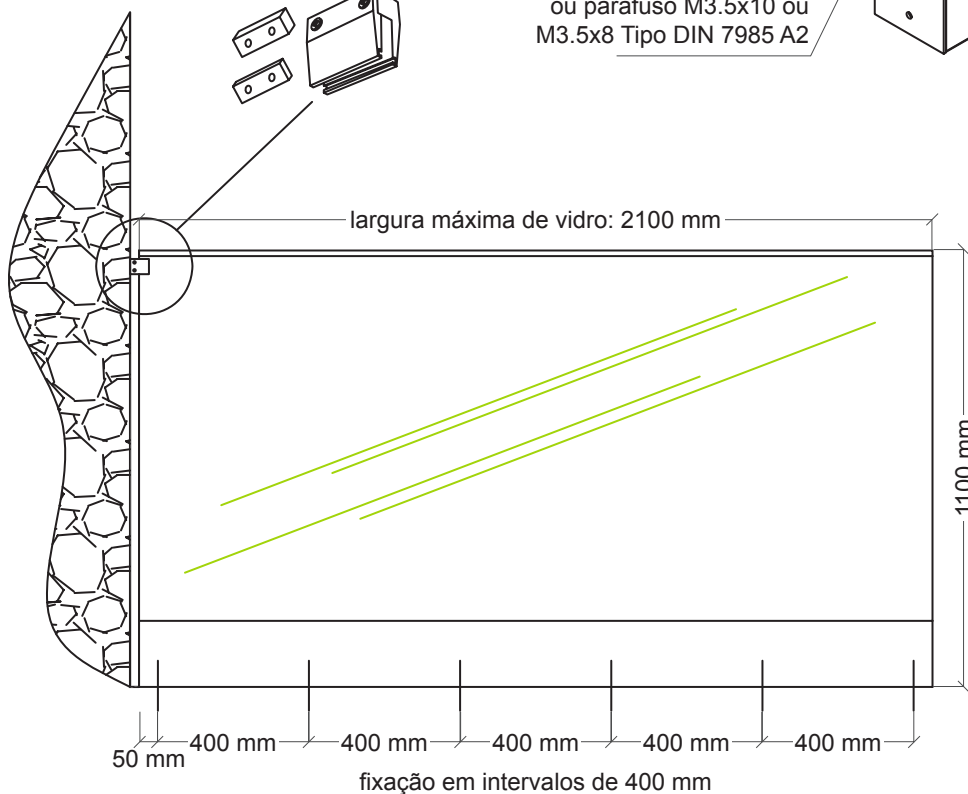

Banheiros

Divisórias

Rede Mosquiteira

Portões

Roupeiros

Toldos

Pré-Aros

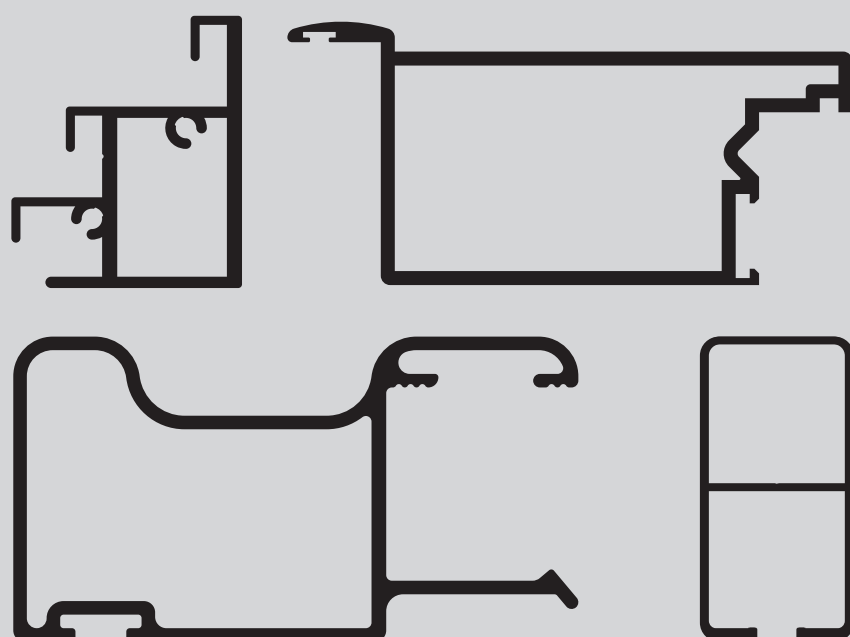

**Perfis
Standard**

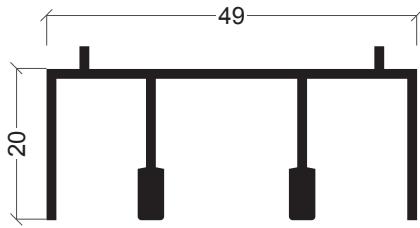

SP-01

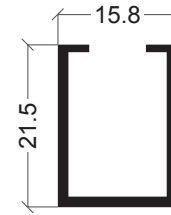

SP-05

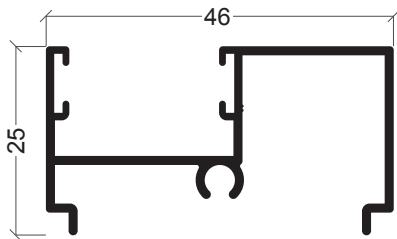

SP-04

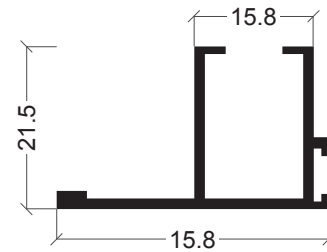

SP-06

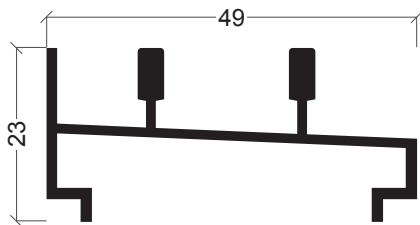

SP-16

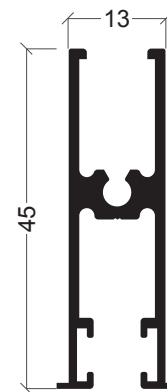

SP-10

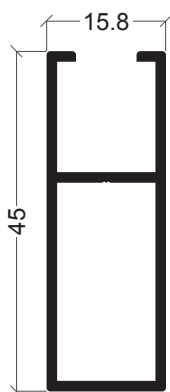

SP-17

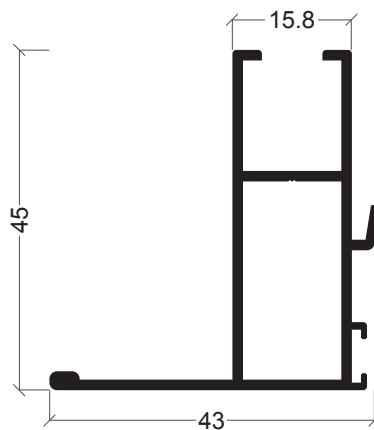

SP-18

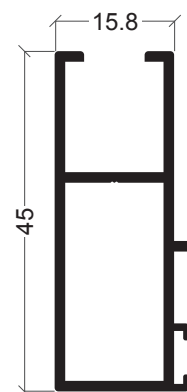

SP-27

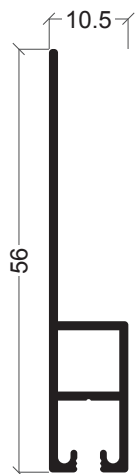

KE-01

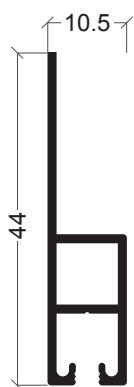

KE-02



KE-17



KE-03

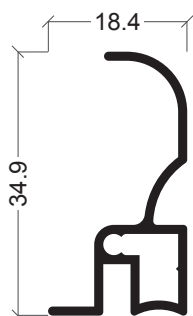

KE-13

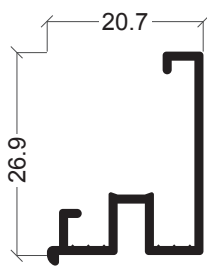

KE-14

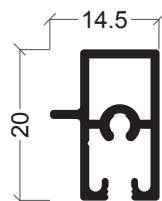

KE-04

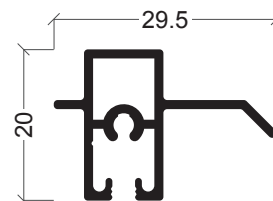

KE-05

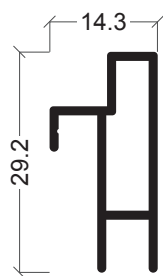

KE-18

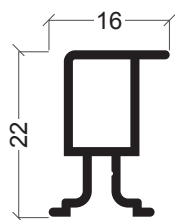

KE-19

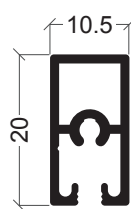

KE-06

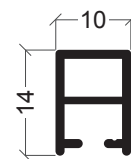

KE-20

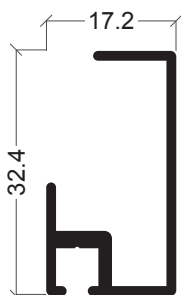

KE-21

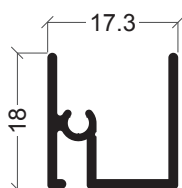

KE-22

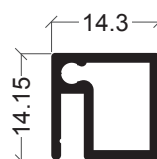

KE-23

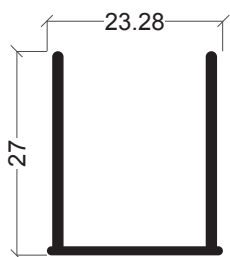

KE-12

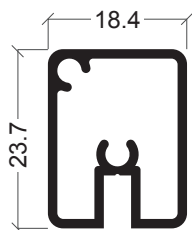

KE-15

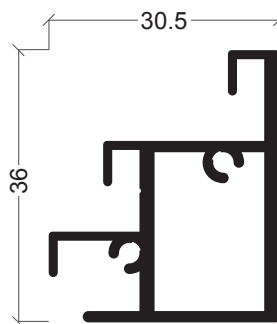

KE-11

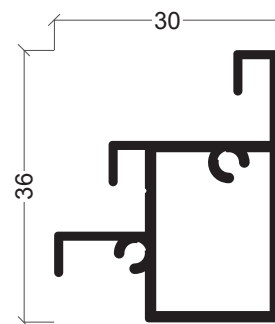

KE-24

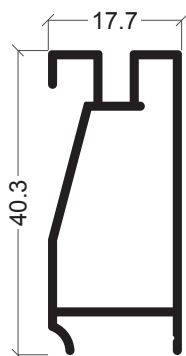

KE-16

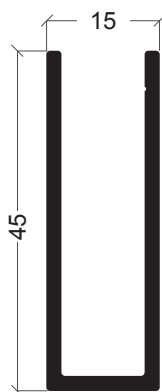

KE-09

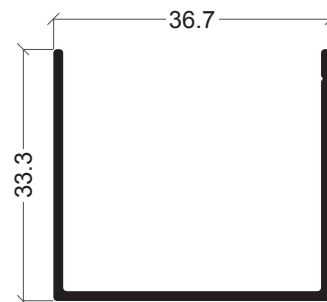

KE-08

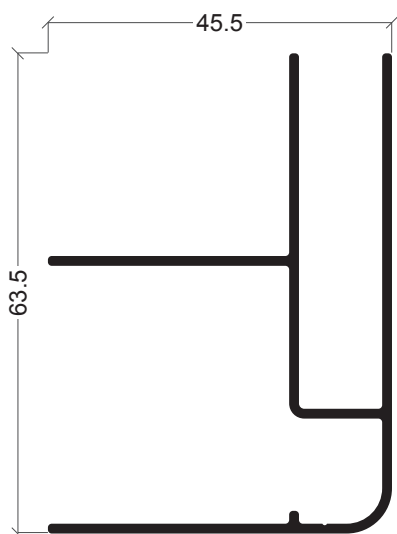

KE-07

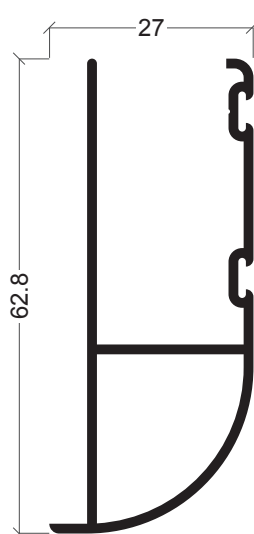

KE-25

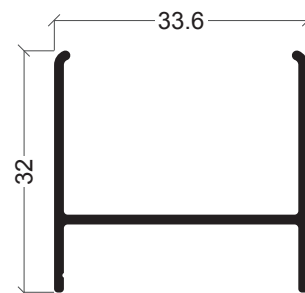

KE-10

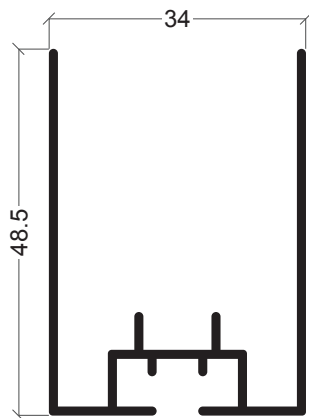

KE-50

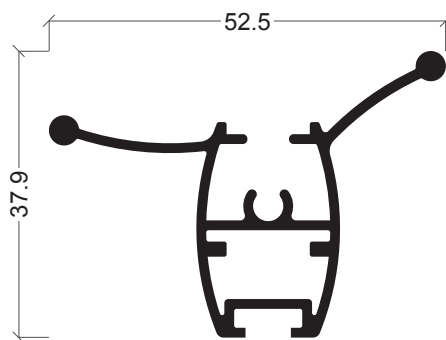

KE-51

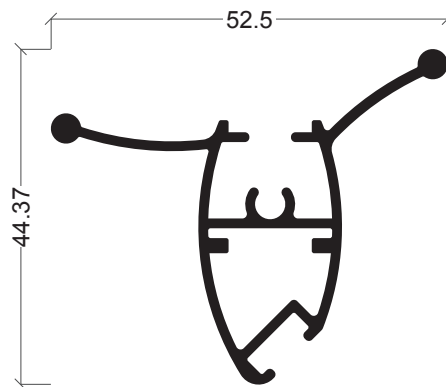

KE-52

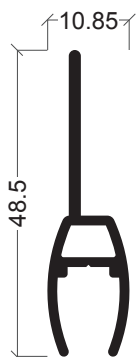

KE-53

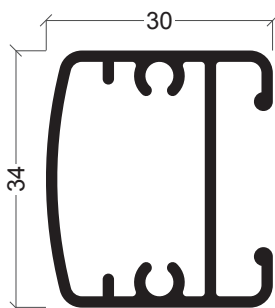

KE-54

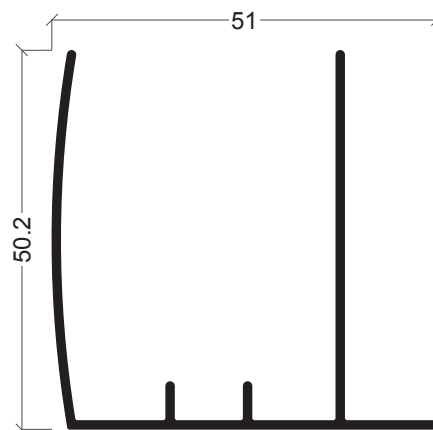

KE-55

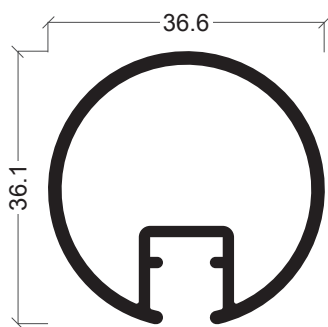

KE-56

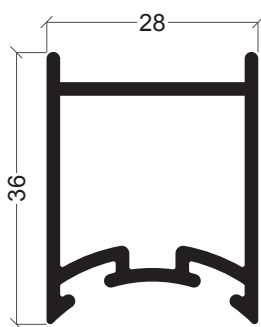

KE-57

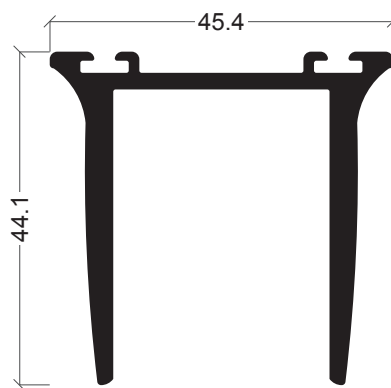

KE-58

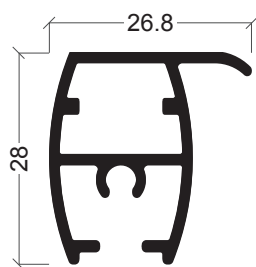

KE-59

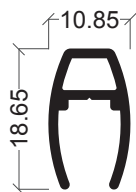

KE-60

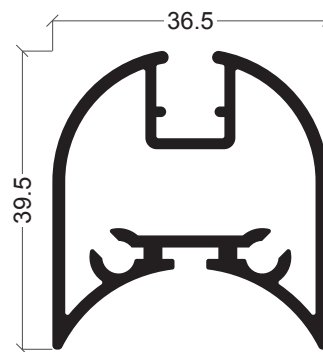

KE-61

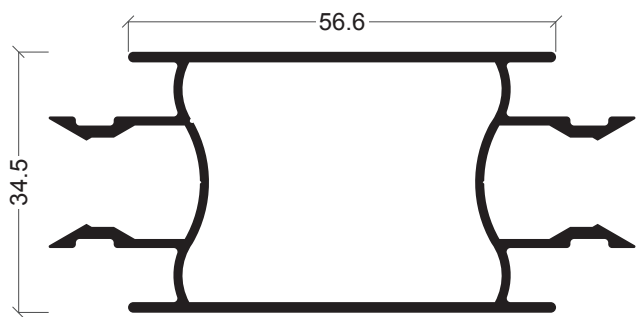

TR-06

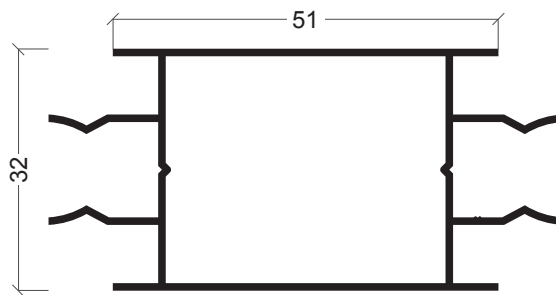

TR-15

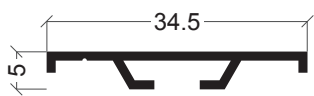

TR-07

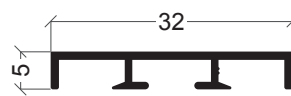

TR-16

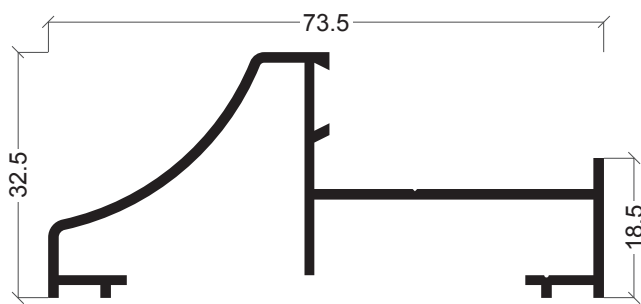

TR-12

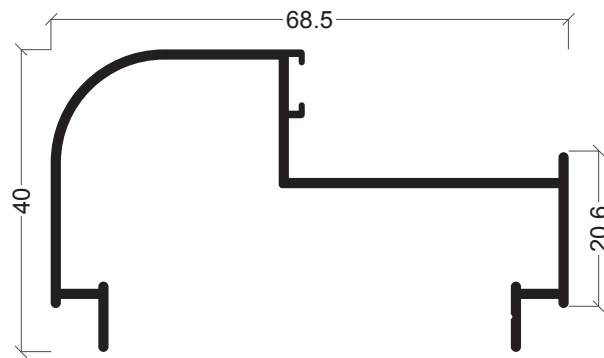

TR-19

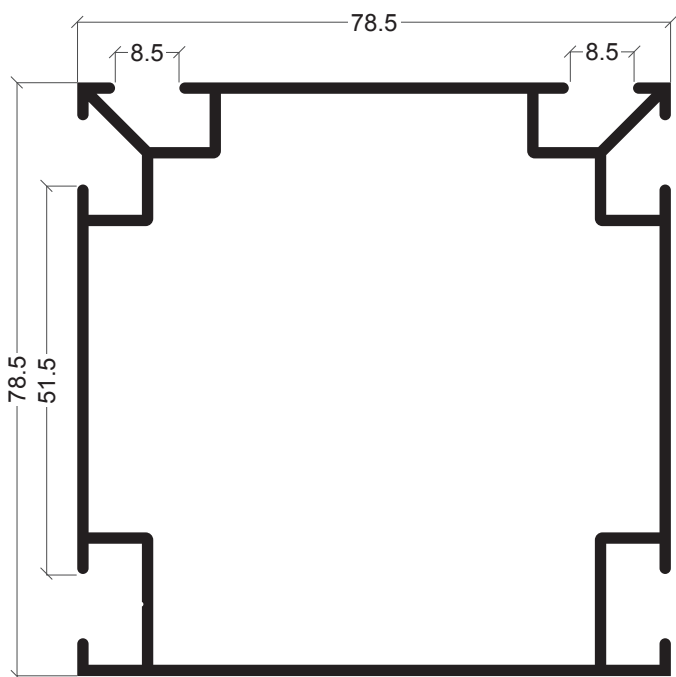

TR-17

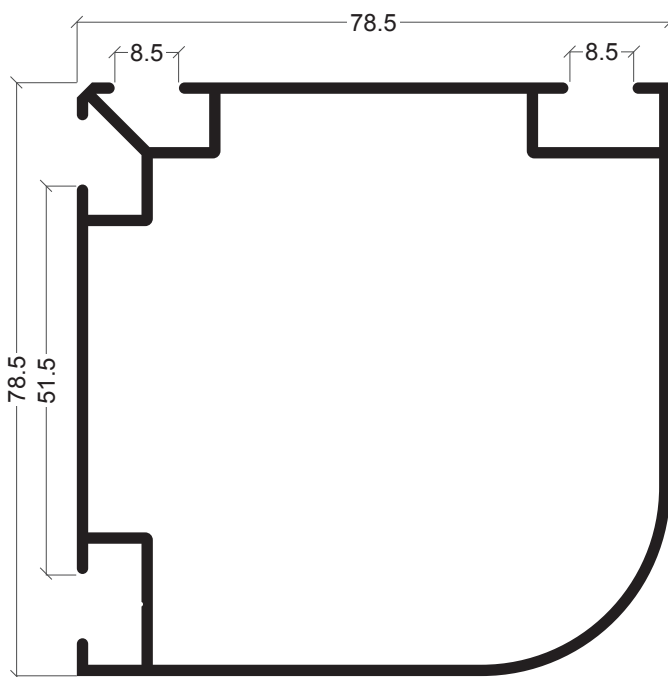

TR-18

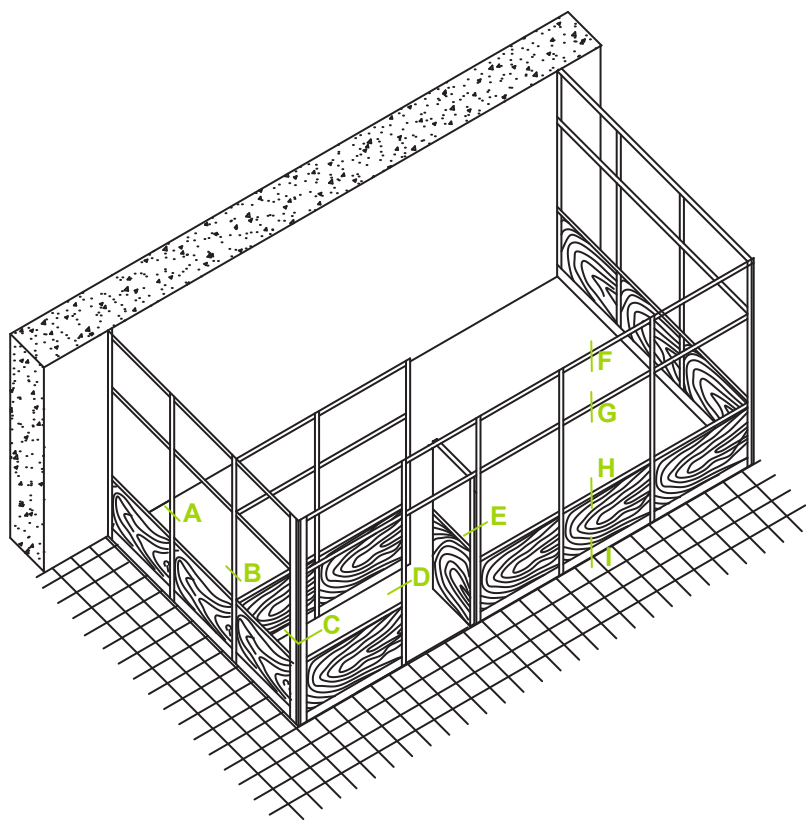

Pormenor de fixação

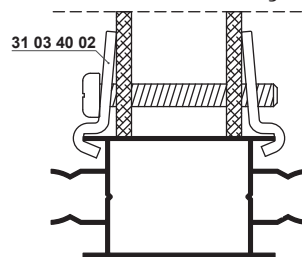

534

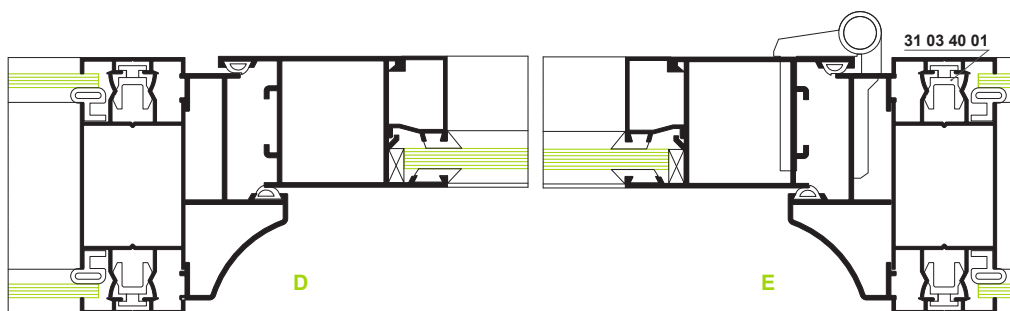
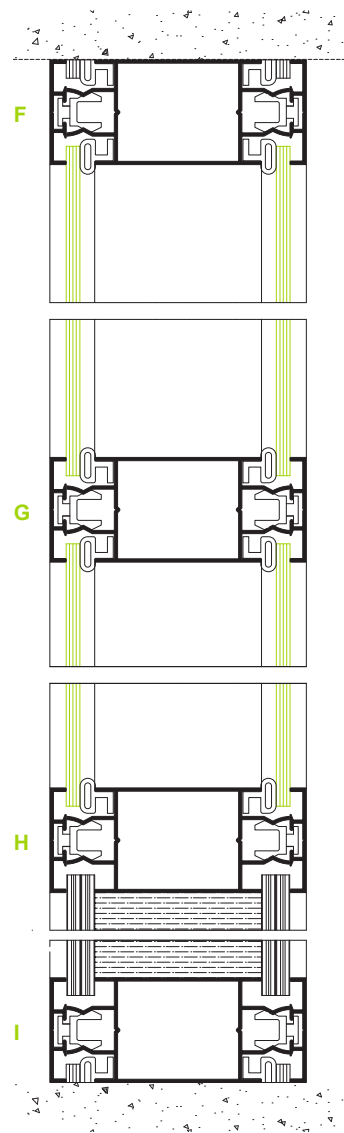
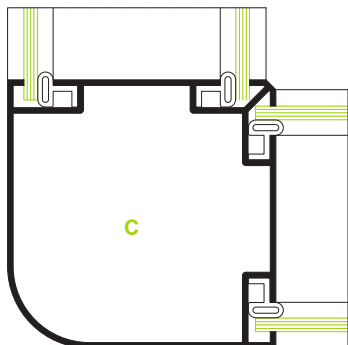
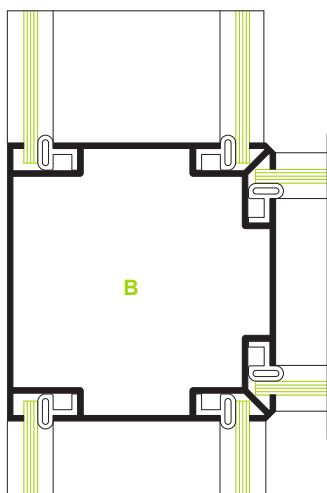
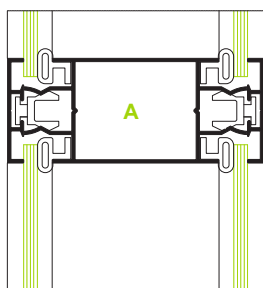

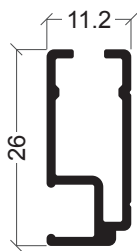

MA-11

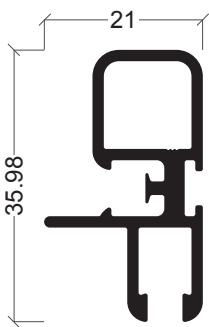

MA-01

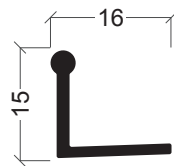

MA-02

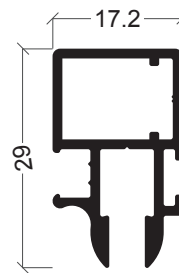

MA-03

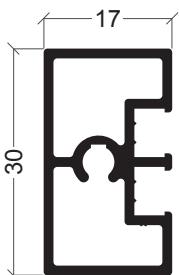

MA-04



MA-05



MA-06

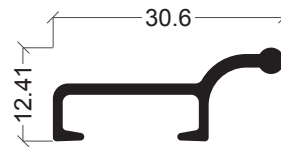

MA-07



MA-08

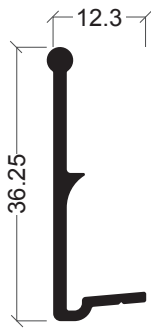

MA-09

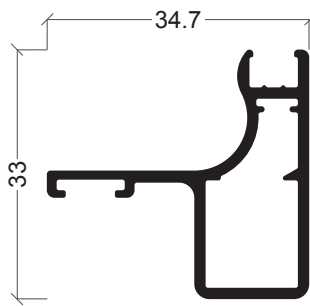

MA-10

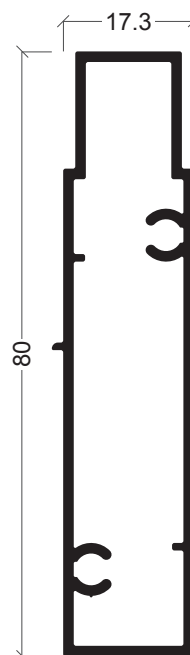

MA-12

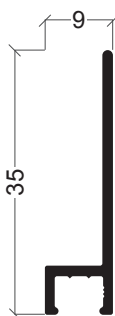

Z-50

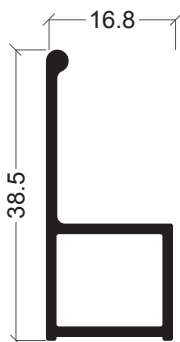

MA-13



P-34

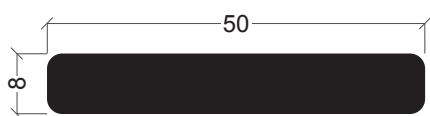

B-24

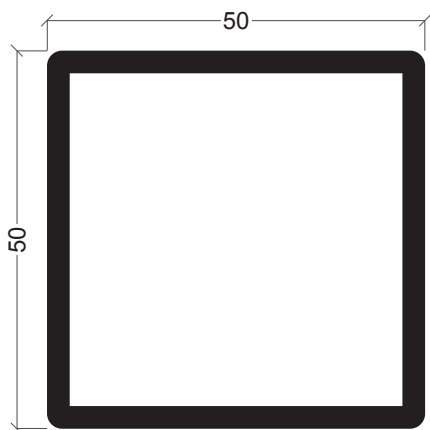

Q-28

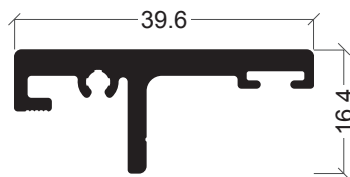

PO-10

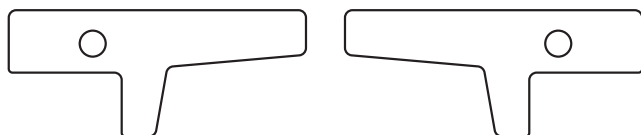

31 01 50 13
Conjunto topo PO-10

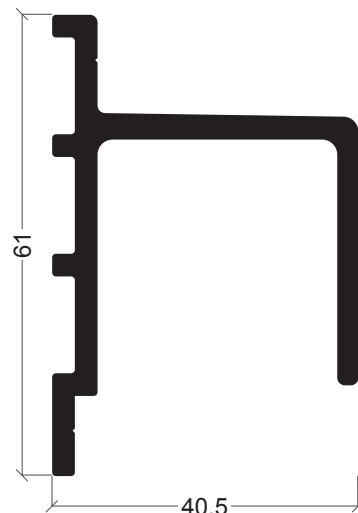

PO-09

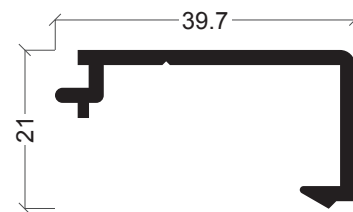

PO-05

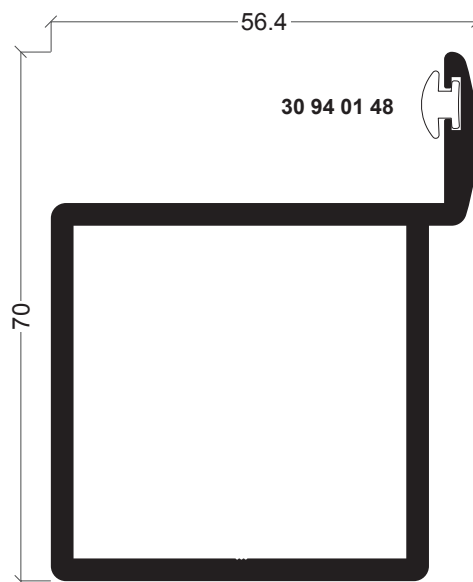

PO-01



30 94 01 48
Junta para portão

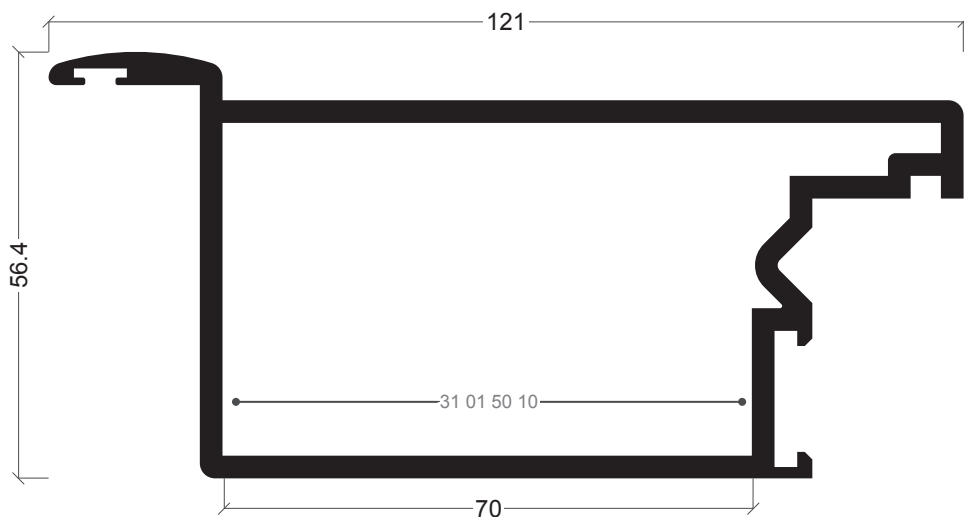

PO-02

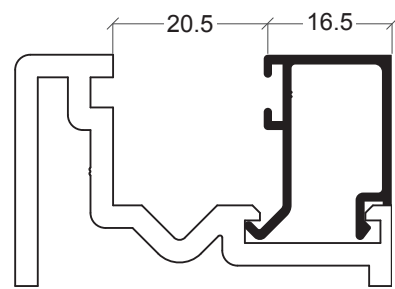

AX-46

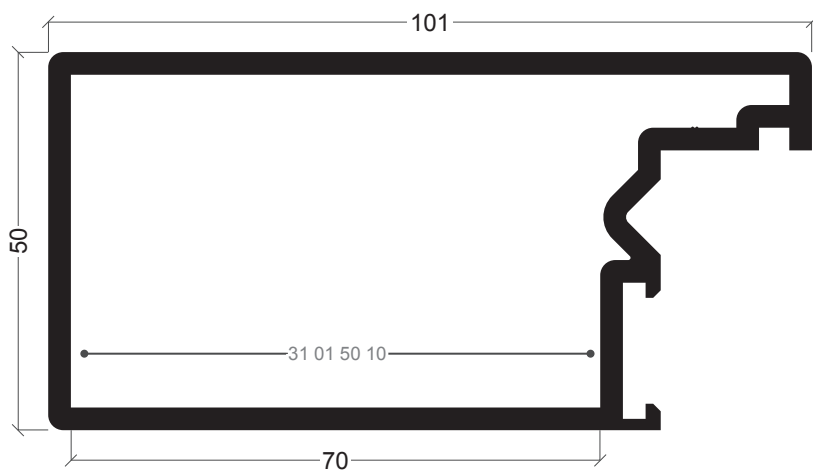

PO-03

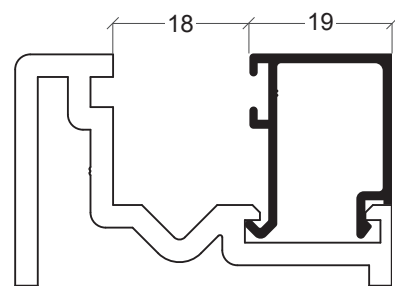

AX-35

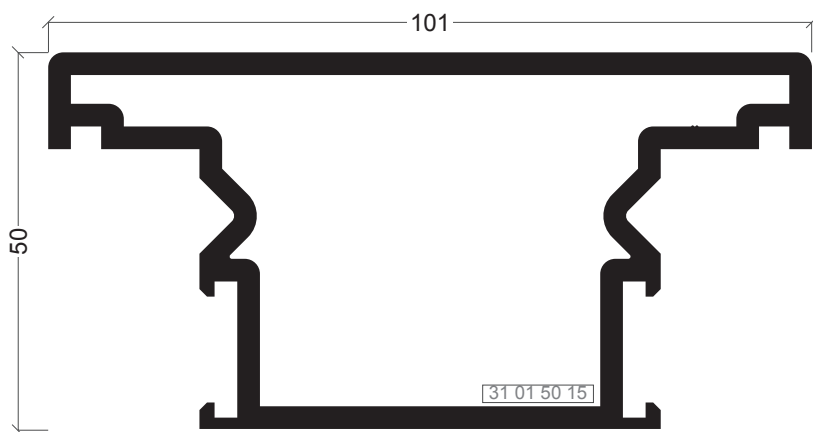

PO-06

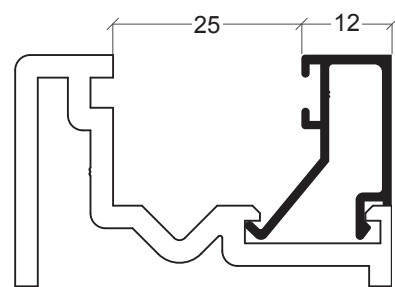

AX-36

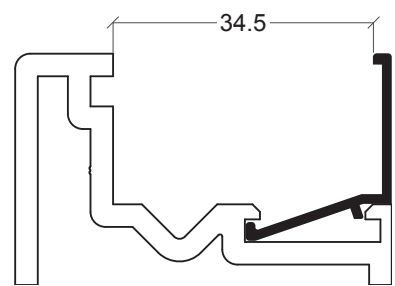

AX-69

538

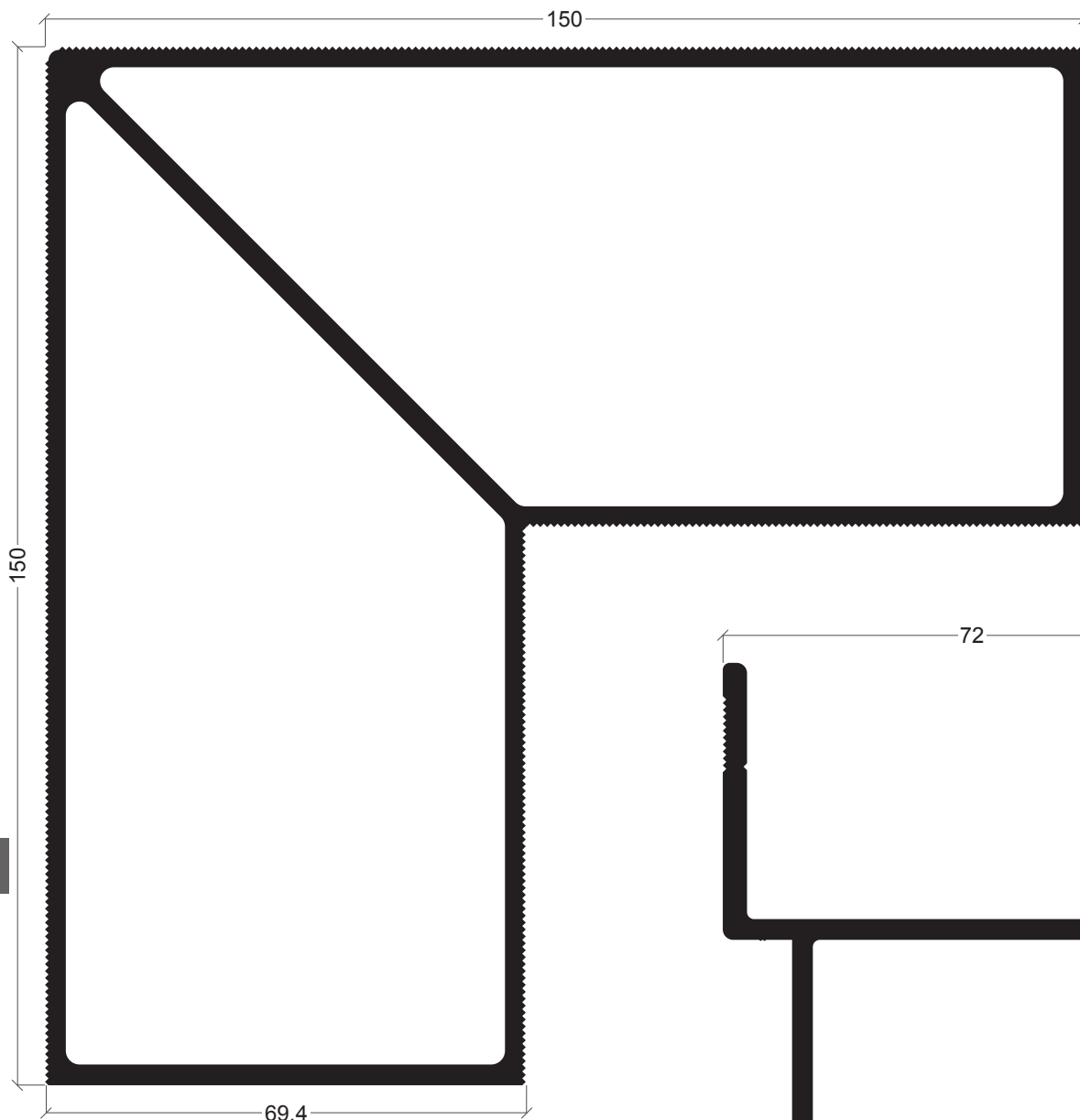

P0-08

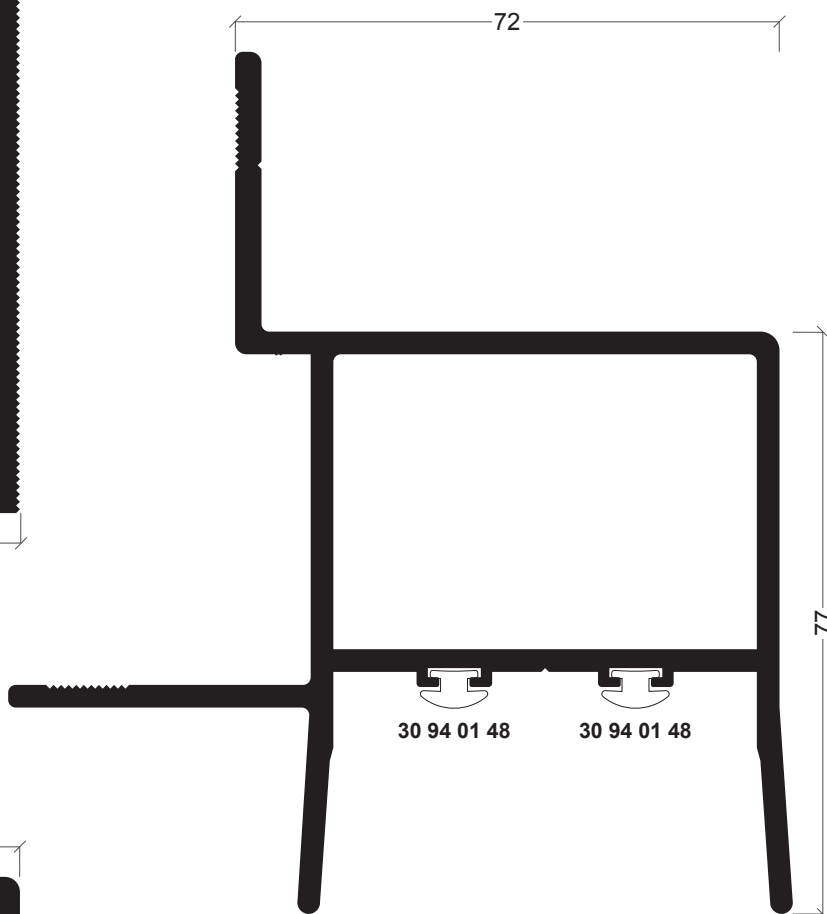

P0-04

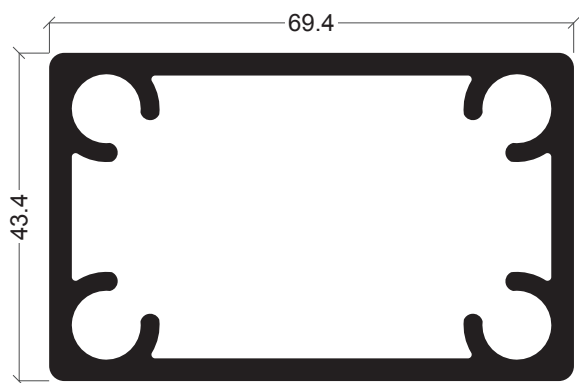

P0-07

Portão 2 folhas de abrir - lâminas fixas

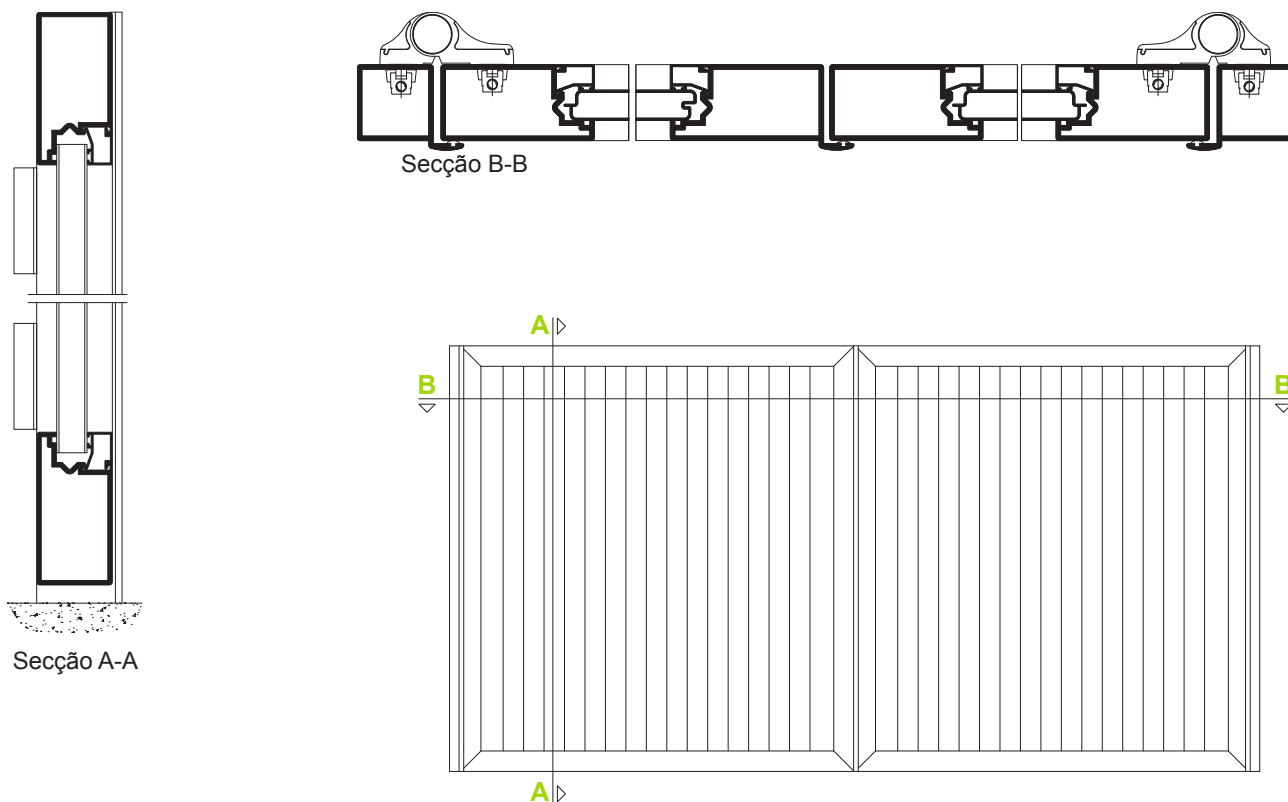

Portão de correr - balaustres + lâminas fixas

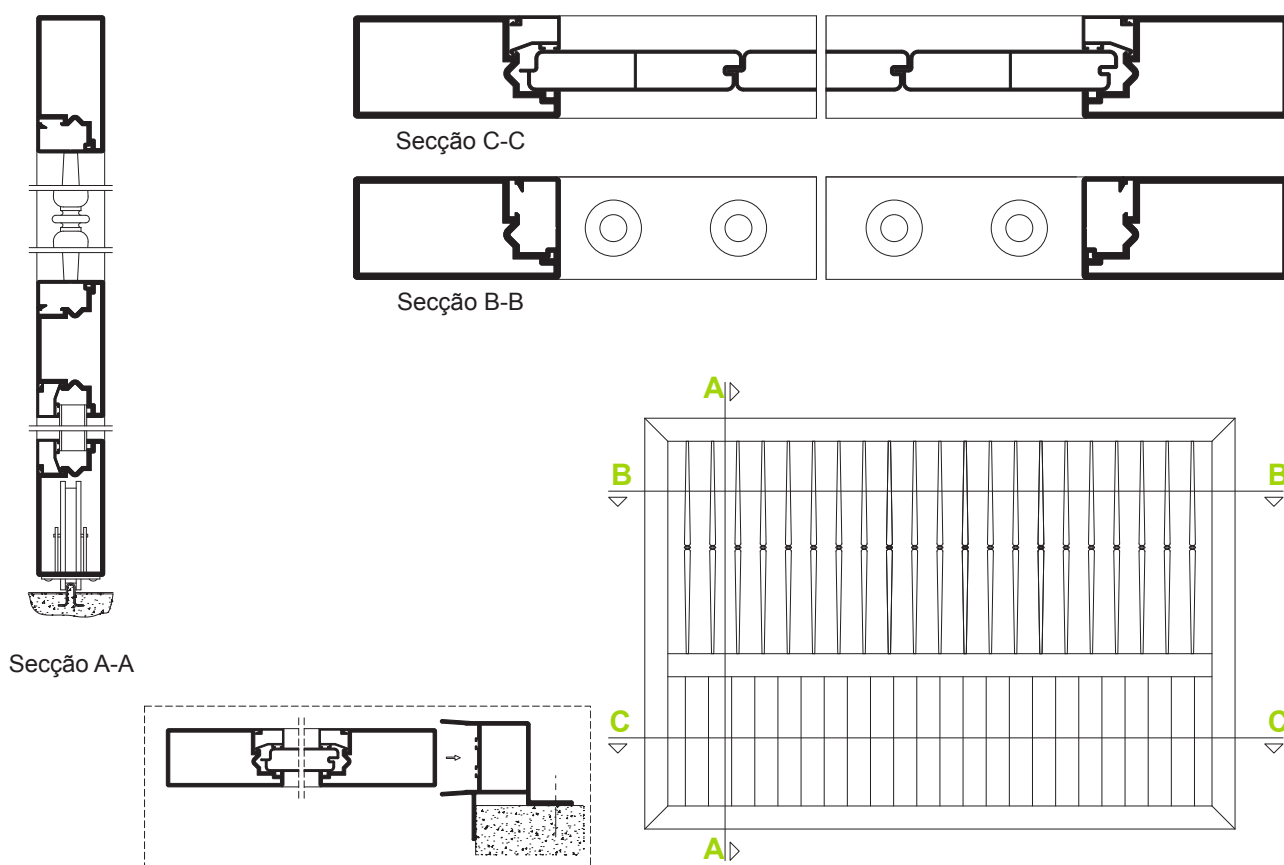

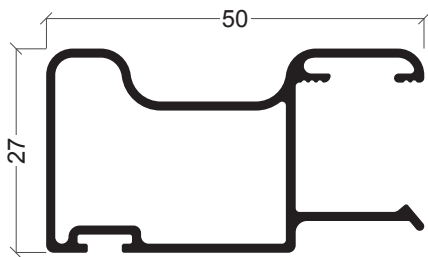

RD-01

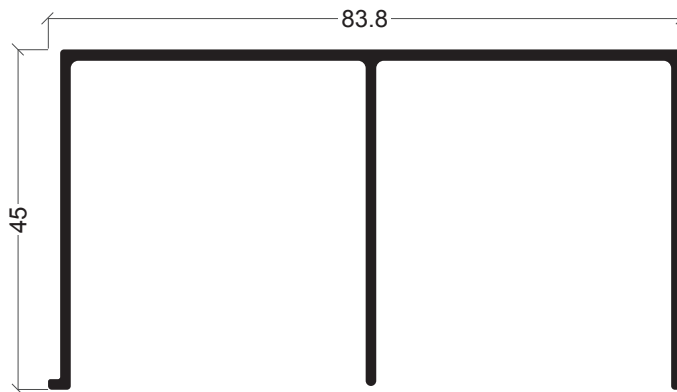

RD-04

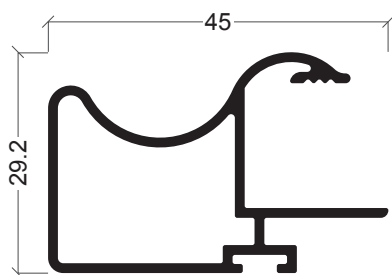

RD-07

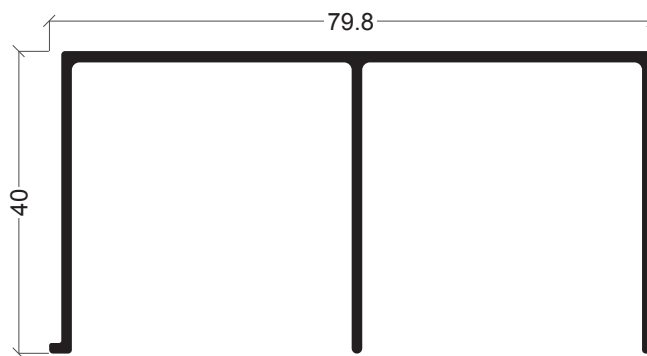

RD-05

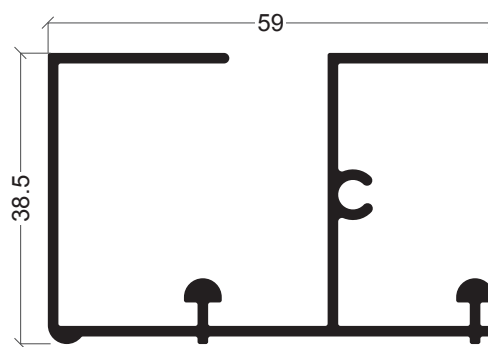

RD-02

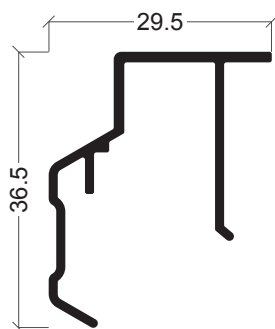

RD-03

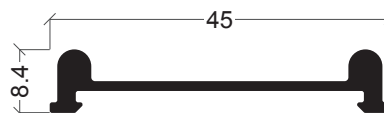

RD-06

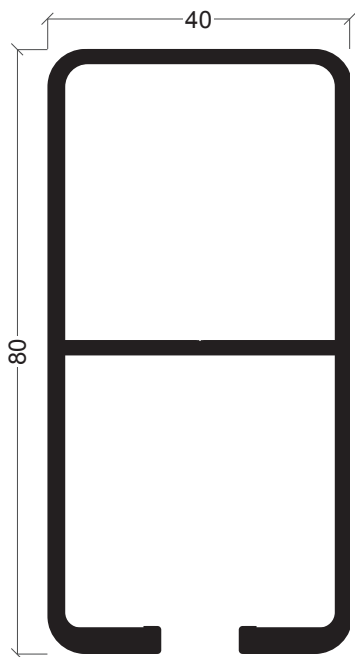

H-07

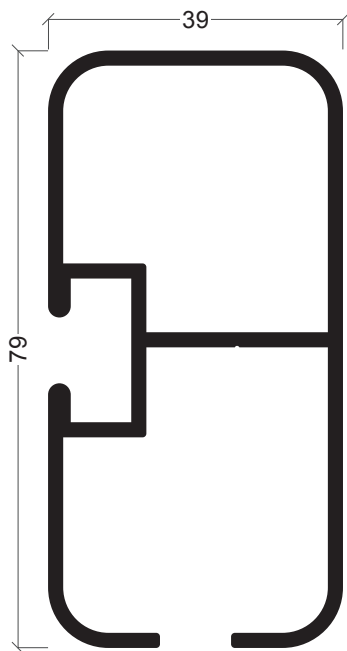

H-08

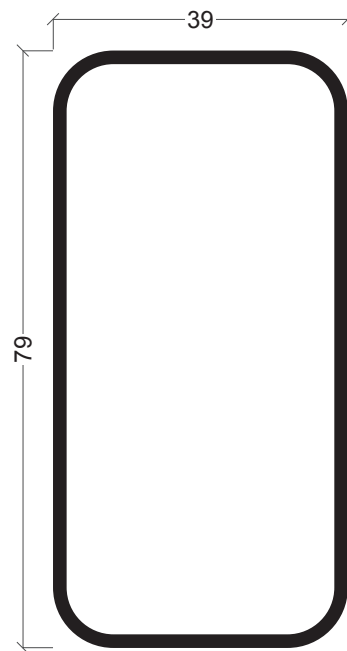

H-10

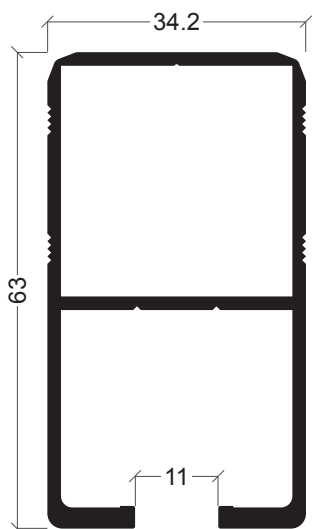

H-03

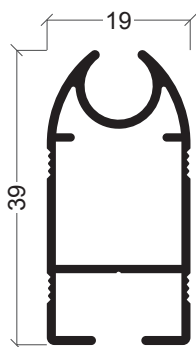

H-01

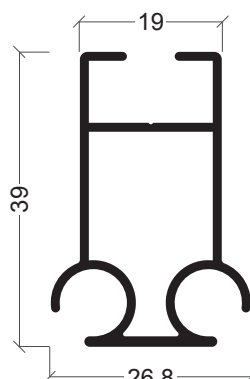

H-04

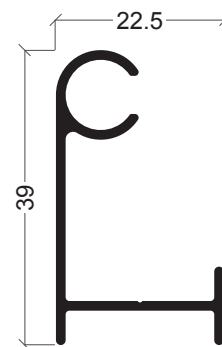

H-09

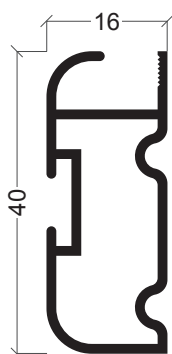

H-20

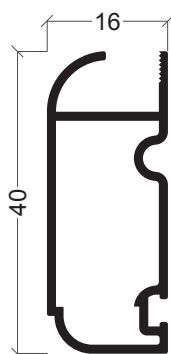

H-21

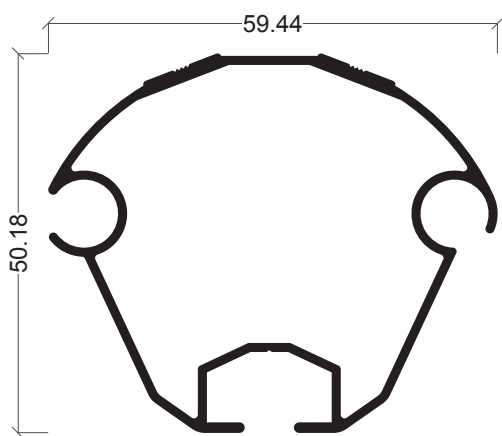

H-06

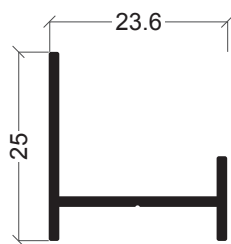

H-02

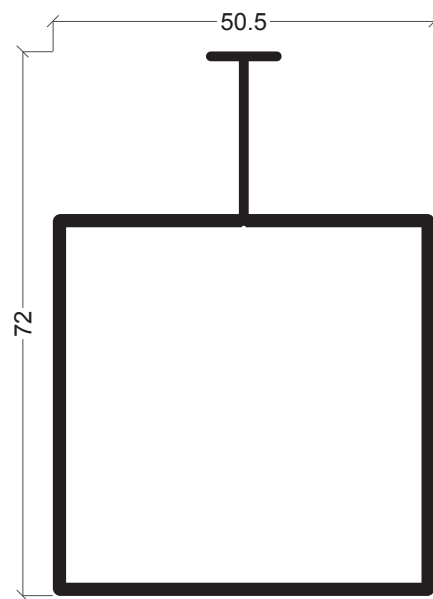

H-05



S-05

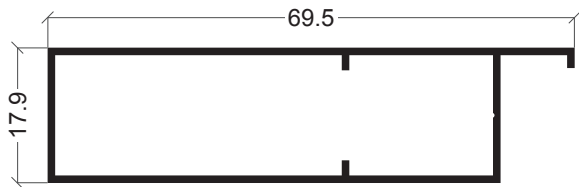

S-04

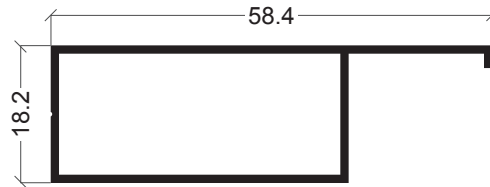

S-03

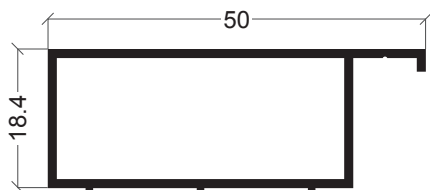

S-02

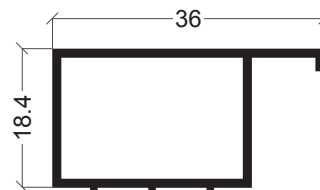

S-01

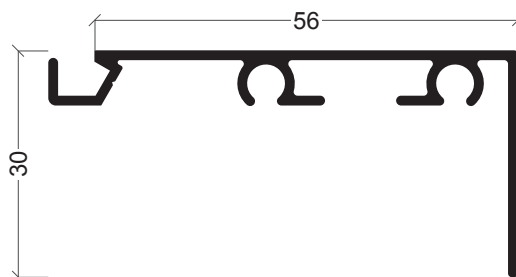

S-07

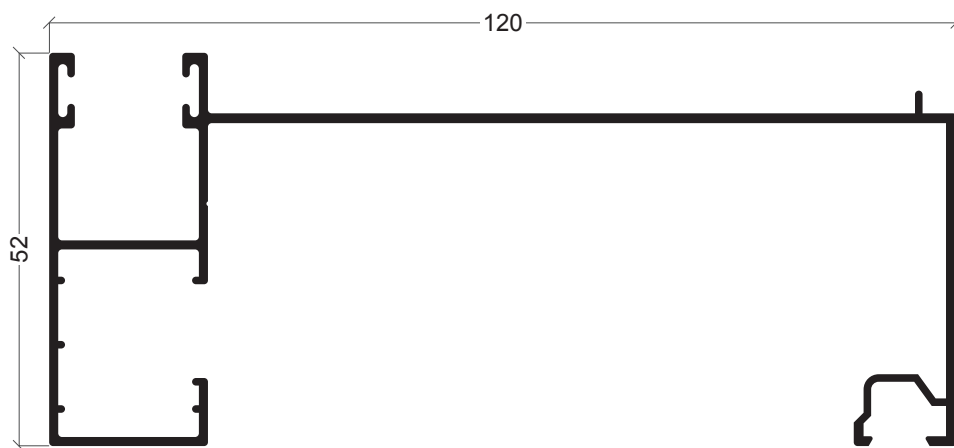

Y-30

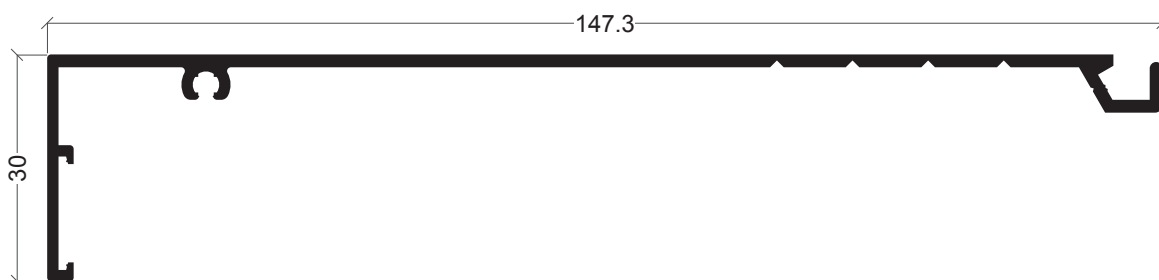

S-09

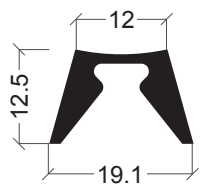

Y-03

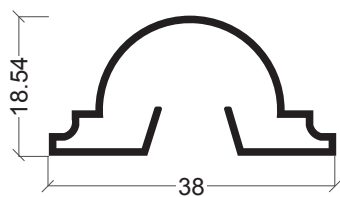

Y-16

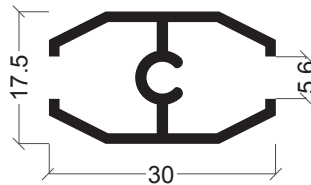

Y-07

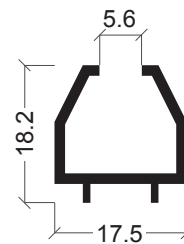

Y-06

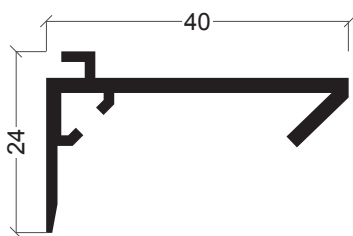

Y-23

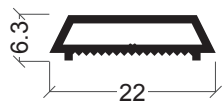

Y-12

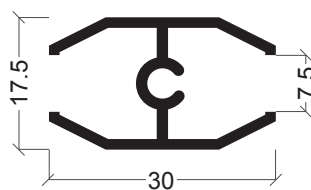

Y-19

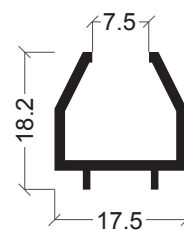

Y-18

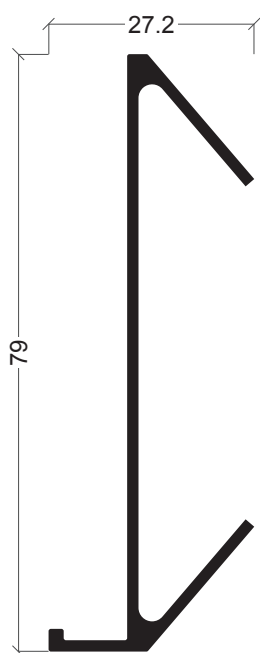

Y-15

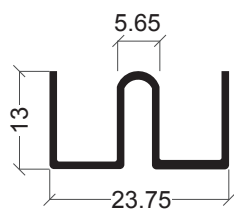

VM-01

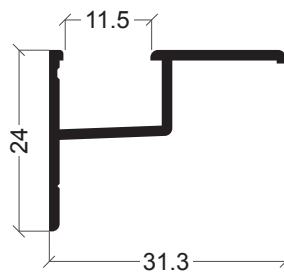

Y-20

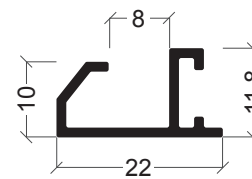

Y-10



VU-03

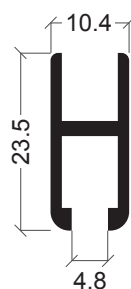

VH-02

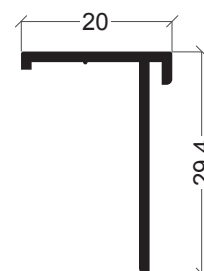

Y-24



Z-52

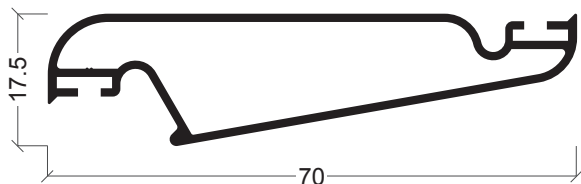

Z-53

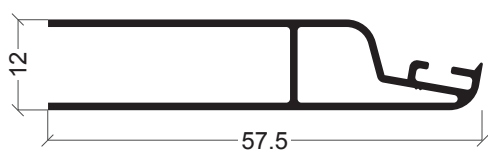

Z-54

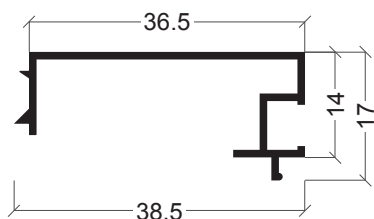

Z-36

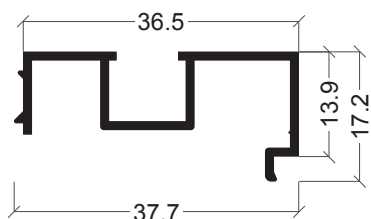

Z-46

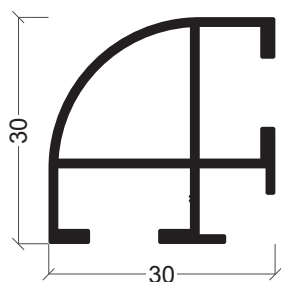

PD-04

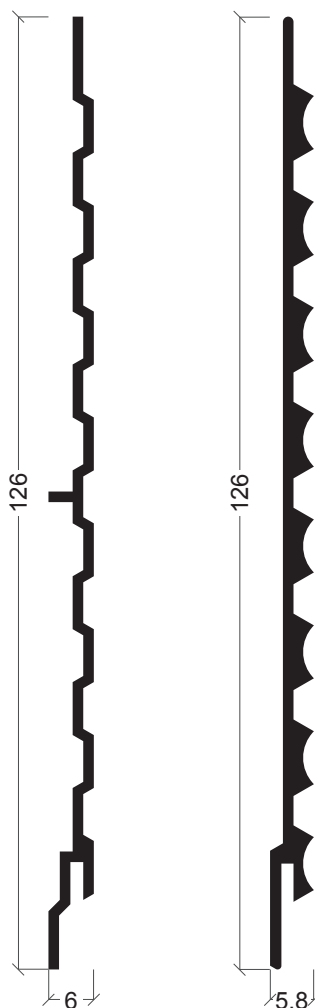

W-01

W-19

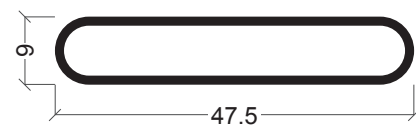

Z-35

31 15 00 37
Conjunto suporte Z-35 preto



Z-40

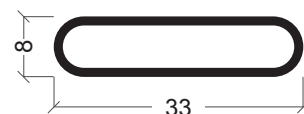

Z-47

31 15 00 39
Conjunto suporte Z-47 preto



Z-08

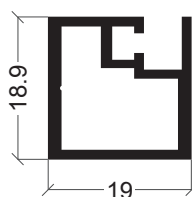

PD-02



PD-01

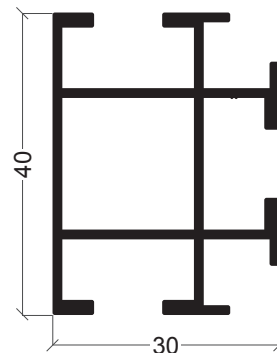

PD-05



Z-55

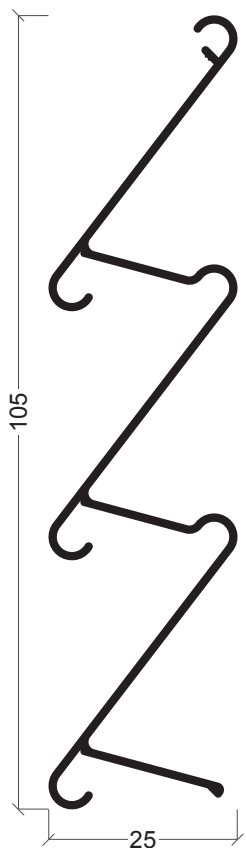

Z-20

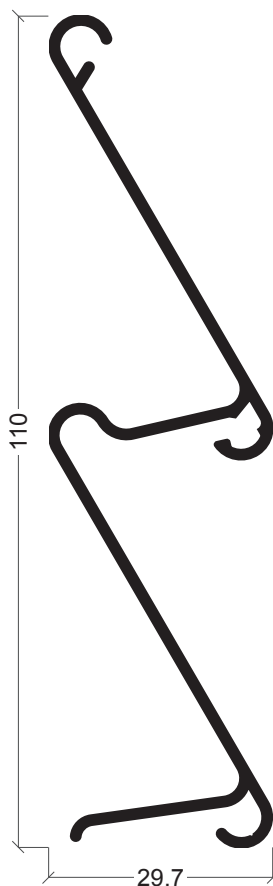

Z-34

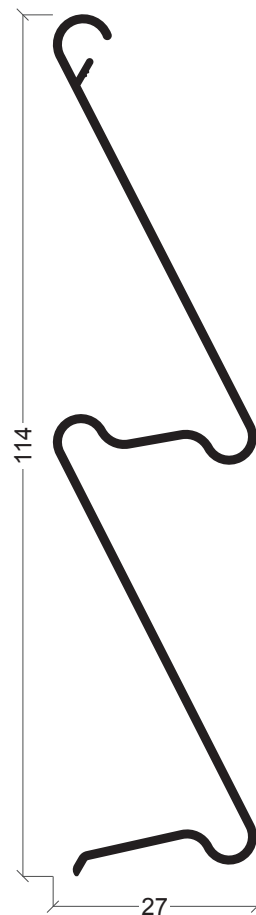

Z-28

545

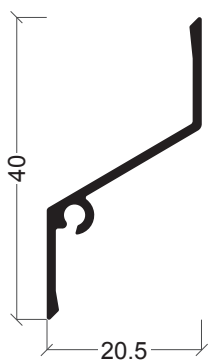

Z-26

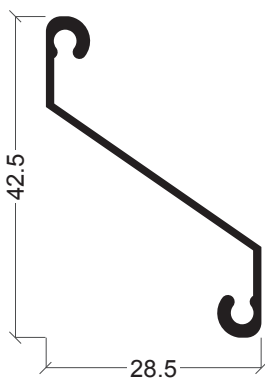

Z-04

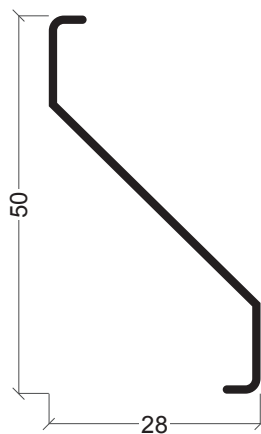

Z-37

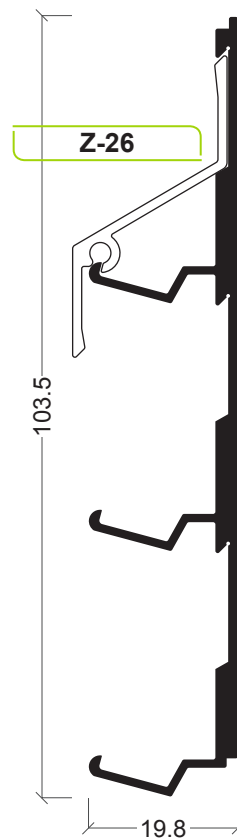

Z-25



M-03

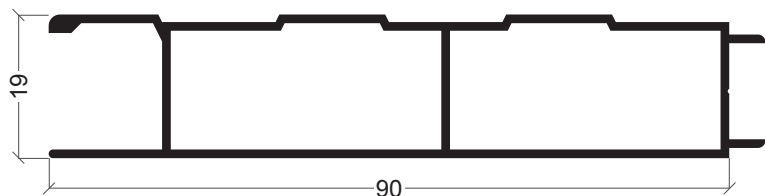

W-21

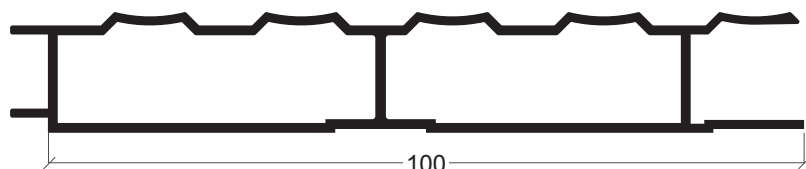

W-22

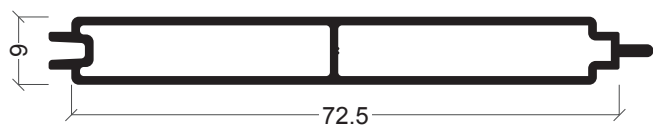

W-23

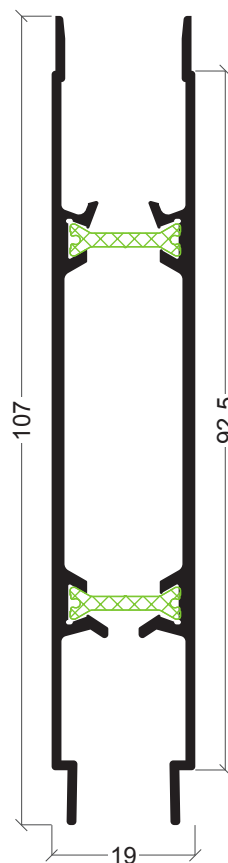

W-15

546

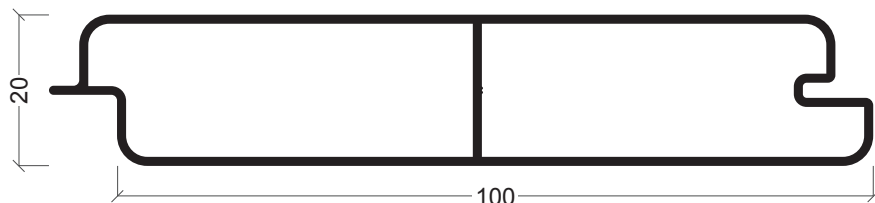

W-25

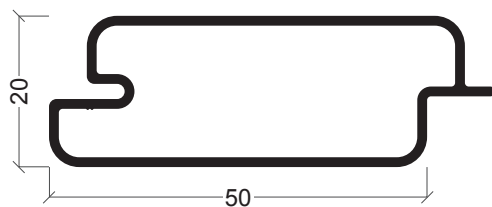

W-26

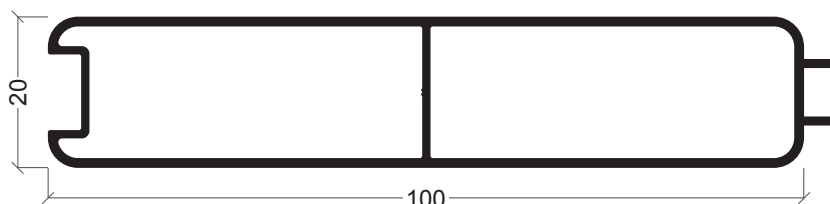

W-27

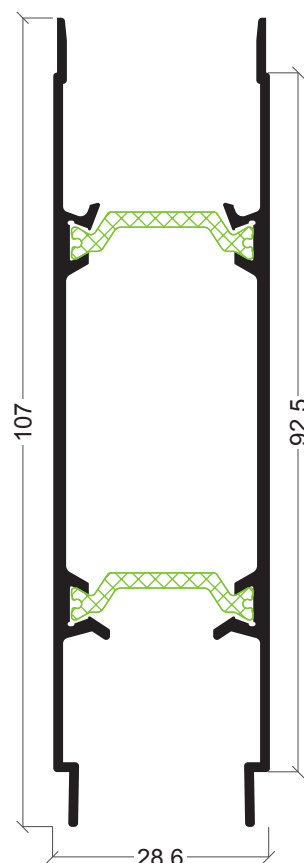

W-20

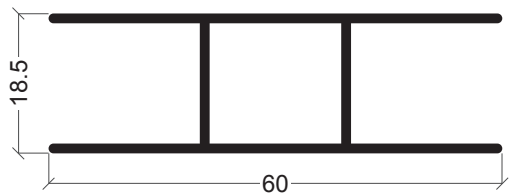

Z-15

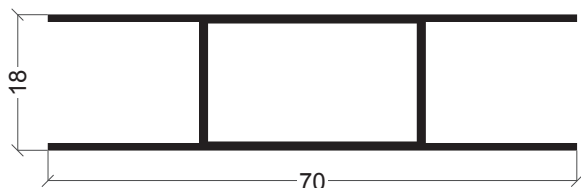

Z-07

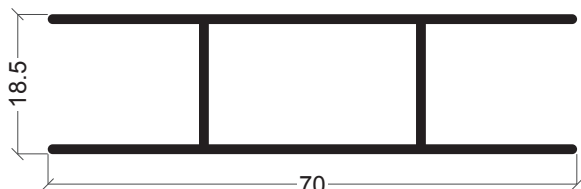

Z-16

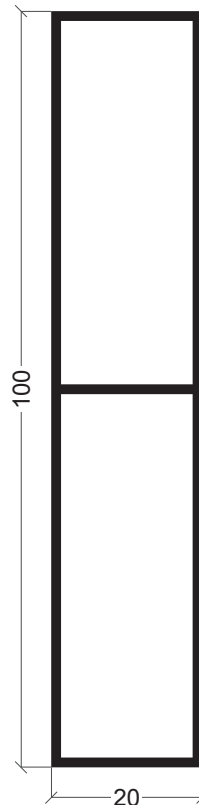

P-14

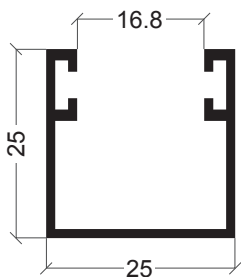

Z-09

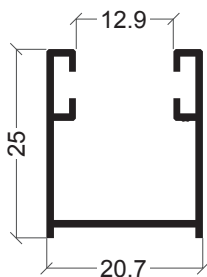

Z-30

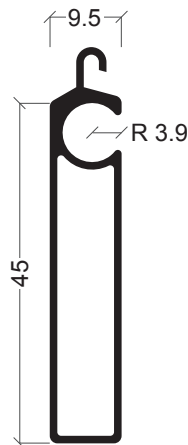

Z-49

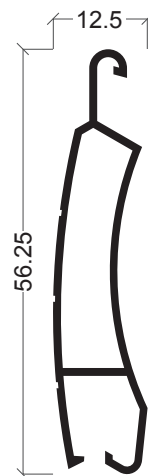

Z-44

Cantoneiras

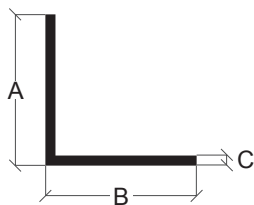

Referência	A	B	C
L-01	15	15	1.2
L-13	15	15	1.5
L-02	20	20	1.2
L-15	20	20	1.5
L-03	25	25	1.2
L-04	25	25	1.5
L-22	30	20	1.5
L-06	30	30	1.2
L-07	30	30	1.5
L-08	32	17	1.8
L-18	40	20	1.2
L-05	40	20	1.5
L-10	40	40	1.2
L-11	40	40	1.5
L-09	50	20	1.3
L-23	50	20	1.8
L-12	50	50	1.3
L-20	50	50	2
L-25	60	60	6

Barras retangulares



Referência	A	B
B-07	20	2
B-04	20	3
B-05	20	4
B-14	20	5
B-18	20	10
B-08	25	2
B-06	25	3
B-11	25	4
B-12	25	5
B-01	30	2
B-09	30	3
B-13	30	4
B-15	30	5
B-16	40	2
B-17	40	3
B-10	40	4
B-22	40	5
B-02	45	3
B-03	50	2
B-19	50	3
B-20	50	4
B-21	50	5
B-24	50	8
B-26	52	20

548

Calhas U

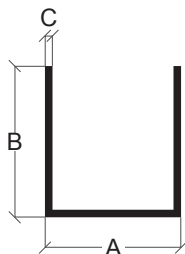

Referência	A	B	C
U-02	18	18	1
U-03	18	20	1
U-05	20	20	1.1
U-07	20	40	1.8
U-08	14	45	3

Redondos

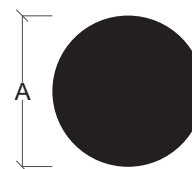

Referência	A
G-03	6
G-01	8
G-04	10

Tubos redondos

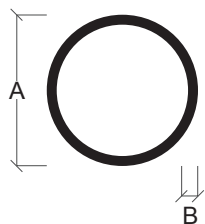

Referência	A	B
R-02	6	1
R-05	8	1
R-01	9	1.4
R-06	10	1
R-03	16	1
R-12	18	1.2
R-04	19	1.2
R-16	20	1.3
R-13	22	1.5
R-07	23	1.5
R-17	25	1.5
R-18	30	1.2
R-08	30	1.5
R-21	40	1.3
R-09	40	1.7
R-19	45	1.2
R-22	45	1.7
R-23	50	1.3
R-10	50	1.7
R-24	60	1.3
R-11	60	1.9
R-25	70	1.5
R-26	80	1.5
R-27	90	2
R-28	100	2

Quadrados



Referência	A
F-03	15
F-05	20
F-04	25

Perfis em tê

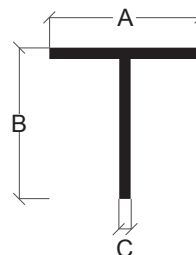

Referência	A	B	C
T-01	20	20	1.5
T-02	25	25	1.5
T-03	25	25	2
T-06	30	30	1.4
T-04	30	30	2
T-07	40	40	1.3
T-05	40	40	2

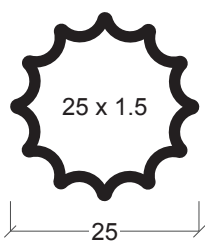

R-14

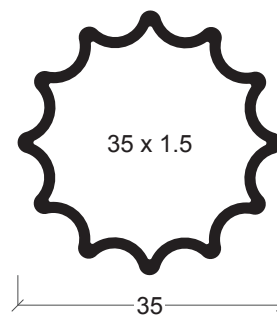

R-15

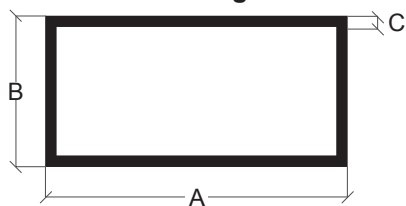
Tubos retangulares

Referência	A	B	C
P-01	30	12.5	1.5
P-27	30	15	1.2
P-02	30	15	1.5
P-11	30	20	1.3
P-04	40	20	1.3
P-03	40	20	2
P-19	50	25	1.3
P-06	50	30	1.5
P-07	50	34	2
P-18	60	15	1.3
P-08	60	20	1.3
P-05	60	40	1.2
P-20	60	40	1.5
P-09	65	30	1.5
P-12	70	20	1.3
P-22	70	40	1.5
P-10	75	40	1.5
P-26	80	20	1.2
P-21	80	20	1.5
P-23	80	30	1.5
P-29	80	40	1.3
P-24	80	40	2
P-13	85	30	1.8
P-25	100	18	2
P-32	100	40	1.4
P-28	100	40	2
P-33	100	45	1.4
P-15	100	45	2
P-31	100	60	2
P-30	120	40	1.7
P-17	150	25	2

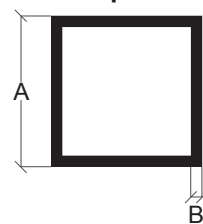
Tubos quadrados

Referência	A	B
Q-10	16	1
Q-01	19	1
Q-18	20	1.3
Q-02	20	2
Q-25	25	1.2
Q-03	25	1.5
Q-22	30	1.2
Q-04	30	1.5
Q-24	35	1.2
Q-05	35	1.5
Q-12	40	1.2
Q-06	40	1.5
Q-15	45	1.3
Q-07	50	1.5
Q-26	50	2
Q-14	60	1.3
Q-20	60	2
Q-09	65	1.5
Q-16	70	1.3
Q-08	70	2
Q-27	75	1.5
Q-11	75	2
Q-17	80	1.5
Q-21	80	2
Q-13	85	2
Q-19	100	1.4
Q-23	100	2

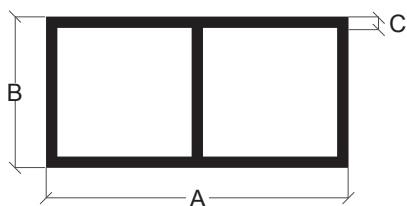
**Tubos retangulares
parede ao centro**

Referência	A	B	C
P-14	100	20	1.3
P-16	125	15	1.8

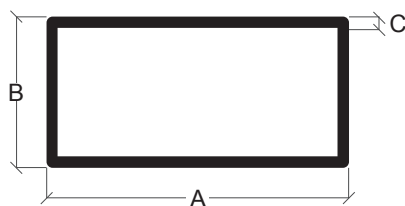
**Tubos retangulares
cantos arredondados**

Referência	A	B	C
P-34	80	50	3

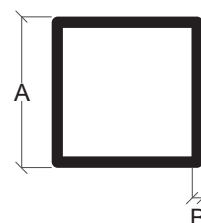
**Tubos quadrados
cantos arredondados**

Referência	A	B
Q-28	50	3